

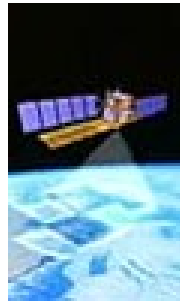

## Active RF Sensing



SAR-  
Radarsat



Altimeter-  
JASON



Scatterometer-  
Seawinds



Precipitation Radar-  
TRMM



Cloud Profile Radar-  
Cloudsat

***Bryan HUNEYCUTT (Jet Propulsion Laboratory/NASA)***

***ITU Seminar for Americas Region***

***Manta, Ecuador***

***20-21 September 2012***

# *Active Sensor Types*

- **SYNTHETIC APERTURE RADARS** - Sensors looking to one side of nadir track, collecting phase and time history of coherent radar echo from which typically can be produced a radar image or topographical map of the Earth surface
- **ALTIMETERS** - Sensors looking at nadir, measuring the precise time between a transmit event and receive event to extract the precise altitude of ocean surface
- **SCATTEROMETERS** - Sensors looking at various aspects to the sides of the nadir track, using the measurement of the return echo power variation with aspect angle to determine wind direction and speed on Earth ocean surface or return echo on Earth land surface
- **PRECIPITATION RADARS** - Sensors scanning perpendicular to nadir track, measuring the radar echo from rainfall to determine the rainfall rate over Earth surface, usually concentrating on the tropics
- **CLOUD PROFILE RADARS** - Sensors looking at nadir, measuring the radar echo return from clouds, to determine cloud reflectivity profile over Earth surface

# *Active Sensor and Service Definitions*

**Active Sensor:** a measuring instrument in the Earth exploration-satellite service or in the space research service by means of which information is obtained by transmission and reception of radio waves (RR)

**Earth Exploration-Satellite Service:** a radiocommunication service between earth stations and one or more space stations, which may include links between space stations, in which:

- information relating to the characteristics of the Earth and its natural phenomena including data relating to the state of the environment is obtained from active sensors or passive sensors on earth satellite;
- similar information is collected from airborne or earth-based platforms;
- such information may be distributed to earth stations within the system concerned

**Space Research Service:** a radiocommunications service in which spacecraft or other objects in space are used for scientific or technological research purposes

# *Active Sensors Applications by Sensor Type*

Active Sensor Type	Active Sensor Applications
SARs	SARs can provide knowledge of deep and undercanopy soil moisture which is critical for several Earth science disciplines and public welfare and policy making processes. These applications include, but are not limited to: long-term weather forecasts, studying the long- and short-term climate variations through quantifying elements of the energy and water cycle, for Carbon cycle science studies, and for studies and management of underground water resources and aquifers.
Altimeters	The data obtained by radar altimeters will be used to study ocean dynamics and their effects on climatology and meteorology. Dual frequency altimeters also operate at 5.3 GHz to provide data to compensate for uncertainties in height measurements caused by ionospheric effects on the 13.5 GHz measurement. The radar altimeter will provide precise measurements of the distance from the satellite to the Earth's surface and also of the power and the shape of the returned echoes from ocean, ice and land surfaces, eventually allowing us to improve our knowledge of climatology and environmental change detection.
Scatterometers	Ocean scatterometers will measure surface wind speeds and directions over at least 90% of the oceans every two days in all weather and cloud conditions. Winds are a critical factor in determining regional weather patterns and global climate. Land scatterometers will measure surface echo returns to augment passive measurements of soil moisture and sea salinity. Scatterometers will play a key role in scientists efforts to understand and predict complex global weather patterns and climate systems.
Precipitation Radars	One precipitation radar is the first space mission dedicated to measuring tropical and subtropical rainfall using several microwave and visible/infrared sensors. Major objectives of the PR are 1) to provide a 3-dimensional rainfall structure, 2) to achieve quantitative rainfall measurement over land as well as over ocean, and 3) to improve the accuracy of a microwave imager measurement by providing the rain structure information.
Cloud Profiling Radars	The cloud profiling radar has been widely recognized as a key sensor to measure global distribution of clouds, which is a critical issue in understanding the cloud role in earth's radiation budget and thereby predicting the global warming. The objective of spaceborne CPR is to measure global three -dimensional cloud distribution. The clouds which always cover about half area of the whole earth surface, play a significant and complicated role in the earth's radiation budget. Especially, the vertical structure of clouds is a critical parameter to decide whether clouds contribute to warming or cooling of the atmosphere.

# *Active Sensor Characteristics*

Characteristics	Sensor Types				
	SAR	Altimeter	Scatterometer	Precipitation Radar	Cloud Radar
Viewing Geometry	Side-looking @10-55 deg off nadir	Nadir-looking	(1) Three/six fan beams in azimuth (2) One/two conical scanning beams	Nadir-looking	Nadir-looking
Footprint/Dynamics	(1) Fixed to one side (2) ScanSAR	Fixed at nadir	(1) Fixed in azimuth (2) Scanning	Scanning across nadir track	Fixed at nadir
Antenna Beam	Fan beam	Pencil beam	(1) Fan beams (2) Pencil beams	Pencil beam	Pencil beam
Radiated Peak Power	1500-8000 W	20 W	100-5000 W	600 W	1000-1500 W
Waveform	Linear FM pulses	Linear FM pulses	Interrupted CW, Short Pulses (ocean), or linear FM pulses(land)	Short pulses	Short pulses
Spectrum Width	20-600 MHz	320 MHz	5- 80 kHz (ocean), 1-4 MHz (land)	0.6-14 MHz	300 kHz
Duty Factor	1-5 %	46 %	31 % (ocean) or 10 % (land)	0.9-2 %	1-14 %
Service Area	Land/coastal/Ocean	Ocean/Ice	Ocean/Ice/Land	Land/Ocean	Land/Ocean

# Active Sensor Examples

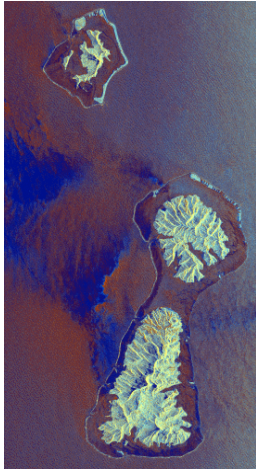

SAR-Radar Image  
Bora Bora, French  
Polynesia

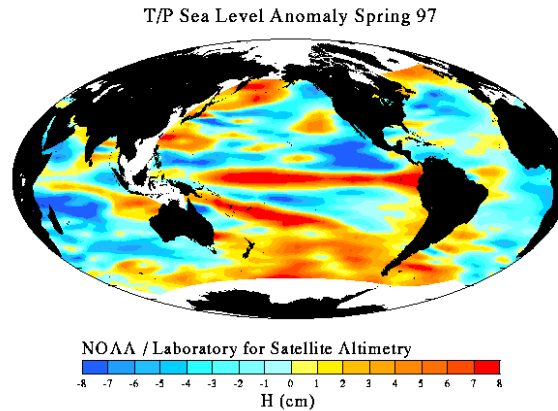

Altimeter-Sea Level

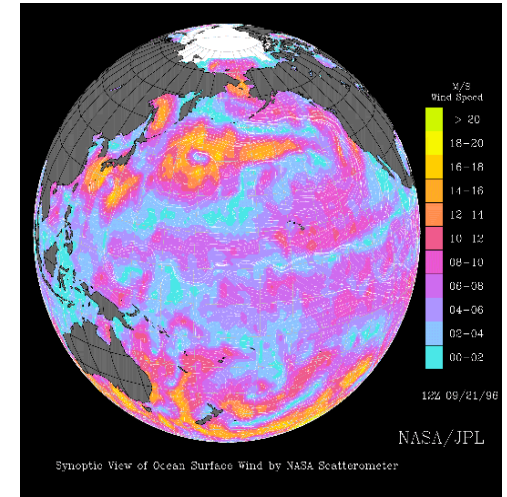

Scatterometer-Wind Speeds

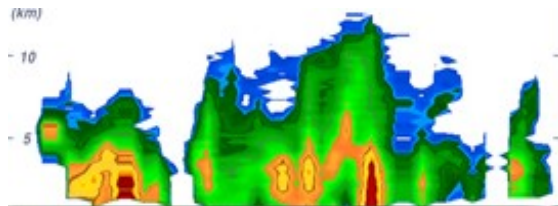

Precipitation Radar-  
Rain Rates

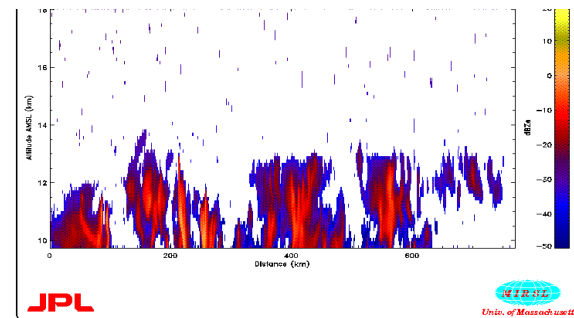

Cloud Radar-Cloud  
Reflectivity Profile

# *Synthetic Aperture Radars (SARs)*

- Provide radar images and topographical maps of the Earth's surface
- RF center frequency depends on the Earth's surface interaction with the EM field
- RF bandwidth affects the resolution of the image pixels
- Allowable image pixel quality degradation determines allowable interference level

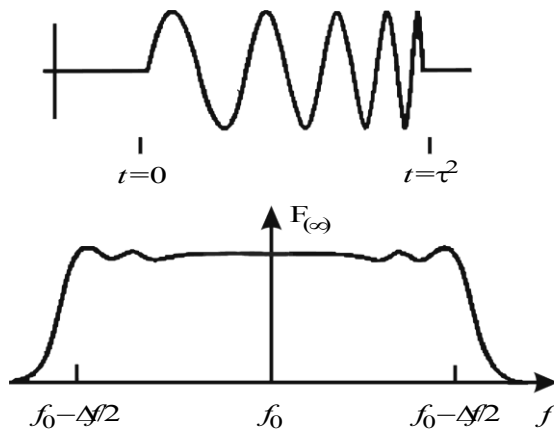

Chirp Spectrum

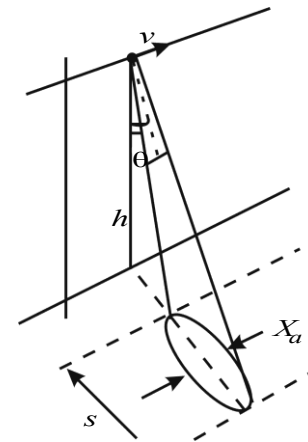

Mtco-0513

SAR Illumination Swath



# *Synthetic Aperture Radars (SARs) (contd)*

SRTM is a 5.3-GHz radar which was flown onboard the shuttle and obtained elevation data on a near-global scale to generate the most complete high-resolution digital topographic database of Earth. The following SRTM image to the left shows the topography of South America. The SRTM DEM image to the right shows the digital elevation model of the East Allgeru around the Royal Castles of Neuschwanstein and Hohenschwangau.



Color Shaded Digital Elevation Model

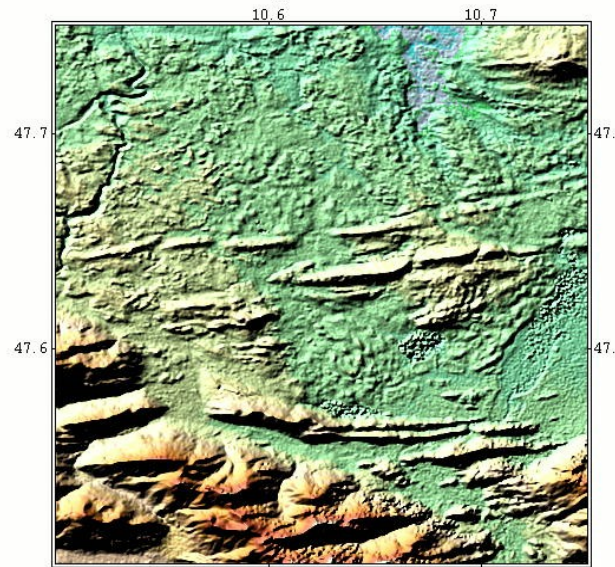

Wed Apr 17 13:34:06 2002

Site: E0103000N473000

Source: SRTM 1 arcsec

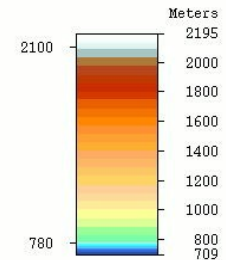

Projection: GEO / WGS84

Res	Easting	Northing	
0.00056	0.00056	d	
NW	10.50000	47.75000	d
SE	10.75028	47.49972	d

Produced by DLR

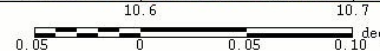

Deutsches  
Fernerkundungs-  
zentrum  
DLR für Luft- und Raumfahrt e.V. (DFZ)



# *Synthetic Aperture Radars (SARs) (contd)*

RADARSAT-1 is a 5-GHz radar and has been successfully used world wide to support disaster response efforts during events such as flooding, oil spills, volcanic eruptions and severe storms. The following Radarsat image (right) shows two flooded areas in north central Bulgaria in early June 2005 with respect to the reference Landsat image (left).

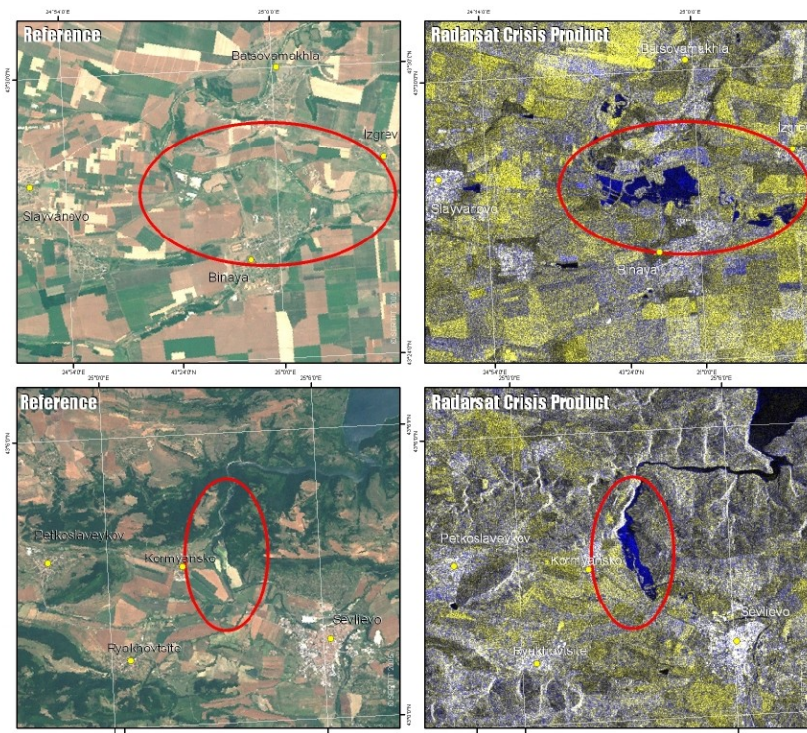

# Altimeters

- Provide altitude of the Earth's ocean surface
- RF center frequency depends on the ocean surface interaction with the EM field
- Dual frequency operation allows ionospheric delay compensation
- JASON-1 uses frequencies around 13.6 GHz and 5.3 GHz
- Allowable height accuracy degradation determines the allowable interference level

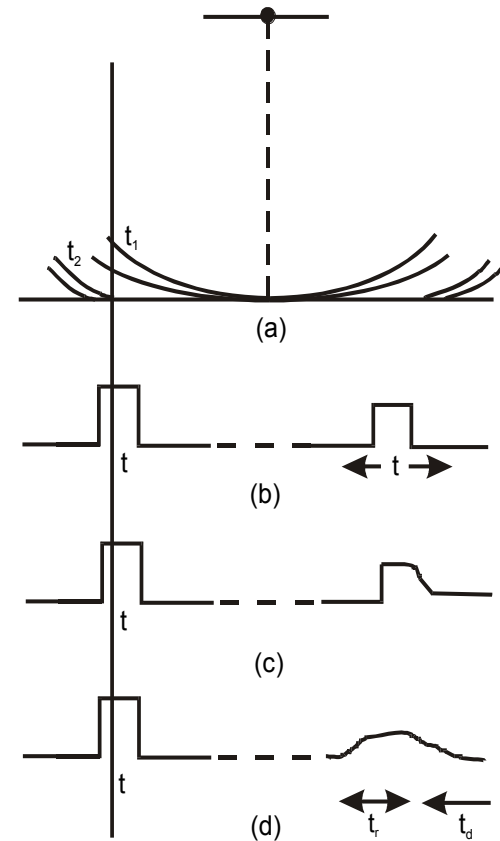
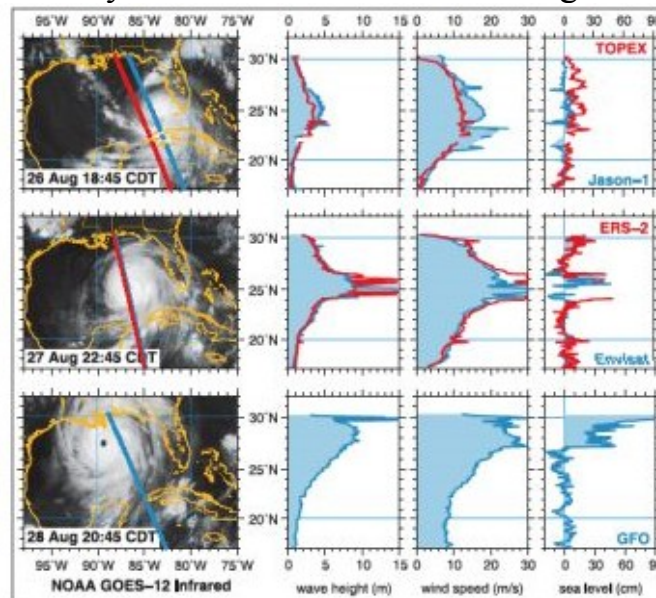

Illustration of Altimeter Return

# Altimeters (contd)

Jason is a dual-frequency radar at 5-GHz and 13-GHz, using radar altimetry to collect sea surface height data of all the world's oceans. Understanding the pattern and effects of climate cycles such as El Niño helps predict and mitigate the disastrous effects of floods and drought. Altimeter and scatterometer data are incorporated into atmospheric models for hurricane season forecasting and individual storm severity. Maps of currents, eddies, and vector winds are used in commercial shipping and recreational yachting to optimize routes. Cable-laying vessels and offshore oil operations require accurate knowledge of ocean circulation patterns to minimize impacts from strong currents. The following altimeter measurements taken during Hurricane Katrina in late August 2005 are shown to the right comparing altimeters Topex and Jason-1 (top row), ERS-2 and Envisat (center row), and Geosat follow on (bottom row), compare the GOES 12 infrared images and the altimeters to the left. The three columns on the right are altimeters measurements of wave height, wind speed, and sea level anomaly as a function of latitude along the altimeter tracks.



# Scatterometers

- Provide the wind direction and speed over the Earth's ocean surface
- RF center frequency depends on the ocean surface interaction with the EM field and its variation over aspect angle
- Narrow RF signal bandwidth provides the needed measurement cell resolution
- Allowable wind speed accuracy degradation determines the allowable interference level

Variation of  
Backscatter  
with Aspect  
Angle

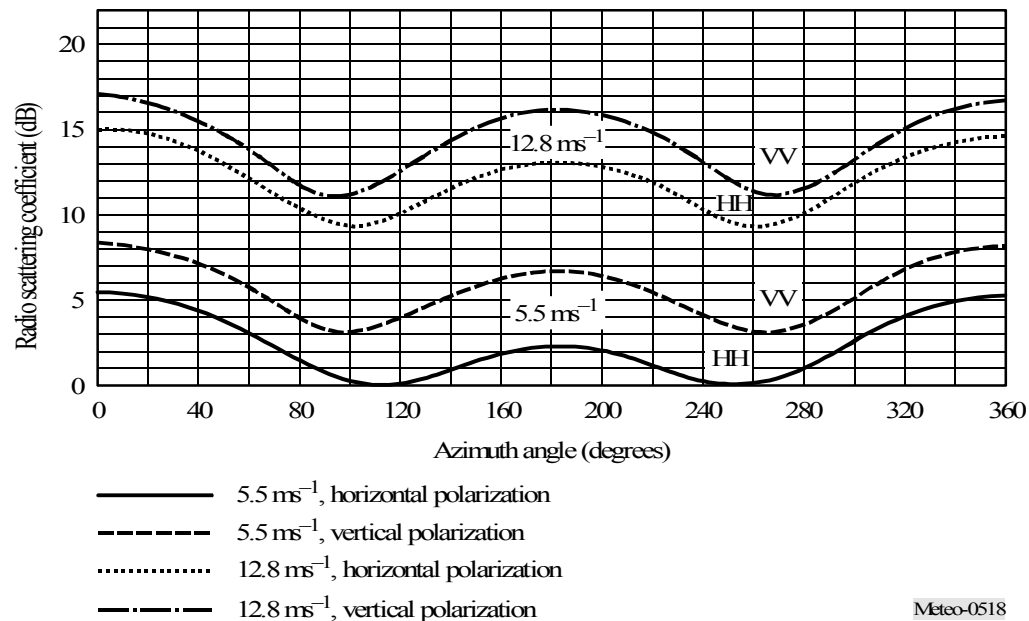

# *Ocean/land scatterometers*

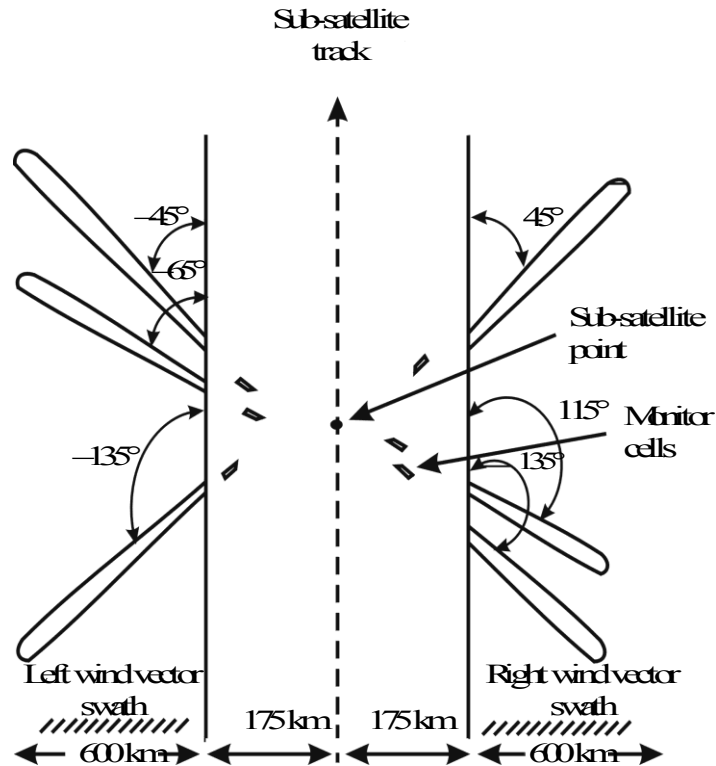

NSCAT illuminated the Earth's surface at several different fixed aspect angles

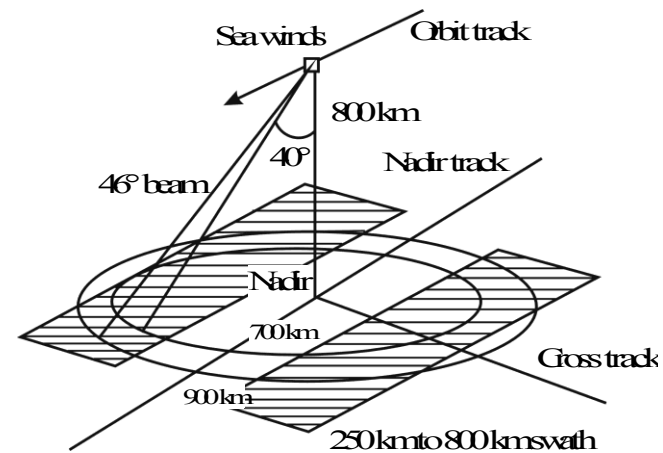

Mteo0519

SEAWINDS scanning pencil beam illuminates scans at two different look angles from nadir, and scans 360 degrees about nadir in azimuth

# *Ocean/land scatterometers*

## *(contd)*

The NSCAT instrument on the NSCAT satellite is a 13-GHz microwave scatterometer that measures backscatter from the Earth's surface as well as near-surface wind speed and direction under all weather and cloud conditions over Earth's oceans. The following data shows an example radar image taken from the NSCAT scatterometer of the Amazon rainforest in South America. The colors represent variations in backscatter power from the Amazon.

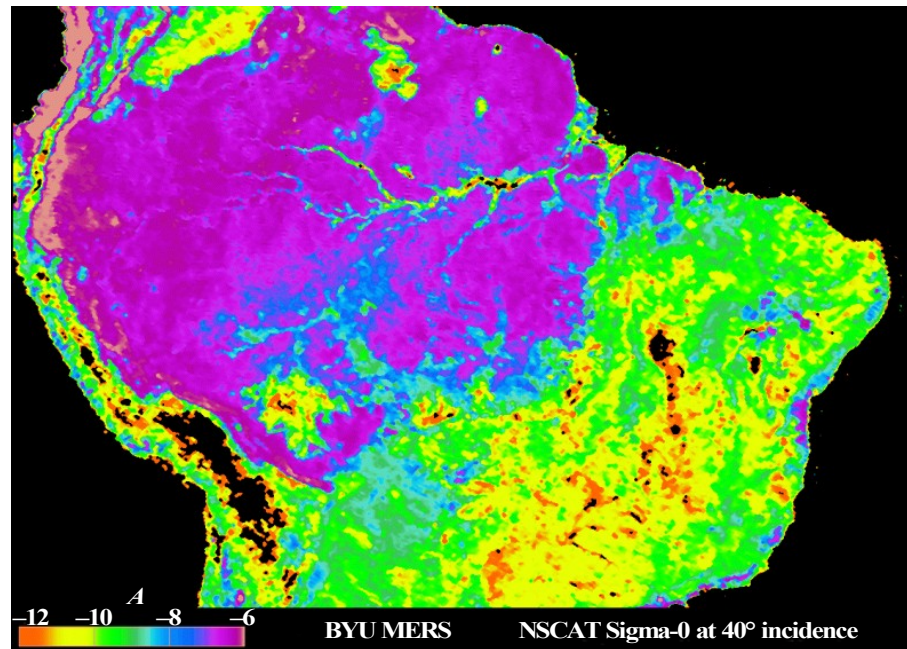

Metco-0521

**NSCAT scatterometers radar image of the Amazon rainforest in South America**



# *Ocean/land scatterometers (contd)*

The SeaWinds instrument on the QuikSCAT satellite is a specialized 13-GHz microwave radar that measures near-surface wind speed and direction under all weather and cloud conditions over Earth's oceans. On the left image shows data that are used to monitor changes in surface water resulting from Hurricanes Katrina and Rita in the Mississippi River basin in Oct 2005. The colors represent increases in surface soil moisture resulting from rainfall. On the right is shown the QuikScat observation of Hurricane Dean revealing the sea surface wind speed and direction.

## **Publications - NASA Satellite Monitors Post-Hurricane Gulf Coast Flood Potential**

October 14, 2005

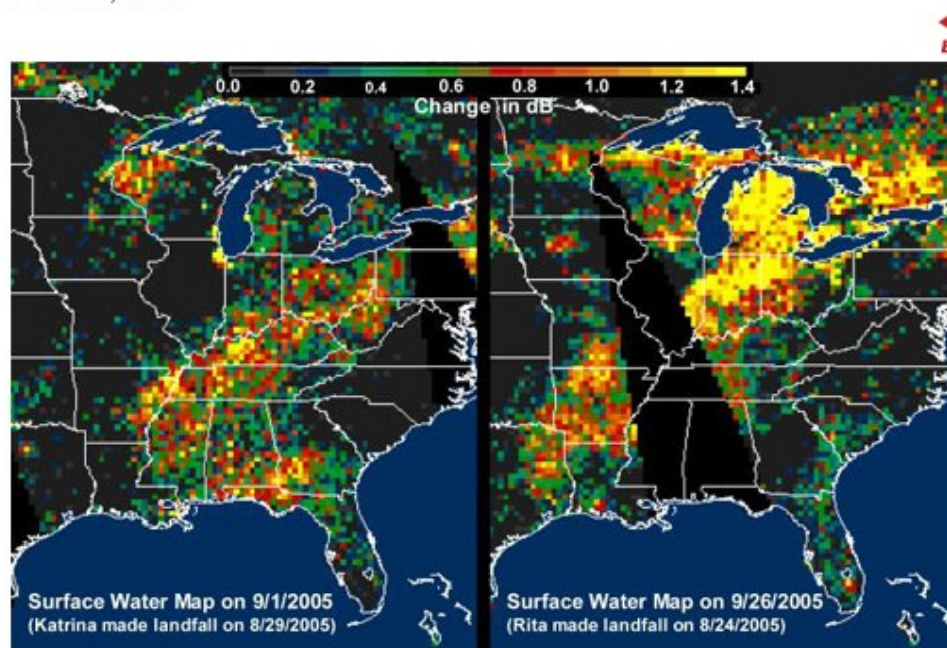

NASA Satellite Monitors Post-Hurricane Gulf Coast Flood Potential  
[Images and Animation](#)

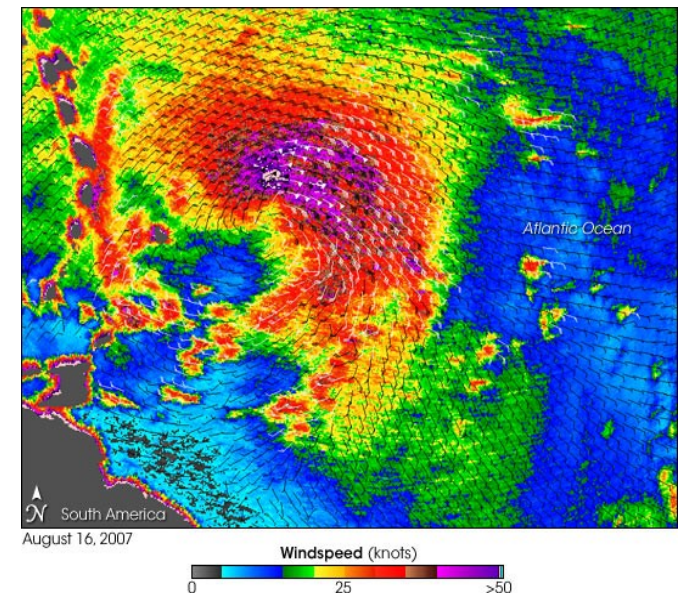



# Ocean/land scatterometers

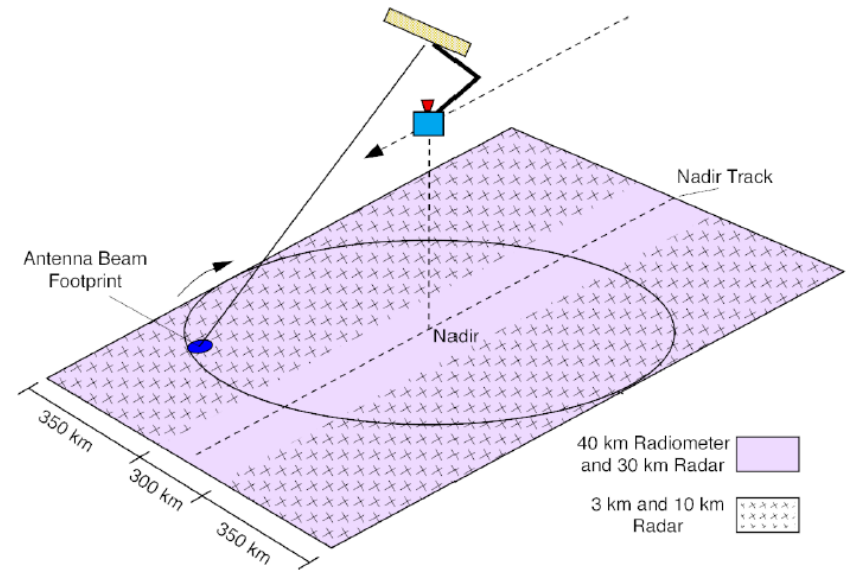
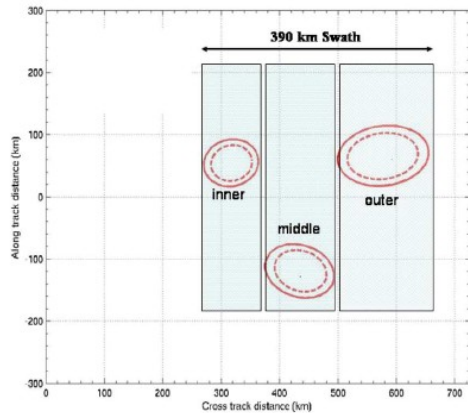
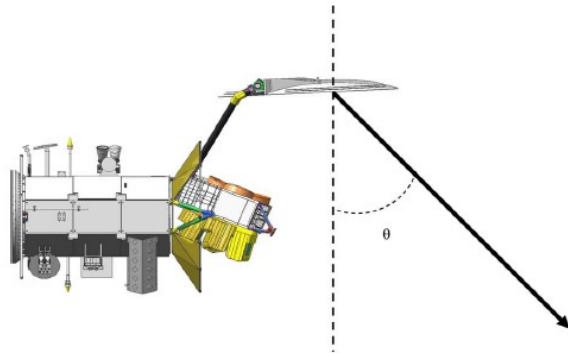

Aquarius scatterometer illuminates the Earth's surface at several different fixed aspect/nadir angle combinations

SMAP scatterometer scanning pencil beam illuminates scans at fixed look angle from nadir, and scans 360 degrees about nadir in azimuth

# *Ocean/land scatterometers*

## *(contd)*

The Aquarius instrument on the SAC-D satellite is a combined scatterometer/radiometer at 1.2-/1.4-GHz microwave instrument that measures sea salinity over Earth's oceans. The global map below is a composite of the data since Aquarius became operational on August 25, 2011 until July 7, 2012. The numerical values represent salt concentration in parts per thousand (grams of salt per kilogram of sea water). Yellow and red colors represent areas of higher salinity, with blues and purples indicating areas of lower salinity. Areas colored black are gaps in the data. The average salinity on the map is about 35.

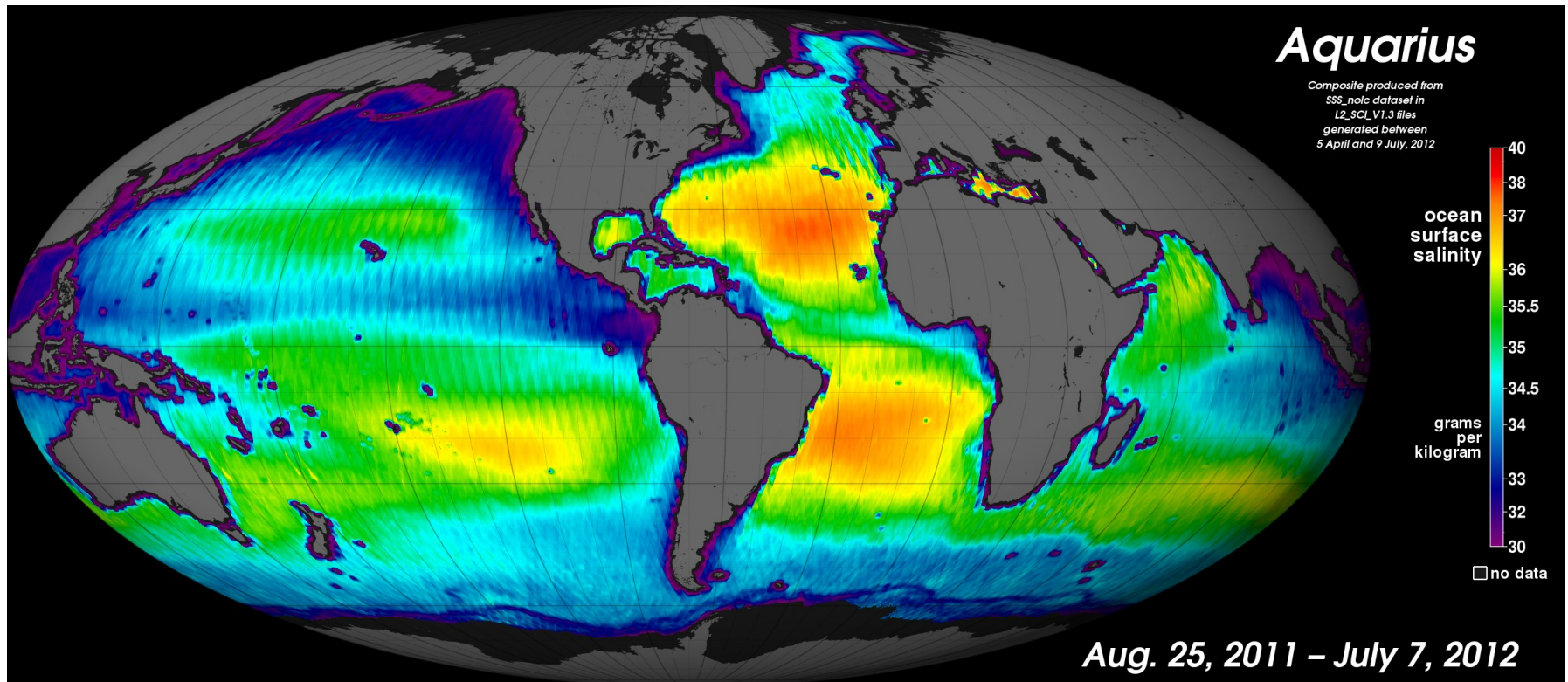

# *Precipitation Radars*

- Provide precipitation rate over the Earth's surface, typically concentrating on rainfall in the tropics
- RF center frequency depends on the precipitation interaction with the EM field
- Narrow RF signal bandwidth provides the needed measurement cell resolution
- Tropical Rainfall Measurement Mission (TRMM) uses only 0.6 MHz RF bandwidth
- Allowable minimum precipitation reflectivity degradation determines the allowable interference level

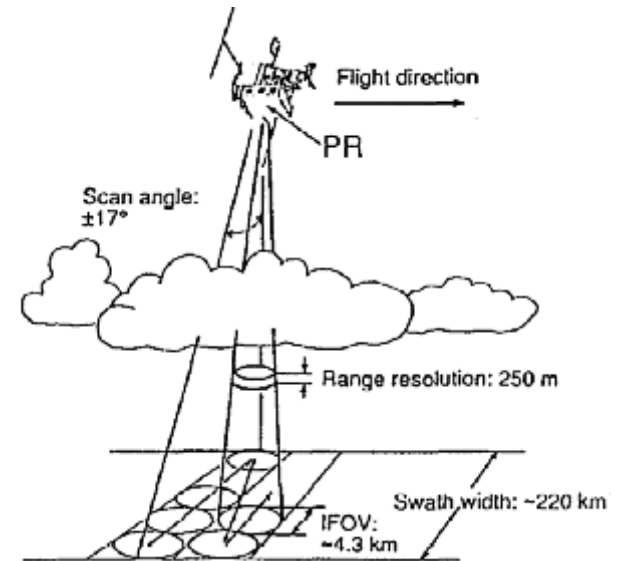

# *Precipitation Radars (contd)*

TRMM is the first 13-GHz spaceborne rain radar that measures the vertical distribution of precipitation over the tropics. TRMM is a research satellite designed to help our understanding of the water cycle in the current climate system. By covering the tropical and semi-tropical regions of the Earth, TRMM provides much needed data on rainfall and the heat release associated with rainfall. It is contributing to our understanding of how clouds affect climate and how much energy is transported in the global water cycle. In coordination with other satellites in NASA's Mission to Planet Earth, TRMM has begun the process of understanding the interactions between water vapor, clouds and precipitation that is central to regulating the climate system. The following TRMM image on the left shows the precipitation profile of the hurricane Ernesto on 26 August, 2006. TRMM reveals several deep convective towers (shown in red) that top out over 15km. The TRMM image on the right shows rain rate distribution of a Typhoon near Philippines on 14 Dec. 2008.

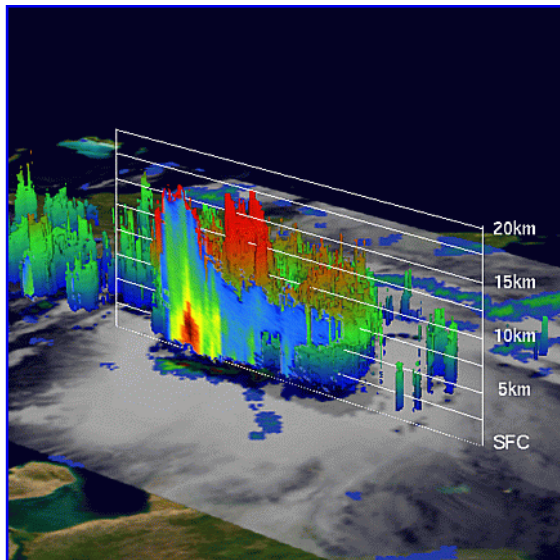

ERNESTO BECOMES THE FIRST ATLANTIC HURRICANE OF THE SEASON

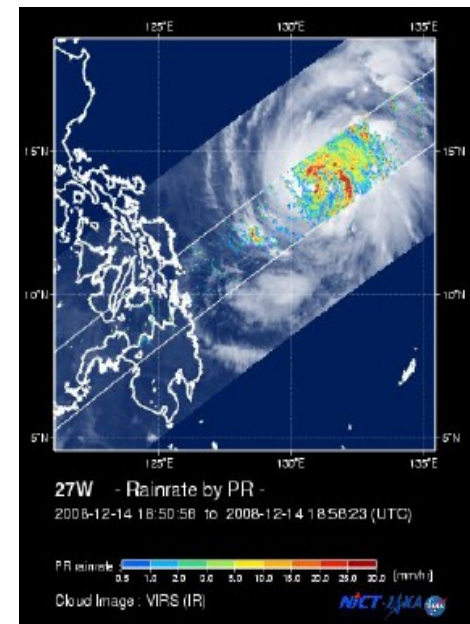



# *Precipitation Radars (contd)*

The following measurements taken during Hurricane Katrina in late August 2005 show a 3D visualization of the TRMM data.



# *Cloud Profile Radars*

- Provide three dimension profile of cloud reflectivity over the Earth's surface
- RF center frequency depends on the ocean surface interaction with the EM field and its variation over aspect angle
- Antennas with very low sidelobes so as to isolate the cloud return from the higher surface return illuminated by the sidelobes
- Narrow RF signal bandwidth provides the needed measurement cell resolution
- Allowable reflectivity accuracy degradation determines the allowable interference level

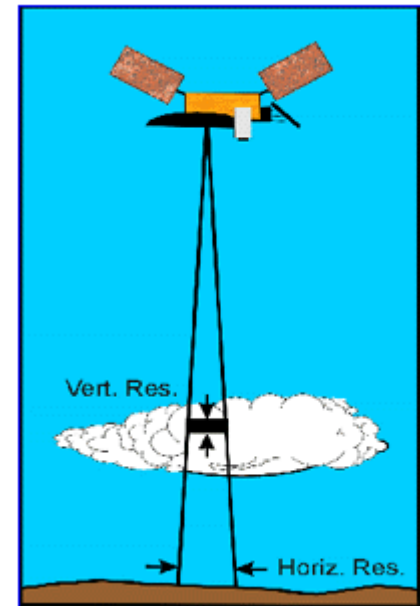

# Cloud Profile Radars (contd)

CloudSat is a Cloud Profiling Radar (CPR), a 94-GHz nadir-looking radar which measures the power backscattered by clouds as a function of distance from the radar. The following Cloudsat image is that of radar profiles of clouds around Hurricane Ileana on Aug 23, 2006. The top image is from NOAA's GOES to show the storm from the top. The bottom image is from CloudSat giving a profile of the cloud reflectivity versus distance from the radar.

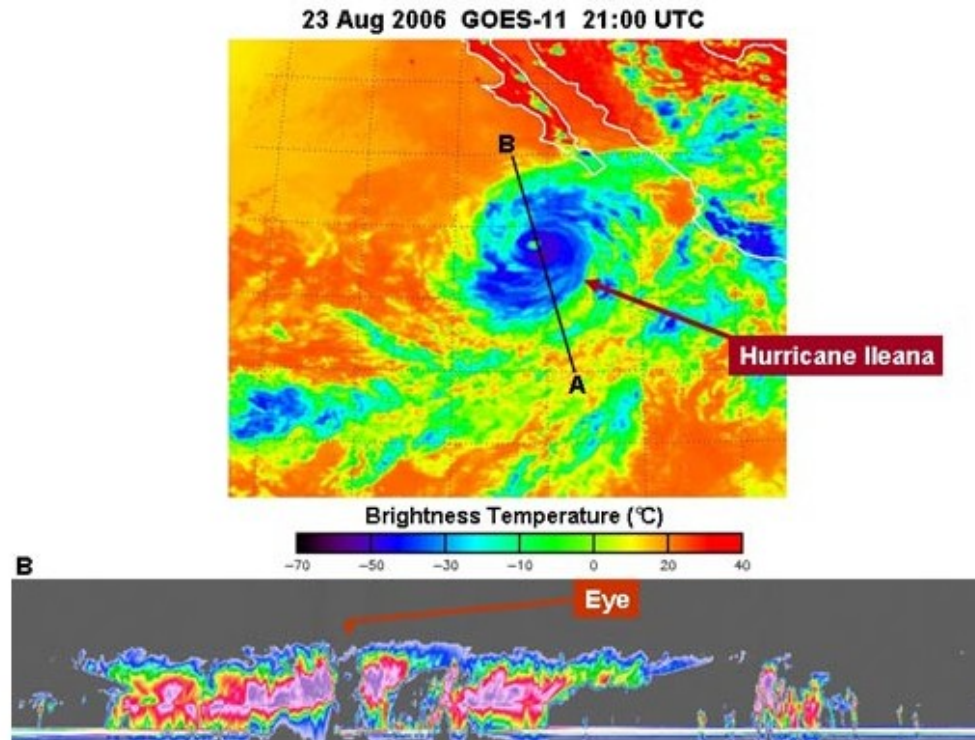

Eye of Hurricane Ileana

08.25.01



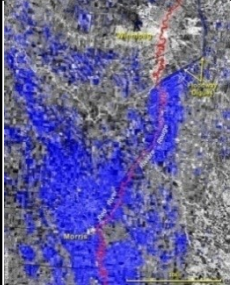
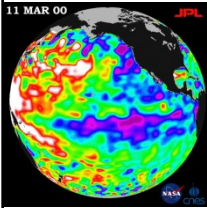
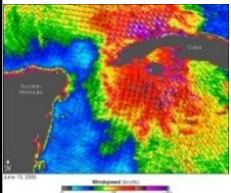

# Applications for EESS (active)

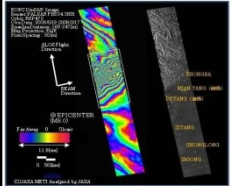
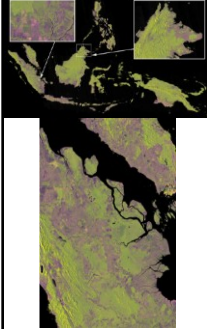
Application	Example	Description	Application	Example	Description
Flooding		RADARSAT image shows from to the area just south of Morris on April 27, 1997. Areas of standing water are shown in blue.	Drought		TOPEX/Poseidon satellite imagery of March 23, 2000, with persistent La Nina pattern dominating the and lower than normal sea-surface heights, indicating cooler temperatures
Severe Storms		SeaWinds data of Tropical Storm Alberto on June 10, 2006, in the Yucatan Channel ; image depicts wind speed in color and wind direction with small barbs.	Hurricane		TRMM rainfall data combined with wind data from SeaWinds on QuikSCAT showing image of Hurricane Floyd in Sep 1999
Earthquake		PALSAR shows diastrophism by processing the image data of SAR imagery taken on 20 May 2008, and one also taken by the PALSAR on 17 Feb. 2008 using the differential interferometric method. The change in the distance between the ALOS spacecraft and the Earth in about three months between 17 Feb. and 20 May is indicated by the two-dimensional colours in the image.	Forestry		First PALSAR image is colour composite of R= HH polarization, G=HV polarization, B=HH-HV polarization image. Greenish colour shows a forest and purple colour shows either a deforested area or an area which is not a forest. Second figure below is expanded image of part of first figure.

# Applications for EESS (active)

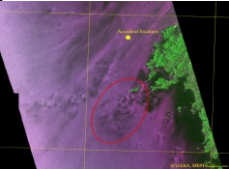
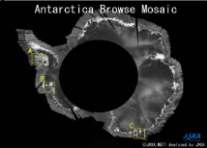
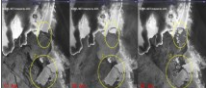
Application	Example	Description	Application	Example	Description
Oil Outflow		PALSAR image shows that the dark area inside the red circle is oil outflow. It is an enlarged image of the neighbourhood of the scene of the accident using a polarimetry image of the 11 December 2007 observation.	Ice	 	<p>PALSAR image above shows mosaic images using PALSAR data during the time between 8 Dec. 2007 and 22 Jan. 2008 (Area B: Near King Peninsula). The white area is very bumpy and the black area is smooth. Second figure below shows the changes at the coastal region (Area B) of the pine island glacier located at the root of the Antarctica peninsula. Expanded image of Area B in first figure (left August 2007, centre January 2008, and right June 2008). During a year, ice cracked down and moved off the coast in the region 1 (upper yellow circle). Region 2 (lower yellow circle) also shows the ice sheet floating.</p>