

International Telecommunication Union

**ITU-R**  
Radiocommunication Sector of ITU

**Report ITU-R BT.2053-2**  
(11/2009)

# **Large screen digital imagery**

**BT Series**  
**Broadcasting service**  
**(television)**



International  
Telecommunication  
Union

## Foreword

The role of the Radiocommunication Sector is to ensure the rational, equitable, efficient and economical use of the radio-frequency spectrum by all radiocommunication services, including satellite services, and carry out studies without limit of frequency range on the basis of which Recommendations are adopted.

The regulatory and policy functions of the Radiocommunication Sector are performed by World and Regional Radiocommunication Conferences and Radiocommunication Assemblies supported by Study Groups.

## Policy on Intellectual Property Right (IPR)

ITU-R policy on IPR is described in the Common Patent Policy for ITU-T/ITU-R/ISO/IEC referenced in Annex 1 of Resolution ITU-R 1. Forms to be used for the submission of patent statements and licensing declarations by patent holders are available from <http://www.itu.int/ITU-R/go/patents/en> where the Guidelines for Implementation of the Common Patent Policy for ITU-T/ITU-R/ISO/IEC and the ITU-R patent information database can also be found.

### Series of ITU-R Reports

(Also available online at <http://www.itu.int/publ/R-REP/en>)

Series	Title
<b>BO</b>	Satellite delivery
<b>BR</b>	Recording for production, archival and play-out; film for television
<b>BS</b>	Broadcasting service (sound)
<b>BT</b>	<b>Broadcasting service (television)</b>
<b>F</b>	Fixed service
<b>M</b>	Mobile, radiodetermination, amateur and related satellite services
<b>P</b>	Radiowave propagation
<b>RA</b>	Radio astronomy
<b>RS</b>	Remote sensing systems
<b>S</b>	Fixed-satellite service
<b>SA</b>	Space applications and meteorology
<b>SF</b>	Frequency sharing and coordination between fixed-satellite and fixed service systems
<b>SM</b>	Spectrum management

*Note: This ITU-R Report was approved in English by the Study Group under the procedure detailed in Resolution ITU-R 1.*

Electronic Publication  
Geneva, 2010

© ITU 2010

All rights reserved. No part of this publication may be reproduced, by any means whatsoever, without written permission of ITU.

## REPORT ITU-R BT.2053-2

**Large screen digital imagery**

(Question ITU-R 15/6)

(2005-2006-2009)

**Foreword**

This Report has been prepared by Radiocommunication Study Group (SG) 6 and Radiocommunication Task Group (TG) 6/9, and contains information gathered from a number of external sources as well as from Radiocommunication TG 6/9. The terminology used throughout this Report is not consistent, other bodies such as, Society of Motion Picture and Television Engineers (SMPTE)<sup>1</sup>, and European Digital Cinema Forum (EDCF)<sup>2</sup> and technical publications, have used different terms in their deliberations to the terms adopted by Radiocommunication TG 6/9 in defining large screen digital imagery (LSDI). Further, it is not appropriate to draw comparisons between various definitions. This Report retains the original text provided by the various sources. The reader is cautioned not to draw any conclusions on the eventual adoption of terminology within this evolving industry.

**1 Introduction**

Radiocommunication TG 6/9 was formed by SG 6 in 2002 as a result of the adoption of ITU-R Question 15/6 “Digital cinema (D-Cinema) broadcasting”. Dr Joseph Flaherty of the North American Broadcasting Association (NABA) chaired the task group.

Radiocommunication TG 6/9 held its first meeting in March 2002. Some questions were raised concerning the scope of the task group; and it was concluded that aspects specifically relating to motion pictures (movies) should be based on standards developed by the motion picture expert groups. As a result, a revised Question was prepared and subsequently adopted, and the term “large-scale digital imagery (LSDI)” has been employed to describe the area of work of the task group. The revised Question is attached as Appendix 1.

This Report is intended to supplement the set of Recommendations prepared by the task group, giving a brief summary of LSDI and the work of the task force and providing detailed information on LSDI technology and LSDI applications. A progress report on standardization for digital cinema is also included.

**2 What is LSDI?**

Large screen digital imagery (LSDI) is a family of digital imagery systems applicable to programmes such as dramas, plays, sporting events, concerts, cultural events, etc., from capture to large screen presentation in high-resolution quality in appropriately equipped theatres, halls, and other venues. There may be many types and sizes of LSDI venues and audiences, but audiences larger than typical family viewing, using display systems larger than those that would normally be considered for a home environment, characterize LSDI.

---

<sup>1</sup> See digital cinema Specification V1.0 as submitted to the SMPTE at [www.dcinovies.com](http://www.dcinovies.com).

<sup>2</sup> See definitions of the EDCF four levels in § 1 of Chapter 3 of Part 2.

LSDI became practical as a result of the development of electronic display systems suitable for viewing by an audience of significant size. Such display systems evolved in a number of areas. Some systems were designed to display very large – albeit relatively low resolution – images for viewing at long distances by very large audiences, such as in sports venues. Other systems were developed by the computer and audio/video (A/V) industries to facilitate presentation of electronic slides to smaller audiences in business environments.

Eventually, these developments led to display systems that could produce an audience experience comparable to that delivered by projection of 35 mm motion picture film, and the concept of digital cinema was born.

It soon became apparent that the evolving technologies could serve two very different areas of requirements.

The motion picture industry intends to develop systems to replace the distribution and projection of 35-mm film prints. In this area it is vitally important to preserve characteristics of film that differentiate it from television, including extended colour gamut and very large contrast range. These considerations meant that the motion picture industry needed to undertake extensive studies based on the unique requirements of the business.

Another area of great interest is the use of LSDI to permit presentation of television programming to large audiences, such as in theatres. Obvious examples are sports events and concerts or other stage productions. In this area it is essential that the characteristics of LSDI systems be closely matched to the television systems that are likely to be used to acquire the programmes

### **3 LSDI venues**

LSDI is suited to any venue where electronically delivered moving images are to be displayed for an audience. Such venues may range from community television halls to stadium environments while the audience size may range from few persons to many tens of thousands. Some of the many possible LSDI venues, and ways in which they may be used, are discussed in Chapter 7 of Part 1.

The work of the task group focused largely on LSDI for theatrical environments. It was recognized that even this classification may include venues of many sizes and characteristics, but emphasis was given to venues where audiences could receive a “big-screen” experience. The LSDI sound system should have characteristics commensurate with this, so as to enhance the overall audience experience. Generally, the LSDI experience should represent a significant enhancement over conventional television, even large-screen television. Recommendation ITU-R BT.1690 describes such a theatrical environment in perceptual terms.

### **4 Video signal formats for LSDI**

The task group developed two Recommendations for baseband video formats for LSDI.

Recommendation ITU-R BT.1680 recommends the use of Recommendation ITU-R BT.709 (1 920 × 1 080 at various frame rates, interlaced and progressive) and Recommendation ITU-R BT.1543 (1 280 × 720 at 59.94 Hz, progressive). It further recommends that for an expanded hierarchy of LSDI digital image formats for future LSDI applications that may require certain resolution and scanning formats that go beyond current technical solutions or those image formats used in other applications a hierarchical relationship with existing Recommendations be retained.

For applications where high-definition signals are not available, Recommendation ITU-R BT.1689 recommends the use of Recommendation ITU-R BT.601 (720 × 576/480 at 50/59.94 Hz).

Programme material for LSDI will normally need to be compressed for delivery to the venue; Recommendation ITU-R BT.1687 recommends the use of MPEG-2. This Recommendation suggests that LSDI applications will generally need higher bit rates than those used for delivery of television to the home. Recommendation ITU-R BT.1687 recommends “MPEG-2 interframe bit-rate reduction at [MP@HL](#) (HiQ) and at a minimum video net bit rate of the order of 20 Mbit/s should be preferred in the short term, for real-time distribution of LSDI programmes for their theatrical presentation.”

## **5 Audio for LSDI**

The task group recognized that high-quality, multichannel audio is an essential component of presentation in an LSDI environment.

Recommendation ITU-R BT.1688 recommends a delivery of 5.1 channel audio as part of LSDI programming, and the use of 48 kHz sampling at a minimum 16-bit resolution, and the use of either baseband PCM, AC-3, or AAC encoding.

Some LSDI applications for a large theatrical environment may need multichannel sound systems that can reproduce the sound sources, which are localized at a higher position over the listener, and vertical and horizontal movements of sound sources. Several multichannel sound systems are currently applied or studied for a theatre with a large screen, and some of them have loudspeakers arranged above and around the viewer.

## **6 Quality considerations for LSDI**

Audiences will have high expectations for LSDI and the quality of the presentation will be critical to success in many areas. Recommendation ITU-R BT.1662 discusses issues of post-processing headroom in the LSDI chain. Recommendation ITU-R BT.1663 addresses display quality; Recommendation ITU-R BT.1686 covers measurement of image parameters, and Recommendation ITU-R BT.1721 makes recommendations for measurement of perceptive image quality. Recommendation ITU-R BT.1679 addresses subjective evaluation of audio quality in LSDI environments.

A study on psychological effects of wide-screen display systems confirms that wider viewing angles generate higher “sensation of reality”. It also implies that LSDI with higher resolution than HDTV would be needed for applications that require a higher “sensation of reality”. On the other hand, it is known that decreases of comfortableness would arise when the viewing position is too close to wide-screen images. Based on such results, parameter values for expanded hierarchy of LSDI systems such as display size, viewing distance and spatial resolution might be determined.

## **7 Delivery of LSDI content**

Traditional broadcast channels such as terrestrial transmission will not generally deliver LSDI content. The large screen will make impairments such as compression artefacts more apparent, and lower compression ratios will normally be needed for LSDI.

Real-time delivery of LSDI will normally use broadband terrestrial circuits or satellite systems. Recommendation ITU-R BT.1727 addresses these forms of delivery.

Non-real-time delivery may use similar circuits, or may use tapes or disks. Recommendation ITU-R BT.1694 makes recommendations for the use of videocassette recordings.

## 8 LSDI technologies and implementations

Current and future LSDI technologies are both discussed in Part 1, which consists of eight Chapters related to the various components of the LSDI chain. Part 2 includes available information on the status of implementations of LSDI applications around the world and future LSDI trends. It is divided into three Chapters, one for each region covered by relevant investigations, namely America (North and South), Asia and Europe.

## 9 Digital cinema

A progress report on standardization for digital cinema will eventually be included, as Part 3 of this Report.

## 10 Recommendations

The Recommendations developed by the task group are listed below in Table form, and with a brief summary of the subject matter.

### LSDI application for presentation in a theatrical environment Recommendations already developed by Radiocommunication TG 6/9

Rec. ITU-R	Title
BT.1662	General reference chain and management of post-processing headroom for programme essence in large screen digital imagery applications
BT.1663	Expert viewing methods to assess the quality of systems for the digital display of large screen digital imagery in theatres
BT.1664	Representation of various image aspect ratios into the image of large screen digital imagery applications that use a 16:9 raster
BT.1665	Considerations for colour encoding and spatial resolution for large screen digital imagery display
BT.1666	User requirements for large screen digital imagery applications intended for presentation in a theatrical environment
BS.1679	Subjective assessment of the quality of audio in large screen digital imagery applications intended for presentation in a theatrical environment
BT.1680	Baseband imaging format for distribution of large screen digital imagery applications intended for presentation in a theatrical environment
BT.1686	Methods of measurement of image presentation parameters for large screen digital imagery programme presentation in a theatrical environment
BT.1687	Video bit-rate reduction for real-time distribution of large screen digital imagery applications for presentation in a theatrical environment
BS.1688	Baseband sound system and audio source-coding at delivery interfaces of large screen digital imagery applications
BT.1689	Guidelines on the presentation in large screen digital imagery environments of programmes that are provided in image formats conforming to Recommendation ITU-R BT.601
BT.1690	Assumed characteristics of venues intended for large screen digital imagery programme presentation in a theatrical environment

Rec. ITU-R	Title
BR.1694	Videocassette recording formats for international exchange of large screen digital imagery programmes intended for presentation in a theatrical environment
BT.1721	Objective measurement of perceptual image quality of large screen digital imagery applications for theatrical presentation
BT.1727	Terrestrial and satellite delivery of programme material to large screen digital imagery venues
BS.1734	Basic performance requirements for the sound components of large screen digital imagery applications for presentation in a theatrical environment

Recommendation ITU-R BT.1662 – General reference chain and management of post-processing headroom for programme essence in large screen digital imagery applications

This Recommendation specifies a general reference chain that should be used to study post-processing headroom management for typical LSDI applications that are based on the use of a fully digital signal chain for programme signals.

Recommendation ITU-R BT.1663 – Expert viewing methods to assess the quality of systems for the digital display of large screen digital imagery in theatres

This Recommendation recognizes that non-expert subjective testing, as specified in Recommendation ITU-R BT.500, is expensive and time-consuming, and may not be practicable in all circumstances. The Recommendation recommends a method for assessing quality using expert viewers, believed to be suitable for some LSDI applications.

The Recommendation recognizes that the method requires further verification, and it further recommends additional studies on sensitivity and results processing.

Recommendation ITU-R BT.1664 – Representation of various image aspect ratios into the image of large screen digital imagery applications that use a 16:9 raster

This Recommendation specifies how images with original aspect ratios other than 16:9 should be fitted into a 16:9 presentation raster. It specifically defines how LSDI programme images should be treated in order that it can be fitted into a 16:9 presentation raster when the original aspect ratio of those images is different from 16:9.

Recommendation ITU-R BT.1665 – Considerations for colour encoding and spatial resolution for large screen digital imagery display

This Recommendation specifies the factors that should be used as the basis of the design and evaluation of colour encoding and spatial sampling methods for digital display of high-quality images in theatres. The Recommendation states that the methods used for the design and evaluation of colour encoding and spatial sampling should be based on the properties of the human visual system. However, these methods should be arrived at within the limits of practical engineering, taking into account cost and complexity.

Recommendation ITU-R BT.1666 – User requirements for large screen digital imagery applications intended for presentation in a theatrical environment

This Recommendation assembles the user requirements identified for LSDI applications intended for presentation in a theatrical environment. It is based on information contributed by several administrations and professional communities. Its purpose is to provide a tool to evaluate whether various possible technical approaches are suitable to meet the needs of those applications.

Recommendation ITU-R BS.1679 – Subjective assessment of the quality of audio in large screen digital imagery applications intended for presentation in a theatrical environment

This Recommendation specifies the provisions that should be implemented when performing subjective assessment tests of audio quality or of audio impairment in LSDI applications designed for programme presentation in a theatrical environment.

Recommendation ITU-R BT.1680 – Baseband imaging format for distribution of large screen digital imagery applications intended for presentation in a theatrical environment

This Recommendation specifies members of a hierarchy of LSDI digital image formats that should be used as baseband imaging formats for distribution of programmes for LSDI applications intended for theatrical environment. This Recommendation identifies existing Recommendations ITU-R BT.709 and ITU-R BT.1543 as two members of such a hierarchy.

Recommendation ITU-R BT.1686 – Methods of measurement of image presentation parameters for large screen digital imagery programme presentation in a theatrical environment

This Recommendation specifies the correct way to perform on-screen measurements of the main projection parameters of LSDI applications based on presentation of programmes in a theatrical environment. The Recommendation is based on recent IEC publications, integrated with the specifications for a specialized device intended to limit the influence of stray light falling on the screen on the measured parameter values.

Recommendation ITU-R BT.1687 – Video bit-rate reduction for real-time distribution of large screen digital imagery applications for presentation in a theatrical environment

This Recommendation specifies the video signal encoding and compression methods appropriate for use in the near term in the distribution of LSDI programmes intended for presentation in a theatrical environment.

Recommendation ITU-R BS.1688 – Baseband sound system and audio source-coding at delivery interfaces of large screen digital imagery applications

This Recommendation specifies the baseband parameters for audio systems for LSDI applications, and the source coding methods to be used in various presentation instances. It is based on the use of existing ITU Recommendations on audio baseband digital encoding and source coding.

Recommendation ITU-R BT.1689 – Guidelines on the presentation in large screen digital imagery environments of programmes that are provided in image formats conforming to Recommendation ITU-R BT.601

This Recommendation specifies provision intended to obtain the best possible image quality in an LSDI presentation in a theatrical environment, in the case of programmes that are only available in image formats conforming to Recommendation ITU-R BT.601.

Recommendation ITU-R BT.1690 – Assumed characteristics of venues intended for large screen digital imagery programme presentation in a theatrical environment

This Recommendation specifies the performance of LSDI theatrical-type venues, to be assumed in the selection and design of audio and video parameters and processing for LSDI programme presentation in a theatrical environment. The indications are provided in perceptual terms, and are independent of the implementation details of such venues.

Recommendation ITU-R BR.1694 – Videocassette recording formats for international exchange of large screen digital imagery programmes intended for presentation in a theatrical environment

This Recommendation specifies a recording medium for the distribution of LSDI applications for programme presentation in a theatrical environment. The method is based on the use of digital videocassette recordings of adequate quality. The Recommendation is intended to facilitate international exchange of these recordings.



Recommendation ITU-R BT.1721 – Objective measurement of perceptual image quality of large screen digital imagery applications for theatrical presentation

This Recommendation specifies that the measurement techniques for the objective measurement of perceptual image quality of LSDI applications for theatrical presentation should conform to those specified in Recommendation ITU-R BT.1683, applicable to standard-definition digital broadcasting systems.

Recommendation ITU-R BT.1727 – Terrestrial and satellite delivery of programme material to large screen digital imagery venues

This Recommendation specifies the video source-coding system, sound-coding system and emission systems for the terrestrial or satellite delivery of programme material to LSDI venues.

## 11 Future work

Radiocommunication SG 6 received a number of contributions on the following issues, which although not resulting in Recommendations are deemed to be a significant complement to LSDI technology:

a) *Classification of television applications*

This issue relates to verify whether the performance capability of some television systems specified in ITU-R Recommendations matches the performance requirements of the new application. Relevant criteria are based on the use of the “design viewing angle” of each application, a concept already partially included in Recommendation ITU-R BT.1127.

b) *Expanded hierarchy of LSDI systems*

This issue relates to image formats of  $3\,840 \times 2\,160$  and  $7\,680 \times 4\,320$  (2 and 4 times  $1\,920 \times 1\,080$  respectively, for both horizontal and vertical direction) intended for applications requiring wider viewing angle and/or higher resolution than those provided by the  $1\,920 \times 1\,080$ . Contributions were received on image parameter values, psychological effects of wide viewing angle, development of the system and implementation examples. They resulted in a preliminary draft new Report (PDNR) titled: “Parameter values for an expanded hierarchy of LSDI systems for acquisition, production, post-production, storage, delivery, display and programme exchange”.

c) *Multichannel sound systems for LSDI beyond the 5.1 channel system*

This issue relates to the continuation of studies on multichannel sound systems having more sound channels than recommended in Recommendation ITU-R BT.1688. A working document titled: “Framework for future studies on multichannel sound systems”, lists a number of such systems inviting for additional studies.

d) *Methods to measure the characteristics of LSDI sound presentation*

This important issue relates to the standardization of objective measurement schemes, which should be carried out by specific expertise.

According to the decisions of Radiocommunication SG 6, studies of the above-mentioned items might be continued by assigning them to relevant working parties, or resuming a specific task group when the progress of LSDI technologies and the development of LSDI applications reach an appropriate phase.

## Appendix 1

QUESTION ITU-R 15-1/6

### Large screen digital imagery<sup>3</sup>

(2002-2003)

The ITU Radiocommunication Assembly,

*considering*

- a) that new very high resolution, large screen digital imagery (LSDI) are being introduced in some countries, whereby dramas, plays, sporting events, concerts, cultural events, etc., photographed electronically or on film, can be delivered, and exhibited in high resolution quality in theatres, halls, and other venues equipped with digital imaging capabilities;
- b) that such practice has the potential to produce excellent picture quality, equal or superior to that available heretofore, and opens the possibility for program delivery in various digital forms for exhibition to large audiences;
- c) that such practice is reported to also offer significant benefits in terms of a faster, lower cost production/postproduction and distribution, including to smaller, less-developed markets;
- d) that high resolution, bright, large screen projection equipment is becoming available from several international manufacturers;
- e) that it may be beneficial to develop a uniform or compatible hierarchy of technical standards for program recording, mastering<sup>4</sup>, exchange, delivery and exhibition, harmonized with those established for the recording and mastering, exchange and delivery of programs for other applications, since this can ease international program exchange;
- f) that the ITU-R has been studying extremely high resolution imagery under Question ITU-R 40/6 based on the concept of a tiered or hierarchical approach;
- g) that the introduction of digital technologies results in the converging of broadcast and telecommunication data channels, so that the secondary distribution of digital programs now also foresees the possible distribution of digital packetized data, in real-time and non-real-time, program-related and non-program-related, to the general public as well as to individual recipients or groups of recipients;

---

<sup>3</sup> Large Screen Digital Imagery is a family of digital imagery systems applicable to programs such as dramas, plays, sporting events, concerts, cultural events, etc., from capture to large screen presentation in high resolution quality in appropriately equipped theatres, halls, and other venues.

<sup>4</sup> The term “mastering” indicates the set of those technical activities that lead to the finished edited master of a program, which normally materializes the creative intent of its authors (see for instance Recommendation ITU-R BR.1292).

- h) that the definition of broadcasting included in the ITU Constitution (CS/A.1010)<sup>5</sup> from the regulatory point of view, makes no distinction between real-time and non-real-time service delivery, nor between interactive and non-interactive programming, nor among sound, television or other types of content, nor among analog, digital or digital packetized delivery;
- j) that various aspects of LSDI are within the scope of Radiocommunication SG 6 as defined in Resolution ITU-R 4-3, e.g.:
- acquisition, production, postproduction and mastering;
  - storage and transfer to and from film for international exchange;
  - encoding, encryption and assembling with control and metadata;
  - delivery by terrestrial or satellite means;
  - quality assessments of the proposed technical solutions;
- k) that some other aspects of LSDI are in the scope of ITU-T Study Group 9; the IEC and ISO; other international or regional standardizing bodies as well as other relevant fora;
- l) that, in view of its scope, Study Group 6 is well placed to act as a focal point to co-ordinate relevant studies among the various concerned ITU and non-ITU bodies;
- m) that studies on LSDI are important both for the theatre and for broadcasting, and the announced imminent opening of some LSDI operational services makes it urgent for the ITU to initiate those studies;
- n) that although studies are currently being carried out in various countries on all aspects of LSDI, those specifically related to motion pictures<sup>6</sup> are not yet fully completed,

*decides* that the following Question should be studied

- 1 What are the picture and sound performance goals, in subjective and objective terms, of the various applications of the LSDI system?
- 2 What methods are appropriate for the subjective and objective assessment of the sound and image quality of LSDI systems?
- 3 Which hierarchically related standards would be required to meet the LSDI subjective performance goals in the acquisition, production, post-production and international exchange of LSDI programs for various applications?
- 4 Which digital mastering, production, post-production, storage, program exchange formats, standards and operating practices should be recommended in order to reliably meet the LSDI performance goals?
- 5 Which methods can be recommended to transfer LSDI material to and from 35-mm film?
- 6 Which information related to LSDI programs should be included as metadata through the mastering and carried through the digital distribution chain, and in which form?

---

<sup>5</sup> The definition of broadcasting given in the ITU Constitution (CS/A.1010) is broadcasting service: A radiocommunication service in which the transmissions are intended for direct reception by the general public. This service may include sound transmissions, television transmissions or other types of transmission.

This definition appears also as 1.38 in Art. 1 of the ITU Radio Regulations, and the scope of Radiocommunication SG 6 in Resolution ITU-R 4-4 provides details on it.

<sup>6</sup> The term “motion pictures” (also called movies, features, etc.), is used to indicate content that is intended for first release in a cinema theatre setting.

7 Which methods can be recommended for the bit-rate-reduction encoding and for the encryption of LSDI programs?

8 Which methods can be recommended to adapt LSDI programs for delivery by terrestrial or satellite emission?

9 Which methods can be recommended for archiving of LSDI material?

*further decides*

1 that co-operation between ITU-T Study Group 9 and Radiocommunication SG 6 would allow the selection of methods for the delivery of LSDI programs to their end users by television cable, fiber networks and telecommunications networks;

2 that co-operation with the ISO/IEC JTC1/SC29/WG11 (MPEG) would allow the selection of compression tools for the delivery of LSDI programs to their end users;

3 that co-operation with ISO, IEC and the other international and regional standardizing bodies and fora (see examples in Annex 1) would allow the specification of the LSDI's presentation environment objectives and the related methods and devices;

4 that co-operation with other bodies such as those given as examples in Annex 1 would allow the selection of methods compatible with the end-to-end LSDI specifications currently being developed;

5 that liaison with bodies such as those listed as examples in Annex 1 should be used to assist SG 6 in determining time-scales and priorities for its studies;

6 that the bodies selected for liaison should be chosen on a case-by-case basis depending on their relevance to the particular topic;

7 that SG 6 studies of the methods for the production, delivery and presentation of LSDI programs should rely, where appropriate, on the use of existing tools and toolkits;

8 that the LSDI studies should result in a set of Recommendations based on a hierarchy of levels of system performance that harmonize where possible with existing systems for digital imagery;

9 That while studies of LSDI may include characteristics<sup>7</sup> that are common to motion pictures<sup>8</sup> and in the purview of Radiocommunication SG 6, Radiocommunication SG 6 recognises that aspects<sup>9</sup> specifically relating to motion pictures should be based on standards developed by the motion picture expert groups;

10 that the LSDI studies should be completed by the year 2005.

Category: S1

---

<sup>7</sup> Such as frame rates, colorimetry, resolution, and aspect ratios.

<sup>8</sup> The term "motion pictures" (also called movies, features, etc.), is used to indicate content that, which is intended for first release in a cinema theatre setting.

<sup>9</sup> Such as production, post-production, distribution, exhibition, trailers, etc.

## **Annex 1 to Appendix 1**

### **Some bodies within and outside the ITU that could provide co-operation on LSDI studies**

The list below provides an indication of some entities within and outside the ITU that possess an expertise relevant to LSDI and could co-operate to LSDI studies within Radiocommunication SG 6.

#### **ITU bodies**

ITU-R Working Party 6A

ITU-R Working Party 6E

ITU-R Working Party 6M

ITU-R Working Party 6P

ITU-R Working Party 6Q

ITU-R Working Party 6R

ITU-R Working Party 6S

ITU-T Study Group 9

ITU-T Study Group 16

#### **Some other international or regional standardizing bodies and fora**

ARIB – Association of Radio Industries and Businesses

ATSC – Advanced Television Systems Committee

DVB – Digital Video Broadcasting

EDCF – European Digital Cinema Forum

IEC – International Electrotechnical Commission

ISO – International Standards Organisation

ISO/IEC JTC1/SC29/WG11 (MPEG) – Moving Picture Experts Group

SMPTE – Society of Motion Picture and Television Engineers

#### **International or regional Unions and Associations of broadcasters**

WBU-TC – Technical Committee of the World Broadcasting Unions

Regional Unions and Associations of Broadcasters (ABU, ASBU, CBU, EBU, IAB, NABA, OTI, URTNA)

#### **Other bodies**

Associations of manufacturers

Associations of program distributors

Associations of theatre owners and operators (e.g., U. S. National Association of Theatre Owners (NATO), International Union of Cinemas (UNIC) and Motion Picture Theatre Owners Association of Canada (MPTAC), etc.).

## Part 1

### Large screen digital imagery technology

#### Table of Contents

	<i>Page</i>
<b>Chapter 1 – Camera technologies</b> .....	16
1 Camera systems currently commercialized.....	16
1.1 Cinealta.....	16
1.2 VariCam.....	16
1.3 Viper.....	16
2 Camera systems within the foreseeable range or under development.....	16
2.1 1920 × 1 080/60p camera.....	16
2.2 1 920 × 1 080/300p camera.....	17
2.3 4k × 2k camera.....	17
2.4 8k × 4k camera (CCD).....	18
2.5 8k × 4k camera (CMOS).....	20
2.6 ARRI D-20.....	20
2.7 DALSA Origin.....	22
2.8 Lockheed Martin 12M-pixel camera.....	22
2.9 Panavision Genesis.....	22
3 H.264/AVC.....	22
4 Coding technologies for an expanded hierarchy of LSDI.....	23
4.1 Super high definition technology.....	23
References.....	23
<b>Chapter 2 – Recording technologies</b> .....	24
<b>Chapter 3 – Display technologies</b> .....	25
1 Large screen projection technologies.....	25
1.1 Introduction.....	25
1.2 Environment.....	25
1.3 Image capture and display.....	25
1.4 Deployed projection technologies.....	26
1.5 Technology in development.....	28
1.6 Projector efficiency.....	29
1.7 Summary.....	31

2	2k × 1k display .....	32
2.1	2k × 1k DMD projectors .....	32
2.2	JVC 2k × 1k projector .....	32
2.3	Sony 2k × 1k projector .....	32
2.4	Epson 2k × 1k device .....	32
3	4k × 2k display .....	33
3.1	JVC, CRL and NTT projectors .....	33
3.2	Sony 4k × 2k projector .....	33
4	NHK 8k × 4k display system .....	33
4.1	Projector .....	33
4.2	Equipment layout .....	34
4.3	Convergence-adjustment device .....	35
<b>Chapter 4 – Distribution technology .....</b>		<b>37</b>
1	Introduction .....	37
2	Ethernet technologies .....	37
2.1	1-Gigabit Ethernet .....	37
2.2	10-Gigabit Ethernet .....	37
3	Satellite transmission technologies .....	38
3.1	Broadcasting satellite system in 12 GHz band .....	38
3.2	Broadcasting satellite system in 21 GHz band .....	38
4	Transporting technologies over wired network .....	40
4.1	Prototype distribution system by NTT .....	40
4.2	International real-time streaming of 4k format video .....	41
4.3	Real-time IP streaming of an uncompressed 4k format video .....	41
4.4	Uncompressed live transmission of 8k format video .....	43
References .....		43
<b>Chapter 5 – Coding technologies .....</b>		<b>44</b>
1	Introduction .....	44
2	Motion JPEG-2000 .....	44
3	H.264/AVC .....	45

4	Coding technologies for an expanded hierarchy of LSDI .....	45
4.1	Super high definition technology .....	45
4.2	The real-time JPEG2000 decoder .....	47
4.3	MPEG-2 CODECs system .....	48
4.4	MPEG-2 CODEC for 8k format LSDI .....	50
	References .....	51
	<b>Chapter 6 – Multichannel sound technologies</b> .....	52
1	Introduction .....	52
2	Multichannel sound systems presently in use .....	53
2.1	5.1 (0/5/0.1) .....	53
2.2	6.1 (0/6/0.1) .....	53
2.3	6.1 (0/5/1.1) .....	54
2.4	7.1 (0/7/0.1) .....	54
2.5	7.1 (0/7/0.1) .....	54
3	Multichannel sound systems under development .....	54
3.1	6.0 (0/2/4) .....	54
3.2	10.2 (0/8/2.2) .....	54
3.3	22.2 (3/10/9.2) .....	54
3.4	Wave field synthesis .....	55
	<b>Chapter 7 – Cinema theatres for motion picture</b> .....	56
1	Introduction .....	56
2	Cinema theatre recommended parameters .....	56
2.1	Current standards .....	56
2.1.1	The AFNOR NF S 27001 .....	56
2.1.2	29 June 1989 Protocol .....	56
2.1.3	Recommended parameters .....	58
2.2	Screen size .....	59
2.2.1	Image size lower bound .....	59
2.2.2	Image size upper bound .....	59
2.3	Screen types .....	59
2.3.1	Flat screen .....	59
2.3.2	Curved screen .....	59
2.4	Screen parameters .....	60
2.4.1	Screen curvature .....	60



*Page*

2.5	Room parameters .....	61
2.5.1	Distance to screen .....	61
2.5.1.1	Minimum distance .....	61
2.5.1.2	Maximum distance .....	61
2.5.2	Head tilt angles.....	61
2.5.3	Row spacing.....	62
2.5.4	Side vision angle .....	62
2.5.5	Seat back plane orientation .....	63
2.5.6	Head clearance .....	64
2.5.7	Seat upper limit plane .....	65
2.5.8	Projection distance .....	65
2.5.9	Image geometric distortion .....	66
2.5.10	Clearance under projection beam.....	67
2.5.11	Room outfit .....	68
2.5.11.1	Image .....	68
2.5.11.2	Sound.....	68
<b>Chapter 8 – Applications of the expanded hierarchy of LSDI systems .....</b>		<b>69</b>
1	Available technologies for the expanded hierarchy of LSDI systems.....	70
<b>Annex 1 to Chapter 8 – Exhibition of LSDI comprising expanded format video and 22.2 multichannel audio at the 2005 World Exposition, Aichi, Japan .....</b>		<b>71</b>

## Chapter 1

### Camera technologies

#### 1 Camera systems currently commercialized

Some high-resolution camera systems have already been commercialized and used widely in the world especially for digital cinema. They all employ CCDs.

##### 1.1 Cinealta

Cinealta is a generic name of a SONY HDTV 24p (24 frames per second (fps)) production system. HDW-F900 is the first camera enabling the capture and recording of digital high-definition pictures at 24 progressive fps just like a conventional film camera. 3 chips (FIT CCDs 2/3 inch equivalent) are employed and moving pictures are digitally imaged in accordance with the CIF (Common Image Format) standard, which specifies a sampling structure of 1 920 active pixels horizontally by 1 080 active pixels vertically. Moreover, it can be switched to record at 25p and 30p progressive scan, at either 50 or 60 Hz interlaced. The maximum recording time is about 50 min with HDCAM recording format.

##### 1.2 VariCam

The AJ-HDC27 VariCam is a progressive scan high-definition camcorder manufactured by Panasonic. This is the first high-definition production camera capable of variable frame rate. Individual frame rates may be selected from 4 fps to 60 fps in single frame steps. The camera employs the Matsushita 1 280 × 720 IT CCDs and horizontal resolution is about 700 TV lines. The camera has the capability to emulate film's gradual transfer function performance (i.e. cinema gamma) increasing the camera's usable dynamic range. The maximum recording time is about 46 min with DVCPRO HD recording format.

##### 1.3 Viper

Viper FilmStream™ Camera manufactured by THOMSON has three 9.2 million pixels (1 920 × 4 320) Frame Transfer CCDs and delivers an RGB 4:4:4 10-bit log output not affected by electronic camera signal processing. Namely, this camera captures raw data directly from CCDs without video-style signal processing. By grouping the 4 320 vertical sub-pixels on the CCDs to map to the desired line rate, popular video formats (native 16:9 or 2.37:1 aspect ratios) can be acquired maintaining full vertical resolution without compromising image quality. Signal formats are 1 080p at 23.98, 24, 25, and 29.97 fps, 1 080i at 50 and 59.94 Hz, 720p at 23.98, 24, 25, 29.97, 50, and 59.94 fps.

#### 2 Camera systems within the foreseeable range or under development

A hierarchy of spatial resolutions in extremely high-resolution imagery is shown in Recommendation ITU-R BT.1201. The hierarchy is based on well-accepted 16:9 aspect ratio and consists of simple multiples of 1920 × 1 080 pixels in horizontal and vertical directions.

##### 2.1 1920 × 1 080/60p camera

A 1 920 × 1 080/60p (60 fps with progressive scanning) camera with three CCD devices for each RGB colour has been developed as an experimental progressive scan HDTV camera

[Shimamoto, H. *et al.*, January 2001] in NHK of Japan in 2003. The CCD has a frame-interline-transfer (FIT) structure for interlaced-scanning. However, the camera drives it in a progressive mode by means of FIT interline transfer (IT) driving method. The horizontal and vertical resolutions of this camera are about 1 000 TV-lines each, and the vertical modulation transfer function (MTF) response is about 57% on 700TVL and 30% on 1000TVL.

## 2.2 1 920 × 1 080/300p camera

NHK is developing a new high-speed (high-frame rate) HDTV camera system. It can shoot 300 fps by using three built in 2.2M-pixels CMOS image sensors and 24G-byte memories. It can replay good quality pictures due to its progressive scanning (1 920 × 1 080) and absence of compression (RGB = 4:4:4). The specifications of the camera are shown in Table 1.

TABLE 1  
Specifications of a 1 920 × 1 080/300p camera

Number of effective pixels	1 920 (H) × 1 080 (V)
Total pixels	2.2M
Pixel pitch (microns)	7 × 7
Image sensor	CMOS
Aspect ratio	16:9
Maximum frame rates (fps)	300
Number of recording frames	3 000
Memories	DRAM
Recording time	10 s (at 300 fps.)
Image size (mm)	13.44 (H) × 7.56 (V)
Horizontal resolution	1 000 TV lines
Sensitivity	2 000lx, <i>f</i> /5.6 (at 60 fps.)
Signal-to-noise ratio (dB)	54
Scanning format	Progressive
Signal output	Dual link (SMPTE 372M)
Colour separation prism	1 inch format
Taking lens	2/3 inch format B4 bayonet mount HDTV lenses
Optical adapter	From 2/3 to 1 inch converter
Camera dimensions (mm)	300 × 200 × 150 (camera head) 420 × 132 × 460 (camera control unit)
Power consumption (W)	250
Weight (kg)	10 (camera head), 25 (CCU)

## 2.3 4k × 2k camera

Olympus Optical Co., Ltd. has developed an experimental 4k × 2k camera in May 2002. The HDTV camera employed four 2/3 inch FIT CCDs (R, G1, G2, B) with a 30 fps progressive scanning. In order to achieve 4k × 2k resolution, the two green panels were arranged by the diagonal-pixel-offset method.

CRL (Communications Research Laboratory) and JVC (Victor Company of Japan) have jointly developed a camera system with 2 000 scanning lines called Quadruple HDTV. The camera system employs three CMOS sensors of  $3\,888 \times 2\,192$  pixels (2 inch equivalent) and outputs the video signals in four HDTV signal channels. The camera scanning is at 30p (30 fps with progressive scanning) or 60i (60 fps with interlaced scanning). The sensitivity of the camera was slightly worse than that of a normal HDTV camera.

NHK has developed an experimental  $4k \times 2k$  colour camera operating in a 2 250-line, 60-frame progressive system [Mitani, K. *et al.*, February/March 2002]. Its main features are listed in Table 2. It is equipped with 8 million pixels CCD sensors (2.5 inch equivalent). Since the CCD has four times as many pixels as the 1 080p system, a very high-clock frequency of approximately 600 MHz would be required. To overcome such a difficulty, the image area of the CCD is divided into 16 sub-areas, each of which is independently scanned at the relatively low-clock frequency of 37.125 MHz. The signals from each sub-area are then combined to result in the full picture [Smith, C. *et al.*, June 1999].

TABLE 2

**Main features of a  $4k \times 2k$  camera developed by NHK**

Parameter	Value
Total number of lines	2 250
Picture rate (fps)	60
Scanning	Progressive
Sample per active line	3 840
Active lines per picture	2 160 <sup>(1)</sup>
Aspect ratio	16:9
Pixel size	8.4 micrometer, square pixel
Imaging system	RGB with 3-CCD

<sup>(1)</sup> The experimentally developed sensor has 2 048 active lines per picture.

**2.4  $8k \times 4k$  camera (CCD)**

In 2002, NHK realized a 4 000 scanning line image system [Mitani, K. *et al.*, January 2003], i.e. with a number of scanning lines four times higher than that of present HDTV systems. Table 3 shows the 4 000-scanning line image system signal formats. A 4 000-scanning line camera system with a 16:9 aspect ratio would need an imaging device with a capability of about 32 million pixels at 60 fps, which is not yet within current technological feasibility. Therefore, the image is processed by dividing it into signals of the size of an HDTV signal, and the current HDTV signal processing circuit and peripherals are applied. The 4 000 scanning line imaging system uses four 8 million pixel CCDs (2.5 inch equivalent) for acquisition of the motion images. As shown in Fig. 1, the optical image passing through a lens is divided by a colour separation prism into three different spectra: two green (G1, G2), red (R), blue (B). Each forms an image on its own 8 million pixel CCD. The four CCDs are located in the prism with a half pixel offset, see Fig. 2. The result is a resolution equivalent to that of a 4 000-scanning line signal CCD colour camera that shoots in colour by using 32 million pixels (8 million pixels  $\times$  4). The external appearance of the prototype camera head is shown in Fig. 3. The camera head weighs 76 kg, and it consumes approximately 600 W. It has a resolution limit of 2 700 TV lines or higher.

TABLE 3  
Signal format of a 4 000 scanning lines image system

Parameter	Value
Picture rate (fps)	60
Scanning	Progressive
Sample per active line	7 680
Active lines per picture	4 320 (4 096) <sup>(1)</sup>
Aspect ratio	16:9

<sup>(1)</sup> The number is currently 4 096 due to a restriction on the effective number of lines for an imaging device.

FIGURE 1  
Configuration of colour-separation optical system

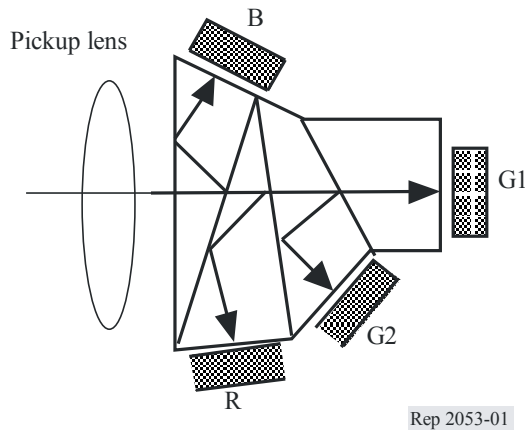

FIGURE 2  
Relative positioning of pixels  
(Sampling position)

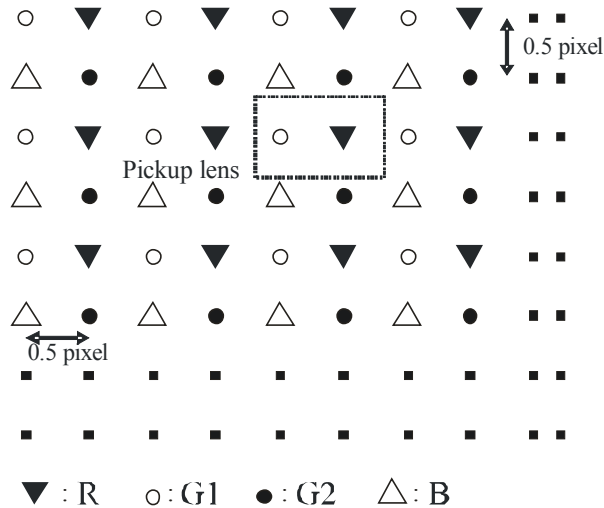

FIGURE 3  
External view of experimental camera



Rep 2053-03

## 2.5 8k × 4k camera (CMOS)

NHK has developed a new 8 megapixels CMOS sensor for a 1.25-inch optical format [Yamashita, T. *et al.*] in the framework of camera head miniaturization associated to the development of a zoom lens. A pixel number of 3 840 (horizontal) × 2 160 (vertical), i.e. twice (in both directions) that of HDTV images was chosen.

Figure 4 shows a block diagram of this sensor architecture. The sampled pixel values from the pairs of columns are transmitted to conventional 10-bit analogue-to-digital converters (ADCs) in each parallel column. Then the pixel values are stored in SRAM banks. Digital data are read out from this SRAM bank by 16 parallel ports.

Optical black pixels are positioned around the periphery of the active area. The optical black pixels on the top and bottom of the sensor are used to compensate the difference between the offset levels of each of the columns, while those on the right and the left of the sensor are used to compensate the difference between the offset levels of each line.

Table 4 shows a comparison between the specification of the CCD sensor on the first model of the 4k-scanning-line camera and that of this CMOS sensor. The pixel size of the CMOS sensor is  $4.2 \times 4.2 \mu\text{m}^2$ , which is smaller than that of the CCD sensor. However, due improved photoelectric transfer characteristics, the sensitivities of these sensors are nearly the same. About 2 000 ADCs are built in, and 16 pixels can be output from the sensor in parallel as a digital signal during one clock period. The reasons for using a CMOS sensor are its low power consumption and the feasibility of column parallel output structure. A wide bandwidth sensor, as used in ultra-high-definition systems, should have a multiple-output structure. Since the CMOS sensor can output arbitrary pixels, it is hard to see the difference in gain or offset. On the other hand, the CCD sensor is better suited for the area-divided output. In this case, it is easy to see the difference in output for each region.

## 2.6 ARRI D-20

The Munich-based company ARRI has developed the D-20 digital cinematography camera for demonstration purposes<sup>10</sup>. It is based on a single 6 million pixels CMOS sensor featuring an image area comparable to that of a 35 mm full aperture negative. The sensor has  $2\,880 \times 2\,160$  pixels with

<sup>10</sup> [http://www.arri.com/prod/cam/d\\_20/](http://www.arri.com/prod/cam/d_20/).

a Bayer colour filter array. Up to three HD-SDI links provide three alternative output formats including 1 920 × 1 080.

FIGURE 4  
External view of experimental camera

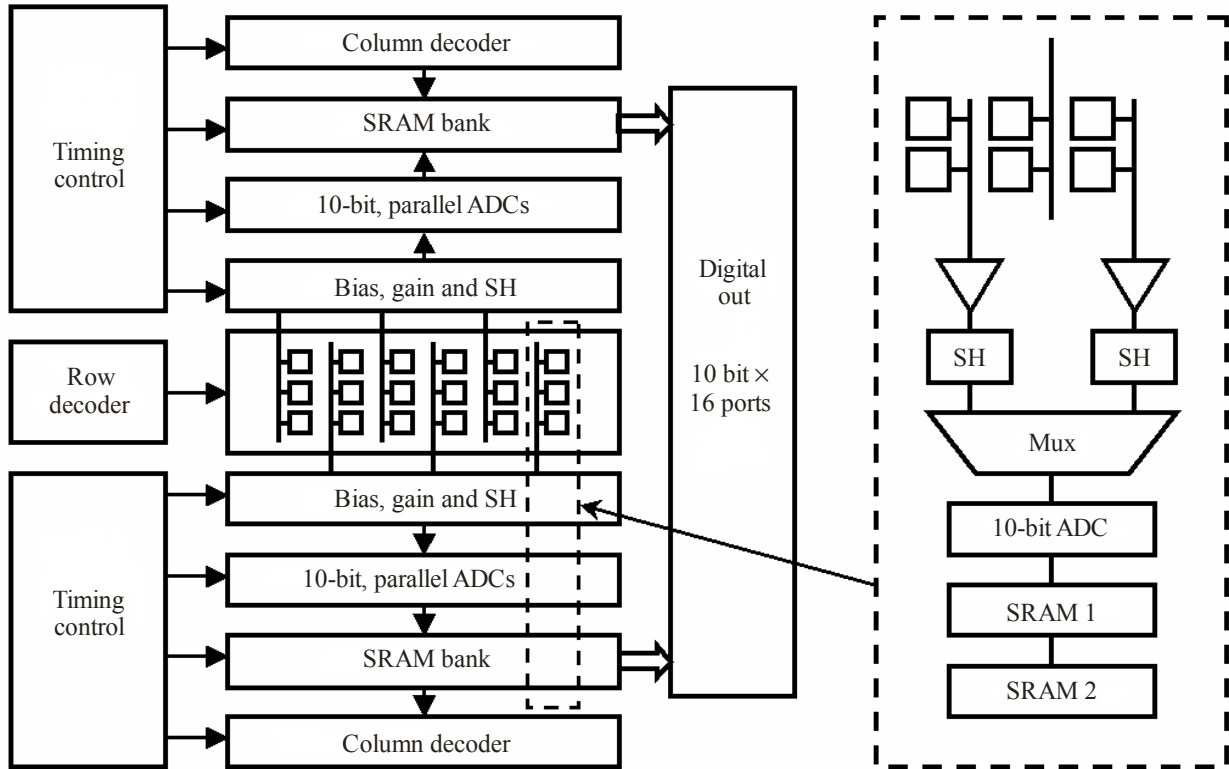

Rep 2053-04

TABLE 4  
Specifications of the 8M-pixel CCD sensor and the CMOS sensor

	CCD sensor on the first model of 4k-line camera	CMOS sensor on the new 4k-line camera
Pixel number (H) × (V)	Effective: 3 840 × 2 048 Total: 4 046 × 2 048	Effective: 3 840 × 2 160 Total: 3 936 × 2 196
Pixel size (µm <sup>2</sup> )	8.4 × 8.4	4.2 × 4.2
Output tap	16	16
Frame rate (fps)	60	←
Scanning method	Progressive scanning	←
Output method	Region parallel	Column parallel
	Analogue output	10-bit digital output
Frequency (MHz)	37.125	49.5
Pixel aperture (%)	89	83 with micro-lens

## 2.7 DALSA Origin

Dalsa Corporation, Waterloo, Ontario, Canada has announced their Origin digital cinematography camera with an 8M-pixel frame-transfer type CCD with a Bayer colour filter array<sup>11</sup>. Its pixel structure is  $4\,046 \times 2\,048$  and its image area is comparable to that of a 35 mm negative. Raw data are recorded with a RAID hard disk recorder at the speed of 400 Mbit/s. Post-processing including de-mosaicing of colour filter is performed on a workstation.

## 2.8 Lockheed Martin 12M-pixel camera

Lockheed Martin Corporation developed a digital cinematography camera with 12M-pixel CCDs [Hill, W.A. *et al.*, 2003]. The image area is  $47.9\text{ mm} \times 62.7\text{ mm}$ . A custom lens was developed to cope with a colour separation prism and large image size. Uncompressed output signals are recorded on a hard disk array in  $4\,096 \times 3\,112$  pixels, 24p format.

## 2.9 Panavision Genesis

Panavision Inc. announced the debut of a portable digital imaging camera containing a Super 35 mm sized 12.4-mega-pixel CCD sensor<sup>12</sup>. It has a frame rate of up to 50 fps and dual link 4:4:4 outputs. It docks to a Sony SRW-1 VTR.

## 3 H.264/AVC

H.264/AVC aims to double the coding efficiency with the same quality in comparison to previous video coding standards, such as MPEG-2, for a broad variety of applications. It can be used for conventional services such as broadcast, storage on optical and magnetic devices, conversational services, multimedia streaming services over a broad variety of network types such as cable, satellite, cable modem, digital subscriber line, Ethernet, LAN, and wireless and mobile networks.

H.264 provides a 50% bit rate saving and blocks noise reduction for equivalent perceptual quality. Some important differences in relation to previous standards are:

- Enhanced frame-prediction capability. The use of seven different macro-block sizes and shapes, results into bit-rate savings with respect to using only a  $16 \times 16$  block size in inter-frame prediction. The picture used for prediction was previously restricted only to the most recently referred picture and could not be used as a reference for predicting other pictures in the video sequence. By removing this restriction, H.264 standard can provide the encoder with more flexibility. Intra-frame prediction is introduced by this standard, which supports  $4 \times 4$  and  $16 \times 16$  block modes.
- Exact-match inverse transformation. In previous video coding standards, the transformation used for representing the video was generally specified only within an error tolerance bound, due to the impracticality of obtaining an exact match with the ideal specified inverse transformation. As a result, each decoder design would produce a slightly different decoded video, causing a drift between the encoded and decoded representations of the video thus effectively reducing the video quality.
- Adaptive in-loop deblocking filter. Block-based video coding produces artefacts known as blocking artefacts. These can originate from both the prediction and residual difference coding stages of the decoding process. The use of an adaptive deblocking filter can improve video quality.

---

<sup>11</sup> <http://www.dalsa.com/>.

<sup>12</sup> <http://www.panavision.com/publish/2004/08/31/genesisrelease.pdf>.



- Enhanced entropy coding methods. The two entropy coding methods applied in H.264, called context-adaptive variable-length coding (CAVLC) [Shimamoto, H. *et al.*, January 2001] and context-adaptive binary arithmetic coding (CABAC) [Mitani, K. *et al.*, February/March 2002], both use context-based adaptivity to improve compression performance when compared to previous standard designs.

For EHRI-3 (7 680 × 4 320) whose spatial image resolution is equivalent to 7 680 × 4 320 LSDI system, the coding performance that can be achieved by employing H.264 / MPEG-4 AVC high profile coding functions may be evaluated from the experimental results shown in § 3.5.3 of Report ITU-R BT.2042-3<sup>13</sup>.

## 4 Coding technologies for an expanded hierarchy of LSDI

### 4.1 Super high definition technology

#### SHD image

Super high definition (SHD) images are categorized to an high-end image media that achieves the excellent digital image quality needed to satisfy professional users in various industries, e.g. printing, medicine and image archives such as electronic art galleries and museums. The SHD images have at least 2 048 pixels resolution, 24-bit colour separation, progressive scanning mode, refresh rate of over 60 Hz to avoid perceptible flicker, and square pixel alignment. The SHD images surpass the quality of 35-mm films in terms of spatial resolution, and have approximately two to four times better image quality than that of HDTV as defined in Recommendation ITU-R BT.709.

## References

- HILL W.A. *et al.* [2003] Twelve Megapixel 24p Electro-optic Cine Camera: Part 2. *SMPTE Motion Imaging*, Vol. 112, 4, pp. 110-121.
- MITANI K. *et al.* [February/March 2002] Experimental ultrahigh-definition colour camera system with three 8M-pixel CCDs. *SMPTE J.* 111, 2.
- MITANI K. *et al.* [January 2003] Ultrahigh-definition colour video camera system with 4k-scanning lines. Proc. of SPIE, 5017, sensors and camera systems for scientific, industrial and digital photography applications 4.
- SHIMAMOTO H. *et al.* [January 2001] High-speed progressive operation of a 2M-Pixel M-FIT CCD. Proc. of SPIE 4, 306 sensors and camera systems for scientific, industrial and digital photography applications 2.
- SMITH C. *et al.* [June 1999] An 8M-CCD for an ultra-high definition TV camera. IEEE Workshop on Charge Coupled Devices and Advanced Image Sensors, Nagoya, Japan.
- YAMASHITA T. *et al.* A new alignment method for an 8K × 4k-pixel ultrahigh-definition camera with four imagers. IS&T/SPIE 16th annual Symposium on electronic imaging 2004 sensors, cameras and systems for scientific/industrial applications VI, 5301A-14.

---

<sup>13</sup> This should be replaced when the revised version of Report ITU-R BT.2042 will be established.

## Chapter 2

### Recording technologies

The data rate of  $1\,920 \times 1\,080/60$  Hz progressive format is two times higher than that of  $1\,920 \times 1\,080/60$  Hz Interlace. In order to record  $1\,920 \times 1\,080/4:2:2/10$ -bit/60 Hz progressive signals on tape it is necessary for a digital VTR to handle approximately  $1.24 \times 2$  Gbit/s of data for net video only. Compression technology is widely applied to video recording and the picture quality is well accepted. Under the current product line-up of VTRs in several manufactures there are recorders which can record 880 Mbit/s of net video rate. The combination of these technologies makes a recorder for  $1\,080/60$  Hz progressive quite feasible. One of the broadcast products manufactures in Japan has released the specifications of a VTR product which is a portable VTR of the HDCAM series of products. The VTR can record  $1\,920 \times 1\,080/4:2:2/10$ -bit/60 Hz progressive signals with a compression factor of 2.7.

## Chapter 3

### Display technologies

#### 1 Large screen projection technologies

##### 1.1 Introduction

The migration of digital technologies into the theatre has created opportunities for new content to be presented on large screens. Historically the projection of pictures onto large screens has involved film projectors, but since they cannot display, in real time, digitally represented images, LSDI will require the use of new projection technologies. Some of these technologies are currently available and others are under development. This Chapter offers a brief survey of those technologies.

The generation of LSDI content will likely conform to existing video production standards. This is particularly true for sporting events and live theatre where production equipment is based on existing programme interchange standards contained in Recommendations ITU-R BT.709 and ITU-R BT.1543.

##### 1.2 Environment

The average theatrical screen size in developed countries is approximately 9 m (30 ft) wide. The screen area for the average theatre is approximately 500 ft<sup>2</sup>. The projected light necessary to achieve 12 ftL is approximately 6 000 lumens. High brightness projectors with appropriate colorimetry tend to be less efficient than smaller consumer/office projectors. The typical large venue projector using a Xenon lamp provides an average of two to four lumens/W resulting in a 2-3 kW lamp for adequate brightness. Under these conditions, the imaging device in the projector must be capable of tolerating significant amounts of light and heat.

The viewing experience in a theatrical environment places most viewers at 1-3 picture heights. The large viewing angles make the viewer more sensitive to spatial and temporal artefacts in the image. In addition, motion artefacts are more apparent (i.e. amplified) than they would be at larger viewing distances. The construction trend in building large multiplexes with higher numbers of smaller screens increases the viewing angle for more of the viewers than in the past. These theatres are also employing stadium seating to reduce the footprint of each theatre.

##### 1.3 Image capture and display

When images are captured by either film or progressive electronic formats, the entire image is captured simultaneously. Some images are captured into interlaced formats; in these systems the image is captured by sampling half the lines during the first half of the frame time and then capturing the alternate lines during the second half of the frame time. The optimum image acquisition and display method is to capture and display an entire (full frame) image during each frame period, and to employ a frame rate high enough to smoothly handle motion within the image. Because equipment is not yet widely available that can capture and display 1 920 × 1 080 images at 50/60 fps, images are typically electronically captured at 1 280 × 720 at 50/60 fps, 1 920 × 1 080 at 24/25/30 fps or 50/60 interlaced fields/s.

When the images are projected, some processing may be required. If the projectors native pixel format differs from the image pixel format, scaling of the image is required. If the projectors native display format is to update all pixels simultaneously, and if the image is interlaced, then de-interlacing or frame rate processing will be required somewhere in the chain. There are techniques to convert between interlaced and non-interlaced image representations. These

techniques range from simple line doubling to sophisticated motion tracking systems. The most sophisticated (and purportedly highest quality) de-interlacing techniques employ significant processing and can be expensive.

#### 1.4 Deployed projection technologies

Early projectors used CRTs for low brightness applications and light valves (either oil film or later LCD-based) for high brightness applications. In all three cases, the image was drawn using an electron beam in a raster scan configuration. Figure 5 shows a functional diagram of an oil film-based system. These early projectors easily operated with an interlaced signal. The digital micro-mirror device (DMD) and the LCD have superseded all three technologies.

FIGURE 5

##### Representative diagram of an oil film projection system

(Note the electron beam writing the image onto an oil film. Tricolour devices have three optical paths for red, green and blue channels)

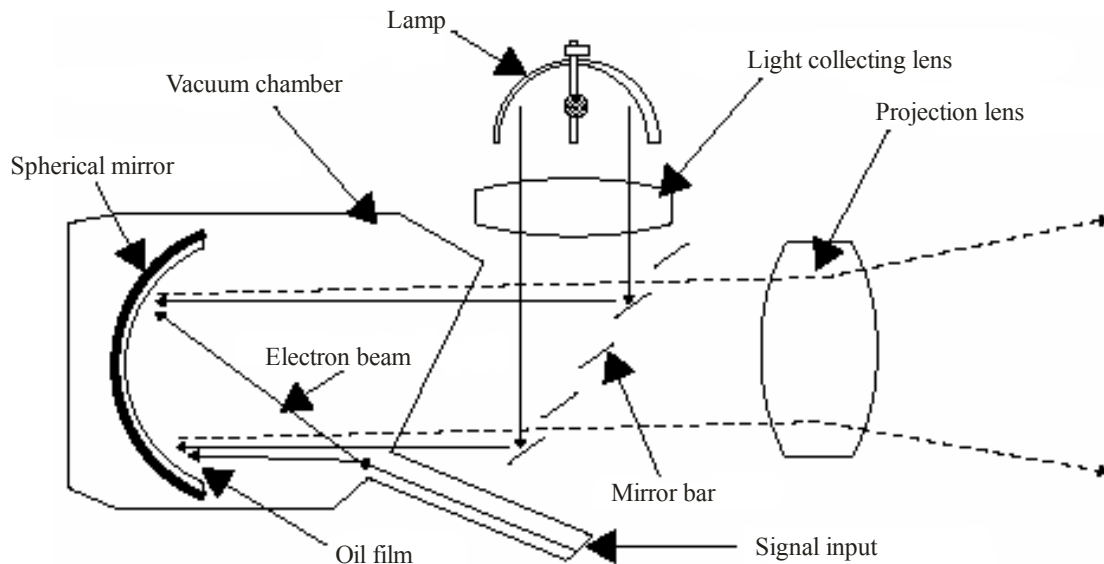

Rep 2053-05

There are currently two large screen digital projector technologies widely deployed. They are the transmissive LCD and the reflective DMD. Some projectors based on reflective LCD devices have also been deployed. All of these technologies employ planar devices with individually addressable pixels. In the large venue projectors employing these technologies, all pixels in the image are updated simultaneously.

The transmissive LCD is a digitally addressed analogue modulated technology that uses a LCD crystal to modulate the light polarization at each pixel location. Light source is either a backlit panel or a lamp. The LCD has analogue-like properties that can vary the intensity of light at each pixel based on how much the pixel's crystal is twisted. As the crystal twists, the light's polarity is changed. The intensity changes are then realized by using polarizing filters in the light path. Each LCD panel handles one colour signal; the projectors employ three panels to handle RGB colour images.

The LCD technology is found in small to medium brightness front projectors. The brightness can be as high as 6K lumens for some models. Typical large venue resolutions are SXGA (1 280 × 1 024), although a new model with 1 080 × 1 920 resolution has been announced. The projectors using transmissive LCDs update the entire image at once. These projectors can accept and display

interlaced content as they contain the appropriate processing circuitry as part of the projector electronics.

FIGURE 6

**Representative diagram of a transmissive LCD projection system**  
(Tricolour devices have three optical paths for red, green and blue channels)

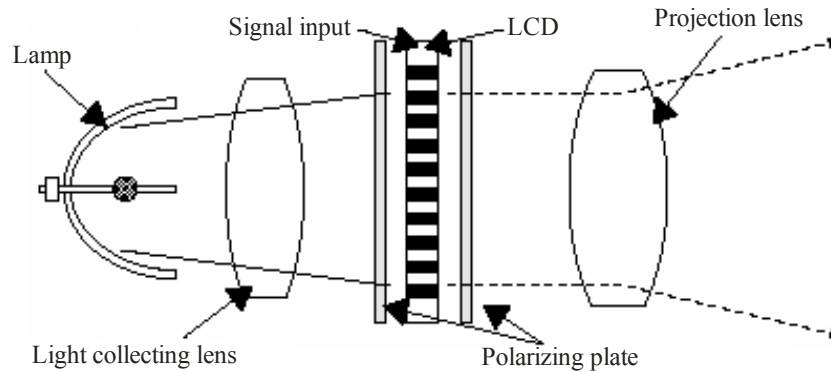

The DMD, also called digital light polarization (DLP), is a binary reflective technology that uses pulse width modulation to achieve an analogue-like representation of brightness at each pixel location. Each pixel is created by a mirror mounted on a movable post that can be toggled to reflect light either onto the screen or into a light dump. The entire image is loaded into a frame buffer and each mirror is then modulated based on the brightness value of the pixel. The fraction of time the mirror is in the on position is directly proportional to the brightness of the addressed pixel. Each device containing an array of mirrors handles one colour component. Projectors employ three devices to handle RGB colour images. The DMD is widely deployed in very high brightness front and rear-view projectors because of its high tolerance to heat and light. DLP projectors update the entire image at once and require interlaced content to be processed prior to display. Some models can accept and display interlaced content as they include appropriate processing circuitry as part of the projector electronics.

The highest quality DMD projectors, including those installed in digital cinema applications, are currently SXGA ( $1\,280 \times 1\,024$ ) resolution; projectors based on a higher resolution DMD began shipping in the 4th quarter of 2003. The new models have  $2\,048 \times 1\,080$  pixels. While LSDI pixel rates may range up to 130 megapixels/s ( $1\,920 \times 1\,280 \times 60$  fps), the DMD devices themselves can handle up to 200 Megapixels/s. The DLP cinema projector models that are on the market, and newer models that have been announced, that are intended for digital cinema applications, cannot accept and display interlaced content. The manufacturers instead supply optional add-on units that offer a de-interlacing function. These units typically convert  $1\,080 \times 1\,920$  25/30 fps signals into a progressive format that is then delivered into the projector via a digital video interface (DVI) interface. Projectors based on DMD devices are available that can handle xenon arc light sources up to 6-7 kW, and can provide light output as high as 20 k lumens.

Reflective LCD displays, commonly known as liquid crystal on silicon (LCoS) and digital image light amplifier (D-ILA), use a mirrored substrate with an LCD structure to modulate the light. The reflective LCD's tend to be less efficient than the transmissive LCD or the DMD. D-ILA and LCoS displays can be manufactured with higher pixel densities and higher fill factors than the DMD, but suffer from the same temperature and heat capacity issues as the transmissive LCD technology.

Projectors using reflective LCD devices are on the market for use on screens up to 10 m, and prototypes for larger screen venues have been shown. Resolutions for the D-ILA are as high as QXGA ( $2\,058 \times 1\,536$ ) and a demonstration of a  $3\,840 \times 2\,048$  projector has been conducted. These

projectors all update the entire image simultaneously. Current D-ILA projector models can accept and display interlaced content as they include appropriate processing circuitry within the projector.

FIGURE 7

**Representative diagram of a DMD projection system**

(Tricolour devices have three optical paths for red, green and blue channels)

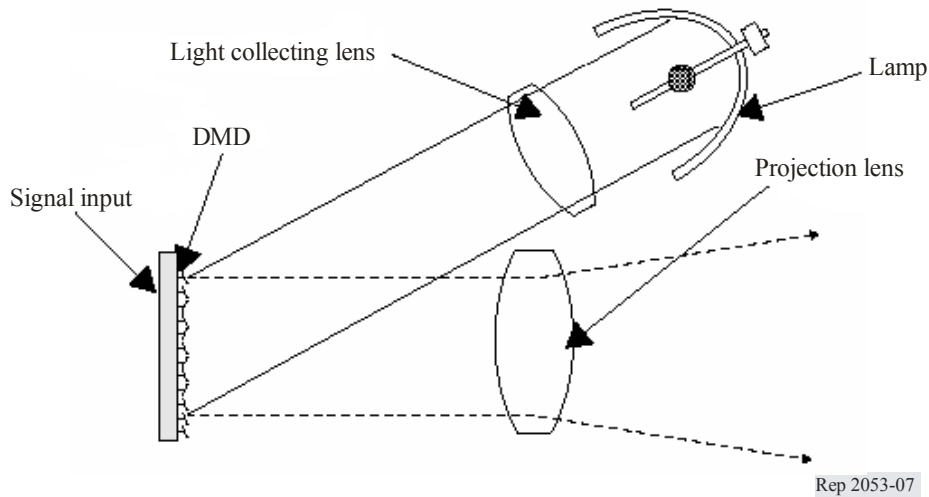
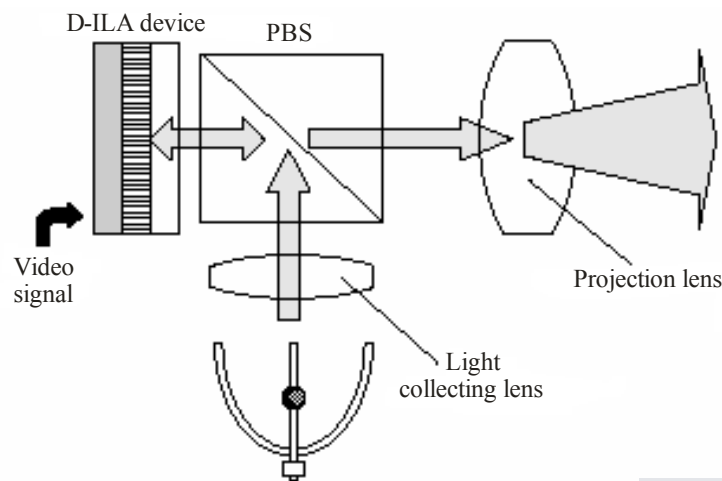

FIGURE 8

**Representative diagram of a D-ILA and LCOS projection system**

(Tricolour devices have three optical paths for RGB channels)



## 1.5 Technology in development

There are several technologies that are under development for large screen applications. The technologies can be separated into two groups: projected displays and emissive panel displays. The projected displays include the GLV, and L-CRT. The L-CRT and the GLV are both based on laser emitters. The emissive displays include OLED, AM-LCD, and carbon nanotubes.

The L-CRT is a device that is essentially a CRT, without phosphor, bonded onto a lasing crystal. The crystal emits a laser beam with intensity proportional to the intensity of the exciting electron beam. The image is formed using a raster scan across the faceplate at an extremely high scan and refresh rate. The e-beam cannot linger on the crystal due to localized heat build up. The device is limited in its power handling capabilities due to limitations in the size of the lasing crystal. Each

L-CRT operates at one colour so three devices are required to supply RGB colour images. The L-CRT can suffer from the distortions inherent in three tube CRTs.

The grating light valve (GLV) is a device that uses continuous beam lasers modulated by an electronic diffraction grating. A vertical line of pixels is displayed simultaneously and this is scanned horizontally creating a ribbon of light that sweeps across the screen. The GLV is an example of a modified raster scan device. In a commercial projector each GLV device would modulate one laser beam; three devices, each illuminated by an R, G or B laser beam, are employed to provide full colour images.

### 1.6 Projector efficiency

The various deployed technologies have different optical efficiencies based on the type of lamp, the size of the lamp, and the application. In general, the imager size should be approximately the same size as the light-emitting source. This leads to certain trade-offs with respect to the type of lamp used and the life of the lamp. Furthermore, larger imagers can handle higher amounts of light (power) due to power dissipation capabilities.

The following plots show a number of projectors grouped by technology and type of lamp. The first plot is efficiency vs. power, the second plot is efficiency vs. brightness, and the third plot is brightness vs. power.

FIGURE 9  
**Plot of the projector efficiency to the lamp power**  
 Efficiency of projection technologies

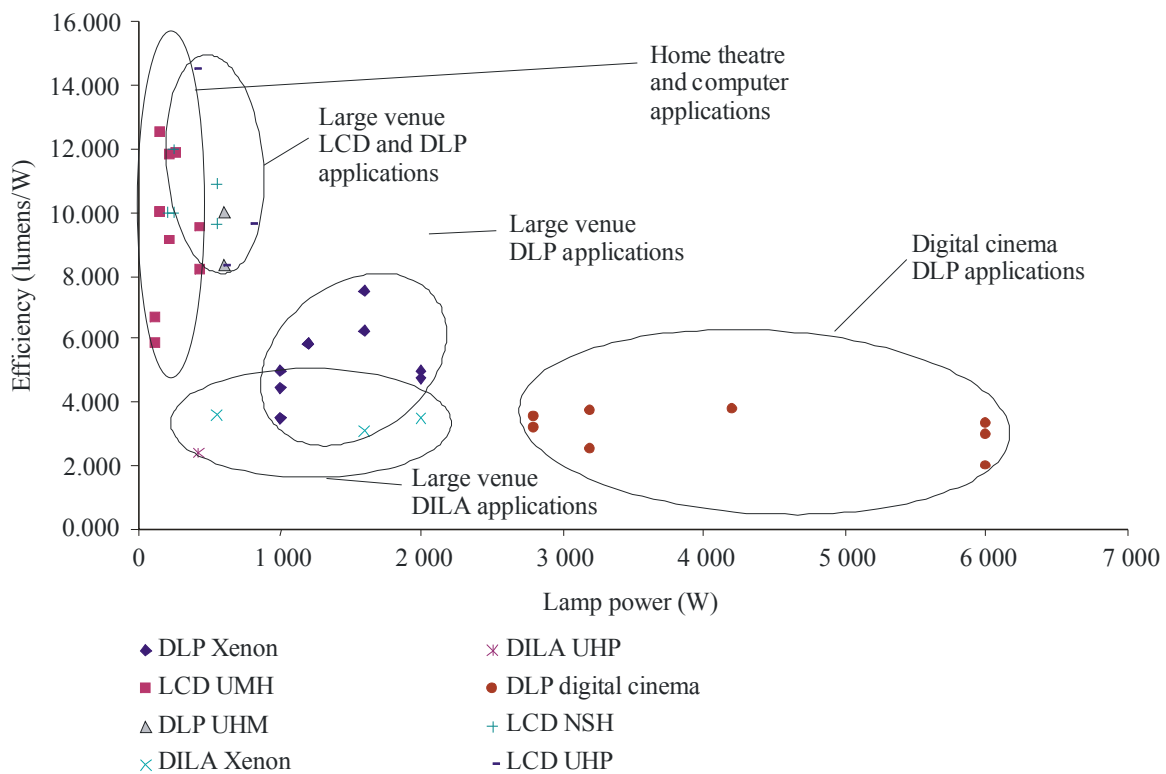

FIGURE 10  
**Plot of the projector efficiency to brightness**  
 Efficiency of projection technologies

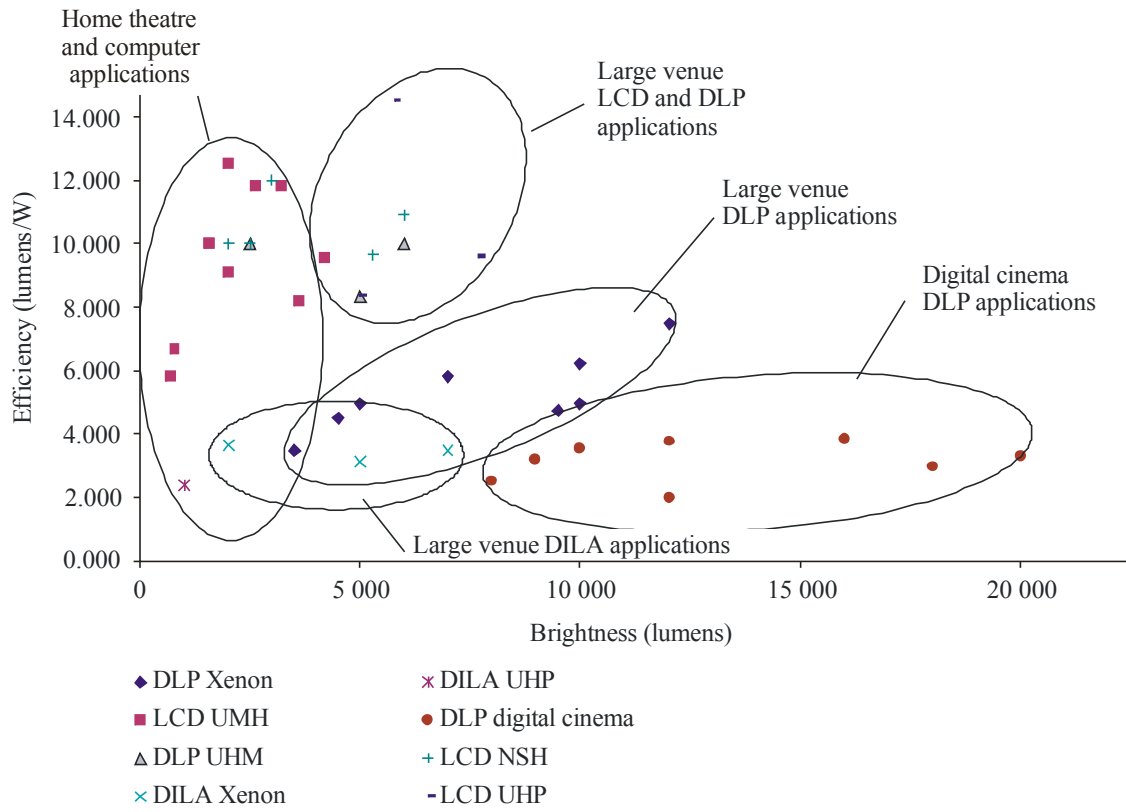
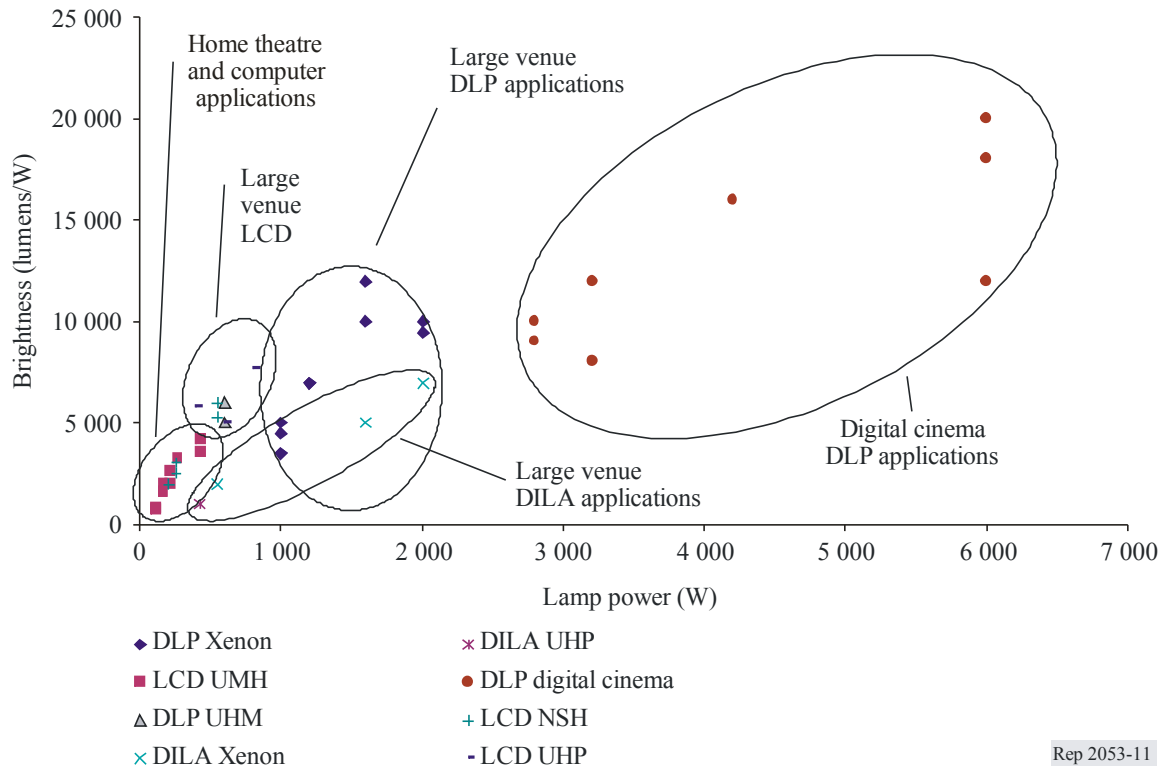



FIGURE 11  
**Plot of the projector power to brightness**  
 Efficiency of projection technologies



Rep 2053-11

Only DLP projectors are available beyond 2 kW lamp power, or with light output greater than approximately 7 500 lumens.

## 1.7 Summary

The display technologies currently deployed in the theatrical environment are planar pixel addressed topologies that, as applied in commercial projectors, update all pixels simultaneously. This is a good match to current progressive image capture devices that capture all pixels in the image simultaneously. Future projectors based on devices in development are also planar, with the exception of the GLV that has a line refresh device. All devices use a frame buffer to store the pixels prior to display.

Due to the nature of the commercially available projectors, any interlace content destined for large screen display will require processing prior to actual display. Because of the large screen display, and likelihood of close viewing distances (1-3 picture heights), all image processing should be performed with the highest quality possible. Compared to performing all processing at every point of projection, where appropriate, placement of a single processing device upstream of the distribution chain could lower the overall system cost and yield optimum quality image, with the processing quality fully under the control of the programme provider. The goal for equipment providers should be to move towards support for the high resolution (1 920 × 1 080), high frame rate (50/60 fps), progressive formats, included in Recommendation ITU-R BT.709.

## 2 2k × 1k display

### 2.1 2k × 1k DMD projectors

As mentioned above, the new models of DMD projectors will soon be released from several manufactures. The projectors have a resolution of 2 048 × 1 080 pixels. As an example of the projectors, the specifications of the model of iS8-2k manufactured by NEC Viewtechnology, Ltd. is shown in Table 5.

TABLE 5  
Specifications of the iS8-2k projector

Type of projector	Integrated DLP-Cinema™ projector
Display device	2 048 × 1 080 1.25 inch 3-chip DLP device
Power consumption (KVA)	1.5
Dimensions (mm)	562 (W) × 751.5 (D) × 340 (H)
Accepted screen width	3 m-8 m by remaining 12 ft <sup>-1</sup>
Contrast ratio	Over 1 700:1
Lamp type	Compact Xenon bubble type lamp (1.25 KW maximum)
Input connector	DVI input, HDSDI input

### 2.2 JVC 2k × 1k projector

Victor Company of Japan, Ltd. (JVC) has introduced a projector with 2k × 1k pixels in the home-theatre market<sup>14</sup>. The display imaging device, called D-ILA, is an LCoS with 1 920 × 1 080 pixels on a 0.8-inch imaging area. The light output is 500 lumens.

### 2.3 Sony 2k × 1k projector

Sony has also introduced a projector with 2k × 1k pixels in the home-theatre market<sup>15</sup>. It uses three LCoS imaging devices, called SXRDs, with 1 920 × 1 080 pixels on a 0.78-inch imaging area.

### 2.4 Epson 2k × 1k device

Seiko Epson Corporation has developed a high-temperature polysilicon LCD panel for true 1 080p home theatre projectors<sup>16</sup>. The number of effective pixels is 1 920 × 1 080 on its 1.3-inch imaging area. The contrast ratio is 500:1.

<sup>14</sup> <http://www.jvc.co.jp/2004/dla-hd2k.html>.

<sup>15</sup> <http://www.sony.jp/CorporateCruise/Press/200306/03-0610B/>.

<sup>16</sup> [http://www.epson.co.jp/e/newsroom/news\\_2003\\_10\\_27.htm](http://www.epson.co.jp/e/newsroom/news_2003_10_27.htm).

### 3 4k × 2k display

#### 3.1 JVC, CRL and NTT projectors

Communications Research Laboratory (CRL) and JVC have jointly developed a display system with 2 000 scanning lines called Quadruple HDTV. The projector employs three LCD panels of 3 840 × 2 048 pixels. The light output of the projector is 5 200 lumens and the contrast ratio is more than 750:1. The resolution of this system corresponds to 2 × 2 times of 1 920 × 1 080 pixels.

Nippon Telegraph and Telephone Corporation (NTT) has also developed a digital cinema system that can store, transmit, and display images of 2 000 scanning lines, with 10-bit each for RGB components. The projector of the system is the same as that of CRL-JVC. Image sources of the system are 35 mm motion films of 24 Hz and the system operates at a frame rate of 24 Hz or 48 Hz. The projector displays the images with a frame rate of 96 Hz in order to avoid the flicker disturbance. The resolution of this system also corresponds to 2 × 2 times of 1 920 × 1 080 pixels.

#### 3.2 Sony 4k × 2k projector

Sony Corporation has developed a 4k projector for the digital cinema market<sup>17</sup>. The projector uses three liquid crystal on silicon (LCoS) imaging devices called SXRDs with 4 096 × 2 160 pixels on their 1.55-inch imaging area. Light output is 10 000 or 5 000 ANSI lumens. With SXRD technology, pixels are set at a pitch of 8.5 μm with an inter-pixel gap of 0.35 μm.

### 4 NHK 8k × 4k display system\*

#### 4.1 Projector

A front projector using four 2 048 × 3 840-pixel LCD panels (1.7 inch) achieving a resolution equivalent to 4 000 scanning lines on a 4 m × 7 m screen (320 inches diagonally) has been implemented. In this case, the relative positioning of the two LCD panels for G has a great effect on resolution characteristics, and these two panels must be accurately offset by 0.5 pixel. To this end, the optical system shown in Fig. 12 has been implemented with a structure that can provide for fine position adjustments of the two panels by using a compact stepping motor. Incidentally, the multiple polarizing beam splitters (PBS) shown in the Figure are adopted to improve contrast. The above configuration results in the use of two projector units, one for colour G and the other for colours R and B, as shown in Fig. 13. Optical output of about 5 000 lumens and screen gain of about 0.9 results in a level of screen brightness of about 50 cd/m<sup>2</sup>, the same as that in a movie theatre.

---

\* SUGAWARA, M. *et al.*, [October/November 2003] Ultrahigh-definition video system with 4 000 scanning lines. Proc. of SMPTE Motion Imaging.

<sup>17</sup> <http://news.sel.sony.com/pressrelease/4864>.

FIGURE 12  
Projector structure for G light

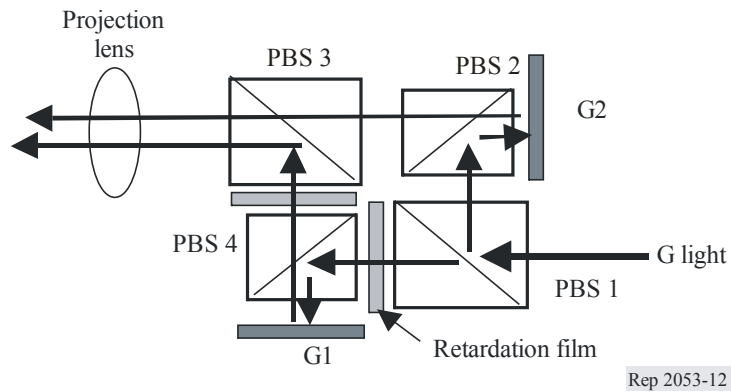

FIGURE 13  
External view of projector



Rep 2053-13

## 4.2 Equipment layout

Figure 14 shows the layout envisioned for the projector, screen, and audience seats. The used screen has a slight curve in the horizontal direction (radius of curvature: 16 m), which, in comparison with a flat screen of the same size, improves brightness shading in the peripheral areas of the screen and increasing the viewing angle. As a result, a viewing angle for the front row of seats of about  $110^\circ$  is achieved, larger than the target horizontal viewing angle of  $100^\circ$ . Sensation of reality nearly saturates at a viewing angle of about  $100^\circ$ , which means that people sitting in the front row should experience a maximum sensation of reality. The viewing angle from the back row of seats, however, is about  $60^\circ$ , but this is still twice that of HDTV. Figure 15 shows an external view of display equipment and the laboratory where experiments were held.

FIGURE 14  
Floor plan

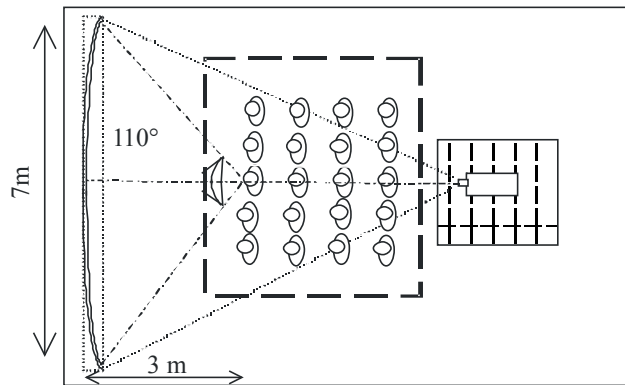

Rep 2053-14

FIGURE 15  
Display equipment and screen

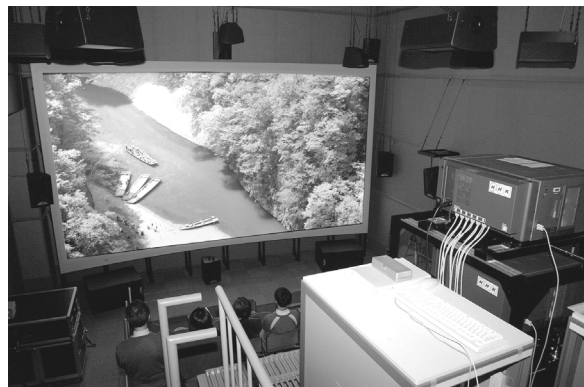

Rep 2053-15

### 4.3 Convergence-adjustment device

As described above, the projector is divided into a G unit and RB unit. These two units are vertically arranged as shown in Fig. 13, and G and RB pixels are roughly aligned on the screen by applying a lens shift to projector lenses. Nevertheless, pixel misalignment (convergence error) between G and RB will still occur on the screen due to the slight curvature of the screen and chromatic aberration in the projector lenses. To counteract this problem, a convergence-adjustment device has been developed to correct geometric distortion in R and B pictures corresponding to convergence error and thereby align G and RB positions on the screen. Figure 16 shows the configuration of this convergence-adjustment device. Here, the “correction coefficient” is obtained by interpolating convergence error across the entire screen from the error data obtained at 9’11 adjustment points on the screen. It should be noted that this convergence-adjustment device is only necessary for a projector system consisting of two units and is not inherent to an ultra-high-definition video system.

FIGURE 16  
Configuration of convergence adjustment device

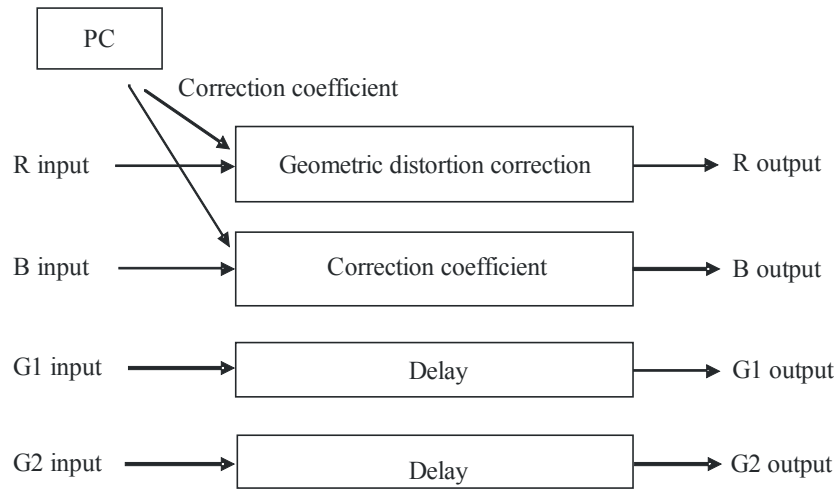

Rep 2053-16

## Chapter 4

### Distribution technology

#### 1 Introduction

LSDI can be used for a wide variety of applications and appropriate distribution technologies can be adopted. There are two main types of distribution point-to-point, and point-to-multipoint. The former is efficiently achieved over wired networks, digital subscriber lines, and optical networks. The Gigabit Ethernet is the usual technology over a fixed network. The latter is simply constructed over a wireless network. Satellite transmission is a convenient method for multicasting distribution.

#### 2 Ethernet technologies

Ethernet has evolved to meet the increasing demands of packet-switched networks. Due to its proven low implementation cost, its known reliability, and relative simplicity of installation and maintenance, its popularity has grown to the point that today nearly all traffic on the Internet uses it. Furthermore, as the demand for faster network speeds has grown, Ethernet technology has been improved to handle these higher speeds. Two types of faster Ethernets are shown below.

##### 2.1 1-Gigabit Ethernet

The 1-Gigabit Ethernet, standardized as IEEE802.3-2002, is called 1000BASE-T or 1000BASE-X, depending on physical media types. According to the International Standards Organization's Open Systems Interconnection (OSI) model, the Ethernet is fundamentally a Layer 2 protocol. The 1-Gigabit Ethernet uses the IEEE802.3 Ethernet Media Access Control (MAC) protocol, the IEEE 802.3 Ethernet frame format, and the minimum and maximum IEEE 802.3 frame size.

It has already become widely used in backbone local area networks (LANs) and has begun to move out from the realm of LANs to encompass the metro area network. Recently, a 1-Gigabit Ethernet such as 1000BASE-TX, has begun to widely spread as the LAN interface for personal computers.

##### 2.2 10-Gigabit Ethernet

The 10-Gigabit Ethernet is already standardized as IEEE802.3ae. Whilst the 1-Gigabit Ethernet still conforms to the Ethernet model, the 10-Gigabit Ethernet represents its natural evolution in speed and distance. However, it does not need the carrier-sensing, multiple-access with collision detection (CSMA/CD) protocol that defines slower, half-duplex Ethernet technologies, since only full-duplex and fibre-only technology is accepted as a priority. In any other respect, the 10-Gigabit Ethernet conforms the original Ethernet model enhancing its speed.

The architectural components of the IEEE802.3ae are shown in Fig. 17. An Ethernet physical layer device (PHY) (corresponding to Layer 1 of the OSI model) connects the media (optical or copper) to the MAC layer (which corresponds to OSI Layer 2). Ethernet architecture further divides the PHY (Layer 1) into a physical media dependent (PMD) and a physical coding sub-layer (PCS). Optical transceivers, for example, are PMDs. The PCS is made up of coding (e.g. 64b/66b) [Walker, R. *et al.*, 64b/Coding update] and serializer or multiplexing functions.

The IEEE802.3ae specification defines two PHY types, the LAN PHY and the WAN PHY. The LAN PHY can allow the speed to be ten times higher than that of the 1-Gigabit Ethernet and maintains compatibility with conventional Ethernet families. The WAN PHY has an extended

feature-set added onto the functions of a LAN PHY and is compatible with a conventional optical network/synchronous digital hierarchy network. These PHYs are solely distinguished by the PCS. Several PMD types are shown in Fig. 17.

FIGURE 17  
The architectural components of the 802.3ae standard

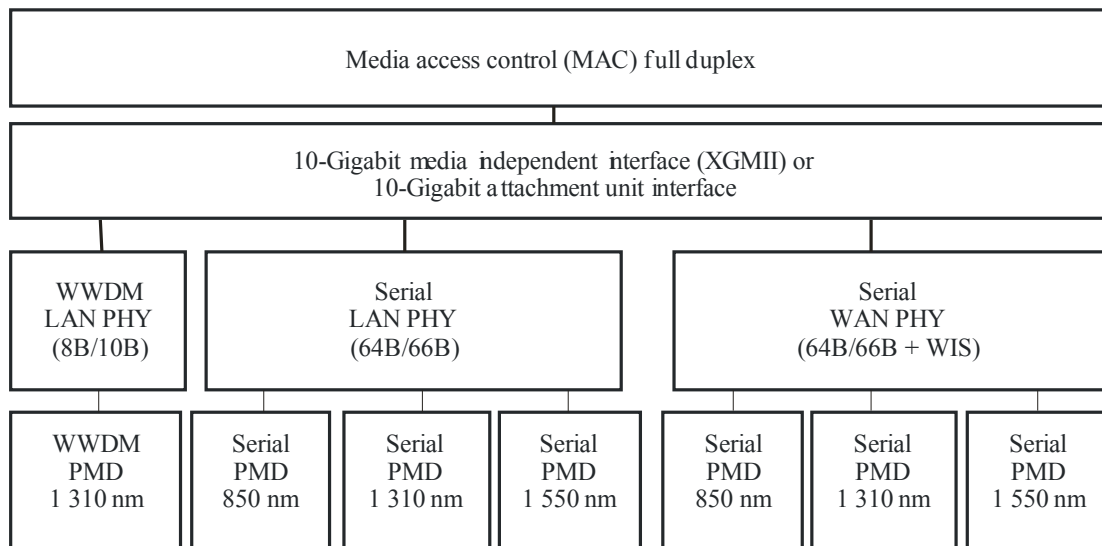

Rep 2053-17

### 3 Satellite transmission technologies

#### 3.1 Broadcasting satellite system in 12 GHz band

A transmission system for advanced multimedia services provided by integrated service digital broadcasting (ISDB) techniques in a broadcasting-satellite channel as per Recommendation ITU-R BO.1408 has been developed and can be used for various digital content distribution. Flexibility of effective services can be achieved by allowing time multiplexing of appropriate modulation schemes suitable for applications with various transmission robustness, such as 8-PSK, QPSK and BPSK. It is possible to transmit a maximum of 52 Mbit/s data rate through one satellite transponder with 8-PSK modulation in the 12 GHz band and to transmit two HDTV channels. The MPEG transport stream (MPEG-TS) is widely used as a container for digitally coded information ensuring inter-operability with other media. Multimedia integration of data/services can be achieved in the transmission system to cope with multiple MPEG-TSs and to also allow for multiple- service quality and service availability according to utilization. As usual, rain attenuation, which varies according to climatic zones, needs to be taken into account when applying this technology.

#### 3.2 Broadcasting satellite system in 21 GHz band

The next generation 21 GHz transmission systems have been investigated with the expectation to achieve a higher bit-rate transmission than presently. However, overcoming larger rain attenuation in the 21 GHz band will be necessary.



An indoor transmission experiment in the 21 GHz band was conducted [Sujikai *et al.*, 2006]. A 7 680 x 4 320 format LSDI was compressed into a 200 Mbit/s signal and transmitted successfully in the 21 GHz band in an indoor environment. The experiment was conducted over 10 h in total. Results suggested that LSDI applications can be broadcasted via satellites in the 21 GHz band. A view of the experiment is shown in Fig. 18.

FIGURE 18  
View of experiment

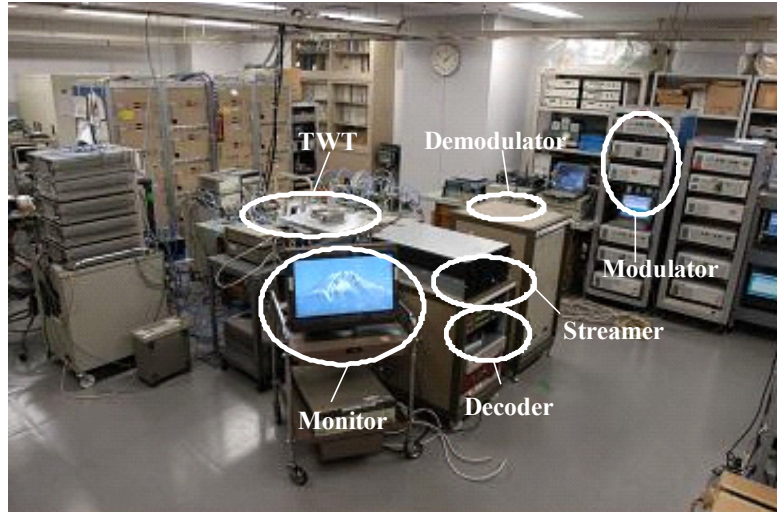

Rep 2053-18

The transmission block diagram is depicted in Fig. 19, and the parameters used in the transmission experiment are shown in Table 6. The 200 Mbit/s signal was divided into four channels. Each channel was modulated with a TC-8-PSK, and then up-converted and amplified with a TWTA in the 21 GHz band. The combined output spectrum of TWTAs is shown in Fig. 20. Measured BER performances are shown in Fig. 21 with the output back-off (OBO) level.

FIGURE 19  
Transmission block diagram

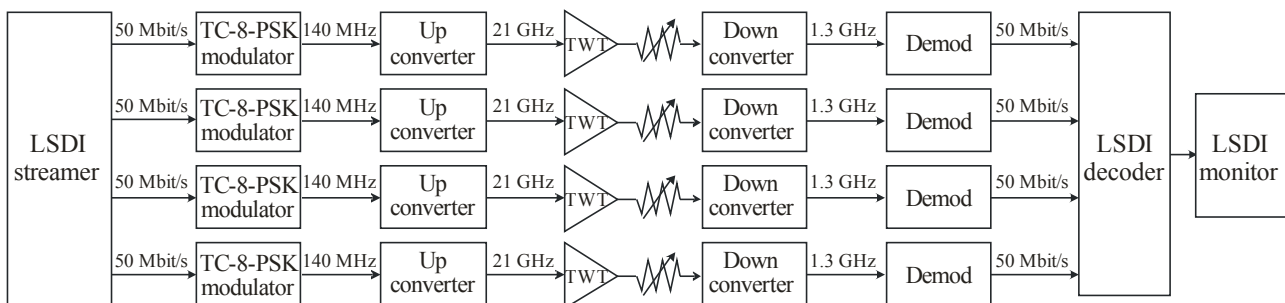

Rep 2053-19

TABLE 6  
Parameters of transmission experiment

Number of channels	4
Centre frequencies (GHz)	21.79246/21.83082/21.86918/ 21.90754
99% power bandwidth (MHz) per channel	34.5
Symbol rate per channel (MBd)	28.86
Modulation	TC-8-PSK
Outer-coding	Reed Solomon (204,188)
Inner-coding	Trellis code
Roll-off factor	0.35

FIGURE 20

Output spectrum (combined spectrum)



FIGURE 21

CNR versus BER

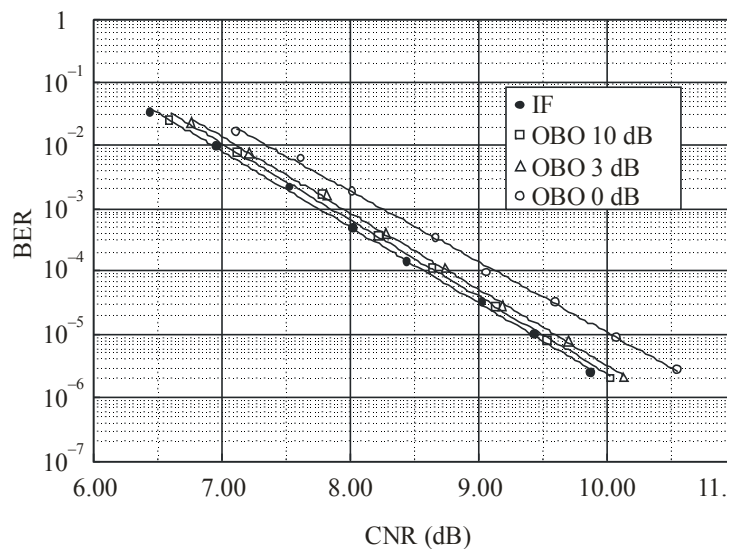

Rep 2053-202

## 4 Transporting technologies over wired network

### 4.1 Prototype distribution system by NTT

NTT has developed a prototype LSDI distribution system that can store, transmit and display eight-million-pixel motion pictures<sup>18</sup>. The system contains a video server, a real-time decoder, and a D-ILA projector. Using a gigabit Ethernet link and TCP/IP, the server transmits JPEG2000 compressed motion picture data streams to the decoder at transmission speeds higher than 300 Mbit/s. The received data streams are decompressed by the decoder, and then projected onto a screen via the projector. With this system, LSDI contents can be distributed over a wide-area IP network. LSDI transmissions were successfully performing on both academic and commercial networks.

<sup>18</sup> <http://www.ntt.co.jp/news/news02e/0211/021113.html>.

The TCP/IP protocol could be used to stream the LSDI contents. With the TCP/IP protocol, however, the network throughput temporarily falls if one or more packets end up dropped and must be retransmitted. In order to maintain continuous projection if such a network stall takes place, the decoder spools the received data stream in memory.

First LSDI distribution experiments were performed on March 2002 in Japan. Data streams were transmitted at about 250 Mbit/s by a TCP/IP single connection in Tokyo. The transmission path was 4-km long using a commercially available Gigabit Ethernet link (NTT-EAST Corp., METRO ETHER). Although the transmission was successful, the limited distance might be an issue in worldwide service areas. Considering that long-distance transmissions would be currently encountered in the U.S. case, the problem of throughput being decreased by the transmission delay (so-called Long Fat Pipe problem) will inevitably need for attention.

The fall 2002 Internet2 member meeting was held on 28 and 29 October 2002, at the University of Southern California. Internet2 is a non-profit consortium being led by over 200 universities working in partnership with industry and government to develop and deploy advanced IP network applications and technologies. During this meeting, an LSDI distribution experiment was performed linking Chicago and Los Angeles (a distance of more than 3 000 km) by using the Internet2 network. This was the world's first long-distance transmission of a LSDI data stream. The main data stream of the experiment was a CG content called "*Virtual Voyage: Milky Way to the Virgo Cluster*", created by UIUC/NCSA and encoded beforehand at several bit rate steps (~ 300 Mbit/s).

Extended experiments were performed as a demonstration of "Digital Cinema" Symposium 2003 on June 2003 at GINZA YAMAHA hall in Japan. Stream data was transmitted at about 450 Mbit/s via a commercially available Gigabit Ethernet link described above.

#### **4.2 International real-time streaming of 4k format video<sup>19</sup>**

Keio University, Nippon Telegraph and Telephone Corp. (NTT), the University of California, San Diego (UCSD), the University of Illinois at Chicago (UIC), and Pacific Interface Co. together successfully demonstrated the transmission of a 4k digital video over gigabit IP optical fiber networks in September 2005. A 4k video captured by a live camera at Keio University was encoded to a 200-400 Mbit/s stream with a JPEG2000 codec. Then it was transmitted over a 9 000-mile optical network linking San Diego with Tokyo and presented on a 4k projector at UCSD.

#### **4.3 Real-time IP streaming of an uncompressed 4k format video<sup>20</sup>**

NTT and NTT Communications successfully demonstrated the world's first transmission of uncompressed super-high-definition 4k digital video in about 6 Gbit/s IP packet stream on 18 January, during the JGN2 symposium 2006 in Sendai. The JGN2 is a national R&D testbed network to promote the R&D for a super-high-speed network and advanced applications technologies. This experimental demonstration was carried out as an example of high-end network applications.

Configuration of the demonstration is shown in Fig. 22.

---

<sup>19</sup> <http://ucsdnews.ucsd.edu/newsrel/science/iGrid4K.asp>.

<sup>20</sup> <http://www.ntt.co.jp/news/news06/0601/060119.html>.

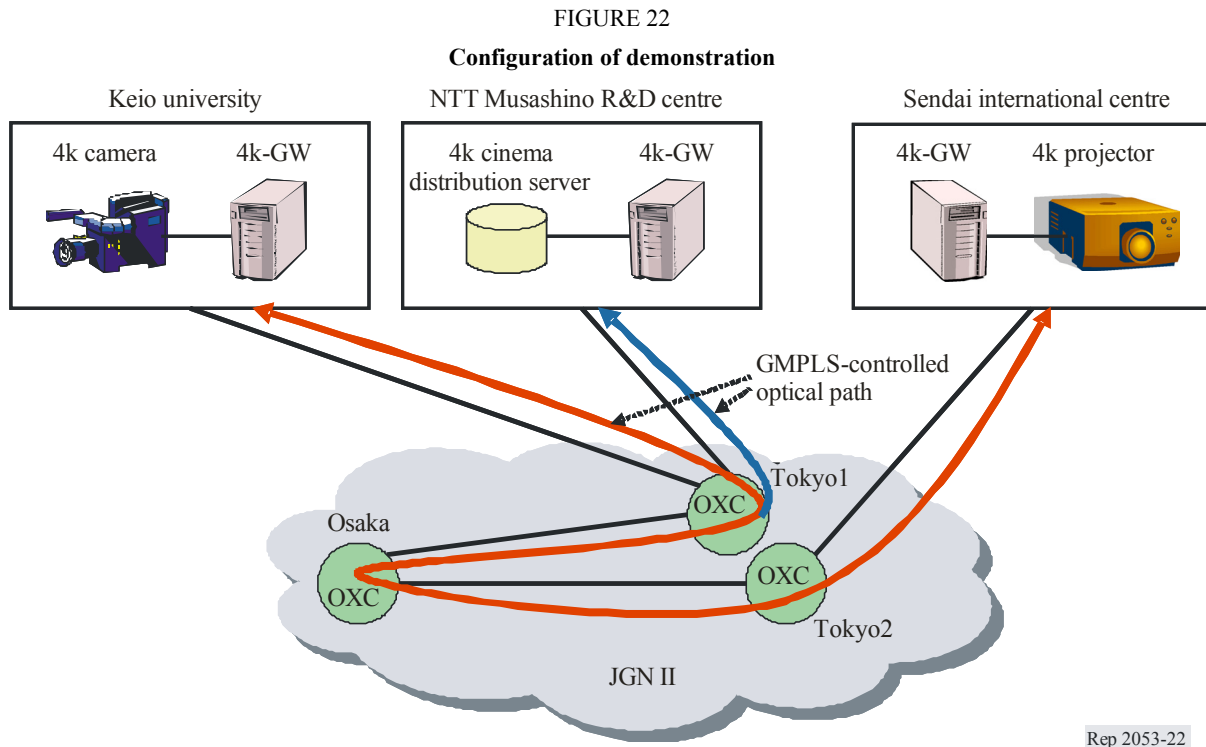

At the Research Institute for Digital Media and Content (DMC: located in Tokyo) of Keio University, a 4k live performance was captured by using a 4k digital video camera.

The captured video stream (30 frames/s) was directly packetized without compression into 6 Gbit/s IP packet stream and transmitted in real-time to the symposium place in Sendai via the JGN2. With this streaming function, low-latency super-high-definition videoconference was also demonstrated between two locations.

Next, from NTT Musashino R&D Centre (in Tokyo), IP-stream of several uncompressed 4k digital video materials was transmitted and shown on the screen of the symposium place in real-time (Fig. 23).

FIGURE 23  
4k videoconference

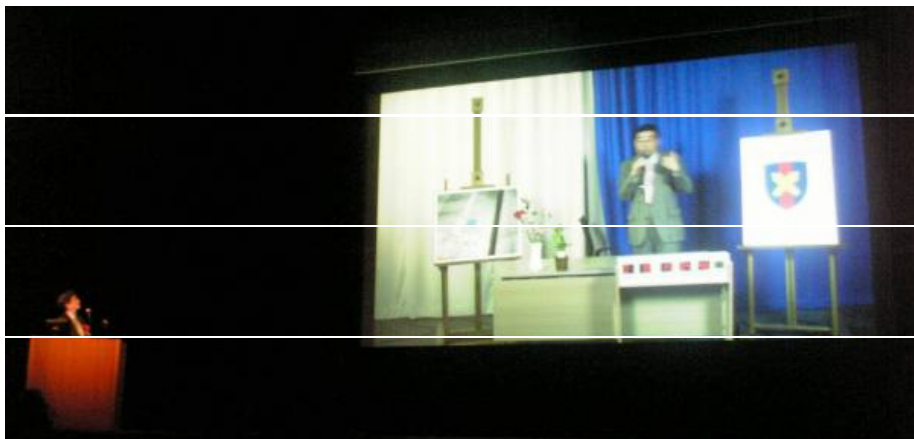

The 6Gbit/s IP-streaming of uncompressed 4k digital video was realized with the “4k Gateway” device (4k-GW) which was newly developed by NTT and NTT Communications based on the i-Visto technology<sup>21</sup>.

IP streaming of uncompressed 4k digital video was successfully demonstrated. The demonstration showed the significance of 4k live video relay, and also proved the feasibility of a future network-based 4k video production system using super-high-speed IP network.

#### 4.4 Uncompressed live transmission of 8k format video

On 2 November, 2005, NHK conducted a live relay involving fibre optic transmission of an uncompressed 7 680 x 4 320 format video signal and 22.2 multi-channel audio signals. Figure 24 shows a schematic diagram of the experiment. At Kamogawa, the shooting site, three 8k format video signals were switched and transmitted to NHK Science and Technical Research Laboratories 260 km away, the presenting venue, with multi-channel audio signals collected with more than 30 microphones.

FIGURE 24  
Schematic diagram of demonstration

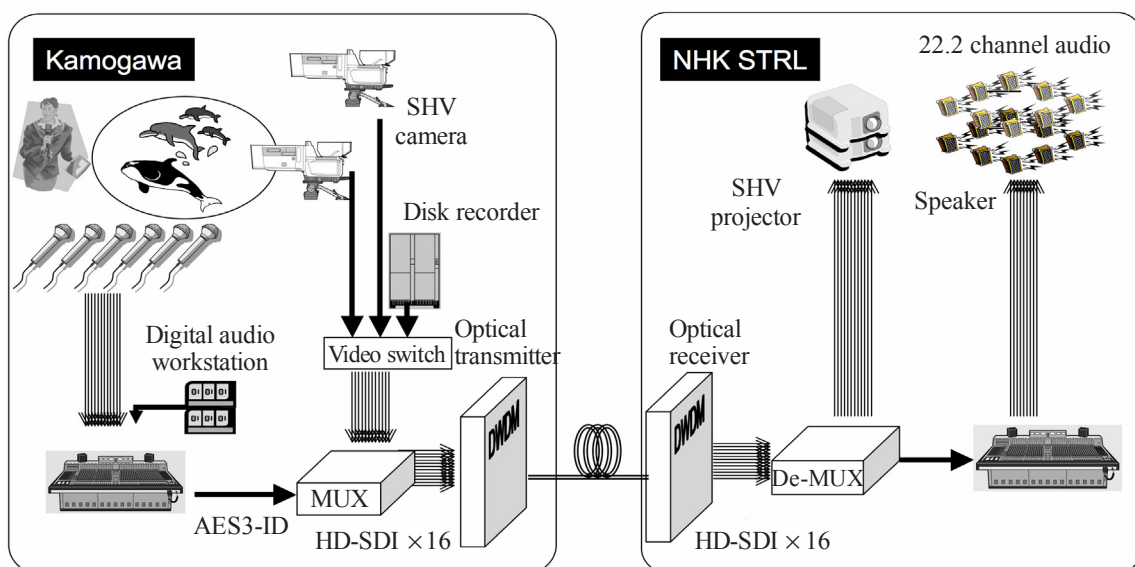

Rep 2053-24

## References

- SUJIKAI *et al.* [2006] Indoor Transmission Experiment of Super Hi-Vision in the 21 Hz Band. ITE Tech. Rep., Vol. 30, 12, p. 13-16.
- WALKER R. *et al.* 64b/66b coding update,  
[http://grouper.ieee.org/groups/802/3/10G\\_study/public/jan00/walker\\_1\\_0100.pdf](http://grouper.ieee.org/groups/802/3/10G_study/public/jan00/walker_1_0100.pdf).

<sup>21</sup> Internet video studio system for HDTV production (<http://www.i-visto.com/>).

## Chapter 5

### Coding technologies

#### 1 Introduction

There are two types of coding technology that are mainly suitable for intra-frame video compression and inter-frame video compression such as Motion JPEG-2000 and H.264/AVC, as shown in ISO/IEC15444-3 and ITU-T H.264 | ISO/IEC 14496-10 AVC, respectively. The former is used when the original image quality is required to be used for other purposes or when the application, such as live broadcasting, requires a real-time feature. The latter is used when a cost-effective image is required to satisfy the minimum service quality and higher-latency can be allowed. They can be selectively applied to LSDI applications if the conditions are met.

#### 2 Motion JPEG-2000

The JPEG-2000 standard provides numerous new features as shown in ISO/IEC15444-1. They can be used for potentially very large application areas, e.g. image archiving, Internet, web browsing, remote sensing, medical imaging, and desktop publishing. Motion JPEG-2000 features inherited from JPEG-2000 are:

- Lossless and lossy compression. This standard provides lossless and lossy compression within a single unified coding framework. For example, medical images require the highest quality for preservation, but are not necessary for display.
- Region of interest (ROI) coding. Certain ROIs of the image can be coded with better quality than the rest of the image (e.g. background). The bits associated with the ROI are placed in the bit-stream before the non-ROI parts of the image. Even if the bit-stream is truncated or the encoding process is terminated, the ROI will maintain a higher fidelity than the rest of the image. This feature allows the reconstruction of images with different resolutions and pixel accuracy.
- Scalability. Scalable coding of images means the ability to achieve more than one resolution and/or quality. Bit-stream scalability is a property of a bit-stream that allows decoding of appropriate subsets of a bit-stream to generate complete picture resolution and/or quality commensurate with the portion of the decoded bit-stream.
- Progressive recovery of an image. Random bit-stream access and processing can be used. This feature can allow access to particular regions of an image without needing to decode the entire bit-stream.
- Robustness to bit-errors. Many applications require the delivery of image data over different types of communication channels such as wireless with the possibility of random and burst bit-errors and the Internet with bit-errors for traffic congestion. To improve the performance, we introduced error syntax, data portioning and resynchronization, error detection and concealment, and transmission based on priority.
- Long bit length of sample values. The sample values of each component (e.g. RGB) are integer values with a precision from one to 38 bit/sample.

### 3 H.264/AVC

H.264/AVC aims to double the coding efficiency with the same quality in comparison to previous video coding standards, such as MPEG-2, for a broad variety of applications. It can be used for conventional services such as broadcast, storage on optical and magnetic devices, conversational services, multimedia streaming services over a broad variety of network types such as cable, satellite, cable modem, digital subscriber line, Ethernet, LAN, and wireless and mobile networks.

H.264 provides a 50% bit rate saving and blocks noise reduction for equivalent perceptual quality. Some important differences in relation to previous standards are:

- Enhanced frame-prediction capability. The use of seven different macro-block sizes and shapes, results into bit-rate savings with respect to using only a  $16 \times 16$  block size in inter-frame prediction. The picture used for prediction was previously restricted only to the most recently referred picture and could not be used as a reference for predicting other pictures in the video sequence. By removing this restriction, H.264 standard can provide the encoder with more flexibility. Intra-frame prediction is introduced by this standard, which supports  $4 \times 4$  and  $16 \times 16$  block modes.
- Exact-match inverse transformation. In previous video coding standards, the transformation used for representing the video was generally specified only within an error tolerance bound, due to the impracticality of obtaining an exact match with the ideal specified inverse transformation. As a result, each decoder design would produce a slightly different decoded video, causing a drift between the encoded and decoded representations of the video thus effectively reducing the video quality.
- Adaptive in-loop deblocking filter. Block-based video coding produces artefacts known as blocking artefacts. These can originate from both the prediction and residual difference coding stages of the decoding process. The use of an adaptive deblocking filter can improve video quality.
- Enhanced entropy coding methods. The two entropy coding methods applied in H.264, called context-adaptive variable-length coding (CAVLC) [Wiegand, Y. *et al.*, July 2003] and context-adaptive binary arithmetic coding (CABAC) [Marpe, D., Schwarz, H. and Wiegand, T., July 2003], both use context-based adaptivity to improve compression performance when compared to previous standard designs.

## 4 Coding technologies for an expanded hierarchy of LSDI

### 4.1 Super high definition technology

#### SHD image

Super high definition (SHD) images are categorized to an high-end image media that achieves the excellent digital image quality needed to satisfy professional users in various industries, e.g. printing, medicine and image archives such as electronic art galleries and museums. The SHD images have at least 2 048 pixels resolution, 24-bit colour separation, progressive scanning mode, refresh rate of over 60 Hz to avoid perceptible flicker, and square pixel alignment. The SHD images surpass the quality of 35-mm films in terms of spatial resolution, and have approximately two to four times better image quality than that of HDTV as defined in Recommendation ITU-R BT.709.

The Japanese Digital Cinema Consortium in collaboration with NTT at Siggraph 2001 provided a preview of the technology under development in 2001<sup>22</sup>.

The demonstration at Siggraph, as shown in Fig. 25, consisted of images having a pixel mapping of  $3\,840 \times 2\,048$  at 24 frames, something beyond the definition of LSDI yet a clear indication of where the technology is headed. Special devices such as, a motion JPEG decoder and a LCD projector were connected with a 4.5 Gbit/s digital video link to show full color images of true  $3\,840 \times 2\,048$  pixels resolution with 96 Hz refresh rate.

### SHD image system

The quality of the SHD images satisfies the requirements of archiving 35-mm films as well as distributing of commercial films and LSDI programme material. The 2001 SHD image system consisted of three devices: video server, real-time SHD decoder, and LCD projector. Since video cameras to capture SHD movies were not yet available, that all the data has been digitized from original films by a film digitizer, then compressed and stored in advance. The SHD decoder decompresses the video streams transmitted from the server using Gigabit Ethernet (GbE), and outputs digital video data to the LCD projector with a display resolution of  $3\,840 \times 2\,048$  pixels.

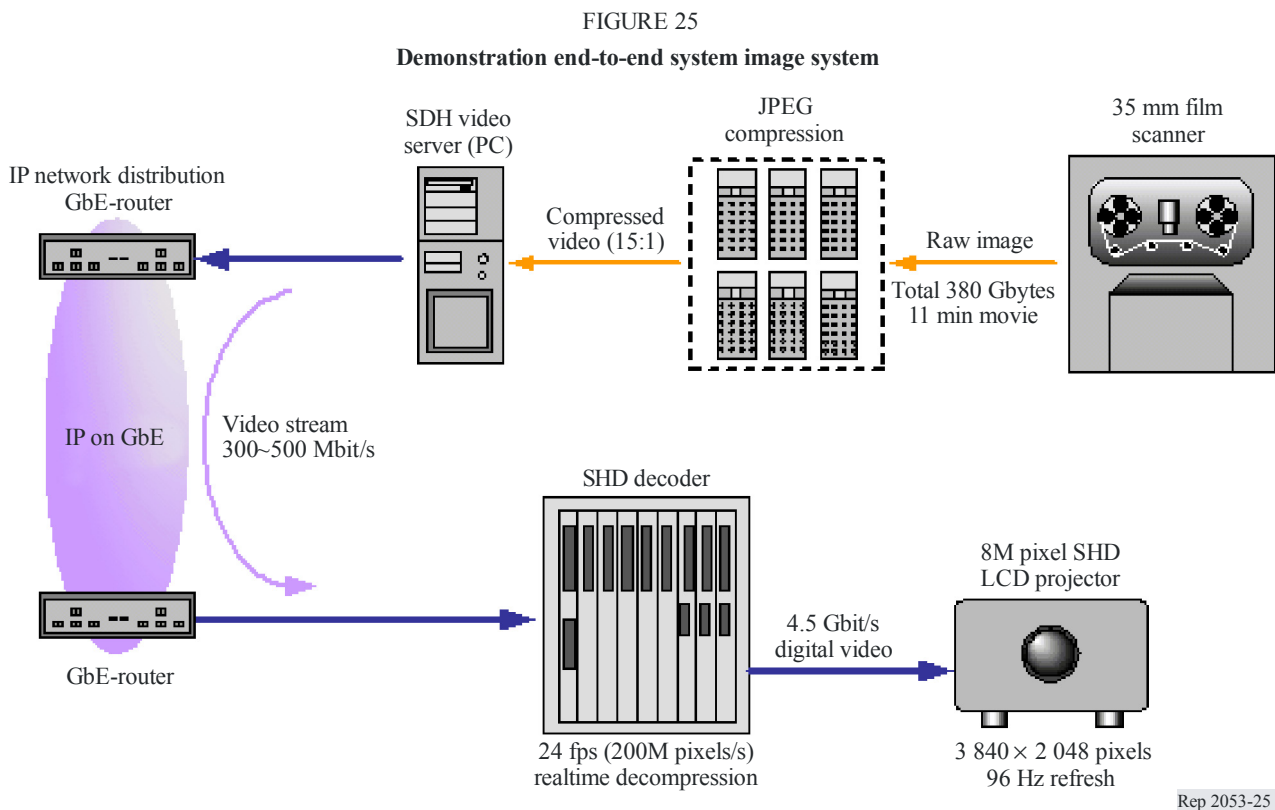

### Prototype system components for 2 048p/24 digital cinema

**Video server:** The original data, amounted to 380 Gbytes for an 11-min long sequence. The images were compressed using JPEG with 15:1 compression ratio. The compressed 25 Gbytes data were transmitted from the video server running on a PC/LINUX as 300Mbit/s IP/GbE data streams.

<sup>22</sup> It should be noted that some of the terminology used in 2001 may differ from that defined by Radiocommunication Study Group 6.



**SHD decoder:** The decoder received the IP data streams on a front-end PC/LINUX, then performed the real-time JPEG decompression at a speed of 200M pixels/s, using special circuit boards equipped with 32 parallel JPEG processing elements.

**LCD projector:** The projector used  $3 \times 3 \ 840 \times 2 \ 048$  pixel reflective-type LCD panels, with luminance exceeding 5000 ANSI lumens. To improve the image quality, filters were employed to limit the video frequency pass-band and improve the noise characteristic. In addition, the projector utilized a special digital video interface of 4.5 Gbit/s to the decoder.

#### 4.2 The real-time JPEG2000 decoder

Nippon Telegraph and Telephone Corporation (NTT) has developed a prototype digital movie system that can store, transmit and display super high definition (SHD) images of 8-million ( $3 \ 840 \times 2 \ 048$ ) pixel resolution using JPEG2000 coding algorithm [Fujii, T. *et al.*, 2003]. The SHD movie system, shown in Fig. 26, provides the VoD service. It consists of three main devices, a video server, a real-time JPEG2000 decoder, and a LCD projector. The movie data have been compressed and stored into the video server in advance. The decoder decompresses the video streams transmitted from the server using parallel JPEG2000 processors, and outputs the digital video data to an LCD projector with  $3 \ 840 \times 2 \ 048$  pixel resolution at 24 or 48 fps.

FIGURE 26  
Overview of prototype SHD movie system



(From left; server, GbE-SW, decoder, projector frame buffer and projector head (behind))

Rep 2053-26

The real-time JPEG2000 decoder is a main part of the digital movie system with 8-million pixel resolution. It can perform the real-time decompression at a rate of 400M pixels/s, using parallel JPEG2000 processing elements. The decoder consists of two circuit blocks, a PC/LINUX part with Gigabit Ether interface, and newly developed JPEG2000 processor boards on the PCI-bus (Fig. 27). In total four boards are installed in the PC in order to process 48 frames of  $3 \ 840 \times 2 \ 048$  pixels 30-bit colour images in a second. Each processor on the boards decodes a square image portion of  $128 \times 128$  pixels with RGB 4:4:4 sampling format at a time. The fragmented images are combined in the frame buffer of the boards, and the complete frames are output to display devices using a special digital video interface.

FIGURE 27  
JPEG2000 decoder board

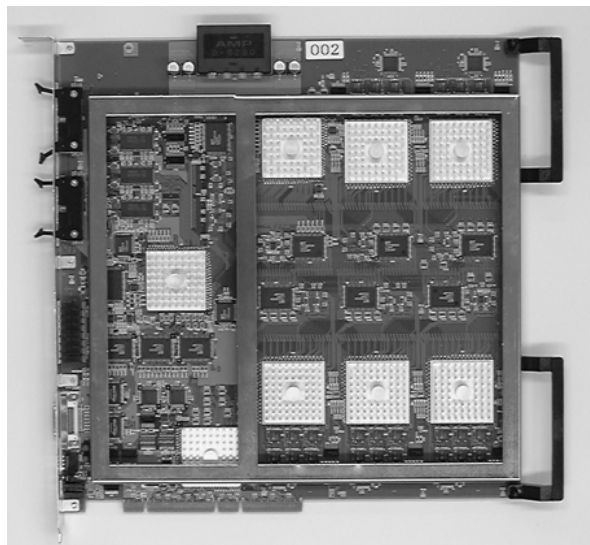

Rep 2053-27

The PC part receives the coded streams at 300 to 500 Mbit/s and then transfers them to JPEG2000 boards. The PC part consists of dual CPUs (P3-1.4 GHz) running under LINUX (kernel version 2.4); the PCI-64 bus hosts both the decoder boards and a GbE-NIC. A control program runs as an application that consists of two threads that share the PC's main memory as a large data buffer. One thread reads the data received from GbE-NIC, and the other reformats and forwards them to each of four decoder boards.

### 4.3 MPEG-2 CODECs system

NTT has developed real-time MPEG-2 CODEC, which can offer four times the resolution of conventional HDTV (2 160 pixels high  $\times$  3 840 pixels wide) and 30 fps frame rate [Nakamura, K., Yoshitome, T. and Yashima, Y., 2004]. It consists of several single-unit MPEG-2 HDTV CODEC and a multi-channel frame synchronizer, which can reconfigure their motion pictures of each CODEC for use in LSDI applications. In order to compress large images that exceed the resolution of HDTV, it was conventionally necessary to divide up and process the images in HDTV units.

However, a number of serious difficulties were encountered in the information exchange between encoders, which resulted in quality variations in some images. This newly developed cooperative rate control technology enables real-time exchanges of information between encoders, thus preventing variations in image quality and achieving even better pictures.

This CODEC system adopts the spatial image division and multi-stream output approach (Fig. 28). In spatial image division, the input image is divided into multiple sub-images and the encoder modules encode them in parallel. This approach is reasonable in terms of cost performance and scalability for LSDI CODEC system. Spatial image division can use either a one-stream output system, in which the sub-streams generated by the encoder modules are reconstructed into one elementary stream, or a multiple-stream output system, where several HDTV streams generated by the encoder modules are output directly in parallel or multiplexed into one transport stream.

FIGURE 28  
Spatially parallel encoding architecture for LSDI

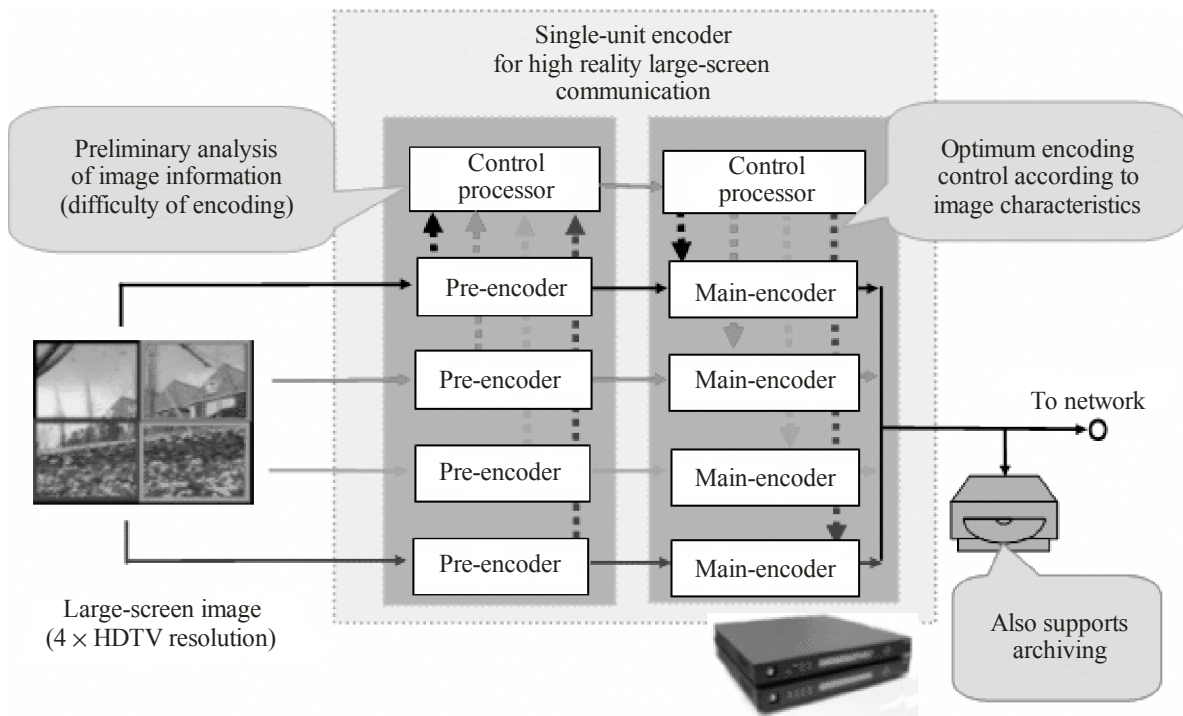

Rep 2053-28

The encoder part of this CODEC system is shown in Fig. 29. The external shape of the decoder does not differ from the encoder. This codec system can handle MPEG2-transport streams of 80M to 160M bps, whilst a stream recorder based on conventional PC can record and playback such streams in real time. The core of the system utilizes a 1-chip HDTV CODEC LSI called "VASA," which conforms to MPEG-2 international standards and enables both smaller size and greater economy than the conventional HDTV ones.

Using this CODEC technology, the semi-final game of the 2002 FIFA World Cup Soccer tournament was transmitted to Yamashita Park in Yokohama city as a public viewing event (see Fig. 30).

FIGURE 29  
Super high-resolution video CODEC



Rep 2053-29

FIGURE 30

Public viewing using super high-resolution video CODEC



Rep 2053-30

#### 4.4 MPEG-2 CODEC for 8k format LSDI

An MPEG-2 CODEC has been developed for efficient transmission and recording of a  $7\,680 \times 4\,320$  (8K) format LSDI. The CODEC system consists of a video format converter, a video CODEC, an audio codec, and a TS recorder, as depicted in Fig. 29. The video format converter converts the  $7\,680 \times 4\,320$  format images from/into those used in the current baseband system described in this Chapter into/from those used in the video CODEC. The video CODEC handles a  $7\,680 \times 4\,320$  format by dividing it into sixteen  $1\,920 \times 1\,080/30$  PsF images. The system has been developed based on the technology of the CODEC for a  $3\,840 \times 2\,160$  format described in this Chapter. The audio CODEC includes non-compression PCM and Dolby-E with a compression ratio of 1:4. It handles 24 channels of audio signals and thus can be applied to the 22.2 multichannel sound system for LSDI application described in Chapter 6 of this Part. The coded audio and video signals are multiplexed into four MPEG-2 TS (DVB-ASI) signals for an external interface. A TS recording device has also been developed. Major specifications of the system are listed in Table 7. A photograph of an experiment on using the CODEC is shown in Fig. 30.

FIGURE 31

Schematic diagram of CODEC system

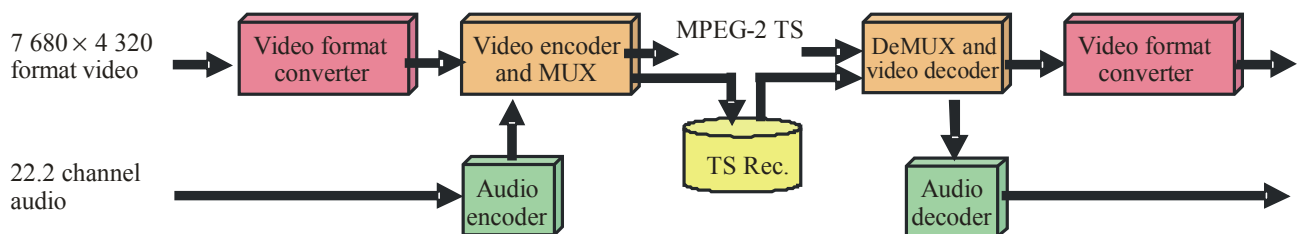

Rep 2053-31

TABLE 7  
Specifications of CODEC

Video	1920 × 1080/29.97 PsF (4:2:2) × 16
	MPEG-2 4:2:2/main profile
	180 Mbit/s-600 Mbit/s
Audio	24 ch (AES3 × 12)
	PCM (48 kHz, 24 bits), 28 Mbit/s
	Dolby-E (8-mono to 1-AES3), 7 Mbit/s
TS I/F and recording	MPEG-2 TS (DVB-ASI) × 4
	Maximum 840 Mbit/s

FIGURE 32  
View of CODEC



Rep 2053-32

## References

- FUJII, T. *et al.* [2003] Digital cinema system using JPEG2000 movie of 8 million pixel resolution. Proc. SPIE/IS&T, Vol. 5022, **5 022**, p. 50-57.
- MARPE, D., SCHWARZ, H. and WIEGAND, T. [July 2003] Context-adaptive binary arithmetic coding in the H.264/AVC video compression standard. IEEE Trans. Circuits Syst. Video Technol., Vol. 13, p. 620-636.
- NAKAMURA, K., YOSHITOME, T. and YASHIMA, Y. [2004] Super high resolution video codec system with multiple MPEG-2 HDTV CODEC LSI's. Proc. IEEE ISCAS VSPC-L4.3.
- WIEGAND, T. *et al.* [July 2003] Overview of the H.264/AVC video coding standard. IEEE Trans. Circuits Syst. Video Technol., Vol. 13, p. 560-576.

## Chapter 6

### Multichannel sound technologies

#### 1 Introduction

Various multichannel sound systems are in use in cinema theatres, broadcast systems and home audio systems or under development. Each multichannel sound system should have consistency in the number of channels from the production stage to the reproduction stage to maintain the spatial audio quality. Recommendation ITU-R BS.775-1 for the multichannel sound system with and without an accompanying picture.

The conventional multichannel sound system description is “ $x.n$ ” where  $x$  is the total number of loudspeakers (channels) and  $n$  is the number of low frequency effects (LFEs) loudspeakers (channels). However, different multichannel sound systems with the same description exist. Thus, the description of multichannel sound system as “ $x/y/z.n$ ” has been proposed to Radiocommunication SG 6. Here,  $x$  is the number of loudspeakers (channels) set on the floor,  $y$  is the number of loudspeakers (channels) set at the listener’s height or half height of the accompanying screen,  $z$  is the number of loudspeakers (channels) which set above the listeners (at ceiling level), and  $n$  is the number of LFE loudspeakers (channels).

Table 8 shows multichannel sound systems for a theatrical environment with a large picture currently in use.

TABLE 8

Multichannel sound systems for a theatrical environment with a large picture currently in use



Conventional description	Proposed description	Arrangement on the floor (lower level)	Arrangement at the viewer’s level (mid level)	Arrangement over the viewer (upper level)	Application area
5.1	0/5/0.1				Currently used in cinemas
6.1	0/6/0.1				Currently used in cinemas
6.1	0/5/1.1				Currently used in IMAX theatres
7.1	0/7/0.1				Currently used in cinemas with SDDS sound system
7.1	0/7/0.1				Developed for home audio systems by Lexicon, Dolby, etc.

Table 9 shows multichannel sound systems for a theatrical environment with a large picture currently in use in very few installations or currently under study.

TABLE 9

**Multichannel sound systems for a theatrical environment with a large picture currently in use or under study**

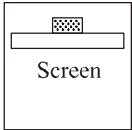
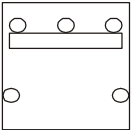
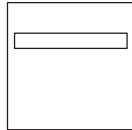
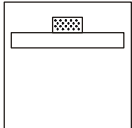
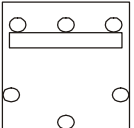
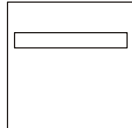
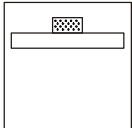
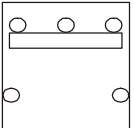
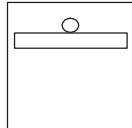
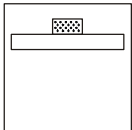
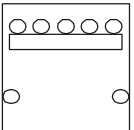
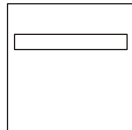
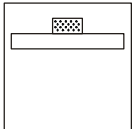
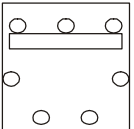
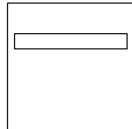
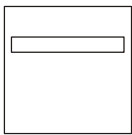
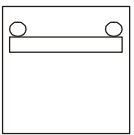
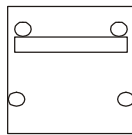
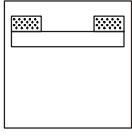
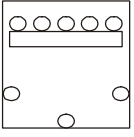
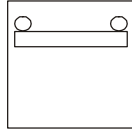
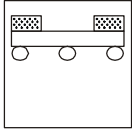
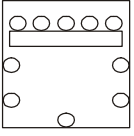
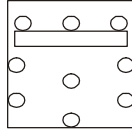
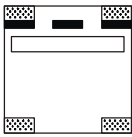
Conventional description	Proposed description	Arrangement on the floor (lower level)	Arrangement at the viewer's level (mid level)	Arrangement over the viewer (upper level)	In use or under study
6.0	0/2/4.0				Developed by MDG Co.
10.2	0/8/2.2				Being studied by Tomlinson Holman, TMH Corporation, USA
22.2	3/10/9.2				Being studied for ultra-high-definition video system by NHK, Japan
Wave field synthesis	Dependent on size of reproduction room				Being studied by FhG, Germany; TU Delft, The Netherlands; McGill, University Canada, etc.

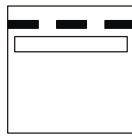
## 2 Multichannel sound systems presently in use

The following multichannel sound systems are being used in commercial cinema theatres.

### 2.1 5.1 (0/5/0.1)

This is the most widely used for cinema, broadcast and home audio. The arrangement of loudspeakers of this system for broadcast use should be based on Recommendation ITU-R BS.775-1. The audio system for home entertainment such as DVD-Audio, Super Audio CD and DTS CD is also based on the Recommendation ITU-R BS.775-1. There are no loudspeakers at the lower level or upper level.

### 2.2 6.1 (0/6/0.1)

This system has additional channel at rear centre of middle level to 0/5/0.1 system. It is reported that this additional channel enables the smooth movement of the sound image from the frontal area to the rear area. Many movies had already utilized this multichannel system, and a number of home audio equipment has also this function.

**2.3 6.1 (0/5/1.1)**

This system is used in IMAX theatres. It has an additional channel at the frontal centre of the upper level, because the IMAX screen is much larger than conventional cinema screens and requires sound localization at heights well above the audience level. This additional channel makes the sound image correspond to video images that appear above the audience's heads at the higher level.

**2.4 7.1 (0/7/0.1)**

This system is mainly used for the SDDS movie sound system. It has five frontal channels at the middle level in order to make the sound image correspond to video images over a very wide screen.

**2.5 7.1 (0/7/0.1)**

This system has the same description as the sound system described in § 2.4. Instead of five frontal channels at the middle level, this system has three frontal channels and two side channels and two rear channels. It is designed for home audio systems and has a sound quality equivalent to that of cinema.

**3 Multichannel sound systems under development**

Several multichannel sound systems have also been studied to improve the spatial impression of sound. The following systems seem to have the capability for practical use.

**3.1 6.0 (0/2/4)**

MDG Co. has proposed this system and has already released DVDs with this format. This system has two frontal channels (left and right) at the middle level, and has four channels (frontal left and right, rear left and right) at the upper level. Because its total number of channel is six, this system can easily be applied to conventional DVD video. It was reported that the loudspeakers on the upper level are effective for reproducing the spaciousness of a huge concert hall or church.

**3.2 10.2 (0/8/2.2)**

Tomlinson Holman, TMH Corporation, USA, developed this system as a next-generation cinema sound system. It has two frontal channels at the upper level to reproduce the elevation of the recorded sound. The middle level is similar to 0/7/0.1, but it also has a rear centre channel. This system has two LFE channels.

**3.3 22.2 (3/10/9.2)**

This system was developed by NHK (Japan Broadcasting Corporation). It has nine channels at the upper level, ten channels at the middle level, three channels at the lower level and two LFE channels. This system is suited to extremely wide screens, because it can localize two-dimensionally a sound image over the entire screen by using three lower channels and five middle channels and three upper channels around the screen. This system has common channels at each three levels with other multichannel systems so that its audio can be easily down-mixed to other multichannel sound systems and has compatibility with every multichannel sound system; i.e., it is compatible with every other multichannel sound system. NHK had proposed a multichannel sound systems hierarchy according to the size of the screen, size of the theatre, viewing/listening position and number of viewers/listeners. The basic system of this hierarchy should be 5.1 (0/5/0.1), and the highest system must be 22.2 (3/10/9.2).



### 3.4 Wave field synthesis

This system was designed by TU Delft in 1989. The European project CARROUSO developed components for the complete chain, from recording, coding, transmission, decoding up-to presentation. In February 2003 the first cinema using this system started daily operation (Ilmenau, Germany). In July 2004 a mixing site was set-up in Studio City, CA.

In the wave field synthesis (WFS), the number of loudspeakers is only related to the size of the reproduction room and completely independent from the number of transmission channels. The audio content is represented as audio objects containing the pure audio content together with metadata describing the position of the object at any instance of time together with the properties of the audio object like directivity. On the rendering site the driving signal for each individual loudspeaker is calculated taking into account its exact position in the reproduction room.

WFS overcomes the concept of a sweet-spot enabling the location of sound objects at any position outside and inside the reproduction room without problems of phase or sound coloration. All formats mentioned in § 5.1 can be reproduced using WFS by the concept of virtual loudspeakers enabling to increase the sweet spot for any content already produced.

## Chapter 7

### Cinema theatres for motion picture

#### 1 Introduction

Since the beginning of cinematography, 35-mm film has been established as an adequate medium enabling movie presentation in theatres in terms of technical quality and comfort.

The French Administration and the professionals of the cinematographic industry have set up rules and standards to ensure a very high level of technical quality and comfort in every theatre. Relevant contributions have been submitted to Radiocommunication SG 6.

In these contributions it was stressed that the new standards for LSDI applications addressing the specific aspects of motion picture should not introduce discrimination between theatres especially in terms of screen size. It was also pointed out that the distribution of motion picture should be based on a single standard or family of standards, thus allowing any theatre to potentially project any motion picture with the same equipment, and also facilitating the exchange of motion picture throughout the world on a fair and unbiased basis.

This Chapter reports standards and recommendations relevant to cinema theatres in force in France.

#### Definition of a cinema theatre

#### 2 Cinema theatre recommended parameters

##### 2.1 Current standards

###### 2.1.1 The AFNOR NF S 27001

The parameters for cinema theatres are specified in the AFNOR<sup>23</sup> NF S 27001 standard. They apply equally to any newly created or renovated theatre room and are shown in Table 10.

###### 2.1.2 29 June 1989 Protocol

In order to help the theatre operation managers to renew in their existing rooms screens in accordance with the requirements of the cinematographic art in terms of dimension and technical quality, the concerned ruling bodies (Fédération Nationale des Cinémas Français,<sup>24</sup> Centre National de la Cinématographie<sup>25</sup>, Commission Supérieure Technique de l'Image et du Son<sup>26</sup>) issued a Protocol adjusting some provisions of the S 27001 norm. The main purpose of this Protocol was to facilitate the installation of larger screens in existing rooms or rooms being created in existing buildings whose structures could not be easily modified without severe consequences.

---

<sup>23</sup> AFNOR stands for Association Française de Normalisation (National French normalization body).

<sup>24</sup> National Federation of French Cinemas (operation managers association).

<sup>25</sup> National Centre for Cinematography (branch of the Ministry of Culture).

<sup>26</sup> Image and Sound Technical Commission (a technicians association also in charge of regulations prescription and enforcement).

TABLE 10

**AFNOR NF S 27001 recommended parameters for cinema theatres**

<b>Description</b>	<b>AFNOR NF S 27001 standard</b>
Screen to front-row distance	$\geq 0.6 \times \text{Cinemascope width}$
Screen to last-row distance	$\leq 2.9 \times \text{Cinemascope width}$
Front-row head tilt angle (looking at top of screen) (degrees)	$\leq 45$
Front-row head tilt angle (looking at screen centre) (degrees)	$\leq 30$
Side vision angle, with respect to the normal (degrees)	$\leq 20$
Row spacing (even floor) (m)	$\geq 0.80$
Row spacing (tiered floor) (m)	$\geq 0.90$
Head clearance (m)	$\geq 0.12$
Clearance under projection beam (m)	$\geq 2.00$
Screen curvature radius	$\geq 5.8 \times \text{Cinemascope width}$
Forward tilt angles in projection	Must not induce image trapezoidal distortions superior to 3% (tolerance 5%)
Seat back plane orientation	Between the screen surface plane and the plane perpendicular to the viewing axis towards screen's centre for the selected seat
Seat upper limit plane	Below the plane intersecting the top side of the screen, tilted 20° above horizontal

In any case the full provisions of the AFNOR NF S 27001 are fully applicable to new venues, or when completely renewing (including the inner walls) the existing ones.

This Protocol simply permits to maintain in existence some worthwhile cinematographic venue, rather than to let it disappear. Therefore, its application should be restricted to well defined and exceptional cases.

The Protocol allows for the modified parameters as shown in Table 11.

TABLE 11

**AFNOR adjusted parameters for cinema theatre**

(as modified by the 29th June 1989 Protocol)

<b>Item</b>	<b>NF S 27001</b>	<b>Protocol 06/89</b>
Clearance under beam (m)	$\geq 2.00$	$\geq 1.80$
Screen to front-row distance	$\geq 0.6 \times \text{cinemascope width}$	$\geq 0.5 \times \text{screen width}$
Head clearance (m)	$\geq 0.12$	$\geq 0.09$

All the other provisions of the S 27001 standard remain applicable, notably the head tilt angles.

### 2.1.3 Recommended parameters

Every designer of a cinematographic theatre room (operation manager, architect) should carefully comply with the values in the right column of Table 12, which guarantee quality and comfort to the audience.

TABLE 12

#### AFNOR NF S 27001 recommended parameters for cinema theatres

Item	Designation	NF S 27001 standard	Protocol 89/97 (exceptional cases)	Recommended value
C.1.1	Screen to front-row distance	$\geq 0.6 \times \text{Cinemascope width}$	$\geq 0.5 \times \text{Screen width}$	$\geq 0.8 \times \text{Screen width}$
C.1.1	Screen to last-row distance	$\leq 2.9 \times \text{Cinemascope width}$	$\leq 2.9 \times \text{Screen width}$	$\leq 2 \times \text{Cinemascope width}$
C.1.2	Front-row head tilt angle/ top of the screen	$\leq 45^\circ$ (eye at 1.00 m/ floor)	$\leq 45^\circ$ (eye at 1.10 m/ floor)	$\leq 40^\circ$
C.1.2	Front-row head tilt angle/ screens centre	$\leq 30^\circ$ (eye at 1.00 m/ floor)	$\leq 30^\circ$ (eye at 1.10 m/ floor)	$\leq 30^\circ$
C.1.3	Row spacing on even floor (m)	$\geq 0.80$	$\geq 0.80$	$\geq 0.90$
C.1.3	Row spacing on tiered floor (m)	$\geq 0.90$	$\geq 0.90$	$\geq 1.00$
C.1.4	Side vision angle (degrees)	$\leq 20$	$\leq 20$	$\leq 16$
C.1.5	Seat back plane/screen plane (degrees)	$\leq 20$	$\leq 20$	See complete guide
C.1.6	Head clearance (m)	$\geq 0.12$	$\geq 0.12$ (0.09 on first Protocol)	$\geq 0.15$
C.1.7	Upper plane (degrees)	$\leq 20$	$\leq 20$	$\leq 20$
C.2.1	Screen curvature radius	$R \geq 2 \times D$ (screen/last row)	$R \geq 1.5 \times D$ (screen/last row)	$R \geq 2 \times D$ (screen/last row)
C.2.2	Vertical geometrical image distortion (%)	$\leq 3$ (tolerance 5)	$\leq 3$ (tolerance 5)	$\leq 3$
C.2.3	Horizontal geometrical image distortion (%)	$\leq 3$ (tolerance 5)	$\leq 3$ (tolerance 5) with ratio Projection distance/screen height > 3.5	$\leq 3$ (tolerance 5) with ratio Projection distance/screen height > 4
C.2.4	Clearance under projection beam (m)	$\geq 2.00$ (tolerance 1.80 on front half for rooms < 200 places)	$\geq 2.00$ above aisles 1.80 above seats	$\geq 2.00$
	Background noise level			NC 27 (digital) NC 30 (analogue)

## 2.2 Screen size

### 2.2.1 Image size lower bound

Due to the perceivable dimensional references in the viewer's visual field (doors, other viewers, stairs, signposts, etc.), it is difficult to subjectively create the illusion of a large image if the screen base does not reach at least 7.00 m for a small room (150 places) et 10.00 m for a greater room. A large image means an image in which the viewer is "immersed" (as conveyed sometimes by the French expression "rentrer dans le film"). This sensation cannot be achieved if the image surface does not cover an important part of the visual field.

### 2.2.2 Image size upper bound

This limit is set by the existing technology. On a 35 mm standard release print, the "grain" of the film, basic element for the picture composition, has a size of approximately 10  $\mu\text{m}$ . An enlargement of 1 000 times will exhibit a "grain" of 1 cm in the projected image, which is the maximum value which can be tolerated without appearance of important optical defects. The width of the image's projected frame being approximately 21 mm, the maximal width will be, in the best cases, 21.00 m.

<b>Minimal and maximal dimensions for a 2.39:1 Cinemascope format screen</b>	
Minimal recommended size (visual field coverage)	Maximal recommended width (image's sharpness, illumination)
7.00 m	20.00 m
<b>Minimal and maximal dimensions for a 1.85:1 widescreen format screen</b>	
6.00 m	15.50 m

The illumination criteria are also to be taken in account. A large projected image requires the use of a high power light source, which will generate high heat levels resulting in possible film deterioration. The maximal allowed light power in "classical" 35 mm projection is 7 000 W. Higher powers would result in huge maintenance and monitoring costs and in consequent considerable risks for the film.

This maximum light power will allow practical projections on surface areas of about 130 m<sup>2</sup>, which corresponds to an image base of about 17.50 m in the 2.39:1 Cinemascope format. New technologies accelerating film feeding in the projection gate allow for an illumination gain of at least 25%, but with other operational constraints not yet compatible with traditional operation.

## 2.3 Screen types

### 2.3.1 Flat screen

The flat screen is the easiest to install, and actually results in few problems for the image provided that the projection's distance is sufficient.

### 2.3.2 Curved screen

The curved screen is slightly more difficult to build, and will necessitate more care in the choice and installation of the projection's optical elements. The curvature must only be considered as **a subjective improvement**, accentuating among other things the image depth and in some cases a better perception of light. In any case this must not be predominant for the technical choice.

## 2.4 Screen parameters

### 2.4.1 Screen curvature

It is commonly accepted that the use of a curved screen results only in a subjective improvement of the image perception, i.e. it helps in creating a depth sensation for images, which do not have any mechanical depth (planar film). The only technically true image depth that can be created is the one related to the depth of field used in film recording (highly dependent on shooting conditions). The flat projection allows the reproduction of this optical “illusion”.

In other respects, projection equipments have technical limitations. Projections on large screens with rather short projection distances necessitate the use of short focal length lenses, for which the depth of field is limited. It becomes often critical to obtain the right focusing as much in lateral as in central areas. Since lenses are built mainly for flat screen projection, the screen's curvature may increase the difficulties.

Lastly, the viewer must be able to observe the screen under good conditions (see § 2.5).

FIGURE 33  
Screen curvature radius

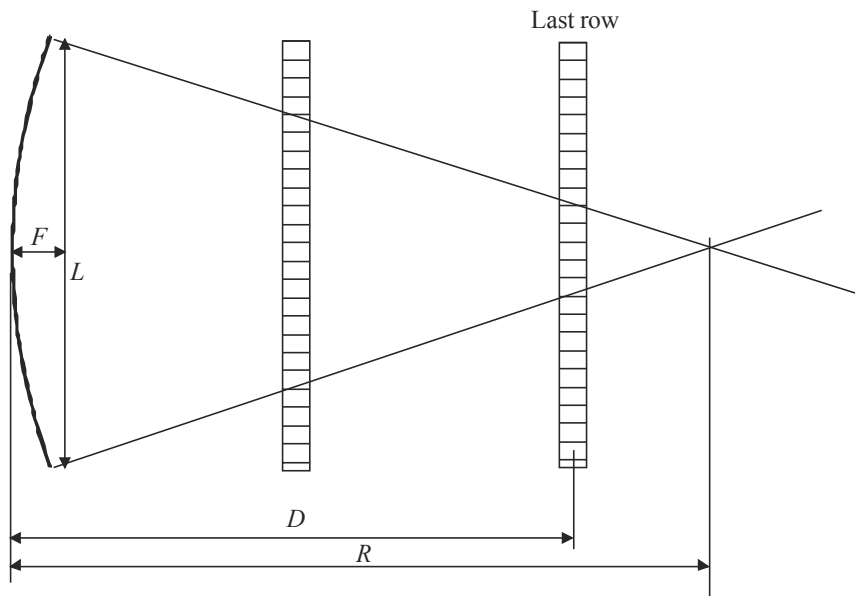

Rep 2053-33

The value of the curvature radius is given by the following formula:

$$R = \frac{L^2}{8 \cdot xF} + \frac{F}{2}$$

Criterion No. 1	
Minimal curvature radius	$R \geq 2$ times the distance from the screen to the last row

A tolerance of 1.5 times  $D$  may be accepted.

## 2.5 Room parameters

### 2.5.1 Distance to screen

#### 2.5.1.1 Minimum distance

Perception of screen perforations is very annoying to viewers. Since the eye resolution is an angle of about 1' angle, and the perforation size is in general 1 mm, in theory it would not be desirable to place viewers closer than 6.00 m from the screen.

Assuming that an average horizontal aperture of the human binocular vision of 120°, the viewer should be placed at least at 0.3 times the width of the image, in order to perceive it in full. However, the viewer will not be able to perceive the 120° vision without various head movements.

For a more comfortable vision the perceivable solid angle is practically limited to about 90°, resulting in a minimal distance to the screen of 0.5 times the width of the observed image. For the lateral seats of this first row, measuring takes place from the point of the screen facing the seat's axis.

Parameter No. 2	
Minimum distance to screen	$\geq 0.6$ times the width of the largest image $> 0.5$ times tolerated in some cases

#### 2.5.1.2 Maximum distance

In principle any viewer should be able to perceive the smallest detail projected on the screen, i.e. the projected image of one film grain. However, for practical purposes, it will be accepted as a worst condition, that the viewer could confuse two grains. Consequently, the perception of a detail of 1.5 times the projected image grain will require placing the viewer at a distance not exceeding 2.45 times the full image width.

On the other hand, to ensure a minimal sensation of the image dimension, it can be assumed that the projected image field should fill at least 15% of the viewer visual aperture (a 20° vision angle). The maximal distance could then set to a maximum of 2.9 times the width of the observed image in exceptional cases.

Parameter No. 3	
Maximum distance to screen	$\leq 2.5$ times the width of the largest image

### 2.5.2 Head tilt angles

Parameter No. 4	
Head tilt angle (eye focusing the top of the screen) (degrees)	$\leq 40$ (tolerance 45)
Head tilt angle (eye focusing the screen's centre) (degrees)	$\leq 30$

### 2.5.3 Row spacing

In this case, the only physical constraint is to leave enough space for the viewer's knees. Taking into account the seat models proposed by the manufacturers and the minimum size specified by the Safety authorities, a minimal row spacing of 0.90 m is recommended. It should be noted that this is only a minimal value, so that values of 1.10 m, even of 1.30 m can be realized, as proposed by many manufacturers.

The measure of the layout spacing between rows is taken at the seat's feet since the seat back due to reclining has a too wide variability to ensure reliable measurements.

Parameter No. 5	
Row spacing (m)	$\geq 0.90$

### 2.5.4 Side vision angle

Experience shows that in those theatres where all the front-row conditions (distance to screen, head's tilting) are set at their minimum acceptable value, the vision in any additional lateral seat may become very annoying.

It is strongly recommended that the front-row width be kept within the screen width (i.e. row width = screen width). In these conditions, seat areas with an offset of  $20^\circ$  (side vision angle,  $\beta$ ) with respect to the screen perpendicular can be acceptable. For smaller rooms it is advised to limit this angle to  $10^\circ$ .

The viewing area will then start from a point situated at the minimal distance for a front-row, on the perpendicular at the screen's edge (see Figs 34 and 35) and will extend to an angle of  $20^\circ$ .

If the limits of § 1.4.1 and 1.5.2 to 1.5.3 are set to their minimum, a maximal  $\beta$  angle of  $16^\circ$  will result.

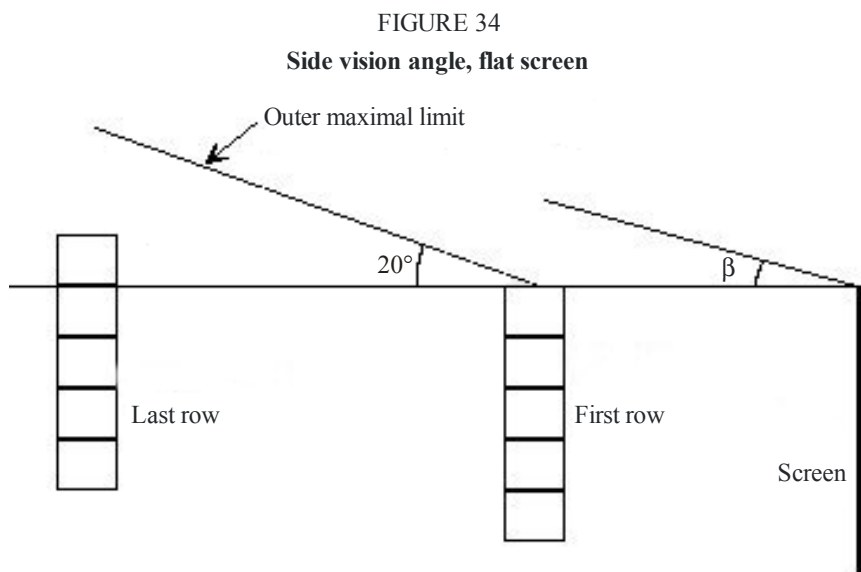
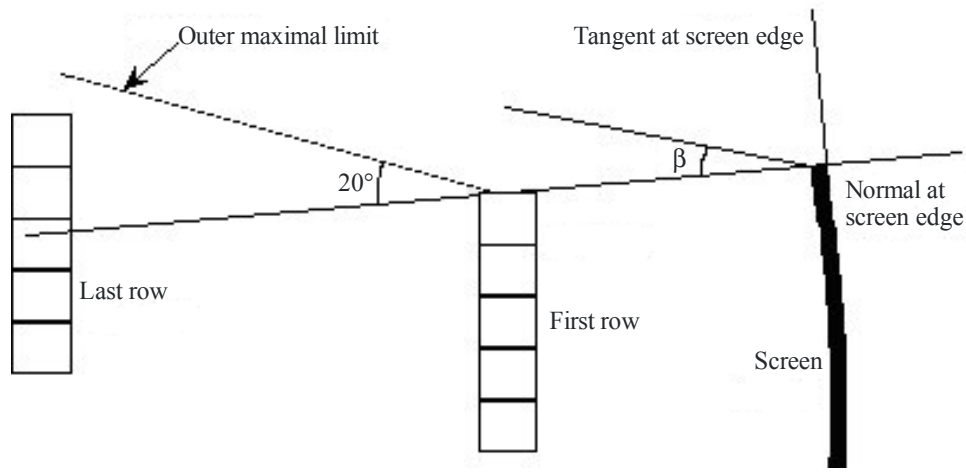



FIGURE 35  
Side vision angle, curved screen



Rep 2053-35

Parameter No. 6	
Side vision angle (degrees)	$\beta \leq 16$

In the case of a curved screen, the calculation is done relatively to the normal at the screen's edges.

### 2.5.5 Seat back plane orientation

For any seat, the seat back plane will be orientated along the direction determined by the plane parallel to the screen and the plane perpendicular to the viewing axis towards the screen's centre.

FIGURE 36  
Seat back plane orientation

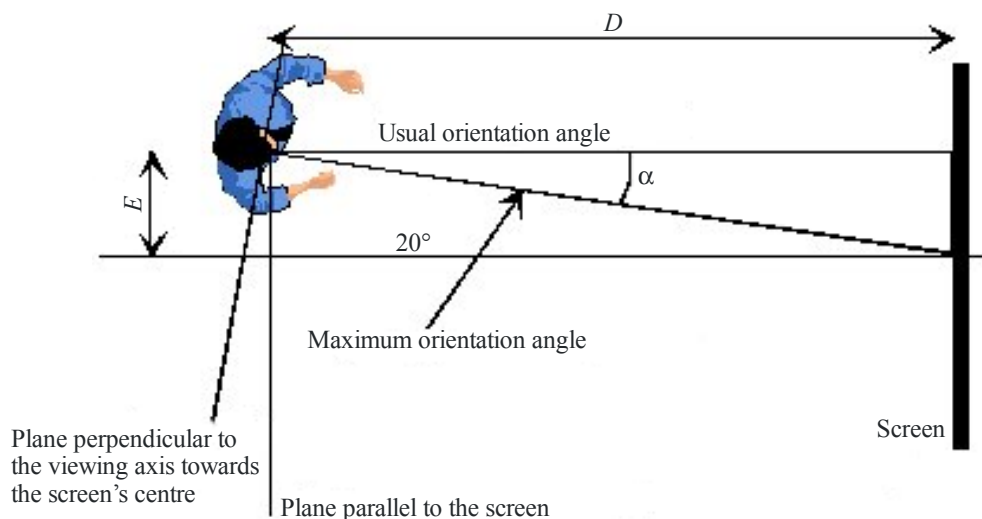

Rep 2053-36

In the case of a curved screen, the calculation is performed with respect to the tangent to the screen centre. In any case, the condition to include the whole width of the screen in the 90° aperture of the viewer's vision (see § 2.5.1) is to be respected.

Parameter No. 7	
Seat back plane orientation	$\alpha \leq \arctangent (E/D)$

**2.5.6 Head clearance**

The average vertical distance between the eyes of a viewer and his head top is 0.12 m (without accounting for hats and particular hairstyles).

Since the head of the viewer sitting in the fore row should not hinder the vision in any seat of the row behind, the screen bottom, the seat base height, and the height difference between rows must be taken into account.

An interleaved seat configuration moves the visibility problem from the central seats to the lateral ones, so that it cannot represent a valid solution for the whole of the seats.

It is recommended to make first calculations assuming a minimal head clearance value of 0.15 m, if the ceiling height is a limiting factor, or more if there is no height problem.

Modern seats place the viewer’s eye at a height,  $H$ , of about 1.10 m. It is recommended to take into account the value,  $H$ , relevant to the selected model at the early stage of the room design.

FIGURE 37  
Head clearance

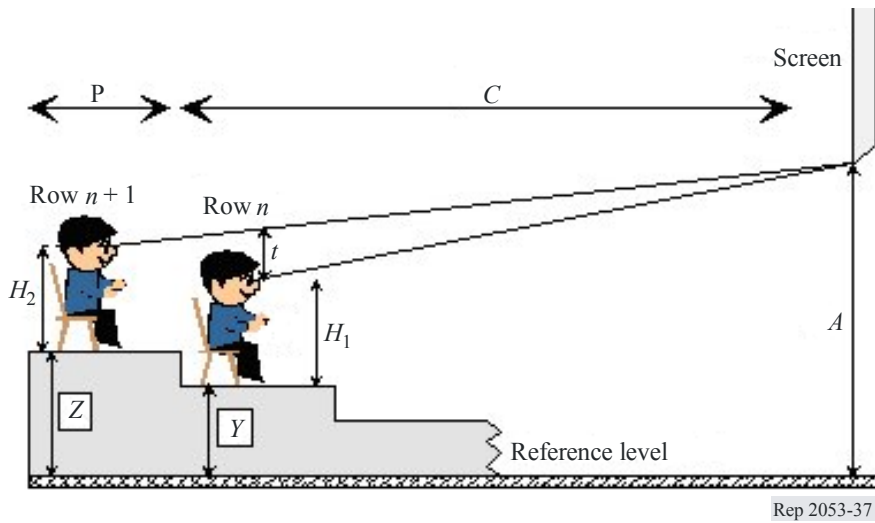

Parameter No. 8	
Minimal head clearance value (m)	≥ 0.12 minimum ≥ 0.15 suggested

### 2.5.7 Seat upper limit plane

FIGURE 38  
Seat upper limit plane

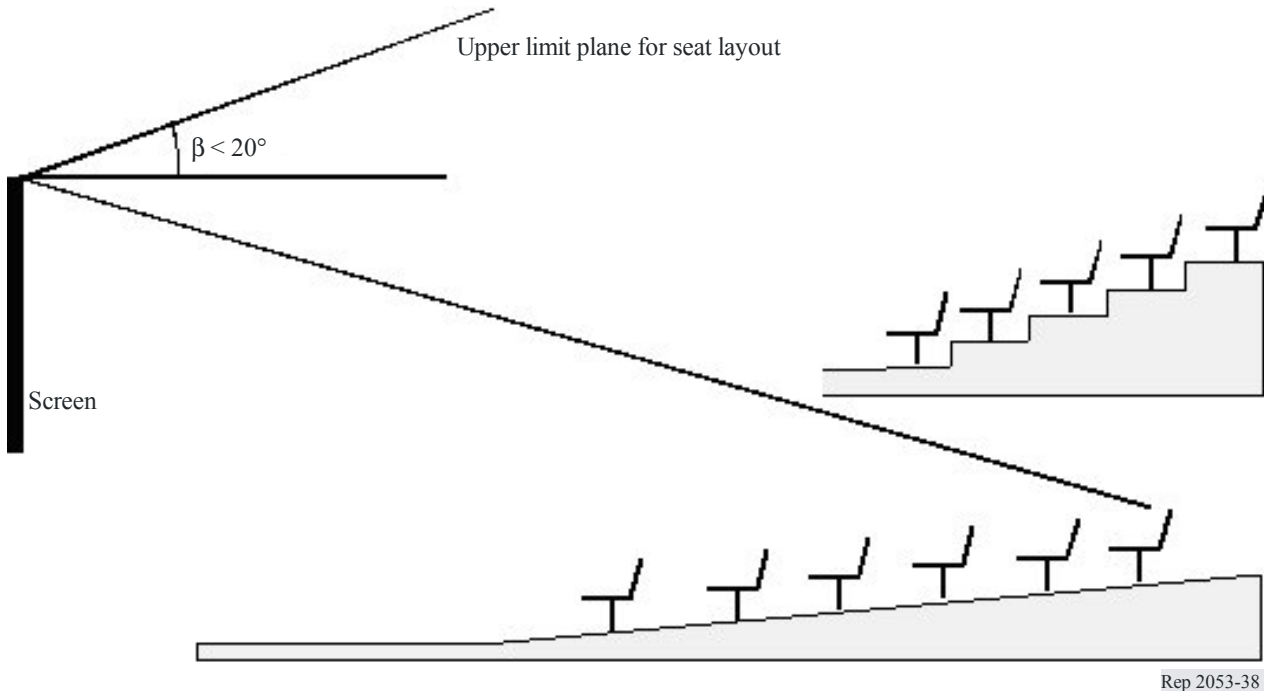

For a comfortable vision the front-row viewer's head should not be tilted too much upwards or the head of the viewer seated in the highest rows tilted too much downwards. Consequently, it is advisable not to place seat rows too high above the screen.

For this, an upper plane tilted  $20^\circ$  from the screen is set as a limit above which it is not recommended to install seat rows. This item applies especially to rooms equipped with a balcony.

Parameter No. 9	
Tilt angle above horizontal of the upper limit plane for the seats layout (degrees)	$\beta \leq 20$

### 2.5.8 Projection distance

The ranges of available projection lenses allow some flexibility in calculating the projection distance. However, it should be stressed that the use of short focal length lenses, except for the use of specially corrected models (which have high prices), generally affects the image quality resulting in lack of sharpness constancy, pincushion deformation.

The use of short focal length lenses also enhances the small optical misalignment defects inherent to projectors but negligible in normal operation: blurring at the image's edges, slight film flatness distortion in the projector's gate, misalignment of the projector's lamp-house, misalignment of lenses in their casing. In conclusion, the performance of even the best available equipment will be affected in a visible and practically irreparable manner simply due to few missing metres on the projection distance.

Parameter No. 10	
Projection distance	$D \geq 3 \times \text{screen height}$

### 2.5.9 Image geometric distortion

FIGURE 39

Image geometric distortion

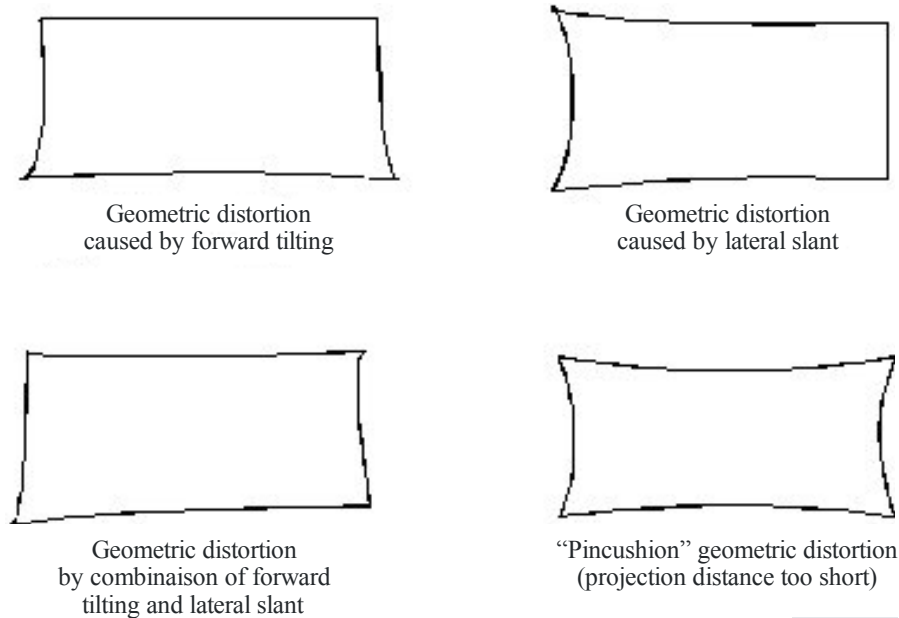

Rep 2053-39

Obviously the design must aim at no distortion at all, i.e. to vertical and horizontal projection axes perpendicular to the centre of the screen surface.

As in the case of the projection distance, if the above condition is not met, visible defects on the image (mainly trapezoidal deformation, blurring on part of the image, splitting in two of the image) will appear, with no technically efficient ways to compensate for them. Therefore it is strongly recommended to verify that projectors are installed as close as possible to the perpendicular axis of the screen centre.

The geometric distortion may be partially compensated by the use of custom-made lenses from manufacturers, but their price is relatively prohibitive (3 to 4 times the normal price).

If the image field outer contour may be adjusted to make it a parallelepiped (the projection's gate), the image distortion (vanishing lines, curved vertical or horizontal lines, deformed sub-titles) cannot be straightened up.

The geometric distortion is calculated with the formula:

$$D = 200 \times \tan(\alpha) \times \tan(\beta/2) \quad (\%)$$

For laterally slanted projection, calculation can be made according to one of the following two methods:

- the side vision offset angle and the beam aperture are known. In this case, the same formula as for the forward tilt applies.
- the side vision offset angle and the beam aperture are not known. In this case, the distortion may be related to the maximum distance between the projector and the perpendicular to the screen centre, which can be calculated as follows (see Fig. 41):

$$X_{max} = (3 \times D) / 200 \times \tan(\beta/2)$$

It should be remembered that according to usual building design, the optical axis of the projector are located at about 1.20 m above the cabin floor (between 1.10 m and 1.25 m).

FIGURE 40  
Image geometric distortion (vertical)

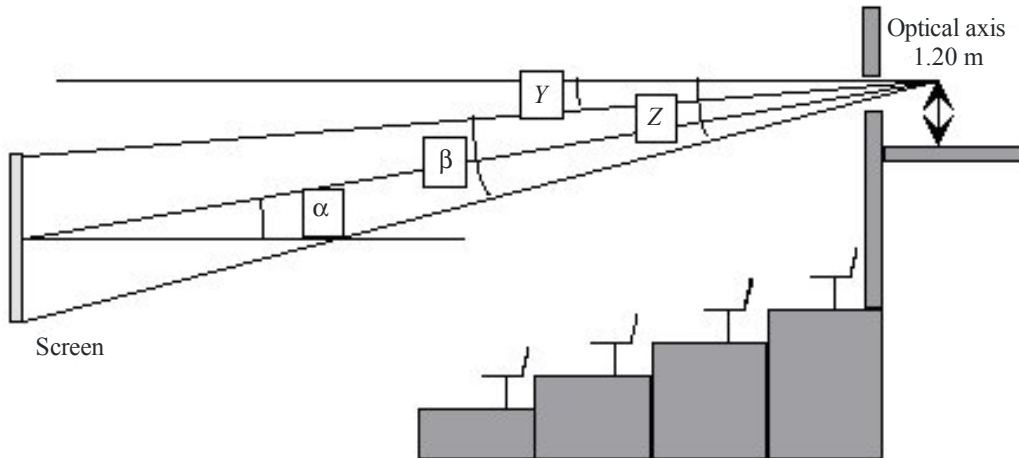

Rep 2053-40

FIGURE 41  
Image geometric distortion (horizontal)

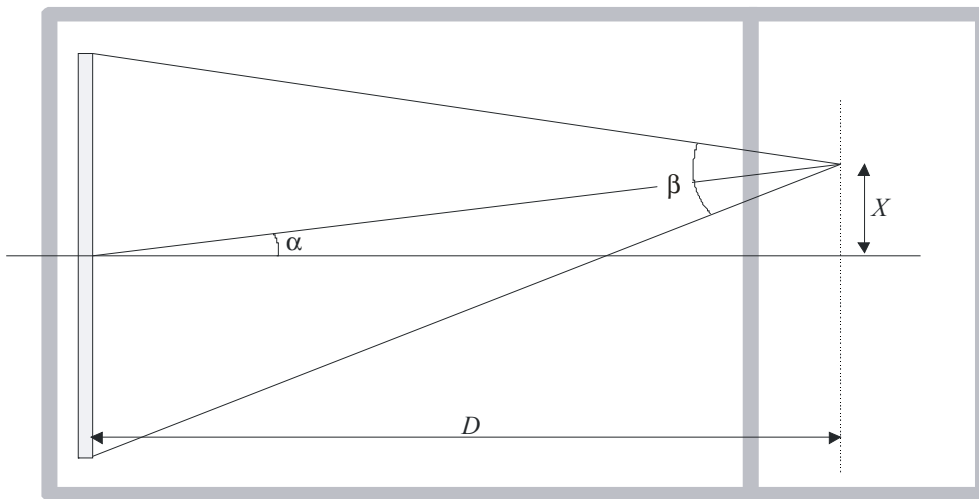

Rep 2053-41

Parameter No. 11	
Geometric distortion (%)	≤ 3

### 2.5.10 Clearance under projection beam

This parameter has been introduced to ensure that a viewer moving all over the room will not intercept the projection's beam with any part of his body, generally the head, and hence partially shadowing the image.

FIGURE 42  
Clearance under projection beam

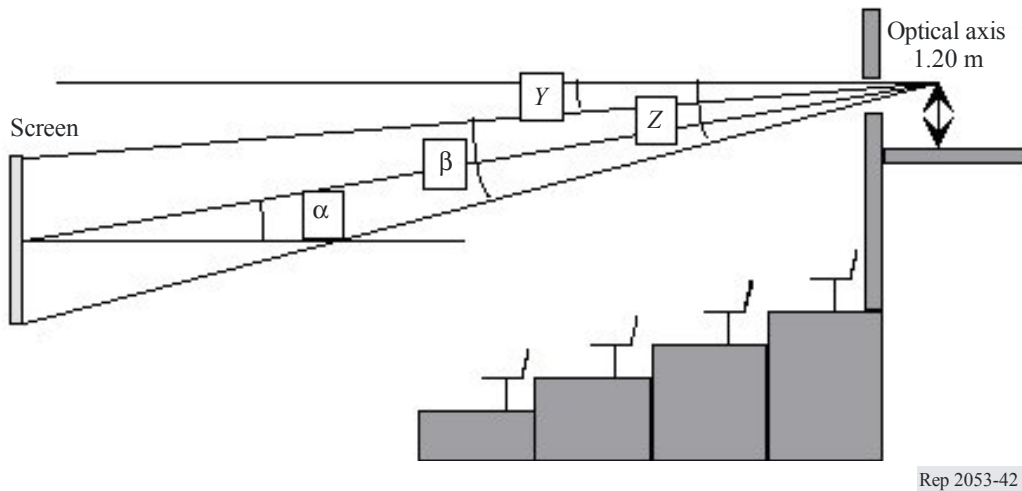

Parameter No. 12	
Clearance under projection beam (m)	2.00

## 2.5.11 Room outfit

The image projection and sound reproduction system should meet a number of specifications to ensure their quality performance. The architect and interior designer task is to enhance the comfort of cinematographic venues while duly respecting the specific needs of the projection. These needs may be defined as follows:

### 2.5.11.1 Image

#### *Interfering light:*

- Interfering light sources may arise mainly from the emergency and safety lighting. It will be crucial to place the safety equipment in such a way that they are not illuminating the screen's surface, or that they are not falling in the viewer vision aperture. Notably, emergency exits near or under the screen should not be allowed.
- Interfering light sources may also arise from all the openings present in the room such as the door's frame casings and the frames of the smoke hatches. Windows also should be completely blacked-out.
- Interfering light may also rise from reflections. The wall panelling, especially on the forward tier of the room, should be made of dark dull material, in order to eliminate any interfering reflection back to the screen of the light reverberated by its surface.

### 2.5.11.2 Sound

The design of the outfit should absolutely include an internal acoustical treatment of the room. This subject is discussed at length in the chapter "Acoustics" of AFNOR NFS S27001.

## Chapter 8

### Applications of the expanded hierarchy of LSDI systems

In a theatrical environment, viewing angles determine the required level of image resolution. As reported to Radiocommunication SG 6, a wider viewing angle generates higher “sensation of reality”. For LSDI applications for presentation of content such as dramas, plays, sporting events, concerts, cultural events, etc. in theatres, “sensation of reality” is one of the most important factors. Expanded hierarchy of LSDI systems are required for the LSDI applications for presentation of those content in theatre. Hierarchical image formats comprising multiples of HDTV format are specified as shown in Table 13.

TABLE 13

#### Picture and scanning characteristics

Item	Parameter	Values	
		3 840 × 2 160 LSDI system	7 680 × 4 320 LSDI system
1.1	Picture aspect ratio	16:9	
1.2	Samples per active line	3 840	7 680
1.3	Active lines per picture	2 160	4 320
1.4	Sampling lattice	Orthogonal	
1.5	Order of samples	Left to right, top to bottom	
1.6	Pixel aspect ratio	1:1 (square pixels)	
1.7	Sampling structure	4:2:2, 4:4:4	
1.8	Frame rate (Hz)	24 <sup>(1)</sup> , 25, 30 <sup>(1)</sup> , 50, 60 <sup>(1)</sup>	
1.9	Image structure	Progressive	
1.10	Bit/pixel	10	
1.11	Colorimetry	See Recommendation ITU-R BT.1361	

<sup>(1)</sup> For the 24, 30 and 60 Hz systems, frame rates having those values divided by 1.001 are also included.

Expanded hierarchy of LSDI systems has been or is going to be experienced. Live relay of an orchestral concert was conducted by a group of Japanese companies in September 2002. The concert was captured by an 8M-pixel camera and transmitted through an optical network. The programme was presented with an 8M-pixel projector. The system is categorized as “3 840 × 2 160 LSDI system” in Table 13. A system categorized as “7 680 × 4 320 LSDI system” is also going to be exhibited by a public broadcaster of Japan in 2005. Annex 1 describes the exhibition of LSDI comprising the expanded format video and 22.2 multichannel audio at the 2005 World Exposition, Aichi, Japan.

In October 2005, a theater capable of displaying expanded-hierarchy LSDI was set up at the Kyushu National Museum. This constitutes the first commercial use of an expanded LSDI of 7 680 × 4 320 format. The museum uses the system to archive its various precious artifacts and introduce visitors to them. Figure 43 shows the inside of the theater.

On 31 December 2005, NHK presented a trial live relay of one of its popular music concert programs in a theater with 8k format video for public viewing. Many people who could not obtain a ticket to the concert were able to enjoy it on the screen of the theater (Fig. 44).

FIGURE 43

View of the theatre of the museum



FIGURE 44

Public viewing of a concert



Rep 2053-4344

Expanded hierarchy of LSDI systems can also be used for a wide variety of applications under non-theatrical environment such as advertisement notices, image archive materials and background images for programme production.

## 1 Available technologies for the expanded hierarchy of LSDI systems

Research and development of the technologies have been in full activity in North America, Europe and Asia aiming at practical implementation of the expanded hierarchy of LSDI systems from capture to large screen presentation. Some of the technologies have already been realized. Those technologies are summarized in Table 14.

TABLE 14

Available technologies for the expanded hierarchy of LSDI systems

Area of technology	Relevant sections in the Report on LSDI technology
Camera	1.2.3 4k × 2k camera
	1.2.4 8k × 4k camera (CCD)
	1.2.5 8k × 4k camera (CMOS)
	1.2.6 ARRI D-20
	1.2.7 DALSA Origin
	1.2.8 Lockheed Martin 12M-pixel camera
	1.2.9 Panavision Genesis
Display	3.3 4k × 2k display
	3.3.1 JVC, CRL and NTT projector
	3.3.2 Sony 4k × 2k projector
	3.4 NHK 8k × 4k display system
Distribution	4.3 Prototype distribution system by NTT
Coding	5.3 Real-time JPEG2000 decoder
	5.4 MPEG2 CODECs system



## Annex 1 to Chapter 8

### Exhibition of LSDI comprising expanded format video and 22.2 multichannel audio at the 2005 World Exposition, Aichi, Japan

#### 1 Introduction

The 2005 World Exposition, Aichi, Japan is being held from 25 March to 25 September. Its objective is to provide the place for the world's people to gather and think on behalf of the life and future of all the Earth. NHK, a public broadcaster of Japan, is taking part in the EXPO and exhibiting a next-generation audio-visual system "Super Hi-Vision", an extremely high-resolution video system with  $8k \times 4k$  pixels, at Global House, the symbol pavilion.

#### 2 Theatre

A schematic configuration of the system is shown in Fig. 45. It consists of hard disk recorders for extremely high-resolution video, a switcher, a projector, a 600-inch ( $13\text{ m} \times 7\text{ m}$ ) screen, a hard disk recorder for 22.2 multichannel audio, a mixer, audio amplifiers and 77 loudspeakers. These components are controlled by operators through a sequence controller. The arrangement of the loudspeakers and the screen are shown Figs 46 and 47. The viewing angle ranges from  $100^\circ$  at the front row to  $60^\circ$  at the last row of the theatre.

FIGURE 45  
Schematic diagram

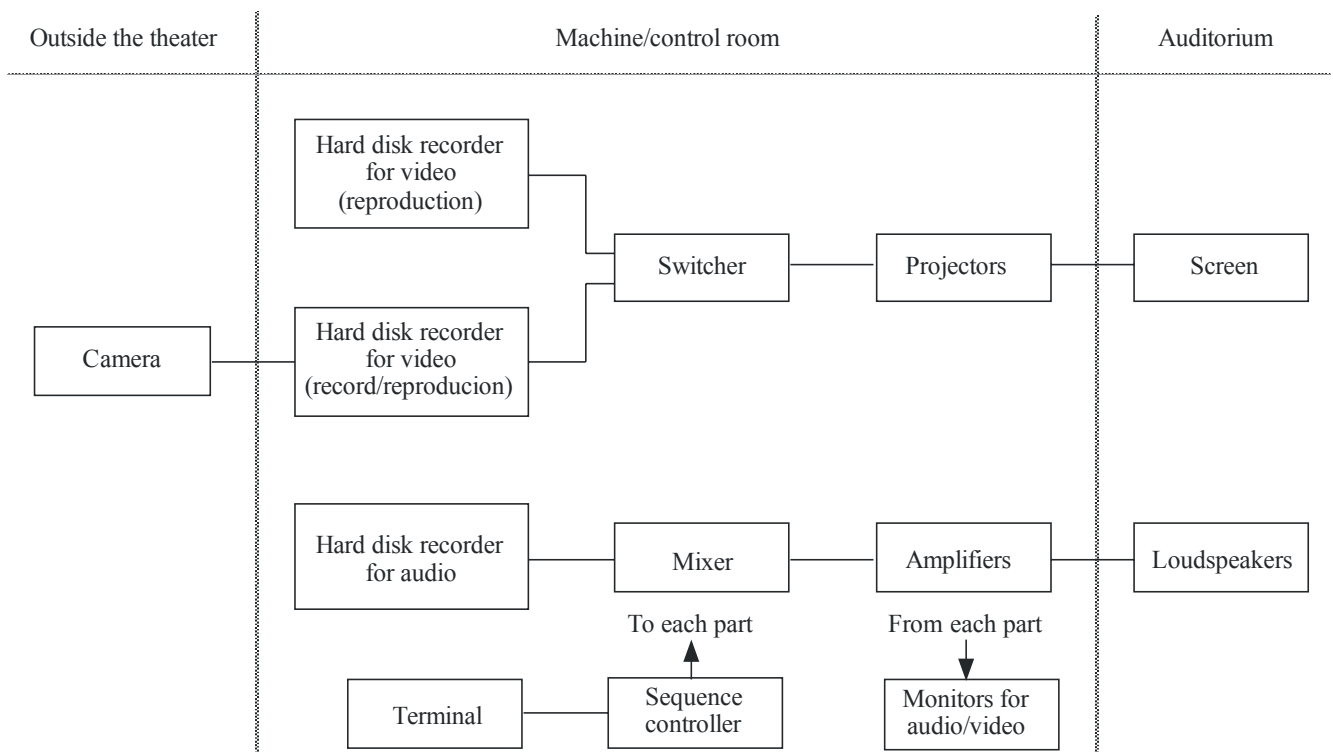

FIGURE 46  
Arrangement of loudspeakers



Rep 2053-46

FIGURE 47  
600-inch screen



Rep 2053-47

### 3 Production

An OB van equipped with the above-mentioned hard disk recorder and an extremely high-resolution camera was built. Shooting was conducted around Japan for seven months since July 2004 (see Fig. 48). Computer-based equipment and technologies were applied for

post-production and CG generation. Through the productions of demo materials, various recordings of 22.2 multichannel sound were carried out. A recording of music was done in a large recording studio using about 40 microphones. Many production recordings in various fields were also held using about ten microphones.

FIGURE 48  
Location shooting



Rep 2053-48

#### 4 Instant capture and replay

In addition to the seven-minute programme, an instant capture and replay is also featured at the show. Four hundred people from the audience are shot in their waiting lines in front of the theatre and the video is replayed on the screen in their turn. Extremely high-resolution images make it possible for everyone to find his or her face on the screen. This demonstrates its electronic feature.

#### 5 Conclusions

The exhibition of an extremely high-resolution audio-visual system comprising  $8k \times 4k$ -pixel video and 22.2 multichannel audio at the World Expo 2005, is an example of expanded hierarchy of LSDI systems. World expositions are called the showcases of the future. Television appeared firstly at the New York Expo in 1939, and HDTV was exhibited on a large-scale at the Tsukuba Expo in 1985. The exhibition of “Super Hi-Vision” this time is also a debut for just-born technology, as the past shows. Although there were a lot of technical challenges to be solved, it is great progress that the actually working system is exhibited to the general public for half a year. It is expected that quite a few people will recognize its potential and R&D will be further accelerated.

## Part 2

### LSDI Implementations

#### Table of Contents

	<i>Page</i>
<b>Chapter 1 – America</b> .....	76
1 Introduction .....	76
2 LSDI projector.....	76
3 Implementations .....	77
3.1 Alternative programming.....	77
3.1.1 Distribution of alternative programming through digital networks .....	77
3.1.2 Emerging Pictures Inc.....	78
3.1.3 Broadway Worldwide Inc. ....	78
3.1.4 INHD network.....	78
3.1.5 Vyvx Corporation .....	78
3.1.6 HDNET and HDNET films.....	79
3.1.7 YES .....	79
3.1.8 HDVision Studios .....	79
3.1.9 CineMuse Inc. ....	79
3.1.10 Kinocast .....	79
3.1.11 Rain Network .....	79
3.1.12 Ex-Centris .....	79
3.1.13 CBC/Radio-Canada.....	80
3.1.14 Electronic LSDI festivals.....	80
3.2 Use of LSDI in independent production and distribution.....	80
3.3 HD content production in the broadcast environment.....	80
4 HDTV programmes produced for major television networks with potential for LSDI applications.....	83
5 HDTV formats distributed by broadcast networks in prime time .....	84
6 HDTV programming broadcast by cable networks.....	85
7 HDTV programming distributed by MSOs and DBS .....	85
8 Summary.....	85
<b>Chapter 2 – Asia</b> .....	86
1 Introduction .....	86
2 LSDI implementation and application in Japan .....	86
2.1 Activities of theatre companies related to LSDI in Japan .....	86
2.1.1 T JOY.....	86
2.1.2 Other cinema chains.....	88

2.2	LSDI alternative content in Japan.....	88
2.2.1	Live concert “Dear Beatles 2003” .....	88
2.2.2	Curtain speech at the preview party .....	88
2.2.3	Stage play .....	89
2.3	Theatre’s comment on LSDI .....	89
3	Voluntary organizations related to 4k format digital cinema in Japan.....	90
3.1	Objectives .....	90
3.2	Activities.....	91
3.3	Future development of LSDI application .....	92
4	LSDI implementation in Asia.....	93
5	LSDI implementation and application in Singapore .....	93
5.1	Key developments of LSDI in Singapore.....	94
5.1.1	First “live” alternative content transmission in September 2003.....	94
5.1.2	Cross-border digital distribution of Infernal Affairs III in December 2003 .....	94
5.1.3	World’s first 2k-digital multiplex deployment in March 2004.....	94
5.1.4	Digital subtitling and watermarking capability.....	95
5.1.5	Cross-Continent Digital Content Transmission (CCTx project).....	95
5.2	Alternative content in Singapore .....	95
6	LSDI in India and China .....	95
6.1	India .....	96
6.2	China.....	96
7	Summary.....	96
<b>Chapter 3 – Europe.....</b>		<b>103</b>
1	Introduction .....	103
1.1	List of projects and their implementation in Europe .....	103
1.1.1	Arcadia (Italy) .....	103
1.1.2	CityScreens (UK) .....	103
1.1.3	Digital Cinema European Network (DCEN) – European project.....	103
1.1.4	CinemaNet (former EuroDocuZone) .....	103
1.1.5	E-Screen (European project).....	104
1.1.6	Euro1080.....	104
1.1.7	Folkets Hus och Parker – Digitala Hus (Sweden).....	104
1.1.8	Kinopolis (Belgium).....	104
1.1.9	Novocine (France).....	104
1.1.10	Orpheus (European project) .....	104
1.1.11	UK Film Council – Digital Screen Network (UK) Art Alliance .....	105
1.1.12	XDC EVS (Belgium) .....	105
1.1.13	I-DIFF .....	105

## **Chapter 1 of Part 2**

### **America**

#### **1 Introduction**

Chapter 1 includes available information on the status of implementations of LSDI applications and future LSDI trends in North and South America as available to Radiocommunication SG 6 until 2005.

The migration of digital technologies into the cinema theatres has created opportunities for new audio and visual content to be presented on these large screens, as well as large screens installed in other large audience venues. Historically, cinema theatres have been used mostly for the presentation of feature films and made use of film projectors. Since only film could be presented and film projectors cannot display in real-time, the type of content and the extent of usage of the venues was limited.

The continuing development and implementation of high-definition television (HDTV) content and equipment, as part of new terrestrial digital television (DTV) services, as well as on cable-TV networks and satellite delivery to homes (DBS/DTH) services in North America, coupled with the possibility to display HDTV on large screen, the increasing availability of high resolution, high-contrast, and high-brightness digital projectors, enables several applications of LSDI.

This digital technology is changing the nature of theatre content and that of other large audience venues. LSDI permits the presentation of new types of content unavailable until recently to cinema theatre audiences. Sports, concerts, dramas, plays, documentaries, cultural, educational, and industrial events can now be presented to cinema theatre audiences alongside traditional feature films. Audiences in many other indoor and outdoor venues can also have access to high quality digital audio and video large screen content. This also permits the owners and operators of cinema theatres and other large audience venues where large screens are installed, to better leverage their assets, increase their revenues, by presenting alternative content when their facilities are not being used for traditional feature films. Finally LSDI, represent a new content and delivery platforms for broadcast content.

Moreover, LSDI may be implemented in digital systems from standard definition to high definition in a theatre or any type of group audience, from a village hall, local club, university auditoria, schools, church halls, or a sports stadium.

In North America, LSDI is spreading at a rapid pace and as of now, there are over 9 000 LSDI theatre screens in daily operation with more being planned and installed this year. As outlined below, LSDI is a reality in North America.

#### **2 LSDI projector**

The development of electronic video projectors intended for large theatre sized screens, with high brightness, high contrast, was the fundamental technology enabling LSDI implementation. In addition, the possibility to distribute, receive, store and play out high-resolution video in these theatres, coupled with HDTV programme content and supporting delivery systems, opens a new era for theatre audiences, bringing a plethora of new content to them.

LSDI projectors are available to provide on large, theatre-sized screens the full HDTV experience and its overall quality of spatial and temporal resolution, brightness, contrast, colorimetry and stability, matching and exceeding the quality requirements of the human visual system, in the

cinema theatres of today. LSDI projectors are now available to provide the “full-spec” HDTV experience of 1 920/1 080/16:9/24p, 30p, 50i&p, 60i&p on large theatre-sized screens from at least three manufacturers, such as: JVC, Sony and Barco. This advance removes the last barrier to providing the viewer with a picture definition, which matches the visual acuity of the eye.

### **3 Implementations**

The following examples of LSDI implementation serve to indicate the rapid growth of LSDI and the variety of LSDI applications in North America.

#### **3.1 Alternative programming**

##### **3.1.1 Distribution of alternative programming through digital networks**

In 2003, the three largest cinema theatre chains in the USA designed, tested, and started operation of sophisticated digital networks capable of distributing alternative programming to multiple theatres, using large screen digital imaging.

Regal CineMedia, driven by the mission to enhance the movie-going experience, has installed and operates over 5 600 digital screens in 440 locations as of March 2005, with content distributed using both satellite and terrestrial technologies.

In 2003, at Regal CineMedia alone, over 43 000 network hours were presented on the large digital screens in both SDTV and HDTV formats, a volume already exceeded in 2004. In 2004, 43 000 “Special Event” hours were presented on the big screen, with the live events being produced in 1 920/1 080 high definition. Furthermore, in 2004, a total of five live musical concerts have been presented. Three of the concerts, “*Phish*”, “*Jimmy Buffett*”, and “*Prince*”, were played to full houses in the major cities. Eight other pre-recorded concerts were also distributed to the theatre network. Other concerts, by the Rolling Stones, Kiss, Meat Loaf, Yes, Linkin Park, Sheryle Crowe, Third Day, and Tom Petty were also presented. On a more educational note, Virtual Interactive Classrooms has been presented by film director James Cameron.

AMC Theatres, which is the second largest theatre chain, has also increased the number of LSDI venues to 3 900, and continues to expand.

The Digital Content Network (DCN) system employs multicast technology over satellite with traditional carrier transport technologies to create an asymmetrical full duplex network that offers fault tolerant fully diverse routing. The DCN interconnects 430 theatres and 5 300 screens, delivering a network reliability of 99.99%.

The Digital Content System (DCS) automatically acquires, schedules, plays back, and reconciles digital media shorts and advertisements, and supports a variety of source materials in multiple video and audio formats. Source content is often repurposed in the form of digital media in either standard definition or high-definition formats, and is encoded, colour-corrected, audio enhanced and uploaded into the DCN system for theatre distribution and playback.

In conclusion, taking Regal, AMC and Century Theatres together, at the end of 2004, there were about 10 000 LSDI digital projectors installed in USA alone, providing a wide range of alternative programming, screened when the main feature movie is not playing. This programming content may include sporting events, musical concerts, documentaries, educational, and cultural material, together with advertising and local events. If required, these programmes may be shown live.

### 3.1.2 Emerging Pictures Inc.

Barry Rebo, a pioneer in commercial high-definition production, now specializes in documentary and independent feature film production, all produced in 1 920/1 080 HD, and exhibited at theatres with LSDI facilities in the United States of America and overseas.

His recent releases include:

*Ballad of Bering Strait* – Nominated for Emmy Award, 2004, and best Director, documentaries.

*This Old Cub*

*Killing Time* – presented at Sundance Film Festival.

*Home of the Brave* – presented at Sundance Film Festival.  
Winner at Maine Film Festival.  
Winner at Cleveland Film Festival.

*Collateral Damages*

*A Tale of Two Pizzas*

*Twelve.*

### 3.1.3 Broadway Worldwide Inc.

Broadway Worldwide produces HDTV recordings of live Broadway musicals, often with the original casts, plus musical concerts in the New York area. These HDTV productions are adapted for LSDI and are distributed to LSDI theatres and venues throughout the United States of America and abroad, thus enabling people unable to attend concerts at the Broadway Theatre in person, to enjoy them in their hometown theatres. In a recent survey of 5 500 people attending Broadway Worldwide presentations of a Broadway musical and a John Lennon concert, it was estimated that the audiences were comprised of 11% of people over 50 years of age, 19% between 25-49 years, and 70% under 24 years of age. From these observations, Broadway Worldwide concludes that there is an excellent LSDI market for Broadway musicals and concerts throughout the world.

During the 12 months previous to March 2005, three new recordings of Broadway musical shows were made: “Jekyll and Hyde”, “Smoky Joe’s Café”, and Steven Sondheim’s “Putting it Together”. These HDTV recordings of live shows on stage are distributed to over 100 LSDI theatres and venues across the United States of America, and a similar number in Europe.

The growing library of Broadway productions is proving attractive to overseas theatres with LSDI facilities for theatrical projection. These include screens in Asia, 11 in South America, and 48 in Europe and the Middle East. All venues are capable of presenting the full 1 920/1 080 HD format.

### 3.1.4 INHD network

INHD is an HDTV network engaged in restoring archival films of 16 summer and Winter Olympic events since 1948 and transferring them to digital HDTV. These programmes can then be available to LSDI venues and audiences with an interest in the history of the Olympic games.

### 3.1.5 Vyvx Corporation

Vyvx is completing a fibre-optic network, HDVenueNET, connecting 17 sport stadiums in eight United States of America cities. The network will be used to cover sporting events in such stadiums and provide real-time HDTV programmes to other venues on the network together with recorded programmes that can be delivered to other LSDI venues.



### 3.1.6 HDNET and HDNET films

HDNET and HDNET films produce documentaries, specialty, and independent film programmes, together with sports events, for distribution to specialty theatres and other LSDI type venues. This operation also provides a distribution outlet for low-budget films presented at film festivals, where such films are increasingly being presented in digital HDTV, and are thus ready for LSDI distribution.

### 3.1.7 YES

The rock band YES distributed a documentary of their work, coupled with a live acoustic performance to Regal Entertainment Group theatres across the country, effectively promoting the release of their latest DVD on the following day.

### 3.1.8 HDVision Studios

HDVision covers live musical concerts and local sporting events, and distributes them in real-time via fibre optic network to a number of cities in theatres and other small venues. One of the first to apply LSDI technology to reach a wider audience, HDVision, has completed over 1 000 programmes in HDTV, ranging from features, documentaries and music videos to commercials, corporate presentations, and product launches, using LSDI technology to reach a broad audience spectrum.

### 3.1.9 CineMuse Inc.

CineMuse Inc. works with museums across North America to install digital HDTV – LSDI equipment to develop targeted programming for screening in the LSDI equipped museums, thus enriching the museum experience for visitors.

### 3.1.10 Kinocast

Today, Brazil has the largest network of LSDI venues in South America. The satellite network operator Kinocast delivers digital HDTV content, and controls the projection and timing remotely for over 100 LSDI venues.

### 3.1.11 Rain Network

The Rain Network in Peru feeds 100 small cinemas and “Art Houses” equipped with LSDI projection facilities, reportedly at a cost of 50 thousand US dollars per installation, and the network is growing.

### 3.1.12 Ex-Centris

The Montreal based company (<http://www.ex-centris.com>), is a state-of-the art multi-theatre and production facility designed to evolve with the emergence of new digital production technologies. Ex-Centris offers in its movie theatres a combination of all the best projection (high quality film and electronic HD video projectors) and sound capabilities available in currently theatres settings. It is an *avant-garde* complex dedicated to the support of independent creators and producers involved in the experimenting with the new generation of cinema-to-graphics tools. Ex-Centris is a blend between a high quality cinema venue and image research laboratories

Ex-Centris uses multiple video formats including SDTV and HDTV. Ex-Centris continues to innovate and exhibit in its facilities alternative content, including HDTV, and is actively looking for other properties such as those envisaged for LSDI. More detailed information will be available later.

### **3.1.13 CBC/Radio-Canada**

The CBC/Radio-Canada will be producing a new series, “The People’s History of Hockey”. This series will be produced in HD using a production model similar to the successful “People’s History of Canada” series, using resources of both the English and French television networks.

The CBC/Radio-Canada Documentary unit has been commissioned to produce in the 1 080i format, a series of 10 one-hour documentaries entitled “The People’s History of Hockey”.

Most of the series will be produced in Toronto but a Montreal unit has been created to provide the production elements necessary to ensure that it has the credibility it seeks with French-speaking viewers across Canada. This could include the entire production of an hour or two of the series. Audio post on the French versions will also be done in Montreal.

All programming will be produced in both languages and there is expected to be a heavy emphasis on other products including DVDs and potentially LSDI. Given the nature of the production and its expected very long shelf life there is a strong desire to produce the series in HD.

Production of the series will occur between Summer 2004 and Winter 2005 with a planned telecast window in January 2006.

### **3.1.14 Electronic LSDI festivals**

Formally known as “film festivals”, the growing demand for a lower cost production medium that matched or exceeded the quality of film production has enabled producers of relatively low budget independent “films” to achieve their goals through the implementation of LSDI. Typically, these producers achieve recognition by screening their work at the many and growing number of film festivals, whether local or international in scope. In 2004, a majority of festival contributions in several categories were produced in 1 920/1 080 HD formats, and displayed on the screen by LSDI projectors. At the recent leading International Sundance Film Festival, 75% of all entries were screened using LSDI.

## **3.2 Use of LSDI in independent production and distribution**

A small but growing number of independent production studios both produce and distribute their programmes using LSDI. HDStudios of Los Angeles is a pioneer in this work. Typically, a live musical concert with a live audience is recorded in the 1 920/1 080 HD format. Using an ad hoc fibre optic distribution network, the performance is distributed live to some 27 theatres across the United States of America, each equipped with an LSDI projector. The programme may be enhanced by the addition of pre-recorded interviews with the artists. The complete recorded programme may be played back at later times, adjusting for time zones, or for multiple sequential presentations in large cities. A recent such event was the “Grateful Dead Movie”, where tickets were sold out in three of the larger cities where it was screened.

## **3.3 HD content production in the broadcast environment**

The transition to HDTV programme production for the US television networks results in the availability of many potential repurposed HD programmes for LSDI applications. Of the 95 television series currently in production, 38% are produced electronically mostly in the HDTV format of 1 920/1 080, the Recommendation ITU-R BT.709. A number of the “Award” shows and “Specials” are also produced in this format, including the MTV Music Awards and the Victoria’s Secret Special. Not only were the 2003 and 2004 Grammy Awards covered in HDTV, but the production also provided 5.1-channel surround sound with over 800 individual audio sources.

From a motion picture production viewpoint, many studios have embraced 1 920/1 080 HD production format. A notable high profile example is George Lucas' "Star Ward Episode II: Attack of the Clones". This movie and the subsequent "Episode III" were produced entirely electronically using the 1 920/1 080/24p format with no film being used.

In 2004 to March 2005, 45 motion pictures have been produced electronically, mostly employing the HD 1 920/1 080/24p format.

The titles include:

*Ali, Bowling for Columbine, The Company, Ghosts of the Abyss, How High, Lovely and Amazing, Masked and Anonymous, The Matrix-3, Once Upon a Time in Mexico, Simone, Spy Kids-3, Starship Troopers.*

For programmes captured on film, in almost every case, the prime original film negative is transferred to a digital high-definition format on videotape, and all post-production and colour correction is effected in the digital domain, resulting in a finished master in the high-definition 1 920/1 080 format, ready for broadcast, satellite, or cable transmission.

If the programme is to be exhibited in a film projection cinema, the master is transferred back to 35 mm film for distribution.

Sports coverage is much enhanced by the application of HDTV and may become an LSDI source. As one example, CBS has been actively producing and broadcasting sports in HDTV for five years, and has covered the US Open Tennis Tournament, the Masters Golf Tournament and the NCAA final four playoffs for four years. For the last three years, CBS has covered NCAA football every Saturday, in addition to many post-season professional NFL games and Super Bowl XXXV with the AFC Divisional playoffs this year. Many major sports stadiums are now equipped with large screens, using LSDI technology.

The recent Olympic Games in Athens were recorded on HD in the 1 920/1 080 format by NBC, and distributed to 124 NBC affiliate stations in the United States of America, thus reaching 96% of all US TV households. 28 HD cameras were used to cover the Games, and 8 to 10 cameras covered each venue. One hundred and sixteen hours of HD coverage were provided, covering athletics, gymnastics, swimming, basketball, track and field, and soccer.

NBC also supplied feeds to MSNBC, CNBC, Bravo, Telemundo, and the United States of America cable network, reaching 80 million cable households.

SONY Electronics provided HDCAM cameras, and the events were recorded in 5.1 channels of sound. Because the Games were also recorded in standard definition, a direct comparison showed the superiority of high-definition production for all the sporting events.

The primetime entertainment programmes of the major networks are rapidly converting to HDTV distribution. For example, CBS has, for the past four years, distributed all its scripted primetime entertainment programmes in 1 920/1 080 HD, totalling 16 h/week along with selected "Movies of the Week".

Nearly all the United States of America prime-time situation comedies for network programming are produced in the 1 920/1 080/24p HD format. The efficacy of this procedure is shown in the fact that 23 pilot programmes for the new season were produced in this HD format in just one month at the CBS facility in Los Angeles. This achievement represents 11 1/2 h of programme running time.

The major United States of America broadcast networks are producing and distributing HD programmes, totalling over 60 h/week in prime time. The cable networks are producing programmes in HD and distributing more than 100 h/day. DBS operators are transmitting multiple channels of HD, and doing so for 20 h/day. Thus, consumers have access to over 37 sources of high-definition programming, and a total of over 1 000 h/week of programming from which to

choose. On the national scene, it is estimated that all delivery media together are transmitting over 2 000 h of HD programming weekly. In sum, there is a plenitude of HD programming available for potential LSDI applications.

The Canadian Broadcasting Corporation is a major broadcast content producer and provider. The CBC produces a lot of content, i.e. sporting events, concerts, documentaries, which could lend itself to LSDI. As the CBC begins to produce in HDTV, it will consider LSDI as a potential new delivery platform for some of its content.

Table 15 presents the results obtained from a survey of all the formats used in the production of programmes for United States of America prime time television programmes for broadcast by the six United States of America television networks and by the major cable networks. At this stage only the HD 1 920/1 080 HD format and the 1 280/720p format are considered.

TABLE 15

**Production formats employed for HD and digital broadcasting, cable and DBS**

Category	Program time	Production format			Distribution format	
		Film	1080i/60 or 1080/24p	720p	1080i/60 or 1080/24p	720p
<b>Terrestrial broadcast</b>	<b>Hours/week</b>					
Entertainment	65	37	23	5	50	15
Sports	18		14	4	14	4
Movies	8	8		0	6	2
<b>Terrestrial Total</b>	<b>91</b>	<b>45</b>	<b>37</b>	<b>9</b>	<b>70</b>	<b>21</b>
<b>Cable networks</b>						
Sports	510	37	400	110	400	110
Entertainment	300	90	210	0	300	0
<b>Cable Total</b>	<b>810</b>	<b>90</b>	<b>610</b>	<b>110</b>	<b>700</b>	<b>110</b>
<b>Grand Total</b>	<b>901</b>	<b>135</b>	<b>647</b>	<b>119</b>	<b>770</b>	<b>131</b>
Totals (%)	100	15	72	13	86	14

It is seen that, in a typical week, the programme production format employed are 1 920/1 080 for 72% of the total, 15% for 35-mm film, and 13% for the 1 280/720p format.

The format used for programme distribution was seen to be 86% for the HD 1 080 format and 14% for the 720p format in 2003.

In 2004, the trend toward the production and distribution of programme content in the 1 920/1 080 high-definition format has continued. Table 16 shows that a majority of all the terrestrial broadcasting networks, the cable networks, film studios and satellite distributors, together with independent content providers, distribute their programmes in the 1 920/1 080 HD format. Thus in March 2005, over 86% of all content for broadcast or cable distribution in the evening hours is distributed in the 1 920/1 080 HD format.

TABLE 16

## TV or cable networks

TV and cable network as of March 2005	Distribution format	TV and cable network as of March 2005	Distribution format
ABC Television Network	720p	Playboy Spice Channel	1 080i
CBS Television Network	1 080i	Bravo HD	1 080i
NBC Television Network	1 080i	TNT in HD	1 080i
FOX Television Network	720p	Madison Square Garden (MSG)	1 080i
WB Television Network	1 080i	Comcast SportsNET	1 080i
UPN Television Network	1 080i	The Movie Channel HD	1 080i
PBS Television Network	1 080i	Cinemax HD	1 080i
HBO-HD	1 080i	VOOM Cinema 1-6	1 080i
Sharper Movies HD	1 080i	Discovery HD	1 080i
Showtime HD	1 080i	NBA HD	1 080i
HDNET	1 080i	A&E HD	1 080i
HDNET Movies	1 080i	Turner Entertainment Network	1 080i
Starz HD	1 080i	Encore HD	1 080i
Starz HD Movies On-Demand	1 080i	HDNEWS	1 080i
INHD Movie Network	1 080i	HD Classics	1 080i
INHD2 Movie Network	1 080i	Anamania HD	1 080i
ESPN HD Network	720p	TMC-HD	1 080i
ESPN2 HD Network	720p	HD Epics	1 080i
Fox Sports Network HD	720p	MTV HD (TBA)	1 080i
World Sports Net HD	1 080i	Spike HD (TBA)	1 080i
HGTV-HD	1 080i	HDStudios	1 080i
TMC-HD	1 080i		

#### 4 HDTV programmes produced for major television networks with potential for LSDI applications

<i>Programme</i>	<i>HD Format</i>	<i>Company</i>
ABC 8 Simple Rules	1 080/24p	Touchstone
ABC I'm With Her	1 080/24p	
ABC According to Jim	1 080/24p	Touchstone
ABC Less Than Perfect	1 080/24p	Touchstone
ABC My Wife & Kids	1 080/24p	Touchstone
ABC It's All Relative	1 080/24p	
ABC George Lopez	1 080/24p	Warner Brothers
ABC Hope & Faith	1 080/24p	
ABC Life with Bonnie	1 080/24p	Touchstone
CBS Yes Dear	1 080/24p	20th Century Fox

<i>Programme</i>	<i>HD Format</i>	<i>Company</i>
CBS Still Standing	1 080/24p	20th Century Fox
CBS Becker	1 080/24p	
CBS Joan of Arcadia	1 080/24p	
CBS Hack	1 080i/35 mm	Paramount
FOX One Minute w/Hooper	1 080/24p	
FOX Wanda at Large	1 080/24p	
FOX Luis	1 080/24p	
FOX Oliver Beene	1 080/24p	20th Century Fox
FOX Bernie Mac Show	1 080/24p	Regency
NBC Whoopi	1 080/24p	
NBC Happy Family	1 080/24p	
NBC American Dreams	1 080/24p	
UPN The Parkers	1 080/24p	Paramount
UPN Girlfriends	1 080/24p	Paramount
UPN Half & Half	1 080/24p	CBS Productions
UPN One on One	1 080/24p	Paramount
UPN All of Us	1 080/24p	
UPN Rock Me Baby	1 080/24p	
UPN Enterprise	1 080/24p	
WB Angel	1 080/24p	
WB What I Like About You	1 080/24p	Tollins/Robbins Prod.
WB Reba	1 080/24p	
WB Like Family	1 080/24p	
WB Grounded for Life	1 080/24p	
WB All About the Andersons	1 080/24p	

## 5 HDTV formats distributed by broadcast networks in prime time

<i>Network</i>	<i>Format</i>	<i>Prime time (%)</i>
ABC Scripted Entertainment	720p	100
CBS Scripted Entertainment	1 080i	100
FOX	720p	50
NBC	1 080i	80
PBS Nature Documentaries	1 080i	
Warner Bros	1 080i	65

**6 HDTV programming broadcast by cable networks**

<i>Network</i>	<i>Format</i>	<i>Network time (%)</i>
A&E	1 080i	80
Bravo-HD	1 080i	100
Discovery	1 080i	30
ESPN-HD	1 080i	100
Fox Sports Net – 13 Reg. Ch's	720p	100
HBO – 14 h/Day	1 080i	75
Madison Square Garden	1 080i	100
NBA-HD	1 080i	100
Playboy Spice	1 080i	100
ShowTime Movies	1 080i	80
Starz-HD – 3 New Channels	1 080i	100
Turner I = Entertainment Net	1 080i	100

**7 HDTV programming distributed by MSOs and DBS**

<i>MSO</i>	<i>Format</i>	<i>Volume (h/day)</i>
CableVision: 4.4 million subscribers	1 080i	20
ComCast Sports 23 markets that reach 65% of subscribers	1 080i	20
Time-Warner: Reaches 93% of subscribers	1 080i	14
<i>DBS Distribution</i>		
DirectTV: 39 HD channels	1 080i	14
HDNet	1 080i	24

**8 Summary**

From the examples reported above, it is concluded that the implementation of LSDI technology is beginning to bring a wide variety of programming not heretofore accessible to theatre audiences in North America, and that the growth of digital HD production promises to provide significant quantities of LSDI programming.

## Chapter 2 of Part 2

### Asia

#### 1 Introduction

This Chapter introduces the progress of LSDI implementation and application in Asia and Oceania. Countries where LSDI equipment has been already implemented are Australia, China, India, Japan, Singapore, South Korea and Thailand according to the website of DcinemaToday.com (<http://www.dcinematoday.com>). This website also reports that India has 101 so-called “E-Cinema screens” and China has 93 so-called “E-Cinema screens”. The rapid and widespread diffusion of LSDI equipment has already started in China and Singapore, but a slower penetration continues in other Asian countries. LSDI equipment may have been implemented in facilities other than cinema theatres (e.g. public halls), but such a case seems to be very rare at this moment.

LSDI applications as alternative content for LSDI venues, in Japan and Singapore are also described. Two types of content, namely “live content” such as “sports or music concerts” and “packaged content” such as “stage plays or traditional performing arts” are being recognized as a new style of entertainment different from the present cinema, concert or stage play.

In addition, the objectives and activities of two organizations in Japan are reported, which started demonstration of prototype 4k format system in 2001, and have been playing an active role in promoting global diffusion of so-called 4k format digital cinema.

#### 2 LSDI implementation and application in Japan

The status of the implementation of LSDI and some LSDI related applications as of February 2006 in Japan is reported. As shown in Table 17, Japan has 46 LSDI screens, and so-called 2k projectors are installed in 27 of the above-mentioned 41 venues. The number of LSDI screens has been increasing not rapidly but steadily.

The following digital cinemas were provided with LSDI screens and projectors as of March 2005 in Japan (list not exhaustive):

*Toy Story 2, Mission to Mars, Dinosaur, 102, Fire Fly, The Emperor’s New Groove, Sprit Away, Final Fantasy, Masked Rider, Atlantis, Thousand Years of Love, Monsters Inc, Rush into Lodge Asama, Star Wars Episode 2, Ice Age, Ping Pong, Harry Potter, Peter Pan 2, Lilo & Stitch, Makai Tenshou, Pirates of Caribbean, Finding Nemo, Legend of Mexico, Brother Bear, Haunted Mansion, The Day after Tomorrow, I-robot, Oceans 12, Incredible, Howl’s Moving Castle.*

##### 2.1 Activities of theatre companies related to LSDI in Japan

###### 2.1.1 T JOY

The TOEI GROUP and other Japanese main cinema distributors established this company in 2000, with the target of new imagery business based on the implementation of a network of cinema complexes all over Japan making use of a dedicated distribution system. Each complex is equipped with at least one LSDI screen. The company has realized many LSDI applications fully achieving its business targets.



The development of the activities of the company since its establishment is as follows:

- 2000/5 LSDI satellite distribution experiment at Marunouchi TOEI theatre.
- 2000/12 The first business basis LSDI show-contents on screen distributed via satellite.
- 2000/12 T JOY Higashi-Hiroshima was opened as the first cinema complex with LSDI facility. *“Dinosaur”* was played on LSDI.
- 2001/3 In the activity of Fuji Television, the curtain speech by main actors and actresses of *“Shonen H seishun-hen”* and the preview show of this content were transmitted live via satellite and showed at T JOY Higashi-Hiroshima.
- 2001/7 T JOY Niigata-Bandai was opened with LSDI facility. The curtain speech of *“Red Shadow”* at Tokyo Marunouchi Toei cinema theatre was transmitted live via satellite to T JOY Niigata-Bandai and T JOY Higashi-Hiroshima.
- 2001/12 T JOY Ooizumi was opened. This theatre can operate up to five LSDI screens.
- 2002/4 T JOY Joypark Place Oh-ita was opened.
- 2002/4 Umeda Buruku 7 was opened, jointly established by T JOY and Shochiku.
- 2002/6 *“Star Wars Episode II”* was distributed to all T JOY theatres via satellite.
- 2002/8 T JOY Ooizumi and Umeda Buruku 7 equipped new facility and started operation of two screens of LSDI. *“Ice Age”* and *“Star Wars Episode II”* were played on LSDI.
- 2002/11 *“Harry Potter and The Chamber of Secrets”* (Japanese dub) was distributed to all T JOY theatres via satellite.
- 2003/3 Sapporo Cinema Frontier was opened and was jointly set up by T JOY, Toho and Shochiku. This theatre has two LSDI screens.
- 2003/3 Live concert of *“Dear BEATLES 2003”* was showed live at Sapporo Cinema Frontier on LSDI. It was a live event held in Tokyo, and was transmitted in HDTV format via satellite.
- 2003/4 T JOY Riverwalk Kita-Kyushu was opened. with two LSDI screens.
- 2004/3 Hiroshima WALD 11 was opened. It is jointly operated by T JOY and Toho, and has 2 LSDI screens and equipped 2k projectors.
- 2004/9 Kagoshima Mitte 10 was opened.
- 2004/9 *“Seven souls in the skull castle AKA-DOKURO”* was played as the first digital entertainment content of T JOY. This content was produced by recording a new type of straight play in 1 080/24p format, and gained some popularity. This type of alternative content seemed to be promising approach.
- 2005/3 *“Seven souls in the skull castle AO-DOKURO”* has been played as the second programme of this series at the all T JOYs. This content has gained high popularity.

Figure 49 shows the T JOY distribution network.

Encrypted content for LSDI is distributed as a file into the storage server of each theatre via satellite, and the key information for decryption can be got from the key server through the different path.

FIGURE 49  
Distribution network for LSDI content

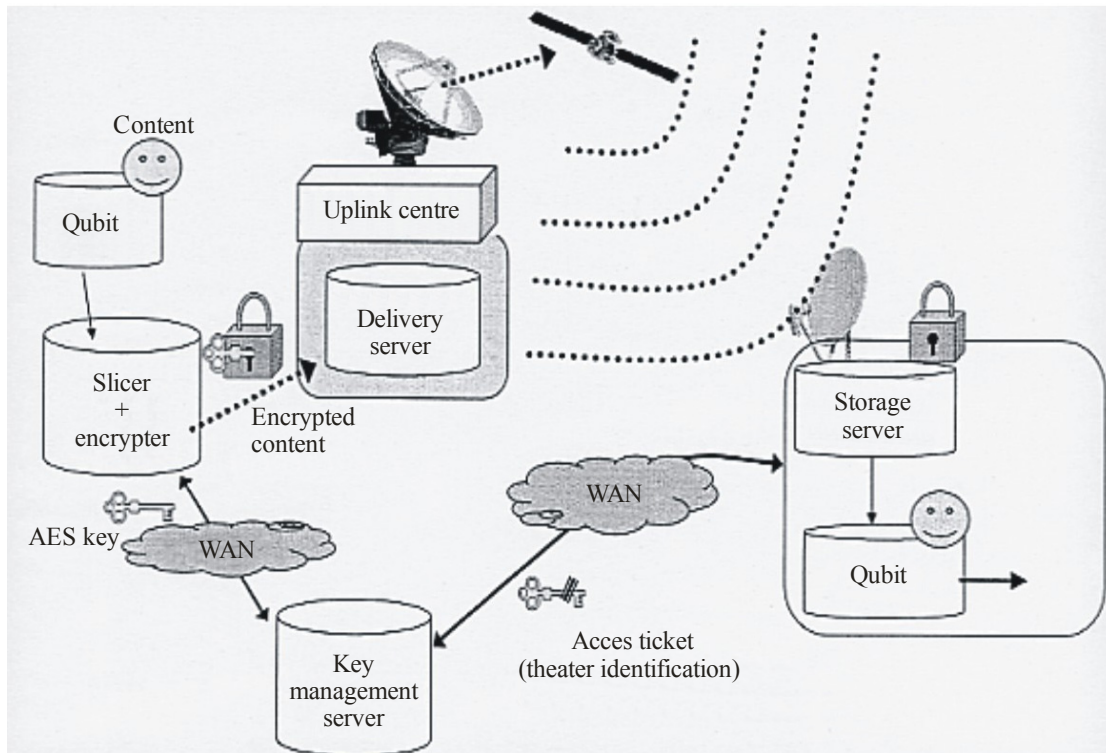

Rep 2053-49

### 2.1.2 Other cinema chains

In addition to T JOY, other cinema theatre chains are active, among which: “109 Cinemas” with ten screens capable of projecting LSDI content, “TOHO” with four screens, “Shochiku Multiplex Theatres” with four screens, “XYZ Cinemas” with two screens, AMC Entertainment with one screen at Tokyo Disney Resort, “Keisei Rosa 10” with one screen, “Cineplex Herald” with one screen, “Sapporo Cinema Frontier” with two screens, “Toei” with one screen and “Warner Mycal Cinemas” with one screen.

## 2.2 LSDI alternative content in Japan

### 2.2.1 Live concert “Dear Beatles 2003”

T JOY realized the first concert live show event in March of 2003 at Sapporo Cinema Frontier, which is jointly operated by Toho, Shochiku and Toei. The live concert was held in Tokyo. The video and sound of the live event were transmitted via satellite to Sapporo theatre site in Hokkaido where 250 viewers were present. In this concert, many Japanese musicians played BEATLES tunes at Tokyo Fuchu-no-mori art theatre hall. According to the result of website questionnaire, the audience was surprised at the clearness of LSDI presentation that showed players’ expression and even other small details around the stage. They could also have the sense of togetherness with people in the concert hall. For people who could not go to the concert site, it was a very attractive application. T JOY considered stage plays, sport games and other live events to be promising as alternative content for theatres capable of projecting LSDI content.

### 2.2.2 Curtain speech at the preview party

T JOY realized other types of live events such as sports games, concert, musicals and plays, which confirmed their technical feasibility as alternative contents for LSDI venues. However, in Japan

these alternative contents, based on live transmission via satellite or optical fibre network, seem presently not so attractive from the viewpoint of business, due to the high costs associated to production, transmission, copyright and advertisement, when compared to the number of available seats in LSDI venues. In addition, these live contents can be shown only once since the audience in LSDI venues want to have the sense of togetherness with the viewers in the location of live event.

At present, the only promising application of using live transmission is “curtain speech at the preview party”, whose production and transmission costs need in any case to be born by cinema distributing companies. In this case live transmission to LSDI venues can easily cover the additional cost, and the audiences in LSDI venues can enjoy curtain speech as an additional service.

The scale of networked LSDI venues is very important in making the best use of the advantages of LSDI, that is, live alternative content may not be business attractive in a small-scale development.

### 2.2.3 Stage play

An alternative content not depending on the time of performance seems to be more business attractive since it can be projected onto LSDI screens many times without transmission cost. This type of content may be the same as digital cinema from technical aspect, but it has different meaning in cultural aspect. Potential audience may have difficulties in viewing directly stage due to the ticket cost and/or geographic or time constraints. This application is very promising not only because people in urban or local area can enjoy stage plays in LSDI venues with a high level of satisfaction but also because it can expand the fan base for stage plays. There is a so-called “Win-Win” relationship between LSDI content and stage plays.

The followings are examples in this type of alternative content in Japan:

“*Seven souls in the skull castle AKA-DOKURO*” was produced in 1 080/24p format and it was successfully shown at six T JOY cinema theatres in September 2004.

“*Seven souls in the skull castle AO-DOKURO*” was played as the second programme of this series at the all T JOYs in March and April 2005, gaining high popularity and business success.

Shochiku, another cinema theatre chain, showed the traditional performing arts of Kabuki play on LSDI screen in 1 080/24p format. This is called “Cinema Kabuki” and is recognized as a new style of entertainment, different from cinema or stage play.

## 2.3 Theatre’s comment on LSDI

The penetration of LSDI facilities in Japan is not fast but has been continuing steadily.

In the content production process, digital technology is already popular in production companies. But, in most cases, the distribution media is film because most theatres are still using film projectors. Theatre owners in Japan are fully aware of the advantages of introducing LSDI equipment, among which:

- better picture quality and sound quality;
- new services such as the live link to the concert hall or sport stadium via satellite/optical fibre networks;
- easier distribution of content media without the cost of duplicating films for each location;
- showing with/without subtitle;
- choice of original language/Japanese;
- easier operation, including automatic play and stop;
- multipurpose usage as a symposium hall or a lecture room.

However they also think that it might be premature to introduce LSDI equipment presently, since:

- LSDI equipment may be obsolete or unavailable for not complying with standardized specifications (see especially the so-called 2k/4k issue or copyright protection method);
- not many contents may presently be distributed in LSDI format, and so that it may be necessary to implement both film projectors and DLP projectors for a given screen;
- high initial costs, since a DLP projector is about three or four times more expensive than a film projector. In addition, transmission equipment such as CS antenna or optical fibre network may be necessary;
- power consumption, which is much more than film projector;
- LSDI equipment may significantly improve their luminance performance in the near future;
- some audiences may prefer so-called film tone to video.

Having paid attention to the progress in both the standardization activity and the performance gain of LSDI equipment, they understand that digitalization of cinema theatres is a necessary trend, and that LSDI equipment will sooner or later be implemented in all theatres. They also think that the so-called 4k-system may be best option when implementing LSDI equipment. On the other hand, they put an emphasis on the timing of implementation LSDI equipment and the consequent return on investment. For instance, even if 4k-system becomes available, its immediate implementation would be economically difficult for those theatre owners, which have already implemented the so-called 2k- or 1.3K-system.

### **3 Voluntary organizations related to 4k format digital cinema in Japan**

There are some voluntary organizations that have been playing an active role in supporting and promoting so-called 4k format digital cinema. Two voluntary organizations, that is Digital Cinema Consortium of Japan (DCCJ) and Digital Cinema Technology Forum (DCTF) are described below. These have been mutually cooperating and seem to have influenced adoption of 4k-format digital cinema by Digital Cinema Initiatives (DCI), LLC.

#### **3.1 Objectives**

##### **DCCJ**

This organization was established in 2001 as voluntary association of dues-paying members, and was formally incorporated as a Non-Profit Organization (NPO) in May 2002. The Chairman is Dr Tomonori Aoyama, Professor of the University of Tokyo.

The objective is to promote advancement in culture and art through the development, test, evaluation and standardization of very high quality digital cinema formats and related infrastructure. Concrete goals are as follows:

- Gather and disseminate information on development of D-Cinema to encourage its use.
- Liaison with organizations inside and outside of Japan to assist the establishment of global standards for digital cinema.
- Support the making, distribution and presentation of digital cinema to promote better understanding of the technology and creative capabilities.

##### **DCTF**

This organization was established in May 2004 with the cooperation of the Ministry of Internal Affairs and Communication (MIC). The Chairman is Dr. Tomonori Aoyama, Professor of the University of Tokyo.

The objective is to achieve the early realization and penetration of digital cinema through the following activities:

- Support development of fundamental technologies for networked distribution of digital cinema.
- Support experiments and tests to advance understanding of the techniques for distribution, image quality evaluation and security of digital cinema based on the so-called “4k” format with the support of all Japanese stake-holders from production to distribution to exhibition.
- Promote relations with similar organizations in America, Europe and Asia to foster the development of digital cinema and global standardization.
- Conduct surveys to understand requirements for early deployment.
- Sponsor events, demonstrations and symposia related to the technology and usage of digital cinema.

### 3.2 Activities

The following are activities that these organizations have carried out to achieve the objectives. Through these activities, the 4k-format digital cinema is well known worldwide.

#### 2001

- June: DCCJ Digital Cinema Symposium in Tokyo – 1st prototype 4k demo in Japan
- August: NTT demo at SIGGRAPH in LA – 1st prototype 4k demo in the United States of America

#### 2002

- June: DCCJ Digital Cinema Symposium in Tokyo
- June: DCCJ 4k demo at Paramount Theatre in Hollywood
- October: DCCJ 4k demo at ETC in Hollywood
- October: NTT 4k streaming demo from UIC in Chicago to USC in Los Angeles via Internet2

#### 2003

- June: DCCJ Digital Cinema Symposium in Tokyo
- June: DCCJ 4k demo at EDCF Digital Test-bed in London – 1st 4k demo in Europe
- July: DCCJ 4k demo at Cinecitta in Rome – 1st 4k demo in Italy

#### 2004

- June: Sony 4k demo at ETC in Hollywood – 1st commercial introduction of 4k projector
- June: DCCJ Digital Cinema Symposium in Tokyo – 1st 4k screening of ASC/DCI StEM<sup>27</sup>
- August: IMAGICA10K scanner option for 4k digital cinema introduced at SIGGRAPH in Los Angeles
- October: Tokyo International Film Festival
  - DCTF Digital Cinema Symposium – 1st public event using two different 4k systems
  - NTT Festival Screenings of Shitsurakuen – 1st public screening of 4k digital cinema full-length Japanese feature

---

<sup>27</sup> ASC/DCI StEM: Standard evaluation Material (StEM) file produced by American Society of Cinematographers (ASC) and Digital Cinema Initiatives (DCI).

- November: Japan Society of Cinematographers (JSC) screening at IMAGICA of ASC/DCI StEM<sup>16</sup> at 4k digital side-by-side with 35-mm film answer print, with ASC cooperation

### 3.3 Future development of LSDI application

DCTF supports the view that broadband optical fibre network is one of the most important key elements for development and penetration of LSDI application. They will support research and development on professional digital production and distribution using broadband optical networks.

Figure 50 shows the conceptual diagram of LSDI application through broadband optical network. This figure is drawn based on the following ideas.

- Commercial optical networks in Japan are already capable of reliable store-and-forward file transfer of 4k format digital cinema.
- Broadband infrastructure will enable fast, secure, point-to-point digital cinema distribution to theatres in Japan.
- Digital cinema will stimulate fibre-to-the-theatre (FTTT) in Japan.
- Installation of FTTT and 4k digital projectors will enable new types of alternative content in Japan, such as super high definition (SHD) streaming of live events to digital cinema theatre audiences.
- Digital cinema and alternative content will become important new commercial applications for broadband networks in Japan.
- Conversion to digital cinema in Japan in combination with rich network infrastructure will lead Japanese studios to become more fully integrated entertainment companies.

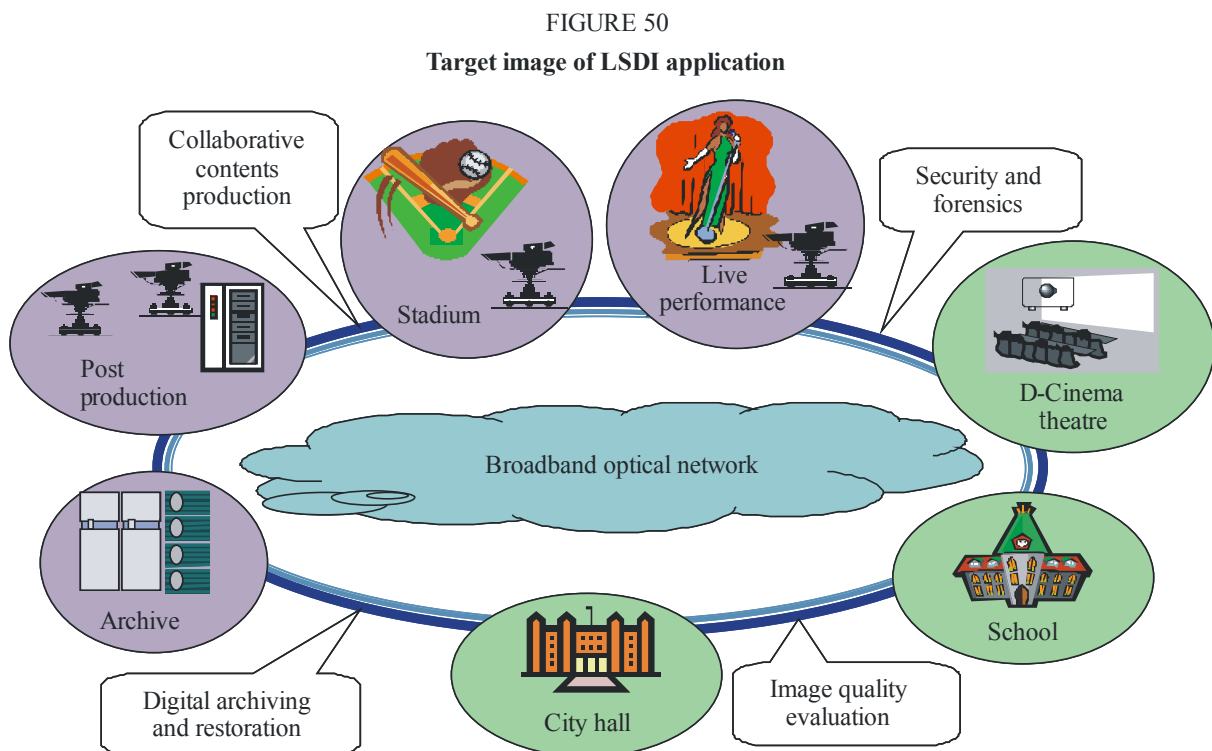

Note 1: This figure is extracted from a document of DCTF.

#### 4 LSDI implementation in Asia

The following information represents data gathered from sources outside of ITU. The classification of projector characteristics may not correspond to the classification defined by ITU. The data is presented in its original form for information only.

The situation regarding implementation of LSDI in Asia as of 7 March, 2006 is reported here. Table 17 shows the information derived from the website of DcinemaToday.com as of 7 March, 2006. (<http://www.dcinematoday.com/dcdb/DCinemas.aspx?app=1&rgn=3&etf1=1,tech,22>)

According to Table 17, there are 3 LSDI screens (D-Cinema quality) in Australia, 99 in China (94 in main land plus 5 in Taiwan), 2 in India, 46 in Japan, 43 in Korea, 24 in Singapore and 5 in Thailand. Within these numbers of LSDI screen, 2k projectors are installed to 1 screen in Australia, 32 in China, 2 in India, 27 in Japan, 39 in Korea, 24 in Singapore and 4 in Thailand, respectively.

The number of LSDI screens (D-Cinema quality) and 2k projectors of Asian countries are shown in Fig. 51, including the information of Germany, UK and USA as reference.

It is also indicated on this website that India has 101 “so-called E-Cinema screens” and China has 93 E-screens, presumably with a little lower quality than a DLP projector.

In any case, China is the country that has implemented the maximum number of LSDI equipment in Asia. This fast penetration has been supported by high-level government commitment and funding.

FIGURE 51  
Number of LSDI screens

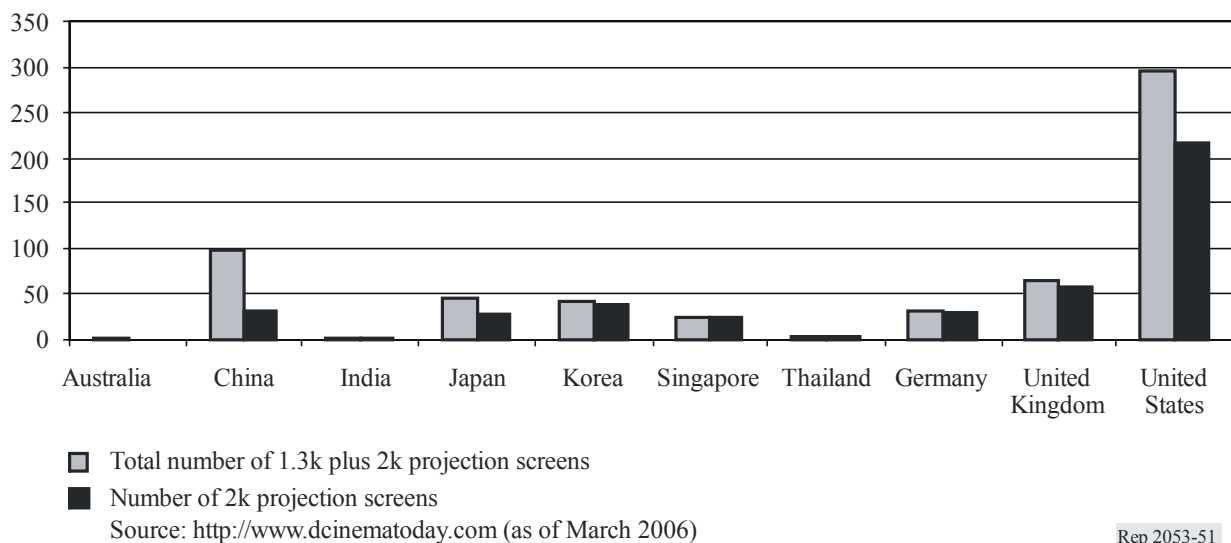

Rep 2053-51

#### 5 LSDI implementation and application in Singapore

Notwithstanding its small geographical extension, Singapore is a country where LSDI equipment has already been in widespread use all over the country. Due to the recent rapid diffusion of equipment capable of displaying LSDI content in European countries and the United States of America, the figures related to Singapore do not appear outstanding as shown in Fig. 51. However, with 22 digital cinema screens, Singapore had the 4th highest number of digital cinema screens deployed in commercial theatres, after the United States, China and Japan. Singapore also had almost the same number of 2k commercial theatre screens as China, Japan and the United States as at August 2005.

The Infocomm Development Authority of Singapore (IDA), government-affiliated organization, has been playing an important role in developing LSDI industry. IDA's Digital Exchange for digital cinema aims to position Singapore as a global hub to process, manage and distribute movies and other forms of digital content.

Digital cinema brings about potential cost savings in distribution allowing greater flexibility for exhibitors in the areas of cinema advertising and content programming. Exhibitors can now offer air-time at multiple locations without having to incur the cost of duplicating films for each location. This also allows other forms of pre-show content such as music videos and public educational advertisements to be screened at any cinema theatres anytime.

As of 2004, two major theatre chains have converted to 2k DLP Cinema™ projection and server technology at their cinema complexes, and screened more than 15 digital movies and alternative programming in total. Value-added services such as digital subtitling, digital watermarking, and secured digital distribution of content are also being provided through established service providers.

## **5.1 Key developments of LSDI in Singapore**

### **5.1.1 First “live” alternative content transmission in September 2003**

Cathay Cineplexes owns and operates more than 30 screens in Singapore and Malaysia, including Cathay Orchard Cineplex. ST Teleport is a full-service satellite communications solution provider with a diverse network of major satellite systems, terrestrial network infrastructures and internet exchanges.

David Bowie's “*Reality*” concert at Cathay Orchard Cineplex marked the first alternative content screening in Singapore. The concert was live transmitted to cinema theatres in Singapore and Hong Kong via satellite by ST Teleport. The concert also featured a Q&A segment where David Bowie took questions from audiences in these locations.

### **5.1.2 Cross-border digital distribution of *Infernal Affairs III* in December 2003**

SingTel is a major telecommunications company with global infrastructure and 34 offices worldwide. Its international network provides direct connections from Singapore to more than 100 countries. It also operates a pan-Asian chain of world-class data centres providing a suite of managed hosting telco solutions.

SingTel completed the country's first cross-border digital distribution of a movie in early December 2003. The Hong Kong blockbuster, *Infernal Affairs III*, was transferred from Hong Kong to Singapore over SingTel's high speed ATM network to Shaw Lido Cineplex.

### **5.1.3 World's first 2k-digital multiplex deployment in March 2004**

Founded in the 1940s, Eng Wah Organization is one of four major film exhibitors and distributors in Singapore, with 29 cinema screen halls and a capacity of over 6 700 seats.

In March 2004, Eng Wah Organization completed the world's first full 2k deployment of a digital multiplex with 5 digital screens by. By June 2004, Eng Wah Organization completed its target deployment of 20 digital screens at 4 multiplexes. All screens are equipped with a Barco 2k DLP Cinema™ projector and a GDC DSR™ digital film server. Each multiplex is also equipped with a GDC DSR™ Cineplex Central Server on which content scheduling is done.



#### 5.1.4 Digital subtitling and watermarking capability

Established in 1989, Mega Films offers subtitling, watermarking, and back-room services to all major film distributors in Singapore. It provides subtitles for their English, Hindi and Chinese commercial and art house film releases to Buena Vista Columbia Tristar Films, Warner-Fox and United International Pictures.

In October 2004, Mega Films extended its activities to the digital field.

Equipped with a Christie 1.3K DLP Cinema™ projector and GDC server in a mini auditorium setup, Mega Films has since provided Mandarin subtitles, as well as watermarks, for Hollywood blockbusters “Shark Tale” and “National Treasure” screened in Singapore.

#### 5.1.5 Cross-Continent Digital Content Transmission (CCTx project)

CCTx project aims to develop a viable business model for digital delivery and production across continents as a global distribution hub for digital content.

In June 2005, the following experiment was successfully completed.

Firstly, an 11-minute test movie called the “Standard Evaluation Material” (StEM) file was transmitted from GlobeCast in Culver City, Los Angeles to 1-Net, a data exchange centre in Singapore, the original StEM narration was localized with Chinese subtitles and Mandarin voiceover. Then, the localized content was re-distributed digitally to the United States and Thailand via satellite through GlobeCast. In the United States, GlobeCast worked with Microspace to deliver the localized StEM to the Digital Cinema Laboratory at ETC-USC. In Bangkok, Thailand, GlobeCast worked with Asia.Net to deliver the localized StEM to SFX Cinema at Central Plaza, a cinema chain of SF Cinema City cinema. The localized StEM was also transmitted directly via fibre by Starhub to two a cinema halls in Singapore at, Eng Wah Suntec and Cathay Cineplex Orchard. The StEM file of 170 GB with a total duration of 12 minutes was successfully screened.

### 5.2 Alternative content in Singapore

These are alternative content that has been done in Singapore.

- “Live” David Bowie “*Reality*” concert at Cathay Orchard Cineplex
- “Live” screening of the Academy Awards Ceremony 2004 and 2005 at Cathay Orchard Cineplex
- Selected soccer matches of Euro2004 screened with full-house audience at Cathay Orchard Cineplex and Golden Village Plaza Singapura Cineplex
- “Live” digital transmission and screening of Singapore’s National Day Parade 2004 at The Legends Fort Canning Park, owned privately by major shareholders of Eng Wah Organization.

## 6 LSDI in India and China

India and China are two of the most populous countries of the world. Both of these countries have a ‘*movie going*’ culture. India and China movie industry are huge driven by large domestic market, which can benefit from the addition of digital screens that are capable of displaying LSDI content. Screens capable of displaying LSDI content have flourished in India and China and been accepted by distributors and exhibitors.

This section presents the current status of digital screens capable of displaying LSDI content in India and China.

## 6.1 India<sup>28, 29</sup>

India is at full steam implementing screens capable of displaying LSDI content. One of the most significant announcements in 2003 was a multi-million dollar contract to retrofit 400 movie theatres with digital displays across India by mid-2004. The goal is to retrofit 1 500 theatres by 2007.

Today, India has about 100 screens capable of displaying LSDI content (mostly below 1.3k quality). Most of these installations are based on single-chip DLP or LCD projectors. There are benefits retrofitting to a digital screen:

- Distribution cost is reduced by electronic distribution.
- Presentation quality is improved.

## 6.2 China

Outside of the US, the next biggest concentration of digitally equipped theaters is China. To date, about 200 digital screens capable of displaying LSDI are established (about half of these are 1.3k or better). These are networked for easier electronic distribution of content throughout China.

China Film Group is also developing its mastering and post-production capability. For example, Hualong (China's leading HD mastering, restoration and conversion facility) has purchased a high-quality digital projector for its mastering suite.

## 7 Summary

LSDI implementation and application in Asia is reported. The rapid and widespread diffusion of LSDI facilities has already started in China and Singapore, but the penetration of LSDI facilities into film theatres seems to be still slow in other Asian countries.

High-level government commitment and funding may be necessary to promote implementation of LSDI equipment, not only because the initial cost for LSDI is higher than film projectors at this moment but also because the scale of networked LSDI venues is very important in making the best use of the merits of LSDI, in other words, live alternative content seems to have business difficulties if carried out on a small scale.

Currently, the highest quality of digital cinema can be achieved by screening with so-called 2k format projectors at commercial cinema theatres. But so-called 4k format projectors have been already developed. The activities in promoting understanding and global diffusion of the 4k format digital cinema are also progressing.

Several alternative contents for LSDI in Japan and Singapore also are described. Cinema theatre chains have already completed the phase of technical validation or experimental trial, realizing some business-attractive alternative contents. They are aware that digitalization of cinema theatres is unavoidable and that LSDI equipment will be implemented into all theatres sooner or later.

---

<sup>28</sup> Digital Cinema in India, Michael Karagosian and Nirav Shah, Karagosian MacCalla Partners, <http://www.kmpartners.org/papers/inasia/india.shtml>.

<sup>29</sup> GDC Tech to retrofit 400 Indian cinemas, digitize feature films [http://www.gdc-tech.com/news/2003\\_13.pdf](http://www.gdc-tech.com/news/2003_13.pdf).

TABLE 17

**LSDI implementation in Asia and Pacific**(Source: <http://www.dcinematoday.com>, 7 March, 2006)

Country	Theatre	Total number of 1.3k + 2k projection screens	Number of 2k projection screens	Location	Organization
Australia	Total number:	3	1		
	Hawthorne Cineplex	1	1	Brisbane	Cineplex
	ACMI Theatre	1		Melbourne	Australian Center for the Moving Image
	Hoyts Fox Multiplex	1		Sydney	Hoyts Corporation Pty Ltd
China	Total number:	99	32		
	Beijing Chang Hong Cinema	1	1	Beijing	China Film Group Corporation
	Beijing Dahua Cinema	1		Beijing	China Film Group Corporation
	Beijing Star City Cinema	1	1	Beijing	China Film Group Corporation
	Beijing Theater	1		Beijing	China Film Group Corporation
	Beijing Youth Palace Cinema	1		Beijing	China Film Group Corporation
	Beijing Zi Guang Cinema City	1		Beijing	China Film Group Corporation
	Capital Time Square Cinema City	1		Beijing	China Film Group Corporation
	China Film Heng Le New Century Cinema City	1		Beijing	China Film Group Corporation
	China Film Theater	1	1	Beijing	China Film Group Corporation
	Dong Huan Cinema City	1		Beijing	China Film Group Corporation
	Sun Dong An Cinema	1		Beijing	China Film Group Corporation
	UME Hua Xing (China Star) Cineplex	1		Beijing	China Film Group Corporation
	Stellar CGV International Cineplex	3	2	Beijing	Stellar Megamedia Corp
	Show Max Cinema	1		Beijing	Yun Bai Group
	Chang Sha Cinema City - Furong Room	1		Chang Sha , Hu Nan Province	China Film Group Corporation
	Hu Nan Grand Theater	1		Chang Sha , Hu Nan Province	China Film Group Corporation
	Changzhou Asia Cinema City	1		Changzhou	China Film Group Corporation
	Chengdu Huaxie Cinema City	1		Chengdu	China Film Group Corporation
	Chengdu Pacific Art Cinema City	1		Chengdu	China Film Group Corporation
	Chengdu Southwest Cinema City	1		Chengdu	China Film Group Corporation
	Wangfujing Cinema City	1		Chengdu	China Film Group Corporation
	Chongqing Studio Cinema City	1		Chongqing	China Film Group Corporation
	UME ChongQing International Cineplex	1	1	ChongQing	Stellar Megamedia Corp
	Dalian Hongni Cinema	1		Dalian	China Film Group Corporation
	Dalian Ownar Cinema City	1		Dalian	China Film Group Corporation
	China Plaza Cinema	2	1	GuangZhou	China Film Group Corporation
	GuangZhou May Flower Cinema	1	1	GuangZhou	China Film Group Corporation
	Guangzhou Feiyang Cinema	2	1	GuangZhou	Guangdong Film Mechanical Factory
	GuanZhou Warner JinYi Int'l Cinema City	1		GuanZhou	China Film Group Corporation

TABLE 17 (continued)

Country	Theatre	Total number of 1.3k + 2k projection screens	Number of 2k projection screens	Location	Organization
	Guangdong Nanhai Plaza Cinema	1		Guicheng	China Film Group Corporation
	Hangzhou Cuiyuan Cinema	1		Hangzhou	China Film Group Corporation
	Hangzhou West Lake (Xihu) Cinema	1		Hangzhou	China Film Group Corporation
	Qingchun Cinema City	1		Hangzhou	China Film Group Corporation
	Hefei Jiefang Cinema	1		Hefei	China Film Group Corporation
	Huai An Huaihai Cinema	1		Huai An	China Film Group Corporation
	HuiZhou CFG South Movie City Cinema	1	1	HuiZhou	China Film Group Corporation
	JiangYin TianHua Culture Center Grand Theater	1	1	JiangYin	Stellar Megamedia Corp
	Kun Ming New Construction Cinema City	1		Kun Ming	China Film Group Corporation
	Yun Nan New Kun Ming Cinema City	1		Kun Ming	China Film Group Corporation
	Nanning Red Star Cinema City	1		Nan Ning	China Film Group Corporation
	Nanning Star Lake Cinema	1		Nan Ning	China Film Group Corporation
	NanHai JiaZhou Cinema	1	1	NanHai	China Film Group Corporation
	Nanjing Jinling Worker's Cinema	1		Nanjing	China Film Group Corporation
	Nanjing Peace Cinema City	1		NanJing	China Film Group Corporation
	Nanjing XinJieKou Cinema	1	1	Nanjing	China Film Group Corporation
	NanJing Warner Cinema World	1	1	NanJing	Stellar Megamedia Corp
	Shangying Warner Int'l Cinema City	1		Nanjing	Stellar Megamedia Corp
	Nanning Wanda Warner Cinema	1	1	Nanning	China Film Group Corporation
	Ningbo Cinema World	2		Ningbo	Stellar Megamedia Corp
	NingXiaJinFengHuang WenHua ZhongXin	1		Ningxia	China Film Group Corporation
	Shanghai Film Studio city	1	1	Shanghai	China Film Group Corporation
	Shanghai Nextage Cinema	1	1	Shanghai	China Film Group Corporation
	Shanghai Stellar Cinema City	3	1	Shanghai	China Film Group Corporation
	Shanghai Super Film World (Kodak Theater)	2	1	Shanghai	China Film Group Corporation
	Studio City Meilongzhen Cinema	1		Shanghai	China Film Group Corporation
	Shanghai Grand Theatre	1		Shanghai	Shanghai Ever Shining Circuit Co., Ltd.
	Shanghai Film Art Center	1		Shanghai	Shanghai Film Group Corp.
	Shanghai Nextage Cinema City	1		Shanghai	Shanghai Film Group Corp.
	Shanghai Paradise Warner Cinema City	2	1	Shanghai	Shanghai Paradise Co.
	Broadband International Cineplex	1		Shanghai	Stellar Megamedia Corp
	Cathay Theatre	1	1	Shanghai	Stellar Megamedia Corp
	UME International Cineplex	1	1	Shanghai	Stellar Megamedia Corp
	Lu Xun Cinema City	1		Shaoxing	China Film Group Corporation
	New-Mart Paradise Cinema City	1		ShenYang	China Film Group Corporation
	Shenyang Guang Lu Cinema	1		ShenYang	China Film Group Corporation
	New South China Cinema City	1		Shenzhen	China Film Group Corporation

TABLE 17 (continued)

Country	Theatre	Total number of 1.3k + 2k projection screens	Number of 2k projection screens	Location	Organization
	Shenzhen New South Movie City	1	1	Shenzhen	China Film Group Corporation
	Hua Xia Art Center	1		Shenzhen, Guangdong	China Film Group Corporation
	Sun Plaza Cinema	1		Shenzhen, Guangdong	China Film Group Corporation
	Citizen Plaza	1	1	Shenzhen, Guangdong	Shenzhen Municipal Government
	Tianjin Wanda Warner Int'l Cinema City	1		Tianjin	China Film Group Corporation
	Wu Xi Big World Cinema City	1		Wu Xi	China Film Group Corporation
	Hubei Silver Star Cinema City	1		Wuhan	China Film Group Corporation
	Wuhan SMI Xinle Cinema City	1		Wuhan	China Film Group Corporation
	Wuhan Studio City Minzhong Leyuan	1		Wuhan	China Film Group Corporation
	Wuhan Studio Silver Star Cinema	1		Wuhan	China Film Group Corporation
	Wuhan Warner JinYi Int'l Cinema City	1		Wuhan	China Film Group Corporation
	Wuhan Warner WanDa Int'l Cinema City	1		Wuhan	China Film Group Corporation
	Kunming Xin JianShe Cinema	1	1	Yunnan Kunming	Stellar Megamedia Corp
	Zhe Jiang Shao Xing Lu Xin Cinema City	1		Zhe Jiang	China Film Group Corporation
	HuaYing QingGong Cinema	1	1		China Film Group Corporation
	JiaXing HuaTing International Cinema City	1			China Film Group Corporation
	Xin JianShe	1			Stellar Megamedia Corp
	Urumchi Renmin Cinema	1			Urumuchi Film Distribution Co.
	Broadway Cinemas Cypertport	1	1		Broadway Circuit
	Ambassador Theatre (Breeze Center)	1	1	Taipei	Ambassador Theatre
	Ambassador Theatre (Ximending)	1	1	Taipei	Ambassador Theatre
	Cinemark Core Pacific	1	1	Taipei	Cinemark USA, Inc.
	Le Sheng LUX Cinema	1	1	Taipei	LUX Movie Theatre
	Hoover Cinema	1	1		Hoover Cinema
India	Total number:	2	0		
	Satyam Cinemas	2		Chennai	Sathyam Cinemas
Japan	Total number:	46	27		
	Keisei Roza	1		Chiba	Keisei Kogyo Co.
	XYZ Cinemas Soga	2		Chiba	XYZ Cinemas Co., Ltd
	Marunouchi Toei	1	1	Cyuo-ku	Toei Co Ltd.
	T-JOY River Walk Kitakyusyu	2		Fukuoka	T-Joy Entertainment
	T-Joy Higashi-Hiroshima	2	2	Hiroshima	T-Joy Entertainment
	T-Joy Hiroshima Ward 11	2	2	Hiroshima	T-Joy Entertainment
	Kagoshima Mitte 10	1	1	Kagoshima	T-Joy Entertainment
	Tokyu 109 Cinemas Kiba	1	1	Koto-ku	Tokyu Recreation Co. Ltd.
	Cineplex Kumamoto	1	1	Kumamoto	Cineplex Herald
	T-Joy Kurume	2	2	Kurume	T-Joy Entertainment

TABLE 17 (continued)

Country	Theatre	Total number of 1.3k + 2k projection screens	Number of 2k projection screens	Location	Organization
	Movix Kyoto	1	1	Kyoto	Shochiku Multiplex Theatres
	Toho Cinemas Nijyo	1	1	Kyoto	Toho Company Ltd.
	Tokyu 109 Cinemas Meiwa	1	1	Matsuzaka-gun	Tokyu Recreation Co. Ltd.
	Tokyu 109 Cinemas Yokkaichi	2	2	Mie	Tokyu Recreation Co. Ltd.
	Tokyu 109 Cinemas Minoh	1	1	Minoh City	Tokyu Recreation Co. Ltd.
	Tokyu 109 Cinemas Nagoya	1	1	Nagoya	Tokyu Recreation Co. Ltd.
	T-JOY Niigata Bandai	2	1	Niigata	T-Joy Entertainment
	T-JOY Park Place Oita	2	1	Ohita Pref.	T-Joy Entertainment
	Shochiku / T-JOY Umeda Buruku 7	2		Osaka	T-Joy Entertainment
	Toho Navio-cineplex	1		Osaka	Toho Company Ltd.
	Toho Sabaigai Cinema	1		Osaka	Toho Company Ltd.
	Movix Saitama	1	1	Saitama	Shochiku Multiplex Theatres
	Toho Shochiku T-JOY Sapporo Cinema Frontier	2		Sapporo	Sapporo Cinema Frontier Co., Ltd.
	T-Joy Takasaki	1	1	Takasaki	T-Joy Entertainment
	Tokyu 109 Cinemas Takasaki	1		Takasaki	Tokyu Recreation Co. Ltd.
	AMC Ikspiari Disneyland 16	1		Tokyo	AMC Entertainment
	Marunouchi Piccadilly 1	1	1	Tokyo	Shochiku Multiplex Theatres
	Shochiku Togeki	1	1	Tokyo	Shochiku Multiplex Theatres
	T-JOY Oizumi (Oz Studio City)	3	1	Tokyo	T-Joy Entertainment
	Toho Hibiya Scalaza Nichigeki Plex	1		Tokyo	Toho Company Ltd.
	Warner MyCal Tama Center	1	1	Tokyo	Warner Mycal Cinemas
	Tokyu 109 Cinemas Tomiya	1		Tomiya	Tokyu Recreation Co. Ltd.
	Tokyu 109 Cinemas MM Yokohama	2	2	Yokohama	Tokyu Recreation Co. Ltd.
Korea	Total number:	43	39		
	Ansan 12	1	1	Ansan	Meganex
	Arirang Cine Center	1			Arirang
	Artreon Theater	2			Artreon
	CGV Gu-Ro 10	1	1		CGV
	CGV In-Cheon	1	1		CGV
	CGV Kang-Byun	2	1		CGV
	CGV Young-San	5	5	Seoul	CGV
	Cinus Yunsoo 10	1	1		Cinus
	Korea Barco 2K TBD	1	1		Koil Corporation
	Lotte Ilsan 14 Cinema	1	1		Lotte Cinema
	Lotte Lafesta	1	1	Seoul	Lotte Cinema
	Lotte World Cinema	1	1		Lotte Cinema
	Megabox Cineplex	17	17	Seoul	Megabox Cinema

TABLE 17 (end)

Country	Theatre	Total number of 1.3k + 2k projection screens	Number of 2k projection screens	Location	Organization
	MegaBox Dae-Gu	2	2		Megabox Cinema
	MegaBox Hae-Un-Dae	1	1		Megabox Cinema
	MegaBox Jun-Ju	1	1		Megabox Cinema
	MegaBox Kwang-Ju	1	1		Megabox Cinema
	MegaBox Seo-Myun	1	1		Megabox Cinema
	MegaBox UL-San	1	1		Megabox Cinema
	Primus Haewoondae	1	1	Busan	Primus
Singapore	Total number:	24	24		
	Cathay Orchard CineLeisure	1	1	Singapore	Cathay Organisation Holdings, Ltd.
	Golden Village Marina	1	1	Singapore	Golden Village
	Eng Wah Jubilee (Ang Mo Kio)	4	4		Eng Wah Organization Ltd.
	Eng Wah Suntec	5	5		Eng Wah Organization Ltd.
	Eng Wah Toa Payoh	5	5		Eng Wah Organization Ltd.
	Eng Wah West Mall (Bukit Batok)	6	6		Eng Wah Organization Ltd.
	Golden Village Grand - Premiere!	1	1		Golden Village
	Shaw Lido	1	1		Shaw Organization
Thailand	Total number:	5	4		
	Major Cineplex Central World Plaza	1	1	Bangkok	Major Cineplex
	Major Cineplex Ratchayothin	1		Bangkok	Major Cineplex
	Major Rama III	1	1	Bangkok	Major Cineplex
	SFX Cinema Central Ladprao	1	1	Bangkok	SF Cinema City
	SFX Emporium	1	1	Bangkok	SF Cinema City

TABLE 18  
**Countries other than Asia and Oceania region**

(Source: <http://www.dcinematoday.com>, 7 March, 2006)

<b>Country</b>	<b>Total number of 1.3k plus 2k projection screens</b>	<b>Number of 2k projection screens</b>
Austria	16	15
Belgium	22	19
Brazil	8	
Canada	8	3
Czech Republic	2	1
Denmark	4	4
France	20	15
Germany	32	30
Hungary	1	
Israel	1	
Italy	26	26
Luxembourg	3	2
Mexico	4	4
Netherlands	15	15
Norway	3	1
Portugal	3	3
Spain	7	5
Sweden	9	8
Switzerland	8	8
United Kingdom	64	58
United States	295	218
Totals:	551	435



## Chapter 3 of Part 2

### Europe

#### 1 Introduction

The European Digital Cinema Forum (EDCF) is a motion picture expert group active in Europe in the field of “D-Cinema” and “E-Cinema” (LSDI):

Most of the following information are provided by EDCF members or related to their activities.

Some of the projects announced in the last EDCF Report are still in a launching phase, mainly due to the difficulties to find funds even with the help of public authorities.

In some countries, like Norway and Switzerland, commercials in the cinema theatre are projected with video server and projectors instead of 35 mm.

For the sake of clarity the EDCF have defined four levels of service appropriate to the various venues and communities served. Levels 4 and 3 cover E-Cinema.

Levels 2 and 1 cover D-Cinema. These correspond broadly to the DCI<sup>30</sup> specification submitted to SMPTE for consideration.

For the description of the Levels see the website of EDCF [www.digitalcinema-europe.com](http://www.digitalcinema-europe.com).

#### 1.1 List of projects and their implementation in Europe

##### 1.1.1 Arcadia (Italy)

The ARCADIA cinema in Milan is the first permanent “digital cinema” site in Italy. The equipment is used for high-end “digital cinema” feature film as well as Alternative Content/“E-Cinema” screenings.

##### 1.1.2 CityScreens (UK)

Since start-up in 1989, CityScreens has become one of Britain’s leading independent exhibitors. Six of its 18 screens are currently equipped with digital projection equipment.

##### 1.1.3 Digital Cinema European Network (DCEN) – European project

Initiated in 2002 by the *Association Européenne pour la Diffusion du cinéma Numérique (ADN)* under the Media Plus programme, DCEN aims at creating a network of digitally equipped theatres around Europe. These theatres are all part of the Europa Cinema network. European manufacturer of projectors and servers are partners of this project. In 2004 four theatres were equipped.

##### 1.1.4 CinemaNet (former EuroDocuZone)

CinemaNet Europe is bringing documentaries to the big screen by transforming 180 independent cinemas across eight countries into digital cinemas.

The member countries are Austria, France, Germany, the Netherlands, Portugal, Spain, Slovakia and the United Kingdom. Belgium is about to join the network as a full member. Autonomous partners in each country are using public and private funding to transform specialist cinemas into digital cinemas. A key financier is the EU’s MEDIA Programme.

---

<sup>30</sup> DCI Digital Cinema Specification V 1.0 could be found at [www.dcinovies.com](http://www.dcinovies.com).

CinemaNet Europe will distribute at least 12 European documentary films in 2005 as well as locally produced films in each country. Future expansion will include other vulnerable genres such as shorts, animation and Arthouse features.

Cinemas now have an easy, low-risk way to revolutionize their business with access to many more films and more scheduling flexibility. CinemaNet Europe films are subtitled on a central server, distributed by satellite and shown using digital projectors. To coincide with film reviews and highest audience interest, films can now be premiered across Europe with a satellite-linked Q&A with the director.

#### **1.1.5 E-Screen (European project)**

Initiated in 2002 with the support of the European Space Agency, the E-Screen project led to the creation of the first “Multilanguage” network for “digital cinema”. E-Screen installed 8 screens around Europe and provides services that can be used by any MPEG-2 Digital Theatre in Europe. Starting from January 2004, the E-Screen network will start a regular programming of Alternative Content. The E-Screen service is also able to support a complete technical flow for processing and delivery of any type of digital contents, including feature films.

#### **1.1.6 Euro1080**

Euro1080, the first operator to broadcast completely in high definition (HD) throughout Europe, distributes 2 channels. The Main Channel distributes a daily 12 h programme to European households as well as to venues like sports bars, hotel chains, restaurants, conference centres, airports, and other public places to familiarize the public with the exceptional quality that HDTV has to offer. The Event Channel distributes event programmes (live or recorded) to so-called “event cinemas”, that are equipped with electronic projectors and surround sound systems, as well as to other venues such as theatres, opera houses, sport halls and so on.

#### **1.1.7 Folkets Hus och Parker – Digitala Hus (Sweden)**

Folkets Hus och Parker (FHP) operates 267 cinemas (all single screen) with a total capacity of 53 958 seats. FHP operates Digitala Hus (Digital Houses) a digital cinema circuit of 9 theatres.

#### **1.1.8 Kinopolis (Belgium)**

Kinopolis, Belgium’s leading Cinema group, is active in Belgium, France, Spain, Italy, Switzerland and Poland. Kinopolis Group is particularly proactive in the field of “digital cinema”: it ordered recently 10 “digital cinema” projectors from a European manufacturer.

#### **1.1.9 Novocine (France)**

Novocine provides solutions for upgrading existing cinemas to digital and acts as an interface between exhibitors, equipment manufacturers and content owners. Novocine is the French partner of CinemaNet.

#### **1.1.10 Orpheus (European project)**

The ORPHEUS Project was initiated in April 2003, in the frame of the Media Plus Programme. ORPHEUS is focused on the production, distribution and exhibition of a set of alternative programming having cultural feature (4 Operas in HD, 2 archive movies). Partners are Elsacom S.p.A., UCI, Cinecittà Holding, BBC OpusArte, La Compagnie, Lyric Theatre of Barcelona. Territorial coverage shall include 9 EU countries. This project aims at validating a proposition also based to the exploitation of Alternative Contents and to the definition of the relevant business and operational models. Projections will start by spring 2004. ORPHEUS follows previous project “EC digital cinema”, led by Elsacom in 2001-2002 in the frame of the Media Programme, and “E-Screen” supported by the European Space Agency.

### **1.1.11 UK Film Council – Digital Screen Network (UK) Art Alliance**

Arts Alliance Digital Cinema (AADC), a provider of digital cinema services, has been selected by the UK Film Council to install and run the world's first digital screen network, a core part of the UK Film Council's strategy for improving access to specialized film and broadening the range of films available to audiences throughout the United Kingdom.

Arts Alliance Digital Cinema will provide a network of up to 250 screens throughout the United Kingdom. Each cinema will guarantee a minimum number of specialized (arthouse/foreign language) film shows a week in return for the equipment.

The agreement with AADC runs for the period of the installation/rollout plus 4 years. It covers installation, training, servicing, warranties and upgrades for the lifetime of the contract. In addition, under the terms of the contract, AADC will, if and when required, create digital cinema masters for specialized film content, and when requested load onto disks, deliver to the cinema and supply the security keys for the cinema to play out the film all at a pre-agreed price.

Arts Alliance Digital Cinema will work with its suppliers to procure, integrate, install and manage equipment in cinemas. Christie Digital Systems and NEC (supported by Digital Projection Ltd) will supply 2k DLP Cinema(tm) Projectors while QuVIS will supply servers. Cinema staff will also be trained and supported and AADC will work with Impact Marcom, Sound Associates, The Metropolitan Film School and the BKSTS to provide these services.

### **1.1.12 XDC EVS (Belgium)**

XDC is a private funded initiative supported by EVS Group. XDC proposes to equip a high number of theatres all over Europe and will set up full logistic services from content preparation to digital screening and archiving. Distributors will pay at least 20% less than the regular cost of the 35 mm distribution. Exhibitors will get a complete solution for a monthly contribution fee with access to different options for the equipment including projector, server, and satellite dish from entry level to high end. They will also have the possibility to use hardware for alternative content (sport, concert, etc.).

### **1.1.13 I-DIFF**

I-DIFF is an event in Europe, with exhibition, conferences and screenings entirely dedicated to "Digital cinema" under all its aspects. This year will be marked by the presence of major European and International actors, in the fields of technologies linked to creation, post-production and diffusion.

---