

International Telecommunication Union

ITU-R
Radiocommunication Sector of ITU

Report ITU-R BT.2470-2
(11/2021)

**Use of Monte Carlo simulation to model
interference into DTTB**

BT Series
Broadcasting service
(television)



International
Telecommunication
Union

Foreword

The role of the Radiocommunication Sector is to ensure the rational, equitable, efficient and economical use of the radio-frequency spectrum by all radiocommunication services, including satellite services, and carry out studies without limit of frequency range on the basis of which Recommendations are adopted.

The regulatory and policy functions of the Radiocommunication Sector are performed by World and Regional Radiocommunication Conferences and Radiocommunication Assemblies supported by Study Groups.

Policy on Intellectual Property Right (IPR)

ITU-R policy on IPR is described in the Common Patent Policy for ITU-T/ITU-R/ISO/IEC referenced in Resolution ITU-R 1. Forms to be used for the submission of patent statements and licensing declarations by patent holders are available from <http://www.itu.int/ITU-R/go/patents/en> where the Guidelines for Implementation of the Common Patent Policy for ITU-T/ITU-R/ISO/IEC and the ITU-R patent information database can also be found.

Series of ITU-R Reports

(Also available online at <http://www.itu.int/publ/R-REP/en>)

Series	Title
BO	Satellite delivery
BR	Recording for production, archival and play-out; film for television
BS	Broadcasting service (sound)
BT	Broadcasting service (television)
F	Fixed service
M	Mobile, radiodetermination, amateur and related satellite services
P	Radiowave propagation
RA	Radio astronomy
RS	Remote sensing systems
S	Fixed-satellite service
SA	Space applications and meteorology
SF	Frequency sharing and coordination between fixed-satellite and fixed service systems
SM	Spectrum management

Note: This ITU-R Report was approved in English by the Study Group under the procedure detailed in Resolution ITU-R 1.

Electronic Publication
Geneva, 2021

© ITU 2021

All rights reserved. No part of this publication may be reproduced, by any means whatsoever, without written permission of ITU.

REPORT ITU-R BT.2470-2

Use of Monte Carlo simulation to model interference into DTTB¹

(2019-2020-2021)

TABLE OF CONTENTS

	<i>Page</i>
Policy on Intellectual Property Right (IPR).....	ii
1 Introduction	2
2 Modelling interference into DTTB services using Monte Carlo simulation.....	3
3 Interpreting the results of Monte Carlo simulation	7
3.1 Main issue.....	7
3.2 Fixed interferer	7
3.3 Moving interferer.....	10
3.4 Modelling of interference scenarios	15
4 Overall conclusions	15
5 Abbreviations	16
6 References	16
Annex 1 Calculation of the probability of non-interference for the protection criteria other than $C/(I+N)$	17
Annex 2 Relationship between the probability of interference and the I/N	17
Annex 3 Relationship between the probability of disruption and the degradation of the reception location probability.....	20
Annex 4 Example Monte Carlo simulation for fixed and mobile interferers	24
A4.1 Introduction.....	24
A4.2 Fixed interferers.....	24
A4.3 Moving interferers	26
Annex 5 System parameters used in the example Monte Carlo simulations.....	27
Annex 6 Results of the example Monte Carlo simulations.....	30

¹ This Report should be brought to the attention of ITU-R Study Groups 1, 3, 4 and 5.

1 Introduction

Monte Carlo simulation is a statistical method widely used to solve complex mathematical problems, to model physical phenomena or to understand complex real-life problems that cannot be easily modelled by analytical methods. For example, Monte Carlo simulation is used to study collision of atoms, polymer dynamics as well as financial risks.

Monte Carlo simulation is based on random sampling to generate a large number of events (experiments), according to the model implemented to describe a physical phenomenon. Each generated event, output of the simulation, can be considered as a snapshot in time.

As such, modelling the probability of interference into DTTB using Monte Carlo simulation poses some unique problems. If the network being modelled does not change with time, i.e. the interferer position is fixed, and the transmitted power is constant, then there is a single event and the calculated probability of interference using a Monte Carlo simulation is valid for any time window. If, however, the network varies, in the case of fixed interferers the power varies between off and fully on, or there is movement or change in position of the interferers in the network, then the calculated probability of interference is only valid for one moment in time or state of the network. To understand the probability of disruption, that is one or more interference events occurring in our hour time window, further processing is needed.

Monte Carlo simulation is increasingly being used to assess the compatibility between radio systems. The simulation typically considers randomly distributed sources of interference and randomly distributed or fixed victim receivers. Different system parameters can also be modelled as random variables defined by given probability distributions. Most often, the output of the simulation is processed to calculate the probability of interference to the victim receiver or the loss of data throughput in a network.

A deterministic method is used to assess the compatibility between radio systems with a fixed interference configuration. However, it is unable to predict the probability of interference if the interference configuration is not fixed and consequently the risk of interference to the victim system. The merit of Monte Carlo simulation is its ability to create a very high number of possible interference configurations, covering the variability in a system, when assessing the compatibility between radio systems and by doing so assess the risk of interference in a more realistic way compared to a deterministic assessment.

When used to assess the compatibility between radiocommunications systems, the outcome of Monte Carlo simulation can be the average probability of interference or the average loss of throughput, at any one instant in time, and does not account for interference that may occur within a time window due to changes with time, for example in relative position and/or power of the source(s) of interference.

Monte Carlo simulation can also be used to assess the risk of interference for a fixed interference scenario. In that case the results obtained will be in line with those obtained by the deterministic assessment if the same network parameters and protection criteria are used.

Report ITU-R SM.2028 provides background information on Monte Carlo simulation methodology for assessing compatibility between radio communication systems and their application in the Spectrum Engineering Advanced Monte Carlo Analysis Tool (SEAMCAT) software.

This Report expands on Report ITU-R SM.2028 providing further information on how to model interference into DTTB services using Monte Carlo simulation. The description and examples presented in this report are based on SEAMCAT, but the methods described for modelling interference into DTTB using Monte Carlo simulation are general.

2 Modelling interference into DTTB services using Monte Carlo simulation

Monte Carlo simulation can be used to model a large range of radio systems and simulate various interference scenarios. Monte Carlo simulation have been extensively used within the CEPT to assess the compatibility between radio systems. The compatibility calculation normally results in an assessment of one of two possible outcomes of such a simulation, either the probability of interference, or the loss of data throughput in a network.

In a Monte Carlo simulation, the impact of a radio service or system on DTTB reception is assessed based on the probability of interference.

First, the most relevant radio parameters are identified and agreed based on the information provided in existing reports and recommendations and other agreed sources: transmitter power, transmit power control, antenna height, diagram and gain, receiver sensitivity, noise floor, propagation model, etc. Such parameters can be found, for example, in ITU-R BT.2383 [2] for DTTB and Report ITU-R M.2292 [3] for IMT. These parameters are used to construct the interference scenario under consideration. Some of these parameters have fixed values, while others are modelled as random variables defined by a given probability distribution.

The basic Monte Carlo simulation steps used to assess the impact of a radio service or system on DTTB reception are summarised below:

Case A – Impact on DTTB reception at the coverage edge:

- 1 a pixel of $100\text{ m} \times 100\text{ m}$ is positioned at the DTTB coverage edge;
- 2 the DTTB receiver is randomly positioned, following a uniform distribution, in the pixel;
- 3 an interfering transmitter (or cluster of transmitters) is positioned around the DTTB receiver. The relative position between the DTTB receiver and the interfering transmitter (or cluster) is randomly generated, following a uniform polar distribution, within the interfering transmitter cell range;
- 4 received useful and interfering signal levels, *DRSS* and *IRSS* respectively, are calculated and stored;
- 5 Steps 2 through 4 are repeated K times (see Fig. 1).

FIGURE 1

Several consecutive events generated by Monte Carlo simulation

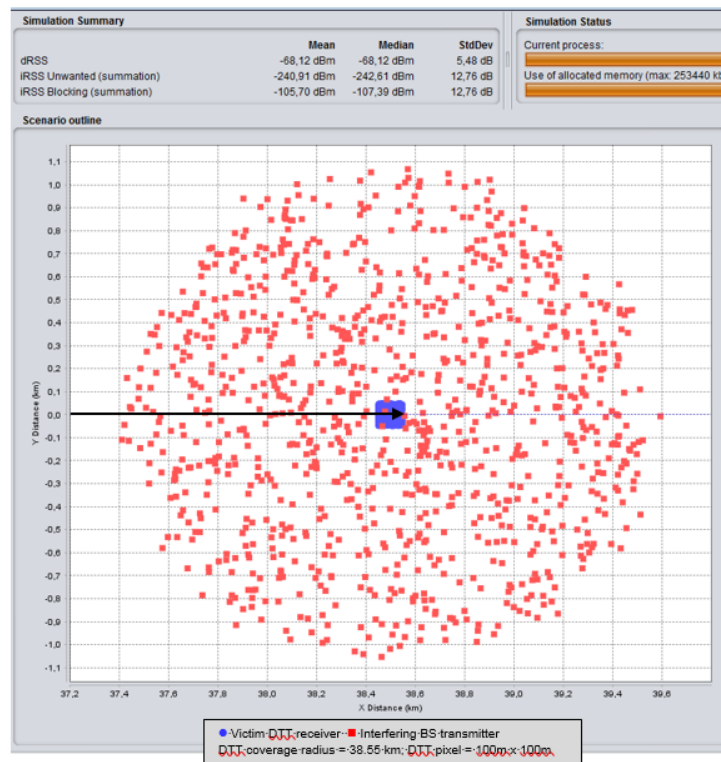

Case B – Impact on DTTB reception across the coverage area:

- 1 the DTTB receiver is randomly positioned, following a uniform polar distribution, in the DTTB coverage area;
- 2 an interfering transmitter (or cluster of transmitters) is positioned around the DTTB receiver. The relative position between the DTTB receiver and the interfering transmitter (or cluster) is randomly generated, following a uniform polar distribution, within the interfering transmitter cell range;
- 3 received useful and interfering signal levels, *DRSS* and *IRSS* respectively, are calculated and stored;
- 4 Steps 1 through 3 are repeated *K* times (see Fig. 2).

FIGURE 2
Several consecutive events generated by Monte Carlo simulation

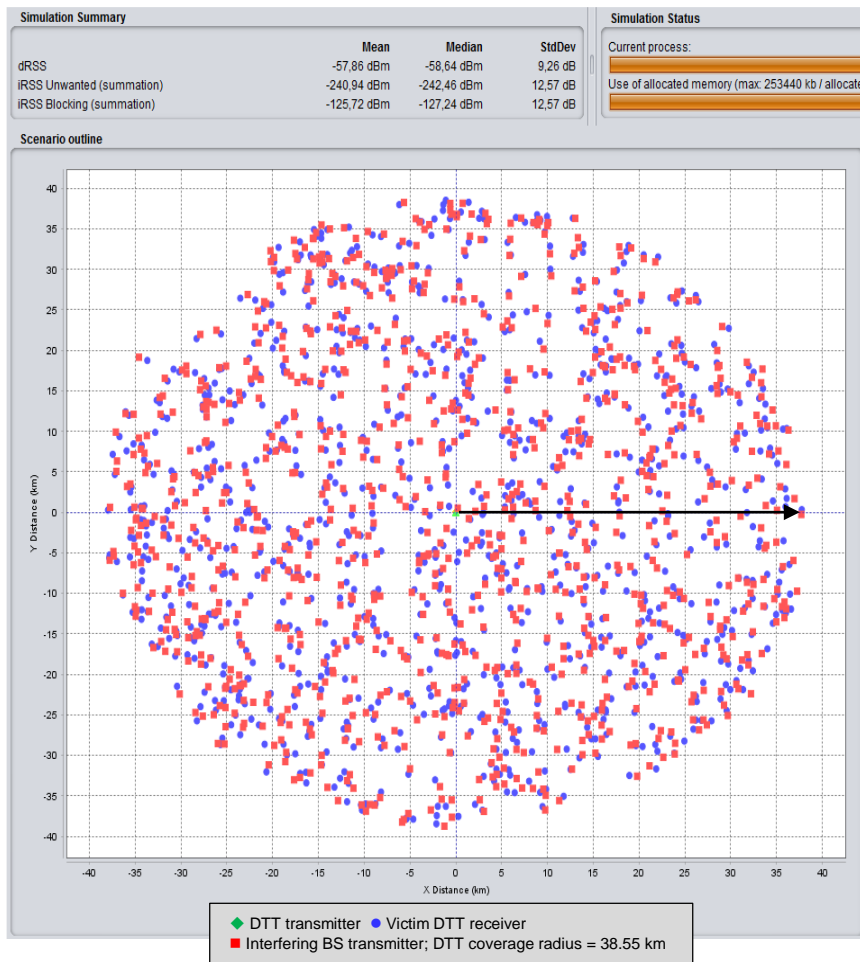

In both cases A and B, the probability of interference (p_I) is calculated after the completion of the simulation.

In Monte Carlo simulation, depending on the interference scenario, a large number (K) of events (experiments) may need to be generated to obtain a reliable result. The events generated by Monte Carlo simulation are independent – the outcome of any one event having no effect on the probability of any other event.

The p_I is calculated from the generated data arrays $DRSS$ and $IRSS$, based on a given interference criterion threshold (C/I , $C/(I+N)$, I/N or $(N+I)/I$). The probability of interference calculated for K events is expressed as

$$p_I = 1 - p_{NI} \quad (1)$$

where p_{NI} is the probability of non-interference of the receiver. This probability can be calculated for different interference types (unwanted emissions, blocking, overloading and intermodulation) or combinations of them.

The interference criterion $C/(I+N)$ should be used for assessing the impact of the interfering transmitters on DTTB reception, where $C/(I+N)$ is equal to the DTTB system C/N . For a constant interferer transmit power p_{NI} can be calculated as follows:

$$p_{NI} = P\left(\frac{DRSS}{IRSS_{composite+N}} \geq \frac{C}{I+N}\right), \text{ for } DRSS > Rx_{sens}$$

$$= \frac{\sum_{i=1}^M 1\left\{\frac{DRSS(i)}{IRSS_{composite}(i)+N} \geq \frac{C}{I+N}\right\}}{M} \quad (2)$$

where:

$$1\{condition\} = \begin{cases} 1, & \text{if condition is satisfied} \\ 0, & \text{else} \end{cases}$$

$$IRSS_{composite}(i) = \sum_{j=1}^L IRSS_{(j)}^{(i)}$$

$DRSS$: received useful signal level

$IRSS$: received interfering signal level

M : number of events where $DRSS > R_{x_{sens}}$. Note that in most cases $M < K$

L : number of interfering transmitters.

Note that $\frac{DRSS}{IRSS_{composite}+N} \geq \frac{C}{I+N}$ condition checks if the sum of the interfering signals received from different fixed interferers causes interference into DTTB receiver, at a time instance.

The degradation of DTTB reception in the presence of interfering signals can easily be calculated as follows:

$$\Delta p_I = P_I(N+I) - P_I(N) \quad (3)$$

where:

$P_I(N)$: p_I in the presence of noise only

$P_I(N+I)$: p_I in the presence of noise and interference.

From equation (1), it is obvious that $P_I(N) = 0$. Then, the following can be written:

$$\begin{aligned} \Delta p_I &= P_I(N+I) \\ &= p_I \end{aligned} \quad (4)$$

From equation (4) it can be concluded that the degradation of DTT reception in the presence of interfering signals is simply p_I calculated in Monte Carlo simulation as described by equation (1) and equation (2).

It should be noted that the p_I , being an average probability over all samples across the area of the simulation, will be significantly influenced by the interference scenario being modelled. For example, the p_I calculated in a 100 m \times 100 m pixel at the edge of the DTTB coverage area will be, because of low wanted signal levels, much higher than a p_I calculated across the overall DTTB coverage area.

It is also important to bear in mind that the p_I is invariant in time. If the occurrence of interference (I) and non-occurrence of interference (NI) are considered as the two values of a Bernoulli random variable X that represents the state of interference, then it is possible to write:

$$\begin{aligned} P(X=I) &= p_I \\ P(X=NI) &= 1-p_I \end{aligned}$$

The above property will be used in § 3.3.1 to calculate the probability of disruption to DTTB reception.

Two different types of interferer are considered when dealing with the interference from other radio services or systems into DTTB reception: those where the interferers are fixed in time and location and those where the interferers move or change position with time. Interpretation of the results of Monte Carlo simulation for each of these situations is considered in the following sections.

3 Interpreting the results of Monte Carlo simulation

3.1 Main issue

The reception location probability (p_{RL}) is one of the most important parameters of network planning. DTTB network planning is based on quasi error free (QEF) reception for a target p_{RL} in a pixel of $100\text{ m} \times 100\text{ m}$ at the edge of the coverage area. For example, the target probability is typically 95% for portable and fixed roof-level reception [4].

For multi-cast or broadcast systems, which cannot re-send data that has failed to be received and cannot adapt the bit rate to suit the state of the RF channel, the quality of service (QoS) is strongly dependent on the signal quality at the reception site (receiving antenna) in the coverage area defined by the target p_{RL} . DTTB networks are planned on the basis of a service having quasi error free reception (i.e. less than one error per hour) at any reception site within the designated coverage area². Consequently, it seems sensible to assess the impact of a radio service or system on DTTB reception based on the degradation of the reception location probability.

The above condition is not necessary for adaptive systems having the ability to adapt their transmission mode to the signal quality at the reception site. Today's bidirectional communication systems can re-send failed data and use adaptive modulation schemes to match the transmitted signal to the quality of the RF channel and ensure the requested QoS for varying signal quality at the reception site. Therefore, for such systems it is sensible to assess the impact of a radio service or system on their performance based on the p_I or on the loss of data throughput (TL) in a network. For example, for mobile communication systems, the acceptable TL is typically around 5% [5].

As described in § 2, when using Monte Carlo simulation to assess the compatibility between DTTB and a given radio service or system, the impact of the latter on DTTB is expressed as a p_I and not as a degradation of the p_{RL} . It is therefore necessary to understand the meaning of the p_I calculated by Monte Carlo simulation and the link between this p_I and the p_{RL} .

3.2 Fixed interferer

In the case of fixed interferers, that is if the source or sources of interference do not move (e.g. mobile base station), the impact of the interference on the DTTB coverage area most often appears as holes (or areas) where the required QoS can no longer be ensured due to the interference. Such holes are often near the interfering transmitters. For example, as a consequence of the roll-out of LTE in the 800 MHz band in France, 67 857 DTTB reception sites were interfered with by LTE 800 MHz base stations which equates to interference to about 168 778 households (many households using a shared receive antenna). The median interference distance from an interfering base station was 572 m [6]. All these interference cases were resolved by filtering out the interfering LTE signal with an additional external filter connected to the affected DTTB receive antenna output.

3.2.1 Calculation of the probability of interference into DTTB reception in the case of fixed interferers with varying transmit power

In a given zone the p_I calculated from equations (1) and (2) is approximately equal to the ratio of interfered areas, where the reception cannot be ensured, and whole area of the zone. Consequently, the degradation of the reception location probability (Δp_{RL}) of DTTB can be calculated as follows:

$$\Delta p_{RL} = p_{RL} - (p_{RL} - p_I)$$

² Report ITU-R BT.2341 – TV receiver subjective picture failure thresholds and the associated minimum quasi error free levels for good quality reception, gives "...the C/N relating to acceptable picture quality (typically better than QEF – one visible error/hour) for normal broadcast reception...".

$$= p_I \quad (5)$$

where:

- p_{RL} : target reception location probability
 $p_I = 1 - p_{NI}$, which is the probability of interference calculated in Monte Carlo simulation as described by equations (1) and (2) in § 2.

However, if the transmitted power of the interferer varies in time according to a duty cycle or a given probability distribution, the p_{NI} cannot be appropriately calculated from equation (2), because DTTB quality of service is assessed in a one-hour time window (TW). Equation (2) can only be used if the interferer transmit power is constant as stated in § 2.

For example, let us consider an interference scenario where a DTTB receiver at a given location is interfered with by a fixed interfering transmitter transmitting at constant power for 100% of the time. The p_I calculated from equations (1) and (2) will be 1 (100%). Now, if the same transmitter had a 50% duty cycle, i.e. is off for 50% of the time and on for the rest 50% of the time, the calculated p_I would be 0.5 (50%). If the duty cycle was 10% then the calculated p_I would be 0.1 (10%), etc. However, from the viewer's point of view, the DTTB reception is systematically interfered with by the interfering transmitter, that is $p_I = 1$ (100%) in all the cases. In fact, in a one-hour time window TW , whether the DTTB reception is disrupted during 100% or for only 10% of time does not change the perception of the viewer who experiences an unacceptable QoS in both cases.

This duty cycle is also often modelled as an effective reduction in the base station transmitted power. A 50% duty cycle corresponds to a 50% activity factor which is modelled as a 3 dB reduction in power and a consequent reduction in a calculated p_I compared with that when the base station transmits at maximum power. This approach is not valid for studies involving DTTB, as with such a method the transmitter is never modelled at its maximum power in a one-hour time window.

In the interference scenario considered above a similar problem will occur when the interferer transmit power varies in time according to a given probability distribution. From the point of view of actual interference into DTTB, information is required as to whether or not the interferer operates at full power at some point within the one-hour time window TW . If it does then the p_I that a DTTB receiver will be subject to one or more interference events from a single source of interference can be estimated by assuming that the interferer operates at maximum power. This is valid for the case of a single interferer. If however, there is more than one interferer, all operating at full power, this would, because of the power sum ($IRSS_{composite}$), overestimate the probability of interference. In such a case the actual p_I would lie between that if there was one interferer and that if all interferers operated at full power ($p_{I\ single} < p_I < p_{I\ multiple}$).

Based on the above observations, equation (2) is modified to take into account the variation of the interferer transmit power in time, while taking into account the fact that a given interfering transmitter operates at maximum power at some point within the one-hour TW .

Consequently, when assessing the interference from radio services or systems into DTTB in the presence of fixed interferers p_{NI} is calculated including the logical checks required as follows:

$$p_{NI} = P \left(\left(\frac{DRSS}{IRSS_{composite} + N} \geq \frac{C}{I + N} \right) \wedge (P_{MAX_{check}} = L) \right), \text{ for } DRSS > Rx_{sens}$$

$$= \frac{\sum_{i=1}^M 1 \left\{ \left(\frac{DRSS(i)}{IRSS_{composite}(i) + N} \geq \frac{C}{I + N} \right) \wedge (P_{MAX_{check}(i)} = L) \right\}}{M} \quad (6)$$

where:

$$1\{condition\} = \begin{cases} 1, & \text{if condition is satisfied} \\ 0, & \text{else} \end{cases}$$

$$IRSS_{composite}(i) = \sum_{j=1}^L IRSS_{(j)}^{(i)}$$

$$P_{MAX_check}(i) = \sum_{j=1}^L \mathbf{1} \left\{ \frac{DRSS(i)}{IRSS_{P_{MAX}(j)}^{(i)} + N} \geq \frac{C}{I+N} \right\}$$

M = number of events where $DRSS > R_{X_{sens}}$. Note that in most cases $M < K$

L = number of interfering transmitters

$IRSS_{P_{MAX}}$: received interfering signal level for the maximum transmit power invariant in time.

Note that:

$\frac{DRSS}{IRSS_{composite} + N} \geq \frac{C}{I+N}$ checks if the sum of the interfering signals received from different fixed interferers causes interference into DTTB receiver, at a time instance T_x .

$\frac{DRSS(i)}{IRSS_{P_{MAX}(j)}^{(i)} + N} \geq \frac{C}{I+N}$ checks if transmitter (j) operating at maximum power causes interference into DTTB receiver within a time window.

Note also that for a given time instance i , the L $IRSS_{P_{MAX}^j}$ are independent variables, where the index j corresponds to the j -th interfering signal received by the victim receiver. Consequently, one of these L $IRSS_{P_{MAX}}$ interfering signals is always predominant with respect to all the others. The predominant $IRSS_{P_{MAX}}$ level is called $IRSS_{P_{MAX}max}$.

It is easy to see that for a given time instance i :

- if $\frac{dRSS(i)}{IRSS_{P_{MAX}max(i)} + N} \geq \frac{C}{I+N}$, then $P_{MAX_check}(i) = L$;
- if $\frac{dRSS(i)}{IRSS_{P_{MAX}max(i)} + N} < \frac{C}{I+N}$, then $P_{MAX_check}(i) = 0$.

Consequently,

$$\begin{aligned} P_{MAX_check}(i) &= \sum_{j=1}^L \mathbf{1} \left\{ \frac{DRSS(i)}{IRSS_{P_{MAX}(j)}^{(i)} + N} \geq \frac{C}{I+N} \right\} \\ &= \mathbf{1} \left\{ \frac{DRSS(i)}{IRSS_{P_{MAX}max(i)} + N} \geq \frac{C}{I+N} \right\} \end{aligned}$$

Then equation (6) can be rewritten including the logical checks required as:

$$p_{NI} = \frac{\sum_{i=1}^M \mathbf{1} \left\{ \left(\frac{DRSS(i)}{IRSS_{composite(i)} + N} \geq \frac{C}{I+N} \right) \wedge \left(\frac{DRSS(i)}{IRSS_{P_{MAX}max(i)} + N} \geq \frac{C}{I+N} \right) \right\}}{M} \quad (7)$$

Calculation of the probability of non-interference (p_{NI}) for the protection criteria other than $C/(I+N)$ is derived straight forward from equation (7) (see Annex 1).

3.2.2 Probability of interference and impact on DTTB coverage

As previously underlined, Monte Carlo simulation is increasingly being used to assess the compatibility between radio systems. Consequently, it is necessary to define the acceptable p_I for DTTB service in the presence of interferers from other radio services or systems.

DTT network planning is based on a target p_{RL} at the edge of the coverage area, which is typically 95% for fixed roof-level or portable reception. Thus, it would be sensible to determine what the acceptable p_I at the edge of the coverage area of DTTB network would be. Whilst DTTB coverage is determined by availability at the edge of the network, the impact of the interfering system on DTTB reception across the whole DTTB coverage area may also be considered. Annex 3 provides an example of results of such Monte Carlo simulation.

3.3 Moving interferer

A moving interferer may change its:

- power in time according to a power control scheme;
- position and location in time.

Change in position or location may cause interference successively to different DTTB receivers or may bring it in to range of a particular receiver as shown in Fig. 3.

Obviously, the impact of such interferers on the DTTB coverage area does not appear as holes (or areas) where the required QoS cannot be ensured. Consequently, in the case of moving interferers (e.g. mobile user terminals), the impact of the interference on the reception location probability (P_{RL}) cannot be estimated as described in equation (5).

FIGURE 3

Impact of a moving interferer (user terminal) on DTTB reception

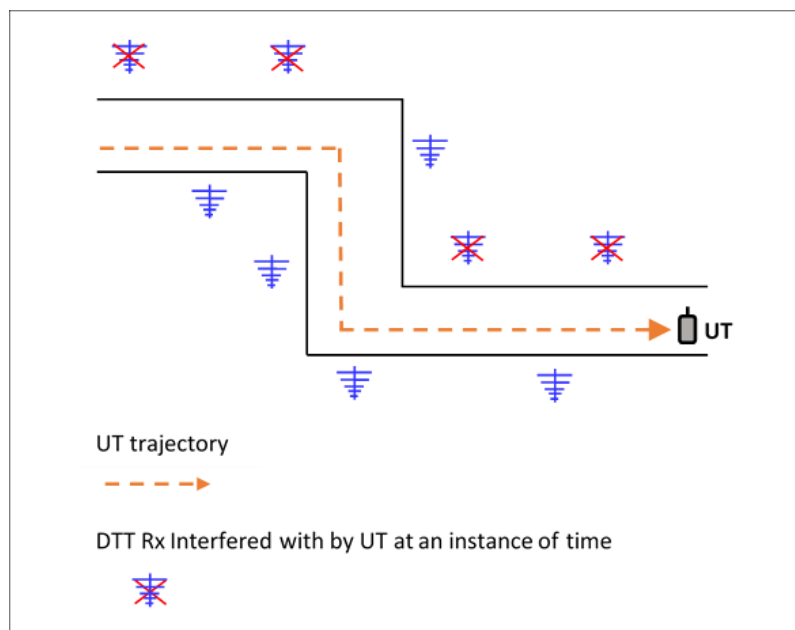

Therefore, with moving interferers, when assessing their impact on DTTB reception, the problem becomes more complicated as their movement in time needs to be taken into account. It should be clear that the p_I calculated in Monte Carlo simulation, as described by equations (1) and (2) or equations (1) and (7), cannot be directly used to assess the impact of moving interferers on DTTB reception due to the fact that p_I does not provide information on the probability that a DTTB receiver will be subject to one or more interference events within a given TW .

3.3.1 Probability of disruption

As explained in the previous section, in the case of moving interferers the continuity in time should be taken into account by converting the p_I calculated in the Monte Carlo simulation into a probability which would better reflect the impact of interference on DTTB reception. In this report this probability is called “Probability of disruption”. The method used to calculate this probability is described below.

The p_I derived from Monte Carlo simulation, by using equations (1) and (2) or equations (1) and (7), provides information on the probability that a DTTB receiver would be subject to interference at any instant (moment) in time. It does not give the probability that a DTTB receiver will be subject to one or more interference events within a given time window. Thus, it is necessary to extend the result of

Monte Carlo simulation to take account of the period in time over which DTTB QoS is assessed, one hour.

As is underlined in § 2, the p_I is invariant in time (constant). If the occurrence of interference (I) and non-occurrence of interference (NI) are considered as the two values of a Bernoulli random variable X that represents the state of interference, then it is possible to write:

$$P(X=I) = p_I$$

$$P(X=NI) = 1-p_I$$

where:

- I : interference
- NI : non-interference.

Now let us split a one-hour TW in “ n ” time intervals. If the value of n is appropriately chosen each time interval can be considered as a Bernoulli trial (a random experiment) with outcomes “ P ” and “ NP ” [7]. These outcomes are called “Interference events”. Within the one-hour TW it can be considered that “ n ” repeated Bernoulli trials occur, here it is obviously assumed that each trial is independent, then the probability that a DTTB receiver is subject to k interference events within the TW is expressed as follows:

$$P(X = k) = \binom{n}{k} p_I^k (1 - p_I)^{n-k} \quad (8)$$

where:

- p_I : probability of interference calculated in Monte Carlo simulation as described by equations (1) and (2)
- n : number of independent trials
- k : number of trials resulting in interference events.

The probability that a DTTB receiver is not subject to any interference events is given by setting $k = 0$ in equation (8):

$$P(X = 0) = (1 - p_I)^n$$

And finally, the probability that a DTTB receiver is subject to at least one interference event can be calculated from:

$$P(X > 0) = 1 - (1 - p_I)^n$$

In this Report this probability is called probability of disruption (p_d) and is expressed as follows:

$$p_d = 1 - (1 - p_I)^n \quad (9)$$

Such a probability p_d could be understood as the probability of having one or more uncorrelated disruptions to the DTTB service during a given time window. The time window should reflect what is used to assess the QoS for DTTB which is, in turn, considered acceptable for the TV viewer (one hour).

Let us remember that the independence of the n trials within the time window implies that the outcome (interference events) of any trial has no effect on the probability of the outcome of other trials. Consequently, in the context of interference into DTTB reception from the movement or change in position of interferers with time, the consecutive n states of interference must be independent (uncorrelated). The average time between two consecutive independent states is called “Decorrelation Time” (DT).

For example, if the outcome of a trial is I (interference) the state of interference stays unchanged during the DT . After this time interval the state of interference changes, thus the interferer or

interferers may, or may not cause interference to the DTTB receiver (remember that the two possible outcomes of a trial are I and NI). Therefore, n can be calculated as follows:

$$n = TW/DT \quad (10)$$

where:

DT : average decorrelation time between two consecutive independent interference states.

Whilst this approach is simple, the problem lies in deriving DT .

3.3.2 Determination of the average decorrelation time

In the case of interferers that move or change with time, particularly in mobile networks, the transmit power control (PC) is one of the most important radio parameters. This feature is implemented in Monte Carlo simulation. Therefore, the impact of the transmit PC is explicitly taken into account in the p_I calculated from equations (1) and (2). Thus, in this Report, the variation of the transmit power of such interferers is not considered when determining the average decorrelation time between two consecutive states of interference.

The number of independent trials “ n ” within the specified TW associated with the movement of the interferers can be determined from the velocity distribution of interferers and the distance an interferer needs to move before signals received by the DTTB receiver no longer have the same impact on the receiver. When an interferer has moved a sufficient distance, then the state of interference at this instance of time can be assumed to be independent from the previous instance of time and there is a change in state in terms of interference.

Taking account of the movement of interferers requires information on the following:

- the velocities at which interferers are moving;
- the distance an interferer needs to move before an interference event caused by the interferer becomes independent relative to a previous event, i.e. occurs to a different DTTB receiver.

3.3.2.1 Interferer velocity

An example of the velocities of user terminals (UT) can be found in [8], this is replicated in Table 1 and Fig. 4.

TABLE 1
Indicative UT velocities

V (km/h)	0	1	3	8	10	15	20	30	40	50	60	70	80	90	100
% calls	14	37	15	1	1	2	6	10	7	2	1	1	1	1	1

As many Monte Carlo simulations consider sources of interference as being both indoor and outdoor these velocities need to be correctly apportioned. As an example – velocities of 0 to 3 km/h, representing 66% of moving traffic, could be taken as representing interferers moving at pedestrian speeds, leaving velocities above 3 km/h as representing interferers located in vehicles.

FIGURE 4
Probability distribution function of UT velocities

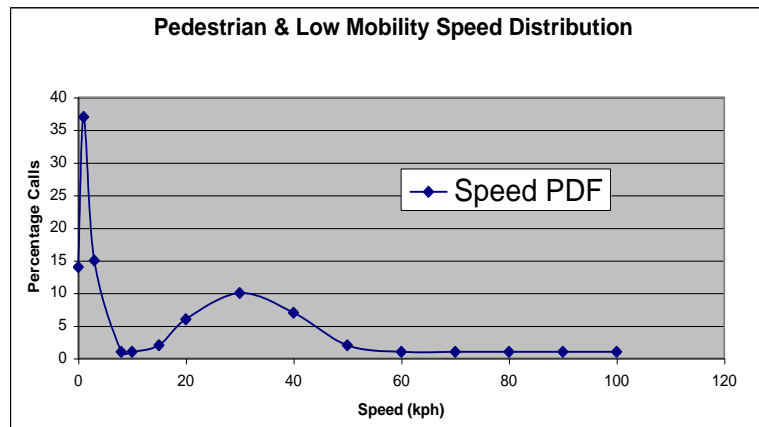

Vehicles are clearly outdoor. To the outdoor total, a proportion of what has been labelled as pedestrian traffic needs to be added. For example, UT moving at speeds of between 0 km/h and 1 km/h could be identified as being indoor (51%) and the devices moving at velocities between 1 km/h and 3 km/h could be identified as being outdoor pedestrian (15%). Based on these assumptions and the distribution provided in this example in Table 1 such an attribution would give indoor and outdoor proportions of devices as 51% and 49% respectively.

It should be noted that Reports ITU-R M.2292 [3] and ITU-R M.2039 [9] provide indoor and outdoor proportion of devices as 70% and 30% respectively, for use of sharing and compatibility studies between IMT advanced systems and other systems and services. Distribution of devices between indoor and outdoor should be appropriate for the systems being considered in sharing and compatibility studies.

3.3.2.2 Decorrelation distance

To calculate the number of independent events that can cause interference, an understanding is required of how far an interferer (for example, a user terminal UT) needs to move before the interference events it generates become independent (uncorrelated). Decorrelation distance is a concept already used in mobile planning for slow fading [10, 11]; specifically, is the distance a UT needs to move from a previous position before the signals, received or transmitted, from UT are assumed to be independent, i.e. are decorrelated. A decorrelation distance value of 20 m is often quoted for movement outdoors and a value of 5 m for movement indoors.

On first inspection and prior to receiving further information, these distances appear to be reasonable for assessing the number of independent state changes generated by device movement.

In the indoor case, 5 m would take you from one side of a house to another which, with respect to interference into DTTB reception, could easily result in a new independent interference event (state) decorrelated from the previous one, i.e. there could be a significant change in the interfering signal level at a DTTB receiver.

For the outdoor case, 20 m, when coupled with the directional pattern of the DTTB receiving antenna, could move a UT from a position of not causing interference, to one causing interference, i.e. there could be a significant change in the interfering signal level at a DTTB receiver.

3.3.2.3 Independent network configurations generated by moving user terminals

For a given TW and the distribution of UT velocity, the proportion of UT moving a certain distance can be readily calculated. From the distance UT move and the decorrelation distance, the number of uncorrelated states “ n ” generated in a TW by UT can be derived as follows:

$$n = TW * \sum_i^k \frac{P_i V_i}{D_i} \quad (11)$$

where:

D: decorrelation distance in metres

V: velocity in metres/second of UT

P: proportion of UT moving at velocity *V*

k: number of velocity values

TW: time window in seconds (for DTTB *TW* = 3 600 seconds).

3.3.2.4 Independent network configurations generated by the scheduler in OFDMA/SC-FDMA based mobile networks

Allocation of physical resource blocks (PRB) for uplink transmission is initiated at the request of UT and made per UT by the uplink scheduler. The allocation of PRB by the scheduler to a UT is independent of the previous requests of the UT and consequently it can be considered as an independent state.

The number of independent states generated in a *TW* by the scheduler as it cycles through UT registered in the cell is given by:

$$n = \frac{M}{A} \quad (12)$$

where:

M: maximum number of active UT per sector (or cell) in *TW*

A: average number of active UT per sector (or cell) in the Monte-Carlo simulation.

The structure of a hexagonal three sector cell of a mobile service base station is shown in Fig. 11.

3.3.2.5 Determination of the number of independent network configurations in the specified TW

As explained in the previous two sections, the number of independent state changes *n* within the specified TW depends on the number of active interferers and the distance an interferer needs to move before an interference event caused by the interferer becomes independent relative to a previous event. The number of uncorrelated events “*n*” generated in a *TW* by UT can be calculated using equations (11) and (12):

$$n = \frac{M}{A} + TW * \sum_i^k \frac{P_i V_i}{D_i} \quad (13)$$

M: maximum number of active UT per sector (or cell) in *TW*

A: average number of active UT per sector (or cell) in the Monte-Carlo simulation

D: decorrelation distance in metres

V: velocity in metres/second of UT

P: proportion of UT moving at velocity *V*

k: number of velocity values

TW: time window in seconds (for DTTB *TW* = 3 600 seconds).

If there is no movement of UT in *TW*, either because UT are fixed, or the *TW* is very short – for example 1 ms, the summation term will be zero, or very close to zero, and the number of events will

be provided by M/A . Consequently, M/A will vary between 1 and the number of UT active in TW – in some case this may be the same.

For example, if the state of UT changes every 1 ms and TW is short 1 ms, then $M = A = 1 = n$ and from equation (9) p_I will equal p_I .

If TW is long relative to the time the network changes state, for example TW is one hour (3 600 seconds), a large number of UT could be expected to be active. Within the one-hour TW , UT in the cell may remain stationary, some will move within the cell, others will move and leave the cell and some will enter the cell. The interest is the number of these UT that transmit at least once during TW . Every UT that transmits in TW , the number being M , generates or contributes to at least one event. It also needs to be considered how many UT, the number being A , are considered in the Monte Carlo simulations. In the case that only one UT is considered, there would be M events. If more than one UT is considered as active at any one time in the Monte Carlo simulations, then it needs to be considered in the number of events generated, hence M/A . M and A should be appropriate for the systems and environment being considered in sharing and compatibility studies.

3.3.3 Impact on DTTB reception

The risk of interference from an interferer to a victim receiver can be minimized by limiting either the in-band or the out-of-band power of the interferer or even both. Even so, unless interference is unreasonably high, it is unclear whether it is practical to limit the in-band power of a UT due to the impact of such restriction on the overall coverage of the concerned service or system. Moreover, despite limiting the power of the UT, there might be residual interference. Therefore, additional mitigation measures may be required to solve possible residual interference on a case-by-case basis (e.g. external filtering of the DTTB receiving installation).

However, as the UT is moving it would be very difficult to solve possible residual interference by applying mitigation techniques such as filtering since the position of the UT is not fixed and cannot be predicted. Annex 4 gives an example of the impact of moving interferers on the DTTB reception.

3.4 Modelling of interference scenarios

Examples of the models used for the fixed and mobile interference scenarios are provided in Annex 4.

4 Overall conclusions

Modern mobile networks are dynamic, constantly changing state to address the needs of individual users and the state of individual RF channels. Monte Carlo simulation used to model such networks provide the average probability of interference (p_I), which is invariant in time and space. This may seem at odds with a dynamic network that is constantly changing with time but is perfectly valid for calculating the average loss of throughput in such networks. Whilst average loss of throughput is a valid measure for mobile networks, broadcasters are interested in disturbances or interruptions to a service in an hour time window; this is visible artefacts (disruptions) on the screen.

As such, modelling the probability of interference into DTTB using Monte Carlo simulation poses some unique problems. If the network being modelled does not change with time from the victim receiver perspective, i.e. the interferer position is fixed, and the transmitted power is constant, then there is a single interference event and the calculated p_I using a Monte Carlo simulation is valid for any time window.

In the case of fixed interferers with variable transmitted power the variation of the power should be taken into account in the calculation of p_I .

Moreover, if the interferer is moving and thus causing interference through its way to different DTT receivers, then the calculated probability of interference is only valid for one moment in time or state

of the network. In such case, p_I should be post processed to calculate the probability of disruption (p_d) which is the probability that one or more interference events occurring in the time window TW .

Two methods are presented in this report that allow an assessment of the risk of interference from dynamic networks into DTTB reception. The first method deals with fixed interferers, such as base stations (BS), which switch between low and full power. This involves a dual pass Monte Carlo simulation approach to take into account the variation of the BS power and calculate p_I .

The second deals with moving interferers, such as user terminals (UT). This second method relies on post processing of a normal Monte Carlo simulation outcome to calculate p_d occurring in the time window TW .

Both these methods should be used when Monte Carlo simulation are carried out to assess compatibility of other services with DTTB.

5 Abbreviations

DRSS	Desired received signal strength
DT	Average decorrelation time between two consecutive interference states
DTTB	Digital terrestrial television broadcasting
IMT	International Mobile Telecommunications
IRSS	Interfering received signal strength
PC	Power control
QoS	Quality of service
SEAMCAT	Spectrum Engineering Advanced Monte Carlo Analysis Tool
TL	Data throughput loss
TW	Time window
UT	User terminal

6 References

- [1] Report ITU-R SM.2028-2 – *Monte Carlo simulation methodology for the use in sharing and compatibility studies between different radio services or systems*, June 2017.
- [2] Report ITU-R BT.2383-1 – *Characteristics of digital terrestrial television broadcasting systems in the frequency band 470-862 MHz for frequency sharing/interference analyses*, October 2016.
- [3] Report ITU-R M.2292-0 – *Characteristics of terrestrial IMT-Advanced systems for frequency sharing/interference analyses*, December 2013.
- [4] GE06 Agreement, *Final Acts of the Regional Radiocommunication Conference for planning of the digital terrestrial broadcasting service in parts of Regions 1 and 3, in the frequency bands 174-230 MHz and 470-862 MHz* (RRC-06).
- [5] ECC Report 281, *Analysis of the suitability of the regulatory technical conditions for 5G MFCN operation in the 3400-3800 MHz band*, 6 July 2018.
- [6] Report ITU-R BT.2301-2 – *National field reports on the introduction of IMT in the bands with co-primary allocation to the broadcasting and the mobile services*, October 2016.
- [7] Probability, Random Variables and Stochastic Processes, Athanasios Papoulis, Mc Graw Hill, 1984.
- [8] Harmonization Meeting on 3GPP HSDPA and 3GPP2 1xEV-DV Work, New Jersey, 13-14 November 2001.

- [9] Report ITU-R M.2039 – *Characteristics of terrestrial IMT-2000 systems for frequency sharing/interference analyses*, November 2014.
- [10] ‘The UMTS Network and Radio Access Technology: Air Interface Techniques for Future Mobile Systems’, Jonathan P Castro, page 34.
- [11] ‘Correlation Model for Shadow fading in Mobile Radio Systems’, M. Gudmundson, 5 Sept. 1991, *Electronic letters* 7 November 1991, Vol. 27 No. 23.

Annex 1

Calculation of the probability of non-interference for the protection criteria other than $C/(I+N)$

Calculation of the probability of non-interference (p_{NI}) for the protection criteria other than $C/(I+N)$ is derived straight forward from equation (7) including the logical checks required:

For C/I :

$$p_{NI} = \frac{\sum_{i=1}^M 1 \left\{ \left(\frac{dRSS(i)}{iRSS_{composite}(i)} \geq \frac{C}{I} \right) \wedge \left(\frac{dRSS(i)}{iRSS_{PMAx_{max}(i)}} \geq \frac{C}{I} \right) \right\}}{M}$$

For I/N :

$$p_{NI} = \frac{\sum_{i=1}^M 1 \left\{ \left(\frac{iRSS_{composite}(i)}{N} \geq \frac{I}{N} \right) \wedge \left(\frac{iRSS_{PMAx_{max}(i)}}{N} \geq \frac{I}{N} \right) \right\}}{M}$$

For $(N+I)/N$:

$$p_{NI} = \frac{\sum_{i=1}^M 1 \left\{ \left(\frac{iRSS_{composite}(i)+N}{N} \geq \frac{(N+I)}{N} \right) \wedge \left(\frac{iRSS_{PMAx_{max}(i)+N}}{N} \geq \frac{(N+I)}{N} \right) \right\}}{M}$$

For overloading threshold (O_{th}):

$$p_{NI} = \frac{\sum_{i=1}^M 1 \left\{ \left((iRSS_{composite}(i) - O_{th}) < 0 \right) \wedge \left((iRSS_{PMAx_{max}(i)} - O_{th}) < 0 \right) \right\}}{M}$$

Annex 2

Relationship between the probability of interference and the I/N

The edge of the broadcasting coverage area is defined as the point at which the reception location probability is reduced to a specified value. The DTTB reception location probability is usually taken to be 95%.

As explained in § 3.2.1, when assessing the risk of interference from fixed interferers into DTTB reception, the p_I calculated by Monte Carlo simulation is equal to the degradation of the reception

location probability (Δp_{RL}) of DTTB. Consequently, a given p_I to DTTB reception, which is equal to the DTTB Δp_{RL} , can be mapped onto a receiver noise floor degradation, in other words the DTTB receiver desensitization, which is expressed as an I/N . Then, it is of interest to know the value of p_I for a given I/N . The calculation of the p_I is straight forward from equations (4) and (5):

$$p_I = \Delta p_{RL} = p_{RLref} - p'_{RL} \quad (14)$$

where:

p_{RLref} : planned reception location probability

p'_{RL} : reduced reception location probability due to the DTTB receiver desensitization.

Note that thermal noise generated in a DTTB receiver can be considered as white noise ($\mu_N = 0$ and $\sigma^2_N = 1$). Consequently, the standard deviation of the receiver noise floor is assumed to be 0 dB. Therefore, for the sake of consistency, in the analytical calculation to map various p_I onto corresponding I/N s, the standard deviation of the interfering signal is also assumed to be 0 dB. The obtained results are presented in Table 2.

TABLE 2
 p_I and corresponding I/N s – analytical calculation results

Relationship between p_I and I/N s						
	p_{RLref}	p_{RL1}	p_{RL2}	p_{RL3}	p_{RL4}	Notes
Reception location probability p_{RL} (%)	95	94.918 4	94.174 5	92.891 0	86.379 5	
Probability of interference $p_I = \Delta p_{RL}$ (%)	N/A	0.086	0.869	2.22	9.074	$p_I = \Delta p_{RL} = p_{RLref} - p_{RLx}$
Gaussian confidence factor μ	1.644 9	1.637 0	1.569 6	1.467 7	1.097 5	
Location variability σ (dB)	5.5	5.5	5.5	5.5	5.5	
Location correction factor C_f (dB)	9.046 7	9.003 5	8.632 8	8.072 5	6.036 4	$C_f = \mu * \sigma$
Receiver noise floor N (dBm)	-98.2	-98.2	-98.2	-98.2	-98.2	$F + 10 \log(k * T * B * 10^6) + 30$
Equivalent desensitization D (dB)	N/A	0.043 2	0.413 9	0.974 2	3.010 3	$D = C_{f,ref} - C_{f,x}$
Reduced receiver noise floor N' (dBm)	N/A	-98.156 8	-97.786 1	-97.225 8	-95.189 7	$N' = N_{ref} - D$
Equivalent I/N (dB)	N/A	-20	-10	-6	0	$I/N = 10 * \log_{10}(10^{N'/10} - 10^{N/10}) - N$
Equivalent interfering signal level I (dBm)	N/A	-118.2	-108.2	-104.2	-98.2	$I = N_{ref} - (I/N)$

Monte Carlo simulation has been carried out to confirm the relationship between p_I and I/N presented in Table 2. The radio parameters of DTTB system used in simulations are presented in Annex 4.

A very simple interference scenario was used:

- 1 the minimum signal level at the DTTB receiver at coverage edge is -68.12 dBm (56.72 dB μ V/m, see Annex 4);

- 2 a pixel of 100 m × 100 m is positioned at the DTTB coverage edge;
- 3 the DTTB receiver is randomly positioned, following a uniform distribution, in the pixel;
- 4 the reception location probability within the pixel in the presence of noise only is 95%, which correspond to a noise floor degradation (Δp_{RL}) of 0%;
- 5 an 8 MHz bandwidth interfering transmitter is positioned at 1 m from the DTTB receiver. The interfering signal is pointing towards the DTT receiver with relative azimuth and elevation angles of 0°. The relative position between the DTTB receiver and the interfering transmitter is fixed (invariable);
- 6 DTTB and interfering transmitter both transmitting at 690 MHz;
- 7 the probability of interference is calculated according to equation (2);
- 8 number of events generated by Monte Carlo simulation is 200 000.

Based on the above scenario the relationship between p_I and I/N presented in Table 2 has been checked by Monte Carlo simulation based on three different methods:

Method 1: by fixing the interfering signal level to $-1\ 000$ dBm (absence of interfering signal) and reducing the noise floor of the receiver by the amount of desensitization (D) corresponding to the I/N values -20 , -10 , -6 and 0 . Note that thermal noise can be considered as white noise ($\mu_N = 0$ and $\sigma_N^2 = 1$). Consequently, the standard deviation of the noise is set to 0 dB in simulations.

Method 2: by keeping the receiver noise floor unchanged (-98.2 dBm) and setting the interfering signal level at the DTTB receiver input to the equivalent interfering signal level corresponding to the I/N values -20 , -10 , -6 and 0 respectively. The bandwidth of the interfering signal is 8 MHz and its standard deviation (σ_I) is 0 dB.

Method 3: by keeping the receiver noise floor unchanged (-98.2 dBm) and setting the interfering signal level at the DTTB receiver input to the equivalent interfering signal level corresponding to the I/N values -20 , -10 , -6 and 0 respectively. The standard deviation of the interfering signal (σ_I) is 5.5 dB. This method is used in Report ITU-R BT.2265 (see Attachment 1 to Annex 2 of Report ITU-R BT.2265).

The results obtained by Monte Carlo simulation are presented in Table 3.

TABLE 3
 p_I and corresponding I/N s – Monte Carlo simulation results

Relationship between p_I and I/Ns					
Analytical calculation results from Table 2					
Equivalent I/N (dB)	$-\infty$	-20	-10	-6	0
$p_I = \Delta p_{RL}$ (%)	0.000	0.086	0.869	2.22	9.074
Monte Carlo simulation results					
METHOD 1: Noise only ($\sigma_N = 0$ dB)					
p_I (%)	0.000	0.082	0.863	2.177	9.005
METHOD 2: Noise ($\sigma_N = 0$ dB) + Interfering signal ($\sigma_I = 0$ dB)					
p_I (%)	0.000	0.091	0.870	2.194	9.081
METHOD 3: Noise ($\sigma_N = 0$ dB) + Interfering signal ($\sigma_I = 5.5$ dB)					
p_I (%)	0.000	0.185	1.987	4.705	14.985

As clearly shown in Table 3, the results obtained by Monte Carlo simulation using Methods 1 and 2 confirm the results of the mapping of the p_I onto various I/N s in Table 2 (results obtained by analytical calculation). While, the results of the Method 3 seem not to be in line with the results of Table 2.

This can be explained by the fact that the third method uses an interfering signal which is not white and has a standard deviation that is greater than zero. The I/N calculated from an interfering signal and noise both having 0 dB standard deviation and that calculated from the mean value of an interfering signal having 5.5 dB and noise having 0 dB standard deviations are not equal. Nevertheless, in the latter case the actual equivalent I/N can be found by referring to the mapping of the p_I onto I/N s done by analytical calculation. For example, the p_I of 1.987 calculated by Method 3 corresponds approximately to an I/N of -6 dB and not -10 dB.

In conclusion, the mapping of the p_I onto I/N s should be done based on the analytical calculations as described in Table 2. A set of p_I and corresponding I/N s are presented in Table 4.

TABLE 4

Required probability of interference in a 100 m × 100 m pixel at the edge of DTTB coverage

Required probability of interference (p_I) for 95% locations equivalent to the protection in a 100 m × 100 m pixel at the edge of DTTB coverage provided in Rec. ITU-R BT.1895			
$p_I = \Delta p_{RL}$ (%) (95% locations)	0.086	0.869	2.22
Equivalent I/N (dB)	-20	-10	-6

Note 1: The I/N of -20 and -10 dB are equivalent to guideline values provided in Rec. ITU-R BT.1895. The I/N of -6 dB is a further value beyond BT.1895 that is often used in compatibility studies within some regions.

Note 2: 95% locations served at cell edge is equivalent to $99.4 \leq X \leq 99.6$ (see Annex 5) by cell area³.

Annex 3

Relationship between the probability of disruption and the degradation of the reception location probability

In the case of fixed interferers, as demonstrated in § 3.2.1, the p_I calculated by Monte Carlo simulation is an estimation of the degradation of the reception location probability (Δp_{RL}). That is a p_I of 2% calculated in a pixel of 100 m × 100 m means that in the 2% of the area of the pixel all the DTTB receivers may be interfered with by the fixed interferers. The interfered areas appear as fixed holes (or areas) where the required Quality of Service (QoS) cannot be ensured, which shows directly the impact of the interference on DTTB coverage.

In the case of moving interferers, the p_I calculated by Monte Carlo simulation cannot be directly used to assess the impact of interference on the DTTB coverage as the impact of such interferers on the DTTB coverage area does not appear as fixed holes (or areas) where the required QoS cannot be ensured. This is the reason why the p_d was introduced in § 3.2.1, which is the probability that at least

³ An estimate of the relationship between cell edge and area coverage is provided by Jakes, Microwave Mobile Communications, section 2.5.3, p. 126, IEEE press 1993.

one interference event occurs to the received signal (e.g. picture) in a time window⁴ (TW). In other words, the p_d is the probability that the required QoS cannot be ensured in the TW .

Deciding what is the acceptable p_d could be more subjective than deciding the acceptable p_I which is equal to the Δp_{RL} in the case of fixed interferers. Clearly the problem lies with how to relate the p_d to Δp_{RL} .

p_d is related to p_I by the following equation (see § 3.3.1):

$$p_d = 1 - (1 - p_I)^n$$

where:

p_I : probability of interference calculated in the presence of moving interferers

n : number of independent events with probability p_I in the specified TW

p_d : probability of disruption.

If each event is independent and does not overlap another event and p_I is represented as a very small interfered area, then it could be concluded that Δp_{RL} is simply the sum of p_I :

$$\Delta p_{RL} = np_I$$

However, whilst interference events are considered independent, since the interferers are moving, the interference areas may overlap. As such the Δp_{RL} should diverge away from the sum of p_I as p_d increases; this can occur due to a great number of events or a higher p_I .

As an example of such divergence, Fig. 5 shows an area 20×20 (400 sq units). Our interference p_I is 0.01 which represents 4 sq units. If there are 6 events ($n = 6$) shown as the green squares. If there was no overlap the sum of p_I would be $6 \times 4 = 24$ units. However, with overlap the total area (coloured green) is reduced, in this example to 21 squares.

FIGURE 5

Example of overlap summation of interfering areas (Overlap sum p_I)

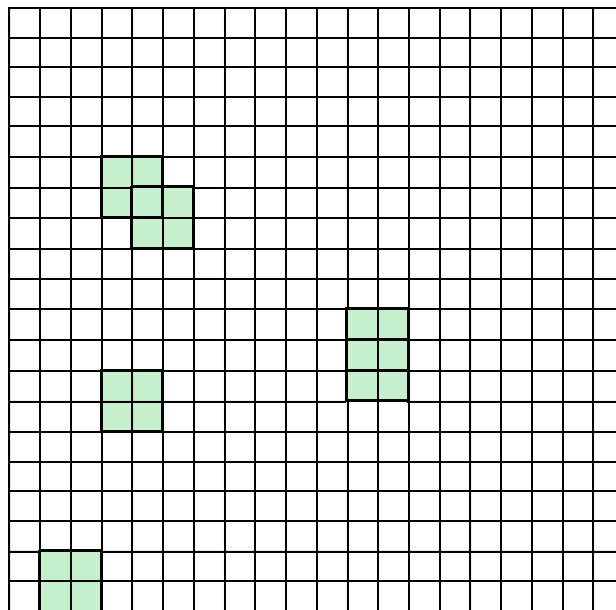

⁴ DTTB quality of service is assessed in a one-hour time window.

This divergence has been demonstrated for a given p_I and number of events (n). The p_d and sum of p_I allowing overlap (Overlap sum p_I) have been compared.

The sum of p_I with overlap has been calculated by taking known areas of 1.0, 1.96, 2.98, 4.0, ... square meters and placing n of them (285⁵ or 2 850) randomly in a 100 m × 100 m pixel (each individual area was always contained within the pixel with no overlap beyond the edge of the pixel, but individual areas could overlap). These individual areas representing p_I of 0.000 01, 0.000 019 6, 0.000 028 9, 0.000 04, etc. The process was repeated 1 000 times for each combination of n and p_I .

The percentage sum of the area they cover with overlap is the reduction in locations (Overlap sum p_I). Figures 6 and 7 show the results obtained for $n = 285$ and $n = 2 850$.

FIGURE 6

Relation between the probability of disruption and the degradation of the reception location probability $n = 285$

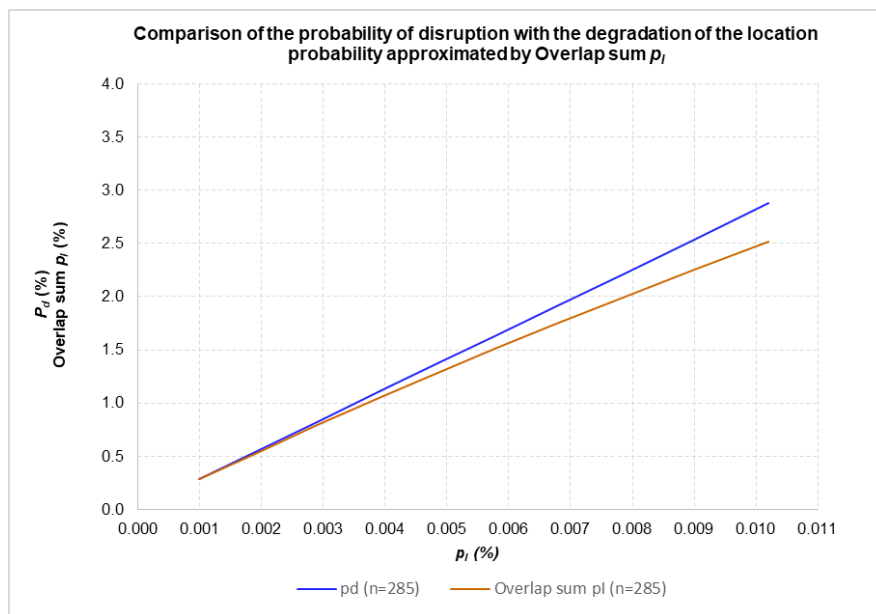

⁵ Number of events in single UT example simulation are provided in Annex 6, Table 11.

FIGURE 7
 Relation between the probability of disruption and the degradation
 of the reception location probability $n = 2\ 850$

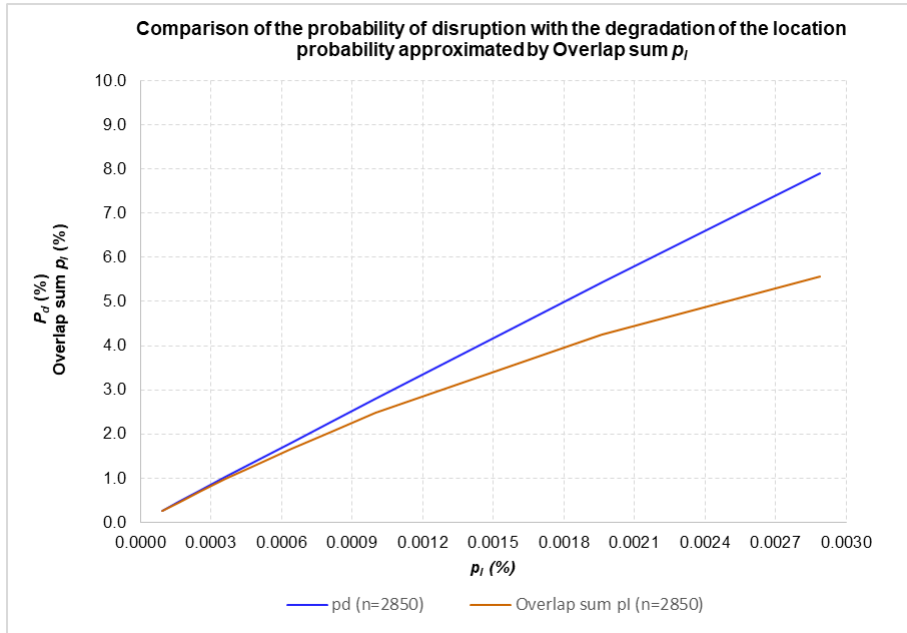

The full results are presented in Table 5.

TABLE 5
 Calculated p_d , Sum p_i and Overlap Sum p_i in a $100\text{ m} \times 100\text{ m}$ pixel

Comparison of the probability of disruption with the degradation of the location probability approximated by Overlap sum p_i										
Number of events (n) = 285										
p_i	1.00E-05	1.96E-05	2.89E-05	4.00E-05	4.84E-05	5.76E-05	6.76E-05	7.84E-05	9.00E-05	1.02E-04
p_d %	0.284 596	0.557 048 2	0.820 279 1	1.133 549	1.369 962 8	1.628 245 7	1.908 223 6	2.209 707 8	2.532 496	2.876 371
Sum p_i %	0.285 00	0.558 60	0.823 65	1.140 00	1.379 40	1.641 60	1.926 60	2.234 40	2.565 00	2.918 40
Overlap sum p_i %	0.280 948	0.542 906 2	0.789 763	1.075 528	1.285 640 4	1.509 715 5	1.746 287 6	1.993 872 7	2.250 852	2.515 557
Number of events (n) = 2 850										
p_i	9.00E-07	1.60E-06	2.50E-06	3.60E-06	4.90E-06	6.40E-06	8.10E-06	1.00E-05	1.96E-05	2.89E-05
p_d %	0.256 171	0.454 962	0.709 969	1.020 756	1.386 798	1.807 472	2.282 067	2.809 784	5.432 9	7.906 534
Sum p_i %	0.256 50	0.456 00	0.712 50	1.026 00	1.396 50	1.824 00	2.308 50	2.850 00	5.586 00	8.236 50
Overlap sum p_i %	0.253 212	0.445 704	0.687 562	0.974 776	1.302 558	1.665 764	2.058 746	2.475 506	4.259 624	5.568 724

The results of the calculations show that there is an equivalence between the probability of disruption (p_d) and the degradation of the reception location probability (Δp_{RL}) for p_d values lower than 1%. Up to a p_d of 3% there is good correlation with Δp_{RL} . For higher p_d values the high divergence between p_d and the Δp_{RL} calculated by Overlap sum p_i prevents their direct comparison for the benefit of p_d .

Annex 4

Example Monte Carlo simulation for fixed and mobile interferers

A4.1 Introduction

The study presented in this annex is a generic compatibility study and not a compatibility study between DTTB and an existing interfering system. It deals with two basic compatibility scenarios:

- DTTB interfered with by fixed interferers with a fixed guard band (64 MHz) and a fixed interfering signal ACLR (200 dB);
- DTTB interfered with by moving interferers with a fixed guard band (9 MHz) and a fixed DTTB ACS (65 dB).

The detailed link budget and radio parameters of DTTB system and interfering system are presented in this annex.

A4.2 Fixed interferers

The following example gives an insight into the impact fixed interferers have on DTTB coverage. Note that for the sake of simplicity a single base station (BS) interferer with hexagonal three sector cell layout has been used in this example (see Fig. 8). Usually, in compatibility studies, one or two rings of base stations around the central base station are modelled. A single ring model would consist of 7 BS (21 hexagonal-shaped sectors) and a double ring model of 19 BS (57 hexagonal-shaped sectors). With each increase in the number of modelled base stations the run-time of the simulation increases in proportion.

To determine the acceptable p_I at the edge of the coverage area of DTTB network, the impact of a mobile network, in this example called “System A”, on DTTB reception has been assessed using Monte Carlo simulation. 400×10^3 events were simulated for each interference configuration considered. The impact across the whole DTTB coverage area has also been considered. Note that the interfering transmitter ACLR is assumed to be 200 dB to prevent any p_I threshold due to the interfering signal out-of-band emissions (OOBE).

This approach allows the benefit of improving the ACS of the DTTB receiver or the guard band between the victim and the interfering systems to be evaluated. Doing so will identify the limitation of the DTTB system to improve the p_I if the in-block power of the interfering system cannot be reduced. In fact, the ACS of a victim receiver cannot attenuate the interfering transmitter OOBE falling into the receiver channel. Therefore, in the presence of a finite interfering transmitter ACLR the improvement of the victim receiver ACS results in a p_I threshold when the received interfering in-band emissions power is equal to the interfering signal OOBE power.

The results of the simulations carried out for two different DTTB coverage radii are presented in Fig. 8 and Annex 5.

FIGURE 8
 Monte Carlo simulation results – Fixed interferers

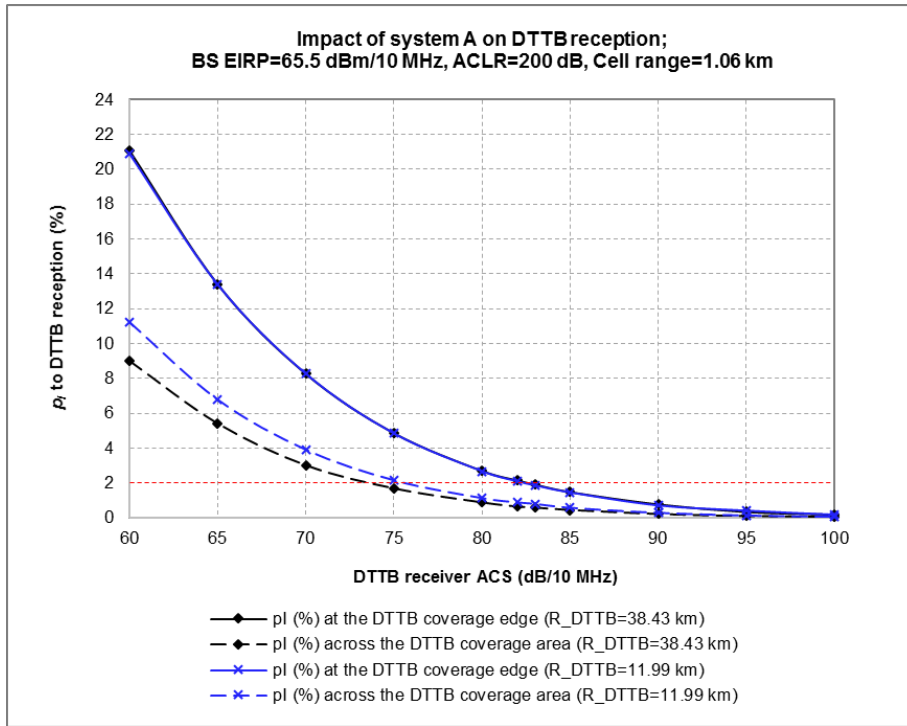

Figure 8 shows the variation of the p_I to DTTB reception as a function of the DTTB receiver ACS, for two different DTTB coverage radii: 38.43 km and 11.99 km for high and medium power DTTB transmitters respectively.

FIGURE 9
 Monte Carlo simulation results – Fixed interferers

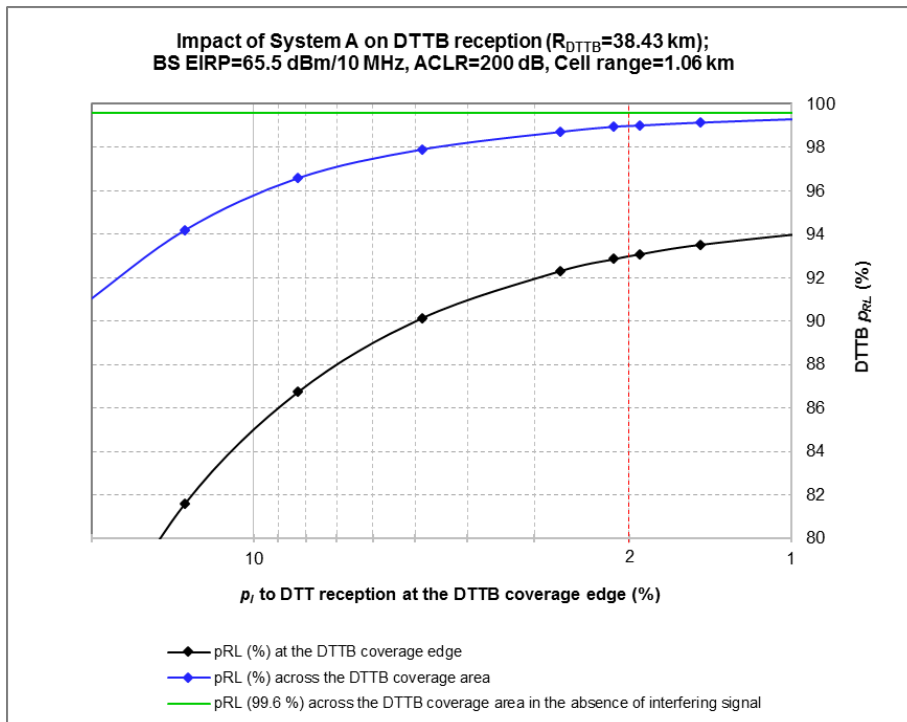

Figure 9 shows the variation of the DTTB reception location probability (p_{RL}) as a function of the p_I to DTTB reception at the coverage edge for the coverage radii of 38.43 km.

More detailed simulation results are provided in Annex 5.

A4.3 Moving interferers

The following example gives an insight into the impact moving interferers may have on DTTB reception. Note that for the sake of simplicity a single BS interferer with a single hexagonal three sector cell layout has been used in this example (see Fig. 11). A single ring model would consist of seven BS (21 hexagonal-shaped sectors) and a double ring model of 19 BS (57 hexagonal-shaped sectors). Associated with each BS and each sector will be a number of user terminals (UT) which add additional calculations and hence time to the simulation when compared to the fixed interferer example. As with the fixed interferer example each increase in the number of modelled base stations the run-time of the simulation increases in proportion. Any simulation is a compromise between computing time and accuracy of the simulation – a judgement having to be made at what point computation time outweighs the benefit of adding additional elements.

It is also worth noting that in current mobile networks using OFDMA, the resource block (RB) allocation may have an impact on the ACLR of the equipment used. The minimum ACLR of UT may be defined for full channel bandwidth occupation (full use of the available RB). When a UT is transmitting with a reduced number of RB, its ACLR would probably also be reduced and in such cases a correction factor (improved ACLR) should be applied. In this example, an ACLR correction factor of 5 dB is applied when reducing the number of RB from 50 (the case if a single UT uses all available resources) to 25 (the case when 2 UT share the available resources equally). 11 500 × 10³ events were simulated for each interference configuration considered.

For the scenario modelled the p_I has been calculated and then been post-processed, based on values in Table 8 in Annex 5, to derive the p_d to DTTB.

FIGURE 10
Monte Carlo simulation results – Moving interferers

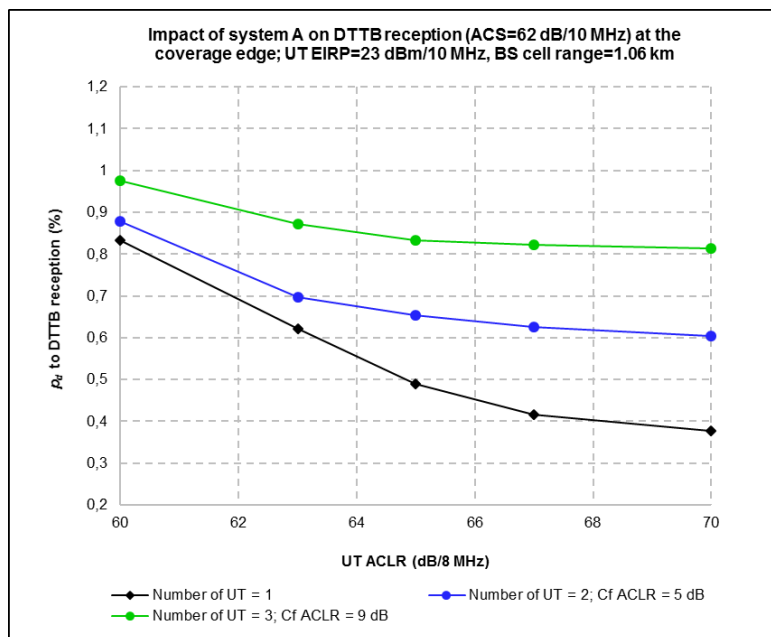

Figure 10 shows the variation of the p_d to DTTB reception at the cell edge as a function of the DTTB receiver ACS, for 1 and 2 transmitting UT. More detailed simulation results are provided in Annex 6.

Annex 5

System parameters used in the example Monte Carlo simulations

TABLE 6

DTTB system radio parameters

DTTB link budget for fixed roof top reception				
DVB-T transmitter parameters (from Report ITU-R BT.2383)				
	Unit	High power transmitter	Medium power transmitter	Notes
e.i.r.p.	dBm	85.15	69.15	For 200 kW, 5 kW and 0.250 kW transmitters respectively
Antenna height	m	300.00	150.00	
DVB-T receiver parameters (from Report ITU-R BT.2383)				
Antenna height	m	10.00	10.00	
Center frequency	MHz	690.00	690.00	Channel 48
Channel BW	MHz	8.00	8.00	
Effective BW	MHz	7.6	7.6	
Noise figure (F)	dB	7	7	
Boltzmann's constant (k)	J/K	1.38E-23	1.38E-23	
Absolute temperature (T)	K	290	290	
Noise power (P_n)	dBm	-98.17	-98.17	$P_n(\text{dBm}) = F + 10\log(k \cdot T \cdot B \cdot 10^6) + 30$
Carrier-to-noise ratio (C/N) at cell edge	dB	21	21	
Protection criterion ($C/(I+N)$)	dB	21	21	See GE06 Agreement, Table A.3.3-11
Receiver sensitivity (P_{min}) *	dBm	-77.17	-77.17	$P_{min} = P_n(\text{dBm}) + SNR(\text{dB})$
Cell edge location probability (LP)	%	95	95	
Gaussian confidence factor for cell edge coverage probability of 95% ($\mu_{95\%}$)	%	1.64	1.64	
Shadowing loss standard deviation (σ)	dB	5.50	5.50	
Log normal fading margin (L_m) for 95%	dB	9.05	9.05	$L_m = \mu_{95\%} * \sigma$
P_{mean} for LP = 95%	dBm	-68.12	-68.12	$P_{mean} = P_{min} + L_m$
Minimum field strength*	dB μ V/m	56.72	56.72	
Cable loss (L_{cable})	dB	4.40	4.40	
Antenna gain (G_{iso}) *	dBi	13.55	13.55	

TABLE 6 (end)

DTTB link budget for fixed roof top reception				
DVB-T transmitter parameters (from Report ITU-R BT.2383)				
	Unit	High power transmitter	Medium power transmitter	Notes
$G_{iso} \cdot L_{cable}$	dB	9.15	9.15	
Max allowed path loss (L_p)	dB	162.42	146.42	$L_p = EIRP + (G_{iso} \cdot L_{cable}) - P_{mean}$
Coverage radius calculated by ITU-R P.1546 propagation model (Beam tilts=1° and 1.6°)	km	38.43	11.99	Urban

* In this example, a fixed DTTB antenna without a built-in amplifier considered. It should be noted that other types of receiving antennas (like an antenna with internal amplifier) also may be taken into account to allow accurate representation of real situation in some areas, for example rural areas or areas with local obstacles causing difficulties of DTTB reception.

TABLE 7

Example "System A" radio parameters

Example "System A" link budget for macro urban and suburban scenarios						
Radio parameters						
		Downlink		Uplink		
	Unit	BS ⇌ UT	Link	UT ⇌ BS	Link	Notes
Center frequency	MHz	763.00	BS	708.00	UT	
Channel BW	MHz	10.00	BS	10.00	UT	
Number of resource blocks (RB) used		50	BS	1	UT	
RB BW	MHz	0.18	BS	0.18	UT	
Effective BW	MHz	9	BS	0.18	UT	
Noise figure (F)	dB	7	UT	3	BS	Values usually used in mobile network planning
Boltzmann's constant (k)	J/K	1.38E-23		1.38E-23		
Absolute temperature (T)	K	290		290		
Noise power (P_n)	dBm	-97.43	UT	-118.42	BS	$P_n(\text{dBm}) = F + 10\log(k \cdot T \cdot B \cdot 10^6) + 30$
SINR at cell edge	dB	1		0		
Link throughput at cell-edge	Kbit/s	≈5000	UT	≈20	BS	
Receiver sensitivity (P_{min})	dBm	-96.43	UT	-118.42	BS	
Cell edge coverage probability	%	86.9		86.9		Value usually used in mobile network planning for a cell coverage probability of 95%
Gaussian confidence factor for cell edge coverage probability (μ)		1.12		1.12		
Shadowing loss standard deviation (σ)	dB	9.00		9.00		Value usually used in mobile network planning
Building entry loss standard deviation (σ_w)	dB	6.00		6.00		Value usually used in mobile network planning

TABLE 7 (end)

Example "System A" link budget for macro urban and suburban scenarios						
Radio parameters						
		Downlink		Uplink		
	Unit	BS ⇌ UT	Link	UT ⇌ BS	Link	Notes
Total loss standard deviation (σ_T)	dB	10.82		10.82		$\sigma_T = \text{SQRT}(\sigma^2 + \sigma_w^2)$
Log normal fading margin (L_m)	dB	12.13		12.13		$L_m = \mu_{82\%} * \sigma_T$
P_{mean} for a cell coverage probability of 95 %	dBm	-84.30	UT	-106.29	BS	$P_{mean} = P_{min} + L_m$
Max Tx power	dBm	46.00	BS	23.00	UT	
Number of Tx (MIMO)		2	BS	1	UT	
Max Tx power (MIMO)	dBm	49.01	BS	23.00	UT	
Maximum Tx EIRP (MIMO)	dBm	65.51	BS	20.00	UT	
Antenna height	m	30.00	BS	1.50	UT	
Cable loss (L_{cable})	dB	0.50	BS	0.00	UT	Value usually used in mobile network planning for BS cable loss is 0,5 ⁽²⁾ -3 dB
Antenna gain (G_{iso})	dBi	17.00	BS	-3.00	UT	Value usually used in mobile network planning for BS antenna gain
$G_{iso} - L_{cable}$	dBi	-3.00	UT	16.50	BS	
Average building entry loss (L_{wall})	dB	15.00		15.00		Value usually used in mobile network planning for urban environment
Typical body loss	dB	3.00		3.00		Value usually used in mobile network planning
Max allowed path loss (L_{pmax})	dB	128.81		124.79		$L_p = EIRP + (G_{iso} - L_{cable}) - L_{wall} - L_{body} - P_{mean}$
Cell radius calculated by Extended Hata propagation model	km		r_{BS}	1.06		Urban: cell radius ⁽¹⁾ calculated from min L_{pmax}

(1) As defined in Report ITU-R M.2292.

(2) Feederless solution – There are only jumper cables between RF Module and antenna connectors. This is the best performing solution from the coverage and capacity point of view since it introduces only a small loss of about 0.5 dB. This solution is widely used not to say generalised.

FIGURE 11

System A hexagonal three sector cell layout of a mobile service base station (R: cell range)

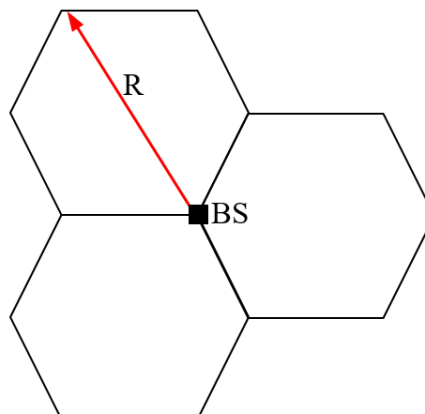

TABLE 8

Example radio parameters

Parameters used to calculate “ <i>n</i> ” and “ <i>DT</i> ”			
BW = 10 MHz; Max number of connected UT per sector = 400; Max number of active UT per sector = 100 Max number of active UT per TTI = 10 Max number of active UT per sector in the MC simulations = 2			
V_{in} (m/h)	$V_{out\ ped}$ (m/h)	$V_{out\ veh}$ (m/h)	TW (h)
1 000	3 000	50 000	1
D_{in} (m)	$D_{out\ ped}$ (m)	$D_{out\ veh}$ (m)	
5	20	20	
P_{in}	$P_{out\ ped}$	$P_{out\ veh}$	
0.7	0.3	0	

Annex 6

Results of the example Monte Carlo simulations

TABLE 9

Impact of System A on DTTB reception – Fixed interferer

Impact of System A on DTTB reception – High power DTTB transmitter ($r_{DTTB} = 38.43$ km) BS EIRP = 65.5 dBm/10 MHz, ACLR = 200 dB/8 MHz, Cell range = 1.06 km					
Noise limited DTTB coverage edge LP (%)			95		
Noise limited DTTB coverage LP (%)			99.6		
DTTB ACS (dB/10 MHz)	PI (%) at the DTTB coverage edge	PI (%) in the whole DTTB coverage area	DTTB coverage edge LP (%)	DTTB coverage LP (%)	DTTB coverage LP degradation due to interferers (%)
60	21.08	9.00	73.92	90.60	9.00
65	13.41	5.41	81.59	94.19	5.41
70	8.27	3.01	86.73	96.59	3.01
75	4.86	1.68	90.14	97.92	1.68
80	2.69	0.87	92.31	98.73	0.87
82	2.14	0.63	92.86	98.97	0.63
83	1.91	0.57	93.09	99.03	0.57
85	1.47	0.44	93.53	99.16	0.44
90	0.76	0.21	94.24	99.39	0.21
95	0.33	0.09	94.67	99.51	0.09
100	0.17	0.04	94.83	99.56	0.04

TABLE 10

Impact of System A on DTTB reception – Fixed interferer

Impact of System A on DTTB reception – Medium power DTTB transmitter ($r_{DTTB} = 11.99$ km) BS EIRP = 65.5 dBm/10 MHz, ACLR = 200 dB/8 MHz, Cell range = 1.06 km					
Noise limited DTTB coverage edge LP (%)			95		
Noise limited DTTB coverage LP (%)			99.4		
DTTB ACS (dB/10 MHz)	PI (%) at the DTTB coverage edge	PI (%) in the whole DTTB coverage area	DTTB coverage edge LP (%)	DTTB coverage LP (%)	DTTB coverage LP degradation due to interferes (%)
60	20.90	11.21	74.10	88.19	11.21
65	13.39	6.77	81.61	92.63	6.77
70	8.26	3.90	86.74	95.50	3.90
75	4.83	2.15	90.17	97.25	2.15
80	2.66	1.12	92.34	98.28	1.12
82	2.08	0.87	92.92	98.53	0.87
83	1.85	0.79	93.15	98.61	0.79
85	1.44	0.57	93.56	98.83	0.57
90	0.69	0.28	94.31	99.13	0.28
95	0.39	0.12	94.61	99.28	0.12
100	0.15	0.05	94.85	99.35	0.05

TABLE 11

Impact of System A on DTTB reception – Moving interferer

DTTB ACS = 62 dB/10 MHz, Number of UT = 1			
M	A	n	DT (s)
100	1	285	12.63
UT ACLR (dB/8 MHz)	PI	Pd	Pd (%)
60	2.93E-05	8.32E-03	0.83
63	2.19E-05	6.22E-03	0.62
65	1.72E-05	4.89E-03	0.49
67	1.46E-05	4.15E-03	0.42
70	1.33E-05	3.77E-03	0.38

TABLE 12

Impact of System A on DTTB reception – Moving interferers

DTTB ACS = 62/10 MHz dB; Number of UT = 2; $C_{ACLR} = 5$ dB			
M	A	n	DT (s)
100	2	235	15.32
UT ACLR (dB/8 MHz)	PI	Pd	Pd (%)
60	3.75E-05	8.78E-03	0.88
63	2.98E-05	6.97E-03	0.70
65	2.79E-05	6.55E-03	0.65
67	2.67E-05	6.25E-03	0.62
70	2.57E-05	6.03E-03	0.60

Effective ACLR=UT ACLR+5 dB

TABLE 13

Impact of System A on DTTB reception – Moving interferers

DTTB ACS = 62/10 MHz dB; Number of UT = 3; $C_{ACLR} = 9$ dB			
M	A	n	DT (s)
100	3	218.33	16.49
UT ACLR (dB/8 MHz)	PI	Pd	Pd (%)
60	4.50E-05	9.77E-03	0.98
63	4.01E-05	8.71E-03	0.87
65	3.83E-05	8.33E-03	0.83
67	3.79E-05	8.23E-03	0.82
70	3.74E-05	8.14E-03	0.81

Effective ACLR=UT ACLR+9 dB