

I n t e r n a t i o n a l T e l e c o m m u n i c a t i o n U n i o n

ITU-T

TELECOMMUNICATION
STANDARDIZATION SECTOR
OF ITU

FG-DR&NRR

Version 1.0
(05/2014)

ITU-T Focus Group on Disaster Relief Systems, Network
Resilience and Recovery

**Promising technologies and use cases
– Part IV and V**

Focus Group Technical Report



FOREWORD

The International Telecommunication Union (ITU) is the United Nations specialized agency in the field of telecommunications, information and communication technologies (ICTs). The ITU Telecommunication Standardization Sector (ITU-T) is a permanent organ of ITU. ITU-T is responsible for studying technical, operating and tariff questions and issuing Recommendations on them with a view to standardizing telecommunications on a worldwide basis.

The procedures for establishment of focus groups are defined in Recommendation ITU-T A.7. The ITU-T Focus Group on Disaster Relief Systems, Network Resilience and Recovery (FG-DR&NRR) was established further to ITU-T TSAG agreement at its meeting in Geneva, 10-13 January 2012. ITU-T Study Group 2 is the parent group of FG-DR&NRR. This Focus Group was successfully concluded in June 2014.

Deliverables of focus groups can take the form of technical reports, specifications, etc. and aim to provide material for consideration by the parent group or by other relevant groups in its standardization activities. Deliverables of focus groups are not ITU-T Recommendations.

SERIES OF FG-DR&NRR TECHNICAL REPORTS

Technical Report on Telecommunications and Disaster Mitigation

Overview of Disaster Relief Systems, Network Resilience and Recovery

Promising technologies and use cases – Part I, II and III

Promising technologies and use cases – Part IV and V

Gap Analysis of Disaster Relief Systems, Network Resilience and Recovery

Terms and definitions for disaster relief systems, network resilience and recovery

Requirements for Disaster Relief System

Requirements for network resilience and recovery

Requirements on the improvement of network resilience and recovery with movable and deployable ICT resource units

ITU-T FG-DR&NRR Deliverable**Promising technologies and use cases – Part IV and V****Summary**

Based on the contributions to FG-DR&NRR meetings, this document provides an integrated view of promising technologies for Disaster Relief Systems, Network Resilience and Recovery (DR&NRR). First, an integrated view of DR&NRR technologies is described that allows the support of rescue organizations as well as private persons when disasters occur (Part I). This is followed by descriptions of each technology component explicitly mentioned in the integrated view (Part II). Other technologies, which do not fit into the single pictorial view but that appear promising are also described (Part III).

Information about FG-DR&NRR inputs is also briefly summarised (Part IV) and references provided using a common formal template (Part V).

Table of contents

1.	Part IV: List of FG-DR&NRR input and use cases	6
1.1.	Mitigation and prevention.....	6
1.2.	Preparedness	6
1.3.	Prediction and early warning.....	7
1.4.	Response	7
1.5.	Impact assessment.....	9
1.6.	Recovery	9
1.7.	Reconstruction.....	10
2.	Part V: Repository of FG-DR&NRR inputs and use cases	11
2.1.	Mitigation and prevention.....	11
2.2.	Preparedness	16
2.3.	Prediction and early warming	36
2.4.	Response	45
2.5.	Impact assessment.....	81
2.6.	Recovery	91
2.7.	Reconstruction.....	115
Appendix I		126

ITU-T FG-DR&NRR Deliverable

Promising technologies and use cases – Part IV and V

1. Part IV: List of FG-DR&NRR input and use cases

This clause provides the classification and a summary of information (use cases) collected through FG-DR&NRR activities.

Note: the categorization below is based on the phase of the disaster (timeline) and is different from the time and the technology-oriented categorization in the overview deliverable, that is, Figure 1, *Overview of the expected study areas for FG-DR&NRR*. And current use cases do not contain every contribution and categorization submitted to the FG. The alignment of categorization and the addition of currently missing use cases remains for further study.

1.1. Mitigation and prevention

- 1) 1st Workshop, Jun. 2012 Session 3-2: Information and Communication Technologies in Disaster Management

This presentation briefly looked at recent catastrophic disasters, and then explained the role of ITU and ICT technologies in emergency telecommunications using the concept of phases, i.e., preparedness phase, response phase, and rehabilitation and recovery phase.

- 2) 2nd Workshop, Dec. 2012 Keynote 1-1: AFAD ICT Projects

This presentation provided a high-level overview of seven disaster related projects in AFAD (Republic of Turkey Prime Ministry Disaster & Emergency Management Presidency), that is, a geographic information system, a command & control system, a temporary shelters management system, an uninterrupted and secure communication system, warning and alarm systems (SIREN systems), the Turkey disaster data center project (TDDCP), and image processing research and development activities (long term).

1.2. Preparedness

- 1) drnrr-i-0042: Liaison Statement from ITU-D Study Group 1 Question 20-1/1 to ITU-T Focus Group on Audio Visual Media Access (FG-AVA) and ITU-T Focus Group on Disaster Relief Systems, Network Resilience and Recovery (FG-DR&NRR)

This Liaison Statement contains two contributions to ITU-D Question 20-1/1. One describes a technical system for ensuring the safety of disabled persons in the event of a disaster, using e.g., specialized dedicated mobile e-health terminals, and identifies challenges faced in an emergency situation. The other describes the provision of a wide range of services (e.g. e-payment and internet shopping) to persons with disabilities using digital TVs and set top boxes.

- 2) drnrr-i-0050: Tower-based base stationed mobile communication for the gathering places where the disaster control management will be and the mass people with convene like hospitals

This contribution describes important issues in emergency telecommunications. One is the use of towers, which are unaffected by earthquakes in Turkey. The other is the power supply for damaged means of transportation.

- 3) 2nd Workshop, Dec. 2012 Keynote 1-3: Mobile Communication in Emergency

This contribution briefly described the importance and difficulties of mobile commu-

nication in emergencies, and explained the legal framework for operators. It then described the preparation undertaken in advance in Turkey, and explains what happened during the Van Earthquake in October 2011.

- 4) 2nd Workshop, Dec. 2012 Session1-3: Research and Development Technologies for Disaster Resistance Improvement - Voice Communication System without Power Supply –

This presentation described an optical access system that enables voice communication without a power supply on the customer side that uses light energy to drive devices. Its architecture and experimental results were described.

- 5) 2nd Workshop, Dec. 2012 Session2-4: Tooway : A New Way of Telecommunication
This presentation described a Ka-band satellite, KASAT, which is available in Europe, and explained the required facilities on the ground. It provides a full-IP based transmission, large as well as on-demand-basis bandwidth, and ubiquitous access even during an emergency.

- 6) drnrr-i-0066: Use case of Local Private Wireless Mesh Network System

This contribution presents a new concept for disasters, a wireless mesh network, which is expected to be provided by municipalities. It consists of fixed and portable mesh relay nodes placed on the tops of the buildings or on the ground, and WiMAX links. Thanks to its distributed mesh architecture, it is robust to partial damage in the network. Several applications are under development both for emergencies and for normal situations, e.g., the distribution of sales information.

1.3. Prediction and early warning

- 1) drnrr-i-0005: Mobile Systems for Disaster Relief and Early Warning

This contribution classifies mobile systems for disasters and early warning into four categories, early warning, disaster relief for general public, disaster relief for individuals, and disaster relief by guidance, and explains the potential applications and required actions for each category based on the Japan 2011 earthquake.

- 2) drnrr-i-0029: Early Warning Systems (EWS)

This contribution presents the essence of drnrr-i-0030, a white paper for early warning systems (EWS). It explains what an EWS is, presents some real use cases from Japan, and discusses high-level requirements for telecommunications.

- 3) drnrr-i-0144: Proposal for a use case of area mail systems over mobile networks

This contribution explains NTT Docomo's Area Mail service presented in drnrr-i-072. It uses the cell broadcast service standardized by 3GPP, and has some good features for disaster early warning, e.g., there is no need to manage destination email addresses because the service employs a sort of broadcast to terminals in a cell. It also explains the improvements made after the Japan 2011 earthquake, and explains the requirements that must be met in order to provide the service.

- 4) 2nd Workshop, Dec. 2012 Session 2-2: Disaster Solutions based on Experiences in Japan Quake 2011

This presentation explained three technologies for disasters. During the Japan 2011 earthquake, a cell broadcast service (CBS) based early warning system contributed to damage reduction. Location based services were used to find evacuation places and people. And there were interruptions to the telephone network in metropolitan areas that triggered the development of the disaster voice message service (DVMS).

1.4. Response

- 1) drnrr-i-0013: The Role of the Amateur Service in Emergency Telecommunications

This contribution describes the possible roles of amateur services (amateur radio) in

emergency situations. It has a high degree of flexibility and self-regulation, and can play a role in various aspects of disasters such as providing emergency alerts, safety information and healthcare.

- 2) 2nd Workshop, Dec. 2012 Session2-3: How Can We Build the Infrastructure of Radio Communication Systems for Disaster Relief and Situation in Turkey
Based on experiences in Turkey, this presentation provided five high-level requirements that must be met when designing radio communication systems for disasters, e.g., there should be at least one plan “b” available to deal with service interruptions caused by the failure of critical system components.
- 3) 5th workshop, Session 2-3, GeoThings Platform, How ICT Coordinates Humanitarian Assistance and Disaster Relief
GeoThing is an incubation project of the Industrial Technology Research Institute of Taiwan, province of China. It integrates Ushahidi (open data platform), Open GeoSMS (a message format for encoding location information in SMS) and others, and helps coordinate people such as volunteers, NGO workers and organizations such as NGOs and governments during disasters.
- 4) dr-nrr-i-0120: Safety confirmation and broadcasting message systems for business continuity
This contribution provides various ways of realizing a business continuity plan (BCP) for enterprises or local governments, in particular those relating to safety confirmation, broadcast message systems from managers, and asset confirmation, and it also describes major requirements for BCP.
- 5) drnrr-i-0075, i-0141: Experimental report of “Multi-network communications system” in anticipation of the disasters
This contribution presents the concept and a prototype of a multi-network communications system, and the result of it’s a related experiment. This multi-network communications system notifies/exchanges disaster information among relevant parties and disaster victims using relay nodes that relay information based on a multiple regional wireless network such as WiMAX, WiFi, ITS and corresponding satellite. An experiment undertaken in March 2013 proved its concept.
- 6) drnrr-i-0142: Introduction UAS
This contribution describes an Unmanned Aircraft System (UAS)-based message (e.g., email) transmission system for disaster information exchange. It receives messages in an unaffected region via WiFi, WiMAX or LTE, and delivers it to disaster affected areas using WiFi.
- 7) drnrr-i-167, 168: Open-air public address systems
Most rural areas in Japan are covered by outdoor public address systems and these are used to warn of emergencies using sirens, and to provide evacuation messages. However, because of a long path echo and a sound mixture problem, the messages were often difficult to understand. This contribution explains ongoing research designed to solve this problem by measuring acoustic properties.
- 8) drnrr-i-155, drnrr-i-172: portable burst-mode EDFA
During disasters it is often necessary to reconnect surviving fibre links to optical fibre networks. These contributions present portable, battery-based burst-mode erbium-doped fibre amplifiers (EDFA) that are useful for such reconnection work.
- 9) drnrr-i-64, drnrr-i-120, drnrr-i-184r1: Safety confirmation system with self-safety information registration
During disasters people wants to exchange status information (e.g., “I’m OK”) with their families and friends. These contributions describe the safety confirmation systems used in the Japan 2011 earthquake, and discuss the requirements for the system

and problems that have been identified for future study.

10) Special session at the 9th FG-DR&NRR meeting, Session 1-1. Telecommunication Technologies for Disaster Relief Systems

This presentation described the operations and technologies used in Fiji when there is a disaster. For natural disasters, the public receive a warning from the MET Office and local radio stations. Telecom Fiji Limited (TFL) has a resilient transmission network between the two main cities (Suva and Lautoka) and between the two main Islands. TFL has Genset back-up in all major exchanges, satellite hubs and radio stations. The challenge for TFL is to transport diesel to remote areas in case of a commercial power outage exceeding a week as a result of access route availability problems. TFL also have a communication fall back position, namely the CDMA Network. In a worst-case scenario, TFL will resort to TFL Satellite Network communication. Radio stations (AM Stations) are used by the government to broadcast important messages before and during a disaster and also during the recovery period.

1.5. Impact assessment

1) drnrr-i-0014/0046: Handbook on Telecommunications and Disaster Mitigation

2) 1st Workshop, Jun.2012 Session1-1: Telecommunications for Disaster Relief, Network Resilience and Recovery - An Introduction

1) and 2) describe the draft ITU-T handbook, “Handbook on Telecommunications and Disaster Mitigation”, which was published on June 2013. It describes use-cases taken from the Japan 2011 earthquake, US hurricane Katarina in 2005, the Sumatra tsunami in 2004, New York 9/11 in 2001, and explains the activities, initiatives and other work of the United Nations, regional initiatives, ITU, International Amateur Radio Union and other standardization bodies.

3) Workshop-2, December, 2012 Session 1-1: Effect of Disasters on FTTX network

This presentation assumed typical FTTx systems and two disaster (earthquake) scenarios, analysed the expected damage, and explained key observations, e.g., fibre cables are more sensitive to pressure than copper cables and ring or mesh topologies are critical for FTTC cabinets.

1.6. Recovery

1) drnrr-i-0027: COMMUNICATIONS DISASTER, SDPPI/ MIN. of INFOCOM INDONESIA

This presentation described the activity of the Indonesian government and relevant bodies in relation to disasters, in particular its organization structure and the flow chart in case of disasters.

2) drnrr-i-0045: The Communication Service Group mechanism in Turkey: An Interoperative Approach for Emergency Communication, Network Resilience and Recovery

3) 2nd Workshop, Dec. 2012 Session1-2: The Communication Service Group Mechanism in Turkey: An Interoperative Approach for Emergency Communication, Network Resilience and Recovery

2) and 3) report that there is a “communication service group” for emergency telecommunications in every province. The group is composed of all network providers, service providers, law enforcement agencies, broadcasters, and the Turkish national amateur radio society. The amateur radio society contributes to the group by providing human resources and its radio communications techniques.

4) drnrr-i-105: Message Transmission without Cellular Coverage

This contribution presents ongoing research that is trying to provide a communication infrastructure using an ad-hoc WiFi mode. Using a mobile ad-hoc network (MANET)

and delay tolerant technology (DTN) technologies as a basis, it has succeeded in providing a communication approach for crowded areas such as large streets, shopping areas and public parks.

- 5) 5th Workshop, May 2013, Session 3-2, An Application of “Hybridcast” for Disaster Information Delivery
Hybridcast is an integrated broadcast-broadband system that enhances broadcasts with information delivered via broadband networks, and that was standardized at the IPTV Forum Japan. This presentation provided prototype applications for disasters e.g., an overlay of earthquake early warning, and summarizes the result of an assessment experiment.
- 6) drnrr-i-140: Device Collaboration to Realize Resilient Information Sharing
This contribution explains a new technology, device collaboration, that realizes resilient information sharing between disaster-affected people’s personal devices that are running HTML 5 browsers by connecting to a local WiFi hot-spot and launching the browser.
- 7) drnrr-i-0177 and 178: Introduction to elastic optical networking
Elastic optical networking technology makes optical frequency flexible, and is usually used to enhance transmission efficiency. It is also a powerful technology for use during disasters because it makes almost all routes available for backup by the dynamic adaptation of modulation formats to meet required distances.
- 8) drnrr-i-63: Introduction to a resilient network architecture based on a Movable and Deployable Resource Unit (MDRU),
5th Workshop, May 2013, Session 3-3, Resilient network architecture based on a Movable and Deployable Resource Unit (MDRU)
A Movable and Deployable Resource Unit (MDRU) is a large all-in-one container carried by e.g., a trailer, and equipped with various servers such as voip and email, and network equipment for WAN (optical transmission) and LAN. This contribution and presentation describe its concept, current prototype status and requirements for future work.
- 9) drnrr-i-58: The Necessity and Flexibility of Portable Emergency Communication Systems (PECS)
This contribution discusses the features required for “portable emergency communication systems“, e.g., on user terminals, IP-based switches, antennas and other devices that can be tools providing a communication infrastructure for various rescue groups or non-professional NGOs during both disasters and rescue operations.

1.7. Reconstruction

- 1) 2nd Workshop, Dec. 2012 Session3-2: Uninterrupted Secure Communication Project for Disaster Management
This presentation analysed communication technologies used in the Japan 2011 earthquake, and US FEMA, and discusses the required capabilities, e.g., the necessary satellite bandwidth, to realize uninterrupted communication during disasters.
- 2) 2nd Workshop, Dec. 2012 Session3-3: IT in Disaster Relief & Rescue - Concept of Hitachi –
This presentation explained a disaster information system that includes various sub-systems such as warnings and alerts to branches and municipalities, and collects damage information using a geographical information system (WebGIS). It also described the effective use of GeoPDF files for disasters.
- 3) drnrr-i-0200: Adding Information-Centric Networking as a component technology of “Disaster Relief Systems, Network Resilience and Recovery (DR&NRR): Promising

technologies and use cases.”

This contribution describes ongoing future network research aimed at constructing applications, such as a social networking service (SNS), using a named content chunk with its signature as a universal component, rather than IP addresses. Based on Information Centric Networking, the same applications can be used before and after a disaster, and secure end-to-end communications are possible in a disaster with no central server.

2. Part V: Repository of FG-DR&NRR inputs and use cases

This clause describes the detailed information (use cases) collected from FG-DR&NRR activities.

2.1. Mitigation and prevention

1) 1st workshop, Jun. 2012 Session3-2: Information and Communication Technologies in Disaster Management

Part I. Summary.

- Country :ITU
- Title of use case: Information and Communication Technologies in Disaster Management
- Details of the person preparing the use case:
 - Name: Maritza Delgado
 - Title: Programme Officer
 - Organization: BDT/LSE
 - Address:
 - E-Mail: delgadod@itu.int
 - Website:
- Date of the submission: Workshop on Disaster Relief Systems, Network Resiliency and Recovery, June 25, 2012 (Presentation 3-2)
- ITU-T SG(s) to which you think your use case could be relevant:
- Status of use case:
 - Operational | Completed | Research and Development
 - If in operational, specify major deployment cases: Japan Earthquake 2011
- (Potential target) Location and population of the use case: International
 - Location (village, district, etc.) (or specify the target is city, rural, and/or countryside)
 - Population of the project area
- Relevant actors (played roles): Multi-stakeholder
 - end-users, private sector organizations, public sector organizations, national/local government, others
 - If others, please specify:
- Type of disaster: Multi-hazard
 - Cold wave | Drought | Earthquake | Epidemic | Extratropical Cyclone | Fire | Flash Flood | Flood | Heat Wave | Insect Infestation | Land Slide | Mad Slide | Severe Local Storm | Snow Avalanche | Storm Surge | Tech. Disaster | Tropical Cyclone | Tsunami | Volcano | Wild Fire | Other
 - if others, please specify:
- Type of use case:
 - Mitigation and prevention | preparedness | prediction and early warning | response |

- impact assessment | recovery | reconstruction
- Wired local loop: Copper, optical fibre, etc. (customers' loop) | Wireless local loop (customers' loop) | Fixed wireless access (long distance) | Mobile wireless access | Satellite two-way communications: VSAT, etc. | Wireless LANS and IP-based related networks | Terrestrial voice, data, sound or television broadcasting | Satellite voice, data, sound or television broadcasting | Hybrid or combined technologies| Others
- if others, please specify: Multi-phased, Multi-technology
- Objective and/or achievements of the use case
- summary of the use case indicating its expected social /economic impacts

Part II. Details.

- Overview of use case targets, objectives and financing
 - Objectives and implementation details of the use case including problem statement (tsunami, earthquake, drought, etc.):
 - Brief description of the target country/region: geography, terrain, climate, demographics, socio-economic situation:
 - If any, technological improvement and its effects for providing new capabilities, reduced cost capital and operating cost solutions.
- Infrastructure and regulatory environment
 - Infrastructure components: Necessary telecommunication facilities, transport access, electricity supply, distance to the nearest local exchange and/or IP network, human resources, security : GIS, GNSS/GPS, Earth Observation Satellites and Meteorological Satellites, Satellite Communications, Land Observation Systems
 - Regulatory components: Necessary license, frequency availability (for radio-based projects), other regulatory issues
 - : The Tampere Convention
 - Other factors which influenced the operating environment (manufacturers, standards etc).
 - : Establishment and Review of Standard Operating Procedure (SOP)
- Technical description of use case provided
 - Architecture, type of systems, main technical characteristics, frequencies (for radio-based projects), power consumption, performances (capacity, reliability, quality of service), network management, etc.,
 - Installation and deployment: network planning, subscriber management, etc.
 - Interconnection to national networks/backbones/disaster response systems
- Cost | financial aspects, if possible
 - Cost of the equipment, cost per line and cost of the operation of the system
 - Cost of each terminal and cost of the service for the user.
 - Financial aspects of the use case
- Effectiveness and sustainability of the project
 - Effectiveness and benefits of the project for the targeted user groups
 - Profitability of the project and/or its contribution to local entrepreneurial activities
 - Specific strategies to respond to the needs of women, youth, handicapped, indigenous people and other marginalized or socially disadvantaged groups
 - Aspects of the project, which could be strengthened to enhance its effectiveness or sustainability maximizing the benefits of telecommunication infrastructure in rural and remote areas.

- Other observations
 - Unexpected results and/or lessons learned
 - Derived requirements | requests for the emergency telecommunication community
 - Anticipated near/long-term future plan
- Other source of information
 - Web
 - Important publications
 - Others

2) 2nd Workshop, Dec. 2012 Keynote 1-1: AFAD ICT PROJECTS

Part I. Summary

- Country: Turkey
- Title of use case: AFAD ICT PROJECTS
- Details of the person preparing the use case:
 - Name: Özge MİŞE
 - Title: Disaster and Emergency Management Presidency
 - Organization: TURKISH REPUBLIC PRIME MINISTRY
 - Address:
 - E-Mail:
 - Website:
- Date of the submission: Workshop on Disaster Relief Systems, Network Resilience and Recovery, Istanbul, Turkey, 11 December 2012 (Keynote 1-1)
- ITU-T SG(s) to which you think your use case could be relevant:
- Status of use case:
 - Operational | Completed | Research and Development
 - If in operational, specify major deployment cases

AFAD was established in 2009 for an effective and efficient Disaster Management in Turkey.
- (Potential target) Location and population of the use case
 - Location (village, district, etc.) (or specify the target is city, rural, and/or countryside)
 - Population of the project area
- Relevant actors (played roles)
 - end-users, private sector organizations, public sector organizations, national/local government, others
 - If others, please specify:
- Type of disaster

[EdNote: consider to edit this list. The list is easy to understand, but contains incidents that do not affect very much to telecom networks. Contributions invited.]

 - Cold wave | Drought | Earthquake | Epidemic | Extratropical Cyclone | Fire | Flash Flood | Flood | Heat Wave | Insect Infestation | Land Slide | Mad Slide | Severe Local Storm | Snow Avalanche | Storm Surge | Tech. Disaster | Tropical Cyclone | Tsunami | Volcano | Wild Fire | Other
 - if others, please specify: Multi Hazard
- Type of use case
 - Mitigation and prevention | preparedness | prediction and early warning | response |

- impact assessment | recovery | reconstruction
- Wired local loop: Copper, optical fibre, etc. (customers' loop) | Wireless local loop (customers' loop) | Fixed wireless access (long distance) | Mobile wireless access | Satellite two-way communications: VSAT, etc. | Wireless LANS and IP-based related networks | Terrestrial voice, data, sound or television broadcasting | Satellite voice, data, sound or television broadcasting | Hybrid or combined technologies | Others
- if others, please specify:
- Objective and/or achievements of the use case
- summary of the use case indicating its expected social /economic impacts

Part II. Details.

- Overview of use case targets, objectives and financing
 - Objectives and implementation details of the use case including problem statement (tsunami, earthquake, drought, etc.):
 - Brief description of the target country/region: geography, terrain, climate, demographics, socio-economic situation:
 - If any, technological improvement and its effects for providing new capabilities, reduced cost capital and operating cost solutions.
- Infrastructure and regulatory environment
 - Infrastructure components: Necessary telecommunication facilities, transport access, electricity supply, distance to the nearest local exchange and/or IP network, human resources, security
 - Regulatory components: Necessary license, frequency availability (for radio-based projects), other regulatory issues
 - Other factors which influenced the operating environment (manufacturers, standards etc).
- Technical description of use case provided
 - Architecture, type of systems, main technical characteristics, frequencies (for radio-based projects), power consumption, performances (capacity, reliability, quality of service), network management, etc.,

A. GEOGRAPHIC INFORMATION SYSTEM

-Aims to gather all information that is useful for Disaster Management in one GIS database.

B. COMMAND & CONTROL SYSTEM

-It is aimed to increase the visibility and tracibility of resources, logistical elements and response teams

C. TEMPORARY SHELTERS MANAGEMENT SYSTEM

-Currently 130,000 Syrian refugees reside in Turkish temporary shelters. Tracking of the population and basic needs in these camps is a big problem. It is aimed to automatize the camp management functions.

D. UNINTERRUPTED AND SECURE COMMUNICATION SYSTEM

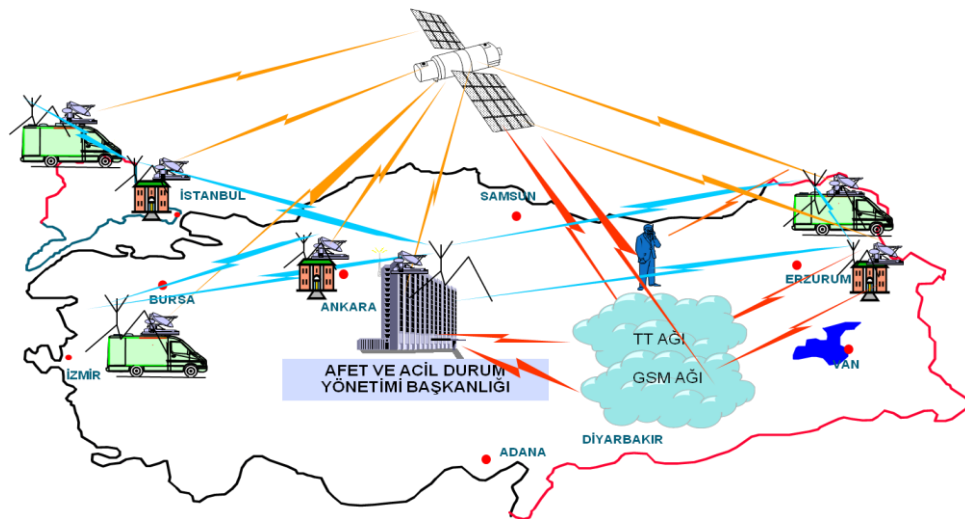

E. WARNING AND ALARM SYSTEMS (SIREN SYSTEMS)

-Existing sirens work manually. A modern siren system which can be remotely controlled is necessary. Pilot application area is Zonguldak city, located in Northern Turkey.

F. TURKEY DISASTER DATA CENTER PROJECT (TDDCP)

-Remote and secure data storage center for all disaster related data . Will be followed by Infrastructure Design, Analysis and Implementation.

G. IMAGE PROCESSING RESEARCH AND DEVELOPMENT ACTIVITIES (LONG TERM)

-Change Detection in the disaster area using remote sensing images.

- Installation and deployment: network planning, subscriber management, etc.
- Interconnection to national networks/backbones/disaster response systems
- Cost | financial aspects, if possible
 - Cost of the equipment, cost per line and cost of the operation of the system
 - Cost of each terminal and cost of the service for the user.
 - Financial aspects of the use case

Budgeting is the most critical issue for the realization of Turkish project.

- Effectiveness and sustainability of the project
 - Effectiveness and benefits of the project for the targeted user groups
 - Profitability of the project and/or its contribution to local entrepreneurial activities
 - Specific strategies to respond to the needs of women, youth, handicapped, indigenous people and other marginalized or socially disadvantaged groups
 - Aspects of the project, which could be strengthened to enhance its effectiveness or sustainability maximizing the benefits of telecommunication infrastructure in rural and remote areas.
- Other observations
 - Unexpected results and/or lessons learned
 - Derived requirements | requests for the emergency telecommunication community
 - Anticipated near/long-term future plan
- Other source of information
 - Web

- Important publications
- Others

2.2. Preparedness

- 1) dnrr-i-0042: Liaison Statement from ITU-D Study Group 1 Question 20-1/1 to ITU-T Focus Group on Audio Visual Media Access (FG-AVA) and ITU-T Focus Group on Disaster Relief Systems, Network Resilience and Recovery (FG-DR&NRR)

Part I. Summary.

- Country
- Title of use case: Ensuring the safety of disabled persons connected to e-health systems in the event of a major incident
- Details of the person preparing the use case:
 - Name: Dr Viliam Sarian
 - Title:
 - Organization: SG1 Q20-1/1
 - Address:
 - E-Mail:
 - Website:
- Date of the submission: 11 – 13 December 2012 (Original 15 March 2012; RGQ 20-1/1/16-E)
- ITU-T SG(s) to which you think your use case could be relevant: TBD
- Status of use case:
 - Research and Development
 - If in operational, specify major deployment cases
- (Potential target) Location and population of the use case: N.A.
 - Location (village, district, etc.) (or specify the target is city, rural, and/or countryside)
 - Population of the project area
- Relevant actors (played roles)
 - end-users: persons with disabilities
 - private sector organizations: N.A.
 - public sector organizations: N.A.
 - national/local government: N.A.
 - others
 - If others, please specify:
- Type of disaster
 - Cold wave | Drought | Earthquake | Epidemic | Extratropical Cyclone | Fire | Flash Flood | Flood | Heat Wave | Insect Infestation | Land Slide | Mad Slide | Severe Local Storm | Snow Avalanche | Storm Surge | Tech. Disaster | Tropical Cyclone | Tsunami | Volcano | Wild Fire | Other
 - if others, please specify:
- Type of use case
 - Mitigation and prevention | preparedness | prediction and early warning | response | impact assessment | recovery | reconstruction
 - Wired local loop: Copper, optical fibre, etc. (customers' loop) | Wireless local loop (customers' loop) | Fixed wireless access (long distance) | Mobile wireless access | Satellite two-way communications: VSAT, etc. | Wireless LANS and IP-based related networks | Terrestrial voice, data, sound or television broadcasting | Satellite voice, data, sound or television broadcasting | Hybrid or combined technologies|

Others

➤ if others, please specify:

Not specific. Examples include fires, ship accidents, and earthquakes.

● Objective and/or achievements of the use case

➤ Objectives

To develop a technical system for ensuring the safety of disabled persons in the event of a major incident at/in a given location (such as a building) using specialized dedicated mobile e-health terminals, mobile phones and other devices, and ubiquitous sensor networks.

➤ Achievements

Identification of requirements

Personalized Safety System: A method of improving safety for disabled persons in the event of a major incident

● summary of the use case indicating its expected social/economic impacts

– Early individual warning of fires and other emergencies of all types.

– Continuous operation and reliability of the system if any of the nodes cease to function.

– Organization of autonomous evacuation of the user out of the affected location or to a specially equipped location within it, with constant monitoring of this process by the system.

– Individualized evacuation of each user to take due account of the user's language and mindset

– Prevention of panic.

– Individualized staff management, with reminders to each person to carry out various planned functions.

– All actions by the user and all recommendations by the system are recorded in the system memory and transmitted to the emergency operations centre.

Part II. Details: N.A.

● Overview of use case targets, objectives and financing

➤ Objectives and implementation details of the use case including problem statement (tsunami, earthquake, drought, etc.):

➤ Brief description of the target country/region: geography, terrain, climate, demographics, socio-economic situation:

➤ If any, technological improvement and its effects for providing new capabilities, reduced cost capital and operating cost solutions.

● Infrastructure and regulatory environment

➤ Infrastructure components:

➤ Necessary telecommunication facilities

➤ transport access

➤ electricity supply

➤ distance to the nearest local exchange and/or IP network

➤ human resources

➤ security

- Regulatory components:
 - Necessary license
 - frequency availability (for radio-based projects)
 - other regulatory issues
- Other factors which influenced the operating environment (manufacturers, standards etc).
- Technical description of use case provided
 - Architecture, type of systems, main technical characteristics, frequencies (for radio-based projects), power consumption, performances (capacity, reliability, quality of service), network management, etc.,
 - Installation and deployment: network planning, subscriber management, etc.
 - Interconnection to national networks/backbones/disaster response systems
- Cost | financial aspects, if possible
 - Cost of the equipment, cost per line and cost of the operation of the system
 - Cost of each terminal and cost of the service for the user.
 - Financial aspects of the use case
- Effectiveness and sustainability of the project
 - Effectiveness and benefits of the project for the targeted user groups
 - Profitability of the project and/or its contribution to local entrepreneurial activities
 - Specific strategies to respond to the needs of women, youth, handicapped, indigenous people and other marginalized or socially disadvantaged groups
 - Aspects of the project, which could be strengthened to enhance its effectiveness or sustainability maximizing the benefits of telecommunication infrastructure in rural and remote areas.
- Other observations
 - Unexpected results and/or lessons learned
 - Derived requirements | requests for the emergency telecommunication community
 - Anticipated near/long-term future plan
- Other source of information
 - Web
 - Important publications
 - Others

- 2) drnrr-i-0050: Tower-based base stationed mobile communication for the gathering places where the disaster control management will be and the mass people with convene like hospitals

Part I. Summary.

- Country: Turkey
- Title of use case: Tower-based base stationed mobile communication for the gathering places where the disaster control management will be and the mass people with convene like hospitals
- Details of the person preparing the use case:
 - Name: Tamer Demir (Original) / NTT (Transcription)
 - Title: Management Program Manager / (Editor)
 - Organization: Turkcell / (NTT)
 - Address:
 - E-Mail:
 - Website:
- Date of the submission:
 - 11-13 December 2012, DR&NRR-i-0050, "Tower-based base stationed mobile communication for the gathering places where the disaster control management will be and the mass people with convene like hospitals"
 - 11 December 2012, ITU-T Workshop, Istanbul, "Disaster relief systems in practice", s02p01
- ITU-T SG(s) to which you think your use case could be relevant: TBD
- Status of use case:
 - Operational | Completed | Research and Development: likely to be R&D
 - If in operational, specify major deployment cases
- (Potential target) Location and population of the use case
 - Location (village, district, etc.) (or specify the target is city, rural, and/or country-side): Turkey nation-wide
 - Population of the project area
- Relevant actors (played roles)
 - end-users: people affected by earthquakes
 - private sector organizations: not defined
 - public sector organizations: not defined
 - national/local government: not defined
 - others
 - If others, please specify:
- Type of disaster
 - Earthquake | Other
 - if others, please specify:
 - Types of Hazards
 - Natural Origin:
 - Geological
 - Meteorological
 - Biological
 - Technology Source:
 - Human Origin:
 - Accident
 - Deliberate
- Type of use case

- Mitigation and prevention | preparedness | response
- Wireless local loop (customers' loop)
- if others, please specify:
- Objective and/or achievements of the use case
 - Objectives
 - what to be supported
 - call for help
 - call your loved ones
 - find out what is happening
 - provide cell phone chargers
 - energy transportation
 - what have to be done
 - network is well prepared
 - provide back-up power
 - network come back on-line fast
 - align the appearance of the tower with the environment
 - Achievements
 - use mobile service
 - provide tower-based base stations
 - Emergency Network Resilience and Recovery Vehicle
- summary of the use case indicating its expected social/economic impacts

Part II. Details.

- Overview of use case targets, objectives and financing
 - Objectives and implementation details of the use case including problem statement (tsunami, earthquake, drought, etc.):
 - provide continued mobile communications during disaster situations caused by earthquakes
 - Brief description of the target country/region: geography, terrain, climate, demographics, socio-economic situation:
 - Turkey nation-wide
 - towers have not been affected by the past earthquakes
 - If any, technological improvement and its effects for providing new capabilities, reduced cost capital and operating cost solutions.
- Infrastructure and regulatory environment
 - Infrastructure components:
 - Necessary telecommunication facilities
 - transport access
 - electricity supply
 - distance to the nearest local exchange and/or IP network
 - human resources
 - security
 - Regulatory components:
 - Necessary license
 - frequency availability (for radio-based projects)
 - other regulatory issues
 - Other factors which influenced the operating environment (manufacturers, standards etc).
- Technical description of use case provided

- Architecture, type of systems, main technical characteristics, frequencies (for radio-based projects), power consumption, performances (capacity, reliability, quality of service), network management, etc.,
 - tower-based base stations for mobile communications
 - battery backup for three days
 - provide cell phone chargers for affected people
- Installation and deployment: network planning, subscriber management, etc.
 - construction of towers at safe locations throughout the nation
- Interconnection to national networks/backbones/disaster response systems
- Cost | financial aspects, if possible
 - Cost of the equipment, cost per line and cost of the operation of the system
 - Cost of each terminal and cost of the service for the user.
 - Financial aspects of the use case
- Effectiveness and sustainability of the project
 - Effectiveness and benefits of the project for the targeted user groups
 - Profitability of the project and/or its contribution to local entrepreneurial activities
 - Specific strategies to respond to the needs of women, youth, handicapped, indigenous people and other marginalized or socially disadvantaged groups
 - Aspects of the project, which could be strengthened to enhance its effectiveness or sustainability maximizing the benefits of telecommunication infrastructure in rural and remote areas.
- Other observations
 - Unexpected results and/or lessons learned
 - Derived requirements | requests for the emergency telecommunication community
 - tower-based base stations for mobile communications
 - construction of towers at safe locations throughout the nation
 - battery backup for three days
 - provide cell phone chargers for affected people
 - Anticipated near/long-term future plan
- Other source of information
 - Web
 - Important publications
 - Others

3) 2nd Workshop, Dec. 2012 Keynote 1-3: Mobile Communication in Emergency

Part I. Summary.

- Country: Turkey
- Title of use case: Mobile Communication in Emergency
- Details of the person preparing the use case:
 - Name: Necati UĞURLU
 - Title: Head of Department
 - Organization: Spectrum Monitoring Department
 - Address:
 - E-Mail: nugurlu@btk.gov.tr
 - Website:
- Date of the submission: Workshop on Disaster Relief Systems, Network Resilience and Recovery (Istanbul, Turkey, 11 December 2012 (Keynote 1-3))
- ITU-T SG(s) to which you think your use case could be relevant:
- Status of use case:
 - Operational | Completed | Research and Development
 - If in operational, specify major deployment cases: Van Earthquake
- (Potential target) Location and population of the use case
 - Location (village, district, etc.) (or specify the target is city, rural, and/or countryside)
 - Population of the project area
- Relevant actors (played roles)
 - end-users, private sector organizations, public sector organizations, national/local government, others
 - If others, please specify:
- Type of disaster
 - Cold wave | Drought | Earthquake | Epidemic | Extratropical Cyclone | Fire | Flash Flood | Flood | Heat Wave | Insect Infestation | Land Slide | Mad Slide | Severe Local Storm | Snow Avalanche | Storm Surge | Tech. Disaster | Tropical Cyclone | Tsunami | Volcano | Wild Fire | Other
 - if others, please specify:
- Type of use case
 - Mitigation and prevention | preparedness | prediction and early warning | response | impact assessment | recovery | reconstruction
 - Wired local loop: Copper, optical fibre, etc. (customers' loop) | Wireless local loop (customers' loop) | Fixed wireless access (long distance) | Mobile wireless access | Satellite two-way communications: VSAT, etc. | Wireless LANS and IP-based related networks | Terrestrial voice, data, sound or television broadcasting | Satellite voice, data, sound or television broadcasting | Hybrid or combined technologies | Others
 - if others, please specify:
- Objective and/or achievements of the use case : To be defined
- summary of the use case indicating its expected social /economic impacts

Part II. Details.

- Overview of use case targets, objectives and financing
 - Objectives and implementation details of the use case including problem statement

- (tsunami, earthquake, drought, etc.)
 - Brief description of the target country/region: geography, terrain, climate, demographics, socio-economic situation: Turkey. Operators have employed mobile BTSs with roaming ability and satellite connection, in 25 regions, and have also mobile BTSs with terrestrial transmission.
 - If any, technological improvement and its effects for providing new capabilities, reduced cost capital and operating cost solutions.
- Infrastructure and regulatory environment
 - Infrastructure components: Necessary telecommunication facilities, transport access, electricity supply, distance to the nearest local exchange and/or IP network, human resources, security
 - Regulatory components: Necessary license, frequency availability (for radio-based projects), other regulatory issues
 - Other factors which influenced the operating environment (manufacturers, standards etc.): In metropolitan areas, operators are obliged to define the location of users calling emergency services with a sensitivity of less than 2 km². (This sensitivity will drop to 1 km² in 5 years)
- Technical description of use case provided
 - Architecture, type of systems, main technical characteristics, frequencies (for radio-based projects), power consumption, performances (capacity, reliability, quality of service), network management, etc.,
 - Installation and deployment: network planning, subscriber management, etc.
 - Interconnection to national networks/backbones/disaster response systems
- Cost | financial aspects, if possible
 - Cost of the equipment, cost per line and cost of the operation of the system
 - Cost of each terminal and cost of the service for the user.
 - Financial aspects of the use case
- Effectiveness and sustainability of the project
 - Effectiveness and benefits of the project for the targeted user groups
 - Profitability of the project and/or its contribution to local entrepreneurial activities
 - Specific strategies to respond to the needs of women, youth, handicapped, indigenous people and other marginalized or socially disadvantaged groups
 - Aspects of the project, which could be strengthened to enhance its effectiveness or sustainability maximizing the benefits of telecommunication infrastructure in rural and remote areas.
- Other observations
 - Unexpected results and/or lessons learned
 - Derived requirements | requests for the emergency telecommunication community
 - Anticipated near/long-term future plan
- Other source of information
 - Web
 - Important publications
 - Others

4) 2nd Workshop, Dec. 2012 Session1-3: Research and Development Technologies for Disaster Resistance Improvement- Voice Communication System without Power Supply

Part I. Summary.

- Country: Japan
- Title of use case: Research and Development Technologies for Disaster Resistance Improvement - Voice Communication System without Power Supply -
- Details of the person preparing the use case:
 - Name: Hideaki Kimura
 - Title: General Manager
 - Organization: NTT Corporation
 - Address:
 - E-Mail: kimura.hideaki@lab.ntt.co.jp
 - Website:
- Date of the submission: Workshop on Disaster Relief Systems, Network Resilience and Recovery, Istanbul, Turkey, 11 December 2012 (Presentation 1-3)
- ITU-T SG(s) to which you think your use case could be relevant:
- Status of use case:
 - Operational | Completed | Research and Development
 - If in operational, specify major deployment cases
- (Potential target) Location and population of the use case
 - Location (village, district, etc.) (or specify the target is city, rural, and/or countryside)
 - Population of the project area
- Relevant actors (played roles)
 - end-users, private sector organizations, public sector organizations, national/local government, others
 - If others, please specify:
- Type of disaster
 - Cold wave | Drought | Earthquake | Epidemic | Extratropical Cyclone | Fire | Flash Flood | Flood | Heat Wave | Insect Infestation | Land Slide | Mad Slide | Severe Local Storm | Snow Avalanche | Storm Surge | Tech. Disaster | Tropical Cyclone | Tsunami | Volcano | Wild Fire | Other
 - if others, please specify: Blackout (power failure)
- Type of use case
 - Mitigation and prevention | preparedness | prediction and early warning | response | impact assessment | recovery | reconstruction
 - Wired local loop: Copper, optical fibre, etc. (customers' loop) | Wireless local loop (customers' loop) | Fixed wireless access (long distance) | Mobile wireless access | Satellite two-way communications: VSAT, etc. | Wireless LANS and IP-based related networks | Terrestrial voice, data, sound or television broadcasting | Satellite voice, data, sound or television broadcasting | Hybrid or combined technologies| Others
 - if others, please specify:
- Objective and/or achievements of the use case : To be defined
- summary of the use case indicating its expected social /economic impacts : To be defined

Part II. Details.

- Overview of use case targets, objectives and financing

- Objectives and implementation details of the use case including problem statement (tsunami, earthquake, drought, etc.): FTTH will become LIFELINE services such as PSTN. All communication services become unavailable during power failure including telephone.
- Brief description of the target country/region: geography, terrain, climate, demographics, socio-economic situation:
- If any, technological improvement and its effects for providing new capabilities, reduced cost capital and operating cost solutions.
- Infrastructure and regulatory environment
 - Infrastructure components: Necessary telecommunication facilities, transport access, electricity supply, distance to the nearest local exchange and/or IP network, human resources, security : User's house
 - Regulatory components: Necessary license, frequency availability (for radio-based projects), other regulatory issues
 - Other factors which influenced the operating environment (manufacturers, standards etc).
- Technical description of use case provided
 - Architecture, type of systems, main technical characteristics, frequencies (for radio-based projects), power consumption, performances (capacity, reliability, quality of service), network management, etc., An optical access system that enables voice communication without power supply during power failure in a user's house employing low threshold Ge-diode radio technique and SCM for downstream signal and DSP techniques for upstream signal.
 - Installation and deployment: network planning, subscriber management, etc.
 - Interconnection to national networks/backbones/disaster response systems
- Cost | financial aspects, if possible: Not presented
 - Cost of the equipment, cost per line and cost of the operation of the system
 - Cost of each terminal and cost of the service for the user.
 - Financial aspects of the use case
- Effectiveness and sustainability of the project
 - Effectiveness and benefits of the project for the targeted user groups
 - Profitability of the project and/or its contribution to local entrepreneurial activities
 - Specific strategies to respond to the needs of women, youth, handicapped, indigenous people and other marginalized or socially disadvantaged groups
 - Aspects of the project, which could be strengthened to enhance its effectiveness or sustainability maximizing the benefits of telecommunication infrastructure in rural and remote areas.
- Other observations
 - Unexpected results and/or lessons learned
 - Derived requirements | requests for the emergency telecommunication community
 - Anticipated near/long-term future plan
- Other source of information
 - Web
 - Important publications
 - Others

5) 2nd Workshop-2, Dec. 2012 Session2-4: Tooway : A new Way of Telecommunication

Part I. Summary.

- Country: Turkey
- Title of use case: Tooway: A new way of Telecommunication
- Details of the person preparing the use case:
 - Name: Omer KARATAS
 - Title: Area Manager
 - Organization: Eutelsat/Skylogic
 - Address: N.A.
 - E-Mail: okaratas@skylogic.it, okaratas@Eutelsat.fr
 - Website: N.A.
- Date of the submission: 11 December, 2012
- ITU-T SG(s) to which you think your use case could be relevant: TBD
- Status of use case:
 - Operational (KASAT with 10Mbps speed) & Research and Development (Megasat with 50Mbps speed)
 - If in operational, specify major deployment cases: N.A.
- (Potential target) Location and population of the use case
 - Location (village, district, etc.) (or specify the target is city, rural, and/or country-side): International
 - Population of the project area: N.A.
- Relevant actors (played roles): Consumer and enterprise
 - end-users
 - private sector organizations
 - public sector organizations
 - national/local government
 - others
 - If others, please specify:
- Type of disaster: Not specified
 - Cold wave | Drought | Earthquake | Epidemic | Extratropical Cyclone | Fire | Flash Flood | Flood | Heat Wave | Insect Infestation | Land Slide | Mad Slide | Severe Local Storm | Snow Avalanche | Storm Surge | Tech. Disaster | Tropical Cyclone | Tsunami | Volcano | Wild Fire | Other
 - if others, please specify:
- Type of use case: Ready for emergency (in general)
 - Mitigation and prevention | preparedness | prediction and early warning | response | impact assessment | recovery | reconstruction
 - Wired local loop: Copper, optical fibre, etc. (customers' loop) | Wireless local loop (customers' loop) | Fixed wireless access (long distance) | Mobile wireless access | Satellite two-way communications: VSAT, etc. | Wireless LANS and IP-based related networks | Terrestrial voice, data, sound or television broadcasting | Satellite voice, data, sound or television broadcasting | Hybrid or combined technologies| Others
 - if others, please specify:
- Objective and/or achievements of the use case
 - Objectives: provide all means of communication anywhere, anytime in the region.
 - Achievements: solutions are deployed and integrated in normal circumstances to be ready for emergency.
- summary of the use case indicating its expected social/economic impacts: provides all

means of communication anywhere, anytime in the region for emergency

Part II. Details.

- Overview of use case targets, objectives and financing
 - Objectives and implementation details of the use case including problem statement (tsunami, earthquake, drought, etc.):
 - Brief description of the target country/region: geography, terrain, climate, demographics, socio-economic situation: International
 - If any, technological improvement and its effects for providing new capabilities, reduced cost capital and operating cost solutions.
- New Generation Satellite (Ka-band)
 - Large bandwidth
 - Small antenna size
 - Larger system capacity
 - Ubiquitous access
 - Flexible bandwidth-on-demand capability
- Infrastructure and regulatory environment: N.A.
 - Infrastructure components:
 - Necessary telecommunication facilities
 - transport access
 - electricity supply
 - distance to the nearest local exchange and/or IP network
 - human resources
 - security
 - Regulatory components:
 - Necessary license
 - frequency availability (for radio-based projects)
 - other regulatory issues
 - Other factors which influenced the operating environment (manufacturers, standards etc).
- Technical description of use case provided:
 - KASAT multispot satellite with 10Mbps speed in 2011
 - Megasat multispot satellite with 50Mbps speed in 2015
 - Architecture, type of systems, main technical characteristics, frequencies (for radio-based projects), power consumption, performances (capacity, reliability, quality of service), network management, etc.,
 - Installation and deployment: network planning, subscriber management, etc.
 - Interconnection to national networks/backbones/disaster response systems
- Cost | financial aspects, if possible: N.A.
 - Cost of the equipment, cost per line and cost of the operation of the system
 - Cost of each terminal and cost of the service for the user.
 - Financial aspects of the use case
- Effectiveness and sustainability of the project: N.A.
 - Effectiveness and benefits of the project for the targeted user groups
 - Profitability of the project and/or its contribution to local entrepreneurial activities

- Specific strategies to respond to the needs of women, youth, handicapped, indigenous people and other marginalized or socially disadvantaged groups
- Aspects of the project, which could be strengthened to enhance its effectiveness or sustainability maximizing the benefits of telecommunication infrastructure in rural and remote areas.
- Other observations
 - Wired and wired technologies are mature and well standardized
 - Communication devices are small and economical
 - Integration is almost seamless at IP level
 - Hybrid solutions are deployed and integrated in normal circumstances to be ready for emergency.
 - tooway(trademark) provides all means of communication anywhere, anytime in the region.
 - Unexpected results and/or lessons learned
 - Derived requirements | requests for the emergency telecommunication community
 - Anticipated near/long-term future plan
- Other source of information
 - Web
 - Important publications
 - Others

6) drrrr-i-0066: Use case of Local Private Wireless Mesh Network System

The wireless mesh network based on a de-centralized mesh architecture would keep the service in the isolated local area just after the large-scale disaster, by distributed database and application technologies. By bridging with full-automatic mobile earth stations and mobile repeater on unmanned aerial vehicle (UAV), isolated areas are connected.

Only the daily used system can be usable at the disaster. Service in normal situation is the key to keep the network. For examples, the distribution of sales information in shopping mall and local government's notification, etc. Just after the large-scale disaster the network will be used for information sharing in groups, safety confirmation, etc.

The network is designed to be with low running cost to be privately operated by local governments. The cost depends on the mesh density, and the simulator to calculate the mesh density for required communication rate is under research.

Several applications are under development assuming emergency and normal situations. Contributions are very welcome especially for application services in normal situation, and the requirement of the network to realize the comfortable services.

Part I. Summary.

- Country: Japan
- Title of use case: Wireless Mesh Network System by bridging Satellite, UAV, and Ground Wireless Nodes
- Details of the person preparing the use case:
 - Name: Kiyoshi Hamaguchi
 - Title: Director, Wireless Mesh Network Laboratory, Resilient ICT Research Center
 - Organization: National Institute of Information and Communications Technology (NICT)
 - Address: 4-2-1 Nukui-Kitamachi, Koganei, Tokyo 184-8795, Japan
 - E-Mail: hamaguti [at] nict.go.jp
 - Website: <http://www.nict.go.jp/en/>
- Date of the submission: 14 May 2013
- ITU-T SG(s) to which you think your use case could be relevant:
 - SGs 2,5,11,13,16, IEEE 802.15.8(Peer-Aware-Communications)
- Status of use case:
 - ~~Operational~~ | ~~Completed~~ | Research and Development
 - If in operational, specify major deployment cases
- (Potential target) Location and population of the use case
 - Location (village, district, etc.) (or specify the target is city, rural, and/or countryside)
 - Population of the project area 1,000
- Relevant actors (played roles)
 - end-users, private sector organizations, public sector organizations, national/local government, others
 - If others, please specify:
- Type of disaster
 - ~~Cold wave~~ | ~~Drought~~ | Earthquake | ~~Epidemic~~ | ~~Extratropical Cyclone~~ | ~~Fire~~ | ~~Flash Flood~~ | ~~Flood~~ | ~~Heat Wave~~ | ~~Insect Infestation~~ | ~~Land Slide~~ | ~~Mad Slide~~ | ~~Severe Local Storm~~ | ~~Snow Avalanche~~ | ~~Storm Surge~~ | ~~Tech. Disaster~~ | ~~Tropical Cyclone~~ | Tsunami

- | ~~Volcano~~ | ~~Wild Fire~~ | Other
- if others, please specify:
- Type of use case
 - ~~Mitigation and prevention~~ | preparedness | ~~prediction and early warning~~ | response | ~~impact assessment~~ | recovery | reconstruction
 - Wired local loop: Copper, optical fibre, etc. (customers' loop) | Wireless local loop (customers' loop) | Fixed wireless access (long distance) | Mobile wireless access | Satellite two-way communications: VSAT, etc. | Wireless LANS and IP-based related networks | Terrestrial voice, data, sound or television broadcasting | Satellite voice, data, sound or television broadcasting | Hybrid or combined technologies
 - Others
 - if others, please specify:
- Objective and/or achievements of the use case
 - Disaster-resilient and flexibly deployable alternative network to our favourite cellular network
- summary of the use case indicating its expected social /economic impacts
 - Daily use service and running cost are key factor to be privately operated by local governments

Part II. Details.

- Overview of use case targets, objectives and financing
 - Objectives and implementation details of the use case including problem statement (tsunami, earthquake, drought, etc.):

The wireless mesh network based on the de-centralized mesh architecture would avoid the whole network blackout cause by some partial damage in the network, and keep the service in the isolated local area just after the large-scale disaster, by distributed database and application technologies. By bridging with full-automatic mobile earth stations and mobile repeater on unmanned aerial vehicle (UAV), isolated areas are connected.

- Brief description of the target country/region: geography, terrain, climate, demographics, socio-economic situation:

The Great East Japan Earthquake reminded us of the significance of mobile communications. We need to prepare disaster-resilient and flexibly deployable alternative network to our favourite cellular network, which could be damaged or congested in disasters.

- If any, technological improvement and its effects for providing new capabilities, reduced cost capital and operating cost solutions.

The wireless mesh network has a significantly improved disaster-resilience achieved by distributed database and distributed application technologies, which are not provided by the commercially available systems. The network is designed to be with low running cost in order to be privately operated by local governments in future. The cost depends on the mesh density, and the simulator to calculate the mesh density for needed communication rate is under research.

It also employs connections to small and on-vehicle full-automatic satellite earth stations and mobile repeaters to be provided by vehicles and program-controlled small unmanned aircrafts. These earth stations and mobile repeaters are expected to rapidly communication and monitoring links to isolated areas until the recovery of infrastructure.

In normal situation the daily used service is offered by only the wireless mesh network, and in special event full-automatic satellite earth stations and mobile repeater on unmanned aerial vehicle (UAV) are added to improve the quality of the network. The special event is also the training for the disaster.

- Infrastructure and regulatory environment
 - Infrastructure components: Necessary telecommunication facilities, transport access, electricity supply, distance to the nearest local exchange and/or IP network, human resources, security
Detailed information to be provided.
 - Regulatory components: Necessary license, frequency availability (for radio-based projects), other regulatory issues
Detailed information to be provided.
 - Other factors which influenced the operating environment (manufacturers, standards etc).

- Technical description of use case provided
 - Architecture, type of systems, main technical characteristics, frequencies (for radio-based projects), power consumption, performances (capacity, reliability, quality of service), network management, etc.,
Detailed information to be provided.
 - Installation and deployment: network planning, subscriber management, etc.
Detailed information to be provided.
 - Interconnection to national networks/backbones/disaster response systems
Detailed information to be provided.

- Cost | financial aspects, if possible
 - Cost of the equipment, cost per line and cost of the operation of the system
Detailed information to be provided.
 - Cost of each terminal and cost of the service for the user.
Free service for the user with BYOD(bring your own device)
 - Financial aspects of the use case
Cost and quality of daily used service are the key factor.

The cost is depended on the mesh density, and the simulator to calculate the mesh density for needed communication ratio is under research.

- Effectiveness and sustainability of the project
 - Effectiveness and benefits of the project for the targeted user groups
Only the daily used system can be usable at the disaster. Service in normal situation is the key to keep the network.

Several applications are under development assuming emergency and normal situations, for examples, such as information sharing in groups, safety confirmation, and distribution of sales information in shopping towns. Some of the healthcare applica-

tions will also be implemented to help elder or sick residents under disasters.
Detailed information of applications will be provided.

- Profitability of the project and/or its contribution to local entrepreneurial activities
 - Specific strategies to respond to the needs of women, youth, handicapped, indigenous people and other marginalized or socially disadvantaged groups
 - Aspects of the project, which could be strengthened to enhance its effectiveness or sustainability maximizing the benefits of telecommunication infrastructure in rural and remote areas.
- Other observations
 - Unexpected results and/or lessons learned
To be provided.
 - Derived requirements | requests for the emergency telecommunication community
To be provided.
 - Anticipated near/long-term future plan
To be provided.
 - Other source of information
 - Web
To be provided.
 - Important publications
To be provided.
 - Others

Local Private Wireless Mesh Network System

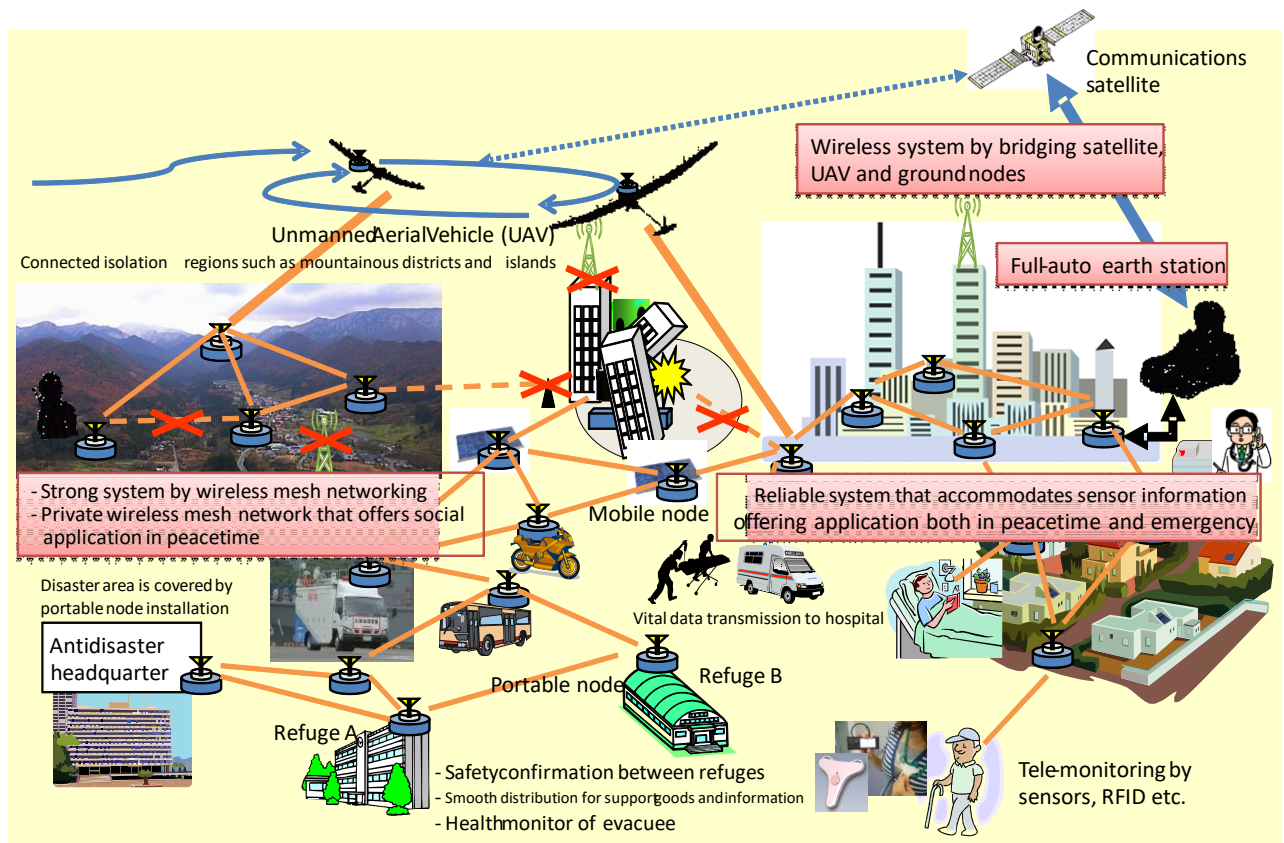

7) drnrr-i-0177 and 178: Introduction to elastic optical networking

Part I. Summary.

- Country: Japan
- Title of use case: Elastic optical networking (EON)
- Details of the person preparing the use case:
 - Name: Akira Hirano
 - Title: Supervisor, Senior Research Engineer
 - Organization: NTT Network Innovation Laboratories
 - Address: 1-1 Hikari-no-oka, Yokosuka, Kanagawa, 239-0847, Japan
 - E-Mail: hirano.akira [at] lab.ntt.co.jp
 - Website:
- Date of the submission:
- ITU-T SG(s) to which you think your use case could be relevant: SG15
- Status of use case:
 - Operational | Completed | Research and Development: R&D
 - If in operational, specify major deployment cases
- (Potential target) Location and population of the use case
 - Location (village, district, etc.) (or specify the target is city, rural, and/or country-side) :Nationwide and metro area
 - Population of the project area:

- Relevant actors (played roles)
 - end-users, private sector organizations, public sector organizations, national/local government, others: Private & public sector organizations
 - If others, please specify:
- Type of disaster

[EdNote: consider to edit this list. The list is easy to understand, but contains incidents that do not affect very much to telecom networks. Contributions invited.]

 - Cold wave | Drought | Earthquake | Epidemic | Extratropical Cyclone | Fire | Flash Flood | Flood | Heat Wave | Insect Infestation | Land Slide | Mad Slide | Severe Local Storm | Snow Avalanche | Storm Surge | Tech. Disaster | Tropical Cyclone | Tsunami | Volcano | Wild Fire | Other: Any disasters which damage optical transport systems.
 - if others, please specify:
- Type of use case
 - Mitigation and prevention | preparedness | prediction and early warning | response | impact assessment | recovery | reconstruction: Recovery
 - Wired local loop: Copper, optical fibre, etc. (customers' loop) | Wireless local loop (customers' loop) | Fixed wireless access (long distance) | Mobile wireless access | Satellite two-way communications: VSAT, etc. | Wireless LANS and IP-based related networks | Terrestrial voice, data, sound or television broadcasting | Satellite voice, data, sound or television broadcasting | Hybrid or combined technologies| Others :
 - if others, please specify:
- Objective and/or achievements of the use case: The key to a cost effective disaster recovery is to have a flexible enough network that can be reconfigured to provide maximum recovery of service. The elastic optical networking will provide full flexibility in optical transport network and eventually enhance bandwidth recovered and reduce time required for the recovery, when a disaster occurs and some fibres/cables or switches are seriously damaged.
- Summary of the use case indicating its expected social /economic impacts: Due to the more crucial role the network plays today, prompt and maximum recovery of the network infrastructure from large scale disasters is becoming more and more important. Regarding optical networking, an emerging new technology is defining finer optical-frequency intervals (i.e., optical frequency slot), which allows multiple use of them with different modulation formats, and thus provide different available bandwidth in an elastic manner by the choice of the number of slots and their formats. The elastic optical networking can fully utilize network resources including terrestrial and submarine cables/fibres, optical/electrical switches, and transponders in the most effective way, and realize maximum recovery of bandwidth (maximum % service traffic) with expedition. These features greatly benefit public network operators for their networks' recovery as well as other organizations for support nationwide and local communities in case of disaster.

Part II. Details.

- Overview of use case targets, objectives and financing
 - Objectives and implementation details of the use case including problem statement (tsunami, earthquake, drought, etc.): To provide prompt and maximum recovery of service, when a disaster occurs and some fibres/cables or switches are seriously damaged. For such purpose, elastic networking features such as distance-adaptive modulation with flexible grid channel allocation will be implemented in optical transport equipment to make large-scale rerouting through various routes including terrestrial

- and submarine cables/fibres.
- Brief description of the target country/region: geography, terrain, climate, demographics, socio-economic situation: Any counties
- If any, technological improvement and its effects for providing new capabilities, reduced cost capital and operating cost solutions.
- Infrastructure and regulatory environment
 - Infrastructure components: Necessary telecommunication facilities, transport access, electricity supply, distance to the nearest local exchange and/or IP network, human resources, security: The system works with remaining fibre/cable, optical transport equipment, and control software. There will be no human intervention needed.
 - Regulatory components: Necessary license, frequency availability (for radio-based projects), other regulatory issues: None
 - Other factors which influenced the operating environment (manufacturers, standards etc.): None
- Technical description of use case provided
 - Architecture, type of systems, main technical characteristics, frequencies (for radio-based projects), power consumption, performances (capacity, reliability, quality of service), network management, etc.: The system consists of flexible grid capable optical transport equipment including optical transponders with variable modulation format, flexible grid capable optical switches and so on. In addition to that, flexible grid capable network management system would be needed to automatically carry out recovery in a disaster.
 - Installation and deployment: network planning, subscriber management, etc. The elastic networking functionalities can be implemented in all kinds of optical transport equipment by upgrading their transponders and optical switches to flexible grid compliant version.
 - Interconnection to national networks/backbones/disaster response systems: The system works with nationwide networks as a unit.
- Cost | financial aspects, if possible
 - Cost of the equipment, cost per line and cost of the operation of the system: Not yet decided
 - Cost of each terminal and cost of the service for the user. : Not yet decided
 - Financial aspects of the use case: It depends on the owner of the system.
- Effectiveness and sustainability of the project
 - Effectiveness and benefits of the project for the targeted user groups : Prompt recovery of communication services around the devastated area and services connected through the area
 - Profitability of the project and/or its contribution to local entrepreneurial activities: The elastic networking feature yields higher transmission efficiency. Thus, the system can be used by public network operators for their services to be provided in a cost effective way in the normal situation.
 - Specific strategies to respond to the needs of women, youth, handicapped, indigenous people and other marginalized or socially disadvantaged groups : The system impact may be generic.
 - Aspects of the project, which could be strengthened to enhance its effectiveness or sustainability maximizing the benefits of telecommunication infrastructure in rural and remote areas. : The system can contribute cost effective installation of local network.
- Other observations
 - Unexpected results and/or lessons learned

- Derived requirements | requests for the emergency telecommunication community
- Anticipated near/long-term future plan
- Other source of information
 - Web
 - Important publications
 - Others

2.3. Prediction and early warning

1) drnr-i-0005: Mobile Systems for Disaster Relief and Early Warning

Part I. Summary.

- Country: Japan
- Title of use case: Mobile Systems for Disaster Relief and Early Warning
- Details of the person preparing the use case:
 - Name: Masao Kojima
 - Title:
 - Organization: KDDI
 - Address:
 - E-Mail: ms-kojima@kddi.com
 - Website:
- Date of the submission: FG on Disaster Relief Systems, Network Resilience and Recovery, Geneva, 25-27 June 2012 (i-5)
- ITU-T SG(s) to which you think your use case could be relevant: SG-2
- Status of use case:
 - Operational | Completed | Research and Development
 - If in operational, specify major deployment cases: The Great East Japan Earthquake
- (Potential target) Location and population of the use case
 - Location (village, district, etc.) (or specify the target is city, rural, and/or countryside): City
 - Population of the project area
- Relevant actors (played roles)
 - end-users, private sector organizations, public sector organizations, national/local government, others
 - If others, please specify:
- Type of disaster
 - Cold wave | Drought | Earthquake | Epidemic | Extratropical Cyclone | Fire | Flash Flood | Flood | Heat Wave | Insect Infestation | Land Slide | Mad Slide | Severe Local Storm | Snow Avalanche | Storm Surge | Tech. Disaster | Tropical Cyclone | Tsunami | Volcano | Wild Fire | Other
 - if others, please specify:
- Type of use case
 - Mitigation and prevention | preparedness | prediction and early warning | response | impact assessment | recovery | reconstruction (Relief)
 - Wired local loop: Copper, optical fibre, etc. (customers' loop) | Wireless local loop (customers' loop) | Fixed wireless access (long distance) | Mobile wireless access | Satellite two-way communications: VSAT, etc. | Wireless LANS and IP-based related networks | Terrestrial voice, data, sound or television broadcasting | Satellite voice, data, sound or television broadcasting | Hybrid or combined technologies | Others

- if others, please specify:
- Objective and/or achievements of the use case
- summary of the use case indicating its expected social /economic impacts

Part II. Details.

- Overview of use case targets, objectives and financing
 - Objectives and implementation details of the use case including problem statement (tsunami, earthquake, drought, etc.):

Most of all victims physically affected areas and refugees in non-physically affected areas run off with mobile device such as mobile phone, smart phone and tablet in hand after a quake.
 - Brief description of the target country/region: geography, terrain, climate, demographics, socio-economic situation: Early Warning-Transmission Only Within the Related Regions, Disaster Relief-300km far from the quake
 - If any, technological improvement and its effects for providing new capabilities, reduced cost capital and operating cost solutions.
- Infrastructure and regulatory environment
 - Infrastructure components: Necessary telecommunication facilities, transport access, electricity supply, distance to the nearest local exchange and/or IP network, human resources, security
 - Regulatory components: Necessary license, frequency availability (for radio-based projects), other regulatory issues
 - Other factors which influenced the operating environment (manufacturers, standards etc).
- Technical description of use case provided
 - Architecture, type of systems, main technical characteristics, frequencies (for radio-based projects), power consumption, performances (capacity, reliability, quality of service), network management, etc.,
 - Mobile device as a possible popular terminal for receiving disaster relief information
 - Mobile device with GPS functions to identify the location of victims and refugees
 - Smooth and effective communication despite traffic congestion or capacity limitation
 - Graphical guidance for easy and quick understanding by victims and refugees
 - Graphical guidance for easy and quick content creation even by local governments and rescue teams
 - Installation and deployment: network planning, subscriber management, etc.
 - Interconnection to national networks/backbones/disaster response systems
- Cost | financial aspects, if possible
 - Cost of the equipment, cost per line and cost of the operation of the system
 - Cost of each terminal and cost of the service for the user.
 - Financial aspects of the use case
- Effectiveness and sustainability of the project
 - Effectiveness and benefits of the project for the targeted user groups
 - Profitability of the project and/or its contribution to local entrepreneurial activities
 - Specific strategies to respond to the needs of women, youth, handicapped, indigenous people and other marginalized or socially disadvantaged groups
 - Aspects of the project, which could be strengthened to enhance its effectiveness or

sustainability maximizing the benefits of telecommunication infrastructure in rural and remote areas.

- Other observations
 - Unexpected results and/or lessons learned
 - Derived requirements | requests for the emergency telecommunication community
 - Anticipated near/long-term future plan
- Other source of information
 - Web
 - Important publications
 - Others

2) drnrr-i-0029: Early Warning Systems (EWS)

Part I. Summary.

- Country : UN ISDR (The United Nations Office for Disaster Risk Reduction)
- Title of use case: Early Warning Systems (EWS)
- Details of the person preparing the use case:
 - Name: Veronica F. Grasso, Ph. D.
 - Title:
 - Organization: UNDP (United Nations Development Programme)
 - Address:
 - E-Mail: Veronica.grasso@undp.org
 - Website:
- Date of the submission: FG-DR&NRR, Geneva, 24 – 26 September, 2012 (i-29)
- ITU-T SG(s) to which you think your use case could be relevant: SG-16, 17 to be specified
- Status of use case:
 - Operational | Completed | Research and Development
 - If in operational, specify major deployment cases
- (Potential target) Location and population of the use case
 - Location (village, district, etc.) (or specify the target is city, rural, and/or countryside)
 - Population of the project area
- Relevant actors (played roles)
 - end-users, private sector organizations, public sector organizations, national/local government, others
 - If others, please specify:
- Type of disaster: to be specified
 - Cold wave | Drought | Earthquake | Epidemic | Extratropical Cyclone | Fire | Flash Flood | Flood | Heat Wave | Insect Infestation | Land Slide | Mad Slide | Severe Local Storm | Snow Avalanche | Storm Surge | Tech. Disaster | Tropical Cyclone | Tsunami | Volcano | Wild Fire | Other
 - if others, please specify: slow-onset threat such as El Nino, climate change
- Type of use case
 - Mitigation and prevention | preparedness | prediction and early warning | response | impact assessment | recovery | reconstruction
 - To be specified | Wired local loop: Copper, optical fibre, etc. (customers' loop) | Wireless local loop (customers' loop) | Fixed wireless access (long distance) | Mobile wireless access | Satellite two-way communications: VSAT, etc. | Wireless LANS and IP-based related networks | Terrestrial voice, data, sound or television broadcast-

ing | Satellite voice, data, sound or television broadcasting | Hybrid or combined technologies| Others

- if others, please specify:
- Objective and/or achievements of the use case : To reduce communication lead time
- summary of the use case indicating its expected social /economic impacts

Part II. Details.

- Overview of use case targets, objectives and financing
 - Objectives and implementation details of the use case including problem statement (tsunami, earthquake, drought, etc.): Earthquake
 - Brief description of the target country/region: geography, terrain, climate, demographics, socio-economic situation: Japan
 - If any, technological improvement and its effects for providing new capabilities, reduced cost capital and operating cost solutions.
- Infrastructure and regulatory environment
 - Infrastructure components: Necessary telecommunication facilities, transport access, electricity supply, distance to the nearest local exchange and/or IP network, human resources, security : A dense seismic network (i.e.20km) to detect an earthquake, TV, radio stations and cellular phones in the affected region
 - Regulatory components: Necessary license, frequency availability (for radio-based projects), other regulatory issues
 - Other factors which influenced the operating environment (manufacturers, standards etc).
- Technical description of use case provided
 - Architecture, type of systems, main technical characteristics, frequencies (for radio-based projects), power consumption, performances (capacity, reliability, quality of service), network management, etc., : frequencies and channels must be reserved and dedicated to disaster relief operations
 - Installation and deployment: network planning, subscriber management, etc.
 - Interconnection to national networks/backbones/disaster response systems
- Cost | financial aspects, if possible
 - Cost of the equipment, cost per line and cost of the operation of the system
 - Cost of each terminal and cost of the service for the user.
 - Financial aspects of the use case
- Effectiveness and sustainability of the project
 - Effectiveness and benefits of the project for the targeted user groups
 - Profitability of the project and/or its contribution to local entrepreneurial activities
 - Specific strategies to respond to the needs of women, youth, handicapped, indigenous people and other marginalized or socially disadvantaged groups
 - Aspects of the project, which could be strengthened to enhance its effectiveness or sustainability maximizing the benefits of telecommunication infrastructure in rural and remote areas.
- Other observations
 - Unexpected results and/or lessons learned
 - Derived requirements | requests for the emergency telecommunication community: Telecommunication functionality and capability from authority to authority for coordination and sharing of information| Telecommunication functionality and capability from authority to citizen
 - Anticipated near/long-term future plan

- Other source of information
 - Web
 - Important publications
 - Others

3) drnr-i-0144: Proposal for a use case of area mail systems over mobile networks

Part I. Summary.

- Country: Japan
- Title of use case: Area Mail
- Details of the person preparing the use case:
 - Name: Kozue ISHIDA
 - Title: Engineer
 - Organization: NTT DOCOMO
 - Address: Kokusai Akasaka Building, 2-4-5 Akasaka Minato-ku, Tokyo 107-0052, Japan
 - E-Mail: cbs-ml[at]nttdocomo.co.jp
 - Website: http://www.nttdocomo.co.jp/english/service/safety/areamail/index.html
- Date of the submission: FG on Disaster Relief Systems, Network Resilience and Recovery, Santiago de Chile, 23-25 October 2013
- ITU-T SG(s) to which you think your use case could be relevant: SG-2
- Status of use case:
 - Operational | Completed | Research and Development
 - If in operational, specify major deployment cases: The Great East Japan Earthquake
- (Potential target) Location and population of the use case
 - Location (village, district, etc.) (or specify the target is city, rural, and/or countryside): City
 - Population of the project area
- Relevant actors (played roles)
 - end-users who are in affected area, local government
 - If others, please specify:
- Type of disaster: all types
 - Cold wave | Drought | Earthquake | Epidemic | Extratropical Cyclone | Fire | Flash Flood | Flood | Heat Wave | Insect Infestation | Land Slide | Mad Slide | Severe Local Storm | Snow Avalanche | Storm Surge | Tech. Disaster | Tropical Cyclone | Tsunami | Volcano | Wild Fire | Other
 - if others, please specify:
- Type of use case
 - Mitigation and prevention | preparedness | prediction and early warning | response | impact assessment | recovery | reconstruction (Relief)
 - Wired local loop: Copper, optical fibre, etc. (customers' loop) | Wireless local loop (customers' loop) | Fixed wireless access (long distance) | Mobile wireless access | Satellite two-way communications: VSAT, etc. | Wireless LANS and IP-based related networks | Terrestrial voice, data, sound or television broadcasting | Satellite voice, data, sound or television broadcasting | Hybrid or combined technologies | Others
 - if others, please specify:
- Objective and/or achievements of the use case : notify early warnings to people in the

- affected area
- summary of the use case indicating its expected social /economic impacts

Part II. Details.

- Overview of use case targets, objectives and financing
 - Objectives and implementation details of the use case including problem statement (tsunami, earthquake, drought, etc.):

The objectives of this use case are to send early warning messages to users who are in affected areas. Since most people have mobile phone, it seems useful to send alerting messages to mobile phones which are existed in area at risk from disaster such as earthquake and tsunami. When people get alerting message, they can be prepared for expecting disaster damages. In general, there are people who happen to be there, such as commuter and tourist, and it is necessary to inform alerting messages to those people. Area Mail can broadcast alert messages to mobile phones in the specific areas at risk from upcoming disaster at that time.

In addition, some of the triggers of broadcasting alert messages are automatically touched by Meteorological Bureau to send messages based on reliable information and rapidly.
 - Brief description of the target country/region: geography, terrain, climate, demographics, socio-economic situation: All countries where mobile phones are widely used
 - If any, technological improvement and its effects for providing new capabilities, reduced cost capital and operating cost solutions.
- Infrastructure and regulatory environment
 - Infrastructure components: Necessary telecommunication facilities, transport access, electricity supply, distance to the nearest local exchange and/or IP network, human resources, security
 - Regulatory components: Necessary license, frequency availability (for radio-based projects), other regulatory issues
 - Other factors which influenced the operating environment (manufacturers, standards etc).
- Technical description of use case provided
 - Architecture, type of systems, main technical characteristics, frequencies (for radio-based projects), power consumption, performances (capacity, reliability, quality of service), network management, etc.,
 - Cellular phone network which can handle Cell Broadcast Services
 - Central system to receive early warning information from meteorological institute
 - Central system to broadcast early warning messages to specific areas at risk from disaster
 - Mobile phones to be sent alerting message.
 - Installation and deployment: network planning, subscriber management, etc.
 - Mobile phone network which can handle Cell Broadcast Service
 - Interconnection to national networks/backbones/disaster response systems
- Cost | financial aspects, if possible
 - Cost of the equipment, cost per line and cost of the operation of the system

- ◇
- Cost of each terminal and cost of the service for the user.
- Financial aspects of the use case
- Effectiveness and sustainability of the project
 - Effectiveness and benefits of the project for the targeted user groups
 - Profitability of the project and/or its contribution to local entrepreneurial activities
 - Specific strategies to respond to the needs of women, youth, handicapped, indigenous people and other marginalized or socially disadvantaged groups
 - Aspects of the project, which could be strengthened to enhance its effectiveness or sustainability maximizing the benefits of telecommunication infrastructure in rural and remote areas.
- Other observations
 - Unexpected results and/or lessons learned
 - Derived requirements | requests for the emergency telecommunication community: Security, High-reliability
 - Anticipated near/long-term future plan
- Other source of information
 - Web
 - Important publications
 - Others

Distributors (such as national or local public bodies) input disaster information to Area Mail System, then the system delivers the Area Mail only to specified area.

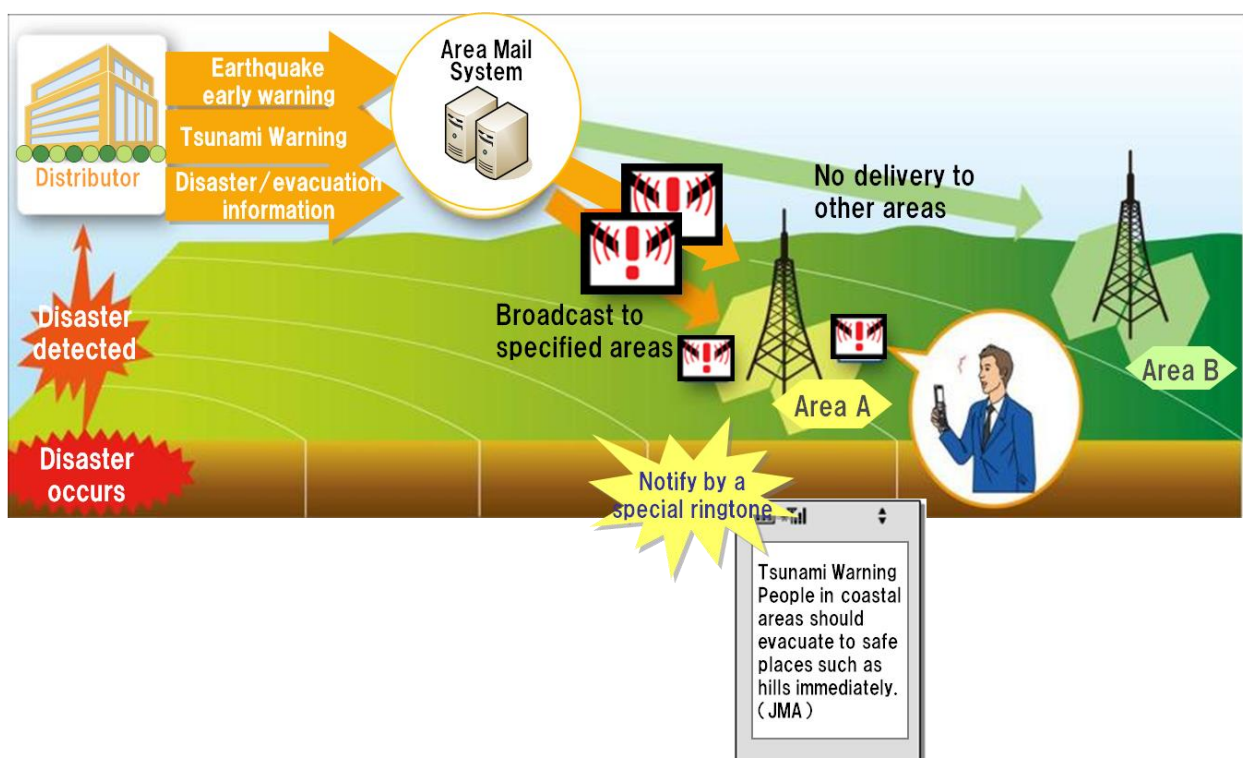

4) 2nd Workshop, Dec. 2012 Session 2-2: Disaster Solutions based on Experiences in Japan Quake 2011

Part I. Summary.

- Country: Japan
- Title of use case: Disaster Solutions based on Experiences in Japan Quake 2011
- Details of the person preparing the use case:
 - Name: Takashi Egawa
 - Title:
 - Organization: NEC Corporation
 - Address:
 - E-Mail: t-egawa@ct.jp.nec.com
 - Website:
- Date of the submission: Workshop on Disaster Relief Systems, Network Resilience and Recovery, Istanbul, Turkey, 11 December 2012 (Presentation 2-2)
- ITU-T SG(s) to which you think your use case could be relevant:
- Status of use case:
 - Operational | Completed | Research and Development
 - If in operational, specify major deployment cases
- (Potential target) Location and population of the use case
 - Location (village, district, etc.) (or specify the target is city, rural, and/or countryside)
 - Population of the project area
- Relevant actors (played roles)
 - end-users, private sector organizations, public sector organizations, national/local government, others
 - If others, please specify:
- Type of disaster

[EdNote: consider to edit this list. The list is easy to understand, but contains incidents that do not affect very much to telecom networks. Contributions invited.]

 - Cold wave | Drought | Earthquake | Epidemic | Extratropical Cyclone | Fire | Flash Flood | Flood | Heat Wave | Insect Infestation | Land Slide | Mad Slide | Severe Local Storm | Snow Avalanche | Storm Surge | Tech. Disaster | Tropical Cyclone | Tsunami | Volcano | Wild Fire | Other
 - if others, please specify:
- Type of use case
 - Mitigation and prevention | preparedness | prediction and early warning | response | impact assessment | recovery | reconstruction
 - Wired local loop: Copper, optical fibre, etc. (customers' loop) | Wireless local loop (customers' loop) | Fixed wireless access (long distance) | Mobile wireless access | Satellite two-way communications: VSAT, etc. | Wireless LANS and IP-based related networks | Terrestrial voice, data, sound or television broadcasting | Satellite voice, data, sound or television broadcasting | Hybrid or combined technologies | Others
 - if others, please specify:
- Objective and/or achievements of the use case :

Different solutions are required on each phase in a disaster.
- summary of the use case indicating its expected social /economic impacts

Part II. Details.

- Overview of use case targets, objectives and financing
 - Objectives and implementation details of the use case including problem statement (tsunami, earthquake, drought, etc.):
 - Different solutions are required on each phase in a disaster.
 - Brief description of the target country/region: geography, terrain, climate, demographics, socio-economic situation:
 - If any, technological improvement and its effects for providing new capabilities, reduced cost capital and operating cost solutions.
- Infrastructure and regulatory environment
 - Infrastructure components: Necessary telecommunication facilities, transport access, electricity supply, distance to the nearest local exchange and/or IP network, human resources, security
 - Cell Broadcast Service (CBS) based Emergency Alerts contributed reduction of damages.
 - Location based services were utilized to find evacuation places and people.
 - There were interruptions of telephone network in Metropolitan areas, that has triggered Disaster Voice Message Service (DVMS) development.
 - Regulatory components: Necessary license, frequency availability (for radio-based projects), other regulatory issues
 - Other factors which influenced the operating environment (manufacturers, standards etc).
- Technical description of use case provided
 - Architecture, type of systems, main technical characteristics, frequencies (for radio-based projects), power consumption, performances (capacity, reliability, quality of service), network management, etc.,
 - 1) Emergency Alert by Cell Broadcast Service (CBS)
 - Actions in a few seconds in advance of strong quakes significantly reduce damages
 - Automatic quake detection/notification gives you in distant area a few seconds.
 - Human lives can be saved from collapse of buildings
 - Accurate and timely delivery of disaster information is critical
 - Broadcast delivery based on automatic earthquake detection and its impact analysis.
 - Evacuation information should be delivered to mobile phones in damaged areas
 - CBS is network congestion tolerant
 - It enables to deliver urgent information under congestion after a disaster.
 - 2) Position Report on Emergency Call
 - In Japan, on receiving an emergency call, a Public Safety Answering Point (PSAP) can acquire the caller's position information based on A-GPS or Cell.
 - Emergency calls from mobile phones increased in Japan Quake 2011.
 - 3) Disaster Voice Messaging Service (DVMS)
 - Voice communication is required in disasters to carry feeling of relief
 - Mobile and fixed phones, SMS, and MMS are affected by call restriction.

- Twitter and Facebook are available in disasters, but they are not for urgent communications

Disaster Voice Messaging Service (DVMS) was developed after Japan Quake 2011.

- Installation and deployment: network planning, subscriber management, etc.
- Interconnection to national networks/backbones/disaster response systems
- Cost | financial aspects, if possible
 - Cost of the equipment, cost per line and cost of the operation of the system
 - Cost of each terminal and cost of the service for the user.
 - Financial aspects of the use case
- Effectiveness and sustainability of the project
 - Effectiveness and benefits of the project for the targeted user groups
 - Profitability of the project and/or its contribution to local entrepreneurial activities
 - Specific strategies to respond to the needs of women, youth, handicapped, indigenous people and other marginalized or socially disadvantaged groups
 - Aspects of the project, which could be strengthened to enhance its effectiveness or sustainability maximizing the benefits of telecommunication infrastructure in rural and remote areas.
- Other observations
 - Unexpected results and/or lessons learned
 - Derived requirements | requests for the emergency telecommunication community
 - Anticipated near/long-term future plan
- Other source of information
 - Web
 - Important publications
 - Others

2.4. Response

1) drnr-i-0013: The Role of the Amateur Service in Emergency Telecommunications

Part I. Summary.

- Country: International
- Title of use case : The Role of the Amateur Service in Emergency Telecommunications
- Details of the person preparing the use case:
 - Name: Hans Zimmermann
 - Title: Coordinator for Emergency Communications
 - Organization: International Amateur Radio Union (IARU)
 - Address: POB 310905, Newington, CT, 06131-0905, USA
 - E-Mail: hans.zimmermann@ties.itu.int
 - Website:
- Date of the submission: FG on DR-NRR, Geneva, 24-26 September 2012 (i-13)
- ITU-T SG(s) to which you think your use case could be relevant:
- Status of use case:
 - Operational | Completed | Research and Development
 - If in operational, specify major deployment cases
- (Potential target) Location and population of the use case
 - Location (village, district, etc.) (or specify the target is city, rural, and/or country-side)

- Population of the project area
- Relevant actors (played roles)
 - end-users, private sector organizations, public sector organizations, national/local government, others
 - If others, please specify:
- Type of disaster
 - Cold wave | Drought | Earthquake | Epidemic | Extratropical Cyclone | Fire | Flash Flood | Flood | Heat Wave | Insect Infestation | Land Slide | Mad Slide | Severe Local Storm | Snow Avalanche | Storm Surge | Tech. Disaster | Tropical Cyclone | Tsunami | Volcano | Wild Fire | Other
 - if others, please specify:
- Type of use case
 - Mitigation and prevention | preparedness | prediction and early warning | response | impact assessment | recovery | reconstruction
 - Wired local loop: Copper, optical fibre, etc. (customers' loop) | Wireless local loop (customers' loop) | Fixed wireless access (long distance) | Mobile wireless access | Satellite two-way communications: VSAT, etc. | Wireless LANS and IP-based related networks | Terrestrial voice, data, sound or television broadcasting | Satellite voice, data, sound or television broadcasting | Hybrid or combined technologies | Others
 - if others, please specify: Amateur Radio Service
- Objective and/or achievements of the use case
- summary of the use case indicating its expected social /economic impacts

Part II. Details.

- Overview of use case targets, objectives and financing
 - Objectives and implementation details of the use case including problem statement (tsunami, earthquake, drought, etc.):
 - Transmitting an alert from an affected location such as small islands or other geographically isolated locations to the “outside world”. The Amateur Service has repeatedly be the first link to potential sources of assistance. The best-known example occurred during the earthquake and tsunami in 2004.
 - the Amateur Service can provide, thanks to its independence of infrastructure, communication channels to local emergency management entities in an affected location when other networks are already affected by the impact of a disaster. Examples are events extending over wider areas in unpredictable ways, such as tropical storms, floods, or secondary effects of earthquakes.
 - For communications with and among health care facilities such as hospitals, the Amateur Service is in several countries, including the USA, a standard component of emergency preparedness. An example for a use of the Amateur Service as a replacement of normal links between hospitals for cooperation and for coordination of evacuations in the aftermath of hurricane Katrina, 2005.
 - The Amateur Service has in many cases enabled the communication of “health-and-welfare-messages” by relaying such information to stations outside the affected area, which could then pass them on via the public networks and cooperate with the services assisting persons displaced by an event.

- In several countries, Turkey being one example, amateur radio is an integrated element of the communication structures of rescue teams in national and international operations.
- Large exercises, e.g. in Finland in 2003 in cooperation with government authorities, were based on the assumption of a complete failure of the national power grid, and proved the capabilities of the Amateur Service to quickly establish and to maintain a wide area network.
- Some specialized groups, e.g. in the USA and in Germany, dispose of mobile equipment with sufficient capacity to provide power to a limited extent also for emergency responders with whom they cooperate.
- Brief description of the target country/region: geography, terrain, climate, demographics, socio-economic situation: Worldwide there are more than 2 Million licensed Amateurs or “hams”, as they call themselves.
- If any, technological improvement and its effects for providing new capabilities, reduced cost capital and operating cost solutions.:
- Infrastructure and regulatory environment
 - Infrastructure components: Necessary telecommunication facilities, transport access, electricity supply, distance to the nearest local exchange and/or IP network, human resources, security
 - Regulatory components: Necessary license, frequency availability (for radio-based projects), other regulatory issues : Exceptions, such as a qualified handling of third-party-traffic, are defined in respective regulations; the Amateur Service can thus in no case serve as a means to circumvent national, regional or international restrictions of information exchange as might be imposed by national administrations during exceptional situations.
 - Other factors which influenced the operating environment (manufacturers, standards etc).
- Technical description of use case provided
 - Architecture, type of systems, main technical characteristics, frequencies (for radio-based projects), power consumption, performances (capacity, reliability, quality of service), network management, etc., :
 - ✧ Stations of the Amateur Service are typically more resistant against the physical impact of disasters - mostly because of the abilities of the skilled operators, to put all remaining resources to best use. Damaged antennas can be replaced by improvisations, and damaged sophisticated equipment can often still be put to use in a simplified way.
 - ✧ Many stations of the Amateur Service dispose of own, network independent, power sources for base stations and for the charging of batteries of portable equipment.
 - Installation and deployment: network planning, subscriber management, etc.
 - Interconnection to national networks/backbones/disaster response systems
- Cost | financial aspects, if possible
 - Cost of the equipment, cost per line and cost of the operation of the system
 - Cost of each terminal and cost of the service for the user.
 - Financial aspects of the use case
- Effectiveness and sustainability of the project
 - Effectiveness and benefits of the project for the targeted user groups
 - Profitability of the project and/or its contribution to local entrepreneurial activities
 - Specific strategies to respond to the needs of women, youth, handicapped, indigenous

- people and other marginalized or socially disadvantaged groups
- Aspects of the project, which could be strengthened to enhance its effectiveness or sustainability maximizing the benefits of telecommunication infrastructure in rural and remote areas.
- Other observations
 - Unexpected results and/or lessons learned
 - Derived requirements | requests for the emergency telecommunication community
 - Anticipated near/long-term future plan
- Other source of information
 - Web
 - Important publications
 - Others

2) 2nd Workshop, Dec. 2012 Session2-3: How Can We Built the Infrastructure of Radio Communication Systems for Disaster Relief and Situation in Turkey

Part I. Summary.

- Country: Turkey
- Title of use case: How Can We Built the Infrastructure of Radio Communication Systems for Disaster Relief and Situation in Turkey
- Details of the person preparing the use case:
 - Name: Talip Küçükklıç
 - Title: Senior Expert Engineer
 - Organization: ASELSAN
 - Address: N.A.
 - E-Mail: N.A.
 - Website: N.A.
- Date of the submission: 11 December, 2012
- ITU-T SG(s) to which you think your use case could be relevant: TBD
- Status of use case:
 - Operational
 - If in operational, specify major deployment cases: N.A.
- (Potential target) Location and population of the use case: N.A.
 - Location (village, district, etc.) (or specify the target is city, rural, and/or countryside)
 - Population of the project area
- Relevant actors (played roles): Public Safety Actors (Professionals, Agencies, Volunteers, etc)
 - end-users
 - private sector organizations
 - public sector organizations
 - national/local government
 - others
 - If others, please specify:
- Type of disaster: Not specified.
 - Cold wave | Drought | Earthquake | Epidemic | Extratropical Cyclone | Fire | Flash Flood | Flood | Heat Wave | Insect Infestation | Land Slide | Mad Slide | Severe Local Storm | Snow Avalanche | Storm Surge | Tech. Disaster | Tropical Cyclone | Tsunami | Volcano | Wild Fire | Other
 - if others, please specify:
- Type of use case
 - preparedness | response
 - Wired local loop: Copper, optical fibre, etc. (customers' loop) | Wireless local loop (customers' loop) | Fixed wireless access (long distance) | Mobile wireless access | Satellite two-way communications: VSAT, etc. | Wireless LANS and IP-based related networks | Terrestrial voice, data, sound or television broadcasting | Satellite voice, data, sound or television broadcasting | Hybrid or combined technologies| Others
 - if others, please specify: Radio Communication System
- Objective and/or achievements of the use case
 - Objectives: Definition of disaster driven requirements of Radio Communication Systems
 - Achievements:

- There should be at least one “b” plan for each critical system component’s service interruption
- Power input of the critical system components should be backed up
- The system should respond to the higher demand of radio communication requests
- Connections to the outside networks/systems should be backed up
- The Radio Communication System should serve every emergency and disaster related organization
- summary of the use case indicating its expected social/economic impacts

Part II. Details.

- Overview of use case targets, objectives and financing
 - Objectives and implementation details of the use case including problem statement (tsunami, earthquake, drought, etc.):
 1. In case of a disaster, Public Safety Actors (Professionals, Agencies, Volunteers, etc) require a non-commercial, wide area, Radio Communication System for
 - in-house communication
 - inter-agency communication
 2. In case of a disaster, coordination and cooperation of the public safety actors require a common Radio Communication Network
 - Brief description of the target country/region: geography, terrain, climate, demographics, socio-economic situation: Turkey
 - If any, technological improvement and its effects for providing new capabilities, reduced cost capital and operating cost solutions.
- Infrastructure and regulatory environment
 - Infrastructure components:
 - Necessary telecommunication facilities: non-commercial Radio Communication System
 - transport access
 - electricity supply
 - distance to the nearest local exchange and/or IP network
 - human resources
 - security
 - Regulatory components:
 - Necessary license
 - frequency availability (for radio-based projects)
 - other regulatory issues
 - Other factors which influenced the operating environment (manufacturers, standards etc).
- Technical description of use case provided
 - Architecture, type of systems, main technical characteristics, frequencies (for radio-based projects), power consumption, performances (capacity, reliability, quality of service), network management, etc.,
 - Emergency Call Centers (PSAPs)
 - Voice Switching Equipments (SIP&VoIP based)
 - Operator Applications
 - Call Taker SW

Dispatcher (Professional Agency Operator) SWAVL SW- System Management ApplicationsSystem Management & Diagnostics SWVoice Recorder SW

- Installation and deployment: network planning, subscriber management, etc.
- Interconnection to national networks/backbones/disaster response systems
- Cost | financial aspects, if possible: N.A.
 - Cost of the equipment, cost per line and cost of the operation of the system
 - Cost of each terminal and cost of the service for the user.
 - Financial aspects of the use case
- Effectiveness and sustainability of the project
 - Effectiveness and benefits of the project for the targeted user groups
 - Profitability of the project and/or its contribution to local entrepreneurial activities
 - Specific strategies to respond to the needs of women, youth, handicapped, indigenous people and other marginalized or socially disadvantaged groups
 - Aspects of the project, which could be strengthened to enhance its effectiveness or sustainability maximizing the benefits of telecommunication infrastructure in rural and remote areas.
- Other observations
 - Unexpected results and/or lessons learned
 - Derived requirements | requests for the emergency telecommunication community

[THE FACTS ABOUT THE DISASTER]

1. In case of a disaster, Public Safety Actors (Professionals, Agencies, Volunteers, etc) require a non-commercial, wide area, Radio Communication System for

in-house communication

inter-agency communication

2. In case of a disaster, coordination and cooperation of the public safety actors require a common Radio Communication Network

[DISASTER DRIVEN REQUIREMENTS of Radio Communication Systems]

1. There should be at least one “b” plan for each critical system component’s service interruption

2. Power input of the critical system components should be backed up

3. The system should respond to the higher demand of radio communication requests

4. Connections to the outside networks/systems should be backed up

5. The Radio Communication System should serve every emergency and disaster related organization

➤ Anticipated near/long-term future plan

1. The competent authorities need to decide the common Public Safety Radio Communication System of Turkey, which will also be used in disaster situations.

2. All of the public safety actors should be a part of the system, in order to achieve high level of integration, coordination and cooperation.

- Other source of information

- Web
- Important publications
- Others

3) 5th workshop, Session 2-3, GeoThings Platform, How ICT Coordinates Humanitarian Assistance and Disaster Relief

Part I. Summary.

- Country
- Title of usage assessment: GeoThings Platform, How ICT Coordinates Humanitarian Assistance and Disaster Relief
- Details of the person preparing the usage assessment:
 - Name: Kuo-Yu slayer Chuang
 - Title: CEO
 - Organization: GeoThings
 - Address: Rm. 417, Bldg. 51, No. 195, Sec. 4, Chungshin Rd., Chuthung, Hsinchu, Taiwan, province of China
 - E-Mail: slayer@geothings.tw
 - Website: <http://geothings.tw>
- Date of the submission: May 24th, 2013
- ITU-T SG(s) to which you think your usage assessment could be relevant: ITU-T SG11
- Status of usage assessment:
 - Completed
- (Potential target) Location and population of the usage assessment
 - Location: Worldwide (with GSM signal access).
 - Population of the project area: No constraint.
- Relevant actors (played roles)
 - NGOs, INGOs, disaster responders, and the volunteers.
- Type of disaster

[EdNote: consider to edit this list. The list is easy to understand, but contains incidents that do not affect very much to telecom networks. Contributions invited.]

- Cold wave | Drought | Earthquake | Epidemic | Extratropical Cyclone | Fire | Flash Flood | Flood | Heat Wave | Insect Infestation | Land Slide | Mad Slide | Severe Local Storm | Snow Avalanche | Storm Surge | Tech. Disaster | Tropical Cyclone | Tsunami | Volcano | Wild Fire | Other
- if others, please specify:
- Type of usage assessment
 - Disaster response, relief, recovery, and reconstruction
 - Mobile wireless access, GMS/3G networks, offline map resource (Open Street Map), GPS.
- Objective and/or achievements of the usage assessment
 - Disaster response, relief, recovery, and reconstruction
- Summary of the usage assessment indicating its expected social /economic impacts
 - International community has evolved to a stage where emergency response and rescue teams and relief organizations from many countries rush to help in major disasters. But due to factors from rescue site chaos to differences among teams of different culture, it's frustrating that an efficiently coordinated rescue management on site appears to be the remotest thing. There're always overlapped efforts, requests unattended and miss-placed priorities throughout these humanitarian missions. Pity, this

means less lives saved. With technologies we have today, this should not have been the case. Blame can be on anything from language barrier, equipment incompatibility, to difficulty in setting up a chain of command. But truly, the real problem is a missing management information system, one that's anything but difficult to develop. It's amazing that none has developed it – until now. GeoThings Platform, SituationDesk, is one such system to help save more lives in future disasters.

Part II. Details.

- Overview of usage assessment targets, objectives and financing
 - GeoThings SituationDesk is developed by a team of enthusiastic employees of ITRI's to address the issue of automation in the fast-paced and chaotic rescue and relief operations on ground zero of a disaster. It is built incorporating the use of Open GeoSMS, which was originally developed by ITRI in 2008 and approved by Open Geospatial Consortium as standard.

GeoThings SituationDesk will be released to a social enterprise ITRI plans to establish later this year. Named GeoThings, this enterprise will be staffed mainly by members of the team that was responsible for the development of the precursor to Open GeoSMS.

GeoThings SituationDesk will be one of the first products and services GeoThings live on. As an automation software product and service, SituationDesk is suitable for international rescue and relief teams and organizations to coordinate their rescue site operations.

- Infrastructure and regulatory environment
 - Infrastructure components: GSM signal for SMS, IP network to access GeoThings Web service, Cloud service to operate GeoThings Platform.
 - Regulatory components: Necessary license, frequency availability (for radio-based projects), other regulatory issues: N/A
 - Other factors which influenced the operating environment (manufacturers, standards etc).
- Technical description of usage assessment provided

Geothings 究心科技

Disaster Management & Coordination Platform

<http://geothings.tw>
 Kuo-Yu slayer Chuang
 slayer@geothings.tw

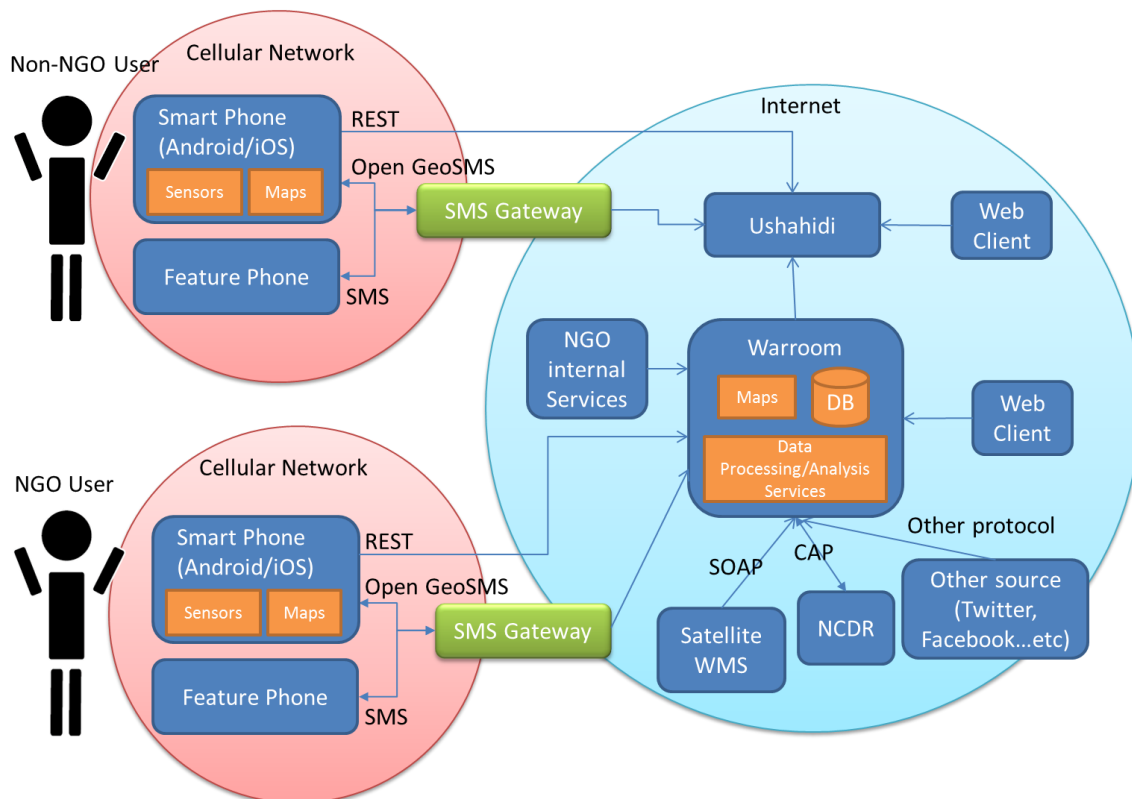
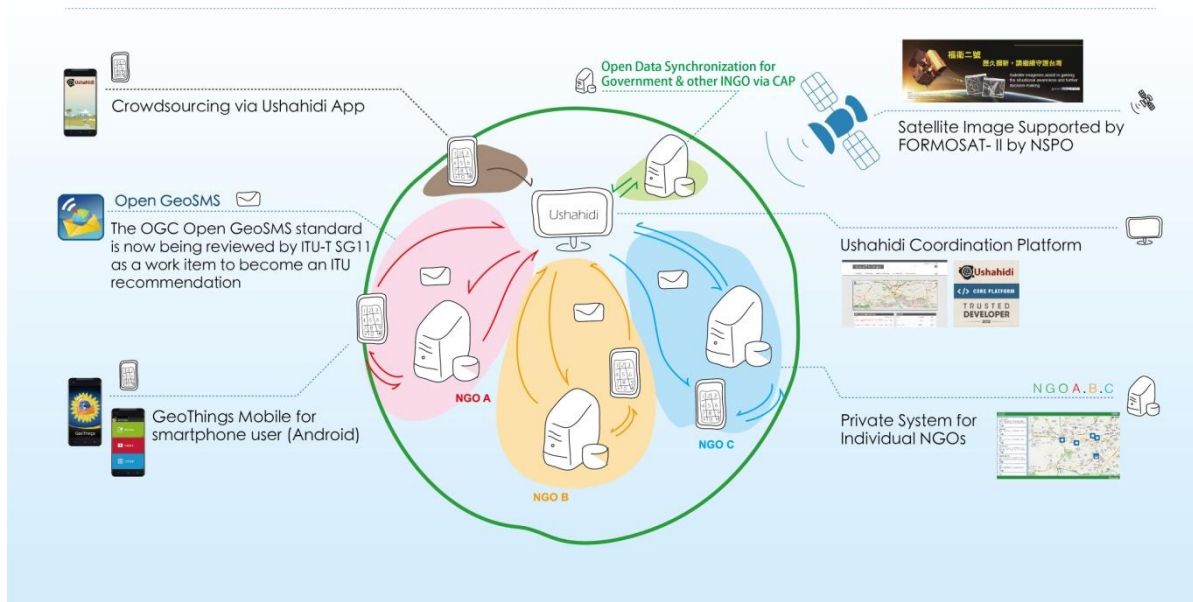

- Cost | financial aspects, if possible
 - Cost of the equipment, cost per line and cost of the operation of the system
 - Cost of each terminal and cost of the service for the user.

- Financial aspects of the usage assessment
- Effectiveness and sustainability of the project
 - Humanitarian organizations or NGOs need the information and resource management system for disaster relief. GeoThings platform provides and enhance the management process with ICT tool.
 - GeoThings is going to be a not-for-profit foundation and has its self-sustainable business plan to operate this ICT service for large/middle/small humanitarian NGOs.
 - GeoThings collaborates with university student in Taiwan, province of China, for a mobile app (with Open GeoSMS) that enables the people who can't listen/speak to report emergency situation to police force.
- Other observations
 - Unexpected results and/or lessons learned
 - Derived requirements | requests for the emergency telecommunication community
 - Anticipated near/long-term future plan
- Other source of information
 - Web
 - Important publications

Others

4) dr-nrr-i-0120: Safety confirmation and broadcasting message systems for business continuity

Part I. Summary.

- Country: Japan
- Title of use case: Safety confirmation and broadcast message systems for business continuity
- Details of the person preparing the use case:
 - Name: Hideo IMANAKA
 - Title: General Manager
 - Organization: NTT
 - Address:
 - E-Mail: h.imanaka[at]hco.ntt.co.jp
 - Website:
- Date of the submission: FG on Disaster Relief Systems, Network Resilience and Recovery, Issyk-kul, 21-23 August 2013
- ITU-T SG(s) to which you think your use case could be relevant: SG-2
- Status of use case:
 - Operational | Completed | Research and Development
 - If in operational, specify major deployment cases: The Great East Japan Earthquake
- (Potential target) Location and population of the use case
 - Location (village, district, etc.) (or specify the target is city, rural, and/or countryside): Global
 - Population of the project area
- Relevant actors (played roles)
 - end-users, private sector organizations, public sector organizations, national/local government, others
 - If others, please specify:
- Type of disaster: all types

- Cold wave | Drought | Earthquake | Epidemic | Extratropical Cyclone | Fire | Flash Flood | Flood | Heat Wave | Insect Infestation | Land Slide | Mad Slide | Severe Local Storm | Snow Avalanche | Storm Surge | Tech. Disaster | Tropical Cyclone | Tsunami | Volcano | Wild Fire | Other
- if others, please specify:
- Type of use case
 - Mitigation and prevention | preparedness | prediction and early warning | response | impact assessment | recovery | reconstruction (Relief)
 - Wired local loop: Copper, optical fibre, etc. (customers' loop) | Wireless local loop (customers' loop) | Fixed wireless access (long distance) | Mobile wireless access | Satellite two-way communications: VSAT, etc. | Wireless LANS and IP-based related networks | Terrestrial voice, data, sound or television broadcasting | Satellite voice, data, sound or television broadcasting | Hybrid or combined technologies| Others
 - if others, please specify:
- Objective and/or achievements of the use case
- summary of the use case indicating its expected social /economic impacts

Part II. Details.

- Overview of use case targets, objectives and financing
 - Objectives and implementation details of the use case including problem statement (tsunami, earthquake, drought, etc.):

The objectives of this use case are to keep business continuity for public organizations and local government. In the event of disaster, public or semi-public organization such as telecom companies, electric power companies, hospitals, fire departments and local governments should continue their services as much as possible to save lives of victims.

If earthquake occurs, safety confirmation requests are automatically sent to staffs by collaboration with early warning systems. The system enables recognizing affected staffs and available staffs, and managers can take measures to keep business continuity. In addition, managers can order all available staffs to countermeasures and share information by broadcasting messages.
 - Brief description of the target country/region: geography, terrain, climate, demographics, socio-economic situation: Global companies, public sectors, government
 - If any, technological improvement and its effects for providing new capabilities, reduced cost capital and operating cost solutions.
- Infrastructure and regulatory environment
 - Infrastructure components: Necessary telecommunication facilities, transport access, electricity supply, distance to the nearest local exchange and/or IP network, human resources, security
 - Regulatory components: Necessary license, frequency availability (for radio-based projects), other regulatory issues
 - Other factors which influenced the operating environment (manufacturers, standards etc).
- Technical description of use case provided
 - Architecture, type of systems, main technical characteristics, frequencies (for radio-based projects), power consumption, performances (capacity, reliability, quality of service), network management, etc.,

- Cloud computing for receiving early-warning information from meteorological institute
- Cloud computing for storing safety confirmation message from users
- Mobile devices and PCs to be sent requests of safety confirmation message.
- Broadcast message function to order from manager for keeping their business
 - Installation and deployment: network planning, subscriber management, etc.
- IP connectivity such as NGNs, Internet and mobile internet access since all features are installed into clouds
 - Interconnection to national networks/backbones/disaster response systems
- Cost | financial aspects, if possible
 - Cost of the equipment, cost per line and cost of the operation of the system
 - ✧ Prices are shown in <http://www.ntt.com/anpi/data/price.html> (in Japanese)
 - Cost of each terminal and cost of the service for the user.
 - Financial aspects of the use case
- Effectiveness and sustainability of the project
 - Effectiveness and benefits of the project for the targeted user groups
 - Profitability of the project and/or its contribution to local entrepreneurial activities
 - Specific strategies to respond to the needs of women, youth, handicapped, indigenous people and other marginalized or socially disadvantaged groups
 - Aspects of the project, which could be strengthened to enhance its effectiveness or sustainability maximizing the benefits of telecommunication infrastructure in rural and remote areas.
- Other observations
 - Unexpected results and/or lessons learned
 - Derived requirements | requests for the emergency telecommunication community: Security, Privacy, High-reliability
 - Anticipated near/long-term future plan
- Other source of information
 - Web
 - Important publications
 - Others

5) drnrr-i-0075, i-0141: Experimental report of “Multi-network communications system” in anticipation of the disasters

Part I. Summary.

- Country: Japan
- Title of use case

Experimental report of “Multi-network communications system” in anticipation of the disasters

- Details of the person preparing the use case:
 - Name: Kazunori TAKEUCHI
 - Title: Executive Director
 - Organization: KDDI R&D Laboratories Inc.
 - Address: Ohara 2-1-15 Fujimino-shi, SAITAMA, 356-8502, JAPAN
 - E-Mail: ka-takeuchi@kddilabs.jp
 - Website: <http://www.kddilabs.jp/index.html>
- Date of the submission: 24th October 2013

- ITU-T SG(s) to which you think your use case could be relevant: TBD
- Status of use case:
 - ~~Operational~~ | ~~Completed~~ | Research and Development
 - If in operational, specify major deployment cases
- (Potential target) Location and population of the use case
 - Location (village, district, etc.) (or specify the target is city, rural, and/or country-side)
 - Population of the project area: Can operate effectively in area with small population, and also applicable to the area with larger population
- Relevant actors (played roles)
 - end-users, private sector organizations, public sector organizations, national/local government, others
 - If others, please specify:
- Type of disaster
 - ~~Cold wave~~ | ~~Drought~~ | Earthquake | ~~Epidemic~~ | ~~Extratropical Cyclone~~ | ~~Fire~~ | ~~Flash Flood~~ | ~~Flood~~ | ~~Heat Wave~~ | ~~Insect Infestation~~ | ~~Land Slide~~ | ~~Mad Slide~~ | ~~Severe Local Storm~~ | ~~Snow Avalanche~~ | ~~Storm Surge~~ | ~~Tech. Disaster~~ | ~~Tropical Cyclone~~ | Tsunami | ~~Volcano~~ | ~~Wild Fire~~ | Other
 - if others, please specify:
- Type of use case
 - ~~Mitigation and prevention~~ | preparedness | ~~prediction and early warning~~ | response | ~~impact assessment~~ | ~~recovery~~ | ~~reconstruction~~
 - Wired local loop: Copper, optical fibre, etc. (customers' loop) | Wireless local loop (customers' loop) | Fixed wireless access (long distance) | Mobile wireless access | Satellite two-way communications: VSAT, etc. | Wireless LANS and IP-based related networks | Terrestrial voice, data, sound or television broadcasting | Satellite voice, data, sound or television broadcasting | Hybrid or combined technologies | Others
 - if others, please specify:
- Objective and/or achievements of the use case:

Pull-up the possibilities to enable victims to communicate by their terminals through the Internet even in and after the disaster.

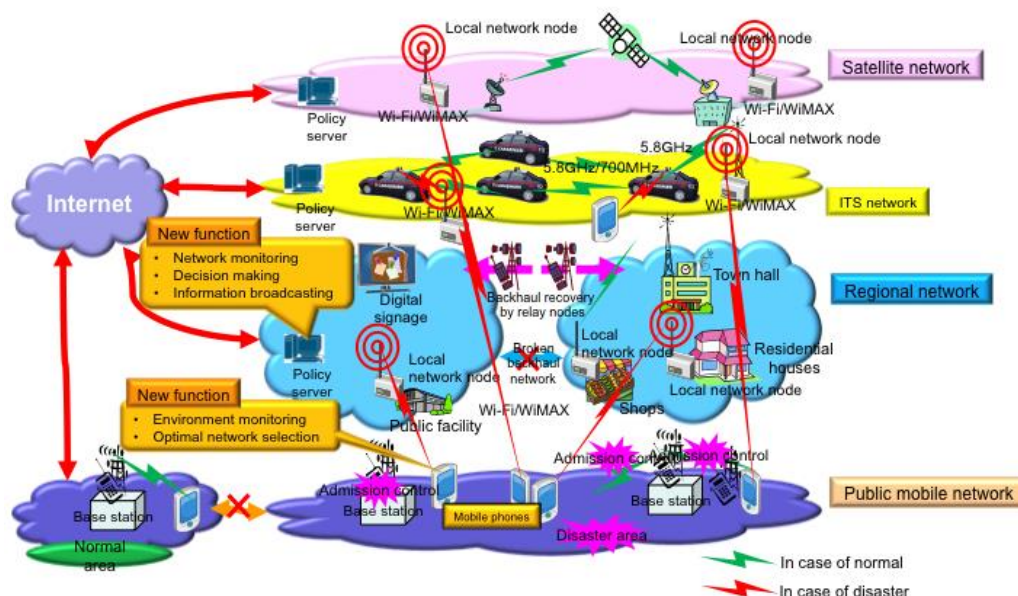

- summary of the use case indicating its expected social /economic impacts:

The multi-network communications systems are provided to avoid connection lost of the user terminals that are dedicated to connect specific national/regional network. It seems impossible or costs enormously to construct a robust network alive perfectly even after the great earthquake and/or tsunami. On the other hand, the probability of one or more wireless network(s) to be functional in some degree is enough high even after the disaster. To utilize the survived wireless network(s) functionality by victims' terminals is powerful method to connect to the Internet even the wireless system of the survived infrastructure and the terminals are different each other.

So the “relay nodes” which are enable to connect any type of wireless networks in the area are expected to support the victims' terminals to be connected by Wi-Fi to the Internet via survived wireless network in the disaster area.

Another problem to be resolved in the disaster area are congestion made by rush of many terminals to the one survived network. To relax the congestion, load balancing conducted from core network side is effective if more than two wireless networks survived after the disaster.

The relay node has the function to select the proper wireless network to obtain best throughput to the Internet by the help of core network side.

By equipped these function to the relay node and core network side, victims' terminals are not necessary to be adopted to many wireless systems among which some are expected working even after the disaster. So economical impact is big. Also we can pull up the possibility to keep all the Wi-Fi capability terminals (like smartphones, tablet, notebook pc) to be connected to the Internet via this relay node even after the disaster. So we regards social impact is also big.

Part II. Details.

- Overview of use case targets, objectives and financing
 - Objectives and implementation details of the use case including problem statement

(tsunami, earthquake, drought, etc.):

The multi-network communications systems are provided to avoid connection lost of the user terminals that are dedicated to connect specific national/regional network. In the disaster area, it seems impossible to keep a specific network to be alive because of the difficulty of prediction of earthquake and/or tsunami. Still the probability of one or more wireless network(s) to be functional in some degree is not entirely zero.

So the “relay nodes” which are enable to connect any type of wireless networks in the area are expected to support the victims’ terminals to be connected by Wi-Fi to the Internet via available wireless network in the disaster area.

Another problem to be resolved in the disaster area are congestion made by rush of many terminals to specific network. To relax this congestion, load balancing conducted from core network side is effective if more than two wireless networks kept remain to work. So the function to monitor the backhaul and core network condition is necessary.

Another necessary function to grasp the wireless network condition is to probe the wireless condition in each location.

The relay node has the function to select the proper wireless network to obtain best throughput to the Internet by the help of core network side.

By equipped these function to the relay node and core network side, victims’ terminals are not necessary to be adopted to many wireless systems among which some are expected to be working even after the disaster.

This scenario is effective only when more than one wireless network will be kept alive even after the disaster. So in some regional area, we should add wireless network(s) to pull up the possibility.

- Brief description of the target country/region: geography, terrain, climate, demographics, socio-economic situation:

The regions should be provided more than one national or regional wireless-network infrastructures.

- If any, technological improvement and its effects for providing new capabilities, reduced cost capital and operating cost solutions.

The technology of the “software defined radio” and the “re-configurable radio” are effective to reduce the cost and enhance the function of the relay node.

- Infrastructure and regulatory environment

- Infrastructure components: More than two wireless networks. Ad-hoc network can be counted as well as infrastructures one.
- Regulatory components: Security concern notifications is one key. It should be enabled to loose authentication of the victims’ terminals at the relay node only when the disaster period.
- Other factors which influenced the operating environment (manufacturers, standards etc).

The victims' terminals are expected to have Wi-Fi or other wireless LAN/PAN capability which is necessary to be provided in the relay node.

- Technical description of use case provided
 - Architecture, type of systems, main technical characteristics, frequencies (for radio-based projects), power consumption, performances (capacity, reliability, quality of service), network management, etc.,

This multi-network communications systems are consists of several functions in both network side and terminal side. In the networks side (Internet side):

 1. The function to pick-up the traffic condition of core, backhaul and base stations.
 2. The function to gather the network condition and notification function to the terminal side (i.e. the relay node)

In the terminal side:

 3. The function to probe the wireless conditions in each area.
 4. The function to relay victims' terminals to survived network selected by the support of network's side recommendation.
 - Installation and deployment: network planning, subscriber management, etc.

The relay nodes should be installed in public place like city halls and/or schools.
 - Interconnection to national networks/backbones/disaster response systems

The multi-network communications systems are directory connected to the Internet via survived wireless network(s).
- Cost | financial aspects, if possible
 - Cost of the equipment, cost per line and cost of the operation of the system

The relay node can be made of existing wireless modules and PCs. So the cost can be suppressed down to practical price. The cost in the network side depends on the scale and configuration of the each wireless networks.
 - Cost of each terminal and cost of the service for the user.

None. The relay terminal will provide wireless system that is already equipped in the victims' terminals. Recently Wi-Fi is the best candidate.
 - Financial aspects of the use case.

We regard it is chaper and practical to bundle multipule wireless networks into one by this technology than to establish real robust and resilient new wireless network.

So this use case has advantage in the financial aspects.
- Effectiveness and sustainability of the project
 - Effectiveness and benefits of the project for the targeted user groups

Adopting this configuration, the possibilities of providing wireless network connectivity for the victims are strongly pulled up.
 - Profitability of the project and/or its contribution to local entrepreneurial activities.

For local entrepreneurial activities, this wireless network relief system is effective to relax the risk to be cut off from the Internet after the disaster. So it contributes their BCP (Business Contingency Plan).

- Specific strategies to respond to the needs of women, youth, handicapped, indigenous people and other marginalized or socially disadvantaged groups.

The victims terminal are assumed as smart phone and/or tablets and/or PCs. Moreover, other device which has the functionality to connect the Wi-Fi is also works as usual. So no special skill is necessary and daily tools works as well. This scheme will greatly helpful to the persons and groups in this discussion.

- Aspects of the project, which could be strengthened to enhance its effectiveness or sustainability maximizing the benefits of telecommunication infrastructure in rural and remote areas.

This multi-networks architecture makes special dedicated wireless systems (not public) i.e. governmental communication systems and/or enterprise link to be available to the emergency circuits of the victims in disaster period. So the total performance of these dedicated systems will be enhanced in social aspects.

- Other observations

- Unexpected results and/or lessons learned

Detailed information to be provided

- Derived requirements | requests for the emergency telecommunication community

Detailed information to be provided

- Anticipated near/long-term future plan

Detailed information to be provided

- Other source of information

- Web

Detailed information to be provided

- Important publications

Detailed information to be provided

- Others

6) drnr-i-0142: Introduction UAS

Part I. Summary.

- Country: Japan
- Title of use case.

Introduction of message transmission system with robustness against long time delay and/or disconnection in network ; proposal of Unmanned Aircraft Systems (UAS) for disaster relief and safety

- Details of the person preparing the use case:
 - Name: Kazunori TAKEUCHI
 - Title: Executive Director
 - Organization: KDDI R&D Laboratories Inc.
 - Address: Ohara 2-1-15 Fujimino-shi, SAITAMA, 356-8502, JAPAN
 - E-Mail: ka-takeuchi@kddilabs.jp
 - Website: <http://www.kddilabs.jp/index.html>
- Date of the submission: 24th October 2013
- ITU-T SG(s) to which you think your use case could be relevant: TBD
- Status of use case:
 - ~~Operational~~ | ~~Completed~~ | **Research and Development**
 - If in operational, specify major deployment cases
- (Potential target) Location and population of the use case
 - Location (village, district, etc.) (or specify the target is city, rural, and/or countryside)
 - Population of the project area: Can operate effectively in the area with small population
- Relevant actors (played roles)
 - end-users, private sector organizations, public sector organizations, national/ local government, others
 - If others, please specify:
- Type of disaster
 - ~~Cold wave~~ | ~~Drought~~ | **Earthquake** | ~~Epidemie~~ | ~~Extratropical Cyclone~~ | ~~Fire~~ | ~~Flash Flood~~ | **Flood** | ~~Heat Wave~~ | ~~Insect Infestation~~ | **Land Slide** | **Mad Slide** | **Severe Local Storm** | ~~Snow Avalanche~~ | ~~Storm Surge~~ | ~~Tech. Disaster~~ | **Tropical Cyclone** | **Tsunami** | ~~Volcano~~ | ~~Wild Fire~~ | Other
 - if others, please specify:
- Type of use case
 - ~~Mitigation and prevention~~ | ~~preparedness~~ | ~~prediction and early warning~~ | **response** | ~~impact assessment~~ | ~~recovery~~ | ~~reconstruction~~
 - Wired local loop: Copper, optical fibre, etc. (customers' loop) | Wireless local loop (customers' loop) | Fixed wireless access (long distance) | Mobile wireless access | Satellite two-way communications: VSAT, etc. | Wireless LANS and IP-based related networks | Terrestrial voice, data, sound or television broadcasting | Satellite voice, data, sound or television broadcasting | Hybrid or combined technologies | **Others**
 - if others, please specify: Message relay by the physical object, UAS, vehicle and the other.
- Objective and/or achievements of the use case:

Enables to transfer electric messages like E-mail, short mail and files etc. in between the surviving area and the isolated area caused by the disaster.

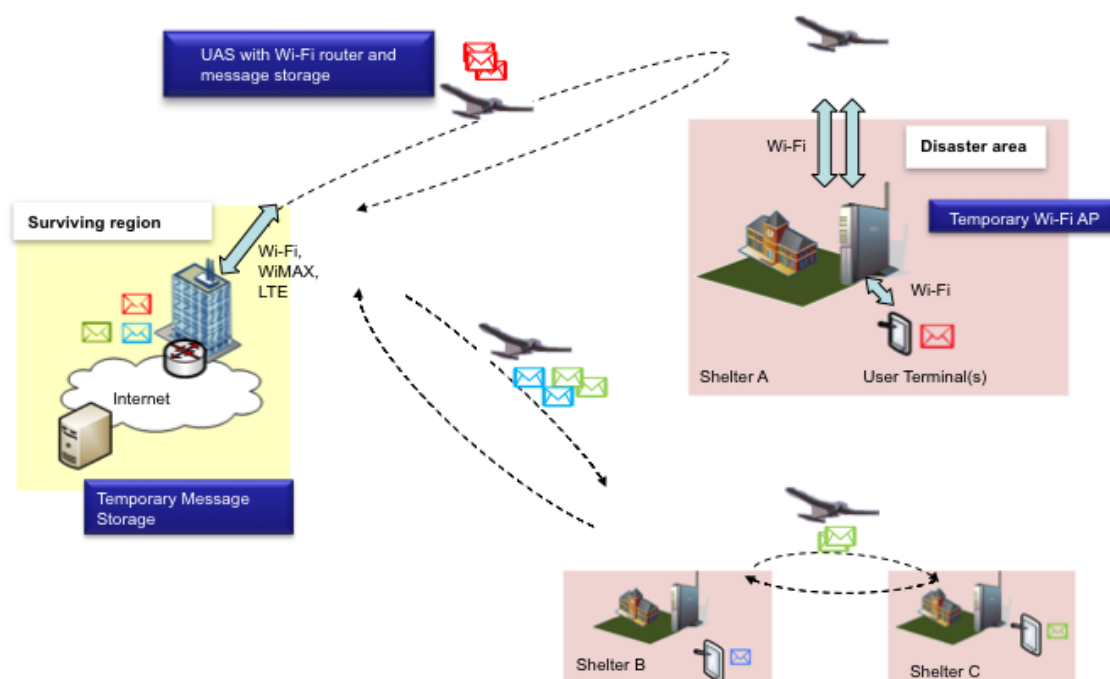

- summary of the use case indicating its expected social /economic impacts:

The message transmission system utilizing the Unmanned Aircraft Systems (UAS) is provided to transmit and receive electric messages between surviving area and isolated areas. Due to typhoon or earthquake and/or tsunami, the small villages in the mountain region, by the river or nearby shore are exposed to be isolated from other area. The isolation is not only limited the cut-off of communication link. The road, railway and bridges also exposed to be cut-off. In this worst case, it seems impossible to recover the communication link in the early days. In such situation, UAS is great candidate to relief this critical condition. By utilizing proper number of unmanned aircrafts, they can configure ad-hoc wireless network in the sky and finally make IP packet link between the surviving area and the isolated.

However, in the initial state of the relief and the recovery, not so many aircrafts are expected to be available in the border. To utilize this small number of UAS effectively to relief the cut-off network, this message transmission system gives UAS the function to exchange the electrical messages in between the isolated area and the surviving area.

The UAS are/is equipped very light weighted and battery driven Wi-Fi router and message storage device.

At the shelter in villages, there should be provided Wi-Fi APs with message storage against the disaster. In the surviving side, dedicated mail server(s) is/are works to gather the messages from the Internet and distribute the messages from the isolated area to the Internet.

Except the UAS itself and the devices on the UAS, Wi-Fi APs combined with message storage in the villages and the mail server in the Internet side can be configured with the consumer devices. So only if the UAS is obtained by fair price, this system is economically effective to relief the communication cut-off risk in the villages.

Moreover, this system can rapidly works even just after the earthquake or the land slide, very important information can be exchanged and might contribute the rescue operation.

On the user side, despite the robustness of this message transmission system, the operation is the same as the MUA (Mail User Agent) in daily use. No special technique is necessary for the user side, so widely useful for the officers and the residents in the isolated area where no wireless communication engineer(s) is/are expected to be stand-by.

Part II. Details.

- Overview of use case targets, objectives and financing
 - Objectives and implementation details of the use case including problem statement (tsunami, earthquake, drought, etc.):

The message transmission systems are intend to bring rapid relief to the isolated vil-lages, colonies and the shelters.

The detailed implementation with sequence is described the figure below.

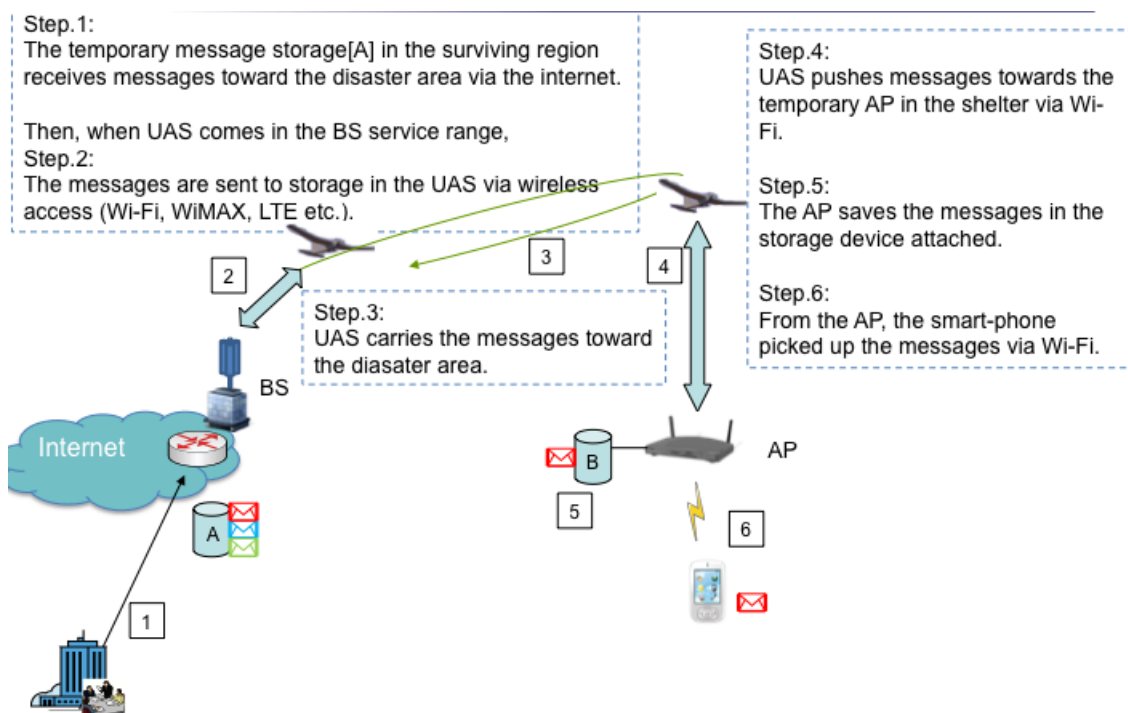

- Brief description of the target country/region: geography, terrain, climate, demographics, socio-economic situation:

The target villages are considered easy to be isolated by earthquake, typhoon and heavy rail. In many case, these villages are located by the river, in the valley area and shore side.

- If any, technological improvement and its effects for providing new capabilities, reduced cost capital and operating cost solutions.

The price of UAS itself and operations cost of it is still expensive today. If the UAS becomes common devices and these prices go down, this system will widely accepted because of its economically effectiveness.

- Infrastructure and regulatory environment
 - Infrastructure components: No special infrastructure is necessary.

- Regulatory components: Security concern notifications is one key. It should be enabled to loose authentication of the victims' terminals at the Wi-Fi APs with the storage only when the disaster period.
- Other factors which influenced the operating environment (manufacturers, standards etc.).

The victims' terminals are expected to have Wi-Fi or other wireless LAN/PAN capability which is necessary to provided in the Wi-Fi APs and the storage.

- Technical description of use case provided

- Architecture, type of systems, main technical characteristics, frequencies (for radio-based projects), power consumption, performances (capacity, reliability, quality of service), network management, etc.,

This message transmission systems are consists of several functions in both UAS, isolated area and Internet side. In the networks side (Internet side):

1. The function to connect the servers in the Internet to the Wi-Fi router with the storage in UAS by wireless. This can be supported by the cellular phone network and/or Broadband Wireless Access.

2. The function to gather the messages from the Internet and distribute the messages from the isolated area to the Internet. As this function needs no special hardware, it can be equipped in the cloud system.

In the UAS:

3. Very light weighted and battery driven Wi-Fi router and message storage device. The device should be energy efficient to extend battery life of UAS.

In the village:

4. The function to gather and store victims' messages via Wi-Fi and push them to the UAS. Also receive the messages from UAS and distribute them to the proper user terminals.

- Installation and deployment: network planning, subscriber management, etc.

The Wi-Fi APs with storage should be installed in public place like city halls and/or schools.

- Interconnection to national networks/backbones/disaster response systems

The mail server in the Internet side works to exchange the messages via Internet.

- Cost | financial aspects, if possible

- Cost of the equipment, cost per line and cost of the operation of the system

Cost of UAS is still unclear because these are not well sold in consumer market.

- Cost of each terminal and cost of the service for the user.

None. The Wi-Fi APs in the shelter will provide wireless system that is already equipped in the victims' terminals. Recently Wi-Fi is the best candidate.

- Financial aspects of the use case.
 - Until the price of UAS kept expensive, this use case will be regarded rather expensive than the existing other method. Still the mobility and the rapid relief bought by this use case might be results cheaper than the others in some cases.
- Effectiveness and sustainability of the project
 - Effectiveness and benefits of the project for the targeted user groups
 - Adopting this configuration, the possibilities of providing message transmission function will be provided very sooner than the existing approach.
 - Profitability of the project and/or its contribution to local entrepreneurial activities.
 - For local entrepreneurial activities, this message transmission system is effective to relax the risk to be isolated after the disaster. So it contributes their BCP (Business Contingency Plan) somehow.
 - Specific strategies to respond to the needs of women, youth, handicapped, indigenous people and other marginalized or socially disadvantaged groups.
 - The victims terminal are assumed as smart phone and/or tablets and/or PCs. Moreover, other device which has the functionality to connect the Wi-Fi is also works as usual. So no special skill is necessary and daily MUA tools works as well. This scheme will greatly helpful to the persons and groups in this discussion.
 - Aspects of the project, which could be strengthened to enhance its effectiveness or sustainability maximizing the benefits of telecommunication infrastructure in rural and remote areas.
 - The quickness of this message transportation will be helpful to bring the necessary information to recover the communication networks in early stage after the disaster.
- Other observations
 - Unexpected results and/or lessons learned
 - Detailed information to be provided
 - Derived requirements | requests for the emergency telecommunication community
 - Detailed information to be provided
 - Anticipated near/long-term future plan
 - Detailed information to be provided
- Other source of information
 - Web
 - Detailed information to be provided
 - Important publications
 - Detailed information to be provided
 - Others

7) drnr-i-167, 168: Open-air public address systems

Part I. Summary.

- Country: Japan
- Title of use case: Sophistication of open-air public address (PA) systems to convey emergency disaster information
- Details of the person preparing the use case:
 - Name: Shuichi Sakamoto
 - Title: Associate Professor
 - Organization: Research Institute of Electrical Communication, Tohoku University
 - Address: 2-1-1 Katahira, Aoba-ku, Sendai, Miyagi
 - E-Mail: saka@ais.riec.tohoku.ac.jp
 - Website: N.A.
- Date of the submission: 24 February, 2014 at ITU-T Focus Group on DR & NRR
- ITU-T SG(s) to which you think your use case could be relevant:
- Status of use case: Research and Development
 - Operational | Completed | Research and Development
 - If in operational, specify major deployment cases
- (Potential target) Location and population of the use case
 - Location (village, district, etc.) (or specify the target is city, rural, and/or country-side): Everywhere, especially the area affected by the earthquake and tsunami
 - Population of the project area
- Relevant actors (played roles): National/local government
 - end-users, private sector organizations, public sector organizations, national/local government, others
 - If others, please specify:
- Type of disaster: Earthquake and Tsunami

[EdNote: consider to edit this list. The list is easy to understand, but contains incidents that do not affect very much to telecom networks. Contributions invited.]

 - Cold wave | Drought | Earthquake | Epidemic | Extratropical Cyclone | Fire | Flash Flood | Flood | Heat Wave | Insect Infestation | Land Slide | Mad Slide | Severe Local Storm | Snow Avalanche | Storm Surge | Tech. Disaster | Tropical Cyclone | Tsunami | Volcano | Wild Fire | Other
 - if others, please specify:
- Type of use case: prediction and early warning | response, others (open-air public address systems)
 - Mitigation and prevention | preparedness | prediction and early warning | response | impact assessment | recovery | reconstruction
 - Wired local loop: Copper, optical fibre, etc. (customers' loop) | Wireless local loop (customers' loop) | Fixed wireless access (long distance) | Mobile wireless access | Satellite two-way communications: VSAT, etc. | Wireless LANS and IP-based related networks | Terrestrial voice, data, sound or television broadcasting | Satellite voice, data, sound or television broadcasting | Hybrid or combined technologies | Others
 - if others, please specify:
- Objective and/or achievements of the use case
 - Objective: Improvement of open-air sound transmission systems to address disaster information
- summary of the use case indicating its expected social /economic impacts
 - It becomes possible to evaluate and predict the intelligibility of speech sound.

- It becomes possible to robustly convey disaster information by using high-familiarity words even if the speech sound is presented at long-path echo condition.
- It becomes possible to highly robustly transmit disaster information by using sign signal even when the speech sound cannot properly transmit the information under long-path echo condition.

Part II. Details.

- Overview of use case targets, objectives and financing
 - Objectives and implementation details of the use case including problem statement (tsunami, earthquake, drought, etc.):
 - In Japan, municipal radio systems to convey disaster information are effectively used, especially in rural and coast areas. When the severe disaster is happened, emergency information is transmitted via the radio systems and various information such as siren, evacuation message is outputted via an open-air public address (PA) system. Such PA system is important peripheral subsystem, because people who are living in the service area can easily receive the information without any special devices. However, because of the long-path echoes from mountains, buildings and so on, intelligibility of the messages becomes extremely low. This research tackles this program from the point of acoustics. To develop such system, several factors as followings must be considered: (1) Characteristics of sound systems including signal processing used, (2) characteristics of speech information in Japanese, (3) listeners' perceptual characteristics in understanding speech information. However, these factors had not been considered at all in the design and install processes of such open-air PA systems except for the output sound pressure levels. Partly because of this, at the time of the Great East-Japan Earthquake, the speech signal outputted from the systems was often found unintelligible. This research aims at substantially improving the performance of the open-air PA system.
 - Brief description of the target country/region: geography, terrain, climate, demographics, socio-economic situation: Every country/region, especially the area affected by the earthquake and tsunami
 - If any, technological improvement and its effects for providing new capabilities, reduced cost capital and operating cost solutions.

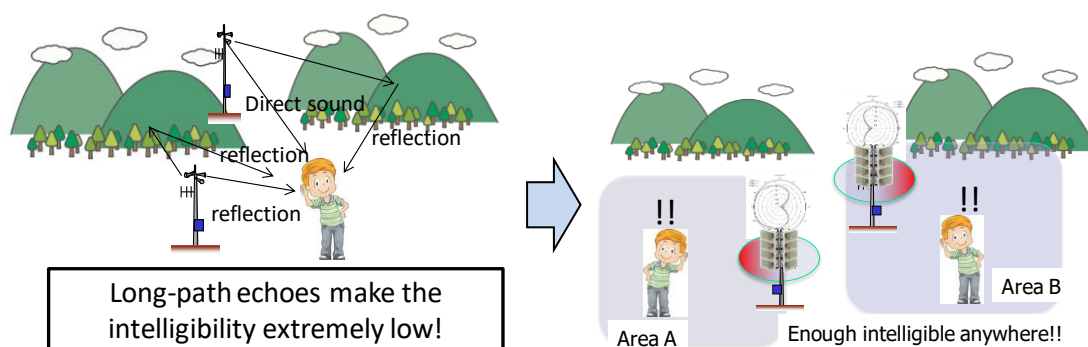

Objective of this research project

- Infrastructure and regulatory environment
 - Infrastructure components: Necessary telecommunication facilities, transport access,

- electricity supply, distance to the nearest local exchange and/or IP network, human resources, security: Public address system (speaker, amplifier, and receiver which is used to receive information from operation center)
- Regulatory components: Necessary license, frequency availability (for radio-based projects), other regulatory issues
 - Other factors which influenced the operating environment (manufacturers, standards etc).
- Technical description of use case provided
 - Architecture, type of systems, main technical characteristics, frequencies (for radio-based projects), power consumption, performances (capacity, reliability, quality of service), network management, etc.,
 - Installation and deployment: network planning, subscriber management, etc.: Planning to construct open-air PA system (which point are speaker towers constructed?), Specification of messages which are transmitted via open-air PA system
 - Interconnection to national networks/backbones/disaster response systems: N.A.
 - Cost | financial aspects, if possible:
 - Cost of the equipment, cost per line and cost of the operation of the system
 - Cost of each terminal and cost of the service for the user.
 - Financial aspects of the use case
 - Effectiveness and sustainability of the project
 - Effectiveness and benefits of the project for the targeted user groups
 - ✧ It becomes possible to evaluate and predict the intelligibility of speech sound.
 - ✧ It becomes possible to robustly convey disaster information by using high-familiarity words even if the speech sound is presented at long-path echo condition.
 - ✧ It becomes possible to highly robustly transmit disaster information by using sign signal even when the speech sound cannot properly transmit the information under long-path echo condition.
 - Profitability of the project and/or its contribution to local entrepreneurial activities
 - Specific strategies to respond to the needs of women, youth, handicapped, indigenous people and other marginalized or socially disadvantaged groups
 - Aspects of the project, which could be strengthened to enhance its effectiveness or sustainability maximizing the benefits of telecommunication infrastructure in rural and remote areas.
 - ✧ By using the knowledge of this project, emergency information can be transmitted correctly to the people who are living in the service area of developed open-air PA systems.
 - Other observations
 - Unexpected results and/or lessons learned
 - Derived requirements | requests for the emergency telecommunication community
 - Anticipated near/long-term future plan
 - Other source of information: Research report “(10). Research and development of multi-tier disaster information transmission systems linking various means of communication and broadcasting, published by Ministry of Internal Affairs and Communications (MIC), Japan
 - Web
 - Important publications
 - Others

8) drnrr-i-172: portable burst-mode EDFA

Part I. Summary.

- Country: Japan
- Title of use case: portable burst-mode EDFA
- Details of the person preparing the use case:
 - Name: Yoshinari Awaji
 - Title: Director, Robust Network Platform Laboratory, Resilient ICT Research Center
 - Organization: National Institute of Information and Communications Technology (NICT)
 - Address: 4-2-1 Nukui-Kitamachi, Koganei, Tokyo 184-8795, Japan
 - E-Mail: yossy[at]nict.go.jp
 - Website: <http://www.nict.go.jp/en/>
- Date of the submission: 24 Feb 2014
- ITU-T SG(s) to which you think your use case could be relevant:
 - SG 15
- Status of use case:
 - ~~Operational~~ | ~~Completed~~ | Research and Development
 - If in operational, specify major deployment cases
- (Potential target) Location and population of the use case
 - Location (village, district, etc.) (or specify the target is city, rural, and/or countryside)
 - Population of the project area
- Relevant actors (played roles)
 - end-users, private sector organizations, public sector organizations, national/local government, others
 - If others, please specify:
- Type of disaster
 - ~~Cold wave~~ | ~~Drought~~ | Earthquake | ~~Epidemic~~ | ~~Extratropical Cyclone~~ | ~~Fire~~ | ~~Flash Flood~~ | ~~Flood~~ | ~~Heat Wave~~ | ~~Insect Infestation~~ | ~~Land Slide~~ | ~~Mad Slide~~ | ~~Severe Local Storm~~ | ~~Snow Avalanche~~ | ~~Storm Surge~~ | ~~Tech. Disaster~~ | ~~Tropical Cyclone~~ | Tsunami | ~~Volcano~~ | ~~Wild Fire~~ | Other
 - if others, please specify:
- Type of use case
 - ~~Mitigation and prevention~~ | ~~preparedness~~ | ~~prediction and early warning~~ | ~~response~~ | ~~impact assessment~~ | recovery | ~~reconstruction~~
 - Wired local loop: Copper, optical fibre, etc. (customers' loop) | Wireless local loop (customers' loop) | Fixed wireless access (long distance) | Mobile wireless access | Satellite two-way communications: VSAT, etc. | Wireless LANS and IP-based related networks | Terrestrial voice, data, sound or television broadcasting | Satellite voice, data, sound or television broadcasting | Hybrid or combined technologies | Others
 - if others, please specify:
- Objective and/or achievements of the use case
 - Swift re-connection of surviving fiber links to optical fiber networks or provide a means of by-passing damaged network infrastructure
- summary of the use case indicating its expected social /economic impacts

Part II. Details.

- Overview of use case targets, objectives and financing
 - Objectives and implementation details of the use case including problem statement (tsunami, earthquake, drought, etc.):

A maintenance person carries the portable burst-mode optical amplifier to the destroyed exchange office, break point, or bypass point by foot or bicycle. With this amplifier connecting a pair of the survived underground optical fiber, a part of the physics network is temporarily restored to connect the survived exchange.

- Brief description of the target country/region: geography, terrain, climate, demographics, socio-economic situation:
- If any, technological improvement and its effects for providing new capabilities, reduced cost capital and operating cost solutions.

By normal EDFA the wave pattern of the amplification signal is distorted for the bursting light signal input without constant light signal strength. Burst mode type EDFA can amplify keeping a wave pattern for any kind of input light signal, and is suitable for the emergency restoration in the disaster area with unstable communication traffic.

- Infrastructure and regulatory environment
 - Infrastructure components: Necessary telecommunication facilities, transport access, electricity supply, distance to the nearest local exchange and/or IP network, human resources, security
Detailed information to be provided.
 - Regulatory components: Necessary license, frequency availability (for radio-based projects), other regulatory issues
Detailed information to be provided.
 - Other factors which influenced the operating environment (manufacturers, standards etc).
- Technical description of use case provided
 - Architecture, type of systems, main technical characteristics, frequencies (for radio-based projects), power consumption, performances (capacity, reliability, quality of service), network management, etc.,
Detailed information to be provided.
 - Installation and deployment: network planning, subscriber management, etc.
Detailed information to be provided.
 - Interconnection to national networks/backbones/disaster response systems
Detailed information to be provided.
- Cost | financial aspects, if possible
 - Cost of the equipment, cost per line and cost of the operation of the system
Detailed information to be provided.
 - Cost of each terminal and cost of the service for the user.

- Financial aspects of the use case
- Effectiveness and sustainability of the project
 - Effectiveness and benefits of the project for the targeted user groups
 - Profitability of the project and/or its contribution to local entrepreneurial activities
 - Specific strategies to respond to the needs of women, youth, handicapped, indigenous people and other marginalized or socially disadvantaged groups
 - Aspects of the project, which could be strengthened to enhance its effectiveness or sustainability maximizing the benefits of telecommunication infrastructure in rural and remote areas.
- Other observations
 - Unexpected results and/or lessons learned
To be provided.
 - Derived requirements | requests for the emergency telecommunication community
To be provided.
 - Anticipated near/long-term future plan
To be provided.
- Other source of information
 - Web
To be provided.
 - Important publications
To be provided.
 - Others

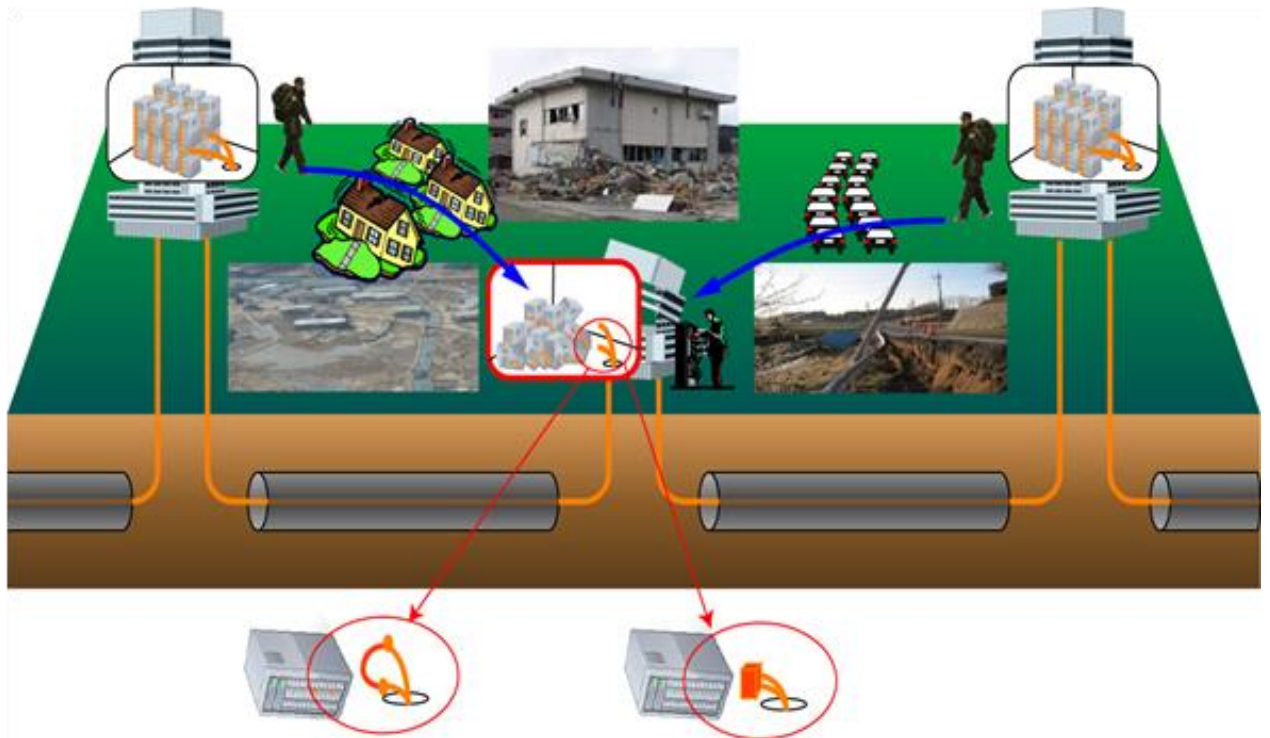

Figure 1 Usecase

9) dnrri-i-184r1: Safety confirmation system with self-safety information registration

Part I. Summary.

- Country: Japan
- Title of use case: Safety confirmation system to capture self-safety information in conjunction with user's queries
- Details of the person preparing the use case:
 - Name: Ryosuke AOKI
 - Title: Researcher
 - Organization: NTT
 - Address: 1-1 Hikari-no-oka Yokosuka-Shi Kanagawa 239-0847 Japan
 - E-Mail: aoki.ryosuke@lab.ntt.co.jp
 - Website:
- Date of the submission: FG on Disaster Relief Systems, Network Resilience and Recovery, Biel, Switzerland 3-5 March 2014
- ITU-T SG(s) to which you think your use case could be relevant: SG-2
- Status of use case:
 - Operational | Completed | Research and Development
 - If in operational, specify major deployment cases:
- (Potential target) Location and population of the use case

- Location (village, district, etc.) (or specify the target is city, rural, and/or countryside): Global
- Population of the project area
- Relevant actors (played roles)
 - end-users, private sector organizations, public sector organizations, national/local government, others
 - If others, please specify:
- Type of disaster: all types
 - Cold wave | Drought | Earthquake | Epidemic | Extratropical Cyclone | Fire | Flash Flood | Flood | Heat Wave | Insect Infestation | Land Slide | Mad Slide | Severe Local Storm | Snow Avalanche | Storm Surge | Tech. Disaster | Tropical Cyclone | Tsunami | Volcano | Wild Fire | Other
 - if others, please specify:
- Type of use case
 - Mitigation and prevention | preparedness | prediction and early warning | response | impact assessment | recovery | reconstruction (Relief)
 - Wired local loop: Copper, optical fibre, etc. (customers' loop) | Wireless local loop (customers' loop) | Fixed wireless access (long distance) | Mobile wireless access | Satellite two-way communications: VSAT, etc. | Wireless LANS and IP-based related networks | Terrestrial voice, data, sound or television broadcasting | Satellite voice, data, sound or television broadcasting | Hybrid or combined technologies| Others
 - if others, please specify:
- Objective and/or achievements of the use case
 - Make it possible to exchange safety information and messages between users with high accuracy and least effort
- Summary of the use case indicating its expected social /economic impacts

Part II. Details.

- Overview of use case targets, objectives and financing
 - Objectives and implementation details of the use case including problem statement (tsunami, earthquake, drought, etc.):

In the event of disaster, people want to confirm the safety of their family, relatives and friends. Safety confirmation systems, which enable users to send their information such as personal condition and the situation around them, are available in Japan. It is reported, however, that the existing systems were not fully used when the East Japan Earthquake occurred. This is due to user's failure to register self-safety information and the burden of operating the systems. The proposed safety confirmation system generates user's self-safety information automatically when the user sends queries asking for other people's safety and registers it to the system without bothering the user. This approach solves the two key problems above.
 - Brief description of the target country/region: geography, terrain, climate, demographics, socio-economic situation: end-users
 - If any, technological improvement and its effects for providing new capabilities, reduced cost capital and operating cost solutions.
- Infrastructure and regulatory environment
 - Infrastructure components: Necessary telecommunication facilities, transport access, electricity supply, distance to the nearest local exchange and/or IP network, human

- resources, security
- Regulatory components: Necessary license, frequency availability (for radio-based projects), other regulatory issues
- Other factors which influenced the operating environment (manufacturers, standards etc).
- Technical description of use case provided
 - Architecture, type of systems, main technical characteristics, frequencies (for radio-based projects), power consumption, performances (capacity, reliability, quality of service), network management, etc.,
 - Self-safety information should be captured by a safety confirmation system even if users forget to register their own personal condition
 - Announcements, which inform the user that other people are looking for the user, should be passed to the user from the safety confirmation system
 - Installation and deployment: network planning, subscriber management, etc.
 - IP connectivity such as NGNs, Internet and mobile internet access since all features are installed
 - Interconnection to national networks/backbones/disaster response systems
- Cost | financial aspects, if possible
 - Cost of the equipment, cost per line and cost of the operation of the system
 - Cost of each terminal and cost of the service for the user.
 - Financial aspects of the use case
- Effectiveness and sustainability of the project
 - Effectiveness and benefits of the project for the targeted user groups
 - Profitability of the project and/or its contribution to local entrepreneurial activities
 - Specific strategies to respond to the needs of women, youth, handicapped, indigenous people and other marginalized or socially disadvantaged groups
 - Aspects of the project, which could be strengthened to enhance its effectiveness or sustainability maximizing the benefits of telecommunication infrastructure in rural and remote areas.
- Other observations
 - Unexpected results and/or lessons learned
 - Derived requirements | requests for the emergency telecommunication community:
 - Anticipated near/long-term future plan
- Other source of information
 - Web
 - Important publications
 - Others

10) Special session in the 9th FG-DR&NRR meeting, Session 1-1. Telecommunication Technologies for Disaster Relief Systems

Part I. Summary.

- Country: Fiji
- Title of use case: Telecommunication Technologies for Disaster Relief Systems
- Details of the person preparing the use case:
 - Name: Josaia Baro
 - Title: Manager Planning and Transformation

- Organization: Telecom Fiji Limited
- Address: Level 4, Ganilau House, Suva, Fiji
- E-Mail: josaia.baro@tfl.com.fj
- Website: N.A.
- Date of the submission: 12 May 2014
- ITU-T SG(s) to which you think your use case could be relevant: TBD (To Be Determined)
- Status of use case:
 - Operational
 - If in operational, specify major deployment cases: Could be used in both cases, ie in times and Natural Disasters or Civil Unrest.
 For Natural Disasters, the Fiji public receives warning from the MET Office and Local Radio Broadcast Stations while Civil Unrest is normally due to political issues. Telecom Fiji transmission network resilience between the 2 major City (Suva and Lautoka) and between the 2 major Islands (Viti Levu and Vanua Levu) – refer to Appendix 2.
 Telecom Fiji has Genset back-up in all major Exchange, Satellite Hub and Radio Stations Sites. The challenge for TFL is getting diesel to remotes in case of commercial power outage for over a week due to access route availability.
 TFL also have communication fall back to the CDMA Network
 On worst case scenario, TFL will fall back to TFL Satellite Network communication- Refer Appendix 3.
 The Broadcasting Stations (AM Stations) are used by Govt to broadcast important message before and during disaster and also during recovery period.
- (Potential target) Location and population of the use case
 - Location (small islands, village, district, city, and countryside): Small island countries potentially affected by tsunami, cyclone and tidal waves
 - Population of the project area: N.A.
- Relevant actors (played roles)
 - public sector organizations, national/local government, others
 - If others, please specify: :service provider (Telecom Fiji)
- Type of disaster

[EdNote: consider to edit this list. The list is easy to understand, but contains incidents that do not affect very much to telecom networks. Contributions invited.]

 - Flood | Tropical Cyclone | Tsunami | Other:
 - if others, please specify: Tidal waves
- Type of use case
 - Mitigation and prevention | preparedness | prediction and early warning | response | impact assessment | recovery | reconstruction
 - Wired local loop: Copper, optical fibre, etc. (customers' loop) | Fixed wireless access (long distance) | Mobile wireless access | Satellite two-way communications: VSAT | Wireless LANS and IP-based related networks | Terrestrial voice, data, sound or television broadcasting | Satellite voice, data, sound or television broadcasting
 - if others, please specify: Email, Fax, HSI, Cloud Services
- Objective and/or achievements of the use case:

To prevent and to recovery in times of natural disasters
- summary of the use case indicating its expected social /economic impacts:

TFL is one of three utilities listed as an essential service in times of natural disaster. TFL activates it EMSEC (Emergency Service Control Centre) in times of Natural Disasters or

Civil Unrest. TFL EMSEC activates in line with Govt`s DISMAC Activation. 3 Regional (CE,North,West) EMSEC centres with CE EMSEC serving as TFL National EMSEC.

The TFL National EMSEC updates DISMAC on TFL Network Status and Network Recovery Progress – Refer Appendix 1 for Organisational Structure

Part II. Details.

- Overview of use case targets, objectives and financing
 - Objectives and implementation details of the use case including problem statement (tsunami, earthquake, drought, etc.): To prevent and to recovery in times of natural disasters (in Tsunami, cyclone, flood and tidal waves)
 - Brief description of the target country/region: geography, terrain, climate, demographics, socio-economic situation: Small island countries
 - If any, technological improvement and its effects for providing new capabilities, reduced cost capital and operating cost solutions.: N.A.
- Infrastructure and regulatory environment
 - Infrastructure components: Necessary telecommunication facilities, transport access, electricity supply, IP network, human resources, security
 - Regulatory components: Necessary license, frequency availability (for radio-based projects), other regulatory issues: N.A.
 - Other factors which influenced the operating environment (manufacturers, standards etc). : N.A.
- Technical description of use case provided
 - performances (capacity, reliability, quality of service), network management
 - Installation and deployment: network planning, subscriber management
 - Interconnection to national networks/backbones/disaster response systems
- Cost | financial aspects, if possible
 - Cost of the operation of the system
 - Cost of each terminal and cost of the service for the user. : N.A.
 - Financial aspects of the use case: N.A.
- Effectiveness and sustainability of the project
 - Effectiveness and benefits of the project for the targeted user groups :
Public sector organizations, national/local government and service provider (telecom operator)
 - Profitability of the project and/or its contribution to local entrepreneurial activities: N.A.
 - Specific strategies to respond to the needs of women, youth, handicapped, indigenous people and other marginalized or socially disadvantaged groups : N.A.
 - Aspects of the project, which could be strengthened to enhance its effectiveness or sustainability maximizing the benefits of telecommunication infrastructure in rural and remote areas. : N.A.
- Other observations
 - Unexpected results and/or lessons learned : N.A.
 - Derived requirements | requests for the emergency telecommunication community: N.A.
 - Anticipated near/long-term future plan : None.
- Other source of information
 - Web: N.A
 - Important publications: None.

➤ Others: None.

Disaster Management Organisation Structure - *Appendix 1*

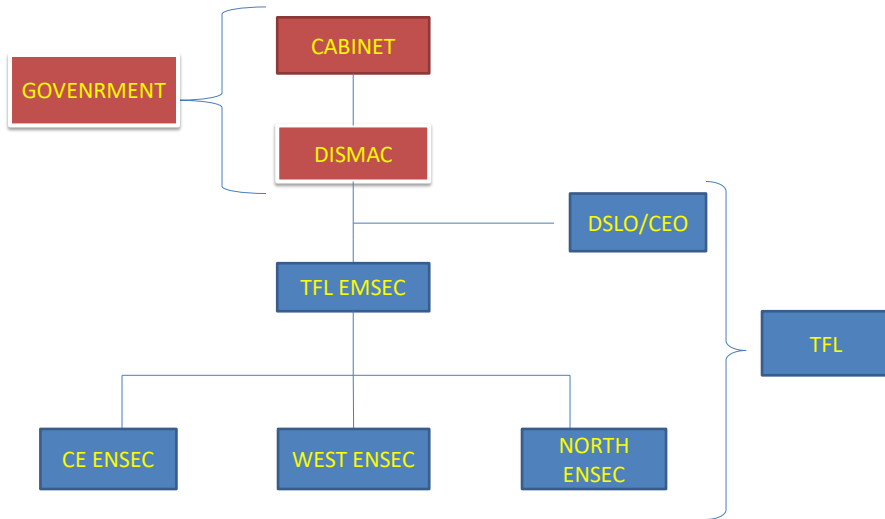

Appendix 2

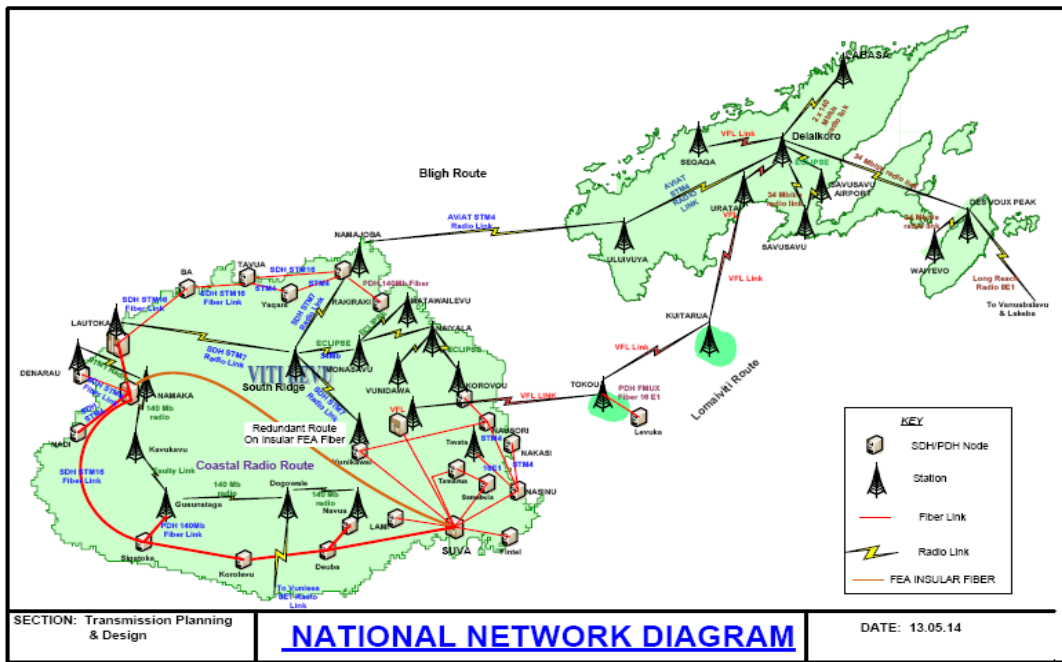

Appendix 3

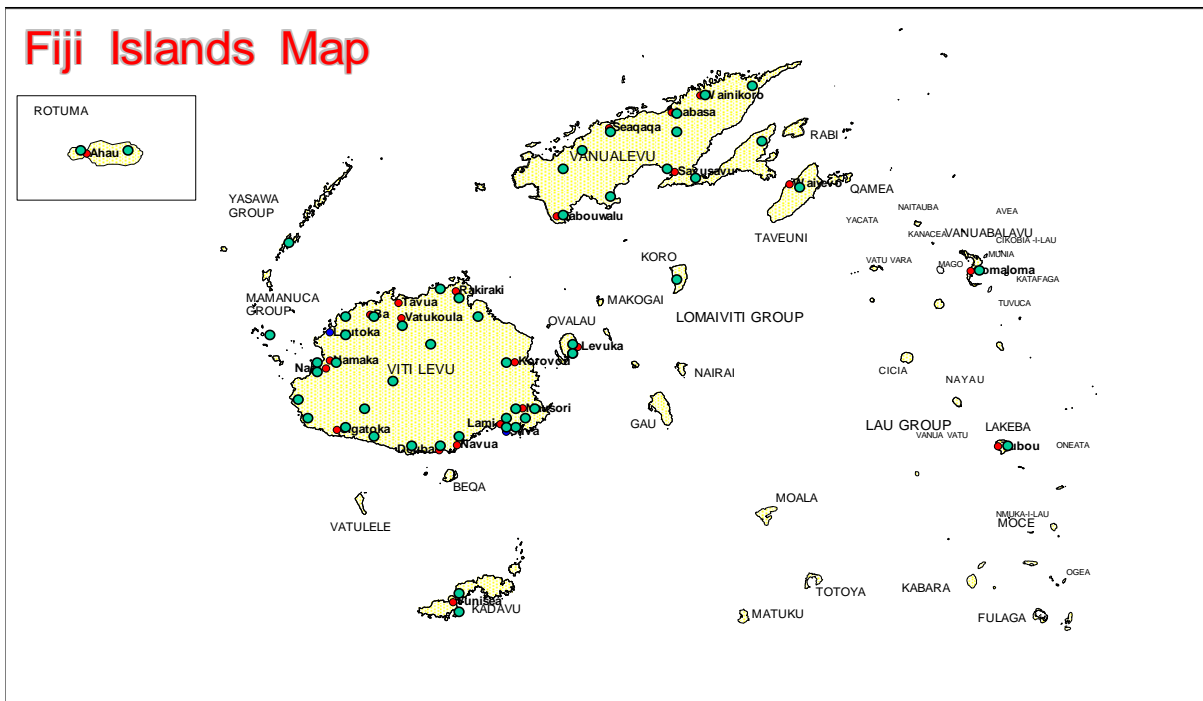

Appendix 4

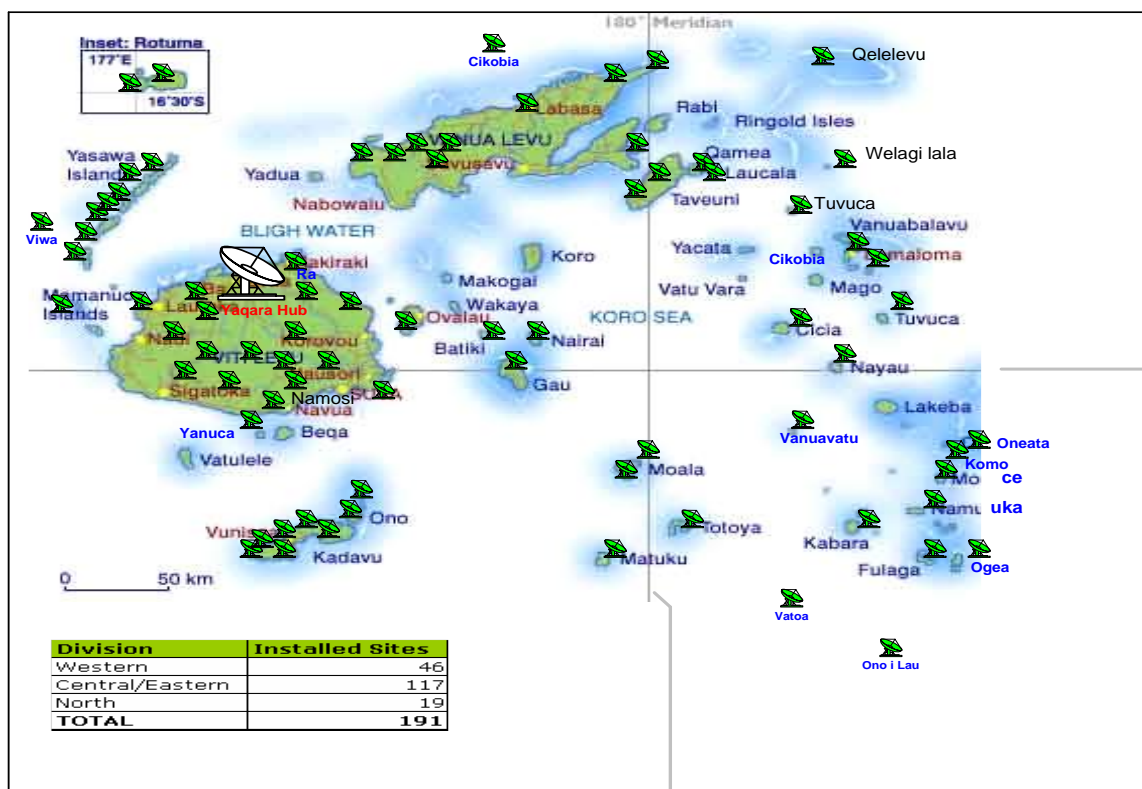

2.5. Impact assessment

1) drnr-i-0014/0046: Handbook on Telecommunications and Disaster Mitigation

Part I. Summary.

- Country: Japan
- Title of use case: Use case of telecommunication services in Japan earthquake and tsunami, 11 March 2011
- Details of the person preparing the use case:
 - Name: Keith Mainwaring (Original)
 - Title: Consultant
 - Organization: ITU Telecommunication Standardization Bureau (TSB)
 - Address: N.A.
 - E-Mail: N.A.
 - Website: N.A.
- Date of the submission:
 - ITU-T Workshop, Geneva, 25 June 2012 (Telecommunications for Disaster Relief, Network Resilience and Recovery: An Introduction)
 - DR&NRR-i-0014 (Handbook on Public Telecommunications Systems in Disaster Situations)
 - DR&NRR-i-0046 (Handbook on Telecommunications and Disaster Mitigation)
 - ITU-T Workshop, Istanbul, 11 December 2012 (ITU-T Handbook on Telecommunications and Disaster Mitigation)
- ITU-T SG(s) to which you think your use case could be relevant: TBD
- Status of use case: (clarification needed)
 - Operational | Completed | Research and Development

- If in operational, specify major deployment cases
- (Potential target) Location and population of the use case
 - Location (village, district, etc.) (or specify the target is city, rural, and/or countryside):
 - East Japan
 - Population of the project area:
 - About 19,000 fatalities
 - Material damages estimated at US\$210 billion
 - About 370,000 houses destroyed
 - Nuclear power plants severely damaged
 - Power, water and gas supplies cut
- Relevant actors (played roles)
 - end-users: (played roles to be specified)
 - private sector organizations: (played roles to be specified)
 - telecommunication operators
 - broadcasting
 - public sector organizations: (played roles to be specified)
 - national/local government: (played roles to be specified)
 - others: (played roles to be specified)
 - If others, please specify:
- Type of disaster
 - Earthquake | Tsunami
 - if others, please specify:
- Type of use case
 - prediction and early warning | response | impact assessment | recovery | reconstruction
 - Wired local loop: Copper, optical fibre, etc. (customers' loop) | Wireless local loop (customers' loop) | Fixed wireless access (long distance) | Mobile wireless access | Terrestrial voice, data, sound or television broadcasting
 - if others, please specify:
- Objective and/or achievements of the use case
 - Objective: Impact assessment
 - Achievements
 - Overview of damage to telecommunications infrastructure
 - Fixed lines – maximum number damaged
 - Fixed lines - changes in the number damaged
 - Fixed public telephone call volumes
 - Fixed line congestion
 - Mobile – maximum number of out-of-service base stations
 - Mobiles – changes in number of damaged base stations
 - Mobile network congestion
 - Damage to submarine cables
 - TV and radio stations out-of-service
- summary of the use case indicating its expected social/economic impacts: Not presented

Part II. Details.

- Overview of use case targets, objectives and financing
 - Objectives and implementation details of the use case including problem statement (tsunami, earthquake, drought, etc.): A case study on the impact of earthquake and

- tsunami
 - Brief description of the target country/region: geography, terrain, climate, demographics, socio-economic situation:
 - East Japan
 - If any, technological improvement and its effects for providing new capabilities, reduced cost capital and operating cost solutions.
 - None
 - Usage of “Disaster Emergency Message Boards” is presented.
- Infrastructure and regulatory environment
 - Infrastructure components:
 - Necessary telecommunication facilities: Fixed NW buildings, transmission routes, mobile base stations, submarine cables, TV/radio broadcasting stations, internet (web sites, e-mail, SNS, twitter), community wireless systems
 - transport access: None
 - electricity supply: widespread and prolonged power cuts and the inability to refuel temporary generators
 - distance to the nearest local exchange and/or IP network: Not presented
 - human resources: Not presented
 - security: Not presented
 - Regulatory components:
 - Necessary license: Not presented
 - frequency availability (for radio-based projects): Not presented
 - other regulatory issues: Not presented
 - Other factors which influenced the operating environment (manufacturers, standards etc).
- Technical description of use case provided
 - Architecture, type of systems, main technical characteristics, frequencies (for radio-based projects), power consumption, performances (capacity, reliability, quality of service), network management, etc.: Not presented
 - Installation and deployment: network planning, subscriber management, etc.: Not presented
 - Interconnection to national networks/backbones/disaster response systems: Not presented
- Cost | financial aspects, if possible
 - Cost of the equipment, cost per line and cost of the operation of the system: Not presented
 - Cost of each terminal and cost of the service for the user: Not presented
 - Financial aspects of the use case: Material damages estimated at US\$210 billion
- Effectiveness and sustainability of the project: Not applicable
 - Effectiveness and benefits of the project for the targeted user groups
 - Profitability of the project and/or its contribution to local entrepreneurial activities
 - Specific strategies to respond to the needs of women, youth, handicapped, indigenous people and other marginalized or socially disadvantaged groups
 - Aspects of the project, which could be strengthened to enhance its effectiveness or sustainability maximizing the benefits of telecommunication infrastructure in rural and remote areas.
- Other observations
 - Derived requirements | requests for the emergency telecommunication community
 - Avoiding congestion
 - Encourage alternative means of communication

- Reduce call hold times
- Reduce call quality
- Reassign resources to telephony
- New network architecture
- Autonomous power supply critical
- Install equipment in safer locations
- Avoid use of aerial facilities
- Geographical disperse critical equipment such as authentication servers
- Accessibility
 - Elderly and disabled vulnerable
 - Need mechanisms to inform the deaf, blind and illiterate
 - Text-to-speech
 - Text-to-sign language
 - Talking books
 - Multi-lingual information
- Anticipated near/long-term future plan
- Media diversity important
 - Radio
 - BBC World Service 188 million weekly (2009)
 - USA 241.2 million weekly (2011) 93% of population
 - Social Media
 - Twitter 140 million users (March 2012)
 - Facebook 900 million users (2012)
- Other observations
 - Lead times: vary enormously depending upon the type of threat
 - tens of seconds for earthquakes,
 - minutes for tornadoes,
 - minutes to hours for tsunamis,
 - hours to days for volcanic eruptions,
 - hours to weeks for hurricanes,
 - weeks to months for droughts, and
 - years for long term climatic events such as El Nino and climate change
- Other source of information
 - Web
 - Important publications
 - Others

2) Workshop-1, Jun.2012 Session1-1: Telecommunications for Disaster Relief, Network Resilience and Recovery - An Introduction

Part I. Summary.

- Country : ITU
- Title of use case : Telecommunications for Disaster Relief, Network Resilience and Recovery Introduction
- Details of the person preparing the use case:
 - Name: Keith Mainwaring
 - Title: Consultant
 - Organization: ITU Telecommunication Standardization Bureau (TSB)
 - Address:
 - E-Mail:
 - Website: <http://www.itu.int/en/ITU-T/pcptdr/Pages/default.aspx>
- Date of the submission: FG-DR&NRR Workshop, Geneva, 25 June 2012 (Presentation 1-1)
- ITU-T SG(s) to which you think your use case could be relevant:
- Status of use case:
 - Operational | Completed | Research and Development
 - If in operational, specify major deployment cases
 - Japan earthquake and tsunami, 11 March 2011
 - Hurricane Katrina 29 August 2005
 - Indian Ocean Tsunami
 - 9/11
- (Potential target) Location and population of the use case: N/A
 - Location (village, district, etc.) (or specify the target is city, rural, and/or countryside)
 - Population of the project area
- Relevant actors (played roles) : N/A
 - end-users, private sector organizations, public sector organizations, national/local government, others
 - If others, please specify:
- Type of disaster
 - Cold wave | Drought | Earthquake | Epidemic | Extratropical Cyclone | Fire | Flash Flood | Flood | Heat Wave | Insect Infestation | Land Slide | Mad Slide | Severe Local Storm | Snow Avalanche | Storm Surge | Tech. Disaster | Tropical Cyclone | Tsunami | Volcano | Wild Fire | Other
 - if others, please specify: Terrorist Attack
- Type of use case
 - Mitigation and prevention | preparedness | prediction and early warning | response | impact assessment | recovery | reconstruction
 - Wired local loop: Copper, optical fibre, etc. (customers' loop) | Wireless local loop (customers' loop) | Fixed wireless access (long distance) | Mobile wireless access | Satellite two-way communications: VSAT, etc. | Wireless LANS and IP-based related networks | Terrestrial voice, data, sound or television broadcasting | Satellite voice, data, sound or television broadcasting | Hybrid or combined technologies | Others
 - if others, please specify:

- Objective and/or achievements of the use case
- summary of the use case indicating its expected social /economic impacts

Part II. Details.

- Overview of use case targets, objectives and financing
 - Objectives and implementation details of the use case including problem statement (tsunami, earthquake, drought, etc.):
 - Brief description of the target country/region: geography, terrain, climate, demographics, socio-economic situation:

Japan earthquake

-About 19,000 fatalities

-Material damages estimated at US\$210 billion

-About 370,000 houses destroyed

-Nuclear power plants severely damaged

-Power, water and gas supplies cut

-NTT East's fixed network

385 buildings being out-of-service,

90 transmission routes were broken, and

6,300 km of coastal aerial cables and 65,000 utility poles washed away or otherwise damaged.

-Aerial facilities fared much worse than those underground with a damage rate of 0.3% for underground facilities and 7.9% for aerial facilities.

-The earthquake itself caused little damage.

-The tsunami destroyed outside plant and flooded buildings and accounted for about 20% of the damage.

-But 80% of buildings were put out of action as a result of the widespread and prolonged power cuts and the inability to refuel temporary generators.

12 March

-120 TV relay stations out of service on 12 March

-2 radio relay stations out of service on 12 March

Katrina

-Some 1833 fatalities

-Material damage estimated at \$108 billion

-Power outages 2.5 million people

-Telecommunications facilities out-of-service:

3 million subscriber lines

1,477 mobile towers

38 "911" emergency call centers

100 broadcast stationsIndian Ocean Tsunami

- An earthquake of magnitude 9.3 occurred off the coast of Sumatra creating a tsunami that struck the coasts around the Indian Ocean from Indonesia to South Africa
- No early warning system for the Indian Ocean then in place
- 280,000 fatalities
- 1.5 million lost their homes
- Economic losses of US\$7 billion

9/11

- 8:46 am on 11 September 2001: a hijacked commercial aircraft crashed into the north tower of the World Trade Center (WTC) in New York City, followed by another being crashed into the south tower of the WTC at 9:03 and into the Pentagon in Washington DC at 9:37. Both towers of the World Trade Center collapsed later than morning causing many casualties and severe material damage.

- The WTC was a significant wireless repeater site and Sprint PCS, Verizon and AT&T Wireless services were disrupted. Also, the Internet service provider points-of-presence (POPs) of Worldcom, AT&T Local Service and Verizon/Genuity that were in the complex were destroyed.

- Severe congestion in both the fixed and mobile networks. Mobile networks in New York City experienced a blocking ration of 92% as call volumes increased ten-fold.

- 5:30 pm: WTC building 7 collapsed, destroying a Consolidated Edison electrical substation and damaging the Verizon central office building at 140 West Street. The basement power supplies in this building were flooded and 1.5 million lines serving the financial district were then out-of-service.

- If any, technological improvement and its effects for providing new capabilities, reduced cost capital and operating cost solutions.
- Infrastructure and regulatory environment
 - Infrastructure components: Necessary telecommunication facilities, transport access, electricity supply, distance to the nearest local exchange and/or IP network, human resources, security :

Japan earthquake

- Resident of temporary housing heard tsunami warning after main quake on 11 March by mean of mainly radio and community wireless system

- Disaster Emergency Message (Dial 171), Disaster Emergency Broadband message Board (Web 171) and Message Boards providing by mobile operators were activated at times of disaster. As of 31 May 2011, Dial171 had been used approximately 3.33 million times, web171 approximately 2.3 million times, and mobile message boards had 3.5 registered users and had been used 5.8 million times. However, a survey has indicated that 21% of all respondents were unaware of the availability of these services and that 91% did not use them.

9/11

-9/11 coincident with GETS (Government Emergency Telecommunications) becoming fully operational with priority treatment for GETS calls being provided to National Security / Emergency Preparedness (NS/EP) users from more than 85% of access lines in the United States.

-Over 10,000 GETS calls were made over the wireline networks in New York City and Washington DC following the attacks with a successful completion rate of over 95%.

-Internet not severely impacted by 9/11 attacks

-News sites heavily used, no congestion - Internet traffic decreased

-Less email sent (though some substitution of email for telephone)

-Greater use of Instant Messaging

-TV preferred source of news

- Regulatory components: Necessary license, frequency availability (for radio-based projects), other regulatory issues
- Other factors which influenced the operating environment (manufacturers, standards etc).
- Technical description of use case provided
 - Architecture, type of systems, main technical characteristics, frequencies (for radio-based projects), power consumption, performances (capacity, reliability, quality of service), network management, etc.,
 - Installation and deployment: network planning, subscriber management, etc.
 - Interconnection to national networks/backbones/disaster response systems
- Cost | financial aspects, if possible
 - Cost of the equipment, cost per line and cost of the operation of the system
 - Cost of each terminal and cost of the service for the user.
 - Financial aspects of the use case
- Effectiveness and sustainability of the project
 - Effectiveness and benefits of the project for the targeted user groups
 - Profitability of the project and/or its contribution to local entrepreneurial activities
 - Specific strategies to respond to the needs of women, youth, handicapped, indigenous people and other marginalized or socially disadvantaged groups
 - Aspects of the project, which could be strengthened to enhance its effectiveness or sustainability maximizing the benefits of telecommunication infrastructure in rural and remote areas.
- Other observations
 - Unexpected results and/or lessons learned
 - Derived requirements | requests for the emergency telecommunication community
 - Anticipated near/long-term future plan
- Other source of information
 - Web:

http://www.soumu.go.jp/main_content/000146938.pdf

http://www.soumu.go.jp/main_sosiki/joho_tsusin/eng/presentation.html#mar16

http://www.ncs.gov/library/reports/ncs_fy2001.pdf

- Important publications
- Others

3) Workshop-2, December, 2012 Session 1-1: Effect of Disasters on FTTX network

Part I. Summary.

- Country: Turkey
- Title of use case: Effect of Disasters on FTTX network
- Details of the person preparing the use case:
 - Name: Zekeriya ERKAN
 - Title:
 - Organization: Turk Telekom
 - Address:
 - E-Mail:
 - Website:
- Date of the submission: Workshop on Disaster Relief Systems, Network Resilience and Recovery, Istanbul, Turkey, 11 December 2012 (Presentation 1-1)
- ITU-T SG(s) to which you think your use case could be relevant:
- Status of use case:
 - Operational | Completed | Research and Development
 - If in operational, specify major deployment cases
- (Potential target) Location and population of the use case
 - Location (village, district, etc.) (or specify the target is city, rural, and/or countryside):

Large FTTX deployed area
 - Population of the project area
- Relevant actors (played roles)
 - end-users, private sector organizations, public sector organizations, national/local government, others
 - If others, please specify: Operators
- Type of disaster

[EdNote: consider to edit this list. The list is easy to understand, but contains incidents that do not affect very much to telecom networks. Contributions invited.]

 - Cold wave | Drought | Earthquake | Epidemic | Extratropical Cyclone | Fire | Flash Flood | Flood | Heat Wave | Insect Infestation | Land Slide | Mad Slide | Severe Local Storm | Snow Avalanche | Storm Surge | Tech. Disaster | Tropical Cyclone | Tsunami | Volcano | Wild Fire | Other
 - if others, please specify:
- Type of use case
 - Mitigation and prevention | preparedness | prediction and early warning | response | impact assessment | recovery | reconstruction
 - Wired local loop: Copper, optical fibre, etc. (customers' loop) | Wireless local loop (customers' loop) | Fixed wireless access (long distance) | Mobile wireless access | Satellite two-way communications: VSAT, etc. | Wireless LANS and IP-based related networks | Terrestrial voice, data, sound or television broadcasting | Satellite voice, data, sound or television broadcasting | Hybrid or combined technologies | Others
 - if others, please specify:
- Objective and/or achievements of the use case

- summary of the use case indicating its expected social /economic impacts:

Fibre cables more sensible pressure than copper cables

Part II. Details.

- Overview of use case targets, objectives and financing
 - Objectives and implementation details of the use case including problem statement (tsunami, earthquake, drought, etc.): Effect of earthquake on large distributed FTTX
 - Brief description of the target country/region: geography, terrain, climate, demographics, socio-economic situation:
 - If any, technological improvement and its effects for providing new capabilities, reduced cost capital and operating cost solutions.
- Infrastructure and regulatory environment
 - Infrastructure components: Necessary telecommunication facilities, transport access, electricity supply, distance to the nearest local exchange and/or IP network, human resources, security

Collapsed or destroyed buildings and telecom infrastructure (Ducts, Pipes, Cables, Equipment, etc.)

There is no way to quickly recover infrastructure and provide service other than Mobile capabilities.

Some buildings collapsed, destroyed, others undamaged. Telecom infrastructure partially destroyed in some areas but still big portion undamaged.

Telecom infrastructure destroyed and out of service in some areas.

Big Part of Network in good condition and works.

But still there is risk to lose all services.

 - Regulatory components: Necessary license, frequency availability (for radio-based projects), other regulatory issues
 - Other factors which influenced the operating environment (manufacturers, standards etc).
- Technical description of use case provided
 - Architecture, type of systems, main technical characteristics, frequencies (for radio-based projects), power consumption, performances (capacity, reliability, quality of service), network management, etc.,
 - Installation and deployment: network planning, subscriber management, etc.
 - Interconnection to national networks/backbones/disaster response systems
- Cost | financial aspects, if possible
 - Cost of the equipment, cost per line and cost of the operation of the system
 - Cost of each terminal and cost of the service for the user.
 - Financial aspects of the use case
- Effectiveness and sustainability of the project
 - Effectiveness and benefits of the project for the targeted user groups
 - Profitability of the project and/or its contribution to local entrepreneurial activities
 - Specific strategies to respond to the needs of women, youth, handicapped, indigenous people and other marginalized or socially disadvantaged groups
 - Aspects of the project, which could be strengthened to enhance its effectiveness or sustainability maximizing the benefits of telecommunication infrastructure in rural

- and remote areas.
- Other observations
 - Unexpected results and/or lessons learned
 - Derived requirements | requests for the emergency telecommunication community

Ring or mesh topoloji critical for FTTC cabinets

Power shortage is very critical

Spare FTTX equipment or boards and batteries
- Anticipated near/long-term future plan
- Other source of information
 - Web
 - Important publications
 - Others

2.6. Recovery

1) drnrr-i-0027: COMMUNICATIONS DISASTER, SDPPI/ MIN. of INFOCOM INDONESIA

Part I. Summary.

- Country: Indonesia
- Title of use case: COMMUNICATIONS DISASTER
- Details of the person preparing the use case:
 - Name: SUBAGYO
 - Title:
 - Organization: SDPPI/MIN. of INFOCOM
 - Address
 - E-Mail:
 - Website:
- Date of the submission: FG-DR&NRR, Geneva, 24 September, 2012 (i-27)
- ITU-T SG(s) to which you think your use case could be relevant: N/A
- Status of use case:
 - Operational | Completed | Research and Development
 - If in operational, specify major deployment cases:
- (Potential target) Location and population of the use case: Not Presented
 - Location (village, district, etc.) (or specify the target is city, rural, and/or country-side)
 - Population of the project area:
- Relevant actors (played roles)
 - end-users, private sector organizations, public sector organizations, national/local government, others
 - If others, please specify:
- Type of disaster
 - Cold wave | Drought | Earthquake | Epidemic | Extratropical Cyclone | Fire | Flash Flood | Flood | Heat Wave | Insect Infestation | Land Slide | Mad Slide | Severe Local

Storm | Snow Avalanche | Storm Surge | Tech. Disaster | Tropical Cyclone | Tsunami
| Volcano | Wild Fire | Other

- if others, please specify:
- Type of use case
 - Mitigation and prevention | preparedness | prediction and early warning | response | impact assessment | recovery | reconstruction
 - Wired local loop: Copper, optical fibre, etc. (customers' loop) | Wireless local loop (customers' loop) | Fixed wireless access (long distance) | Mobile wireless access | Satellite two-way communications: VSAT, etc. | Wireless LANS and IP-based related networks | Terrestrial voice, data, sound or television broadcasting | Satellite voice, data, sound or television broadcasting | Hybrid or combined technologies | Others
 - if others, please specify: Radio Communications
- Objective and/or achievements of the use case
- summary of the use case indicating its expected social /economic impacts

Part II. Details.

- Overview of use case targets, objectives and financing
 - Objectives and implementation details of the use case including problem statement (tsunami, earthquake, drought, etc.): Years 1960-2010, Indonesia had 23 times Tsunami
 - Brief description of the target country/region: geography, terrain, climate, demographics, socio-economic situation:
 - If any, technological improvement and its effects for providing new capabilities, reduced cost capital and operating cost solutions.
- Infrastructure and regulatory environment
 - Infrastructure components: Necessary telecommunication facilities, transport access, electricity supply, distance to the nearest local exchange and/or IP network, human resources, security
 - Regulatory components: Necessary license, frequency availability (for radio-based projects), other regulatory issues
 - Other factors which influenced the operating environment (manufacturers, standards etc). : Indonesia has established BNPB/SRCPB.
- Technical description of use case provided
 - Architecture, type of systems, main technical characteristics, frequencies (for radio-based projects), power consumption, performances (capacity, reliability, quality of service), network management, etc.: Each Nodes of Organization Structures managing communications network has Call Sign with unique name and controlled by Incident Commander.
 - Installation and deployment: network planning, subscriber management, etc.
 - Interconnection to national networks/backbones/disaster response systems
- Cost | financial aspects, if possible
 - Cost of the equipment, cost per line and cost of the operation of the system
 - Cost of each terminal and cost of the service for the user.
 - Financial aspects of the use case
- Effectiveness and sustainability of the project
 - Effectiveness and benefits of the project for the targeted user groups
 - Profitability of the project and/or its contribution to local entrepreneurial activities
 - Specific strategies to respond to the needs of women, youth, handicapped, indigenous

- people and other marginalized or socially disadvantaged groups
- Aspects of the project, which could be strengthened to enhance its effectiveness or sustainability maximizing the benefits of telecommunication infrastructure in rural and remote areas.
- Other observations
 - Unexpected results and/or lessons learned
 - Derived requirements | requests for the emergency telecommunication community
 - Anticipated near/long-term future plan
- Other source of information
 - Web
 - Important publications
 - Others

2) drnrr-i-0045: The Communication Service Group mechanism in Turkey: An Interoperative Approach for Emergency Communication, Network Resilience and Recovery

Part I. Summary.

- Country: Turkey
- Title of use case: The Communication Service Group mechanism in Turkey: An Interoperative Approach for Emergency Communication, Network Resilience and Recovery
- Details of the person preparing the use case:
 - Name: Aziz SASA
 - Title: President
 - Organization: Telsiz Radyo Amatorleri Cemiyeti [TRAC]
 - Address:
 - E-Mail: infotrac@googlegroups.com
 - Website:
- Date of the submission: 11 - 13 December 2012, DR&NRR-i-0045, “The Communication Service Group mechanism in Turkey: An Interoperative Approach for Emergency Communication, Network Resilience and Recovery”
- ITU-T SG(s) to which you think your use case could be relevant:
- Status of use case:
 - Operational
 - If in operational, specify major deployment cases: “Emergency Communication Systems, Network Resilience and Recovery,” handled by the “Communication Service Group,” Turkey
- (Potential target) Location and population of the use case
 - Location (village, district, etc.) (or specify the target is city, rural, and/or countryside): Every province in Turkey
 - Population of the project area
- Relevant actors (played roles)
 - end-users
 - private sector organizations: members of the “Communication Service Group”: GSM-Providers, Satellite Service Providers, the Maritime Communication Service Provider, Law Enforcement Agencies, Turkish Radio TV (TRT), and other agencies with a strong radio communication structure
 - public sector organizations
 - national/local government
 - others
 - If others, please specify:
- Type of disaster
 - Cold wave | Drought | Earthquake | Epidemic | Extratropical Cyclone | Fire | Flash Flood | Flood | Heat Wave | Insect Infestation | Land Slide | Mad Slide | Severe Local Storm | Snow Avalanche | Storm Surge | Tech. Disaster | Tropical Cyclone | Tsunami | Volcano | Wild Fire | Other
 - if others, please specify:
- Type of use case
 - preparedness | prediction and early warning | response | recovery
 - Wireless local loop (customers’ loop) | Mobile wireless access | Satellite
 - if others, please specify: Maritime Communication
- Objective and/or achievements of the use case
 - Objectives

- mutual aid among the members in order to provide emergency communication and quick network recovery in the aftermath of emergencies
- to provide “Business Continuity”
- to overcome the inefficiency brought about by complex and expensive radio communication networks, often praised as a key instrument for interoperability, in the aftermath of disasters
- Achievements
 - Amateur Radio has been proven to be a major resource to fill this gap (i.e., to overcome the lack of experienced personnel that is able to handle such adverse situations like emergency) globally. Being a pool of dedicated volunteers using simple and efficient technologies, which are tailored for weak signal communication, this resource was easily used to overcome the problems typical to emergencies several times in the past.
 - IARU, the International Amateur Radio Union, is presently leading the revision of the Handbook of Emergency Communication published by ITU-D.
- summary of the use case indicating its expected social/economic impacts

Part II. Details.

- Overview of use case targets, objectives and financing
 - Objectives and implementation details of the use case including problem statement (tsunami, earthquake, drought, etc.):
 - Brief description of the target country/region: geography, terrain, climate, demographics, socio-economic situation:
 - If any, technological improvement and its effects for providing new capabilities, reduced cost capital and operating cost solutions.
- Infrastructure and regulatory environment
 - Infrastructure components:
 - Necessary telecommunication facilities: Amateur Radio, GSM, Satellite Service, the Maritime Communication Service, Radio TV (TRT), and other radio communication
 - transport access
 - electricity supply
 - distance to the nearest local exchange and/or IP network
 - human resources
 - security
 - Regulatory components:
 - Necessary license
 - frequency availability (for radio-based projects)
 - other regulatory issues
 - Other factors which influenced the operating environment (manufacturers, standards etc).
- Technical description of use case provided
 - Architecture, type of systems, main technical characteristics, frequencies (for radio-based projects), power consumption, performances (capacity, reliability, quality of service), network management, etc.,
 - Installation and deployment: network planning, subscriber management, etc.
 - Interconnection to national networks/backbones/disaster response systems
- Cost | financial aspects, if possible
 - Cost of the equipment, cost per line and cost of the operation of the system

- Cost of each terminal and cost of the service for the user.
- Financial aspects of the use case
- Effectiveness and sustainability of the project
 - Effectiveness and benefits of the project for the targeted user groups
 - Profitability of the project and/or its contribution to local entrepreneurial activities
 - Specific strategies to respond to the needs of women, youth, handicapped, indigenous people and other marginalized or socially disadvantaged groups
 - Aspects of the project, which could be strengthened to enhance its effectiveness or sustainability maximizing the benefits of telecommunication infrastructure in rural and remote areas.
- Other observations
 - Unexpected results and/or lessons learned
 - Derived requirements | requests for the emergency telecommunication community
 - mutual aid among the members in order to provide emergency communication and quick network recovery in the aftermath of emergencies
 - to provide “Business Continuity”
 - to overcome the inefficiency brought about by complex and expensive radio communication networks, often praised as a key instrument for interoperability, in the aftermath of disasters
 - Anticipated near/long-term future plan
- Other source of information
 - Web
 - Important publications
 - Others

3) 2nd Workshop, Dec. 2012 Session1-2: The Communication Service Group mechanism in Turkey: An Interoperative Approach for Emergency Communication, Network Resilience and Recovery

Part I. Summary.

- Country: Turkey
- Title of use case: The Communication Service Group mechanism in Turkey: An Interoperative Approach for Emergency Communication, Network Resilience and Recovery
- Details of the person preparing the use case:
 - Name: Aziz ŞASA
 - Title:
 - Organization: TRAC
 - Address:
 - E-Mail: ta1e@ttmail.com
 - Website:
- Date of the submission: Workshop on Disaster Relief Systems, Network Resilience and Recovery , Istanbul, Turkey, 11 December 2012 (Presentation 1-2)
- ITU-T SG(s) to which you think your use case could be relevant: ITU-D SG-2
- Status of use case:
 - Operational | Completed | Research and Development
 - If in operational, specify major deployment cases: Turkey earthquakes
- (Potential target) Location and population of the use case: Not Presented
 - Location (village, district, etc.) (or specify the target is city, rural, and/or countryside)
 - Population of the project area
- Relevant actors (played roles)
 - end-users, private sector organizations, public sector organizations, national/local government, others
 - If others, please specify:
- Type of disaster
 - Cold wave | Drought | Earthquake | Epidemic | Extratropical Cyclone | Fire | Flash Flood | Flood | Heat Wave | Insect Infestation | Land Slide | Mad Slide | Severe Local Storm | Snow Avalanche | Storm Surge | Tech. Disaster | Tropical Cyclone | Tsunami | Volcano | Wild Fire | Other
 - if others, please specify:
- Type of use case
 - Mitigation and prevention | preparedness | prediction and early warning | response | impact assessment | recovery | reconstruction
 - Wired local loop: Copper, optical fibre, etc. (customers' loop) | Wireless local loop (customers' loop) | Fixed wireless access (long distance) | Mobile wireless access | Satellite two-way communications: VSAT, etc. | Wireless LANS and IP-based related networks | Terrestrial voice, data, sound or television broadcasting | Satellite voice, data, sound or television broadcasting | Hybrid or combined technologies| Others
 - if others, please specify: Ham
- Objective and/or achievements of the use case : To be defined
- summary of the use case indicating its expected social /economic impacts : No particular social/economic impacts.

Part II. Details.

- Overview of use case targets, objectives and financing
 - Objectives and implementation details of the use case including problem statement (tsunami, earthquake, drought, etc.):
 - Lack of an efficient radio communication within and between service providers in emergencies
 - Vulnerabilities of complex radio communication systems
 - Brief description of the target country/region: geography, terrain, climate, demographics, socio-economic situation: Turkey
 - If any, technological improvement and its effects for providing new capabilities, reduced cost capital and operating cost solutions.
- Infrastructure and regulatory environment
 - Infrastructure components: Necessary telecommunication facilities, transport access, electricity supply, distance to the nearest local exchange and/or IP network, human resources, security :
 - ✧ When all else fails, amateur radio works
 - ✧ Simple, strong, sustainable infrastructure, vast variety of techniques
 - ✧ Dedicated volunteers
 - ✧ Co-operation with majority of agencies including scientific sources such as National Earthquake Research Centre.
 - Regulatory components: Necessary license, frequency availability (for radio-based projects), other regulatory issues
 - Other factors which influenced the operating environment (manufacturers, standards etc).
- Technical description of use case provided
 - Architecture, type of systems, main technical characteristics, frequencies (for radio-based projects), power consumption, performances (capacity, reliability, quality of service), network management, etc.,
 - Installation and deployment: network planning, subscriber management, etc.
 - Interconnection to national networks/backbones/disaster response systems
- Cost | financial aspects, if possible
 - Cost of the equipment, cost per line and cost of the operation of the system
 - Cost of each terminal and cost of the service for the user.
 - Financial aspects of the use case
- Effectiveness and sustainability of the project
 - Effectiveness and benefits of the project for the targeted user groups
 - Profitability of the project and/or its contribution to local entrepreneurial activities
 - Specific strategies to respond to the needs of women, youth, handicapped, indigenous people and other marginalized or socially disadvantaged groups
 - Aspects of the project, which could be strengthened to enhance its effectiveness or sustainability maximizing the benefits of telecommunication infrastructure in rural and remote areas.
- Other observations
 - Unexpected results and/or lessons learned
 - Derived requirements | requests for the emergency telecommunication community
 - Anticipated near/long-term future plan
- Other source of information
 - Web
 - Important publications

➤ Others

4) drnrr-i-105, i-121: Message Relay by Mobile Terminals without Cellular Infrastructure

Part I. Summary.

- Country: Japan
- Title of use case
 - Message Relay by Mobile Terminals without Cellular Infrastructure
- Details of the person preparing the use case:
 - Name: Hiroki Nishiyama
 - Title: Associate Professor
 - Organization: Graduate School of Information Sciences, Tohoku University
 - Address: Aramaki-Aoba 6-3-09, Aoba-ku, Sendai, 980-8579, JAPAN
 - E-Mail: bigtree@it.ecei.tohoku.ac.jp
 - Website: <http://www.it.ecei.tohoku.ac.jp/en-index.html>
 - Name: Nei Kato
 - Title: Professor
 - Organization: Graduate School of Information Sciences, Tohoku University
 - Address: Aramaki-Aoba 6-3-09, Aoba-ku, Sendai, 980-8579, JAPAN
 - E-Mail: kato@it.ecei.tohoku.ac.jp
 - Website: <http://www.it.ecei.tohoku.ac.jp/en-index.html>
- Date of the submission: 21 August 2013
- ITU-T SG(s) to which you think your use case could be relevant: TBD
- Status of use case:
 - ~~Operational~~ | ~~Completed~~ | Research and Development
 - If in operational, specify major deployment cases
- (Potential target) Location and population of the use case
 - Location (village, district, etc.) (or specify the target is city, rural, and/or country-side)
 - Population of the project area: Can operate in area with small population, but performance are generally better in an area with larger population
- Relevant actors (played roles)
 - end-users, private sector organizations, public sector organizations, national/local government, others
 - Private sector organizations are those who distribute the application for the end-users
 - If others, please specify:
- Type of disaster
 - ~~Cold wave~~ | ~~Drought~~ | Earthquake | ~~Epidemie~~ | ~~Extratropical Cyclone~~ | ~~Fire~~ | ~~Flash Flood~~ | ~~Flood~~ | ~~Heat Wave~~ | ~~Insect Infestation~~ | ~~Land Slide~~ | ~~Mad Slide~~ | ~~Severe Local Storm~~ | ~~Snow Avalanche~~ | ~~Storm Surge~~ | ~~Tech. Disaster~~ | ~~Tropical Cyclone~~ | Tsunami | ~~Volcano~~ | ~~Wild Fire~~ | Other
 - if others, please specify:
- Type of use case
 - ~~Mitigation and prevention~~ | ~~preparedness~~ | ~~prediction and early warning~~ | response | ~~impact assessment~~ | recovery | ~~reconstruction~~
 - Wired local loop: Copper, optical fibre, etc. (customers' loop) | Wireless local loop (customers' loop) | Fixed wireless access (long distance) | Mobile wireless access | Satellite two-way communications: VSAT, etc. | Wireless LANS and IP-based relat-

ed networks | Terrestrial voice, data, sound or television broadcasting | Satellite voice, data, sound or television broadcasting | Hybrid or combined technologies| Others

➤ if others, please specify:

- Objective and/or achievements of the use case:

Make it possible to deliver message without any physical infrastructure.

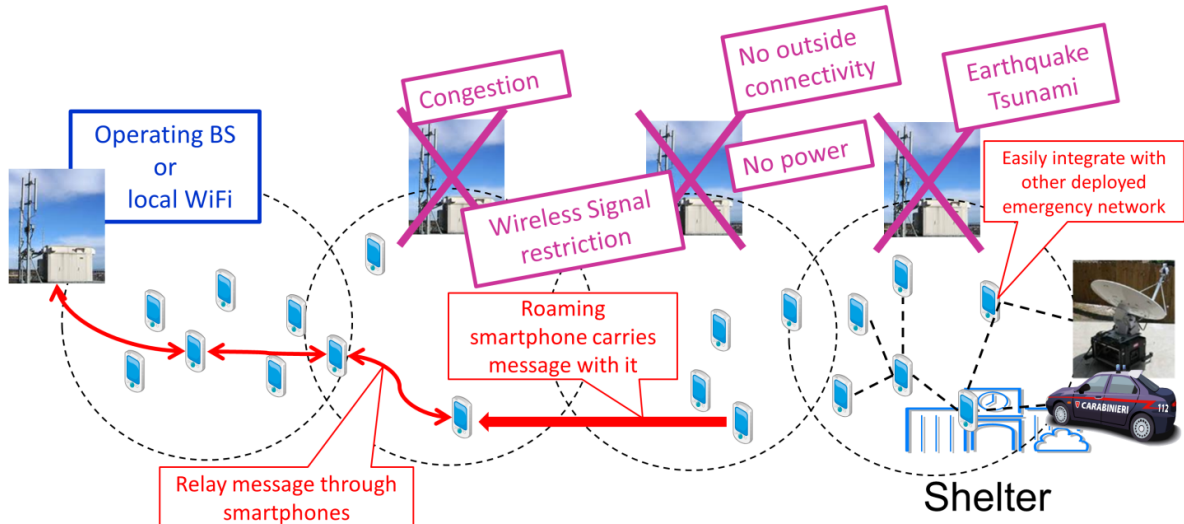

- summary of the use case indicating its expected social /economic impacts:

The application can be downloaded by the user without any cost. However, it is necessary that the user downloaded the application prior to usage. In addition, it may be possible for end-user to utilize this system in everyday life like delivering message to family members or friends without any charge from cellular operator. One scenario is that when many people gather for a public event such as concert or sport event, cellular network may not be able to accommodate a massive amount of user within the area. Therefore, this system can be used to provide communications service to the participant without any incurring cost.

Part II. Details.

- Overview of use case targets, objectives and financing
 - Objectives and implementation details of the use case including problem statement (tsunami, earthquake, drought, etc.):

After an event of disaster such as earthquake or tsunami, many communications infrastructure may be damaged or destroyed. Therefore, it is necessary to provide some means of communication especially some means of sending message. This contribution provides the necessary method of sending messages even when the physical infrastructure is not available. This contribution utilizes common smartphone WiFi functionality to send message in a multi-hop fashion. Thus it is possible to send message to people further away using this contribution.

- Brief description of the target country/region: geography, terrain, climate, demographics, socio-economic situation:

Currently target regions are regions that have a lot of natural disaster like Japan or regions that has minimum or no physical infrastructures.

- If any, technological improvement and its effects for providing new capabilities, reduced cost capital and operating cost solutions.

The network introduced by the contribution can furthermore be enhanced by integrating with other type of network such as satellite network, movable and deployable resource unit (MDRU) network, unmanned aircraft systems (UAS), or even remaining cellular network to make even longer distance communication available.

- Infrastructure and regulatory environment

- Infrastructure components: Necessary telecommunication facilities, transport access, electricity supply, distance to the nearest local exchange and/or IP network, human resources, security

Only user terminal are necessary to deliver messages between user terminals. However, additional infrastructure components such as MDRU, UAS, or user terminal under working cellular network can enhance the performance of the system.

- Regulatory components: Necessary license, frequency availability (for radio-based projects), other regulatory issues

Since the system utilizes WiFi and WiFi operates in unlicensed band, no necessary frequency licensing is required.

- Other factors which influenced the operating environment (manufacturers, standards etc).

Detailed information to be provided

- Technical description of use case provided

- Architecture, type of systems, main technical characteristics, frequencies (for radio-based projects), power consumption, performances (capacity, reliability, quality of service), network management, etc.,

This system utilizes user terminal's WiFi capability to deliver messages with 2.4 GHz frequency band. The performance of the system is varies with the number of the end user involved. However, the system is also able to perform exceptionally with low number of users.

- Installation and deployment: network planning, subscriber management, etc.

Currently the plan is to make the application freely available to public. Thus users can freely download and install the application on their smartphone.

- Interconnection to national networks/backbones/disaster response systems

The contribution can be integrate with other network such as satellite network, MDRU network, UAS network, or remaining cellular network, which would have connectivity to the outside network.

- Cost | financial aspects, if possible

- Cost of the equipment, cost per line and cost of the operation of the system

The application will be made freely available to the public. However, additional equipment will be required when connecting with other network such as satellite, resource unit, and/or unmanned aerial vehicle.

- Cost of each terminal and cost of the service for the user.

Assuming our target users who are smartphone (WiFi equipped device) user own their own device, the application will be freely available. Thus no cost will be bestowed upon the user.

- Financial aspects of the use case
Detailed information to be provided

- Effectiveness and sustainability of the project

- Effectiveness and benefits of the project for the targeted user groups

The user can send message to other user in the form of safely confirmation or other form of communication. In addition, the users can use this system to send message in an event that cellular network is not available like large concert or sport event.

- Profitability of the project and/or its contribution to local entrepreneurial activities
Detailed information to be provided

- Specific strategies to respond to the needs of women, youth, handicapped, indigenous people and other marginalized or socially disadvantaged groups

Our targeted users are device owner who are likely to be familiar with their device. The only action that the user needs to take is to open the application and follow instructions. The matter is being investigated for the case of handicapped.

- Aspects of the project, which could be strengthened to enhance its effectiveness or sustainability maximizing the benefits of telecommunication infrastructure in rural and remote areas.

Since the application is freely available, anyone with a smartphone can download it and utilize its capability. One such scenario is that the system can be used as communication medium between resident of small village. In addition, with the help of unmanned aerial vehicle or satellite, it may be even possible to provide connection from rural area where there are no actual infrastructure to support communications service

- Other observations

- Unexpected results and/or lessons learned

Detailed information to be provided

- Derived requirements | requests for the emergency telecommunication community

Detailed information to be provided

- Anticipated near/long-term future plan
Detailed information to be provided

- Other source of information
 - Web
 - ◇ <http://www.it.ecei.tohoku.ac.jp/innovation/index.html> (Japanese)
 - ◇ English webpage in construction
 - Important publications
Detailed information to be provided
 - Others

5) 5th Workshop, May 2013, Session 3-2, An Application of “Hybridcast” for Disaster Information Delivery

Part I. Summary.

- Country: Japan
- Title of use case: Disaster Information Transmission System Based on “Hybridcast”
- Details of the person preparing the use case:
 - Name: Go Ohtake
 - Title: Researcher
 - Organization: NHK (Japan Broadcasting Corporation)
 - Address: 1-10-11 Kinuta, Setagaya-ku, Tokyo, 157-8510 JAPAN
 - E-Mail: ohtake.g-fw@nhk.or.jp
 - Website:
- Date of the submission: Fifth meeting of Focus Group on Disaster Relief Systems, Network Resilience and Recovery, Phuket, Thailand, 20-24 May 2013
- ITU-T SG(s) to which you think your use case could be relevant: ITU-T SG-9
- Status of use case:
 - Operational | Completed | Research and Development
 - If in operational, specify major deployment cases
- (Potential target) Location and population of the use case
 - Location (village, district, etc.) (or specify the target is city, rural, and/or countryside): Impacted and concerned regions which are independent from area
 - Population of the project area: 130 million in maximum
- Relevant actors (played roles)
 - end-users, private sector organizations, public sector organizations, national/local government, others
 - If others, please specify:
- Type of disaster
 - Cold wave | Drought | Earthquake | Epidemic | Extratropical Cyclone | Fire | Flash Flood | Flood | Heat Wave | Insect Infestation | Land Slide | Mad Slide | Severe Local Storm | Snow Avalanche | Storm Surge | Tech. Disaster | Tropical Cyclone | Tsunami | Volcano | Wild Fire | Other (Any of the above)
 - if others, please specify:
- Type of use case
 - Mitigation and prevention | preparedness | prediction and early warning | response | impact assessment | recovery | reconstruction
 - Wired local loop: Copper, optical fibre, etc. (customers’ loop) | Wireless local loop (customers’ loop) | Fixed wireless access (long distance) | Mobile wireless access |

Satellite two-way communications: VSAT, etc. | Wireless LANS and IP-based related networks | Terrestrial voice, data, sound or television broadcasting | Satellite voice, data, sound or television broadcasting | Hybrid or combined technologies | Others

- if others, please specify:
- Objective and/or achievements of the use case: Quick transmission of disaster information including early warning in the event of large-scale natural disaster
- summary of the use case indicating its expected social /economic impacts: Provision of information on evacuation survival and rescue operation

Part II. Details.

- Overview of use case targets, objectives and financing
 - Objectives and implementation details of the use case including problem statement (tsunami, earthquake, drought, etc.): Quick transmission of disaster information through both broadcasting and broadband in the event of earthquake and tsunami
 - Brief description of the target country/region: geography, terrain, climate, demographics, socio-economic situation: All over Japan
 - If any, technological improvement and its effects for providing new capabilities, reduced cost capital and operating cost solutions.
- Infrastructure and regulatory environment
 - Infrastructure components: Necessary telecommunication facilities, transport access, electricity supply, distance to the nearest local exchange and/or IP network, human resources, security: Broadcast networks, wired or wireless internet access, power supply to operate the equipment
 - Regulatory components: Necessary license, frequency availability (for radio-based projects), other regulatory issues
 - Other factors which influenced the operating environment (manufacturers, standards etc): IPTVFJ STD-0010, IPTVFJ STD-0011
- Technical description of use case provided
 - Architecture, type of systems, main technical characteristics, frequencies (for radio-based projects), power consumption, performances (capacity, reliability, quality of service), network management, etc.: An Integrated Broadcast-Broadband system using HTML5. A TV receiver and mobile computers can work together to present broadcast and additional content with interactivity.
 - Installation and deployment: network planning, subscriber management, etc.: broadcast channels plus any kind of internet reachable networks for each user
 - Interconnection to national networks/backbones/disaster response systems
- Cost | financial aspects, if possible
 - Cost of the equipment, cost per line and cost of the operation of the system
 - Cost of each terminal and cost of the service for the user.
 - Financial aspects of the use case
- Effectiveness and sustainability of the project

Effectiveness and benefits of the project for the targeted user groups: Users can obtain required information which may vary time by time.

(1) On the day when a big earthquake happened

- ✧ When a Hybridcast TV receiver gets “Earthquake Early Warning” signal from broadcast (Figure 1)

- The receiver launches the application immediately and automatically, and starts displaying detailed disaster information for local area. The application shows appropriate content depending on the area. (Figure 2)



Figure 1: Earthquake Early Warning Figure 2: Detailed disaster information for local area.

(It's not a function of Hybridcast.)

◇ When “Tsunami Warning” is issued

- The receiver displays an alert message, such as “Please evacuate immediately!”, according to urgency for those who live in the area where a tsunami will probably hit. (Figure 3)



Figure 3: Alert message for hazardous area.

- A user in the disaster area can inform his/her family who lives separately whether he/she is safe with easy operation. (Figure 4)



Figure 4: Safety confirmation.

- The receiver displays live streaming video from the fixed cameras located in the disaster area. (Figure 5)



Figure 5: Live streaming video from the cameras in the disaster area.

- A mobile terminal connected to Hybridcast receiver can get useful information for evacuation with the combination of Hybridcast applications. It can display, for example, an estimated water level of tsunami and a route to the nearest evacuation site from their homes. This terminal can be taken out during evacuation. (Figure 6)



Figure 6: Estimated water level of tsunami and route for evacuation center.

(2) On the following day and after

- ◇ The receiver displays local information about lifeline.
- ◇ A user can watch previous news programs anytime.
- Profitability of the project and/or its contribution to local entrepreneurial activities
- Specific strategies to respond to the needs of women, youth, handicapped, indigenous people and other marginalized or socially disadvantaged groups: Service providers can offer such information through implementation of the application and their services.
- Aspects of the project, which could be strengthened to enhance its effectiveness or sustainability maximizing the benefits of telecommunication infrastructure in rural and remote areas: As mentioned above, the system can potentially involve any kind of IP networks.
- Other observations
 - Unexpected results and/or lessons learned
 - Derived requirements | requests for the emergency telecommunication community
 - Anticipated near/long-term future plan

- Other source of information
 - Web
 - Important publications: IPTVFJ STD-0010, IPTVFJ STD-0011, ARIB STD-B24, Draft New Report ITU-R BT.[IBB-Report]
 - Others

6) drrr-i-140: Device Collaboration to Realize Resilient Information Sharing

Part I. Summary

- Country: Japan
- Title of use case: Device Collaboration to Realize Resilient Information Sharing
- Details of the person preparing the use case:
 - Name: Shunichi SEKO
 - Title: Researcher
 - Organization: NTT
 - Address: Hikarino-oka 1-1, Yokosuka-shi, Kanagawa, 239-0847, JAPAN
 - E-Mail: seko.shunichi[at]lab.ntt.co.jp
 - Website:
- Date of the submission: FG on Disaster Relief Systems, Network Resilience and Recovery, Chile, 23-25 October 2013
- ITU-T SG(s) to which you think your use case could be relevant: SG-2
- Status of use case:
 - ~~Operational~~ | ~~Completed~~ | **Research and Development**
 - If in operational, specify major deployment cases
- (Potential target) Location and population of the use case
 - Location (village, district, etc.) (or specify the target is city, rural, and/or countryside): Evacuation sites
 - Population of the project area:
- Relevant actors (played roles)
 - ~~end-users, private sector organizations, public sector organizations, national/local government, others~~
 - If others, please specify:
- Type of disaster: all types
 - ~~Cold-wave~~ | ~~Drought~~ | **Earthquake** | ~~Epidemie~~ | **Extratropical Cyclone** | ~~Fire~~ | **Flash Flood** | **Flood** | ~~Heat Wave~~ | ~~Insect Infestation~~ | ~~Land Slide~~ | ~~Mad Slide~~ | **Severe Local Storm** | ~~Snow Avalanche~~ | **Storm Surge** | ~~Tech. Disaster~~ | ~~Tropical Cyclone~~ | **Tsunami** | **Volcano** | ~~Wild Fire~~ | Other
 - if others, please specify:
- Type of use case
 - ~~Mitigation and prevention~~ | ~~preparedness~~ | ~~prediction and early warning~~ | ~~response~~ | ~~impact assessment~~ | **recovery** | ~~reconstruction (Relief)~~
 - ~~Wired local loop: Copper, optical fibre, etc. (customers' loop)~~ | **Wireless local loop (customers' loop)** | ~~Fixed wireless access (long distance)~~ | ~~Mobile wireless access~~ | ~~Satellite two-way communications: VSAT, etc.~~ | **Wireless LANS and IP-based related networks** | ~~Terrestrial voice, data, sound or television broadcasting~~ | ~~Satellite voice, data, sound or television broadcasting~~ | ~~Hybrid or combined technologies~~ | ~~Others~~
 - if others, please specify:

- Objective and/or achievements of the use case:
Make it possible to share information in/among evacuation sites without Internet access.
- summary of the use case indicating its expected social /economic impacts:
The platform can be implemented in HTML5. Thus, evacuees can use the service(platform) without preparation such as download and installation. In addition, it is possible for users to utilize the platform in daily life. For example, he/she can automatically get discount coupons by connecting to WiFi access point in shops. Therefore, this platform is useful in cases of disasters and daily life with their own mobile devices and WiFi access points.

Part II. Detail

- Overview of use case targets, objectives and financing
 - Objectives and implementation details of the use case including problem statement (tsunami, earthquake, drought, etc.):
 - ✧ After a disaster strike such as earthquake, tsunami and so on, people won't be able to access web sites due to failure of the network infrastructure. In disaster situations, it is important for victims to get information related to the disaster and to exchange personal status information. This contribution provides an ad-hoc distributed platform to exchange information among people without Internet access. Moreover, this platform is implemented with HTML5. Therefore, victims get and share information with web browsers and WiFi connections on common smartphone and tablets. Thus, this contribution makes it possible to share information without the Internet.
 - Brief description of the target country/region: geography, terrain, climate, demographics, socio-economic situation:
 - ✧ Regions whose Internet access is often disconnected by disasters, earthquake, typhoon and so on.
 - If any, technological improvement and its effects for providing new capabilities, reduced cost capital and operating cost solutions.
 - ✧ T.B.D.
- Infrastructure and regulatory environment
 - Infrastructure components: Necessary telecommunication facilities, transport access, electricity supply, distance to the nearest local exchange and/or IP network, human resources security.
 - ✧ User devices such as smartphones and devices that can configure local area networks such as wireless routers are necessary to share information. In addition, this platform use electricity supply, Internet access and cloud server depending on necessity.
 - Regulatory components: Necessary licence, frequency availability (for radio-based projects), and other regulatory issues
 - ✧ No necessary frequency licensing is required, because this platform use WiFi in unlicensed bands.
 - Other factors which influenced the operating environment (manufacturers, standards etc).
- Technical description of use case provided
 - Architecture, type of systems, main technical characteristics, frequencies (for radio-based projects), power consumption, performances (capacity, reliability, quality of service), network management, etc.,

- ◇ WiFi routers for connecting devices and managing local IP addresses.
 - ◇ Mobile devices or PCs for inputting and sharing information.
 - ◇ Web Server in local area network for providing html and javascript files on this platform.
- Installation and deployment: network planning, subscriber management, etc.
 - ◇ Device that has function of web server is installed this platform programs.
 - ◇ Mobile devices run web browser. (Regular web browsers are supported and so preinstalled)
- Interconnection to national networks/backbones/disaster response systems
 - ◇ Local Area Network
- Cost | financial aspects, if possible
 - Cost of the equipment, cost per line and cost of the operation of the system
 - ◇ T.B.D.
 - Cost of each terminal and cost of the service for the user.
 - ◇ T.B.D.
 - Financial aspects of the use case
 - ◇ T.B.D.
- Effectiveness and sustainability of the project
 - Effectiveness and benefits of the project for the targeted user groups
 - ◇ Users can get and send information related disaster using web browser and WiFi connection without Internet. In addition, municipality can municipality collect information such as effect of disaster and safety confirmation.
 - Profitability of the project and/or its contribution to local entrepreneurial activities
 - ◇ T.B.D.
 - Specific strategies to respond to the needs of women, youth, handicapped, indigenous people and other marginalized or socially disadvantaged groups
 - ◇ This platform permits customizing font size, font color and background color for elderly person and person with partial color blindness.
 - Aspects of the project, which could be strengthened to enhance its effectiveness or sustainability maximizing the benefits of telecommunication infrastructure in rural and remote areas.
 - ◇ T.B.D.
- Other observations
 - Unexpected results and/or lessons learned
 - ◇ T.B.D.
 - Derived requirements | requests for the emergency telecommunication community:
 - ◇ Privacy, Usability
 - Anticipated near/long-term future plan
 - ◇ T.B.D.
- Other source of information
 - Web
 - ◇ N/A
 - Important publications
 - ◇ N/A
 - Others
 - N/A

7) drnr-i-63: Introduction to a resilient network architecture based on Movable and Deployable Resource Unit (MDRU)

8) 5th Workshop, May 2013, Session 3-3, Resilient network architecture based on Movable and Deployable Resource Unit (MDRU)

7) and 8) deals with the same topic.

Part I. Summary.

- Country: Japan
- Title of use case: Movable and deployable ICT resource unit (MDRU) and ICT car
- Details of the person preparing the use case:
 - Name: Toshikazu Sakano
 - Title: Senior Research Engineer and Supervisor
 - Organization: Network Innovation Laboratories in NTT
 - Address: 1-1 Hikari-no-oka, Yokosuka, Kanagawa, 239-0847, Japan
 - E-Mail: sakano.toshikazu [at] lab.ntt.co.jp
 - Website:
- Date of the submission: February and May 2013
- ITU-T SG(s) to which you think your use case could be relevant: SG15
- Status of use case:
 - Operational | Completed | Research and Development: R&D (Trial machines have been implemented and are available)
 - If in operational, specify major deployment cases
- (Potential target) Location and population of the use case
 - Location (village, district, etc.) (or specify the target is city, rural, and/or countryside): Three sizes of implementations are available targeting at different disaster areas.
 - Population of the project area: The current implementations support 5,000 smartphone users via IP telephony.
- Relevant actors (played roles)
 - End-users, private sector organizations, public sector organizations, national/local government, others: Applicable to all actors above.
 - If others, please specify:
- Type of disaster

[EdNote: consider to edit this list. The list is easy to understand, but contains incidents that do not affect very much to telecom networks. Contributions invited.]

 - Cold wave | Drought | Earthquake | Epidemic | Extratropical Cyclone | Fire | Flash Flood | Flood | Heat Wave | Insect Infestation | Land Slide | Mud Slide | Severe Local Storm | Snow Avalanche | Storm Surge | Tech. Disaster | Tropical Cyclone | Tsunami | Volcano | Wild Fire | Other: Any disasters which damage a local switch office seriously and make it hard to recover in a short period of time.
 - if others, please specify:
- Type of use case
 - Mitigation and prevention | preparedness | prediction and early warning | response | impact assessment | recovery | reconstruction: Recovery
 - Wired local loop: Copper, optical fibre, etc. (customers' loop) | Wireless local loop (customers' loop) | Fixed wireless access (long distance) | Mobile wireless access | Satellite two-way communications: VSAT, etc. | Wireless LANs and IP-based related networks | Terrestrial voice, data, sound or television broadcasting | Satellite voice, data, sound or television broadcasting | Hybrid or combined technologies|

Others : Substitution for a local edge node which functions as a local telephone switch, edge node for Internet access, and data center and works with remaining network facilities

- if others, please specify:
- Objective and/or achievements of the use case: To replicate network functionalities lost by disaster or to increase network capacity to support the surge of post-disaster traffic by bringing a transportable package of ICT resources.
- Summary of the use case indicating its expected social/economic impacts: The current implementations prove three different implementations in size; the packages of big and middle size containers, which can be carried by truck, and a van-mounted package. The machine supports UNI-based public network connections, which allow public network operators for their networks' recovery as well as other organizations for support local communities in case of disaster.

Part II. Details.

- Overview of use case targets, objectives and financing
 - Objectives and implementation details of the use case including problem statement (tsunami, earthquake, drought, etc.): To replicate network functionalities lost by disaster or to increase network capacity to prepare for the surge of post-disaster traffic and prevent congestion, when a disaster occurs which damages a local switch office seriously and makes it hard to recover in a short period of time.
 - Brief description of the target country/region: geography, terrain, climate, demographics, socio-economic situation: Any counties including developing countries which needs new local networks
 - If any, technological improvement and its effects for providing new capabilities, reduced cost capital and operating cost solutions: The following improvements have been confirmed; (1) Prompt construction of a Wi-Fi access NW by using a sensor NW and intensively controlling the surrounding access point group, (2) Telephone service that is instantly available for use by easily registering your own smart phone, (3) Combination of plural MDRUs by forming a network based on them, which extends the service area and expands functionality, (4) Self-reliant operation of the ICT Car by introducing self-sustaining power supply system including a power generator and highly efficient air conditioner based on heat storage medium, (5) Special storage data transmission technique enables images and videos to be sent without stress even during network instability.
- Infrastructure and regulatory environment
 - Infrastructure components: Necessary telecommunication facilities, transport access, electricity supply, distance to the nearest local exchange and/or IP network, human resources, security: The machine works in the combination of remaining network facilities. It works independently from public networks as well.
 - Regulatory components: Necessary license, frequency availability (for radio-based projects), other regulatory issues: None.
 - Other factors which influenced the operating environment (manufacturers, standards etc). None.
- Technical description of use case provided
 - Architecture, type of systems, main technical characteristics, frequencies (for radio-based projects), power consumption, performances (capacity, reliability, quality of service), network management, etc.: The machine is designed for providing functionalities comparable with a local telephone switch, edge node for Internet access, and

- data center
- Installation and deployment: network planning, subscriber management, etc.: The machine is movable by ordinary transportations and quickly deployable in the destination.
- Interconnection to national networks/backbones/disaster response systems: The machine supports interconnections with remaining facilities including fibers and a UNI-based public network connection.
- Cost | financial aspects, if possible
 - Cost of the equipment, cost per line and cost of the operation of the system: Not yet decided.
 - Cost of each terminal and cost of the service for the user. Survived terminals are supposed to be used.
 - Financial aspects of the use case: It depends on the owner of the machine and use of it in normal situations.
- Effectiveness and sustainability of the project
 - Effectiveness and benefits of the project for the targeted user groups: Quick recovery of communication services around the devastated area
 - Profitability of the project and/or its contribution to local entrepreneurial activities: The machine can be used by local government or private sectors for their services in the normal situation
 - Specific strategies to respond to the needs of women, youth, handicapped, indigenous people and other marginalized or socially disadvantaged groups: An application for collecting and managing victim data is installed. People in evacuation centers can be promptly registered into the system's database with their information (name, address, sex, age, etc.) after uploading their face photos and document photos taken by a tablet PC with a camera. This data base becomes instantly available to management services, providing reassurance of personal safety about including people in the list above.
 - Aspects of the project, which could be strengthened to enhance its effectiveness or sustainability maximizing the benefits of telecommunication infrastructure in rural and remote areas: The machine can be used not only for disaster recovery but for new local network development.
- Other observations
 - Unexpected results and/or lessons learned: Confirmation of the importance of being used in a normal situation.
 - Derived requirements | requests for the emergency telecommunication community: To support user-friendly disaster relief applications taking aged people into account
 - Anticipated near/long-term future plan: Variation of physical size including a carrying trunk size (attaché case size ICT BOX). Small implementations playing as building blocks
- Other source of information
 - Web: NTT press release on ICT Car, <http://www.ntt.co.jp/news2014/1401e/140128a.html>
 - Important publications:
 - Others: The project is a winner of the ITU-MCMC (the Malaysian Communications and Multimedia Commission) Contest to Promote the Transformational Power of Broadband - Connecting at the Roots, <http://www.itu.int/en/ITU-D/Conferences/connect/Asia-Pacific/Pages/connect-at-the-roots.aspx>

9) drnrr-i-58: The Necessity and Flexibility of Portable Emergency Communication Systems (PECS)

Part I. Summary.

- Country: Turkey
- Title of use case: Portable Emergency Communication Systems (PECS)
- Details of the person preparing the use case:
 - Name: Levent Gerdan
 - Title: Coordinator (ISMEP-Component A)
 - Organization: Istanbul Project Coordination Unit
 - Address:
 - E-Mail: lgerdan@outlook.com
 - Website:
- Date of the submission: February 2013
- ITU-T SG(s) to which you think your use case could be relevant:
- Status of use case:
 - Operational | Completed | Research and Development
 - If in operational, specify major deployment cases
- (Potential target) Location and population of the use case
 - Location (village, district, etc.) (or specify the target is city, rural, and/or countryside)
 - Population of the project area
- Relevant actors (played roles)
 - end-users, private sector organizations, public sector organizations, national/local government, others
 - If others, please specify:
- Type of disaster

[EdNote: consider to edit this list. The list is easy to understand, but contains incidents that do not affect very much to telecom networks. Contributions invited.]

- Cold wave | Drought | Earthquake | Epidemic | Extratropical Cyclone | Fire | Flash Flood | Flood | Heat Wave | Insect Infestation | Land Slide | Mad Slide | Severe Local Storm | Snow Avalanche | Storm Surge | Tech. Disaster | Tropical Cyclone | Tsunami | Volcano | Wild Fire | Other
- if others, please specify:
- Type of use case
 - Mitigation and prevention | preparedness | prediction and early warning | response | impact assessment | recovery | reconstruction
 - Wired local loop: Copper, optical fibre, etc. (customers' loop) | Wireless local loop (customers' loop) | Fixed wireless access (long distance) | Mobile wireless access | Satellite two-way communications: VSAT, etc. | Wireless LANS and IP-based related networks | Terrestrial voice, data, sound or television broadcasting | Satellite voice, data, sound or television broadcasting | Hybrid or combined technologies | Others
 - if others, please specify:
- Objective and/or achievements of the use case: During emergencies and disasters, communication service disruptions are quite often and sometimes unavoidable. It is the responsibility of the public authorities to recover from such cases and this has to be done very quickly in order to gain control over the chaotic situations. During the recovery phase, "Portable Emergency Communication Systems (PECS)" may play an important and intermediate role to speed up the transition from the "communication lost" state to

“stable communication” state.

- Summary of the use case indicating its expected social /economic impacts: During emergencies and disasters, communication service disruptions are quite often and sometimes unavoidable. It is the responsibility of the public authorities to recover from such cases and this has to be done very quickly in order to gain control over the chaotic situations. During the recovery phase, “Portable Emergency Communication Systems (PECS)” may play an important and intermediate role to speed up the transition from the “communication lost” state to “stable communication” state.

Part II. Details.

- Overview of use case targets, objectives and financing
 - Objectives and implementation details of the use case including problem statement (tsunami, earthquake, drought, etc.):
 - Brief description of the target country/region: geography, terrain, climate, demographics, socio-economic situation:
 - If any, technological improvement and its effects for providing new capabilities, reduced cost capital and operating cost solutions.
- Infrastructure and regulatory environment
 - Infrastructure components: Necessary telecommunication facilities, transport access, electricity supply, distance to the nearest local exchange and/or IP network, human resources, security
 - Regulatory components: Necessary license, frequency availability (for radio-based projects), other regulatory issues
 - Other factors which influenced the operating environment (manufacturers, standards etc).
- Technical description of use case provided
 - Architecture, type of systems, main technical characteristics, frequencies (for radio-based projects), power consumption, performances (capacity, reliability, quality of service), network management, etc.,
 - Installation and deployment: network planning, subscriber management, etc.
 - Interconnection to national networks/backbones/disaster response systems
- Cost | financial aspects, if possible
 - Cost of the equipment, cost per line and cost of the operation of the system
 - Cost of each terminal and cost of the service for the user.
 - Financial aspects of the use case
- Effectiveness and sustainability of the project
 - Effectiveness and benefits of the project for the targeted user groups
 - Profitability of the project and/or its contribution to local entrepreneurial activities
 - Specific strategies to respond to the needs of women, youth, handicapped, indigenous people and other marginalized or socially disadvantaged groups
 - Aspects of the project, which could be strengthened to enhance its effectiveness or sustainability maximizing the benefits of telecommunication infrastructure in rural and remote areas.
- Other observations
 - Unexpected results and/or lessons learned
 - Derived requirements | requests for the emergency telecommunication community
 - Anticipated near/long-term future plan
- Other source of information
 - Web

- Important publications
- Others

2.7. Reconstruction

1) 2nd Workshop, Dec. 2012 Session3-2: Uninterrupted Secure Communication Project for Disaster Management

Part I. Summary.

- Country: Turkey
- Title of use case: Uninterrupted Secure Communication Project for Disaster Management
- Details of the person preparing the use case:
 - Name: ONUR DEMIRKOL
 - Title: Electronic and Communication Engineer
 - Organization: AFAD (Afet ve Acil Durum Yonetimi Baskanligi)
 - Address: N.A.
 - E-Mail: N.A.
 - Website: N.A.
- Date of the submission: 11 December, 2012 at ITU-T Workshop (Presentation 3-2)
- ITU-T SG(s) to which you think your use case could be relevant: TBD
- Status of use case:
 - Operational | Completed | Research and Development
 - If in operational, specify major deployment cases

TUBITAK Project: Administration of disaster and emergency services, to establish effective and efficient Disaster and Emergency Management Centers across the country that can be contacted by people in order to ensure seamless and secure communication (Uninterrupted Secure Communication). The work started with BİLGEM and will be assisted by TURKSAT.
- (Potential target) Location and population of the use case
 - Location (village, district, etc.) (or specify the target is city, rural, and/or countryside)
 - in the provinces, in some districts, and in some institutions/organizations
 - Population of the project area: N.A.
- Relevant actors (played roles)
 - end-users
 - private sector organizations
 - public sector organizations
 - national/local government

Disaster and Emergency Management Centers

 - others
 - If others, please specify:
- Type of disaster
 - Cold wave | Drought | Earthquake | Epidemic | Extratropical Cyclone | Fire | Flash Flood | Flood | Heat Wave | Insect Infestation | Land Slide | Mad Slide | Severe Local Storm | Snow Avalanche | Storm Surge | Tech. Disaster | Tropical Cyclone | Tsunami | Volcano | Wild Fire | Other

- if others, please specify:
 - Type of use case
 - Mitigation and prevention | preparedness | prediction and early warning | response | impact assessment | recovery | reconstruction

Disaster management, Early warning, Emergency response, Restoration, Repair, Re-construction

 - Wired local loop: Copper, optical fibre, etc. (customers' loop) | Wireless local loop (customers' loop) | Fixed wireless access (long distance) | Mobile wireless access | Satellite two-way communications: VSAT, etc. | Wireless LANS and IP-based related networks | Terrestrial voice, data, sound or television broadcasting | Satellite voice, data, sound or television broadcasting | Hybrid or combined technologies| Others

various communication environments, such as secure voice, data and video communication

 - if others, please specify:
 - Objective and/or achievements of the use case
 - Objectives
 - Achievements
 - summary of the use case indicating its expected social/economic impacts
- Establishment of Disaster and Emergency Management Centers, supported by Uninterrupted Secure Communication
- Related projects: “News Gathering and Dissemination System” and “Warning and Alarm Systems (Electronic Siren Systems)”

Part II. Details.

- Overview of use case targets, objectives and financing
 - Objectives and implementation details of the use case including problem statement (tsunami, earthquake, drought, etc.):
 - Brief description of the target country/region: geography, terrain, climate, demographics, socio-economic situation:
 - If any, technological improvement and its effects for providing new capabilities, reduced cost capital and operating cost solutions.
- Infrastructure and regulatory environment
 - Infrastructure components: N.A.
 - Necessary telecommunication facilities
 - transport access
 - electricity supply
 - distance to the nearest local exchange and/or IP network
 - human resources
 - security
 - Regulatory components: N.A.
 - Necessary license
 - frequency availability (for radio-based projects)
 - other regulatory issues
 - Other factors which influenced the operating environment (manufacturers, standards etc).
- Technical description of use case provided

- Architecture, type of systems, main technical characteristics, frequencies (for radio-based projects), power consumption, performances (capacity, reliability, quality of service), network management, etc.,
- Installation and deployment: network planning, subscriber management, etc.
- Interconnection to national networks/backbones/disaster response systems

[WHAT WE HAVE]

900 Satellite Phones from Thuraya

13 Cities have HF Radios

[WHAT WE NEED]

Redundant Links

Mobile VSATs

Disaster Prevention Radio System

Mobile Hybrid Generators

Crypto Devices

Strong Backbone

Link Between Disaster Zone and Everywhere

- Cost | financial aspects, if possible: N.A.
 - Cost of the equipment, cost per line and cost of the operation of the system
 - Cost of each terminal and cost of the service for the user.
 - Financial aspects of the use case
- Effectiveness and sustainability of the project: N.A.
 - Effectiveness and benefits of the project for the targeted user groups
 - Profitability of the project and/or its contribution to local entrepreneurial activities
 - Specific strategies to respond to the needs of women, youth, handicapped, indigenous people and other marginalized or socially disadvantaged groups
 - Aspects of the project, which could be strengthened to enhance its effectiveness or sustainability maximizing the benefits of telecommunication infrastructure in rural and remote areas.
- Other observations
 - Unexpected results and/or lessons learned
 - Derived requirements | requests for the emergency telecommunication community
 - Anticipated near/long-term future plan

Mobile command center

Redundant Links

Redundant Energy (Innovative Hybrid System with mobile container equipped with wind turbine, solar system, diesel generator, and battery)

Direct transmission from helicopter (Burst modem synchronization through blade rotation, Steady transmission everywhere without interruption from mountains or buildings, 19Mbps high-definition video transmission)

- Other source of information
 - Web
 - Important publications
 - Others

2) 2nd Workshop, Dec. 2012 Session3-3:IT in Disaster Relief & Rescue - Concept of Hitachi

=

Part I. Summary.

- Country: Japan
- Title of use case: IT in Disaster Relief & Rescue -- DamageVerification
- Details of the person preparing the use case:
 - Name: Bahadir Gultekin
 - Title: N.A.
 - Organization: Hitachi Solutions
 - Address: N.A.
 - E-Mail: N.A.
 - Website: N.A.
- Date of the submission: 11 December, 2012 at ITU-T Workshop (Presentation 3-3)
- ITU-T SG(s) to which you think your use case could be relevant: TBD
- Status of use case:
 - Operational
 - If in operational, specify major deployment cases: 2011 Japan Earthquake
- (Potential target) Location and population of the use case
 - Location (village, district, etc.) (or specify the target is city, rural, and/or countryside)
 - coast line affected by the earthquake and tsunami
 - Population of the project area: N.A.
- Relevant actors (played roles)
 - end-users
 - private sector organizations
 - public sector organizations
 - national/local government: Cabinet Office, local disaster headquarters, and municipal government
 - others
 - If others, please specify:
- Type of disaster
 - Earthquake | Tsunami
 - if others, please specify:
- Type of use case
 - Recontstruction
 - Wired local loop: Copper, optical fibre, etc. (customers' loop) | Wireless local loop (customers' loop) | Fixed wireless access (long distance) | Mobile wireless access | Satellite two-way communications: VSAT, etc. | Wireless LANS and IP-based related networks | Terrestrial voice, data, sound or television broadcasting | Satellite voice, data, sound or television broadcasting | Hybrid or combined technologies| Others
 - if others, please specify:
- Objective and/or achievements of the use case
 - Objectives
 - To Facilitate Damage Verification in Disaster Areas through Comparison of Maps and

Post-Disaster Satellite Imagery

➤ Achievements

Establishment of a system which delivers geographical information systems data in PDF format to facilitate viewing and adding information on the disaster area map.

The use of this system will facilitate the verification of housing damage to greatly simplify the administration of Disaster

Victim Certificates issued to property owners. The system can also be effectively used for reconstruction planning.

- summary of the use case indicating its expected social/economic impacts

See above.

Part II. Details: N.A.

- Overview of use case targets, objectives and financing
 - Objectives and implementation details of the use case including problem statement (tsunami, earthquake, drought, etc.):
 - Brief description of the target country/region: geography, terrain, climate, demographics, socio-economic situation:
 - If any, technological improvement and its effects for providing new capabilities, reduced cost capital and operating cost solutions.
- Infrastructure and regulatory environment
 - Infrastructure components:
 - Necessary telecommunication facilities
 - transport access
 - electricity supply
 - distance to the nearest local exchange and/or IP network
 - human resources
 - security
 - Regulatory components:
 - Necessary license
 - frequency availability (for radio-based projects)
 - other regulatory issues
 - Other factors which influenced the operating environment (manufacturers, standards etc).
- Technical description of use case provided
 - Architecture, type of systems, main technical characteristics, frequencies (for radio-based projects), power consumption, performances (capacity, reliability, quality of service), network management, etc.,
 - Installation and deployment: network planning, subscriber management, etc.
 - Interconnection to national networks/backbones/disaster response systems
- Cost | financial aspects, if possible
 - Cost of the equipment, cost per line and cost of the operation of the system
 - Cost of each terminal and cost of the service for the user.
 - Financial aspects of the use case
- Effectiveness and sustainability of the project
 - Effectiveness and benefits of the project for the targeted user groups
 - Profitability of the project and/or its contribution to local entrepreneurial activities
 - Specific strategies to respond to the needs of women, youth, handicapped, indigenous

- people and other marginalized or socially disadvantaged groups
- Aspects of the project, which could be strengthened to enhance its effectiveness or sustainability maximizing the benefits of telecommunication infrastructure in rural and remote areas.
- Other observations
 - Unexpected results and/or lessons learned
 - Derived requirements | requests for the emergency telecommunication community
 - Anticipated near/long-term future plan
- Other source of information
 - Web
 - Important publications
 - Others

3) drnrr-i-0200: Adding Information-Centric Networking as a component technology of “Disaster Relief Systems, Network Resilience and Recovery (DR&NRR): Promising technologies and use cases.”

Part I. Summary

- Country: Japan
- Title of use case: Middleware to Realize Application Invariance before and after Disaster
- Details of the person preparing the use case:
 - Name: Tohru Asami
 - Title: Professor
 - Organization: The University of Tokyo
 - Address: 7-3-1 Hongo, Bunkyo-ku, Tokyo 113-8656, JAPAN
 - E-Mail: asami[at]akg.t.u-tokyo.ac.jp
 - Website:
- Date of the submission: FG on Disaster Relief Systems, Network Resilience and Recovery, Suva, Fiji, 12-15 May 2014
- ITU-T SG(s) to which you think your use case could be relevant: SG-13
- Status of use case:
 - ~~Operational~~ | ~~Completed~~ | Research and Development
 - If in operational, specify major deployment cases
- (Potential target) Location and population of the use case
 - Location (village, district, etc.) (or specify the target is city, rural, and/or country-side): Evacuation sites which may be covered by a cell of a mobile network
 - Population of the project area:
 - The number of people within a cell, which is expected to be around 10 thousand or more.
- Relevant actors (played roles)
 - end-users, private sector organizations, public sector organizations, national/local government, others
 - If others, please specify:
- Type of disaster: all types
 - ~~Cold wave~~ | ~~Drought~~ | Earthquake | ~~Epidemie~~ | Extratropical Cyclone | ~~Fire~~ | Flash Flood | ~~Flood~~ | ~~Heat Wave~~ | ~~Insect Infestation~~ | Land Slide | ~~Mad Slide~~ | Severe Local Storm | Snow Avalance | Storm Surge | ~~Teeh. Disaster~~ | Tropical Cyclone | Tsunami | Volcano | Wild Fire | Other
 - if others, please specify: bombing campaigns

- Type of use case
 - ~~Mitigation and prevention | preparedness | prediction and early warning | response | impact assessment | recovery | reconstruction (Relief)~~
 - ~~Wired local loop: Copper, optical fibre, etc. (customers' loop) | Wireless local loop(customers' loop) | Fixed wireless access (long distance) | Mobile wireless access | Satellite two-way communications: VSAT, etc. | Wireless LANS and IP-based related networks | Terrestrial voice, data, sound or television broadcasting | Satellite voice, data, sound or television broadcasting | Hybrid or combined technologies | Others~~
 - if others, please specify:
- Objective and/or achievements of the use case:

Make it possible (1) to share information in/among evacuation sites in an isolated cell in a mobile network, using favorite application software like a social networking service (SNS), and to (2) to provide secure and energy efficient end-to-end communications with out any center server at a disaster.

- summary of the use case indicating its expected social /economic impacts:

A service of Information Centric Networking (ICN), as well as Data Aware Networking (ITU-T Recommendation Y.3033), can be implemented initially as an overlaying network over the existing networks such as the Internet, wide-area ethernets, device-to-device layer of LTE Direct, etc. The gradual increase of the number of ICN terminals/routers improves the efficiency of content delivery which contents delivery networks (CDNs) currently perform in the normal situation. At a disaster, ICN works as a secure connecting engine among the fragmented physical networks such as mobile network cells, Wi-Fi access points, etc. which lose the links to the wide-area networks. If an SNS is implemented as an ICN application, it runs even at thie disaster without any modifications, and can be used for safety confirmation purposes. ICN also provides secure end-to-end communications which is important at a disaster to prevent possible malicious activities such as sabotages.

Part II. Detail

- Overview of use case targets, objectives and financing
 - Objectives and implementation details of the use case including problem statement (tsunami, earthquake, drought, etc.):
 - ◇ After the Great East Japan Earthquake, many cells of mobile networks were off-the-air. 85% of failures were because of blackouts, 6% were because of physical base station crashes, and rest 9% were because of backhaul failures. Since 85% of the base station failures will be fixed if the government require mobile carriers to support one day operation of base station by secondary power sources. As for 9%, base stations mobile terminals are active though isolated from the core networks. The first 24 hours after the disaster are very important for safety confirmation. Even in this situation, people want to use a usually-used SNS application for this purpose. This is the first objective of this proposal. The second is to provide secure end-to-end communications to avoid possible malicious activities at a disaster. The third is that the communication traffic among terminals must be minimum since the available power, especially that of each terminal, is limited. As for the first objective, in ICN, an application is constructed based on named content chunks rather than IP packets. Once nodes (base stations and mobile terminals) are connected with each other though some media (Wi-Fi Direct,

LTE-Direct, DTN etc.), then the same application used before the disaster can be used. As for the second, every content chunk has a signature and can be encrypted. A secure communication is an embedded functionality. As for third, once a terminal retrieves a content chunk from a server, it is cached on all the nodes on the path between the terminal and the server. Succeededng accesses from other terminals to this content retrieve it from the nearest cache. This minimizes the network traffic. Once a cache is created, their availability of the physical server does not matter. Thus a sustainable service is also possible.

- Brief description of the target country/region: geography, terrain, climate, demographics, socio-economic situation:
 - ✧ Regions to lose Internet connections by a disaster such as earthquake, typhoon, bombing campaign and so on.
- If any, technological improvement and its effects for providing new capabilities, reduced cost capital and operating cost solutions.
 - ✧ 3GPP LTE Direct should have an API (Application Programming Interface) for Information Centric Networking services.
- Infrastructure and regulatory environment
 - Infrastructure components: Necessary telecommunication facilities, transport access, electricity supply, distance to the nearest local exchange and/or IP network, human resources security.
 - ✧ User devices such as smartphones and devices with Wi-Fi Direct or LTE Direct modes .
 - ✧ A base station with LTE Direct mode with a secondary power supply for its one day operation after the blackout. The existence of IP layer does not matter since ICN just requires connections between terminals.
 - Regulatory components: Necessary licence, frequency availability (for radio-based projects), and other regulatory issues
 - ✧ If communications among Wi-Fi Direct nodes do not require frequency licensing because of unlicensed Wi-Fi bands.
 - ✧ Better and wider communications are possible if a base station with LTE Direct can join these communications. No additional frequency license is required. It's only a matter of API standardization of LTE Direct.
 - ✧ Communication in an isolated cell cannot be controled by a mobile carrier in a real-time manner. Admitting such comercial services is a regulatory issues.
 - Other factors which influenced the operating environment (manufacturers, standards etc).
 - ✧ API of LTE Direct must be open to implement ICN related software on base stations. This is a matter of standardization of LTE Direct.
- Technical description of use case provided
 - Architecture, type of systems, main technical characteristics, frequencies (for radio-based projects), power consumption, performances (capacity, reliability, quality of service), network management, etc.,
 - ✧ ICN-aware mobile devices or PCs with Wi-Fi Direct or LTE Direct
 - ✧ ICN-aware base station with LTE Direct
 - ✧ SNS application on ICN for providing safety confirmation services for instance.
 - ✧ Wi-Fi routers may exist for better connections among devices.
 - Installation and deployment: network planning, subscriber management, etc.

- ◇ Mobile device with Wi-Fi Direct or LTE Direct must also install ICN related software modules.
 - ◇ Base stations of a mobile carrier must install ICN related software modules in addition to LTE Direct.
- Interconnection to national networks/backbones/disaster response systems
 - ◇ If there is one ICN router with a fixed Internet access port or an available mobile network access port, the interconnections to Web services on national networks/backbones or to disaster response systems are realized by a convertor between content names and URLs. .
- Cost | financial aspects, if possible
 - Cost of the equipment, cost per line and cost of the operation of the system
 - ◇ T.B.D.(Developing and installing ICN related software modules into base stations as well as mobile terminals are required.)
 - Cost of each terminal and cost of the service for the user.
 - ◇ T.B.D.
 - Financial aspects of the use case
 - ◇ T.B.D.
- Effectiveness and sustainability of the project
 - Effectiveness and benefits of the project for the targeted user groups
 - ◇ Users can exchange safety confirmations with mobile devices with Wi-Fi Direct or LTE Direct.
 - ◇ They can use their mobile terminals longer since the power consumption of a user terminal is minimum because of using caches
 - ◇ They can get rid of spoofing or other malicious activities that may happen at a disaster, since any content chunk has its signature and can be encrypted.
 - ◇ The transition from a normal operation (IP connecting networks) to a disaster operation is seamless for each user. ICN nodes can reconfigure their interconnecting media after the disaster and set up the routing domain of content chunks. Any explicit status change of the device by each user is not required.
 - ◇ The gateway between ICN services and Web services is relatively easy to construct. So a municipality can collect a lot of municipality information such as effect of disaster and safety confirmations from the Internet as well as the ICN services, and provide them to the people in evacuation shelters effectively through ICN service..
 - Profitability of the project and/or its contribution to local entrepreneurial activities
 - ◇ T.B.D. (It requires an agreement between a mobile carrier and an entrepreneur manager.)
 - Specific strategies to respond to the needs of women, youth, handicapped, indigenous people and other marginalized or socially disadvantaged groups
 - ◇ Most of SNS applications support customizing font size, font color and background color for elderly person and person with partial color blindness. We assume such kind of SNS application implemented by ICN.
 - Aspects of the project, which could be strengthened to enhance its effectiveness or sustainability maximizing the benefits of telecommunication infrastructure in rural and remote areas.
 - T.B.D. (Any communication link can be used by ICN nodes. ICN does not necessarily require IP setup on a link. This may be effective to use available communication media in rural and remote areas.)
- Other observations

- Unexpected results and/or lessons learned
 - ✧ T.B.D.
- Derived requirements | requests for the emergency telecommunication community:
 - ✧ Extra software modules are implemented in a mobile base station. These functionality must be standardized.
- Anticipated near/long-term future plan
 - ✧ As for the standardization activities, contributions in IETF CDNI WG, and in IRTF ICNRG are important. We have been sending researchers to these standardization activities.
 - ✧ To encourage the dissemination of ICN technology, it must be useful even in a usual situation. We identify an efficient MPEG content delivery is one of such applications. We propose MPEG Consortium a contribution on Metadata API Format for ICN.
- Other source of information
 - Web: GreenICN, <http://www.greenicn.org/>.
 - Important publications: <http://www.greenicn.org/deliverables/>.
 - Others: The project is a collaboration project started from 2013 between FP7 (EU) and NICT (Japan). To proceed this project, a consortium is organized among 12 institutes: Georg-August-Universität Göttingen (Germany), University College London (UK), Consorzio Nazionale Interuniversitario per le Telecomunicazioni (Italy), NEC Europe Ltd. (UK), CEDEO (Italy), Telekomunikacja Polska (Poland), The University of Tokyo (Japan), Osaka University (Japan), Waseda University (Japan), KDDI R&D Laboratories Inc. (Japan), NEC Corporation (Japan), Panasonic Advanced Technology Development Co., Ltd. (Japan)

Appendix I

Templates of use cases

This appendix provides the blank template used in the clause 5 of this document.

Part I. Summary.

- Country
- Title of use case
- Details of the person preparing the use case:
 - Name:
 - Title:
 - Organization:
 - Address:
 - E-Mail:
 - Website:
- Date of the submission:
- ITU-T SG(s) to which you think your use case could be relevant:
- Status of use case:
 - Operational | Completed | Research and Development
 - If in operational, specify major deployment cases
- (Potential target) Location and population of the use case
 - Location (village, district, etc.) (or specify the target is city, rural, and/or countryside)
 - Population of the project area
- Relevant actors (played roles)
 - end-users, private sector organizations, public sector organizations, national/local government, others
 - If others, please specify:
- Type of disaster

[EdNote: consider to edit this list. The list is easy to understand, but contains incidents that do not affect very much to telecom networks. Contributions invited.]

 - Cold wave | Drought | Earthquake | Epidemic | Extratropical Cyclone | Fire | Flash Flood | Flood | Heat Wave | Insect Infestation | Land Slide | Mad Slide | Severe Local Storm | Snow Avalanche | Storm Surge | Tech. Disaster | Tropical Cyclone | Tsunami | Volcano | Wild Fire | Other
 - if others, please specify:
- Type of use case
 - Mitigation and prevention | preparedness | prediction and early warning | response | impact assessment | recovery | reconstruction
 - Wired local loop: Copper, optical fibre, etc. (customers' loop) | Wireless local loop (customers' loop) | Fixed wireless access (long distance) | Mobile wireless access | Satellite two-way communications: VSAT, etc. | Wireless LANS and IP-based related networks | Terrestrial voice, data, sound or television broadcasting | Satellite voice, data, sound or television broadcasting | Hybrid or combined technologies | Others
 - if others, please specify:

- Objective and/or achievements of the use case
- summary of the use case indicating its expected social /economic impacts

Part II. Details.

- Overview of use case targets, objectives and financing
 - Objectives and implementation details of the use case including problem statement (tsunami, earthquake, drought, etc.):
 - Brief description of the target country/region: geography, terrain, climate, demographics, socio-economic situation:
 - If any, technological improvement and its effects for providing new capabilities, reduced cost capital and operating cost solutions.
 - Infrastructure and regulatory environment
 - Infrastructure components: Necessary telecommunication facilities, transport access, electricity supply, distance to the nearest local exchange and/or IP network, human resources, security
 - Regulatory components: Necessary license, frequency availability (for radio-based projects), other regulatory issues
 - Other factors which influenced the operating environment (manufacturers, standards etc).
 - Technical description of use case provided
 - Architecture, type of systems, main technical characteristics, frequencies (for radio-based projects), power consumption, performances (capacity, reliability, quality of service), network management, etc.,
 - Installation and deployment: network planning, subscriber management, etc.
 - Interconnection to national networks/backbones/disaster response systems
 - Cost | financial aspects, if possible
 - Cost of the equipment, cost per line and cost of the operation of the system
 - Cost of each terminal and cost of the service for the user.
 - Financial aspects of the use case
 - Effectiveness and sustainability of the project
 - Effectiveness and benefits of the project for the targeted user groups
 - Profitability of the project and/or its contribution to local entrepreneurial activities
 - Specific strategies to respond to the needs of women, youth, handicapped, indigenous people and other marginalized or socially disadvantaged groups
 - Aspects of the project, which could be strengthened to enhance its effectiveness or sustainability maximizing the benefits of telecommunication infrastructure in rural and remote areas.
 - Other observations
 - Unexpected results and/or lessons learned
 - Derived requirements | requests for the emergency telecommunication community
 - Anticipated near/long-term future plan
 - Other source of information
 - Web
 - Important publications
 - Others
-