



INTERNATIONAL TELECOMMUNICATION UNION

CCITT

THE INTERNATIONAL
TELEGRAPH AND TELEPHONE
CONSULTATIVE COMMITTEE

E.170

(11/1988)

SERIES E: OVERALL NETWORK OPERATION,
TELEPHONE SERVICE, SERVICE OPERATION AND
HUMAN FACTORS

Operation, numbering, routing and mobile service –
International operation –
International routing plan

Traffic routing

Reedition of CCITT Recommendation E.170 published in
the Blue Book, Fascicle II.2 (1988)

NOTES

1 CCITT Recommendation E.170 was published in Fascicle II.2 of the *Blue Book*. This file is an extract from the *Blue Book*. While the presentation and layout of the text might be slightly different from the *Blue Book* version, the contents of the file are identical to the *Blue Book* version and copyright conditions remain unchanged (see below).

2 In this Recommendation, the expression “Administration” is used for conciseness to indicate both a telecommunication administration and a recognized operating agency.

Recommendation E.170

TRAFFIC ROUTING

1 Introduction

1.1 Objective of traffic routing

The objective of routing is to establish a successful connection between any two exchanges in the network. The function of traffic routing is the selection of a particular circuit group, for a given call attempt or traffic stream, at an exchange in the network. Thus, the selection of individual circuits within a circuit group is not considered in this Recommendation. The choice of a circuit group may be affected by information on the availability of downstream elements of the network.

1.2 Scope of Recommendation

This Recommendation takes account of the range of new traffic routing and control techniques which are provided by stored program controlled (SPC) exchanges and common channel signalling systems.

Additional routing information is contained in Recommendation E.171 (International telephone routing plan) and Recommendation E.172 (Call routing in the ISDN era).

Failure or overload conditions may require temporary changes to routing patterns or algorithms. This is considered to be a network management action and is described in the E.400 Series Recommendations.

1.3 Network topology

1.3.1 Network elements

A network comprises a number of nodes (switching centres) interconnected by circuit groups (engineering routes). There may be several direct circuit groups between a pair of nodes and these may be unidirectional or bothway. Figure 1/E.170 illustrates a number of possible situations.

A direct route consists of one or more circuit groups connecting adjacent nodes. An indirect route is a series of circuit groups connecting two nodes providing an end-to-end connection via other nodes.

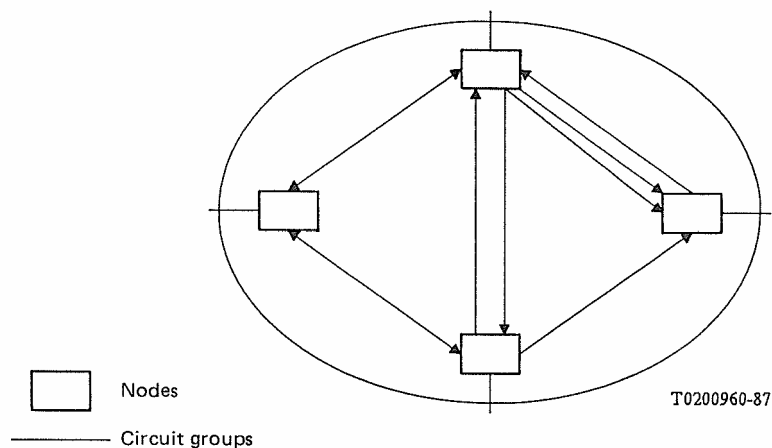

FIGURE 1/E.170

1.3.2 Network architecture

Within national networks it is often appropriate to adopt a hierarchy of switching units (e.g. local, area, trunk, regional trunk, international) with each level of the hierarchy performing different functions. For the international network, there is no recommended hierarchy for international switching centres (ISCs) with Administrations being free to determine the most suitable utilization of their individual ISCs. (Recommendation E.171 refers.)

2 Logic of routing

2.1 Routing structure

It is important to note that the concept of hierarchical routing need not be directly related to the concept of a hierarchy of switching centres (as described above).

A routing structure is hierarchical if, for all streams, all calls offered to a given route, at a specific node, overflow to the same set of routes irrespective of the routes already tested. The routes in the set will always be tested in the same sequence although some routes may not be available for certain call types. The last choice route is final in the sense that no traffic streams using this route may overflow further.

A routing structure is non-hierarchical if it violates the above-mentioned definition (e.g., mutual overflow between circuit groups originating at the same exchange).

An example of hierarchical routing in a non-hierarchical network of exchanges is illustrated in Figure 2/E.170.

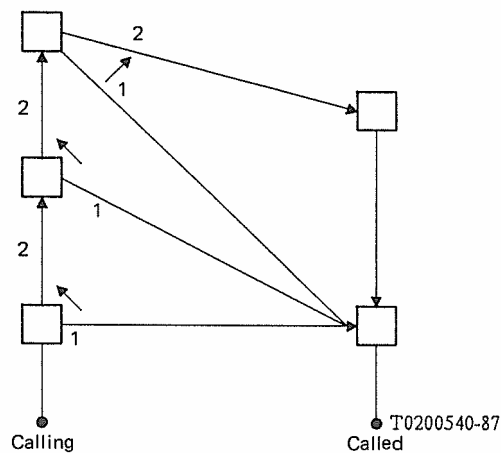

Note – All nodes are of equal status.

FIGURE 2/E.170

2.2 Routing scheme

The routing scheme defines how a set of routes is made available for calls between a pair of nodes.

Fixed: The set of routes in the routing pattern is always the same.

Dynamic: The set of routes in the routing pattern varies.

2.2.1 Fixed routing scheme

Routing patterns in the networks may be fixed, in that changes to the route choices for a given type of call attempt require manual intervention. Changes then represent a “permanent” change to the routing scheme (e.g., the introduction of new routes require a change to a fixed routing scheme).

2.2.2 Dynamic routing schemes

Routing schemes may also incorporate frequent automatic variations. Such changes may be time and/or state dependent.

The updating of routing patterns may take place periodically or aperiodically, predetermined or depending on the state of the network.

Time-dependent routing:

Routing patterns will be altered at fixed times during the day (or week) to allow changing traffic demands to be provided for. It is important to note that these changes are pre-planned and will be implemented consistently over a long time period.

State-dependent routing:

Routing patterns will vary automatically according to the state of the network. Such routing schemes are said to be adaptive.

In order to support this type of routing scheme, it is necessary to collect information about the status of the network. For example, each exchange may compile records of successful calls or outgoing trunk group occupancies. This information may be distributed through the network to other exchanges or passed to a centralized database.

Based on this network status information, routing decisions will be made either in each exchange or at a central processor serving all exchanges. See Figure 3/E.170.

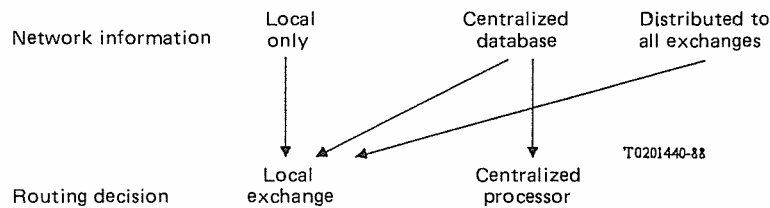

FIGURE 3/E.170

2.3 Route selection

Route selection is the action to actually select a definite route for a specific call.

Sequential: The routes in a set are always tested in sequence and the first available route is chosen.

Non-sequential: The routes in a set are tested in no specific order.

The decision to select a route can be based on the state of the outgoing circuit group or the states of the series of circuit groups in the route. In either case, it can also be based on the incoming path of entry, class of service, or type of call to be routed. One example of the above is selective trunk reservation.

3 Call control procedures

Call control procedures define the entire set of interactive signals necessary to establish, maintain and release a connection between exchanges. Described below are two main types of call control procedures:

3.1 Progressive call control

Progressive call control uses link-by-link signalling to pass supervisory controls sequentially from one exchange to the next. This type of call control can be either irreversible or reversible. In the irreversible case, call control is always passed downstream towards the destination exchange. Call control is reversible when it can be passed backwards (maximum one node), towards the originating exchange, using automatic rerouting or crankback possibilities.

3.2 Originating call control

Originating call control requires that the originating exchange maintain control of the call set-up until a connection between the originating and terminating exchanges has been completed.

4 Applications

4.1 Automatic alternative routing

A particular type of progressive (irreversible) routing is automatic alternative routing (AAR). When an exchange has the option of using more than one route to the next exchange, an alternative routing scheme can be employed.

Two main types are available:

- when there is a choice of direct circuit groups between the two exchanges;
- when there is a choice of direct and indirect routes between the two exchanges.

Alternative routing takes place when all appropriate circuits in a group are busy. Several circuit groups may be tested sequentially. The testing order will be fixed or time-dependent.

4.2 Automatic rerouting (crankback)

Automatic rerouting (ARR) takes place upon receipt of a signal at A from a downstream exchange B, indicating that a call once routed to B encountered an “all circuits busy” state on circuit groups out of that exchange. This application is also referred to as crankback.

In the example of Figure 4/E.170, a call from A to D is routed via C because the circuit group BD is congested.

With ARR, care must be taken to avoid circular routings which return the call to the point at which blocking occurred.

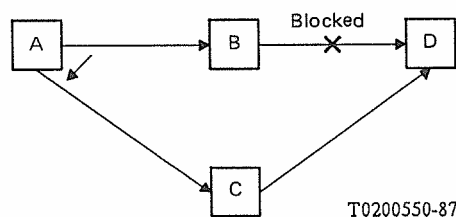
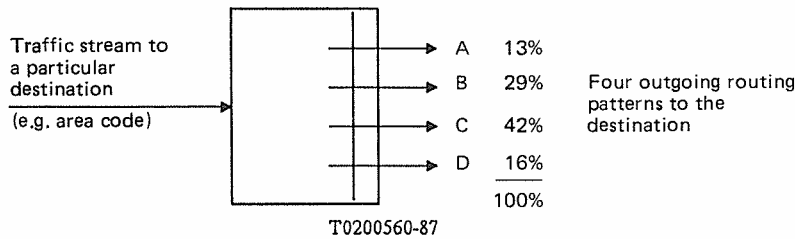

FIGURE 4/E.170

4.3 Load sharing

All routing schemes result in the sharing of traffic load between network elements. Routing schemes can however be developed to ensure that call attempts are offered to route choices according to a preplanned distribution.

Figure 5/E.170 illustrates this application of load sharing which can be made available as a software function of SPC exchanges. The system works by distributing the call attempts to a particular destination in a fixed ratio between the specified outgoing routing patterns.



Note – Each outgoing routing pattern (A, B, C, D) may include alternative routing options.

FIGURE 5/E.170

4.4 Dynamic routing

4.4.1 Example of state-dependent routing

A centralized routing processor is employed to select optimum routing patterns on the basis of the actual occupancy levels of the circuit groups and exchanges in the network which are monitored on a periodical basis (e.g., 10 s), see Figure 6/E.170. In addition, qualitative traffic parameters may also be taken into consideration in the determination of the optimal routing pattern.

This routing technique inherently incorporates fundamental principles of network management in determining routing patterns. These include:

- avoiding occupied circuit groups,
- not using overloaded exchanges for transit,
- in overload circumstances, restriction of routing direct connections.

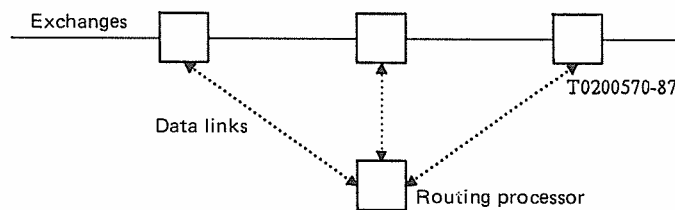

FIGURE 6/E.170

4.4.2 Example of time-dependent routing

For each originating and terminating exchange pair, a particular route pattern is planned depending on the time of day and day of week, see Figure 7/E.120. A weekday, for example, can be divided into different time periods, with each time period resulting in different route patterns being defined to route traffic streams between the same pair of exchanges.

This type of routing takes advantage of idle circuit capacity in other possible routes between the originating and terminating exchanges which may exist due to non-coincident busy periods. Crankback may be utilized to identify downstream blocking on the second link of each two-link alternative path.

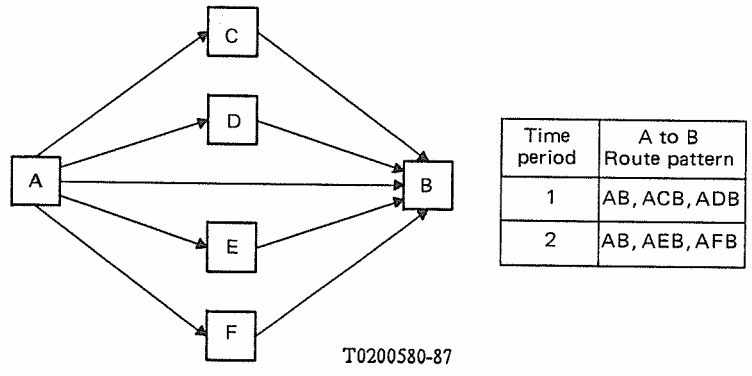

FIGURE 7/E.170

ITU-T E-SERIES RECOMMENDATIONS
**OVERALL NETWORK OPERATION, TELEPHONE SERVICE,
 SERVICE OPERATION AND HUMAN FACTORS**

OPERATION, NUMBERING, ROUTING AND MOBILE SERVICES

INTERNATIONAL OPERATION

Definitions	E.100–E.103
General provisions concerning Administrations	E.104–E.119
General provisions concerning users	E.120–E.139
Operation of international telephone services	E.140–E.159
Numbering plan of the international telephone service	E.160–E.169

International routing plan	E.170–E.179
-----------------------------------	--------------------

Tones in national signalling systems	E.180–E.189
Numbering plan of the international telephone service	E.190–E.199
Maritime mobile service and public land mobile service	E.200–E.229

OPERATIONAL PROVISIONS RELATING TO CHARGING AND ACCOUNTING IN THE INTERNATIONAL TELEPHONE SERVICE

Charging in the international telephone service	E.230–E.249
Measuring and recording call durations for accounting purposes	E.260–E.269

UTILIZATION OF THE INTERNATIONAL TELEPHONE NETWORK FOR NON-TELEPHONY APPLICATIONS

General	E.300–E.319
Phototelegraphy	E.320–E.329

ISDN PROVISIONS CONCERNING USERS

International routing plan	E.350–E.399
----------------------------	-------------

QUALITY OF SERVICE, NETWORK MANAGEMENT AND TRAFFIC ENGINEERING

NETWORK MANAGEMENT

International service statistics	E.400–E.409
International network management	E.410–E.419
Checking the quality of the international telephone service	E.420–E.489

TRAFFIC ENGINEERING

Measurement and recording of traffic	E.490–E.505
Forecasting of traffic	E.506–E.509
Determination of the number of circuits in manual operation	E.510–E.519
Determination of the number of circuits in automatic and semi-automatic operation	E.520–E.539
Grade of service	E.540–E.599
Definitions	E.600–E.649
ISDN traffic engineering	E.700–E.749
Mobile network traffic engineering	E.750–E.799

QUALITY OF TELECOMMUNICATION SERVICES: CONCEPTS, MODELS, OBJECTIVES AND DEPENDABILITY PLANNING

Terms and definitions related to the quality of telecommunication services	E.800–E.809
Models for telecommunication services	E.810–E.844
Objectives for quality of service and related concepts of telecommunication services	E.845–E.859
Use of quality of service objectives for planning of telecommunication networks	E.860–E.879
Field data collection and evaluation on the performance of equipment, networks and services	E.880–E.899

ITU-T RECOMMENDATIONS SERIES

Series A	Organization of the work of the ITU-T
Series B	Means of expression: definitions, symbols, classification
Series C	General telecommunication statistics
Series D	General tariff principles
Series E	Overall network operation, telephone service, service operation and human factors
Series F	Non-telephone telecommunication services
Series G	Transmission systems and media, digital systems and networks
Series H	Audiovisual and multimedia systems
Series I	Integrated services digital network
Series J	Transmission of television, sound programme and other multimedia signals
Series K	Protection against interference
Series L	Construction, installation and protection of cables and other elements of outside plant
Series M	TMN and network maintenance: international transmission systems, telephone circuits, telegraphy, facsimile and leased circuits
Series N	Maintenance: international sound programme and television transmission circuits
Series O	Specifications of measuring equipment
Series P	Telephone transmission quality, telephone installations, local line networks
Series Q	Switching and signalling
Series R	Telegraph transmission
Series S	Telegraph services terminal equipment
Series T	Terminals for telematic services
Series U	Telegraph switching
Series V	Data communication over the telephone network
Series X	Data networks and open system communications
Series Y	Global information infrastructure and Internet protocol aspects
Series Z	Languages and general software aspects for telecommunication systems