



INTERNATIONAL TELECOMMUNICATION UNION

ITU-T

TELECOMMUNICATION
STANDARDIZATION SECTOR
OF ITU

E.501

(05/97)

SERIES E: OVERALL NETWORK OPERATION,
TELEPHONE SERVICE, SERVICE OPERATION AND
HUMAN FACTORS

Quality of service, network management and traffic
engineering – Traffic engineering – Measurement and
recording of traffic

Estimation of traffic offered in the network

ITU-T Recommendation E.501

(Previously CCITT Recommendation)

ITU-T E-SERIES RECOMMENDATIONS

OVERALL NETWORK OPERATION, TELEPHONE SERVICE, SERVICE OPERATION AND HUMAN FACTORS

OPERATION, NUMBERING, ROUTING AND MOBILE SERVICES

INTERNATIONAL OPERATION	E.100–E.229
OPERATIONAL PROVISIONS RELATING TO CHARGING AND ACCOUNTING IN THE INTERNATIONAL TELEPHONE SERVICE	E.230–E.299
UTILIZATION OF THE INTERNATIONAL TELEPHONE NETWORK FOR NON-TELEPHONY APPLICATIONS	E.300–E.329
ISDN PROVISIONS CONCERNING USERS	E.330–E.399

QUALITY OF SERVICE, NETWORK MANAGEMENT AND TRAFFIC ENGINEERING

NETWORK MANAGEMENT	E.400–E.489
International service statistics	E.400–E.409
International network management	E.410–E.419
Checking the quality of the international telephone service	E.420–E.489

TRAFFIC ENGINEERING	E.490–E.799
---------------------	-------------

Measurement and recording of traffic E.490–E.505

Forecasting of traffic	E.506–E.509
Determination of the number of circuits in manual operation	E.510–E.519
Determination of the number of circuits in automatic and semi-automatic operation	E.520–E.539
Grade of service	E.540–E.599
Definitions	E.600–E.699
ISDN traffic engineering	E.700–E.749
Mobile network traffic engineering	E.750–E.799

QUALITY OF TELECOMMUNICATION SERVICES: CONCEPTS, MODELS, OBJECTIVES AND DEPENDABILITY PLANNING E.800–E.899

Terms and definitions related to the quality of telecommunication services	E.800–E.809
Models for telecommunication services	E.810–E.844
Objectives for quality of service and related concepts of telecommunication services	E.845–E.859
Use of quality of service objectives for planning of telecommunication networks	E.860–E.879
Field data collection and evaluation on the performance of equipment, networks and services	E.880–E.899

For further details, please refer to ITU-T List of Recommendations.

ITU-T RECOMMENDATION E.501

ESTIMATION OF TRAFFIC OFFERED IN THE NETWORK

Summary

This Recommendation contains estimation procedures for the traffic offered to a circuit-switched network. Methods to estimate the traffic offered to a circuit group and the origin-destination traffic, based on circuit group measurements, are described.

Source

ITU-T Recommendation E.501 was revised by ITU-T Study Group 2 (1997-2000) and was approved under the WTSC Resolution No. 1 procedure on the 26th of May 1997.

FOREWORD

ITU (International Telecommunication Union) is the United Nations Specialized Agency in the field of telecommunications. The ITU Telecommunication Standardization Sector (ITU-T) is a permanent organ of the ITU. The ITU-T is responsible for studying technical, operating and tariff questions and issuing Recommendations on them with a view to standardizing telecommunications on a worldwide basis.

The World Telecommunication Standardization Conference (WTSC), which meets every four years, establishes the topics for study by the ITU-T Study Groups which, in their turn, produce Recommendations on these topics.

The approval of Recommendations by the Members of the ITU-T is covered by the procedure laid down in WTSC Resolution No. 1.

In some areas of information technology which fall within ITU-T's purview, the necessary standards are prepared on a collaborative basis with ISO and IEC.

NOTE

In this Recommendation, the expression "Administration" is used for conciseness to indicate both a telecommunication administration and a recognized operating agency.

INTELLECTUAL PROPERTY RIGHTS

The ITU draws attention to the possibility that the practice or implementation of this Recommendation may involve the use of a claimed Intellectual Property Right. The ITU takes no position concerning the evidence, validity or applicability of claimed Intellectual Property Rights, whether asserted by ITU members or others outside of the Recommendation development process.

As of the date of approval of this Recommendation, the ITU had/had not received notice of intellectual property, protected by patents, which may be required to implement this Recommendation. However, implementors are cautioned that this may not represent the latest information and are therefore strongly urged to consult the TSB patent database.

© ITU 1997

All rights reserved. No part of this publication may be reproduced or utilized in any form or by any means, electronic or mechanical, including photocopying and microfilm, without permission in writing from the ITU.

CONTENTS

		<i>Page</i>
1	Introduction	1
2	Scope	2
3	References	2
4	Only-path circuit group	2
	4.1 No significant congestion	2
	4.2 Significant congestion	2
5	High-usage/final circuit group arrangement.....	3
	5.1 High-usage group with no significant congestion on the final group	3
	5.2 High-usage group with significant congestion on the final group	3
6	Origin-destination equivalent traffic offered.....	4
	6.1 Determination of origin-destination traffic offered when origin-destination traffic measurements on the totality of call attempts are available	4
	6.2 Determination of origin-destination traffic offered when origin-destination traffic measurements only on a sampling basis are available.....	4
	6.3 Determination of origin-destination traffic offered when only circuit-group based measurements of traffic intensity are available	4
7	History.....	5
8	Bibliography.....	5
	Annex A – A simplified model for the formula presented in 4.2	5
	Annex B – Equivalent traffic offered	10
	Annex C – Methods for determination of origin-destination traffic offered when only the measurements of traffic intensity on circuit group basis are available	10
	C.1 Notation, derivation, and solution of Formula 6-1 in 6.3	10
	C.2 The pseudo-inverse.....	12
	C.3 The iterative algorithm.....	12
	Bibliography.....	14
	Annex D – Examples of application of the methods described in Annex C	14
	D.1 Example 1	14
	D.2 Example 2	16
	Annex E – A sample performance evaluation of the pseudo-inverse and of the iterative algorithm	19

ESTIMATION OF TRAFFIC OFFERED IN THE NETWORK

(revised 1997)

1 Introduction

For planning the growth of the network, the following quantities must be estimated from measurements:

- traffic offered to circuit groups;
- traffic offered to destinations, on an origin-destination basis;
- traffic offered to exchanges;
- call attempts offered to exchanges;
- traffic offered to signalling links.

These quantities are normally estimated from measurements of busy-hour carried traffic and call attempts, but there are a number of factors which may need to be taken into account within the measurement and estimation procedures:

- a) Measurements may need to be subdivided, e.g. on a destination basis, or by call type (for example, calls using different signalling systems).
- b) It may not be possible to obtain a complete record of traffic carried. For example, in a network with high usage and final groups, it may not be possible to measure the traffic overflowing from each high usage group.
- c) Measurements may be affected by congestion. This will generally result in a decrease in traffic carried, but the decrease may be affected by customer's repeat attempts and by the actions (for example, automatic repeat attempts) of other network components.
- d) When high levels of congestion persist for a lengthy period (many days), some customers may avoid making calls during the congested period of each day. This apparent missing component of offered traffic is known as suppressed traffic. It should be taken into account in planning since the offered traffic will increase when the equipment is augmented. At present, suitable algorithms for estimating suppressed traffic have not been defined.

Three situations should be distinguished:

- i) Congestion upstream of the measurement point – This is not directly observable.
- ii) Congestion due to the measured equipment – Congestion measurements should be used to detect this.
- iii) Congestion downstream of the measurement point – This can often be detected from measurements of ineffective traffic or completion ratio. Note that where groups are both way, congestion elsewhere in the network may be both upstream and downstream of the measurement point for different parcels of traffic.

When congestion is due to the measured equipment, this must be properly accounted for in the estimation of traffic offered which is used for planning the growth of the measured equipment.

When congestion arises elsewhere in the network, the planner needs to consider whether or not the congestion will remain throughout the considered planning period. This may be difficult if he does not have control of the congested equipment.

This Recommendation presents estimation procedures for two of the situations described above. Clauses 4 and 5 have the aim of the determination of traffic offered to circuit group, and namely clause 4 deals with the estimation of traffic offered to a fully-operative only-path circuit group which may be in significant congestion. Clause 5 deals with a high-usage and final group arrangement with no significant congestion. Clause 6 provides a procedure to determine traffic offered to destinations on an origin-destination basis, when only measurements of traffic intensity on circuit groups are available or when direct measurements on origin-destination traffic offered are also available.

In clause 6 the estimated traffic offered is the "equivalent traffic offered" used in the pure lost call model as defined in Annex B, while in clauses 4 and 5 in the evaluation of traffic offered, the user's repeat attempts are taken into account.

These estimation procedures should be applied to individual busy-hour measurements. The resulting estimates of traffic offered in each hour should then be accumulated according to the procedures described in Recommendation E.500.

2 Scope

This Recommendation provides means of estimating the traffic offered to circuit groups based on measurements of traffic carried and means of estimating origin-destination traffic flows based on circuit group measurements.

3 References

The following ITU-T Recommendations and other references contain provisions which, through reference in this text, constitute provisions of this Recommendation. At the time of publication, the editions indicated were valid. All Recommendations and other references are subject to revision; all users of this Recommendation are therefore encouraged to investigate the possibility of applying the most recent edition of the Recommendations and other references listed below. A list of the currently valid ITU-T Recommendations is regularly published.

- CCITT Recommendation E.500 (1992), *Traffic intensity measurement principles*.
- CCITT Recommendation E.502 (1992), *Traffic measurement requirements for digital telecommunication exchanges*.

4 Only-path circuit group

4.1 No significant congestion

Traffic offered will equal traffic carried measured according to Recommendation E.500. No estimation is required.

4.2 Significant congestion

Let A_C be the *traffic carried* on the circuit group. Then, on the assumption that augmentation of the circuit group would have no effect on the mean holding time of calls carried or on the completion ratio of calls carried, the *traffic offered* to the circuit group may be expressed as:

$$A = A_C \frac{(1 - WB)}{(1 - B)} \quad (4-1)$$

where B is the present average loss probability for all call attempts to the considered circuit group, and W is a parameter representing the effect of call repetitions. Models for W are presented in Annex A.

To facilitate the quick determination of offered traffic according to the approximate procedure in Annex A, Table A.1 including numerical values of the factor $(1 - WB)/(1 - B)$ was prepared for a wide range of B , H and r' (for the definition of H and r' , see Annex A). For the use of Table A.1, see Note 2 in Annex A.

NOTE 1 – Annex A gives a derivation of this relationship, and also describes a more complex model which may be of use when measurements of completion ratios are available.

NOTE 2 – When measurements of completion ratios are not available a W value may be selected from the range 0.6 to 0.9. It should be noted that a lower value of W corresponds to a higher estimate of traffic offered. Administrations are encouraged to exchange the values of W that they propose to use.

NOTE 3 – Administrations should maintain records of data collected before and after augmentations of circuit groups. This data will enable a check on the validity of the above formula, and on the validity of the value of W used.

NOTE 4 – In order to apply this formula, it is normally assumed that the circuit group is in a fully operative condition or that any faulty circuits have been taken out of service. If faulty circuits or faulty transmission or signalling equipment associated with these circuits remain in service, then the formula may give incorrect results.

5 High-usage/final circuit group arrangement

5.1 High-usage group with no significant congestion on the final group

5.1.1 Where a relation is served by a high-usage and final group arrangement, it is necessary to take simultaneous measurements on both circuit groups.

Let A_H be the traffic carried on the high-usage group, and A_F the traffic overflowing from this high-usage group and carried on the final group. With no significant congestion on the final group, the traffic offered to the high-usage group is:

$$A = A_H + A_F \quad (5-1)$$

5.1.2 Two distinct types of procedure are recommended, each with several possible approaches. The method given in 5.1.2.1 a) is preferred because it is the most accurate, although it may be the most difficult to apply. The methods of 5.1.2.2 may be used as additional estimates.

5.1.2.1 Simultaneous measurements are taken of A_H and the total traffic carried on the final group. Three methods are given for estimating A_F , in decreasing order of preference:

- a) A_F is measured directly. In most circumstances this may be achieved by measuring traffic carried on the final group on a destination basis.
- b) The total traffic carried on the final group is broken down by destination in proportion to the number of effective calls to each destination.
- c) The traffic carried on the final group is broken down according to ratios between the bids from the high-usage groups and the total number of bids to the final group.

5.1.2.2 Two alternative methods are given for estimating the traffic offered to the high-usage group which, in this circumstance, equals the equivalent traffic offered:

- a) A is estimated from the relationship:

$$A_H = A [1 - E_N(A)] \quad (5-2)$$

here $E_N(A)$ is the Erlang loss formula, N is the number of working circuits on the high-usage group. The estimation may be made by an iterative computer programme, or manually by the use of tables or graphs.

The accuracy of this method may be adversely affected by the non-randomness of the offered traffic, intensity variation during the measurement period, or use of an incorrect value for N .

- b) A is estimated from:

$$A = A_H / (1 - B) \quad (5-3)$$

where B is the measured overflow probability. The accuracy of this method may be adversely affected by the presence of repeat bids generated by the exchange if they are included in the circuit group bid register.

It is recommended to apply both methods a) and b); any significant discrepancy would then require further investigation. It should be noted however that both of these methods may become unreliable for high-usage groups with high overflow probability; in this situation a longer measurement period may be required for reliable results.

5.2 High-usage group with significant congestion on the final group

In this case, estimation of the traffic offered requires a combination of the methods of 4.2 and 5.1. A proper understanding of the different parameters, through further study, is required before a detailed procedure can be recommended.

6 Origin-destination equivalent traffic offered

This clause deals with the determination of equivalent traffic model according to the model described in Annex B.

An accurate estimate of origin-destination traffic offered is essential to design, engineer and service any communications network. This is especially, but not uniquely, true for dynamic routing networks.

The accuracy of this estimation depends on the availability of measurements and on the network structure.

As a matter of fact, the origin-destination offered traffic can be obtained in three different ways, by elaborating:

- i) the measurements of traffic dispersion and duration (see Recommendation E.502), accomplished by the network switches on the total traffic;
- ii) the measurements of traffic dispersion and duration (see Recommendation E.502), accomplished by the network switches on a sampling basis;
- iii) the measurements on the circuit groups and nodes.

6.1 Determination of origin-destination traffic offered when origin-destination traffic measurements on the totality of call attempts are available

In this case the problem of determining the origin-destination traffic offered is directly solved by the measurements as it is specified in 4.2.4/E.502, and no further computations are needed.

6.2 Determination of origin-destination traffic offered when origin-destination traffic measurements only on a sampling basis are available

These measurements should be supported by consistent measurements on the traffic volume (erlang) on the totality of outgoing traffic. More precisely, if the set of origin-destination measurements, as specified in 4.2.4/E.502, type 15: "traffic dispersion", is a sampling of the total traffic outgoing the exchange, the relevant measurements on traffic volume should be the overall measurements on originating outgoing traffic and on transit traffic (type 3 and type 6 respectively of Recommendation E.502). If "the traffic dispersion" is performed on a specific circuit group, of course the relevant measurement on traffic volume should be performed on the same circuit group (measurement type 10). The determination of the traffic offered from measurements of the carried traffic should be achieved by using the procedure described in clause 4.

6.3 Determination of origin-destination traffic offered when only circuit-group based measurements of traffic intensity are available

This subclause refers to the switches which do not perform any origin-destination measurements but only circuit group based traffic intensity measurements. The following method [1] can be applied to hierarchical and non-hierarchical networks whose routing scheme can be either fixed or updated periodically with period dT , provided that the updated interval dT is long enough to guarantee the stationary traffic conditions.

These three assumptions are made:

- i) on each link, calls from different traffic relations see the same blocking which is the given measured circuit group blocking;
- ii) the event that a call will be blocked on a path link is independent of the event that it will be blocked on the other links;
- iii) a path is composed by at least two links.

Simulation studies have shown that these assumptions produce estimates of traffic offered for individual origin-destination pairs that are within 6% to 7% of actual values when the network congestion values are as low as the ones assumed in the network dimensioning.

The following information is supposed to be available at each time interval:

- i) the circuit group measurements which include the carried load and blocking on each circuit group TG ;
- ii) the (fixed) routing sequence during the dT period.

Under the above assumptions, it can be shown that the following equation holds:

$$TG = Z \cdot a \quad (6-1)$$

where TG is a vector whose elements are the carried traffic of each circuit group, a is a vector whose elements are the origin-destination traffic offered, and Z is a matrix whose elements are defined by the blocking on each circuit group and the routing sequence. The equation 6-1 is formally valid even if the above assumptions i) and iii) are not made.

The origin-destination traffic offered, a , is obtained by solving equation 6-1. Generally the solution can be derived by the classical mathematical methods, as the one described in Annex C. Nevertheless, when the node number is high, the solution of the equation system can be complex and methods of unknown variable reduction become essential. The suggestion of some of these methods is for further studies. Examples of the application of pseudo-inverse method are reported in Annex D. A sample performance evaluation of both the pseudo-inverse and the iterative algorithm is provided in Annex E.

The notations, as well as the derivation and solution of equation 6-1 are described in Annex C when two link paths are adopted. The extension to paths with more than two links is for further study.

7 History

This Recommendation was first published in 1984. It was revised in 1992 and 1997.

8 Bibliography

- [1] TU (M.): Estimation of Point-to-Point Traffic Demand in the Public Switched Telephone Network, *IEEE Transactions on Communications*, Vol. 42, Nos. 2/3/4, pp. 840-845, February/March/April 1994.

Annex A

A simplified model for the formula presented in 4.2

The call attempts arriving at the considered circuit group may be classified as shown in Figure A.1.

The total call attempt rate at the circuit group is:

$$N = N_0 + N_{NR} + N_{LR} \quad (A-1)$$

We must consider $N_0 + N_{NR}$ which would be the call attempt rate if there were no congestion on the circuit group.

Let:

$$B = \frac{N_L}{N} \quad \text{measured blocking probability on the circuit group;} \quad (A-2)$$

$$W = \frac{N_{LR}}{N_L} \quad \text{proportion of blocked call attempts that re-attempt.} \quad (A-3)$$

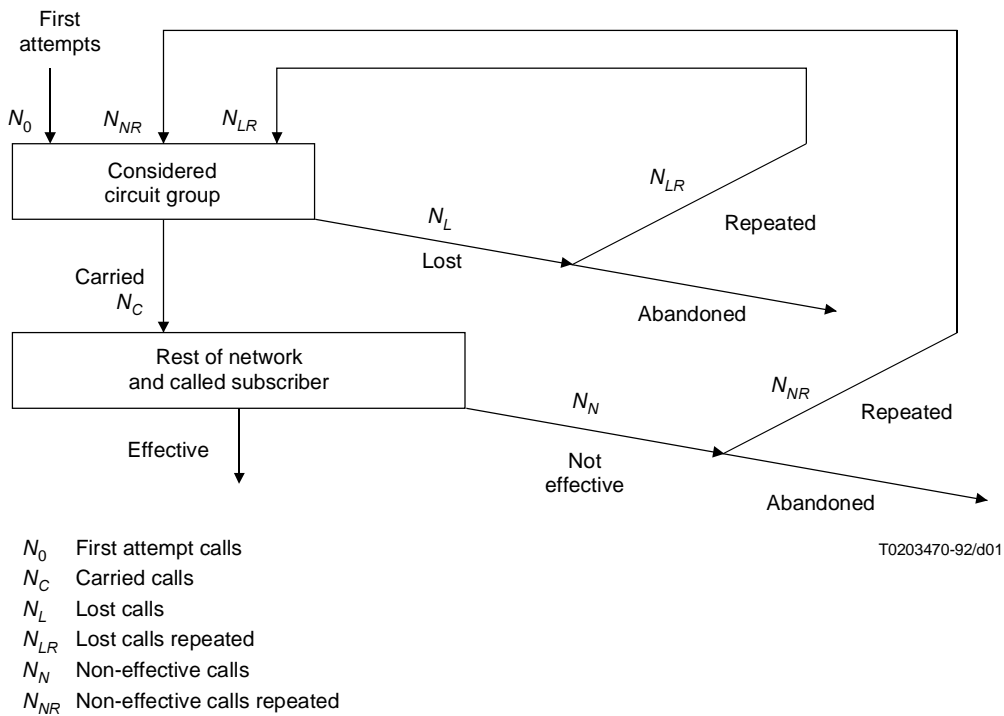

Figure A.1/E.501

We have:

$$N_0 + N_{NR} = N - N_{LR} = (N - N_{LR}) \frac{N_C}{N_C} = N_C \frac{(N - N_{LR})}{(N - N_L)} = N_C \frac{(1 - BW)}{(1 - B)} \quad (\text{A-4})$$

The above model is actually a simplification since the rate N_{NR} would be changed by augmentation of the circuit group.

Multiplying by the mean holding time of calls carried on the circuit group, h , gives:

$$A = A_C \frac{(1 - WB)}{(1 - B)} \quad (\text{A-5})$$

where A_C is the traffic carried on the circuit group.

The above model is actually a simplification since the rate N_{NR} would be changed by augmentation of the circuit group.

An alternative procedure is to estimate an equivalent persistence W from the following formulae:

$$W = \frac{r'H}{1 - H(1 - r')} \quad (\text{A-6})$$

$$H = \frac{\beta - 1}{\beta(1 - r)} \quad (\text{A-7})$$

$$\beta = \frac{\text{All call attempts}}{\text{First call attempts}} \quad (\text{A-8})$$

where r' is the completion ratio for seizures on the considered circuit group and r is the completion ratio for call attempts to the considered circuit group.

These relationships may be derived by considering the situation after augmentation (see Figure A.2).

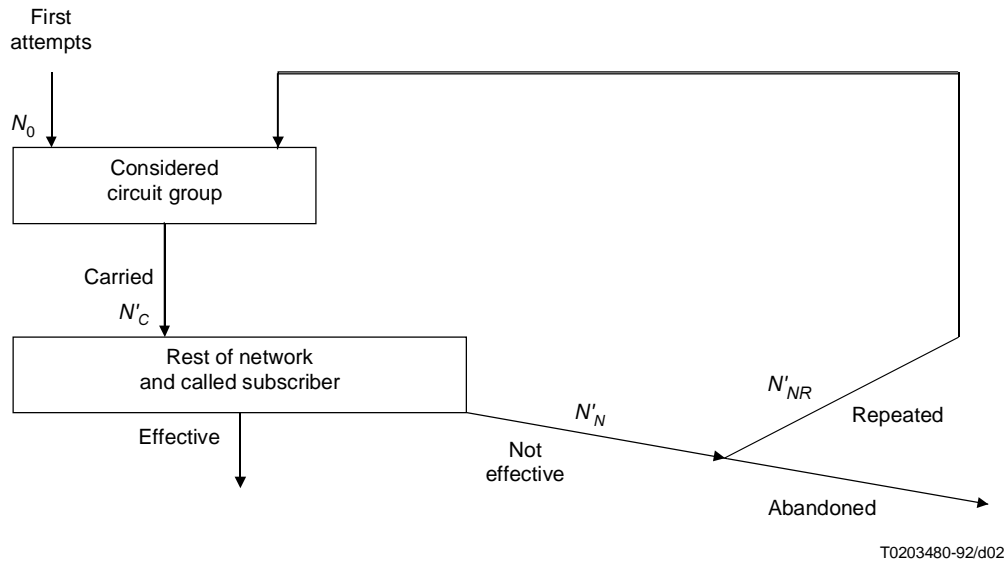

Figure A.2/E.501

It is required to estimate N'_{C} , the calls to be carried when there is no congestion on the circuit group. This may be done by establishing relationships between N_C and N_0 (before augmentation) and between N'_{C} , and N_0 (after augmentation), since the first attempt rate N_0 is assumed to be unchanged. We introduce the following parameters:

- H is the overall subscriber persistence;
- r' is the completion ratio for seizures on the circuit group.

Before augmentation:

$$H = \frac{N_{NR} + N_{NL}}{N_N + N_L} \quad (\text{A-9})$$

$$r' = \frac{N_C - N_N}{N_C} \quad (\text{A-10})$$

After augmentation:

$$H = \frac{N'_{NR}}{N'_N} \quad (\text{A-11})$$

$$r' = \frac{N'_C - N'_N}{N'_C} \quad (\text{A-12})$$

It is assumed for simplicity that H and r' are unchanged by the augmentation. The following two relationships may be readily derived:

$$N_0 = \frac{N_C [1 - H(1 - r') - r'BH]}{1 - B} \quad (\text{A-13})$$

$$N_0 = N'_C [1 - H(1 - r')] \quad (\text{A-14})$$

Hence:

$$N'_C = \frac{N_C \left[1 - \left(\frac{r'H}{1 - H(1 - r')} \right) B \right]}{1 - B} \quad (\text{A-15})$$

On multiplying by the mean call holding time, h , this provides our estimate of traffic offered in terms of traffic carried.

The relationship:

$$H = \frac{\beta - 1}{\beta(1 - r)} \quad (\text{A-16})$$

is valid both before and after augmentation, as may easily be derived from the above diagrams.

NOTE 1 – Some Administrations may be able to provide information on the call completion ratio to the considered destination.

NOTE 2 – The procedure of estimating the factor W above is based on the assumptions that H , r' and h remain unchanged after augmentation. The elimination of congestion in the group considered, leads to a change in H and in practical cases, this causes an underestimation of the factor W and consequently an overestimation of offered traffic in the formula of 4.2. A relevant study in the period 1985-1988 has shown that the overestimation is practically negligible if $B \leq 0.2$ and $r' \geq 0.6$. For larger B and smaller r' values, the overestimation may be significant unless other factors, not having been taken into account by the study, do not counteract. Therefore, caution is required in using Table A.1 in the indicated range. In the case of dynamically developing networks, the overestimation of offered traffic and relevant overprovisioning may be tolerated, but this may not be.

Table A.1/E.501

Values of $\frac{1 - WB}{1 - B}$

H =	0.70	0.75	0.80	0.85	0.90	0.95
<i>B</i> = 0.1						
<i>r</i> ' = 0.3	1.0653	1.0584	1.0505	1.0411	1.0300	1.0165
<i>r</i> ' = 0.4	1.0574	1.0505	1.0427	1.0340	1.0241	1.0129
<i>r</i> ' = 0.5	1.0512	1.0444	1.0370	1.0289	1.0202	1.0105
<i>r</i> ' = 0.6	1.0462	1.0396	1.0326	1.0252	1.0173	1.0089
<i>r</i> ' = 0.7	1.0421	1.0358	1.0292	1.0223	1.0152	1.0077
<i>r</i> ' = 0.8	1.0387	1.0326	1.0264	1.0200	1.0135	1.0068
<i>B</i> = 0.2						
<i>r</i> ' = 0.3	1.1470	1.1315	1.1136	1.0925	1.0675	1.0373
<i>r</i> ' = 0.4	1.1293	1.1136	1.0961	1.0765	1.0543	1.0290
<i>r</i> ' = 0.5	1.1153	1.1	1.0833	1.0652	1.0454	1.0238
<i>r</i> ' = 0.6	1.1041	1.0892	1.0735	1.0568	1.0390	1.0201
<i>r</i> ' = 0.7	1.0949	1.0806	1.0657	1.0503	1.0342	1.0174
<i>r</i> ' = 0.8	1.0872	1.0735	1.0595	1.0451	1.0304	1.0154
<i>B</i> = 0.3						
<i>r</i> ' = 0.3	1.2521	1.2255	1.1948	1.1587	1.1158	1.0639
<i>r</i> ' = 0.4	1.2216	1.1948	1.1648	1.1311	1.0931	1.0498
<i>r</i> ' = 0.5	1.1978	1.1714	1.1428	1.1118	1.0779	1.0408
<i>r</i> ' = 0.6	1.1785	1.1530	1.1260	1.0974	1.0669	1.0345
<i>r</i> ' = 0.7	1.1627	1.1382	1.1127	1.0862	1.0587	1.0299
<i>r</i> ' = 0.8	1.1495	1.1260	1.1020	1.0774	1.0522	1.0264
<i>B</i> = 0.4						
<i>r</i> ' = 0.3	1.3921	1.3508	1.3030	1.2469	1.1801	1.0995
<i>r</i> ' = 0.4	1.3448	1.3030	1.2564	1.2040	1.1449	1.0775
<i>r</i> ' = 0.5	1.3076	1.2666	1.2222	1.1739	1.1212	1.0634
<i>r</i> ' = 0.6	1.2777	1.2380	1.1960	1.1515	1.1041	1.0537
<i>r</i> ' = 0.7	1.2531	1.2150	1.1754	1.1342	1.0913	1.0466
<i>r</i> ' = 0.8	1.2325	1.1960	1.1587	1.1204	1.0813	1.0411
<i>B</i> = 0.5						
<i>r</i> ' = 0.3	1.5882	1.5263	1.4545	1.3703	1.2702	1.1492
<i>r</i> ' = 0.4	1.5172	1.4545	1.3846	1.3061	1.2173	1.1162
<i>r</i> ' = 0.5	1.4615	1.4	1.3333	1.2608	1.1818	1.0952
<i>r</i> ' = 0.6	1.4166	1.3571	1.2941	1.2272	1.1562	1.0806
<i>r</i> ' = 0.7	1.3797	1.3225	1.2631	1.2013	1.1369	1.0699
<i>r</i> ' = 0.8	1.3488	1.2941	1.2380	1.1807	1.1219	1.0617

Annex B

Equivalent traffic offered

In the lost call model the equivalent traffic offered corresponds to the traffic which produces the observed carried traffic in accordance with the relation:

$$y = A(1 - B) \quad (\text{B-1})$$

where:

y : is the carried traffic;

A : is the equivalent traffic offered;

B : is the call congestion through the part of the network considered.

NOTE 1 – This is a purely mathematical concept. Physically, it is only possible to detect bids whose effect on occupancies tells whether these attempts give rise to very brief seizures or to calls.

NOTE 2 – The equivalent traffic offered, which is greater than the traffic carried and therefore, greater than the effective traffic, is greater than the traffic offered when the subscriber is very persistent.

NOTE 3 – B is evaluated on a purely mathematical basis so that it is possible to establish a direct relationship between the traffic carried and call congestion B and to dispense with the role of the equivalent traffic offered A .

Annex C

Methods for determination of origin-destination traffic offered when only the measurements of traffic intensity on circuit group basis are available

C.1 Notation, derivation, and solution of Formula 6-1 in 6.3

The following notations are adopted:

L : the number of links;

P : the number of traffic relations;

$a(i)$: the offered traffic for traffic relation i ;

Path ij : denote the j -th path for traffic relation i ;

$OL(ij)$: the traffic relation i offered to path ij ;

$PB(ij)$: the path blocking of path ij ;

$CL(ij)$: the traffic intensity of relation i carried on path ij ;

$$CL(ij) = OL(ij) \cdot [1 - PB(ij)] \quad (\text{C-1})$$

Path link ijk : denotes the k -th circuit group of Path ij :

- $k = 1$ or 2 since only 1-link and 2-link paths are considered (the extension to n -link path is straightforward);
- each path link ijk corresponds to a unique circuit group q ($q = 1, 2, \dots, L$), but each circuit group q may correspond to a number of path links ijk . This relationship is denoted by a mapping X , i.e.:

$$X(ijk) = q \quad (\text{C-2})$$

The term q either denotes a circuit group or is equal to zero so that:

- if $X(ij1) = 0$, it means that traffic relation i has at most $j - 1$ paths;
- if $X(ij2) = 0$ and $X(ij1) \neq 0$, it means that j -th path for traffic relation i is a 1-link path;

$LB(ijk)$: the link blocking of link ijk ;

$TG(q)$: the total traffic carried on circuit group q .

Because of the assumptions on the independence of the call blocking on each link of a path, the path blocking is a simple function of its circuit group blockings:

$$PB(ij) = LB(ij1) + LB(ij2) - LB(ij1) \cdot LB(ij2) \quad (C-3)$$

When there is the crankback capability, the following equation can be derived:

$$OL(ij) = a(i) \cdot \prod_{t=1}^{j-1} PB(it) \quad (C-4)$$

Therefore, from formulae C-1 and C-4:

$$CL(ij) = a(i) \cdot [1 - PB(ij)] \cdot \prod_{t=1}^{j-1} PB(it) = s(ij) \cdot a(i) \quad (C-5)$$

where:

$$s(ij) = [1 - PB(ij)] \cdot \prod_{t=1}^{j-1} PB(it) \quad (C-6)$$

Then the total carried traffic on each circuit group q is:

$$TG(q) = \sum_{X(ijk)=q} CL(ij) = \sum_{X(ijk)=q} s(ij) \cdot a(i) \quad (C-7)$$

When there is no crankback capability, a call will be routed in the next path in the routing sequence only if it is blocked on the first link of path ij . The call will be abandoned if it is blocked on the second link. In this case the formula C-4 must be rewritten in the following way:

$$OL(ij) = a(i) \cdot \prod_{t=1}^{j-1} LB(it1) \quad (C-8)$$

From formulae C-1 and C-8:

$$CL(ij) = a(i) \cdot [1 - PB(ij)] \cdot \prod_{t=1}^{j-1} LB(it1) \quad (C-9)$$

and assuming in this case (no crankback capability):

$$s(ij) = [1 - PB(ij)] \cdot \prod_{t=1}^{j-1} LB(it1) \quad (C-10)$$

the final equation can be written as in C-7.

The offered traffic for each relation can be derived from the set of formula C-7, in which the definition of $s(ij)$ is depending on the presence of crankback capability on the network.

Pseudo-inverse and various iterative methods can be applied to solve the equation system C-7, that can be written in the following matrix form:

$$TG = Z \cdot a \quad (C-11)$$

where:

$$\begin{aligned} TG &= [TG(1), \dots, TG(L)]^T \\ a &= [a(1), \dots, a(P)]^T \\ Z &= [z(uv)]_{L \times P} \end{aligned} \quad (C-12)$$

where $z(uv)=s(vr)$ if circuit group u is a circuit group of the r -th path of relation v ; otherwise is equal to zero.

At present, two methods here have been proposed to solve the system C-11: the pseudo-inverse and an iterative algorithm.

C.2 The pseudo-inverse

If the pseudo-inverse method is used, the solution of the system C-11 is:

$$a^0 = Z^0 \cdot TG \quad (C-13)$$

where a^0 is the estimated offered traffic relation and Z^0 is the pseudo-inverse of Z (C-1).

If the system is square, namely the number of equations is equal to the number of unknowns and therefore, the network is fully meshed, the solution is univocally determined, in fact:

$$Z^0 = Z^{-1} \quad (C-14)$$

where Z^{-1} is the inverse matrix (if existing) of Z .

For non-fully connected networks, namely the number of equations is less than the number of unknowns, the equation system does not have a unique solution, therefore the offered traffic for each relation must be estimated, introducing in this way an error that is greater as the number of circuit groups decreases. In this case:

$$Z^0 = Z^T \cdot (Z \cdot Z^T)^{-1} \quad (C-15)$$

where Z^T is the transpose matrix of Z .

Finally, there can also be the case in which the number of equations is greater than the number of unknowns (overdetermined systems). This can happen, for example, when other network measurements, such as the office totals, are added. In this case:

$$Z^0 = (Z^T \cdot Z)^{-1} \cdot Z^T \quad (C-16)$$

In any case, a^0 is the optimal estimate of a , in the least-square sense, based on the available measurements.

C.3 The iterative algorithm

In the iterative method $a^{(0)}$, an initial estimate of a , is first given. Then, from the current estimate $a^{(k)}$ at the k -th step, a new estimate $a^{(k+1)}$ is generated as follows:

$$a^{(k+1)} = a^{(k)} + w^{(k)} \cdot v^{(k)} \quad (C-17)$$

In this equation the scalar quantity $w^{(k)}$ and the generic r -th component of the vector $v^{(k)}$ are obtained by properly weighting the error $\Delta TG^{(k)} = Z \uparrow a^{(k)} - TG$, according to the following expressions (C-2):

$$v_r^{(k)} = a_r^{(k)} \sum_{i=1}^L \frac{\Delta TG_i^{(k)}}{TG_i} z_{i,r} \quad r = 1, 2, \dots, P \quad (C-18)$$

$$w^{(k)} = \frac{\left(\Delta TG^{(k)}\right)^T Z \cdot v^{(k)}}{\left(v^{(k)}\right)^T Z^T Z \cdot v^{(k)}} \quad (C-19)$$

These equations are derived so as to minimize the distance between ΔTG and the update $w \cdot v$ at each iteration. This process terminates when the relative variation of the estimate

$$\frac{\left\| a^{(k+1)} - a^{(k)} \right\|}{\left\| a^{(k)} \right\|} \quad (C-20)$$

is less than a preset limit (e.g. 10^{-3}).

The accuracy and/or the speed of the method may depend on the closeness of the initial estimate $a^{(0)}$ to the true value of a .

A convenient expression for the initial estimate of the origin-destination traffic can be reached through the following steps:

- 1) Estimation of the probability $P_{R|T}(r|k)$ that the traffic carried on the circuit group k belongs to the origin-destination relation r through the equation:

$$P_{R|T}(r|k) = \frac{z_{k,r}}{\sum_i z_{k,i}} \quad (C-21)$$

where $z_{k,r}$ is the element in the k -th row and r -th column of z ;

- 2) Estimation of the origin-destination traffic carried on each path, made up of one or more circuit groups, through the equation:

$$a_{r,q}^* = \min_{k_i} \left[P_{R|T}(r|k_i) TG_{k_i} \right] \quad (C-22)$$

where the subscript i covers all the circuit groups of the path q ;

- 3) Estimation of the total traffic carried on the circuit group k as the sum of the estimates for the traffic due to all the relations using that circuit group through the equation:

$$TG_k^{est} = \sum_{r,q} a_{r,q}^* \quad (C-23)$$

- 4) Normalization of the estimate obtained at step 2):

$$a_{r,q}^{**} = a_{r,q}^* \frac{TG_{k_1}}{TG_{k_1}^{est}} \quad (C-24)$$

- 5) Estimation of the offered origin-destination traffic by using the estimated origin-destination traffic carried on each path and the estimated loss for each origin-destination pair:

$$a_r^{(0)} = \frac{\sum_q a_{r,q}^{**}}{1 - PB_r} \quad (C-25)$$

where loss PB_r for the relation r is estimated from the measured losses on the circuit groups by assuming that each relation using the same circuit group undergoes the same loss.

NOTE 1 – Different traffic relations do not see the same blocking on a circuit group, especially if circuit reservation is used. The proposed method can make use of the traffic relation blocking probabilities. In both cases, $LB(ijk)$ should be interpreted as the circuit group blocking seen by the traffic relation i on the circuit group ijk . The derived equations remain unchanged. The evaluation of the relation blocking by analytical models is for further study.

NOTE 2 – In the case of large networks the solution of the system of linear equations C-11 may be affected by computational problems (e.g. instability). In addition, the convergence of the iterative algorithms is not proven in a rigorous mathematical way, but it has been obtained in the examined practical cases. A reduction of the system's dimensions to reduce the computational load is highly desirable. The specific method for reducing the computational load is for further study.

Bibliography

- ALBERT (A.): Regression and the Moore-Penrose Pseudoinverse, *Academic Press*, New York, 1972.
- KIM (N.): A point-to-point traffic estimation from circuit group and office measurement for large network, *13th International Teletraffic Congress*, pp. 465-469, Copenhagen, 19-26 June 1991.

Annex D

Examples of application of the methods described in Annex C

D.1 Example 1

Consider the following 3-node network (see Figures D.1 and D.2):

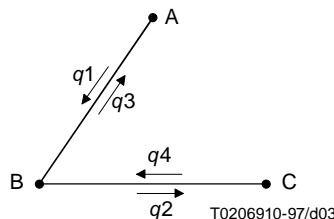

Figure D.1/E.501 – The one-way circuit group case

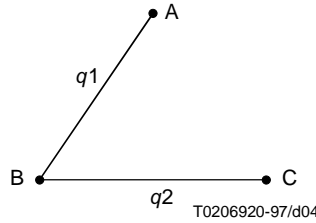

Figure D.2/E.501 – The two-way circuit group case

The origin-destination pairs and their paths are given in the following tables:

For the one-way case

Origin-destination	(A, B)	(B, C)	(C, A)	(B, A)	(C, B)	(A, C)
<i>i</i>	1	2	3	4	5	6
Path	<i>q1</i>	<i>q2</i>	<i>q4, q3</i>	<i>q3</i>	<i>q4</i>	<i>q1, q2</i>

For the two-way case

Origin-destination	(A, B)	(B, C)	(C, A)	(B, A)	(C, B)	(A, C)
<i>i</i>	1	2	3	4	5	6
Path	<i>q1</i>	<i>q2</i>	<i>q2, q1</i>	<i>q1</i>	<i>q2</i>	<i>q1, q2</i>

Based on the routing table, the mapping $X(ijk) = q$ can be expressed as follows:

For the one-way case

<i>ijk</i>	<i>q</i>	<i>ijk</i>	<i>q</i>	<i>ijk</i>	<i>q</i>	<i>ijk</i>	<i>q</i>	<i>ijk</i>	<i>q</i>	<i>ijk</i>	<i>q</i>
111	1	211	2	311	4	411	3	511	4	611	1
112	0	212	0	312	3	412	0	512	0	612	2

For the two-way case

<i>ijk</i>	<i>q</i>	<i>ijk</i>	<i>q</i>	<i>ijk</i>	<i>q</i>	<i>ijk</i>	<i>q</i>	<i>ijk</i>	<i>q</i>	<i>ijk</i>	<i>q</i>
111	1	211	2	311	2	411	1	511	2	611	1
112	0	212	0	312	1	412	0	512	0	612	2

The Z matrix is:

$$Z = \begin{bmatrix} s(11) & 0 & 0 & 0 & 0 & s(61) \\ 0 & s(21) & 0 & 0 & 0 & s(61) \\ 0 & 0 & s(31) & s(41) & 0 & 0 \\ 0 & 0 & s(31) & 0 & s(51) & 0 \end{bmatrix} \quad \text{for the one-way case;}$$

$$Z = \begin{bmatrix} s(11) & 0 & s(31) & s(41) & 0 & s(61) \\ 0 & s(21) & s(31) & 0 & s(51) & s(61) \end{bmatrix} \quad \text{for the two-way case.}$$

Let us assume that also for the two-way circuit groups all the links have the same blocking value of 0.1, then we obtain the values for $s(ij)$: $s(i1) = 0.9$ for $i = 1, 2, 4$ and 5 , and $s(i1) = 0.81$ for $i = 3$ and 6 .

Thus we have:

$$\begin{bmatrix} TG(1) \\ TG(2) \end{bmatrix} = \begin{bmatrix} 0.9 & 0 & 0.81 \\ 0 & 0.9 & 0.81 \end{bmatrix} \begin{bmatrix} a(1) + a(4) \\ a(2) + a(5) \\ a(3) + a(6) \end{bmatrix}.$$

Assuming $TG(1) = 5$ E, and $TG(2) = 7$ E, we obtain:

$$\begin{bmatrix} a(1) + a(4) \\ a(2) + a(5) \\ a(3) + a(6) \end{bmatrix} = \begin{bmatrix} 1.43 \text{ E} \\ 3.65 \text{ E} \\ 4.58 \text{ E} \end{bmatrix}.$$

That is, the two-way offered traffic between the endpoints A and B is 1.43 E, between the endpoints B and C is 3.65 E, and between the endpoints A and C is 4.58 E.

For the one-way circuit group case we obtain the values for $s(i1)$: $s(i1) = 0.9$ for $i = 1, 2, 4$ and 5 , and $s(i1) = 0.81$ for $i = 3$ and 6 . Then we have:

$$\begin{bmatrix} TG(1) \\ TG(2) \\ TG(3) \\ TG(4) \end{bmatrix} = \begin{bmatrix} 0.90 & 0.00 & 0.00 & 0.00 & 0.00 & 0.81 \\ 0.00 & 0.90 & 0.00 & 0.00 & 0.00 & 0.81 \\ 0.00 & 0.00 & 0.81 & 0.90 & 0.00 & 0.00 \\ 0.00 & 0.00 & 0.81 & 0.00 & 0.90 & 0.00 \end{bmatrix} \begin{bmatrix} a(1) \\ a(2) \\ a(3) \\ a(4) \\ a(5) \\ a(6) \end{bmatrix}.$$

Assuming:

$$TG = \begin{bmatrix} 2.5 \\ 3.5 \\ 2.5 \\ 3.5 \end{bmatrix},$$

By the application of the pseudo-inverse we obtain:

$$\begin{bmatrix} a(1) \\ a(2) \\ a(3) \\ a(4) \\ a(5) \\ a(6) \end{bmatrix} = \begin{bmatrix} 0.716709 \\ 1.82782 \\ 2.29008 \\ 0.716709 \\ 1.82782 \\ 2.29008 \end{bmatrix}.$$

D.2 Example 2

Consider the following network (see Figures D.3 and D.4):

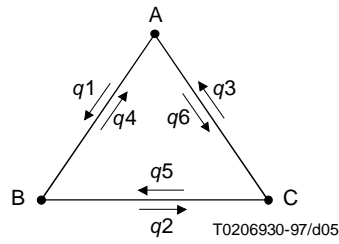

Figure D.3/E.501 – The one-way circuit group case

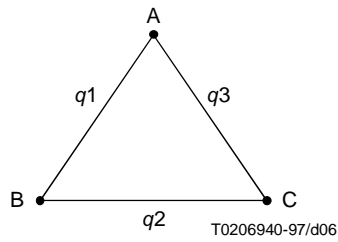

Figure D.4/E.501 – The two-way circuit group case

The origin-destination nodes and their routing sequences are given in the following tables.

For the one-way case

Origin-destination nodes	(A, B)	(B, C)	(C, A)	(B, A)	(C, B)	(A, C)
<i>i</i>	1	2	3	4	5	6
1st choice path	<i>q1</i>	<i>q2</i>	<i>q3</i>	<i>q4</i>	<i>q5</i>	<i>q6</i>
2nd choice path	<i>q6, q5</i>	<i>q4, q6</i>	<i>q5, q4</i>	<i>q2, q3</i>	<i>q3, q1</i>	<i>q1, q2</i>

For the two-way case

Origin-destination nodes	(A, B)	(B, C)	(C, A)	(B, A)	(C, B)	(A, C)
<i>i</i>	1	2	3	4	5	6
1st choice path	<i>q1</i>	<i>q2</i>	<i>q3</i>	<i>q1</i>	<i>q2</i>	<i>q3</i>
2nd choice path	<i>q3, q2</i>	<i>q1, q3</i>	<i>q2, q1</i>	<i>q2, q3</i>	<i>q3, q1</i>	<i>q1, q2</i>

Based on the routing table, the mapping $X(ijk) = q$ can be expressed as follows:

For the one-way case

<i>ijk</i>	<i>q</i>	<i>ijk</i>	<i>q</i>	<i>ijk</i>	<i>q</i>	<i>ijk</i>	<i>q</i>	<i>ijk</i>	<i>q</i>	<i>ijk</i>	<i>q</i>
111	1	211	2	311	3	411	4	511	5	611	6
112	0	212	0	312	0	412	0	512	0	612	0
121	6	221	4	321	5	421	2	521	3	621	1
122	5	222	6	322	4	422	3	522	1	622	2

For the two-way case

<i>ijk</i>	<i>q</i>	<i>ijk</i>	<i>q</i>	<i>ijk</i>	<i>q</i>	<i>ijk</i>	<i>q</i>	<i>ijk</i>	<i>q</i>	<i>ijk</i>	<i>q</i>
111	1	211	2	311	3	411	1	511	2	611	3
112	0	212	0	312	0	412	0	512	0	612	0
121	3	221	1	321	2	421	2	521	3	621	1
122	2	222	3	322	1	422	3	522	1	622	2

The matrix *Z* is:

$$Z = \begin{bmatrix} s(11) & 0 & 0 & 0 & s(52) & s(62) \\ 0 & s(21) & 0 & s(42) & 0 & s(62) \\ 0 & 0 & s(31) & s(42) & s(52) & 0 \\ 0 & s(22) & s(32) & s(41) & 0 & 0 \\ s(12) & 0 & s(32) & 0 & s(51) & 0 \\ s(12) & s(22) & 0 & 0 & 0 & s(61) \end{bmatrix} \quad \text{for the one-way case;}$$

$$Z = \begin{bmatrix} s(11) & s(22) & s(32) & s(41) & s(52) & s(62) \\ s(12) & s(21) & s(32) & s(42) & s(51) & s(62) \\ s(12) & s(22) & s(31) & s(42) & s(52) & s(62) \end{bmatrix} \quad \text{for the two-way case.}$$

Let us assume also that for the two-way circuit groups all the links have the same blocking value of 0.1. Then, we obtain the following values for $s(ij)$ for both with and without crankback: $s(i1) = 0.9$ and $s(i2) = 0.081$.

Thus we have:

$$\begin{bmatrix} TG(1) \\ TG(2) \\ TG(3) \end{bmatrix} = \begin{bmatrix} 0.981 & 0.081 & 0.081 \\ 0.081 & 0.981 & 0.081 \\ 0.081 & 0.081 & 0.981 \end{bmatrix} \begin{bmatrix} a(1) + a(4) \\ a(2) + a(5) \\ a(3) + a(6) \end{bmatrix}$$

Assuming $TG(1) = 5$ E, $TG(2) = 7$ E, and $TG(3) = 10$ E, we obtain:

$$\begin{bmatrix} a(1) + a(4) \\ a(2) + a(5) \\ a(3) + a(6) \end{bmatrix} = \begin{bmatrix} 3.82 \text{ E} \\ 6.05 \text{ E} \\ 9.38 \text{ E} \end{bmatrix}$$

That is, the two-way offered traffic between the endpoints A and B is 3.82 E, between the endpoints B and C is 6.05 E, and between the endpoints A and C is 9.38 E.

For the one-way circuit group case we obtain the values for $s(ij)$: $s(i1) = 0.9$ and $s(i2) = 0.081$ for $i = 1, \dots, 6$. Then we have:

$$\begin{bmatrix} TG(1) \\ TG(2) \\ TG(3) \\ TG(4) \\ TG(5) \\ TG(6) \end{bmatrix} = \begin{bmatrix} 0.900 & 0.000 & 0.000 & 0.000 & 0.081 & 0.081 \\ 0.000 & 0.900 & 0.000 & 0.081 & 0.000 & 0.081 \\ 0.000 & 0.000 & 0.900 & 0.081 & 0.081 & 0.000 \\ 0.000 & 0.081 & 0.081 & 0.900 & 0.000 & 0.000 \\ 0.081 & 0.000 & 0.081 & 0.000 & 0.900 & 0.000 \\ 0.081 & 0.081 & 0.000 & 0.000 & 0.000 & 0.900 \end{bmatrix} \begin{bmatrix} a(1) \\ a(2) \\ a(3) \\ a(4) \\ a(5) \\ a(6) \end{bmatrix}$$

Assuming:

$$TG = \begin{bmatrix} 2.5 \\ 3.5 \\ 5.0 \\ 2.5 \\ 3.5 \\ 5.0 \end{bmatrix},$$

by the application of the pseudo-inverse we obtain:

$$\begin{bmatrix} a(1) \\ a(2) \\ a(3) \\ a(4) \\ a(5) \\ a(6) \end{bmatrix} = \begin{bmatrix} 2.0281 \\ 3.2491 \\ 5.08061 \\ 2.0281 \\ 3.2491 \\ 5.08061 \end{bmatrix}.$$

Annex E

A sample performance evaluation of the pseudo-inverse and of the iterative algorithm

In order to evaluate both methods a medium-sized network, made up of 15 nodes and shown in Figure E.1, has been considered. The network is connected in a partially meshed fashion with a 65% connectivity.

The routing plan is fixed allowing for no more than 3 paths, composed of one or two links, for each origin-destination couples.

For this network two basic sets of origin/destination traffic values have been considered, obtained by scaling the real ones in such a way to produce an average grade of service equal to 2.5% and 7.1% respectively. Each basic set has then being randomly perturbed (within a $\pm 10\%$ range), in order to obtain 2 groups of 100 sets.

Each set has been input to a network analysis tool, which has supplied us with the values of the traffic carried on the circuit groups and the associated losses. After forming the system of equations C-11 for each set of origin-destination traffic values, both methods (the pseudo-inverse and the iterative algorithm) have been applied, leading to 2 groups of 100 sets of estimated origin-destination traffic values for each method. The starting point for the iterative algorithm has been set to 1 erlang for all origin-destination couples.

To evaluate the performance of both methods two indicators have been used: the Norm-2 and the Norm-infinity relative errors, respectively defined as:

$$\|e\|_2 = \frac{\|a_s - a\|_2}{\|a\|_2} = \frac{\sqrt{\sum_h (a_{s,h} - a_h)^2}}{\sqrt{\sum_h a_h^2}}, \quad (E-1)$$

$$\|e\|_\infty = \text{Max}_h \left| \frac{a_{s,h} - a_h}{a_h} \right|. \quad (E-2)$$

where a is the true vector and a_s is the estimated vector (either via the pseudo-inverse or through the iterative algorithm).

The mean value and the standard deviation of the two indicators are reported in Tables E.1 and E.2.

Table E.1/E.501 – Norm-2 error (Average ± standard deviation)

		Case A (Avg. Loss ≅ 2.5%)	Case B (Avg. Loss ≅ 7.1%)
Pseudo-inverse		9.28 ± 0.26 %	9.49 ± 0.28 %
Iterative algorithm	Flat initialization	8.33 ± 0.26 %	8.95 ± 0.30 %
	Annex E initialization	5.84 ± 0.12 %	6.57 ± 0.27 %

Table E.2/E.501 – Norm-infinity error (Average ± standard deviation)

		Case A (Avg. Loss ≅ 2.5%)	Case B (Avg. Loss ≅ 7.1%)
Pseudo-inverse		212 ± 15 %	237 ± 14 %
Iterative algorithm	Flat initialization	268 ± 22 %	282 ± 21 %
	Annex E initialization	140 ± 10 %	142 ± 11 %

Though the Norm-infinity error is very large in both methods, it refers generally to light traffic relations.

The average number of iteration needed to reach the solution was 17.8 for the 2.5% loss and 20.2 for the 7.1% loss (the algorithm was stopped when the relative variation introduced by a new iteration was less than 10^{-4}).

As can be seen, both methods lead to acceptable results.

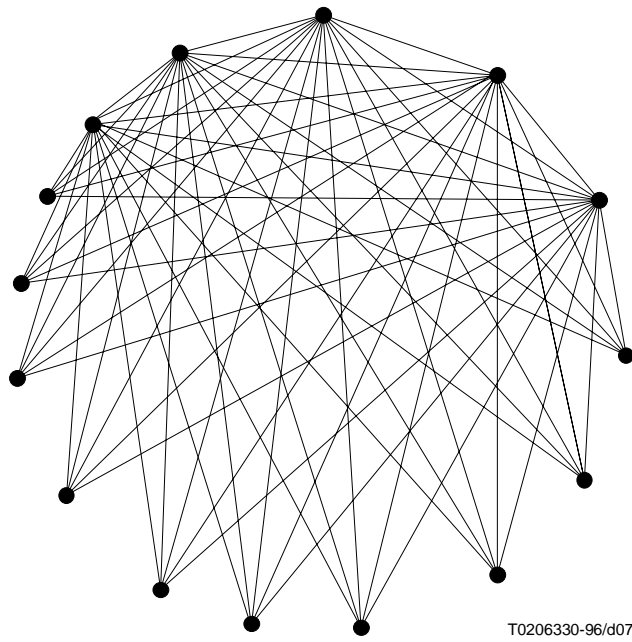

Figure E.1/E.501 – Network topology

ITU-T RECOMMENDATIONS SERIES

Series A	Organization of the work of the ITU-T
Series B	Means of expression: definitions, symbols, classification
Series C	General telecommunication statistics
Series D	General tariff principles
Series E	Overall network operation, telephone service, service operation and human factors
Series F	Non-telephone telecommunication services
Series G	Transmission systems and media, digital systems and networks
Series H	Audiovisual and multimedia systems
Series I	Integrated services digital network
Series J	Transmission of television, sound programme and other multimedia signals
Series K	Protection against interference
Series L	Construction, installation and protection of cables and other elements of outside plant
Series M	TMN and network maintenance: international transmission systems, telephone circuits, telegraphy, facsimile and leased circuits
Series N	Maintenance: international sound programme and television transmission circuits
Series O	Specifications of measuring equipment
Series P	Telephone transmission quality, telephone installations, local line networks
Series Q	Switching and signalling
Series R	Telegraph transmission
Series S	Telegraph services terminal equipment
Series T	Terminals for telematic services
Series U	Telegraph switching
Series V	Data communication over the telephone network
Series X	Data networks and open system communication
Series Z	Programming languages