



INTERNATIONAL TELECOMMUNICATION UNION

CCITT

THE INTERNATIONAL
TELEGRAPH AND TELEPHONE
CONSULTATIVE COMMITTEE

G.763

(11/1988)

SERIES G: TRANSMISSION SYSTEMS AND MEDIA,
DIGITAL SYSTEMS AND NETWORKS

General aspects of digital transmission systems; terminal
equipments

General

**DIGITAL CIRCUIT MULTIPLICATION
EQUIPMENT USING 32 KBIT/S ADPCM AND
DIGITAL SPEECH INTERPOLATION**

Reedition of CCITT Recommendation G.763 published in
the Blue Book, Fascicle III.4 (1988)

NOTES

- 1 CCITT Recommendation G.763 was published in Fascicle III.4 of the *Blue Book*. This file is an extract from the *Blue Book*. While the presentation and layout of the text might be slightly different from the *Blue Book* version, the contents of the file are identical to the *Blue Book* version and copyright conditions remain unchanged (see below).
- 2 In this Recommendation, the expression “Administration” is used for conciseness to indicate both a telecommunication administration and a recognized operating agency.

Recommendation G.763

DIGITAL CIRCUIT MULTIPLICATION EQUIPMENT USING 32 KBIT/S ADPCM AND DIGITAL SPEECH INTERPOLATION

(Melbourne, 1988)

1 General

1.1 Scope

This Recommendation is intended as an introduction to digital circuit multiplication equipment and systems, and as a base document for the specification of Digital Circuit Multiplication Equipment (DCME) and Digital Circuit Multiplication Systems (DCMS).

Essential facilities, interface conditions and overall performance requirements are given. Requirements for full compatibility and interoperability are under study (see Supplement N^o 31 at the end of this fascicle).

1.2 Attributes

Digital circuit multiplication equipment is utilized as a means of augmenting the capacity of digital transmission systems operating between several International Switching Centers (ISCs). DCME has all of the following attributes:

- digital speech interpolation (DSI);
- low rate encoding (LRE);
- dynamic load control (DLC) arrangement in association with interfacing;
- capability to accommodate the following types of bearer service requirements:
 - i) speech,
 - ii) 3.1 kHz audio (data and speech),
 - iii) 64 kbit/s unrestricted (transparent),
 - iv) alternate speech/64 kbit/s unrestricted.

The link between two DCMEs is generally one where a highly efficient traffic carrying capability is required, e.g., a long-distance link.

1.3 Application

This Recommendation is applicable to the design of digital circuit multiplication equipment intended for, but not limited to, use in an international digital circuit. Freedom is permitted in design details which are not covered in this Recommendation (see Note).

Note – Several additional items yet to be fully considered include the evaluation of:

- instantaneous 2-bit speech encoding on overloads (to avoid clipping), and voice-band data rate discrimination (to permit rates less than or equal to 4800 bit/s to be coded at 32 kbit/s only and to increase bearer channel efficiency).
- silence elimination techniques (to permit saving of bearer channel capacity during the inactive periods of half-duplex voice-band data calls).

2 Definitions relating to digital circuit multiplication equipment

2.1 digital circuit multiplication equipment (DCME)

A general class of equipment which permits concentration of a number of 64 kbit/s PCM encoded input trunk channels on a reduced number of transmission channels (see § 2.7).

2.2 **digital circuit multiplication system (DCMS)**

A telecommunications network comprised of two or more DCME terminals where each DCME terminal contains a transmit unit and a receive unit.

2.3 **low rate encoding (LRE)**

A voice-band signal encoding method, e.g. adaptive differential pulse code modulation (ADPCM), which results in a bit rate less than 64 kbit/s, e.g. 40 kbit/s, 32 kbit/s, or 24 kbit/s.

Note – Conversion between speech signals encoded in PCM at 64 kbit/s and those encoded in ADPCM must be carried out by means of transcoding processes given in Recommendations G.721 and G.723.

2.4 **variable bit rate (VBR)**

The capability of the encoding algorithm to dynamically switch between 32 and 24 kbit/s for speech traffic under control of the DCME.

2.5 **digital speech interpolation (DSI)**

A process which, when used in the transmit unit of a DCME, causes a trunk channel (see § 2.9) to be connected to a bearer channel (see § 2.8) only when activity is actually present on the trunk channel. Thus, by exploiting the probability of the speech activity factor (see § 2.14) of trunk channels being less than 1.0, enables the traffic from a number of trunk channels to be concentrated and carried by a lesser number of time-shared bearer channels. The signals carried by a bearer channel, therefore, represent interleaved bursts of speech signals derived from a number of different trunk channels.

Note – A process complementary to DSI is required in the receive unit of a DCME, i.e. assignment of the interleaved bursts to their appropriate trunk channels.

2.6 **DCME frame**

A time interval, the beginning of which is identified by a «unique word» in the control channel. The DCME frame need not coincide with the multiframes defined in Recommendation G.704. The format specification of the DCME frame includes channel boundaries and bit position significance.

2.7 **transmission channel**

A 64 kbit/s time slot within a DCME frame.

2.8 **bearer channel (BC)**

A bearer channel is a unidirectional, digital, transmission path from the transmit unit of one DCME to the receive unit of a second associated DCME and which is used to carry concentrated traffic between the two DCMEs.

Note 1 – A number of bearer channels in each direction of transmission form the both-way link required between two DCMEs. This link may be, for example, a 2048 kbit/s system.

Note 2 – A bearer channel may have any of the following instantaneous bit rates: 24, 32, 40 and 64 kbit/s.

2.9 **trunk channel (TC)**

A unidirectional, digital transmission path (generally short distance) used for carrying traffic and which connects a DCME to other equipment, e.g. an International Switching Centre (ISC). Two such trunk channels (transmit and receive) are needed by 4-wire telephone circuits and constitute a trunk circuit.

Note 1 – Signals carried by a trunk channel will be transmitted at a bit rate of 64 kbit/s.

Note 2 – A number of trunk channels in each direction of transmission are required between a DCME and, for instance, an ISC. These trunk channels may be carried by a number of 1544 or 2048 kbit/s systems.

2.10 **assignment message**

The message specifying the interconnections required between trunk channels and bearer channels.

2.11 **assignment map**

A record, held in a memory of a DCME, of the interconnections required between trunk channels and bearer channels. This record is dynamically updated in real time in accordance with the traffic demands made on the DCME.

2.12 **control channel**

A unidirectional transmission path from the transmit unit of one DCME to the receive unit of one or more associated DCMEs and which is dedicated primarily to carrying channel assignment messages. In addition, the control channel transmits other messages such as idle noise levels, dynamic load control, and alarm messages.

Note – An alternative name for «control channel» is «assignment channel».

2.13 **ensemble activity**

The ratio of the time active signals and their corresponding hangover time and front-end delay occupy the trunk channels, to the total measuring time, averaged over the total number of trunk channels included in the measurement.

2.14 **speech activity factor**

The ratio of the time speech signals with their corresponding hangover time and front-end delay occupy a trunk channel, to the total measuring time, averaged over the total number of trunk channels carrying speech.

2.15 **voice band data ratio**

The ratio of the number of trunk channels carrying voice-band data signals to the total number of trunk channels averaged over a fixed interval of time.

2.16 **64 kbit/s unrestricted digital data ratio**

The ratio of the number of trunk channels carrying 64 kbit/s unrestricted digital data signals, to the total number of trunk channels averaged over a fixed interval of time.

2.17 **DCME overload (mode)**

The condition when the number of input trunk channels instantaneously active carrying speech exceeds the number of 32 kbit/s channels available for interpolation.

2.18 **overload channels**

The additional bearer channel capacity which is generated using variable bit rate (VBR) encoding to minimize or eliminate DSI competitive clipping.

2.19 **average bits per sample**

The average number of encoding bits per sample computed over a given time window for the ensemble of active interpolated bearer channels within a given interpolated pool. Only bearer channels carrying speech are included in this calculation.

2.20 **transmission overload**

The condition when the average bits per sample goes beyond the value set in accordance with speech quality requirements.

2.21 **freeze-out**

The condition when a trunk channel becomes active and cannot immediately be assigned to a bearer channel, due to lack of available transmission capacity.

2.22 **freeze-out fraction (FOF)**

The ratio of the total time that the individual channels experience the freeze-out condition to the total time of the active intervals and their corresponding hangover times and front-end delays, for all trunks over a fixed interval of time, e.g. one minute.

2.23 **interpolation gain (IG)**

The trunk channel multiplication ratio which is achieved through DSI. The IG is the ratio of the number of trunk channels to the number of DCME bearer channels where the same signal encoding rate is used for trunk and bearer channels. The achievable gain depends on the ensemble activity and the system size.

2.24 **transcoding gain (TG)**

The transmission channel multiplication ratio which is achieved through LRE, which effectively creates a number of low rate encoded bearer channels which is greater than the number of available transmission channels. When only a transcoding process conforming to Recommendation G.721 (i.e 32 kbit/s ADPCM) is used, the TG will equal 2. When no transcoding is used the TG will equal 1. When overload channels are created the TG will be greater than 2.

2.25 **DCME gain (DCMG)**

The trunk channel transmission multiplication ratio, which is achieved through application of DCME, including LRE and DSI. Hence $DCMG = TG \cdot IG$.

2.26 **clique**

A set of bearer channels which are associated with a set of trunk channels and which are independent in operation and control from other bearer channels. The set of trunk channels is directed to a single destination.

Note – An alternate term for clique is «bundle».

2.27 **multi-clique mode**

A DCME operational mode in which more than one clique is used when each clique is associated with a different destination.

2.28 **multi-destination mode**

A DCME operational mode where traffic is exchanged between more than two (2) corresponding DCMEs simultaneously and trunk channel traffic is interpolated over a pool of available bearer channels for all destinations having traffic in the pool. The transmit trunk channels are designated to receive trunk channels at corresponding locations.

3 **Tutorial**

3.1 *Use of digital circuit multiplication system (DCMS)*

DCMS provides the means to reduce the cost of long distance transmission by making use of the combination of Digital Speech Interpolation (DSI) and Low Rate Encoding (LRE) techniques.

DSI is used to concentrate a number of input channels (generally referred to as trunk channels) onto a smaller number of output channels (generally referred to as bearer channels). It does this by connecting a trunk channel to a bearer channel only for the period that the trunk channel is active, i.e. is carrying a burst of speech or voice-band data. Since in average conversations one direction of transmission is active for only 30 to 40 per cent of the time, if the number of trunks is large the statistics of the speech and silence distributions will permit a significantly smaller number of bearer channels (bearer channel pool) to be used. Control information must also be passed between the terminals to ensure that bearer and trunk channel assignments at each end remain synchronized.

LRE uses digital filtering techniques to construct an estimate of the waveform at both the encoder and the decoder. Since the actual information rate of speech is much lower than the channel Nyquist rate, the link used between the LRE encoder and the decoder can operate at a rate which is dependent mainly on the quality of the models and the permissible amount of transmission degradation. The CCITT has standardized in Recommendations G.721 and G.723 a type of LRE known as ADPCM, the performance of which has been extensively characterized.

The simplest way to use DCMS is in the single destination mode as shown in Figure 1/G.763. This mode of operation, is most economic for the largest routes. For smaller routes there are two options:

- operation in multi-clique mode;
- operation in multi-destination mode.

Operation in multi-clique mode, see Figure 2/G.763, divides the bearer channels into a number of blocks or «cliques», each associated with a different route. There is a fixed boundary between cliques, and trunk/bearer channel assignments are generally carried in a control channel within the clique that they refer to. This limits the dynamic processing of received channels to those which are contained in the wanted clique; selection of the wanted clique channels can be done using a simple static digital switch without reference to the assignment information. With a 2048 kbit/s bearer system in multi-clique DCMS, the statistics of the DSI are unpromising with more than three routes.

Operation in multi-destination mode, see Figure 3/G.763, permits any bearer channel to be associated with any trunk channel of any of a number of different routes. There is no segregation of routes on the bearer, and therefore at the receive terminal it is impossible to select the wanted channels without reference to the assignment information. Multi-destination mode is economic for very small routes via satellite, but practical difficulties limit the number of routes which is desirable to have on a single DCMS.

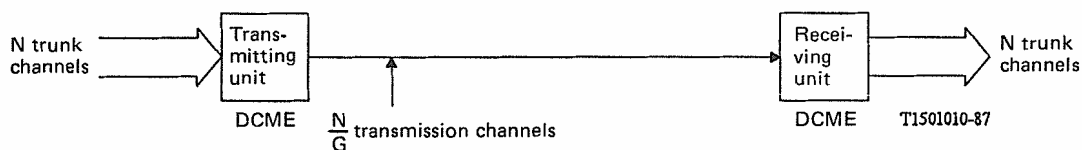

G Digital circuit multiplication gain (DCMG)

FIGURE 1/G.763

**Point-to-point mode
(only one direction shown)**

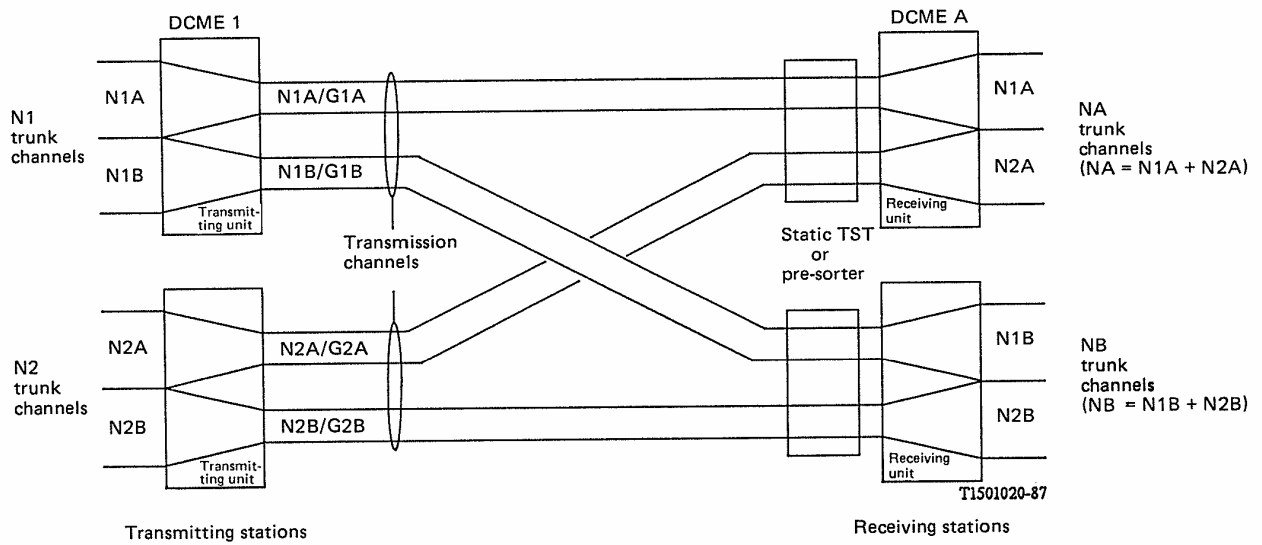

FIGURE 2/G.763

**Multi-clique mode
(only one direction shown)**

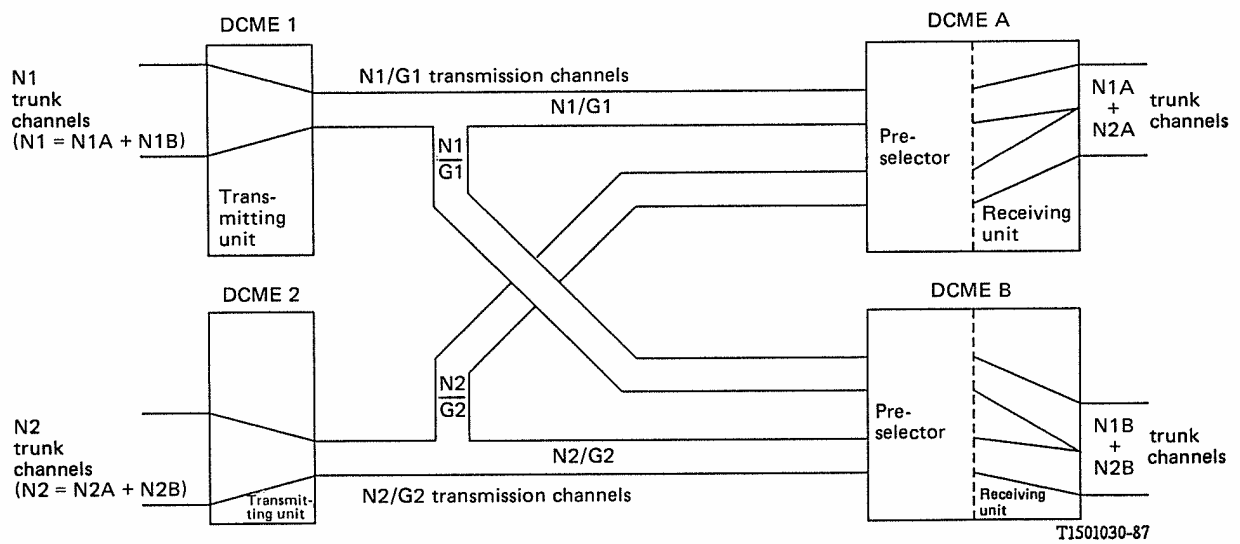

FIGURE 3/G.763

**Multi-destination mode
(only one direction shown)**

3.2 *Location*

Location of DCME depends on its use. Equipment used in single destination mode or in multi-clique mode can in general be located at the:

- ISC,
- earth station,
- cable head,

without significant restrictions.

Equipment used in the multi-clique mode will typically be located at the ISC so that the advantages of DCMG can be extended over the national section.

Equipment used in the multi-destination mode will typically be located at the earth station or cable head. The reason for this is that whereas in multi-clique mode the number of receive bearer channels at the DCME terminal is approximately equal to the number of transmit bearer channels, in multi-destination mode the number of receive bearer channels at the DCME terminal is the number of transmit bearer channels multiplied by the number of destinations. It therefore may be uneconomic to provide sufficient transmission capacity between the earth station and the ISC to permit location of multi-destination DCME at an ISC.

3.3 *Transmission requirements*

DCMS is usually required to carry any traffic which can be carried on ordinary General Switched Telephone Network (GSTN) connections. That includes voice-band data using V-series GSTN modems and facsimile calls following Recommendations T.4 and T.30 and using V.29 modems. In addition, in the ISDN, 64 kbit/s unrestricted on-demand digital data and alternate speech/64 kbit/s unrestricted bearer services must be carried.

DCMS are primarily designed to maximize the efficiency of speech transmission. Use with voice-band data especially at high rates, presents problems. These problems are mainly due to the difficulty for 32 kbit/s ADPCM to encode voice-band data waveforms.

3.4 *DCME gain (DCMG)*

The gain of DCME is the input trunk channel transmission multiplication ratio, which is achieved through application of DCME, including LRE and DSI (for a specified speech quality at a certain level of bearer channel activity). The maximum available gain depends on:

- number of trunk channels;
- number of bearer channels;
- trunk channel occupancy;
- speech activity;
- voice-band data traffic;
- ratio of half duplex to full duplex voice-band data;
- type of signalling;
- 64 kbit/s traffic;
- minimum acceptable speech quality;
- dynamic load control threshold.

Of these, the factor which has the greatest significance is the percentage of 64 kbit/s digital data traffic. This is because a trunk channel carrying 64 kbit/s traffic requires two 32 kbit/s bearer channels to be removed from the pool of channels available to the DSI process.

The percentage of voice-band data typically varies between 5 and 30 per cent, depending on the route. It is not unusual for a route to show more than a 2:1 variation, depending on time of day, with peaks which may or may not coincide for speech and voice-band data.

The type of signalling system used on the route can significantly affect the gain. Continuously compelled signalling systems hold channels active for undesirably long periods. In the case of Signalling System R2 digital signalling via a DCMS used on a satellite, the channel might be active for 5 to 14 seconds (Signalling System R2 also requires capacity for line signalling).

The measured speech activity depends on the characteristics of the activity detector. It is usual to assume an activity of 35 to 40 per cent. Outside of the route busy hour the occupancy of the trunk channels by traffic will be lower than during the route busy hour. The effect of this is to reduce the activity measured by the activity detector to about 27 per cent outside the route busy hour, whereas it will be close to the speech activity factor, i.e. about 40 per cent, during the route busy hour.

The speech quality is governed by two main factors: the LRE rate, and the amount of speech lost while a newly active trunk channel is awaiting connection to a bearer channel. If there are a great many newly active trunk channels in competition, the beginning of a burst of speech is more likely to be «clipped» or «frozen out» than if relatively few trunk channels are active.

The speech quality of a DCME in a network with external echo control devices may be affected by clipping introduced by echo control devices and by a possible noise contrast effect. In particular when echo suppressors or echo cancellers are used on low noise circuits, suppression of the far end noise may be objectionable due to noise contrast. Possible means of eliminating this problem are use of echo control devices which insert idle line noise at the appropriate level during suppression periods, or insertion of idle line noise at the DCME during the relevant period when the echo control device is integrated in the DCME.

When commissioning a new DCMS, observations should be made of the type and characteristics of the traffic which will use it. It is unwise to rely solely on customer complaints to indicate when a system is poorly dimensioned since interactions between the DCMS and echo control¹⁾ may obscure the true problem. Furthermore the consequence of trying to concentrate too many trunk channels onto too few bearers may be simply to increase the calling rate and to reduce the call holding time. This may result in greatly reduced quality, especially where continuously compelled signalling systems are used, and in levels of trunk channel activity far above what was envisaged in the original system dimensioning.

Two possible criteria for acceptable speech performance are: an average of 3.7 bits per sample and less than two per cent probability of clipping exceeding 50 ms, or alternatively less than 0.5 per cent of speech lost due to clipping.

Using the above criteria, approximations have been derived that relate the percentage of voice-band data and the number of trunk channels to the gain of a DCME using 30 bearer channels. These approximations are intended for use in initial system dimensioning and are as follows:

$$G = 0.42 + 0.73 (\log_e T) \quad \text{for less than 7\% voice-band data,}$$

$$G = -1.15 + \log_e T \quad \text{for less than 15\% voice-band data,}$$

where

G Gain

T Number of trunk channels.

These simple approximations are only valid for between 30 and 150 trunk channels with a channel activity of 37 per cent. If operation with fewer bearer channels is envisaged, then the approximations given above will tend to overestimate the achievable gain and this must be taken into account. If a more accurate representation is required, it will be necessary to carry out a first order Markov chain analysis referred to in the literature on DSI [1], [2], [3].

3.5 ISDN bearer services

DCMS are generally required to carry the full range of ISDN bearer services which can be provided on a 64 kbit/s channel as specified in Recommendation I.231. These are:

- circuit mode 64 kbit/s unrestricted, 8 kHz structured bearer service category.

This category may be used among other things for speech, multiple sub-rate information streams multiplexed by the user, or for transparent access to an X.25 public network.

¹⁾ The highest speech quality is obtained when echo cancellers conforming to Recommendation G.165 are used for echo control. However echo suppressors conforming to Recommendation G.164 and G.161 may be used.

- circuit mode 64 kbit/s, 8 kHz structured bearer service category, usable for speech information transfer.

This is broadly similar to the preceding category, but with different access protocols.

- circuit mode 64 kbit/s, 8 kHz structured bearer service category, usable for 3.1 kHz audio information transfer.

This bearer service provides the transfer of 3.1 kHz bandwidth audio information, for example voice-band data via modems, Group I, II and III facsimile information, and speech.

- circuit mode alternate speech/64 kbit/s unrestricted 8 kHz structured bearer service category.

This service is similar to both the unrestricted and speech 64 kbit/s circuit-mode bearer services, but provides for the alternate transfer of either voice or unrestricted digital information at 64 kbit/s within the same call.

3.6 *Restoration of services*

For most applications, the loss of traffic under failure conditions would be such that the installation of a single pair of terminals on a route would be insufficient without a means of rapid changeover to spare equipment in the event of failure. This means that DCME is often used in a cluster of n active terminals and one standby terminal to be loaded with the configuration information of the failed terminal. Other automatic fallback modes may be considered.

Failure of the transmission system between DCME terminals can be handled by normal transmission system restoration procedures. Failure of the transmission systems entering the DCME terminals from the exchanges may result in a wide range of different alarm conditions being experienced, particularly where a multi-destination DCME terminal serves more than one exchange and more than one route. It is desirable to limit the generation of alarm conditions to the channels which have actually failed.

3.7 *Control of transmission overload*

A reduction in the number of bearer channels available to the interpolation process can occur due to high activity of voice-band and 64 kbit/s data services or statistical variations in the ensemble input speech activity. This can lead to overload, where the number of instantaneously active trunk channels exceeds the number of available bearer channels. Action is then required to safeguard speech quality. There are four possible solutions:

- The system can be dimensioned so that with the maximum anticipated short-term trunk channel activities there is negligible probability of violating the speech quality criteria. This employs the DCMS very inefficiently outside the busy hour.
- A multi-destination system can be made to carry routes with widely different busy hours, so that although the trunk channels might have relatively low non-busy hour occupancy, the bearer channels would always be well loaded.
- Signals can be sent from the DCME to the exchange to busy-out part of the route when the quality criteria are violated. This is known as Dynamic Load Control (DLC), and can be an effective control method. However, it cannot be retroactive and it is slow to take effect. Furthermore, care must be taken to ensure that when circuits are returned to service the increase in bearer channel activity is not sufficient to result in the immediate reapplication of DLC.
- The signal-to-quantization performance can be traded against the clipping of speech burst. By using variable rate ADPCM algorithms, it is possible to quantize to three, rather than four, bits on individual speech channels on a pseudo-cyclic basis for a given number of samples. In this way the system can be given a gradual degradation characteristic, rather than a sudden overloading.

Practical DCMS are likely to require some or all of these techniques to be used.

3.8 *Control channel*

Because the assignment of trunk channels to bearer channels is continually changing, it is necessary to provide a control information channel between the transmit and the receive units to ensure that their assignment maps correspond. This channel carries information for assignments, changes of coding rates, message refreshments, 64 kbit/s channel allocations and other system and management messages. It should be carried in a permanently allocated time slot which includes forward error correction, so that transmission errors do not cause the transmit and receive assignment maps to go out of step.

4 **DCME functions**

This Recommendation is applicable to DCME designs in both directions of transmission.

The purpose of DCME is to provide maximum effective use of transmission facilities in the digital operating environment, using DSI and LRE techniques. At a minimum, the DCME functions shall include:

- interpolation of speech signals (DSI);
- transcoding of 64 kbit/s PCM to ADPCM (LRE) when applicable;
- the means to carry the ISDN bearer services given in § 4.4;
- one or more of the following operating modes:
 - i) point-to-point,
 - ii) multi-clique,
 - iii) multi-destination;
- speech detection;
- voice-band data detection;
- a means for transmit detection and receive injection of background noise;
- the means to accommodate non-interpolated preassigned traffic;
- a means for interterminal communication (control channel);
- a means for exchanging signals with an ISC for purposes of ISDN bearer services involving 64 kbit/s unrestricted traffic, DLC, and alarms;
- time slot interchange;
- the ability to support the signalling systems identified in § 4.12.

4.1 *Digital speech interpolation*

The DCME shall incorporate digital speech interpolation (DSI) techniques to achieve a reduction in the composite transmission rate of the 64 kbit/s trunk channels.

4.2 *DCME low rate encoding algorithm*

The DCME shall operate with a nominal low rate encoding gain of 2:1 through the use of adaptive differential pulse code modulation (ADPCM) techniques. The DCME shall incorporate the algorithms defined in Recommendation G.721 and G.723. These algorithms include provisions for transcoding the 64 kbit/s PCM input signal to 24 kbit/s ADPCM during overload conditions, to 32 kbit/s ADPCM during normal operation, and to 40 kbit/s for voice-band data.

4.3 *DCME gain*

The DCME shall combine digital speech interpolation and low rate encoding techniques to achieve a reduction in the composite transmission rate of the 64 kbit/s trunk channels.

4.4 *DCME bearer services*

The DCME shall respond to the following ISDN bearer service requests from its associated ISCs:

- a) speech;
- b) 3.1 kHz audio (data and speech);
- c) 64 kbit/s unrestricted.

4.5 *Operational modes*

The following three modes of operation are described:

- a) point-to-point;
- b) multi-clique; and
- c) multi-destination.

4.5.1 *Point-to-point mode* (see Figure 1/G.763)

The transmit side DCME concentrates N trunk channels at 64 kbit/s into N/G transmission channels. The transmission channels represent a number of time shared variable bit rate (bearer) channels which are grouped into a primary rate multiplex format.

At the receive side, the receiving DCME simply demultiplexes the primary-rate format and reconstitutes the N trunk channels from the N/G transmission channels.

4.5.2 *Multi-clique mode* (see Figure 2/G.763)

In this mode the pool of bearer channels is subdivided into two or three independent pools (cliques) of fixed capacity, each pool corresponding to an individual destination. While the aggregate bearer bit rates for both the transmit side and the receive side are equal, the DCMG of each clique may be different, since this gain is a function of the number of input channels, routed within each clique.

It is desirable to limit the number of cliques within a primary-rate bearer to two or three. Figure 2/G.763 indicates one form of this approach in which the primary-rate bearer circuit is assumed to be available to each of the DCM nodes, but each node has the capability of preselecting the traffic that is intended for it.

4.5.3 *Multi-destination mode* (see Figure 3/G.763)

In this mode, the input trunk channels are interpolated over a common pool of bearer channels, regardless of their destination. The input trunk channels are destination preassigned so that they may be routed to the appropriate destination in accordance with the assignment channel messages. This operational mode permits higher DCM gains than the multi-clique mode, but its usefulness is limited if the DCME is located at the ISC.

4.6 *Activity detector*

4.6.1 *Purpose*

The purpose of the activity detector is to recognize when a valid signal is applied to the input of the DCME, which results in a request for an available bearer channel for transmission of the valid signal. The activity detector must:

- a) detect low-level activity on a quiet input trunk channel;
- b) reject high-level noise on an input trunk channel;
- c) avoid introducing front end clipping on signals;
- d) minimize false operation on impulse noise;
- e) avoid clipping during a signalling sequence;
- f) avoid clipping on facsimile messages during page changes.

4.6.2 *Activity detector characteristics (under study)*

The activity detector characteristics are based upon the assumption that the frequency response of the transmission channel up to the input of the activity detector is ± 0.5 dB with respect to 1020 Hz over the frequency band from 300 to 3400 Hz, and that the level of any single audio frequency, measured selectively on an idle channel, should not exceed -50 dBm₀.

4.6.2.1 *Operating threshold and operation time for variable threshold*

The transmit activity detector threshold shall automatically adjust relative to the average power of Gaussian noise band limited between 300 to 3400 Hz.

The threshold and operate time of the transmit activity detector may operate in a manner which is equivalent to an activity detector with the characteristics given below (see note).

Note – All parameter values are provisional and under study.

<i>Average signal power</i>	<i>Operate time</i>
< - 40 dBm0	OFF
≥ - 40 dBm0, ≤ - 30 dBm0	Figure 4/G.763
> - 30dBm0	2 ms < t < 4 ms

The operate time requirements will be satisfied while permitting tolerances on the average signal power of any stimulus signal in the frequency band at boundary conditions as follows:

- 40 dBm0	± 1.5 dB
- 30 dBm0	± 1.0 dB

The rate of change of the transmit activity detector adaptive threshold will be between 2.5 dB/s and 20.0 dB/s.

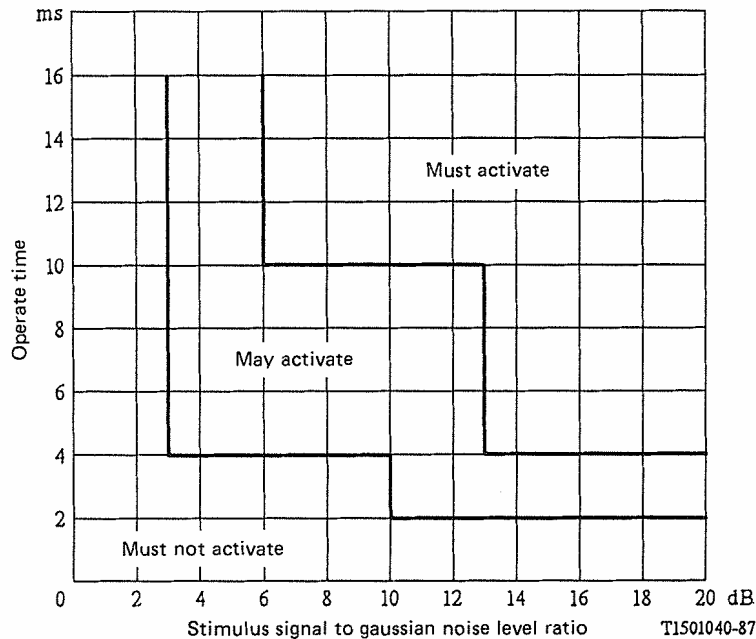

Note 1 – Mask applicable to stimulus signals which are ≥ - 40 dBm0, but ≤ - 30 dBm0.

Note 2 – Stimulus signal to be 1020 Hz sinusoid.

FIGURE 4/G.763

Transmit activity detector operate threshold mask

4.6.2.2 Interaction of the transmit activity detector with echo control devices

The threshold of the transmit activity detector shall not adapt to Gaussian noise level variations which are due to the actions of echo suppressors or echo cancellers. This may be accomplished by any means which is functionally equivalent to providing an inhibit signal from a receive activity detector when activity is present in the receive channel.

4.6.2.3 *Hangover time*

The permissible hangover time as a function of stimulus signal duration shall be within the mask shown in Figure 5/G.763 for Signalling System No. 5 and within the mask shown in Figure 6/G.763 for Signalling Systems No. 6, 7 and R2D.

It shall be possible to select the required type of hangover time mask. For voice-band data, the hangover time should be extended so that it is sufficiently long to bridge FAX page changes. This time may be as long as 14 s.

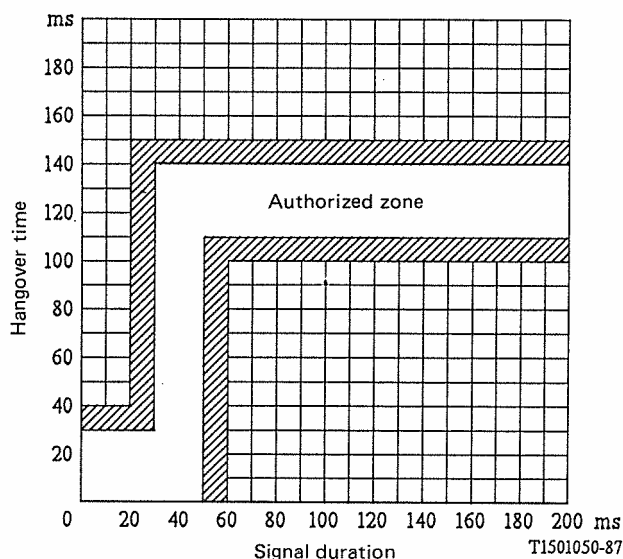

FIGURE 5/G.763

Hangover time mask for Signalling System No. 5

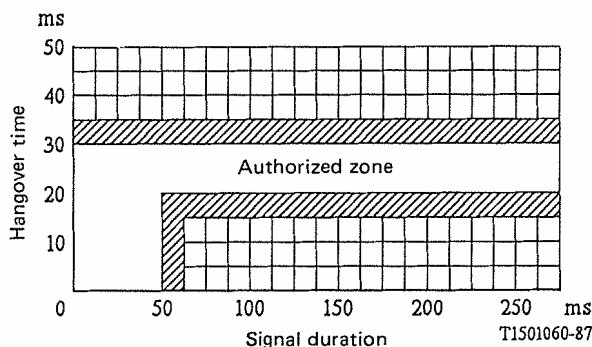

FIGURE 6/G.763

Hangover time mask for Signalling Systems No. 6 , 7 and R2D

4.7 *Data/speech discrimination*

4.7.1 *Purpose*

The DCME data detector shall be capable of discriminating between voice-band data and speech. This discrimination is necessary in order to assign the voice-band data signal to a non-overloaded bearer channel and to eliminate or minimize front end clipping of the data signal.

4.7.2 *Data/speech discrimination characteristics*

Most of the V-Series modems use the 2100 Hz disabling tone for the purpose of disabling echo control devices. The 2100 Hz echo control disabling signal shall be used to identify those input trunk channels where the active signal is in-band data originating from 2-wire PSTN data modems. Upon detecting the 2100 Hz disabling tone with or without phase reversal (see Recommendation V.25), a particular call shall be designated as data through the DCME.

4.8 *Control channel*

The control channel shall include provisions for accommodating the following categories of inter DCME-terminal messages:

- trunk-to-bearer assignment;
- idle noise level;
- dynamic load control;
- alarm information;
- self diagnostic information;
- signal classification.

In addition, the control channel shall include DCME frame synchronization and the messages shall be protected against bit errors occurring on the bearer channel.

A dedicated 32 kbit/s channel shall be used; however, the precise format and operation is under study.

4.9 *Communication to the ISC*

The DCME shall communicate with the ISC in accordance with Recommendation Q.50.

4.9.1 *Dynamic load control (DLC)*

The DCME shall generate dynamic load control messages for the following two categories of traffic:

- a) speech and 3.1 kHz audio, and
- b) 64 kbit/s unrestricted.

The DCME shall provide a dynamic load control signal which may be sent to the local and distant telephone switching centres to limit the traffic load presented to the DCME during overload conditions. The dynamic load control signal is activated by monitoring load parameters for the interpolated speech and the 64 kbit/s unrestricted channels.

Overload conditions should be indicated by the average number of bits per sample calculated for each clique. When the value falls below a particular, previously set threshold level, the DLC message should be generated at the DCME. DLC messages shall be sent back to the local ISC(s), and the distant DCME shall be informed through the control channel. The distant DCME shall interpret and appropriately convey the DLC information to its associated ISC(s).

The DLC condition shall be reset automatically when the average number of bits per sample exceeds a second, previously set threshold.

4.9.2 *Dynamic load control activation/deactivation criteria*

Speech and 3.1 kHz audio dynamic load control activation messages shall be generated when the average number of bits per sample drops below a preset threshold.

The 64 kbit/s unrestricted dynamic load control activation messages shall be generated when:

- a) the measured number of assigned 64 kbit/s unrestricted channels exceeds a preset threshold, or
- b) the speech and 3.1 kHz audio dynamic load control has been activated, or
- c) the speech and 3.1 kHz audio dynamic load control is expected to be activated due to an increase of one additional channel in the 64 kbit/s unrestricted traffic loading.

Dynamic load control activation shall occur immediately upon satisfying the threshold criteria. Dynamic load control deactivation messages shall be generated when the average number of bits per sample exceeds a preset threshold or the number of 64 kbit/s unrestricted channels falls below a preset threshold. If the 64 kbit/s dynamic load control is not active, 64 kbit/s unrestricted channel requests shall not be refused. Dynamic load control deactivation shall not occur earlier than a programmable interval which has a minimum of 10 s.

4.9.3 *Establishment and release of 64 kbit/s unrestricted class connections*

The DCME shall establish/release 64 kbit/s unrestricted duplex connections under control of the seizing/releasing ISC as part of the call set-up/clearing process between exchanges. Dedicated seizure/select and release messages and the associated acknowledgement messages are exchanged between the DCME and the ISC as defined in Recommendation Q.50.

Subject to the capability of the ISC, this process is usable for performing the in-call modifications between the DCMEs during alternate speech/64 kbit/s unrestricted type calls.

Upon reception of a seizure/select message from the ISC for a trunk, the DCME shall perform the necessary internal checks, including the 64 kbit/s unrestricted dynamic load control status, for the accommodation of this call and an acknowledgement (positive or negative) message shall be returned as soon as possible to the calling ISC. The calling end DCME shall initiate the establishment of the unrestricted 64 kbit/s forward connection to the called end DCME using a special identifier in the assignment message. The called end DCME, upon receipt of this message, shall automatically initiate the establishment of the unrestricted 64 kbit/s return connection. Failure to complete the establishment of a 64 kbit/s circuit between DCMEs shall be reported to the ISC as soon as this has been detected internally. This reporting shall be in the form of an out-of-service message.

Upon receipt of a release message from the calling ISC, the releasing end DCME shall initiate the release of the unrestricted 64 kbit/s forward connection, and the opposite end DCME shall automatically initiate the release of the unrestricted 64 kbit/s return connection. Upon completion of this process, a positive release acknowledgement message shall be returned to the releasing ISC. Failure to complete the release shall be reported to the releasing ISC using the out-of-service message and the DCME shall put the trunk in a blocked condition.

After manual or automatic removal of any failure condition, the DCME shall put the trunk in an idle condition and send a back-in-service message to the ISC.

A calling end DCME shall detect a release initiated by the opposite end (non-controlling) ISC by the reception of a disconnect message in the control channel. This abnormal release shall be recognized as a dual seizure situation being resolved between the ISCs. The detecting DCME shall first complete the release normally and immediately attempt to re-establish the released 64 kbit/s unrestricted duplex connection between the DCMEs.

4.10 *Trunk channel idle noise level detection and injection*

The DCME transmit unit shall measure the trunk channel idle noise level and forward this information to the corresponding DCME receive unit, which shall insert the appropriate idle level noise within the receive output speech channel during silent intervals following disconnection of the bearer channel. The idle level noise shall not be inserted on 64 kbit/s unrestricted channels.

4.11 *Time slot interchange (TSI)*

The DCME shall include a time slot interchange capability on the trunk side interface so that a given time slot at the transmit unit can be assigned to any time slot on the receive unit.

4.12 *Signalling transmission*

The DCME shall support the following signalling systems:

- Signalling System No. 5
- Signalling System No. 6 (both analogue and digital versions)
- Signalling System No. 7
- Signalling System R1 under study (Note 1)
- Signalling System R2 (Note 2)

Signalling detection is under study.

Note 1 – Signalling System R1 may be supported, but a special signalling interface will be required.

Note 2 – Transmission of R2D line signalling in the control channel is recommended.

4.13 *Voice-band data transmission*

Once a voice-band data call is recognized by the DCME, the DCME system shall not introduce any degradation to the voice-band data block error rate performance beyond that normally encountered by a single encoding of the ADPCM codec used in the DCME for voice-band data transmission.

4.14 *Echo protection*

The DCME shall not activate transmission in the transmit direction as the result of receive signals. Such activation increases the apparent speech activity factor and reduces the DCME gain. Therefore, echo in the transmit signal resulting from the receive signal must be removed, but this echo control function is not required to be a part of the DCME.

A network echo control device meeting or exceeding the requirements of Recommendations G.165, G.164 or G.161 is required on all trunk channels carrying speech serviced by a DCME²⁾

4.15 *Bearer channel preassignment*

The DCME shall permit trunk channels to be preassigned to bearer channels. The 64 kbit/s trunk channels may be preassigned to any of the following:

- channels subject to 32 kbit/s ADPCM,
- channels subject to 40 kbit/s ADPCM,
- channels transmitted using 64 kbit/s.

5 **Interfaces**

The transmission interface to the international switching centre (ISC) or national transmission medium (trunk side) shall be at the primary hierarchical rates of either 2048 kbit/s or 1544 kbit/s. The transmission interface to the national or international transmission medium (bearer side) shall be at either 2048 kbit/s or 1544 kbit/s. The data rates on the trunk and bearer sides are normally the same.

In the case of interworking between the 1544 kbit/s and 2048 kbit/s hierarchies on the same DCMS, it is recommended in Recommendation G.802 that the bearer system should be 2048 kbit/s. Nevertheless, there may be operational difficulties with such interworking depending on whether the DCME is Type 1, where the DCME cannot communicate with the ISC, or Type 2, where it can, as defined in Recommendation Q.50.

5.1 *Transmission interface; trunk side*

5.1.1 *Trunk side interface at 2048 kbit/s*

- a) The electrical characteristics shall comply with Recommendation G.703. The test load impedance shall be either 75 Ω unbalanced or 120 Ω balanced depending on the user requirement.

²⁾ The French Administration has indicated that improved echo suppressor performance, superior to Recommendations G.164 and G.161, can be achieved by incorporating an echo suppressor within the DCME, because advantage can be taken of the more sophisticated speech detection incorporating a delay line to reduce break-in and double-talk clipping.

- b) The frame structure shall comply with Recommendation G.704.
- c) The encoding law for voice frequency signals shall conform to the A-law system described in Recommendation G.711.

5.1.2 *Trunk side interface at 1544 kbit/s*

- a) The electrical characteristic shall comply with Recommendation G.703. The line code adopted shall be either AMI or B8ZS depending on the user requirement.
- b) The frame structure shall comply with Recommendation G.704. The multiframe size shall be either 24 frames or 12 frames depending on the user requirement.
- c) The encoding law for voice frequency signals shall conform to the μ -law system described in Recommendation G.711.

5.2 *Transmission interface: bearer side*

5.2.1 *Bearer side interface at 2048 kbit/s*

5.2.1.1 *Electrical characteristics*

The electrical characteristics shall comply with Recommendation G.703. The test load impedance shall be either 75 Ω unbalanced or 120 Ω balanced depending on the user requirement.

5.2.1.2 *Bearer frame structure*

The bearer frame structure shall comply with Recommendation G.704. Time slot 0 shall be used as recommended in Recommendation G.704 and time slots 1 to 31 shall carry control channels and traffic according to the DCME frame structure.

5.2.2 *Bearer side interface at 1544 kbit/s*

5.2.2.1 *Electrical characteristics*

The electrical characteristics shall comply with Recommendation G.703. The test load impedance shall be 100 Ω resistive.

5.2.2.2 *Bearer frame structure*

The bearer frame structure shall comply with Recommendation G.704.

Provisions shall be included in the bearer frame structure to accommodate control channels and traffic according to the DCME frame structure.

The 193rd bit shall be used for frame synchronization as recommended in Recommendation G.704.

5.3 *Control interfaces to switching equipment (at the ISC)*

The choice of interface is considered to be a national matter and left for each Administration to define within the constraints of their transmission facilities and ICSSs.

The control interface to the switching equipment is dependent on the capability of the ISC and the facilities between the ISC and the DCME (see Recommendation Q.50).

5.4 *Man-machine interface*

The DCME shall contain a system command structure which serves as a menu-driven interface between internal functions and the system operator. Typically two RS 232C/V24 ports are necessary to provide operator access to the equipment: one for a display terminal and one for a printer.

5.5 *Operations function interface(s)*

5.5.1 *Trunk side operation at 2048 kbit/s or 1544 kbit/s*

The utilization of spare bits for monitoring and error protection shall be in accordance with Recommendations G.704 and G.706.

Details covering the use of the above in an equipment specification are under study.

5.5.2 *Bearer side*

5.5.2.1 *Single destination mode*

The utilization of spare bits for monitoring and error protection is under study.

5.5.2.2 *Multi-clique or multi-destination mode*

The utilization of spare bits for monitoring and error protection is under study.

5.6 *Local alarms interface (provisional)*

The DCME must present alarms to the local entity according to the user's requirement. The choice of the physical/electrical interface is to be decided by the individual Administration. In the case of individual voltage-free loop alarms, the categories of alarm in Recommendation G.803 should be included. In the case of a serial alarm interface, it is recommended to provide as a minimum the following signals:

- a) initial occurrence of an alarm in the monitored DCME;
- b) initial occurrence of a clear in the monitored DCME;
- c) receipt of a data request from the local entity;
- d) initial system power-on.

Note – The inclusion of Telecommunications Management Network (TMN) protocols and interface requirements in future DCME Recommendations is planned.

5.7 *External clock interface*

5.7.1 *DCME working with 2048 kbit/s transmission interfaces*

The external clock interface shall comply with Recommendation G.703, § 10.3. The test load impedance shall be either 75 Ω unbalanced or 120 Ω balanced depending on the user requirement.

5.7.2 *DCME working with 1544 kbit/s transmission interfaces*

The timing normally derived from an incoming digital link at 1544 kbit/s complying with Recommendation G.703, § 2. Where required an external clock interface may be provided.

6 Timing synchronization

6.1 *General*

Timing synchronization of DCME can be achieved in many ways and care should therefore be taken in any implementation to ensure that the configuration adopted is correct.

6.1.1 *Reference clock*

The DCME reference clock shall be derived from a source which meets the requirement of Recommendation G.811. For networks that entail one international destination, loop timing can be used as an alternative at one end of the link. The need for an internal reference clock for use under failure conditions is for further study.

6.1.2 *Plesiochronous slips*

The slip rate shall not exceed the requirements of Recommendation G.822. Controlled slips at 2048 kbit/s on the trunk side shall be 2 frames, controlled slips at 1544 kbit/s and on the bearer side require further study.

6.1.3 *Buffer sizes and locations*

Table 1/G.763 indicates suitable buffer sizes and locations for the 2048 kbit/s hierarchy for the various synchronization options which are detailed in Appendix I. A table for the 1544 kbit/s hierarchy is under study.

TABLE 1/G.763

Synchronization type (Note 1)	Buffer size (Note 2)	Slip size (Note 3)	Location (Note 4)	Figure No. of Appendix I
<i>No buffering</i>				
Asynchronous	No buffer	–	–	I-1/G.763
Synchronous	No buffer	–	–	I-2/G.763, I-12/G.763, I-15/G.763
Synchronous analogue-to-digital	No buffer	–	–	I-5/G.763
<i>Plesiochronous buffering</i>				
Asynchronous	0.5 ms	2 frames	Trunk side	I-3/G.763 I-4/G.763,
Synchronous	0.5 ms	2 frames	Bearer side	I-13/G.763, I-16/G.763
<i>Plesiochronous/doppler buffering</i>				
Synchronous	1.7 ms	2 frames	Bearer side	I-6/G.763, I-11/G.763, I-14/G.763, I-17/G.763, I-19/G.763
Synchronous	2.4 and 1.7 ms		Bearer side and trunk side	I-7/G.763
Asynchronous	1.7 ms	2 frames	Trunk side	I-9/G.763
Synchronous	2.4 et 1.7 ms		Trunk side and bearer side	I-8/G.763
Synchronous	1.7 ms	2 frames	Trunk side	I-10/G.763, I-18/G.763

Note 1 – Asynchronous refers to the case where the transmit unit and receive unit of the same DCME terminal are deriving their timing from different clock sources.

Note 2 – Buffer sizes are derived from the following:

- single doppler with plesiochronous buffer: $(0.6 \text{ ms} \times 2) + 0.5 = 1.7 \text{ ms}$;
- double doppler buffer: $1.2 \text{ ms} \times 2 = 2.4 \text{ ms}$;
- plesiochronous buffer for 2 PCM (2048 kbit/s) frames: 0.5 ms.

The doppler buffer size used is an example for a specific satellite. These buffer sizes may need to be adjusted taking into account the orbital parameters of the satellite in use.

Note 3 – The slip size of 2 PCM frames is based upon the requirement in the 2048 kbit/s frame to maintain frame alignment.

Note 4 – In general it is preferable to avoid placing the plesiochronous slip buffers on the bearer side of the DCME to minimize disruptions caused by slips. This may not be possible under all circumstances.

6.1.4 Terminal synchronization

The DCME terminal shall be capable of deriving its timings from any of the incoming digital links or from an external clock. When the synchronization is derived from the trunk receive side, it is recommended that a fallback trunk receive synchronization source is allocated in the event of the primary channel receiving an alarm condition indicating a received line signal failure, loss of frame alignment, AIS or receive BER $\geq 10^{-3}$. Switching between primary and fallback sources shall be automatic.

7 Performance

7.1 *Speech performance*

Recommendation P.84³⁾ describes a subjective test method for comparing the performance of DCME systems against suitable reference conditions for carefully defined input signals. Recommendation P.84 consists of listening tests and is the recommended source of information about subjective testing of DCME. These tests are a first step and do not preclude the need for conversational tests.

It is recommended that a fixed delay be inserted in the transmit speech path to reduce the probability of front end clipping. This delay compensates for activity detection time and DCME assignment message connection delay. The delay should be such as to assure that the main speech spurt clipping is less than 5 ms.

7.2 *Voice-band data performance*

Paragraph 2.3 refers to Recommendation G.721 (32 kbit/s ADPCM algorithms) and to Recommendation G.723 (24 kbit/s and 40 kbit/s algorithms derived from Recommendation G.721), which have been selected for use in DCME. Extensive testing has demonstrated satisfactory voice-band data performance for the 40 kbit/s algorithm specified in Recommendation G.723 for a voice-band data rate of 9600 bit/s.

Voice-band data at rates greater than 9600 bit/s may be satisfactorily transmitted, but in any event a 64 kbit/s unrestricted channel can be selected through the DCME which will accommodate voice-band data rates at 14400 bit/s.

8 System management functions

8.1 *Transmission facilities*

Each terminal should monitor each incoming digital link for the following conditions or parameters and store separate cumulative counts of each type of event as required by users:

- AIS, remote alarm indication;
- loss of incoming signal, loss of frame alignment, reframe rate;
- severely errored seconds;
- degraded minutes;
- slips, slip rate.

8.2 *Terminal traffic handling performance*

The DCMS terminals shall monitor and store records of the various parameters needed to evaluate the traffic handling performance being provided.

8.2.1 *Measurement of statistics* (see Table 2/G.763)

Measurements and calculations, other than for BER, shall be done only on non-preassigned trunk channels which are defined in the configuration data. The DLC-on ratio for voice/voice-band data and the DLC-on ratio for 64 kbit/s unrestricted traffic shall be obtained separately for each destination. All other parameters shall be obtained separately for each transmit pool.

The measurements of each parameter shall be made over Statistics Time Interval (STI) determined by the operator. Each statistic shall be calculated once every update interval (e.g. 30s), with the accumulated data from every sampled DCME frame (e.g. each 10th frame) over the previous averaging period (e.g. 1 min). The average over the STI shall be the average of the values calculated each update interval during the STI within the range from 10 min to 60 min (in 10 min steps).

The definitions of the Quality of Service and offered traffic statistics are given in Appendix II.

During the STI, the average BER shall be calculated at the end of each 1 minute interval, the voice freezeout excess shall be calculated from the 1 min values of voice queue freezeout fraction and the BER excess shall be calculated from the 1 min values of average BER.

The summary statistics calculated at the end of the STI shall be output to a statistics data file on a secure storage medium (e.g. non-volatile RAM, hard disk. etc.).

³⁾ The specifications in Rec. P.84 are subject to future enhancement and therefore should be regarded as provisional.

TABLE 2/G.763

DCME management statistics

Service to be measured	Quality of service statistics	Offered traffic statistics
Voice	(1) Bits per sample (2) Voice queue freezeout fraction (3) Voice freezeout excess	(4) Voice activity ratio (5) DLC voice-on ratio
Data	(6) Data queue freezeout fraction	(7) Data activity ratio
64 kbit/s on demand	(8) 64 kbit/s failed seizures ratio	(9) 64 kbit/s connected ratio (10) 64 kbit/s DLC-on ratio
All services	(11) Average BER (12) BER excess (13) Severely errored seconds (14) Degraded minutes	

Note – Statistics (1) to (4) and (6) to (9) shall be calculated separately for each transmit pool.

Statistics (5) and (10) shall be calculated separately for each destination.

Statistics (11) and (12) shall be calculated separately for each receive control channel.

Statistics (13) and (14) shall be calculated separately for each incoming digital link according to Recommendation G.821.

8.3 *Synchronizer*

The state of synchronization of each primary group interface, the selected clock source, and the times of any failures or changes of clock source should be monitored.

8.4 *Communication links*

The condition of all communication links should be monitored to detect failures as far as practicable, including:

- control channels;
- ISC-DCME interface;
- man-machine interface.

8.5 *Reports*

The terminal should:

- a) at operator defined intervals, or when set parameters have been exceeded, or as a worst 15-minutes report for any 24 hours period, file operator selected parameters from those monitored and stored, including header information such as terminal identification, date, and measurement period covered by the file;

- b) compare selected parameters, status or measurements with predetermined conditions;
- c) upon detection that predetermined conditions have been met or exceeded for a given period of time, take the necessary action(s) which may include:
 - 1) filing of an anomaly report;
 - 2) transmission of alarm signals;
 - 3) block all new calls due to failure;
 - 4) switch to standby, if available;
 - 5) total shut down of the terminal.

8.6 *System configuration*

The terminal shall include a non-volatile back-up memory containing a copy of the latest configuration of the DCME, for use in failure situations. A non-working spare copy should also be provided to allow changes in configuration to be made without impact upon service security. In cases where cluster operation of terminals is used to provide additional service security, means must be provided for the standby terminal to adopt the configuration of the working terminal which it is intended to replace.

The configuration information shall include details of trunk side interface channel connections, modes of operation of any preassigned channels, any restrictions in force to any destination or on any block of circuits (e.g. limit on the number of 64 kbit/s calls).

8.7 *Failure strategy*

Upon detection of conditions affecting the service, the DCME shall take the appropriate actions to protect existing traffic, such as switching to fallback timing sources or fallback units where redundancy is provided, transmission of DLC signals, disconnection of failed circuits, transmission of any appropriate alarm conditions.

9 **Maintenance functions and alarms**

9.1 *Maintenance functions*

The DCME should provide the following maintenance functions:

- a) facilities for disabling (terminal out-of-service test):
 - digital speech interpolation;
 - low rate encoding (ADPCM);
 - variable bit rate coding;
- b) facilities for providing fixed connections of specific trunk channels to specific bearer channels, at 32 kbit/s without interpolation, 40 kbit/s without interpolation and 64 kbit/s interpolation;
- c) facilities for protected monitoring points (under study).

9.2 *DCME alarm conditions*

Alarm conditions and the appropriate consequent actions are defined as follows:

9.2.1 *Normal traffic carrying operating conditions*

The following shall apply when the DCME is carrying traffic, when no digital links are exhibiting fault conditions and when the DCME is also not exhibiting a fault condition:

- a) the absence of alarm indications on the DCME terminal shall indicate a normal condition;
- b) the means used on the DCME terminal to indicate operating modes or to provide routine information shall be of such form, colour or type that they cannot be confused with alarm conditions.

9.2.2 *Time delay*

Optionally, a time delay, selectable up to three seconds maximum, shall be provided before alarms are initiated or indications are transmitted in fault conditions categories A, B, C and/or D of Table 3/G.763, as appropriate.

9.2.3 *Fault conditions and consequent actions*

Table 3/G.763 shows various fault conditions and consequent actions which are externally observable.

TABLE 3/G.763

Consequent actions

	Fault condition	Alarm (Note 4)	Apply to bearer side, towards distant terminal (Note 5)	Apply to trunk side of own network (Note 5)	Other action
A	Failure of incoming 1.5- or 2-Mbit/s trunk from own network (Note 1) (See conditions G, E)	Prompt	Message in control channel to indicate which 64 kbit/s trunks are affected	AIRE in affected trunk	Management report ^{a)}
B	Failure of bearer from distant end (Note 1) (See condition F)	Prompt	Remote alarm message in control channel and AIRE	AIS in all affected trunks	Management report ^{a)}
C	AIS in incoming 1.5- or 2-Mbit/s trunk from own network (See conditions G, E)		Message in control channel to indicate which 64 kbit/s trunks are affected	AIRE in affected trunk	Management report ^{a)}
D	AIS in bearer from distant end (See condition F)		Remote alarm in control channel and AIRE	AIS in all affected trunks	
E	Remote alarm indication in incoming 1.5- or 2-Mbit/s trunk from own network (See conditions A, C)		Message in control channel to indicate which 64 kbit/s trunks are affected		Management report ^{a)}
F	Remote alarm message in control channel and AIRE (Note 2) (See conditions B, D)			Extend remote alarm indication in all appropriate trunks (optional)	
G	Message in control channel of bearer to indicate failure or AIS in a 1.5- or 2-Mbit/s trunk incoming from distant end (See conditions A, C)			All "1s" in affected 64 kbit/s trunks and "out of service" code via an ISC to DCME link	
H	Timing source failure	Prompt if unprotected deferred if protected			Management report ^{a)} and switch to fall back source when available

TABLE 3/G.763 (continued)

Fault condition		Alarm (Note 4)	Apply to bearer side, towards distant terminal (Note 5)	Apply to trunk side of own network (Note 5)	Other action
J	DCME failure (not power failure, but self-test routine)	Prompt is deferred depending upon nature of failure	AIS, if necessary, dependent upon nature of failure (for prompt alarms only)	AIS, if necessary, upon nature of failure (for prompt alarms only)	Managements report ^{a)}
K	DCME power failure	Prompt when service affecting, deferred otherwise	AIS if possible when service affecting	AIS if possible when service affecting	Managements report ^{a)} if possible
L	Speech performance degraded (Note 3)	Prompt or deferred, depending upon level of degradation			– Management report ^{a)} – Apply DLC or STM as appropriate via the ISC DCME link
M	1.5- or 2-Mbit/s trunk BER between 10^{-6} and 10^{-3}	Deferred			Managements report ^{a)}
N	Bearer BER between 10^{-6} and 10^{-3}	Deferred	Message in control channel to distant end		Managements report ^{a)}
O	Receive message in control channel for BER between 10^{-6} and 10^{-3}	Deferred			Managements report ^{a)}
P	Control channel error rate exceeds threshold (under study)	Prompt	Remote alarm message in control channel and AIRE	AIS in all affected trunks	Managements report ^{a)}

^{a)} Denotes management report, printout or information storage for maintenance.

STM Synchronous transfer module

AIS Alarm indication signal

AIRE Alarm indication to remote end

Note 1 – The fault conditions are loss of incoming signal, loss of frame alignment or a bit error ratio greater than 10^{-3} as defined in Recommendations G.737, § 4.1, and G.734, § 3.1 for 2048 and 1544 kbit/s digital links, respectively.

Note 2 – “Fault condition” is a network condition. DCME should optionally pass on the condition transparently for recognition and action by own network.

Note 3 – The following conditions must exist before the alarm for speech performance degradation operates:

a) Deferred alarm: the average number of encoding bits per sample, as defined in Appendix II, is less than a present threshold determined by subjective criteria (for further study) for a period “x” seconds (to be determined);

b) Prompt alarm: the “voice queue freezeout fraction” exceeds a selectable threshold (value under study). The possibility of additionally using “voice freezeout excess” and/or measuring the length of freezeout instances is also under study.

Note 4 – Recommendation G.803 defines the alarm categories.

Note 5 – The DCME shall not cause any indeterminate or unknown conditions when AIS is injected into its network, either on the trunk or the bearer side of the DCME.

APPENDIX I

(to Recommendation G.763)

Timing synchronization

The following figures provide a number of examples of Doppler and plesiochronous slip buffer placements for a variety of network synchronization schemes. In the figures it is assumed that all buffers will derive their write clocks from the input bit stream.

The following drawing convention is used:

..... Timing path

_____ Traffic path.

I.1 *Point-to-point operation*

I.1.1 *Terrestrial operation within a national network*

Figures I-1/G.763 and I-2/G.763 show methods of DCME terminal synchronization for operation within a national network.

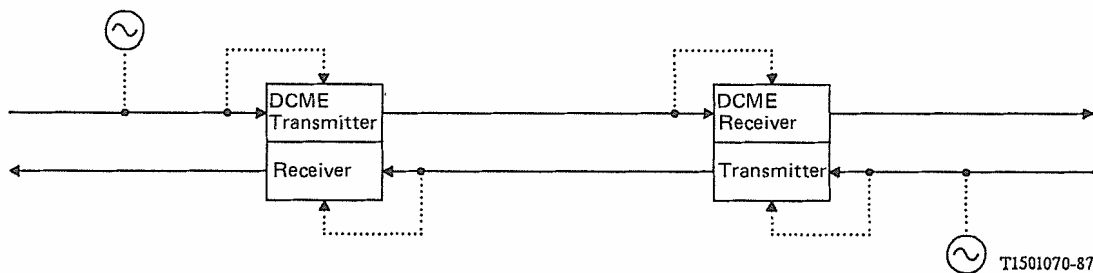

FIGURE I-1/G.763

**DCME synchronous (independent) operation
(in a single asynchronous network)**

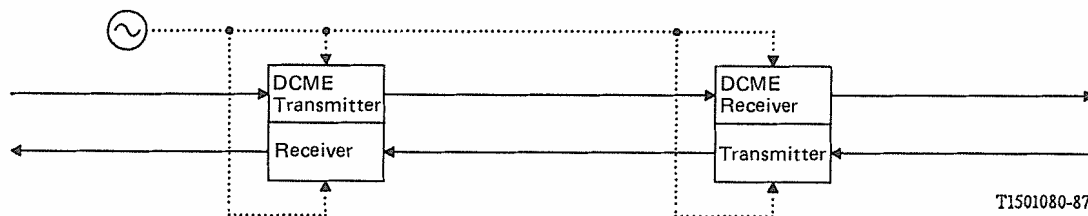

FIGURE I-2/G.763

**DCME synchronous operation
(in a single synchronous network)**

I.1.2 Terrestrial operation between national networks

Figures I-3/G.763, I-4/G.763 and I-5/G.763 show methods of terminal synchronization for operation between national networks via terrestrial networks. Plesiochronous buffers are required for networks as shown in Figures I-3/G.763 and I-4/G.763. Figure I-5/G.763 utilizes loop timing and therefore does not require plesiochronous buffering.

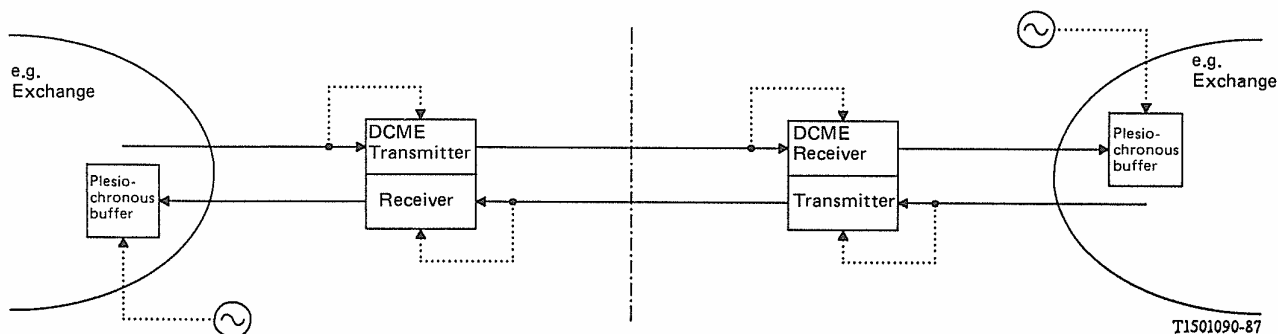

FIGURE I-3/G.763

**DCME synchronous (independent) operation
(between two plesiochronous networks)**

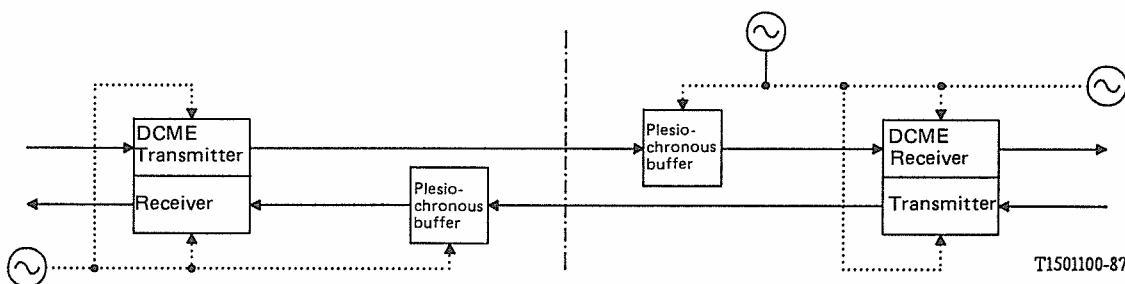

FIGURE I-4/G.763

**DCME buffered plesiochronous operation
(between two plesiochronous networks)**

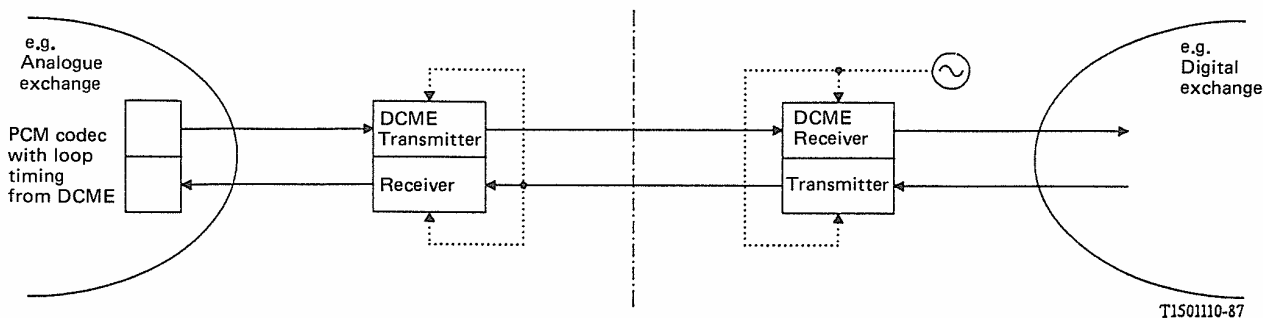

FIGURE I-5/G.763

**DCME synchronous loop operation
(between analogue and digital networks)**

I.1.3 *Satellite operation between national networks based upon continuous digital carrier type services*

Figures I-6/G.763 to I-9/G.763 show methods of terminal synchronization for operation between national networks over a satellite link based upon asynchronous continuous digital carrier type services. Figure I-6/G.763 introduces controlled slips between the DCMEs which are limited to in 70 days if G.811 clocks are available in both networks. Figures I-7/G.763, I-8/G.763 and I-9/G.763 permit slip free operation between the DCMEs.

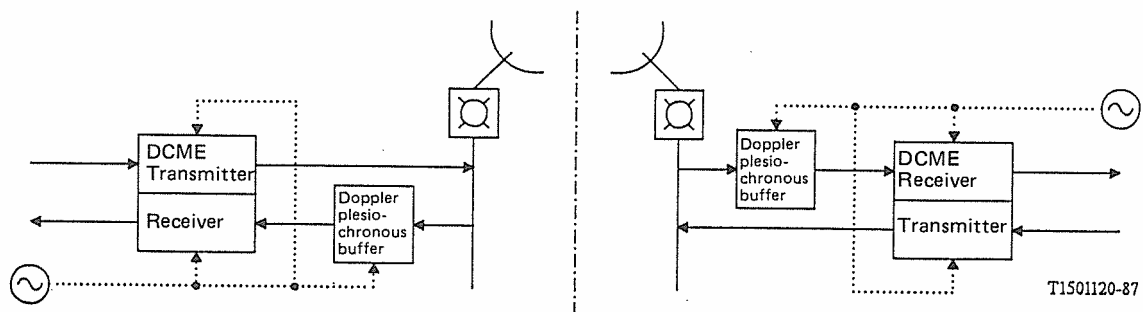

FIGURE I-6/G.763

**DCME buffered plesiochronous operation
(between two plesiochronous networks)**

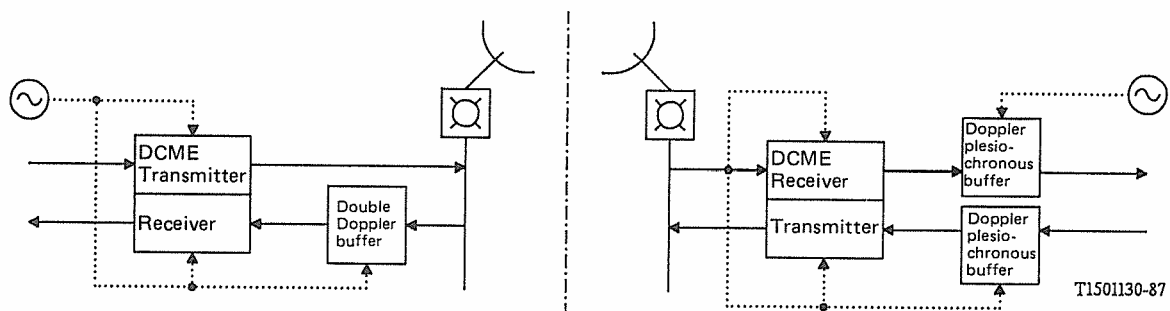

FIGURE I-7/G.763

**DCME synchronous loop operation
(between two plesiochronous networks)**

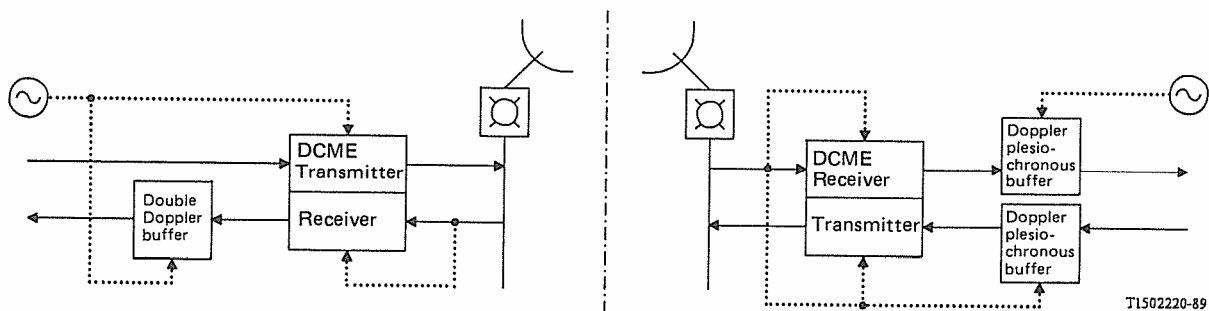

FIGURE I-8/G.763

**DCME synchronous loop operation
(between two plesiochronous networks)**

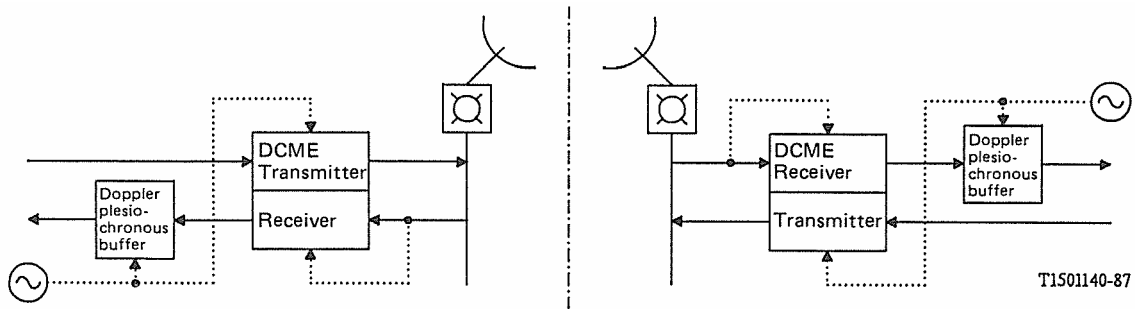

FIGURE I-9/G.763

**DCME synchronous (independent) operation
(between two plesiochronous networks)**

I.1.4 *Satellite operation between national networks based upon TDMA-Type services*

Figures I-10/G.763 and I-11/G.763 show a method of CDME terminal synchronization for operation between national networks over a satellite link based on TDMA-type services. An appropriate interface is provided in the TDMA terminal to permit interfacing the DCME with and without multi-clique operation over a primary multiplex port. Figure I-10/G.763 permits slip free operation between the DCMEs.

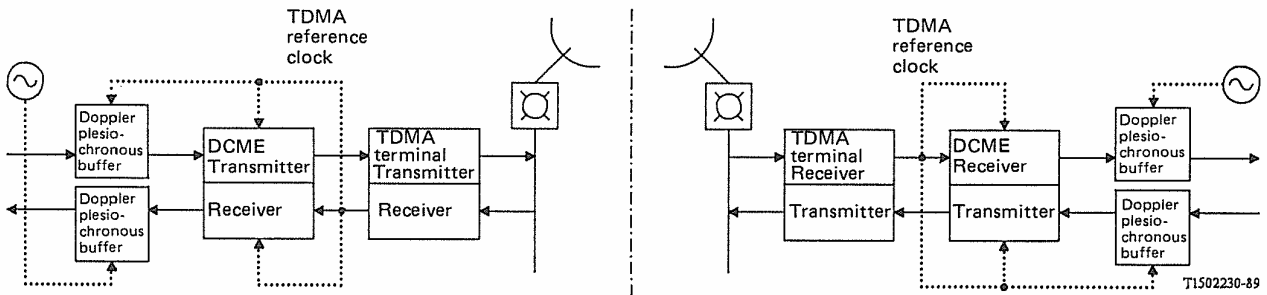

FIGURE I-10/G.763

**DCME synchronous operation
(between two plesiochronous networks)**

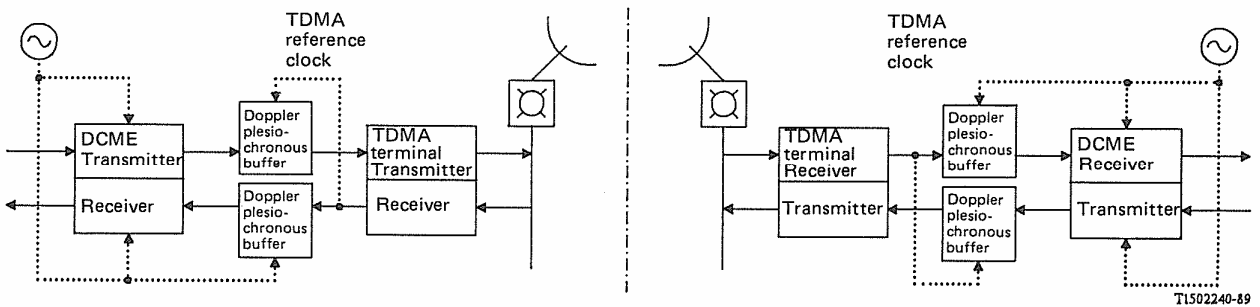

FIGURE I-11/G.763

**DCME buffered plesiochronous operation
(between two plesiochronous networks)**

I.2 Multi-clique operation

I.2.1 Terrestrial operation within a national network

Figure I-12/G.763 shows a method of DCME terminal synchronization for operation within a national network. The cross-connect function provides a means of assembling the received multi-clique pools onto a single primary multiplex.

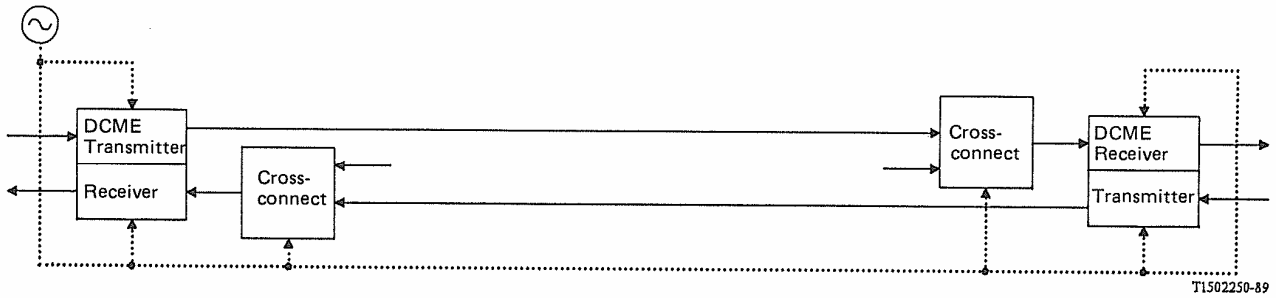

FIGURE I-12/G.763

**DCME synchronous operation
(in a single synchronous network)**

I.2.2 Terrestrial operation between national networks

Figure I-13/G.763 shows a method of DCME terminal synchronization for operation between national networks via terrestrial facilities. Plesiochronous buffers are required to resolve timing differences between the various plesiochronous networks. Due to the multiple source nature of the multi-clique configuration, the plesiochronous buffers must be placed before the cross-connect function.

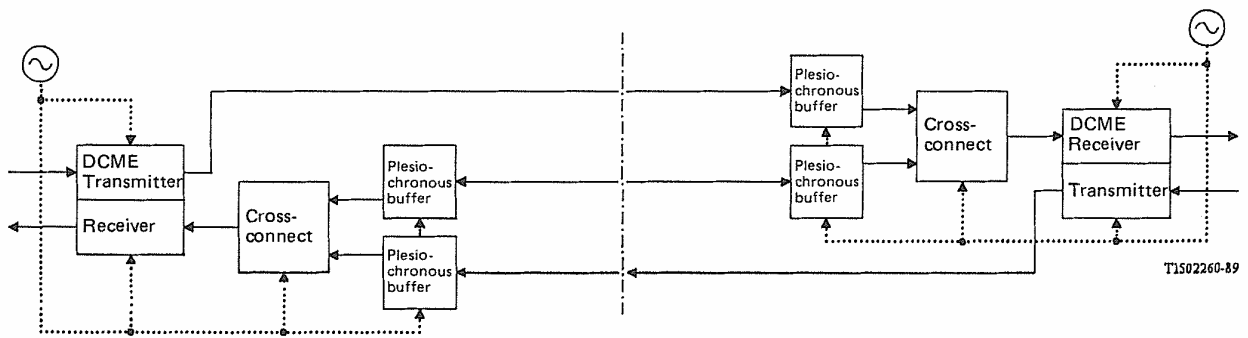

FIGURE I-13/G.763

**DCME buffered plesiochronous operation
(between two plesiochronous networks)**

I.2.3 Satellite operation between national networks based upon continuous carrier type services

Figure I-14/G.763 shows a method of DCME terminal synchronization for operation between national networks based on continuous digital satellite carriers. Plesiochronous/Doppler buffers are required to resolve timing differences between the various plesiochronous networks and to remove satellite induced Doppler shifts on the received data streams. Due to the multiple source nature of the multi-clique configuration, the plesiochronous/Doppler buffers must be placed before the cross-connect function.

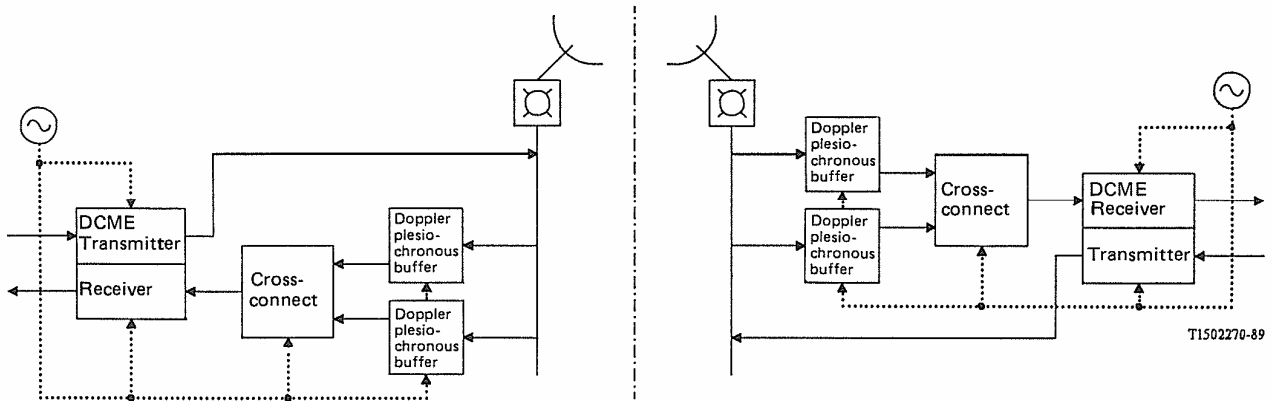

FIGURE I-14/G.763

**DCME buffered plesiochronous operation
(between two plesiochronous networks)**

I.3 *Multi-destination operation*

I.3.1 *Terrestrial operation within a national network*

Figure I-15/G.763 shows a method of DCME terminal synchronization for operation within a national network. The received data streams are assumed to originate from mutually synchronized sources.

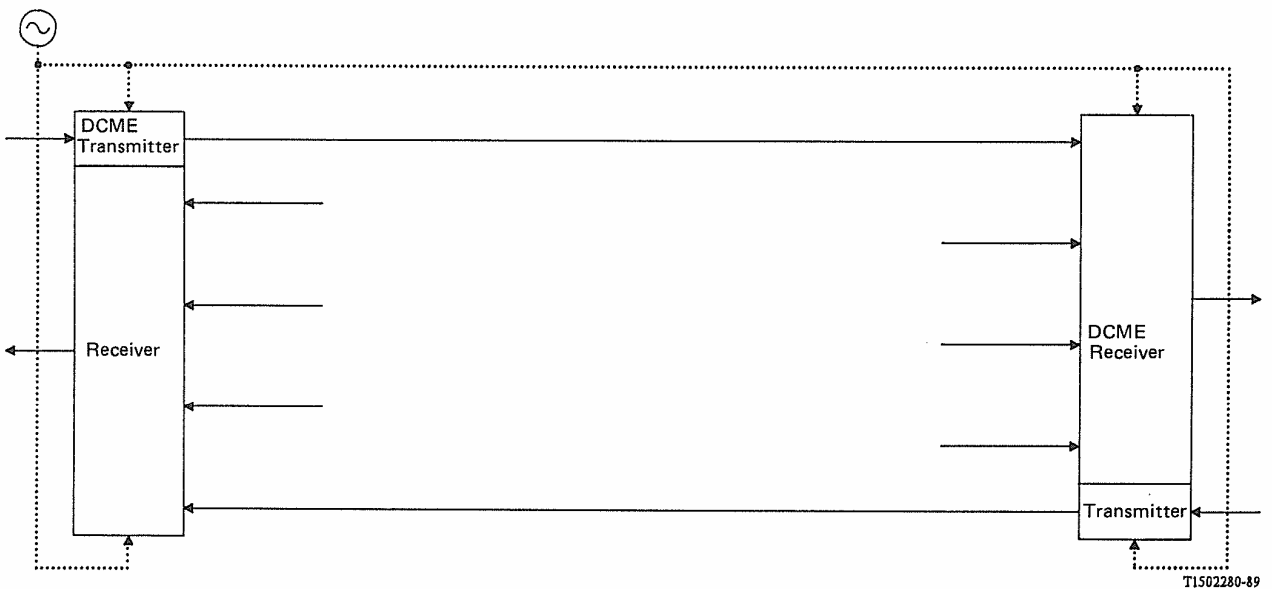

FIGURE I-15/G.763

**DCME synchronous operation
(in a single synchronous network)**

I.3.2 Terrestrial operation between national networks

Figure I-16/G.763 shows a method of DCME terminal synchronization for operation between national networks via terrestrial facilities. Plesiochronous buffers are required to resolve timing differences between the various plesiochronous networks. Due to the multiple source nature of the multi-destination configuration, the plesiochronous buffers must be placed before the DCME receive function.

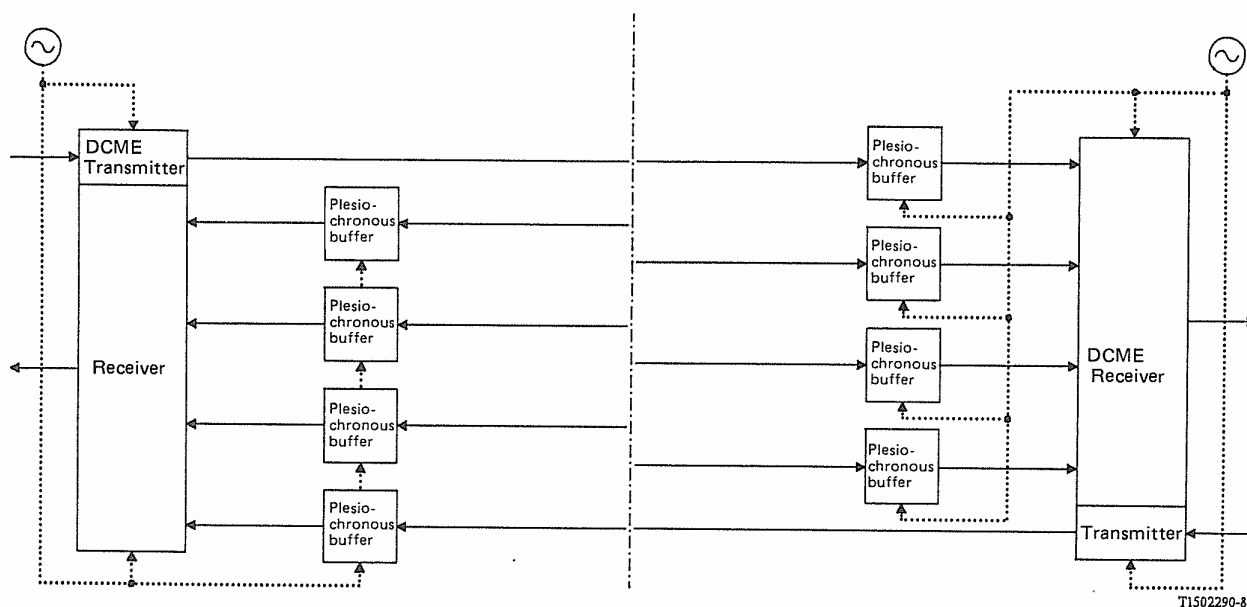

FIGURE I-16/G.763

DCME buffered plesiochronous operation (between two plesiochronous networks)

I.3.3 Satellite operation between national networks based upon continuous carrier type services

Figure I-17/G.763 shows a method of DCME terminal synchronization for operation between national networks based on continuous digital satellite carriers. Plesiochronous/Doppler buffers are required to resolve timing differences between the plesiochronous networks and to remove satellite induced Doppler shifts on the received data streams. Due to the multiple source nature of the receive signals in the multi-destination configuration, the plesiochronous/Doppler buffers must be placed before the DCME receiver.

I.3.4 Satellite operation between national networks based upon TDMA-type services

Figures I-18/G.763 and I-19/G.763 show a method of DCME terminal synchronization for operation between national networks over a satellite link based on TDMA-type services. An appropriate interface is provided in the TDMA terminal to permit interfacing the DCME over a primary multiplex port. Figure I-18/G.763 permits slip free operation between the DCMEs.

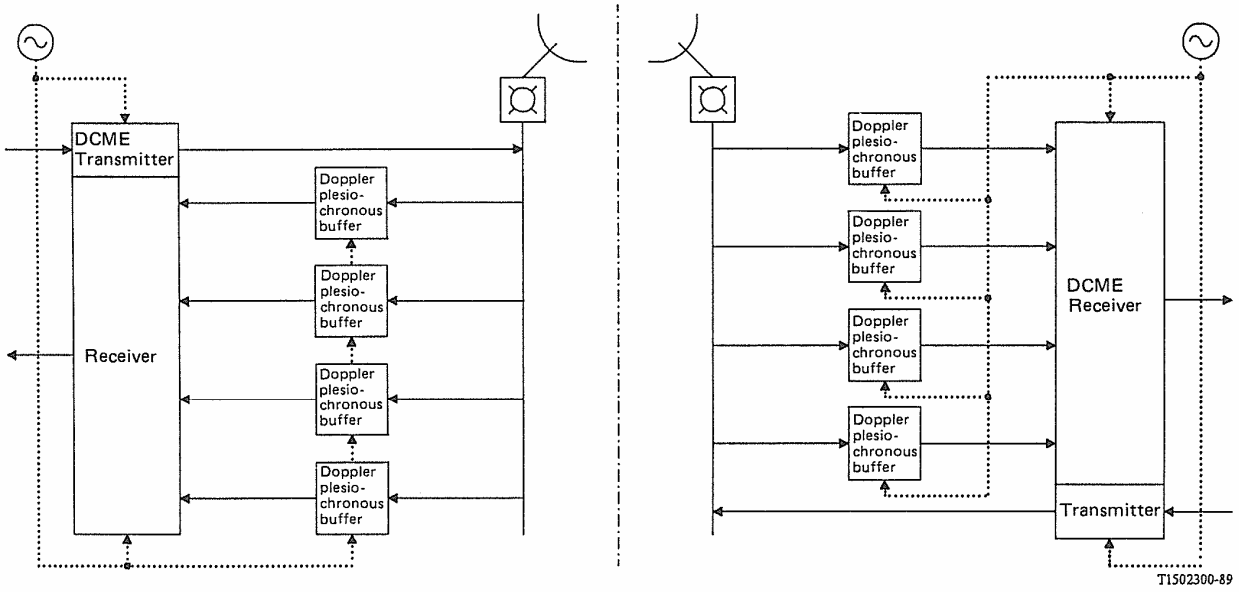

FIGURE I-17/G.763

**DCME buffered plesiochronous operation
(between two plesiochronous networks)**

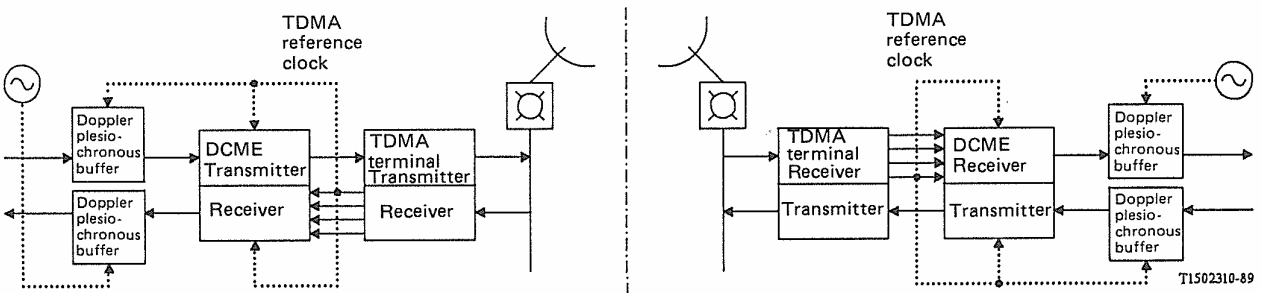

FIGURE I-18/G.763

**DCME synchronous operation
(between two plesiochronous networks)**

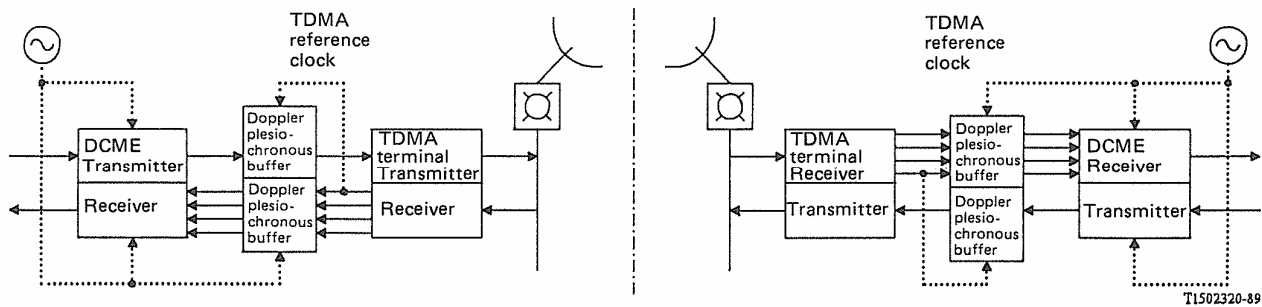

FIGURE I-19/G.763

**DCME buffered plesiochronous operation
(between two plesiochronous networks)**

APPENDIX II

(to Recommendation G.763)

Channel state classification and system management statistics

The purpose of this Appendix is to provide sufficient information to clearly define the system management statistics identified in Table 2/G.763.

Note – It is important that the voice and data performance are measured separately for the following reasons:

- The effect of freezeout and clipping is different on voice calls and data calls.
- The DCME process gives priority to assigning activity classed as data and hence the freezeout figures for the data queue should always be less than the corresponding freezeout figure for the voice queue.

II.1 Channel state classifications

The following channel states are defined in order to clarify their specific meaning in the definitions of the system management statistics.

II.1.1 Trunk channel (TC) classification

The following trunk channel states are defined:

- a) *Transparent* – The channel is engaged in the transmission of an unrestricted 64 kbit/s call;
- b) *Voice-active* – The channel is classified as voice by the data/speech discriminator and it is declared active by the activity detector;
- c) *Voice-inactive* – The channel is classified as voice by the data speech discriminator and the channel is declared inactive by the activity detector;
- d) *Data-active* – The channel is classified as data by the data/speech discriminator and it is declared active by the activity detector;
- e) *Data-inactive* – The channel is classified as data by the data/speech discriminator and it is declared inactive by the activity detector;
- f) *Signalling-active* – Signalling is detected in this channel by the signalling detector (under study) and the channel is declared active by the activity detector.

II.1.2 Bearer channel (BC) classification

The following bearer channel states are defined:

- a) *Voice* – The connected trunk channel carries a voice signal or in-band signalling;
- b) *Data* – The connected trunk channel carries a data signal;
- c) *Transparent* – The connected trunk channel carries a transparent call;
- d) *Disconnected* – No trunk channel is connected to this bearer channel;
- e) *Voice-available* – The bearer channel is connected to a voice trunk channel, but could be used for a different assignment;
- f) *Data-available* – The bearer channel is connected to a data trunk channel, but could be used for a different assignment;
- g) *Pre-assigned* – The bearer channel is permanently assigned to a trunk channel;
- h) *Bank (provisional)* – This 4-bit bearer channel can be used to obtain the LSBs of up to four data channels.

II.2 *System management statistics*

In the following definitions, N is the number of sampled DCME frames in the averaging period.

II.2.1 **bits/sample for voice**

The average number of encoding bits per sample for all TCs used for voice. The average should be calculated to two decimal places.

$$\text{Bits/sample for voice} = \frac{\sum_N \text{No. of bits within the BC used for voice}}{\sum_N \text{No. of non-preassigned TCs classified other than transparent, data or inactive}}$$

II.2.2 **voice queue freezeout fraction (Voice FOF)**

The ratio of competitive clip duration to voice spurt duration. The fraction may be determined as the ratio of the number of non-preassigned TCs classified as voice-active but not connected, to the total number of non-preassigned TCs classified as voice-active connected plus not connected. The ratio should be expressed as a percentage to three decimal places.

$$\text{Voice FOF} = \frac{\sum_N \text{No. of non-preassigned TCs classified as voice-active but not connected}}{\sum_N \text{Total No. of non-preassigned TCs classified as voice-active (i.e. not connected + connected)}} \times 100$$

The number of TCs classified as voice-active and connected includes those within the hangover time. The voice spurt duration is taken to include hangover.

II.2.3 **voice freezeout excess**

Percentage of time voice FOF exceeds 0.5% when averaged over 1 minute. The percentage should be calculated to two decimal places. [For statistic time interval (STI) see § 8.2.1.]

$$\text{Voice FOF excess} = \frac{\text{No. of 1 min. periods in STI in which voice FOF} > 0.5\%}{\text{No. of 1 min. periods in STI}} \times 100$$

II.2.4 **voice activity ratio**

The ratio of the number of non-preassigned TCs which are classified as voice-active to the total number of non-preassigned TCs. The ratio is expressed as a percentage, to the nearest integer.

$$\text{Voice activity ratio} = \frac{\sum_N \text{No. of non-preassigned voice-active TCs}}{\text{No. of non-preassigned TCs} \times N} \times 100$$

The voice activity ratio includes hangover time.

II.2.5 **DLC voice-on ratio**

The ratio of the number of frame during which DLC for voice/voiceband data (V/VBD) is ON, to the total number of frames. The ratio is expressed as a percentage, to the nearest integer.

$$\text{DLC voice-on ratio} = \frac{\text{No. of sampled DCME frames with DLC ON for V/VBD}}{N} \times 100$$

II.2.6 **data queue freezeout fraction (Data FOF)**

The ratio of the number of non-preassigned TCs classified as data-active but not connected, to the total number of non-preassigned TCs classified as data-active (i.e. connected + not connected). The ratio should be expressed as a percentage to three decimal places.

$$\text{Data FOF} = \frac{\sum_N \text{No. of non-preassigned TCs classified as data-active but not connected}}{\sum_N \text{Total No. of non-preassigned TCs classified as data-active (i.e. not connected + connected)}} \times 100$$

The number of TCs classified as data-active connected includes those within the hangover time.

II.2.7 **data activity ratio**

The ratio of the number of non-preassigned TCs which are classified as data-active, to the total number of non-preassigned TCs. The ratio is expressed as a percentage to the nearest integer.

$$\text{Data activity ratio} = \frac{\sum_N \text{No. of non-preassigned data-active TCs}}{\text{No. of non-preassigned TCs} \times N} \times 100$$

The data activity ratio includes hangover time.

II.2.8 **64 kbit/s failed seizures ratio**

The percentage of 64 kbit/s on demand seizure (S64) attempts that receive a 64 kbit/s negative acknowledgment (S64 NACK) from the DCME, given as an integer.

$$64 \text{ kbit/s FSR} = \frac{\text{Count of S64 signals received in STI}}{\text{Count of S64 NACK signals sent in STI}} \times 100$$

II.2.9 64 kbit/s connected ratio

The ratio of the number of non-preassigned TCs which are classified as 64 kbit/s connect-called plus 64 kbit/s connect-calling, to the total number of non-preassigned TCs. The ratio is expressed as a percentage to the nearest integer.

$$\text{64 kbit/s connected ratio} = \frac{\sum_N \text{No. of non-preassigned 64 kbit/s TCs connect-called and -calling}}{\text{No. of non-preassigned TCs} \times N} \times 100$$

The data activity ratio includes hangover time.

II.2.10 64 kbit/s DLC – on ratio

The ratio of the number of frames during which DLC for 64 kbit/s unrestricted is ON, to the total number of frames. The ratio is expressed as a percentage to the nearest integer.

$$\text{64 kbit/s DLC-on ratio} = \frac{\text{No. of sampled DCME frames with DLC for 64 kbit/s ON}}{N} \times 100$$

II.2.11 average BER

The average BER, as measured on the receive control channel.

$$\text{Average BER} = \frac{\text{Count of No. of bit errors identified in the control channel}}{\text{Count of total No. of bits received in the control channel}} \times 100$$

II.2.12 BER excess

The percentage of time that the average BER exceeds 1.10^{-3} when averaged over 1 minute. The value is given as an integer.

$$\text{BER excess} = \frac{\text{No. of 1 min periods in STI in which BER} > 1 \cdot 10^{-3}}{\text{No. of 1 min periods in STI}} \times 100$$

II.2.13 severely errored seconds ratio

See Recommendation G.821.

II.2.14 degraded minutes ratio

See Recommendation G.821.

References

- [1] KOU (K.Y.), O'NEAL (J.B.), NILSON (A.A.): Computations of DSI (TASI) overload as a function of the traffic offered, *IEEE Trans. on Communications*, Vol. COM-33, No. 2, Feb. 1985.
- [2] BRADY (P.T.): A model for generating on-off speech patterns in 2-way conversation, *Bell System Technical Journal*, page 2445 *et seq.*, Sep. 1969.
- [3] Special Issue on bit rate reduction and speech interpolation, Guest Editors M.R. Aaron and N.S. Jayant, *IEEE trans. on Communications* Vol. COM 30 No. 4, April 1982.

ITU-T RECOMMENDATIONS SERIES

Series A	Organization of the work of the ITU-T
Series B	Means of expression: definitions, symbols, classification
Series C	General telecommunication statistics
Series D	General tariff principles
Series E	Overall network operation, telephone service, service operation and human factors
Series F	Non-telephone telecommunication services
Series G	Transmission systems and media, digital systems and networks
Series H	Audiovisual and multimedia systems
Series I	Integrated services digital network
Series J	Transmission of television, sound programme and other multimedia signals
Series K	Protection against interference
Series L	Construction, installation and protection of cables and other elements of outside plant
Series M	TMN and network maintenance: international transmission systems, telephone circuits, telegraphy, facsimile and leased circuits
Series N	Maintenance: international sound programme and television transmission circuits
Series O	Specifications of measuring equipment
Series P	Telephone transmission quality, telephone installations, local line networks
Series Q	Switching and signalling
Series R	Telegraph transmission
Series S	Telegraph services terminal equipment
Series T	Terminals for telematic services
Series U	Telegraph switching
Series V	Data communication over the telephone network
Series X	Data networks and open system communications
Series Y	Global information infrastructure and Internet protocol aspects
Series Z	Languages and general software aspects for telecommunication systems