



INTERNATIONAL TELECOMMUNICATION UNION

ITU-T

G.769/Y.1242

TELECOMMUNICATION
STANDARDIZATION SECTOR
OF ITU

(08/2002)

SERIES G: TRANSMISSION SYSTEMS AND MEDIA,
DIGITAL SYSTEMS AND NETWORKS

Digital terminal equipments – Principal characteristics of
transcoder and digital multiplication equipment

SERIES Y: GLOBAL INFORMATION INFRASTRUCTURE
AND INTERNET PROTOCOL ASPECTS

Internet protocol aspects – Architecture, access, network
capabilities and resource management

**Circuit multiplication equipment optimized for
IP-based networks**

ITU-T Recommendation G.769/Y.1242

ITU-T G-SERIES RECOMMENDATIONS
TRANSMISSION SYSTEMS AND MEDIA, DIGITAL SYSTEMS AND NETWORKS

INTERNATIONAL TELEPHONE CONNECTIONS AND CIRCUITS	G.100–G.199
GENERAL CHARACTERISTICS COMMON TO ALL ANALOGUE CARRIER-TRANSMISSION SYSTEMS	G.200–G.299
INDIVIDUAL CHARACTERISTICS OF INTERNATIONAL CARRIER TELEPHONE SYSTEMS ON METALLIC LINES	G.300–G.399
GENERAL CHARACTERISTICS OF INTERNATIONAL CARRIER TELEPHONE SYSTEMS ON RADIO-RELAY OR SATELLITE LINKS AND INTERCONNECTION WITH METALLIC LINES	G.400–G.449
COORDINATION OF RADIOTELEPHONY AND LINE TELEPHONY TESTING EQUIPMENTS	G.450–G.499
TRANSMISSION MEDIA CHARACTERISTICS	G.500–G.599
DIGITAL TERMINAL EQUIPMENTS	G.600–G.699
General	G.700–G.709
Coding of analogue signals by pulse code modulation	G.710–G.719
Coding of analogue signals by methods other than PCM	G.720–G.729
Principal characteristics of primary multiplex equipment	G.730–G.739
Principal characteristics of second order multiplex equipment	G.740–G.749
Principal characteristics of higher order multiplex equipment	G.750–G.759
Principal characteristics of transcoder and digital multiplication equipment	G.760–G.769
Operations, administration and maintenance features of transmission equipment	G.770–G.779
Principal characteristics of multiplexing equipment for the synchronous digital hierarchy	G.780–G.789
Other terminal equipment	G.790–G.799
DIGITAL NETWORKS	G.800–G.899
DIGITAL SECTIONS AND DIGITAL LINE SYSTEM	G.900–G.999
QUALITY OF SERVICE AND PERFORMANCE	G.1000–G.1999
TRANSMISSION MEDIA CHARACTERISTICS	G.6000–G.6999
DIGITAL TERMINAL EQUIPMENTS	G.7000–G.7999
DIGITAL NETWORKS	G.8000–G.8999

For further details, please refer to the list of ITU-T Recommendations.

ITU-T Recommendation G.769/Y.1242

Circuit multiplication equipment optimized for IP-based networks

Summary

Voice and voice-band data traffic in international networks has traditionally been transported by circuit switched systems and equipment. On the other hand, IP network technology has advanced rapidly, and high-speed networks utilizing the IP transport technique have been constructed worldwide with a view to support increasing future demand of multimedia communications. In parallel with this trend, low-rate voice coding technology has further progressed recently and, by using the technology, a system of transporting voice, facsimile voice-band data traffic over the IP-based networks has been developed and is now available in the market as VoIP (Voice over IP) systems.

By reviewing the technologies used for the VoIP system and comparing them with those used for Circuit Multiplication Equipment (CME)'s, one can recognize that the IP-based voice transmission technique can be applied to realize a new type of CME, namely a CME optimised for IP-based networks (IP-CME). Thus it can be expected that this new type of CME certainly contributes to construct future cost-effective voice, facsimile and voice-band signals transmission networks in the next generation global information infrastructure.

This Recommendation contains principles and examples of multiplication schemes of voice and voice-band data between the International Switching Centre (ISC) (exchanges) which are connected via IP-based networks.

Source

ITU-T Recommendation G.769/Y.1242 was prepared by ITU-T Study Group 15 (2001-2004) and approved under the WTSA Resolution 1 procedure on 6 August 2002.

Keywords

Bearer interface, Circuit multiplication equipment, Echo canceller, End-to-end transmission performance, Facsimile over IP, Gateway, Internet protocol, Internet gateway, IP-based networks, Multiplication, IP gateway, IP packets, Media gateway, Media gateway controller, Quality of service, Signalling interface, Speech coding, TDM, TDM-to-IP gateway, Voice gateway, Voice over IP, Voice quality, VoIP.

FOREWORD

The International Telecommunication Union (ITU) is the United Nations specialized agency in the field of telecommunications. The ITU Telecommunication Standardization Sector (ITU-T) is a permanent organ of ITU. ITU-T is responsible for studying technical, operating and tariff questions and issuing Recommendations on them with a view to standardizing telecommunications on a worldwide basis.

The World Telecommunication Standardization Assembly (WTSA), which meets every four years, establishes the topics for study by the ITU-T study groups which, in turn, produce Recommendations on these topics.

The approval of ITU-T Recommendations is covered by the procedure laid down in WTSA Resolution 1.

In some areas of information technology which fall within ITU-T's purview, the necessary standards are prepared on a collaborative basis with ISO and IEC.

NOTE

In this Recommendation, the expression "Administration" is used for conciseness to indicate both a telecommunication administration and a recognized operating agency.

INTELLECTUAL PROPERTY RIGHTS

ITU draws attention to the possibility that the practice or implementation of this Recommendation may involve the use of a claimed Intellectual Property Right. ITU takes no position concerning the evidence, validity or applicability of claimed Intellectual Property Rights, whether asserted by ITU members or others outside of the Recommendation development process.

As of the date of approval of this Recommendation, ITU had received notice of intellectual property, protected by patents, which may be required to implement this Recommendation. However, implementors are cautioned that this may not represent the latest information and are therefore strongly urged to consult the TSB patent database.

© ITU 2003

All rights reserved. No part of this publication may be reproduced, by any means whatsoever, without the prior written permission of ITU.

CONTENTS

	Page
1	Scope 1
2	Normative references..... 2
3	Abbreviations..... 3
4	Definitions 4
5	Target services to be supported 5
6	Network reference model 5
6.1	Connection configuration 5
6.2	Interfaces 6
6.2.1	Trunk I/F..... 6
6.2.2	ISC signalling I/F 7
6.2.3	Packetized IP-CME control signalling I/F 7
6.2.4	Packetized call control signalling I/F 7
6.2.5	IP transmission channel I/F 7
7	Functions of the IP-CME..... 7
7.1	Functions related to audio stream handling..... 7
7.2	Trunk I/F access function 8
7.2.1	Layer 1..... 8
7.2.2	TDM Signalling Interface..... 8
7.3	ISC signalling I/F control function..... 9
7.4	IP transmission channel I/F access function..... 9
7.4.1	Layer 3..... 9
7.4.2	Layer 2..... 9
7.4.3	Layer 1..... 9
7.4.4	IP transmission channel control procedure..... 9
7.5	Packetized IP-CME control signalling function..... 10
7.5.1	Definition of the IP-CME profile 10
7.5.2	Procedure of the profile exchange..... 10
7.6	Transport of call control signalling function..... 11
7.6.1	Transmission over IP-based networks..... 11
7.6.2	Transmission over SS7 networks 11
7.7	Multiplexing function..... 11
7.7.1	Algorithms for generating multiplexed packets 11
7.8	Multiplexing load control function..... 14
7.9	System operation management function 14
7.10	QoS policy management function 15

	Page
7.10.1 QoS requirements and measures	15
7.11 Network management function	15
Annex A – IP transmission channel control procedure.....	15
A.1 Conditions.....	15
A.2 Parameters	16
A.3 Procedure.....	18
A.3.1 Transmit side of IP-CME A	18
A.3.2 Receive side of IP-CME B	18
A.4 Structure of the multiplexed packet.....	19
A.4.1 IP port ID (IPP-ID): 7 bits	21
A.4.2 Extension bit (X): 1 bit	21
A.4.3 Payload Length (PL): 8 bits.....	21
Appendix I – Functional architecture.....	21
I.1 Functional implementation.....	21
I.1.1 Transmit side of IP-CME	22
I.1.2 Receive side of IP-CME.....	23

ITU-T Recommendation G.769/Y.1242

Circuit multiplication equipment optimized for IP-based networks

1 Scope

This Recommendation contains principles and examples of multiplication schemes of voice, facsimile and voice-band data between the International Switching Centre (ISC) (exchanges) (see Note) which are connected via IP-based networks.

Circuit multiplication equipment may have integral echo control and A/ μ -law converter functions. The information in this Recommendation is compatible with the control procedures for such devices.

NOTE – As Circuit Multiplication Equipment may also be used in national networks, the signalling described here could not only be used in International Switching Centres but also in national exchanges.

This Recommendation applies to digital circuit multiplication equipment optimised for IP-based networks (IP-CME) and specifies the following aspects for IP-CME in order to achieve interworking between them.

- a) Network interface requirements
 - connection configuration;
 - trunk and bearer facility interface;
 - IP-based networks interface;
 - call control signalling;
 - IP-CME control signalling which includes definition of coding types;
 - echo control.
- b) Functional requirements
 - multiplication schemes optimised for IP-based networks;
 - handling of the call signalling transmission between the ISCs;
 - handling of the IP-CME control signalling between IP-CMEs;
 - multiplexing load control of IP-transmission channels over IP-based networks;
 - dynamic load control of calls in PSTN side;
 - network management;
 - management of voice, facsimile and voice-band data quality transported over IP-based networks;
 - system operation (capacity, overload strategy, maintenance, alarm).
- c) Performance criteria of IP-CME system elements
 - speech detector;
 - facsimile detector;
 - voice-band data detector;
 - signalling detector.

2 Normative references

The following ITU-T Recommendations and other references contain provisions which, through reference in this text, constitute provisions of this Recommendation. At the time of publication, the editions indicated were valid. All Recommendations and other references are subject to revision; users of this Recommendation are therefore encouraged to investigate the possibility of applying the most recent edition of the Recommendations and other references listed below. A list of the currently valid ITU-T Recommendations is regularly published. The reference to a document within this Recommendation does not give it, as a stand-alone document, the status of a Recommendation.

- ITU-T Recommendation G.109 (1999), *Definition of categories of speech transmission quality*.
- ITU-T Recommendation G.168 (2002), *Digital network echo cancellers*.
- ITU-T Recommendation G.177 (1999), *Transmission planning for voice-band services over hybrid Internet/PSTN connections*.
- ITU-T Recommendation G.701 (1993), *Vocabulary of digital transmission and multiplexing and pulse code modulation (PCM) terms*.
- ITU-T Recommendation G.703 (2001), *Physical/electrical characteristics of hierarchical digital interfaces*.
- ITU-T Recommendation G.704 (1998), *Synchronous frame structures used at 1544, 6312, 2048, 8488 and 44 736 kbit/s hierarchical levels*.
- ITU-T Recommendation G.711 (1988), *Pulse code modulation (PCM) of voice frequencies*.
- ITU-T Recommendation G.711 Appendix I, (1999), *A high quality low-complexity algorithm for packet loss concealment with G.711*.
- ITU-T Recommendation G.711 Appendix II, (2000), *A comfort noise payload definition for ITU-T G.711 use in packet-based multimedia communication systems*.
- ITU-T Recommendation G.723.1 (1996), *Speech coders: Dual rate speech coder for multimedia communications transmitting at 5.3 and 6.3 kbit/s*.
- ITU-T Recommendation G.723.1 Annex A, (1996), *Silence compression scheme*.
- ITU-T Recommendation G.726 (1990), *40, 32, 24, 16 kbit/s Adaptive Differential Pulse Code Modulation (ADPCM)*.
- ITU-T Recommendation G.729 (1996), *Coding of speech at 8 kbit/s using conjugate-structure algebraic-code-excited linear-prediction (CS-ACELP)*.
- ITU-T Recommendation G.729 Annex B (1996), *A silence compression scheme for G.729 optimized for terminals conforming to Recommendation V.70*.
- ITU-T Recommendation G.763 (1998), *Digital circuit multiplication equipment using G.726 ADPCM and digital speech interpolation*.
- ITU-T Recommendation G.957 (1999), *Optical interfaces for equipments and systems relating to the synchronous digital hierarchy*.
- ITU-T Recommendation I.233.x (1991), *Frame mode bearer services*.
- ITU-T Recommendation I.363.1 (1996), *B-ISDN ATM Adaptation Layer specification: Type 1 AAL*.
- ITU-T Recommendation I.363.2 (2000), *B-ISDN ATM Adaptation Layer specification: Type 2 AAL*.

- ITU-T Recommendation I.363.5 (1996), *B-ISDN ATM Adaptation Layer specification: Type 5 AAL*.
- ITU-T Recommendation P.861 (1998), *Objective quality measurement of telephone-band (300-3400 Hz) speech codecs*.
- ITU-T Recommendation P.862 (2001), *Perceptual evaluation of speech quality (PESQ): An objective method for end-to-end speech quality assessment of narrowband telephone networks and speech codecs*.
- ITU-T Recommendation Q.2 (1988), *Signal receivers for automatic and semi-automatic working, used for manual working*.
- ITU-T Recommendation Q.50 (2001), *Signalling between Circuit Multiplication Equipment (CME) and International Switching Centres (ISC)*.
- ITU-T Recommendation Q.50.1 (2001), *Signalling between International Switching Centres (ISC) and Digital Circuit Multiplication Equipment (DCME) including the control of compression/decompression*.
- ITU-T Recommendation Q.52 (2001), *Signalling between international switching centres and stand-alone echo control devices*.
- ITU-T Recommendation Q.400 (1988), *Forward line signals*.
- ITU-T Recommendation Q.931 (1998), *ISDN user-network interface layer 3 specification for basic call control*.
- ITU-T Recommendation T.30 (1999), *Procedures for document facsimile transmission in the general switched telephone network*.
- IETF RFC 1661 (1994), *The Point-to-Point Protocol (PPP)*.
- IETF RFC 1812 (1995), *Requirements for IP Version 4 Routers*.
- IETF RFC 1889 (1996), *RTP: A Transport Protocol for Real-Time Applications*.
- IETF RFC 2131 (1997), *Dynamic Host Configuration Protocol*.
- IETF RFC 2427 (1998), *Multiprotocol Interconnect over Frame Relay*.
- IETF RFC 2460 (1998), *Internet Protocol, Version 6 (IPv6) Specification*.
- IETF RFC 2719 (1999), *Framework Architecture for Signalling Transport*.
- IETF RFC 2833 (2000), *RTP Payload for DTMF Digits, Telephony Tones and Telephony Signals*.
- IETF RFC 2960 (2000), *Stream Control Transmission Protocol*.
- IEEE 802 (2001), *IEEE Standards for Local and Metropolitan Area Networks: Overview and Architecture*.

3 Abbreviations

This Recommendation uses the following abbreviations.

CME	Circuit Multiplication Equipment
DHCP	Dynamic Host Configuration Protocol
DS0	Digital Signal level 0
DTMF	Dual Tone Multi-Frequency
DTX	Discontinuous Transmission

GSTN	General Switched Telephone Network
IETF	Internet Engineering Task Force
IP	Internet Protocol
IPP-ID	IP port ID
ISC	International Switching Centre
ITU	International Telecommunication Union
MG	Media Gateway
PCC	Per Call Control
PCM	Pulse Code Modulation
PPP	Point-to-Point Protocol
PSTN	Public Switched Telephone Network
RTCP	Real Time Control Protocol
RTP	Real Time Protocol
SCN	Switched Circuit Network
SDH	Synchronous Data Hierarchy
SET	Simple Endpoint Type
SIGTRN	Signalling Transport
SNMP	Simple Network Management Protocol
SPH	Short Packet Header
SS7	Signalling System No. 7
SW	Switch
TCP	Transmission Control Protocol
TDM	Time Division Multiplex(ing)
TFO	Tandem Free Operation
UDP	User Datagram Protocol
VAD	Voice Activity Detection
VBD	Voice-Band Data
VoIP	Voice over IP

4 Definitions

Definitions relating to the IP-CME are as follows:

4.1 IP-based CME (IP-CME): IP-CME constitutes a general class of equipment that permits concentration of a number of IP ports on a reduced number of transmission channels over IP-based networks.

4.2 low rate encoding (LRE): It defines speech-coding methods with bit rates less than 64 kbit/s, e.g. the 32 kbit/s transcoding process defined in ITU-T Rec. G.726 applied to speech coded according to ITU-T Rec. G.711.

Furthermore, in VoIP systems, coding-decoding device ("codec") that generate encoded blocks of voice signals in each periodical frame are usually adopted. For example, codecs such as the G.729 Annexes and G.723.1 are common in the VoIP field, and the basic intervals of their frames are usually multiples of 10 ms.

4.3 speech activity ratio: It defines the ratio of the time speech and corresponding hangover occupies the trunk to the total measuring time, averaged over the total number of trunks carrying speech.

4.4 trunk: It defines a bidirectional connection consisting of a forward channel and a backward channel between the SW (the International Switching Centre). Each channel in the trunk interface is identified by Trunk channel ID.

4.5 IP port: It defines a bidirectional call stream between the IP-CMEs. An IP port in an IP transmission channel is distinguished by the IP port ID (IPP-ID) based on UDP port number and mapped to correspondent trunk.

4.6 IP transmission channel: It defines a bidirectional multiplexed IP/UDP/RTP stream channel between the IP-CME that transmits speech data and VBD over IP-based networks.

4.7 freeze-out: It defines the temporary condition when a trunk channel becomes active and cannot immediately be assigned to an IP transmission channel, due to lack of available transmission capacity and so on.

4.8 freeze-out fraction: It defines the ratio of the sum of the individual channel freeze-outs to the sum of the active signals and their corresponding hangover times and front end delays, for all trunk channels over a fixed interval of time, e.g. one minute.

5 Target services to be supported

All kinds of telephony services such as speech, facsimile (includes ITU-T Rec. T.30) and VBD shall be supported by IP-CME. Facsimile demodulation / remodulation is optionally supported.

NOTE – How to support Modem signal and Tone signal is for further study at this moment.

6 Network reference model

6.1 Connection configuration

Multiplexing/demultiplexing the circuits communicating between an originator and a terminator are on the same or different General Switched Telephone Network (GSTN) by the IP-CMEs located at both ends of the transit IP-based networks. The single connection configuration is shown in Figure 1. The multipoint connection configuration is also shown in Figure 2. And the multipoint connection configuration is a set of single one.

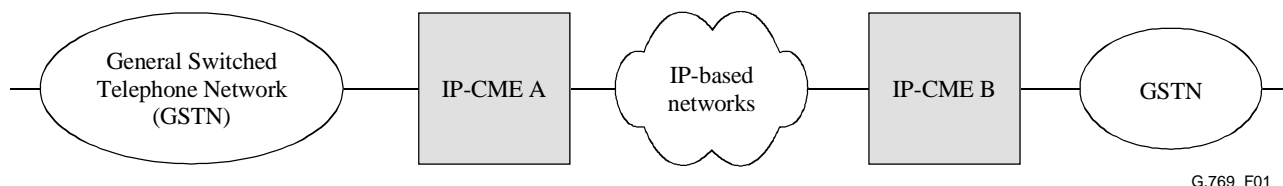
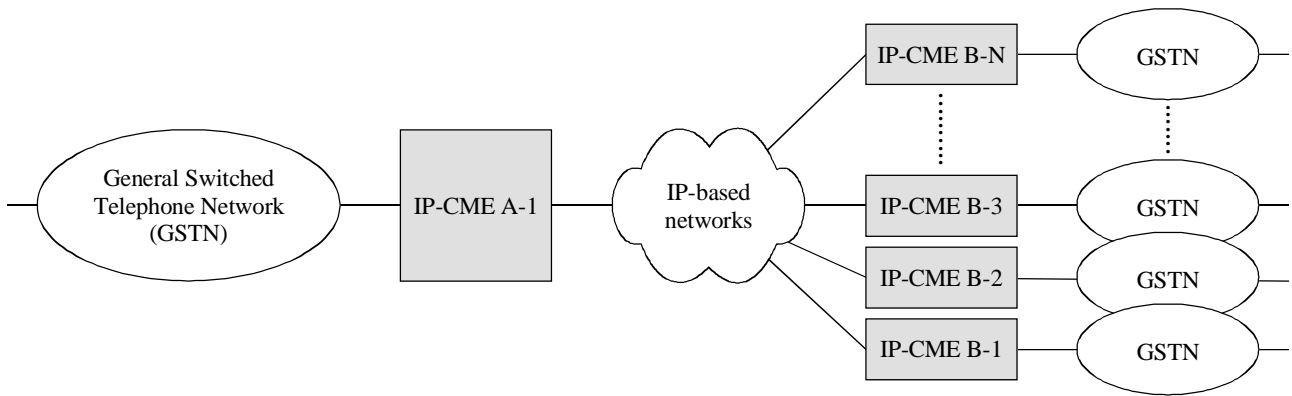

Figure 1/G.769/Y.1242 – Single connection configuration of the IP-CME



G.769_F02

Figure 2/G.769/Y.1242 – Multipoint connection configuration of the IP-CME

6.2 Interfaces

IP-CMEs are connected with the GSTN switches (International Switching Centres (ISCs)). Following two connection configurations are supported by IP-CME.

When the call control signalling is transmitted over IP-based networks via IP-CMEs, there are five interfaces that the IP-CMEs should have as shown in Figure 3. On the other hand, in the configuration using SS7 networks to transmit the call control, there are four interfaces shown in Figure 4 below.

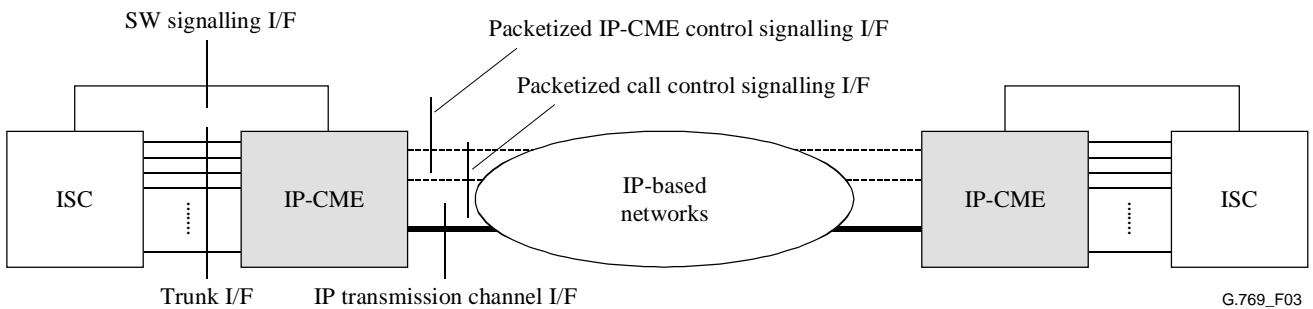

G.769_F03

Figure 3/G.769/Y.1242 – Network connection interfaces of the IP-CME

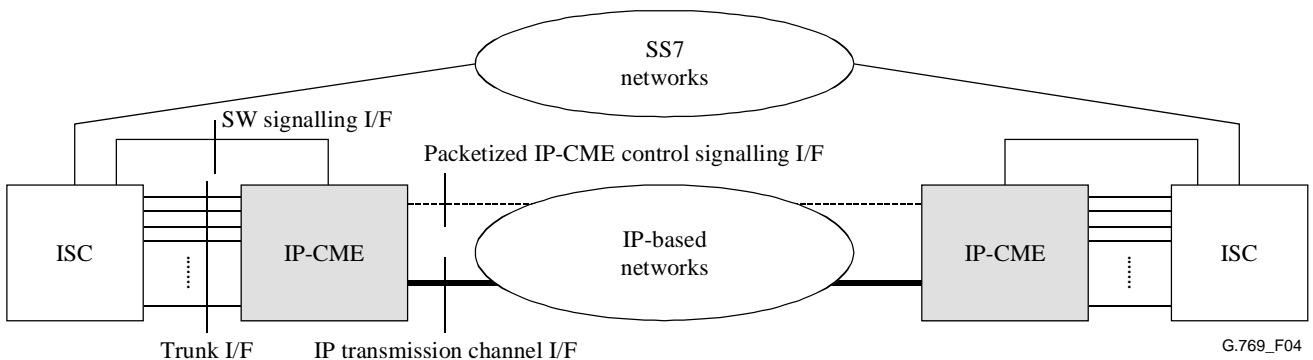

G.769_F04

Figure 4/G.769/Y.1242 – Network connection interfaces of the IP-CME using SS7 networks

6.2.1 Trunk I/F

This interface such as T1, E1, T3, and E3 should be used to transmit the voice, Facsimile and VBD signals between the IP-CME and ISC.

- Trunk side interface at 1544 kbit/s
- Trunk side interface at 2048 kbit/s
- Trunk side interface at 34 368 kbit/s
- Trunk side interface at 44 736 kbit/s

6.2.2 ISC signalling I/F

This is the signalling interface between ISC and IP-CME and supports the signals to control the IP-CME from ISC.

6.2.3 Packetized IP-CME control signalling I/F

This interface provides the IP-CME control signals between them via IP-based networks.

6.2.4 Packetized call control signalling I/F

This interface provides the call control signals between ISCs via IP-based networks.

6.2.5 IP transmission channel I/F

This interface provides the bearer signals between IP-CMEs via IP-based networks.

7 Functions of the IP-CME

The functions of IP-CME are shown as follows.

7.1 Functions related to audio stream handling

The architecture of the audio stream handling functions is shown in Figure 5.

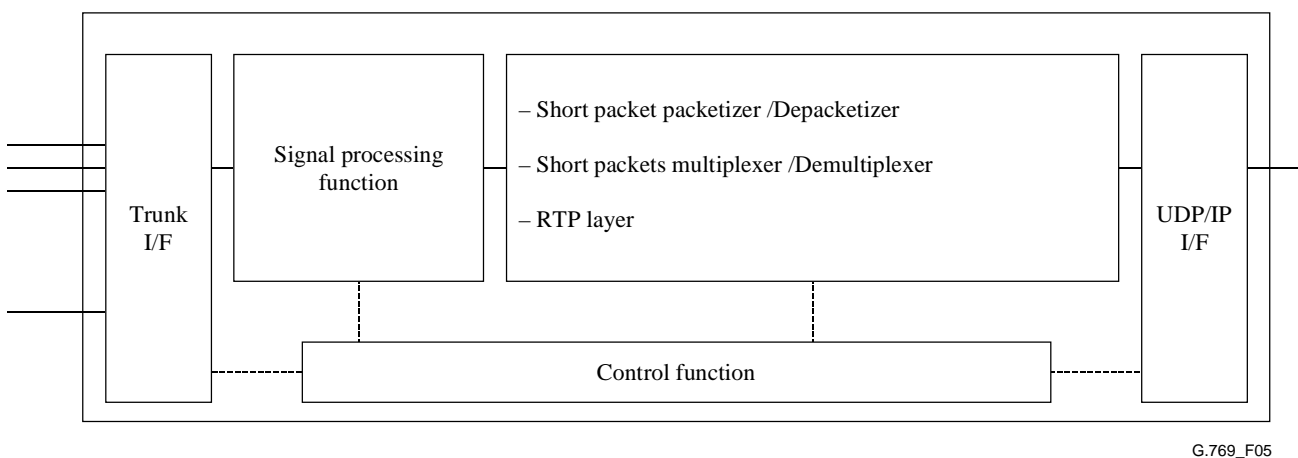

Figure 5/G.769/Y.1242 – Basic functions related to audio stream handling

The trunk interface unit provides connection to PSTN network and distribution of the TDM channels for signal processing.

The Signal Processing Function unit processes the Voice, Facsimile and VBD signals of the call. The signal processing function list may include voice compression, signal analysis, fax relay or bypass, modem relay or bypass, echo canceller, DTMF detector etc.

The signal processing function generates frames of information that are applied to the packetizer function. The packetizer builds short packets consisting of one or more frames of information.

The Short Packets Multiplexer/De-multiplexer function combines short packets into one multiplexed structure packet. The function de-multiplexes combined packets on receiver side using

the short packet header and sends the short packets to appropriate channel of signal processing function.

The RTP layer function provides RTP capability between two IP-CMEs (IETF RFC 1889, IETF RFC 2833).

The UDP/IP interface function consists of the UDP functionality and IP packets layer-3 functionality/layer-2 protocol functionality and layer-1 physical interface.

A more detailed functional model of the IP-CME is shown in Figure 6.

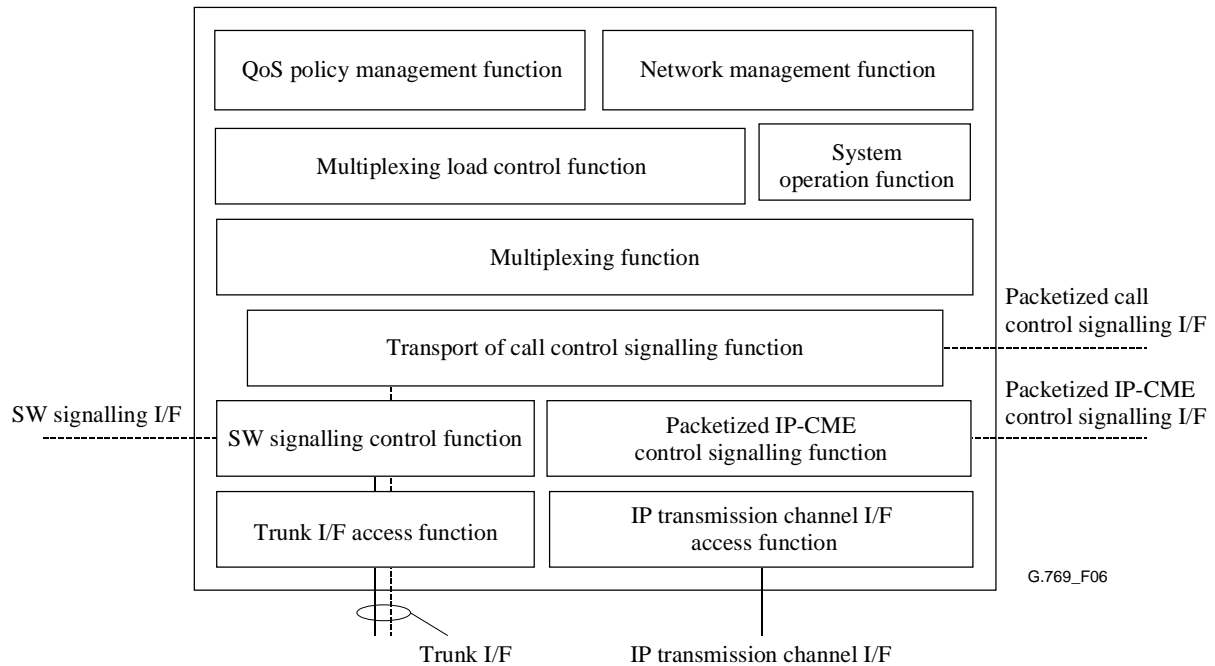

Figure 6/G.769/Y.1242 – Functions of the IP-CMEs

The functional units of Figure 6 are briefly described in the following clauses.

7.2 Trunk I/F access function

7.2.1 Layer 1

Layer-1 protocols may include any of the following:

ITU-T Recs. G.703, G.704, G.957 and IEEE 802.

7.2.2 TDM Signalling Interface

TDM Bearer signalling is accomplished by means of signalling on the TDM bearer interface. TDM signalling interfaces supported by this Recommendation should conform to national standards and are for future study.

If SS7 links are used, then signalling on the TDM bearer interface is not used.

Support of the following and other signalling types is for further study:

- SS7 Signalling;
- ITU-T Rec. Q.931;
- R1 Signalling System – ITU-T Q.300 series Recommendations;
- R2 Signalling System – ITU-T Q.400 series Recommendations;
- Channel Associated as per ITU-T Rec. G.704.

7.3 ISC signalling I/F control function

This signalling is used for dynamic load control of calls in PSTN side and control of echo cancelling mechanism.

See ITU-T Recs Q.50, Q.50.1 and Q.52.

7.4 IP transmission channel I/F access function

7.4.1 Layer 3

Layer-3 protocols may include any of the following:

DHCP – IETF RFC 2131;

IP V4 Router – IETF RFC 1812;

Support of IP V6 – IETF RFC 2460.

7.4.2 Layer 2

Layer-2 protocols may include any of the following:

PPP – IETF RFC 1661;

Frame Relay – ITU-T Rec. I.233;

ATM – ITU-T Recs I.363.1, I.363.2 and I.363.5;

IP over PPP, as per IETF RFC 1661;

IP over Frame Relay, as per IETF RFC 2427;

IP over ATM.

7.4.3 Layer 1

Layer-1 protocols may include any of the following:

ITU-T Recs G.703, G.704, G.957 and IEEE 802.

7.4.4 IP transmission channel control procedure

Annex A provides details about the IP transmission channel control procedure for the relevant multiplex structure.

Figure 7 illustrates the configuration of the IP transmission channel between the IP-CMEs.

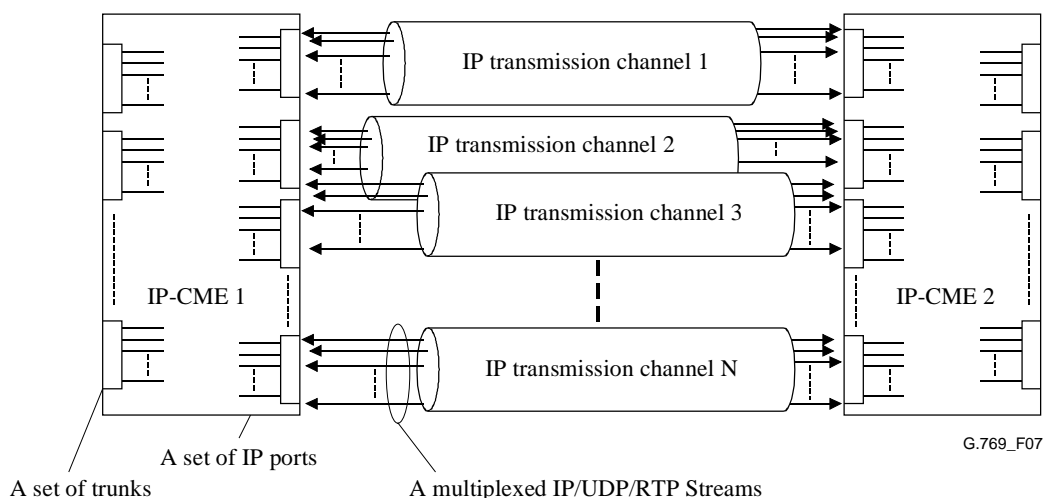

Figure 7/G.769/Y.1242 – Configuration of IP transmission channel between the IP-CMEs

7.5 Packetized IP-CME control signalling function

7.5.1 Definition of the IP-CME profile

This signalling is used for exchanging the profile of IP-CME. The profile includes the following information.

a) IP network information.

One IP-CME has following three IP addresses:

- 1) For Packetized IP-CME control signalling I/F and Packetized call control signalling I/F;
- 2) For IP transmission channel I/F;
- 3) For management use.

NOTE 1 – IP-CME(s) under DHCP environment should automatically collect the IP addresses.

NOTE 2 – The number of UDP port numbers of the IP transmission channel depends on the number of the IP transmission channels between IP-CME(s).

b) Coding types of IP transmission channels;

c) Range of call ID values;

d) Range of trunk ID values;

e) Selected multiplication algorism(s);

f) Information of Network management.

Access speed (band width), average one-way delay time between IP-CMEs based on SNMP.

g) Information of QoS policy management.

IP-CME should have the following parameters which are calculated by Sender/Receiver reports of RTCP:

- MeanDelay (Sender report of RTCP);
Mean value of delay for the current reported time interval;
- Max_MeanDelay (Sender report of RTCP);
Largest value of MeanDelay;
- CumulativeNumberOfPacketsLost (Receiver report of RTCP)
Cumulative number of packets lost of last sent RTCP Receiver Report;
- MeanJitter (Receiver report of RTCP).
Average value of CalculatedJitter calculated from all sent RTCP Receiver Reports for the current reported time interval;
- Max_MeanJitter (Receiver report of RTCP).
Largest value of MeanJitter.

7.5.2 Procedure of the profile exchange

Profile information should be exchanged, if required, when the new channel profiles are implemented in IP-CME and diagnosis of own functionalities is initiated.

7.5.2.1 Off-line procedure

This issue is for further study.

7.5.2.2 On-line procedure

The profiles shall be exchanged once before the IP-CME starts operation. The transmission protocol for the profile shall be FTP.

7.6 Transport of call control signalling function

7.6.1 Transmission over IP-based networks

Both of the channels (TDM time slots) in a ISC, such as call signalling channel and bearer channels (Voice, Facsimile and VBD channels) are connected to IP-CME. In short, the call signalling messages are passed transparently between IP-CMEs over IP-based networks using the following means. See Figure 3.

- 1) SIGTRAN transmission (IETF RFC 2719, IETF RFC 2960);
- 2) Clear channel (64 kbit/s) transmission.

7.6.2 Transmission over SS7 networks

The call control signalling messages are send to the existing SS7 networks and only the bearer channels' signals (Voice, Facsimile and VBD signals) are connected to the IP-CME. See Figure 4.

7.7 Multiplexing function

The following items should be taken into account for the multiplexing function.

- Triggering algorithms for multiplexing.
- Conditions of QoS policies and network management should be also considered in the algorithms.
- A buffer control mechanism for composing/decomposing the multiplexed RTP/UDP/IP packets.
- The Voice Activity Detection (VAD) mechanism for rescheduling the multiplexing scheme.
- A mechanism for detecting the payload types of the GSTN streams such as voice, facsimile and VBD signals for selecting the multiplexing scheme, and switching the multiplexing schemes ON/OFF.
- Scheduling mechanism for controlling the multiplexed packet streams between the IP-CMEs.

7.7.1 Algorithms for generating multiplexed packets

For multiplexing Schemes, several algorithms can be used to determine the length and emission timings of multiplexed packets. The following subclauses describe selectable multiplication algorithms. The circuit multiplication schemes may be achieved in one of following schemes. Table 1 summarizes the variants of the Scheme considered with respect to the algorithms for generating the multiplexed packets.

Table 1/G.769/Y.1242 – Variants of the schemes

Variants	Features	Parameters	Implementation
Scheme 1	Fixed threshold on packet payload length	<i>L</i>	<i>Mandatory</i>
Scheme 2	Dynamic threshold on packet payload length	<i>L (M, A)</i>	<i>Option</i>
Scheme 3	Periodic packet emission	<i>T</i>	<i>Mandatory</i>
Scheme 4	Combination of Scheme 1 and Scheme 3	<i>L and T</i>	<i>Option</i>

7.7.1.1 Scheme 1: Triggering by fixed payload length threshold

A multiplexed packet is constructed by packet emission triggering based on a fixed payload length threshold. The following set of steps gives the procedure of the algorithm where the parameter L indicates a prespecified threshold value of the multiplexed packet payload length in bytes. Figure 8 depicts a sketch of the packetization process in this scheme.

Step 1) Set a threshold value L for a packet payload,

Step 2) If the total amount of short packets generated and collected for a multiplexed packet becomes equal to or greater than the threshold L , then send out the multiplexed packet. It should be noted that the delay of short packets waiting for transmission might vary largely with the traffic load change. For instance, when only a few number of voice streams are in progress, then the delay becomes longer.

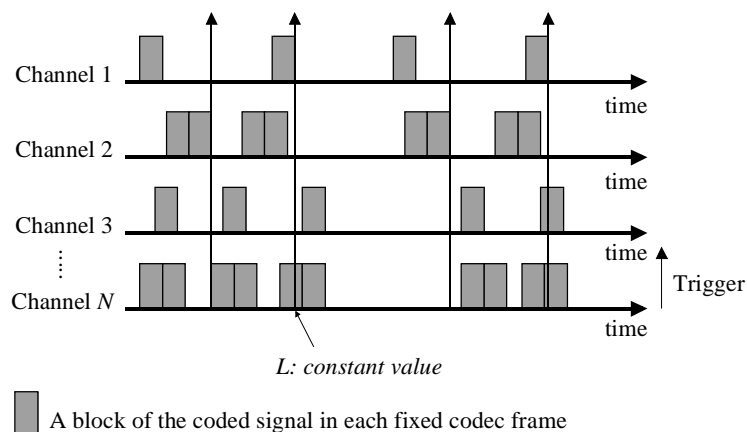

G.769_F08

Figure 8/G.769/Y.1242 – Multiplexing and packetization by triggers of fixed payload length threshold

7.7.1.2 Scheme 2: Triggering by dynamic payload length threshold

In order to have a more flexible threshold method, an algorithm in which the payload length threshold is dynamically changed as the function $L(M, A)$ is defined. In this function, M represents the time-varying number of voice streams in progress through the multiplexing device, and A is a constant that may be used to represent the speech activity ratio in the streams. The following set of steps gives the procedure, and a sketch of the packetization process in this scheme is shown in Figure 9.

Step 1) Set a constant A ;

Step 2) Update the value M when a voice stream is newly setup or released to calculate the current value of $L(M, A)$;

Step 3) If the total amount of short packets generated and collected for a multiplexed packet becomes equal to or greater than the threshold $L(M, A)$, then send out the multiplexed packet. For example, the function $L(M, A) = 10 \times M \times A$ is used assuming only a G.729 Annex whose frame interval is 10 ms and is used as a low rate codec. By this function, it is expected that $L(M, A)$ gives an estimate of the amount of short packets generated during a certain period such as a coding frame, and thus the variation of waiting delay for transmission may be lessened.

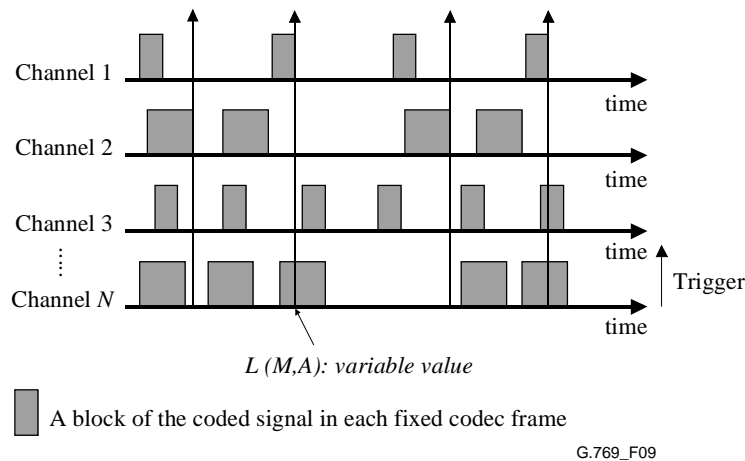

G.769_F09

Figure 9/G.769/Y.1242 – Multiplexing and packetization by triggers of dynamic payload length threshold

7.7.1.3 Scheme 3: Triggering by timer

In Scheme 3, a periodical timer is used in order to determine the timing to send out a multiplexed packet. The basic scheme is to use a fixed timer value that is specified beforehand. The following set of steps gives the procedure of the algorithm where the parameter T indicates a prespecified timer value. Figure 10 depicts a sketch of the packetization process in this scheme.

- Step 1) Set T to determine the timing of a multiplexed packet to be constructed. The trigger is activated periodically throughout the multiplexing operation;
- Step 2) When a trigger is activated by T , collect the short packets generated and stored, up to this moment, from the circuits concerned to construct the next multiplexed packet to be sent.

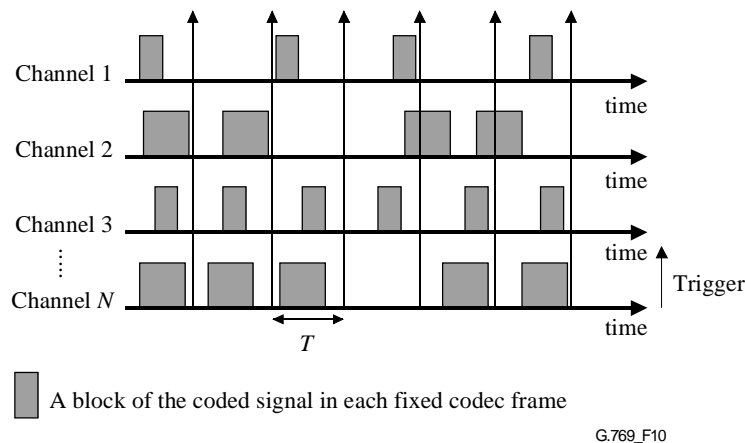

G.769_F10

Figure 10/G.769/Y.1242 – Multiplexing and packetization by triggers of periodical timer

7.7.1.4 Scheme 4: Combined scheme of Scheme 1 and Scheme 3

The scheme 4 that we consider is based on an algorithm that is derived by combining those of Scheme 1 and Scheme 3, that is, a combined use of triggering by a periodic timer and by a fixed payload length threshold.

NOTE – This scheme is based on a multiplexing algorithm whose triggering mechanism is a combination of triggering by timer and triggering by fixed payload length threshold and, especially, pursues the shortening of packetization delay under the heavy channel load condition by controlling the generation of packets with a lengthy RTP payload.

However, from the viewpoint of reduction of the header overhead ratio, the scheme might be disadvantageous because shorter RTP packets tend to be generated by triggering by timer just after RTP packets are generated by triggering by a fixed payload length threshold, especially under the heavy channel load condition as shown in Figure 11. The evaluation results using a prototype system of the comparisons of the header overhead in Figure 12 also show this trend.

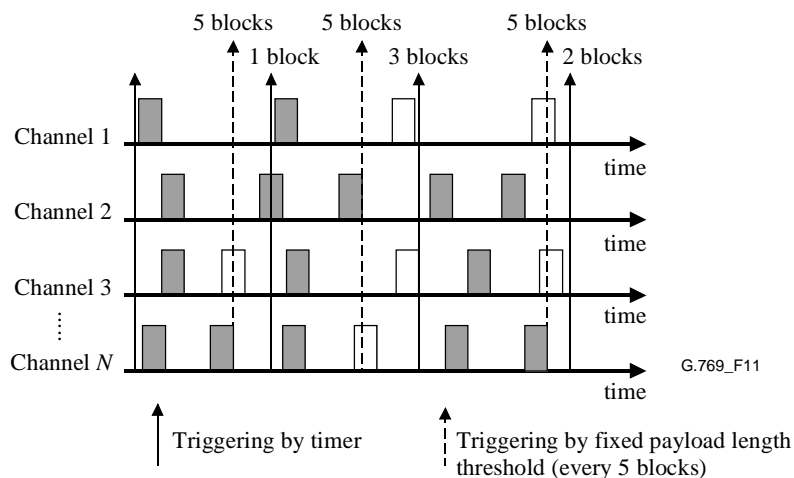

Figure 11/G.769/Y.1242 – The packetization mechanism in Scheme 4

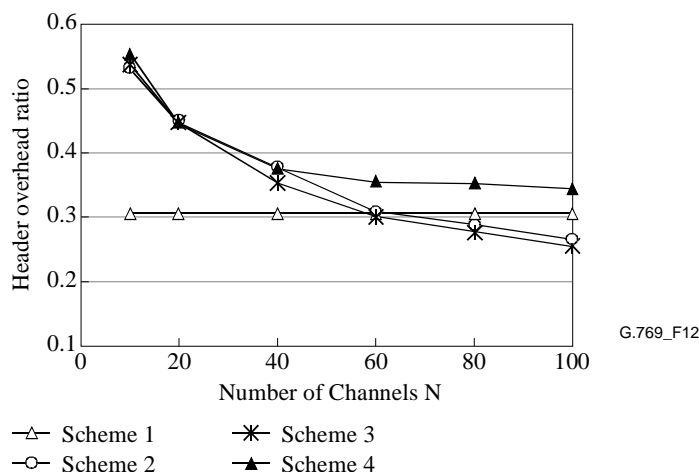

Figure 12/G.769/Y.1242 – Header overhead ratio

7.8 Multiplexing load control function

This function provides interworking between the multiplexing function and the functions of QoS policy management or Network management.

(Details are for further study.)

7.9 System operation management function

Management mechanisms for equipment faults and bearer interface faults on the GSTN side /IP network side and for maintenance operations are provided by this function.

(Details are for further study.)

7.10 QoS policy management function

7.10.1 QoS requirements and measures

To achieve QoS requirements, following measures shall be executed:

a) *Clarity measurements*

The objective quality measurement methods such as P.861 and P.862 Perceptual Evaluation of Speech Quality (PESQ) should be implemented.

b) *Voice activity measurements*

The chopping of the voice stream due to packet losses and other impairment factors should be measured.

c) *Delay measurement*

Delay does not affect the intelligibility, but rather the character, of a speech conversation. The measurement mechanism should be implemented.

7.11 Network management function

This issue is for further study.

Annex A

IP transmission channel control procedure

This annex provides details about the control procedure of IP transmission channel and structure of the multiplexed packet.

A.1 Conditions

The following are conditions for control of IP transmission channels.

An IP transmission channel is established or released depending on the following conditions:

- 1) The number of the streams of the IP ports within an IP transmission channel.
- 2) The type of the codec that is used in each call.
- 3) The requirements of the QoS of calls.

Furthermore, when the type of the codec is changeable in the same call (e.g. Speech to Facsimile), a detection mechanism of the type of the codec is needed and the following are examples of the detectors.

VBD/End-of-VBD signals detector, FAX/End-of-FAX signals detector, Speech detector.

An IP transmission channel may accommodate streams of the IP ports having the same coding type in order to simplify the triggering mechanisms of multiplexing schemes and reduce packetization delay.

A call has two directional streams such as from IP-CME A to IP-CME B, and vice versa. When a coding type of one direction of a call is different from the other, each stream can be accommodated by an independent IP transmission channel.

The maximum number of calls multiplexed onto one IP transmission channel is preassigned and the IP port ID (IPP-ID) identifies every call in the channel. The length of the IPP-ID is 7 bits. The maximum number of variations is therefore 128.

When the number of IPP-ID exceeds the maximum number, a new IP transmission channel shall be established.

The ID of the IP transmission channel is defined as a pair of numbers of the UDP ports on both sides of the IP-CMEs. Furthermore, a combination of the IPP-ID and ID of the IP transmission channel distinguishes a call.

When the number of calls in a channel falls to zero, and after a timer interval T, the IP transmission channel is released.

A.2 Parameters

The Trunk ID and Call ID versus the coding types is presented as shown in Table A.1. A Call ID distinguishes a call that is a voice stream connected on an IP transmission channel through the IP-CME. The maximum number of the Call ID depends on the number of trunks on the PSTN I/F "trunk channel number". Each Trunk is distinguished by the Trunk ID.

Table A.1/G.769/Y.1242 – Coding types of a call

Trunk ID	Call ID	Coding type
101	1	0000
102	2	0011
...

Table A.2 shows the coding features such as the algorithm name, compression bit rate and voice transfer structure. The call ID is related to Trunk ID which is shown in Table A.1.

NOTE – The coding algorithms that are shown in Table A.2 are nothing but the examples. A variety of coding algorithms such as the higher low bit rate codings and the variable bit rate ones should be supported in compliance with the future requirements.

Table A.2/G.769/Y.1242 – Coding features

Coding type	Algorithm name	Compression bit rate (kbit/s)	Voice transfer structure (Octets)
0000	PCM A-law (G.711)	64	40 × m
0001		56	35 × m
0010		48	30 × m
0011	PCM μ-law (G.711)	64	40 × m
0100		56	35 × m
0101		48	30 × m
0110	ADPCM (G.726)	40	25 × m
0111		32	20 × m
1000		24	15 × m
1001		16	10 × m
1010	LD-CELP (G.728)	16	10 × m
1011	CS-ACELP (G.729)	8	10 × m
1100	MP-MLQ (G.723.1)	6.3	24
1101	ACELP (G.723.1)	5.3	20
1110	GSM-EFR	13	20
1111	–	–	–

Table A.3 shows a mapping of the coding type and ID of the IP transmission channel.

Table A.3/G.769/Y.1242 – ID of IP transmission channels (m = 1~12)

Coding type	Maximum number of calls on an IP transmission channel				
	8 kbit/s	16 kbit/s	32 kbit/s	64 kbit/s	128 kbit/s
0000	1	2	3,4,5	6,7,8...9	10
1101	–	–	11,12,13	14,15...20	21
...

Call ID

Table A.4 shows relation between ID of the IP transmission channel and the call ID.

Table A.4/G.769/Y.1242 – Attributes of IP transmission channels

ID of IP transmission channel	UDP port number of Transmit part of the IP-CME	ID of other party IP-CME	UDP port number of Receive part of IP-CME	Maximum call stream number of an IP transmission channel	The total number of calls on an IP transmission channel	Call ID	IPP-ID
1	15001	1 or IP address	16001	64	40	1,2,12, 10...	1,2,3, 4...
2	15002	2	16002	64	60	3,7,9, 11...	1,2,3, 4...
3	15003	3	16003	32	10	4,13...	1,2...
...

A.3 Procedure

The following steps show a control procedure for the IP transmission channel. Figure A.1 is a conceptual sketch of the control.

NOTE – Signalling part of Call control (A-1, B-1) in IP-CME is required when the call control signalling is transmitted over IP-based networks.

A.3.1 Transmit side of IP-CME A

Step 1) The switching section of the IP-CME A (A-4) distributes the TDM side call control signalling and data stream to the Signalling part of Call control (A-1) and Coding part Channel #n (A-5-n), respectively.

Step 2) The signalling is forwarded to the signalling sections of the call control in the IP-CME B (B-1) via signalling sections of the call control of the IP-CME A (A-1).

The data stream is transmitted to the coding section channel #n (A-5-n) to set the proper encoding scheme and requests the packetization section channel #n (A-6-n) of the IP transmission channel to set the proper short packet header information and to operate the scheduled multiplexing scheme.

The proper encoding scheme is provided by IP-CME profile.

Step 3) The management part of the IP transmission channels and IP-CME control (A-2) checks the coding features in the Table #A2 which is defined based on the IP-CME profile and updates the Table #A1. The A-2 also records the information of the Call ID and the coding type in Table #A1.

Step 4) The A-2 checks the coding type and the maximum call stream number of the IP transmission channel in Table #A3 and requests A-4 to assign the call stream to the proper IP transmission channel. The A-2 also sends information on the IPP-ID, encoding type.

Step 5) The A-2 updates Table #A4 and sends the modified information of Table #A4 to the other party IP-CME (IP-CME B) via the signalling section of the IP transmission channels and IP-CME control (A-3).

A.3.2 Receive side of IP-CME B

Step 1) The B-1 receives the signalling and forwards it to the switching section (B-4).

Step 2) The signalling section of the IP transmission channel and IP-CME control (B-3) receives the updated information of Table #B4 and forwards it to the management section of IP transmission channel and IP-CME control (B-2). The B-2 updates Tables #B4 and #B1.

- Step 3) The B-4 chooses a trunk and sends a signalling message to the PSTN. The signalling messages received at B-1 are also forwarded to B-2.
- Step 4) The B-2 checks the coding type and requests B-4 to set the proper decoding scheme at B-5-n taking into account the information of Table #B4.
- Step 5) The depacketization section Channel #n (B-6-n) receives the multiplexed stream and checks the short packet header information such as the IPP-ID and forwards it to B-4. The B-4 distributes the signal of the short packets to the proper trunk based on the IPP-ID and information such as the Call ID provided by B-2.

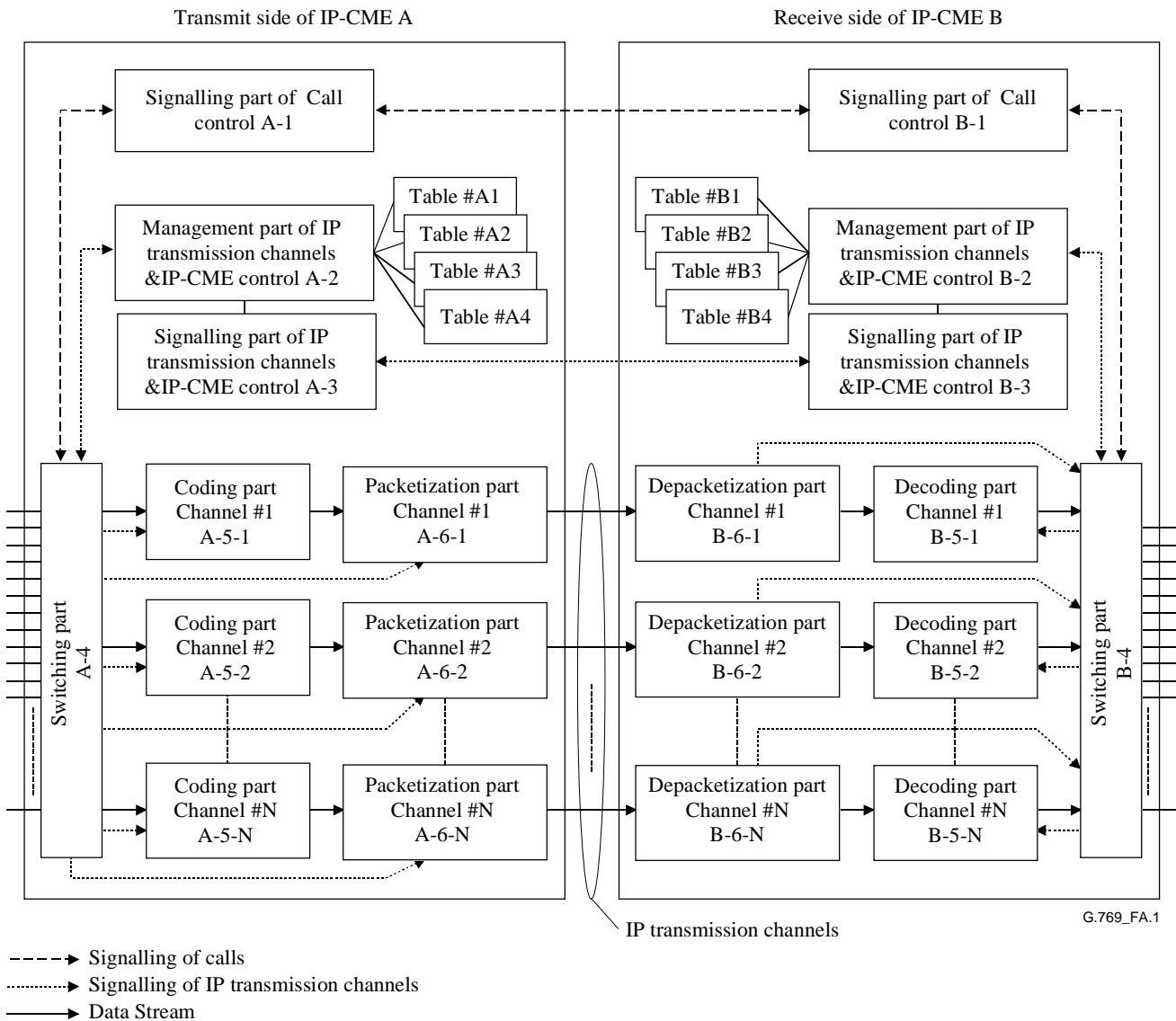

Figure A.1/G.769/Y.1242 – Conceptual block diagram of IP transmission channel control

A.4 Structure of the multiplexed packet

There are alternative methods with respect to structuring the short packet payload and header and IP packet payload. Figure A.2 depicts a short packet header and the IP packet structure in multiplexing schemes.

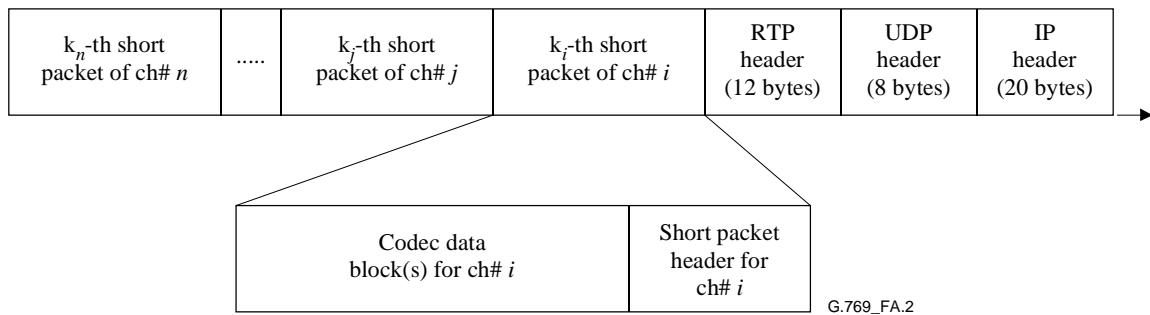

Figure A.2/G.769/Y.1242 – IP packet structure and short packet header elements

The length of the short packet header, which has information to reconstruct the original RTP/UDP/IP header, should be as small as possible and it is set to be 2-byte or 4-byte. Figure A.3 shows the format of the short packet header and Figure A.4 illustrates the configuration of the IP/UDP/RTP connections between the IP-CMEs. Following are the entries and their meanings.

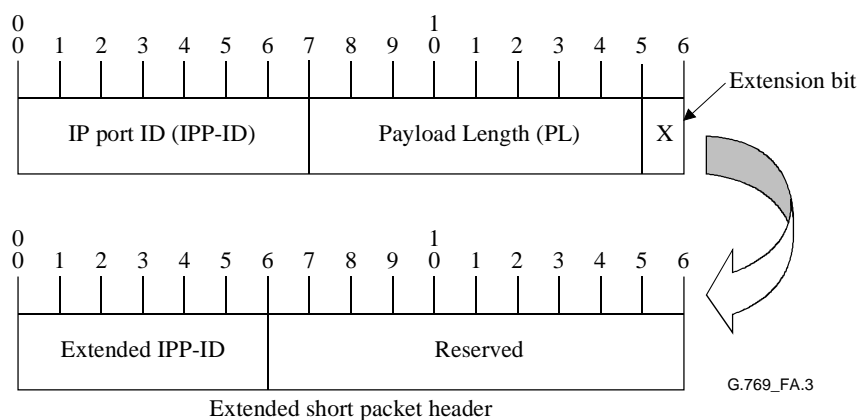

Figure A.3/G.769/Y.1242 – Format of the short packet header

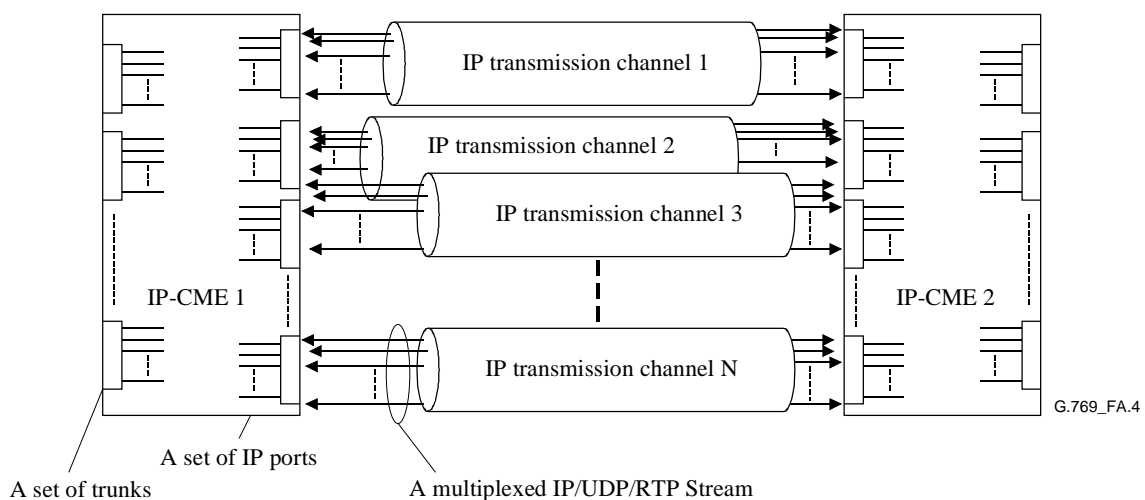

Figure A.4/G.769/Y.1242 – Configuration of the RTP connection between the IP-CMEs

A.4.1 IP port ID (IPP-ID): 7 bits

This field indicates 128 different IPP-IDs. The IPP-ID is used to identify the stream (call) at the IP-CME. The IP-CME can simultaneously support several IP/UDP/RTP connections called "IP transmission channel". When the number of the IPP-ID exceeds 128, a new IP transmission channel is established as shown in Figure A.4 or the extension bit is set in order to support large IPP-ID number using the Extended IPP-ID field in Figure A.3

A.4.2 Extension bit (X): 1 bit

Indication of the extension header is used, for example, as a negotiation signalling for changing the encodings without disconnecting the Circuit, when the number of streams (calls) in an IP transmission channel exceeds 128. The extension header is 2 bytes and is present when the X bit is set to "1".

A.4.3 Payload Length (PL): 8 bits

This field provides the type of the payload size by using 256 different numbers. In this case, the IP-CMEs connected to each other need to have a table to map the type and note that the field may also indicate the exact payload size of the coded block in bytes.

NOTE 1 – The 8-bit field of the PL allows a maximum payload length of 256 bytes and this size may be sufficient because most voice codecs such as the G.729 series generate encoded blocks of less than 200 bytes in each frame. In general, furthermore, on an Ethernet that is frequently used as a portion of IP-based networks, the maximum size of an IP packet datagram that manages to go through over the Ethernet without fragmentation into short datagrams is restricted to 1500 bytes or less. Considering this condition of the Ethernet, the sizes of both IPP-ID and PL are adjusted in order to provide enough information for multiplexed short packets in an IP packet whose total length is 1500 bytes or less.

NOTE 2 – A header error correction control field to guarantee the consistency of the short packet header has been left out since UDP checksum in the UDP header could be applicable for this use.

The examples of the characteristics of standard audio encodings are shown in Table A.5.

Table A.5/G.769/Y.1242 – Properties of audio encodings

Encoding format	Bit rate (kbit/s)	Sample/frame	Bits/sample	ms/frame
G.711 (A-law, μ -law)	64	Sample	8	–
G.723.1	5.3/6.3	Frame	–	30
G.729	8	Frame	–	10

Appendix I

Functional architecture

This appendix provides an example of the functional implementation of IP-CME.

I.1 Functional implementation

Figures I.1/G.769 and I.2/G.769 show examples of the functional implementation of IP-CME for transmit side and received side respectively. Since the IP packets are bidirectional, transmitted in the form of full-duplex communication, each IP-CME shall have both the transmit side and receive side functionalities.

I.1.1 Transmit side of IP-CME

IP transmission channel control functional Unit (A-2) communicates with the functional Unit (B-2) in the destination side. IP-CME determines a specified coding type and other profiling parameters for controlling IP transmission channels. Call control functional Unit (A-1) communicates with the functional Unit (B-1) in the destination side. IP-CME connects the calls between the origin side and destination side IP-CMEs.

In the transmit side IP-CME, the voice, Facsimile and VBD signals of the call via the communication channel is applied to the coding functional Unit (A-12). The coding functional Unit encodes the signal into encoded signal in accordance with one of the coding types determined by coding type order functional Unit (A-7) based on IP transmission channel control signalling (A-2). The silence part of the voice signal is compressed and thus the active part signal is encoded.

The encoded signal from the coding functional Unit (A-12) is applied to the buffer functional Unit (A-13) and temporarily stored therein. The short packet construction functional Unit (A-15) gets a short packet header for the encoded signal of the call from the short packet header generation functional Unit (A-8). The functional Unit (A-15) also gets a payload length of the short packet for the encoded signal from the payload length indication functional Unit (A-19), and then extracts from the buffer functional Unit (A-16) a part of the encoded signal with the payload length as a segment.

The short packet, composed of the short packet header (SPH) and the short packet payload (SPP), is provided for each call. In the short packet header, an IP port number (IPP-ID) and a payload length (PL) are provided. The short packet construction functional Unit (A-15) transfers the constructed short packet to the short packet buffer functional Unit (A-16).

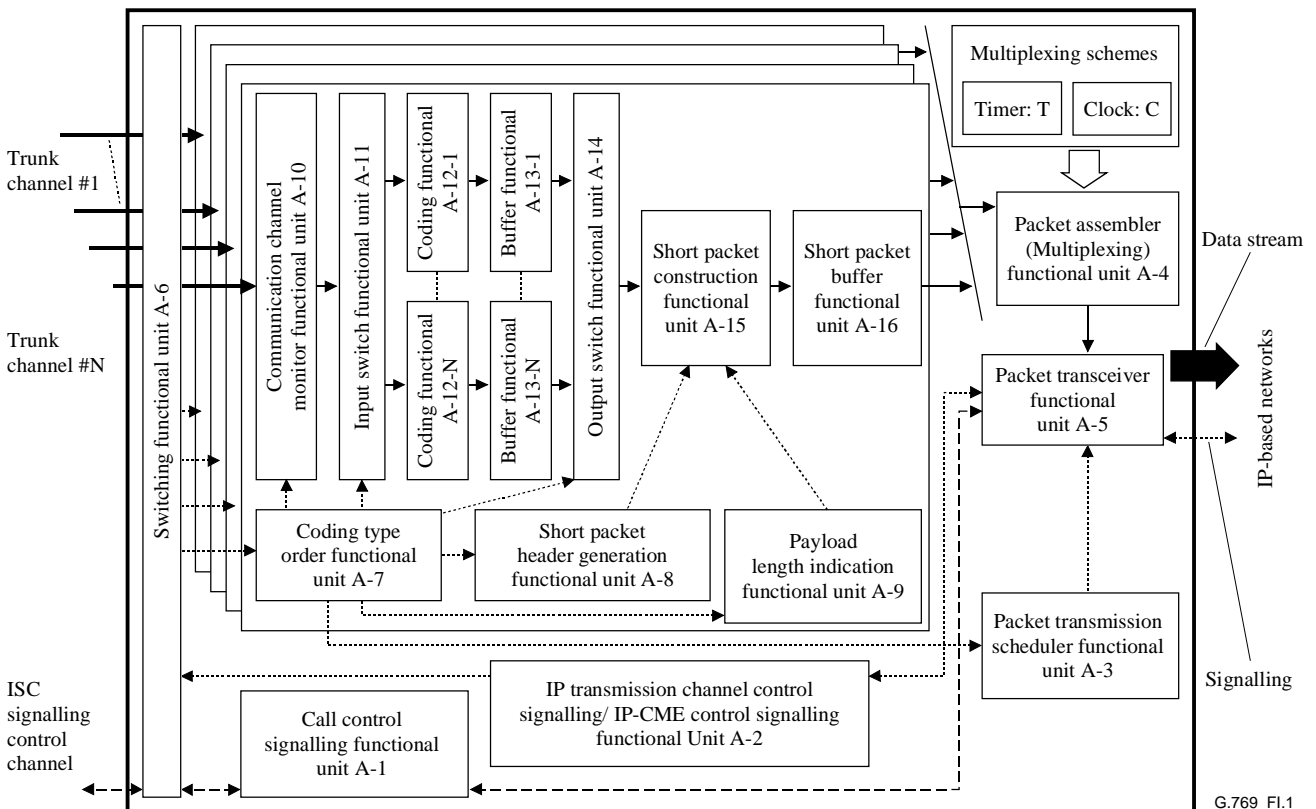

Figure I.1/G.769/Y.1242 – Example of block diagram of multiplication in Transmit side of IP-CME

I.1.2 Receive side of IP-CME

The IP packets transmitted from the transmit side IP-CME are received at the packet transceiver functional Unit (B-4) in the receive side IP-CME. The received IP packet is transferred to the packet disassembler functional Unit (B-3).

The disassembler functional Unit (B-4) disassembles the received IP packet into short packets. Then the functional Unit B-4 reads out the communication channel numbers described in the short packet headers of the respective short packets and transfers these short packets to the corresponding short packet buffer functional Units (B-6), respectively. The short packet disassembler functional Unit (B-7) extracts the short packet and disassembles it into a short packet header and a short packet payload. Then, the disassembler functional Unit (B-7) transfers the coded signals in the short packet payload to the buffer functional Unit (B-8). The buffer functional Unit B-8 inserts a fill-in signal such as a signal indicating silence between the immediately preceding segment and the current segment. The decoding functional Unit (B-9-n (n; from 1 to N)) sequentially decodes the coded signals extracted from the buffer functional Unit (B-7) to convert into ISC signals for the telephone network.

In IP-CME, an optimum coding type for the content of the information signal can be selected for each communication channel during communication of the call. The transmit side IP-CME has, as shown in Figure I.1, N coding functional Units (A-12-1) to (A-12-N) which operate different coding algorithms for one communication channel, N buffer functional Units (A-13-1) to (A-13-N), a communication channel monitor functional Unit (A-10), an input switch functional Unit (A-11), an output switch functional Unit (A-14) and a coding type order functional Unit (A-7). On the other hand the receive side IP-CME has, in addition N decoding functional Units (B-9-1) to (B-9-N) which operate different coding algorithms for one communication channel and N buffer functional Units (B-8-1) to (B-8-N).

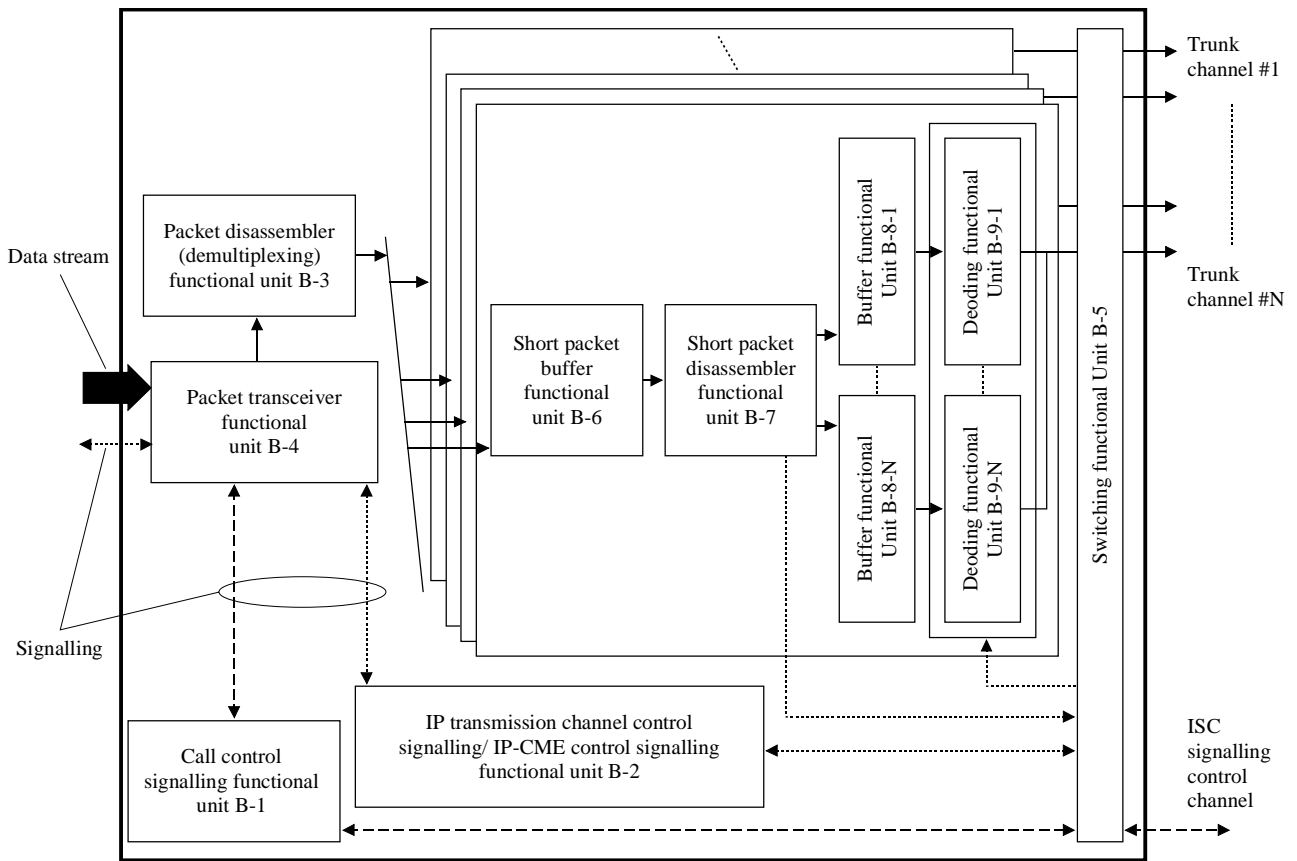

G.769_FI.2

Figure I.2/G.769/Y.1242 – Example of block diagram of multiplication in Receive side of IP-CME

ITU-T Y-SERIES RECOMMENDATIONS
GLOBAL INFORMATION INFRASTRUCTURE AND INTERNET PROTOCOL ASPECTS

GLOBAL INFORMATION INFRASTRUCTURE	
General	Y.100–Y.199
Services, applications and middleware	Y.200–Y.299
Network aspects	Y.300–Y.399
Interfaces and protocols	Y.400–Y.499
Numbering, addressing and naming	Y.500–Y.599
Operation, administration and maintenance	Y.600–Y.699
Security	Y.700–Y.799
Performances	Y.800–Y.899
INTERNET PROTOCOL ASPECTS	
General	Y.1000–Y.1099
Services and applications	Y.1100–Y.1199
Architecture, access, network capabilities and resource management	Y.1200–Y.1299
Transport	Y.1300–Y.1399
Interworking	Y.1400–Y.1499
Quality of service and network performance	Y.1500–Y.1599
Signalling	Y.1600–Y.1699
Operation, administration and maintenance	Y.1700–Y.1799
Charging	Y.1800–Y.1899

For further details, please refer to the list of ITU-T Recommendations.

SERIES OF ITU-T RECOMMENDATIONS

- Series A Organization of the work of ITU-T
- Series B Means of expression: definitions, symbols, classification
- Series C General telecommunication statistics
- Series D General tariff principles
- Series E Overall network operation, telephone service, service operation and human factors
- Series F Non-telephone telecommunication services
- Series G Transmission systems and media, digital systems and networks**
- Series H Audiovisual and multimedia systems
- Series I Integrated services digital network
- Series J Cable networks and transmission of television, sound programme and other multimedia signals
- Series K Protection against interference
- Series L Construction, installation and protection of cables and other elements of outside plant
- Series M TMN and network maintenance: international transmission systems, telephone circuits, telegraphy, facsimile and leased circuits
- Series N Maintenance: international sound programme and television transmission circuits
- Series O Specifications of measuring equipment
- Series P Telephone transmission quality, telephone installations, local line networks
- Series Q Switching and signalling
- Series R Telegraph transmission
- Series S Telegraph services terminal equipment
- Series T Terminals for telematic services
- Series U Telegraph switching
- Series V Data communication over the telephone network
- Series X Data networks and open system communications
- Series Y Global information infrastructure and Internet protocol aspects**
- Series Z Languages and general software aspects for telecommunication systems

