

ITU-T

TELECOMMUNICATION
STANDARDIZATION SECTOR
OF ITU

G.8051/Y.1345

Amendment 1
(08/2017)

SERIES G: TRANSMISSION SYSTEMS AND MEDIA,
DIGITAL SYSTEMS AND NETWORKS

Packet over Transport aspects – Ethernet over Transport
aspects

SERIES Y: GLOBAL INFORMATION
INFRASTRUCTURE, INTERNET PROTOCOL ASPECTS,
NEXT-GENERATION NETWORKS, INTERNET OF
THINGS AND SMART CITIES

Internet protocol aspects – Transport

Management aspects of the Ethernet transport (ET)
capable network element

Amendment 1

Recommendation ITU-T G.8051/Y.1345 (2015) –
Amendment 1

ITU-T G-SERIES RECOMMENDATIONS
TRANSMISSION SYSTEMS AND MEDIA, DIGITAL SYSTEMS AND NETWORKS

INTERNATIONAL TELEPHONE CONNECTIONS AND CIRCUITS	G.100–G.199
GENERAL CHARACTERISTICS COMMON TO ALL ANALOGUE CARRIER-TRANSMISSION SYSTEMS	G.200–G.299
INDIVIDUAL CHARACTERISTICS OF INTERNATIONAL CARRIER TELEPHONE SYSTEMS ON METALLIC LINES	G.300–G.399
GENERAL CHARACTERISTICS OF INTERNATIONAL CARRIER TELEPHONE SYSTEMS ON RADIO-RELAY OR SATELLITE LINKS AND INTERCONNECTION WITH METALLIC LINES	G.400–G.449
COORDINATION OF RADIOTELEPHONY AND LINE TELEPHONY	G.450–G.499
TRANSMISSION MEDIA AND OPTICAL SYSTEMS CHARACTERISTICS	G.600–G.699
DIGITAL TERMINAL EQUIPMENTS	G.700–G.799
DIGITAL NETWORKS	G.800–G.899
DIGITAL SECTIONS AND DIGITAL LINE SYSTEM	G.900–G.999
MULTIMEDIA QUALITY OF SERVICE AND PERFORMANCE – GENERIC AND USER-RELATED ASPECTS	G.1000–G.1999
TRANSMISSION MEDIA CHARACTERISTICS	G.6000–G.6999
DATA OVER TRANSPORT – GENERIC ASPECTS	G.7000–G.7999
PACKET OVER TRANSPORT ASPECTS	G.8000–G.8999
Ethernet over Transport aspects	G.8000–G.8099
MPLS over Transport aspects	G.8100–G.8199
Synchronization, quality and availability targets	G.8200–G.8299
Service Management	G.8600–G.8699
ACCESS NETWORKS	G.9000–G.9999

For further details, please refer to the list of ITU-T Recommendations.

Recommendation ITU-T G.8051/Y.1345

Management aspects of the Ethernet transport (ET) capable network element

Amendment 1

Summary

Recommendation ITU-T G.8051/Y.1345 addresses management aspects of the Ethernet transport network element containing transport functions of one or more of the layer networks of the Ethernet transport network. The management of the Ethernet layer networks is separable from that of its client layer networks so that the same means of management can be used regardless of the client. The management functions for fault management, configuration management, performance monitoring, and security management are specified.

The 2009 revision of this Recommendation added the management of additional transport functions that were introduced in the 2009 revision of Recommendation ITU-T G.8021/Y.1341.

The 2013 revision of this Recommendation added the management of additional functions, including: client signal fail (CSF); proactive loss measurement using loss measurement message (LMM)/loss measurement reply (LMR); proactive delay measurement using delay measurement message (DMM)/delay measurement reply (DMR) and one-way delay measurement (1DM); synthetic loss measurement using synthetic loss message (SLM)/synthetic loss reply (SLR) and one-way synthetic loss measurement (1SL) (proactive and on-demand); performance management (PM) requirements on protocol data unit (PDU) generation type, message period, measurement interval, repetition period, start time, stop time and session duration; and PM data collection requirements.

The 2015 Revision of this Recommendation has updated the management information (MI) signals for the ETHx_FT function in clause 8.5, the MI signals for the ETHx/MCC function in clause 8.6, the one-way synthetic loss measurement (1SL) MI signal for the ETHDe_FT_Sk function in clause 8.8, and the on-demand and proactive loss measurement requirements in clause 10.2.

Amendment 1 provides:

- Addition of fFOP-PM and fFOP-TO for ETH_C_MI in clause 7
- Deletion of the description related to ODUkP-X-L/MT_A in clauses 7, 8 and 10, due to the deletion of LCAS-capable ODUk to ETH Adaptation function in Recommendation ITU-T G.8021
- Update of the text in clause 8.3, "Protection switching"
- Update of RAPS (Recommendation ITU-T G.8032) related MIs for ETH-C in Table 8-4
- Addition of the definitions for Traffic condition and shaping functions in clause 3
- Update of some references in clause 2

History

Edition	Recommendation	Approval	Study Group	Unique ID*
1.0	ITU-T G.8051/Y.1345	2007-10-22	15	11.1002/1000/9186
2.0	ITU-T G.8051/Y.1345	2009-11-13	15	11.1002/1000/10430
2.1	ITU-T G.8051/Y.1345 (2009) Amd. 1	2011-06-06	15	11.1002/1000/11139
3.0	ITU-T G.8051/Y.1345	2013-08-29	15	11.1002/1000/12024
3.1	ITU-T G.8051/Y.1345 (2013) Amd. 1	2014-05-14	15	11.1002/1000/12186
4.0	ITU-T G.8051/Y.1345	2015-08-13	15	11.1002/1000/12549
4.1	ITU-T G.8051/Y.1345 (2015) Amd. 1	2017-08-13	15	11.1002/1000/13314

Keywords

Carrier Ethernet, transport resource.

* To access the Recommendation, type the URL <http://handle.itu.int/> in the address field of your web browser, followed by the Recommendation's unique ID. For example, <http://handle.itu.int/11.1002/1000/11830-en>.

FOREWORD

The International Telecommunication Union (ITU) is the United Nations specialized agency in the field of telecommunications, information and communication technologies (ICTs). The ITU Telecommunication Standardization Sector (ITU-T) is a permanent organ of ITU. ITU-T is responsible for studying technical, operating and tariff questions and issuing Recommendations on them with a view to standardizing telecommunications on a worldwide basis.

The World Telecommunication Standardization Assembly (WTSA), which meets every four years, establishes the topics for study by the ITU-T study groups which, in turn, produce Recommendations on these topics.

The approval of ITU-T Recommendations is covered by the procedure laid down in WTSA Resolution 1.

In some areas of information technology which fall within ITU-T's purview, the necessary standards are prepared on a collaborative basis with ISO and IEC.

NOTE

In this Recommendation, the expression "Administration" is used for conciseness to indicate both a telecommunication administration and a recognized operating agency.

Compliance with this Recommendation is voluntary. However, the Recommendation may contain certain mandatory provisions (to ensure, e.g., interoperability or applicability) and compliance with the Recommendation is achieved when all of these mandatory provisions are met. The words "shall" or some other obligatory language such as "must" and the negative equivalents are used to express requirements. The use of such words does not suggest that compliance with the Recommendation is required of any party.

INTELLECTUAL PROPERTY RIGHTS

ITU draws attention to the possibility that the practice or implementation of this Recommendation may involve the use of a claimed Intellectual Property Right. ITU takes no position concerning the evidence, validity or applicability of claimed Intellectual Property Rights, whether asserted by ITU members or others outside of the Recommendation development process.

As of the date of approval of this Recommendation, ITU had not received notice of intellectual property, protected by patents, which may be required to implement this Recommendation. However, implementers are cautioned that this may not represent the latest information and are therefore strongly urged to consult the TSB patent database at <http://www.itu.int/ITU-T/ipr/>.

© ITU 2017

All rights reserved. No part of this publication may be reproduced, by any means whatsoever, without the prior written permission of ITU.

Table of Contents

	Page
1	Scope..... 1
2	References..... 2
3	Definitions 3
3.1	Terms defined elsewhere 3
3.2	Terms defined in this Recommendation 4
4	Abbreviations and acronyms 4
5	Conventions 7
6	ET management architecture 7
6.1	ET network management architecture 7
6.2	ET equipment management function architecture 10
6.3	Information flows over management points 11
7	Fault (maintenance) management 12
7.1	Fault management applications 12
7.2	Fault management functions 14
8	Configuration management 22
8.1	Hardware 22
8.2	Software 22
8.3	Protection switching 22
8.4	Trail termination 23
8.5	Flow termination 23
8.6	Adaptation 28
8.7	Connection 38
8.8	Diagnostic 39
8.9	Traffic conditioning and shaping 42
8.10	XXX_Reported 43
8.11	Alarm severity 43
8.12	Alarm reporting control 43
8.13	PM thresholds 44
8.14	TCM activations 44
8.15	Date and time 44
9	Accounting management 45
10	Performance management 45
10.1	Performance management applications 45
10.2	Performance monitoring functions 45
11	Security management 54
	Appendix I – MI signals/parameters for PM tools in ITU-T G.8021 55

Recommendation ITU-T G.8051/Y.1345

Management aspects of the Ethernet transport (ET) capable network element

Amendment 1

Editorial note: This is a complete-text publication. Modifications introduced by this amendment are shown in revision marks relative to Recommendation ITU-T G.8051/Y.1345 (2015).

1 Scope

This Recommendation addresses management aspects of the Ethernet transport (ET) capable network element containing transport functions of one or more of the layer networks of the Ethernet transport network. The management of the Ethernet layer networks is separable from that of its client layer networks so that the same means of management can be used regardless of the client. In this version of this Recommendation, fault management, configuration management, performance management (PM), and security management are specified. Accounting management is for further study. Furthermore, only the management information (MI) of the following ET equipment functions is addressed:

- Ethernet MAC layer (ETH) flow forwarding, flow termination, connection, diagnostic, and traffic conditioning/shaping functions;
- ETH server to ETH client adaptation functions (including ETH/ETH-m and ETHG/ETH);
- ETH link aggregation functions;
- Ethernet PHY layer (ETYn) trail termination functions;
- ETYn server to ETH client adaptation functions;
- GFP-F-based mapping of Ethernet into SDH;
- GFP-T-based mapping of Gigabit Ethernet code words into VC-4-Xv;
- PDH server to ETH client adaptation functions; and
- OTN server to ETH client adaptation functions.

The management of the adaptation of other clients and servers with respect to ET is for further study.

This Recommendation also describes the management network organizational model for communication between an element management layer (EML) operations system and the ET equipment management function (EMF) within an ET network element.

The architecture described in this Recommendation for the management of Ethernet transport networks is based upon the following considerations:

- the management view of network element functional elements should be uniform whether these elements form part of an inter-domain interface or part of an intra-domain interface. The properties necessary to form such a uniform management view are to be included in this Recommendation;
- Ethernet layer network entities (ELNEs) refer to trail termination, adaptation and connection functions as described in [ITU-T G.8010];
- a network element may only contain Ethernet layer network entities;
- a network element may contain both ELNEs and client layer network entities (CLNEs);
- client layer entities are managed as part of their own logical domain;

- CLNEs and ELNEs may or may not share a common message communication function (MCF) and management application function (MAF) depending on application; and
- CLNEs and ELNEs may or may not share the same agent;
- server layer network entities (SLNEs) and ELNEs may or may not share the same agent.

2 References

The following ITU-T Recommendations and other references contain provisions which, through reference in this text, constitute provisions of this Recommendation. At the time of publication, the editions indicated were valid. All Recommendations and other references are subject to revision; users of this Recommendation are therefore encouraged to investigate the possibility of applying the most recent edition of the Recommendations and other references listed below. A list of the currently valid ITU-T Recommendations is regularly published. The reference to a document within this Recommendation does not give it, as a stand-alone document, the status of a Recommendation.

- [ITU-T G.707] Recommendation ITU-T G.707/Y.1322 (2007), *Network node interface for the synchronous digital hierarchy (SDH)*.
- [ITU-T G.709] Recommendation ITU-T G.709/Y.1331 (2016~~2~~), *Interfaces for the optical transport network*, plus Amendment 1 (~~2012~~2016) and [Corrigendum 1 \(2017\)](#).
- [ITU-T G.805] Recommendation ITU-T G.805 (2000), *Generic functional architecture of transport networks*.
- [ITU-T G.806] Recommendation ITU-T G.806 (2012), *Characteristics of transport equipment – Description methodology and generic functionality*, [plus Corrigendum 1 \(2012\)](#), [Corrigendum 2 \(2016\)](#) and [Corrigendum 3 \(2017\)](#).
- [ITU-T G.832] Recommendation ITU-T G.832 (1998), *Transport of SDH elements on PDH networks – Frame and multiplexing structures*.
- [ITU-T G.7041] Recommendation ITU-T G.7041/Y.1303 (2016~~4~~), *Generic framing procedure*.
- [ITU-T G.7710] Recommendation ITU-T G.7710/Y.1701 (2012), *Common equipment management function requirements*, [plus, Amendment 1\(2016\)](#).
- [ITU-T G.7712] Recommendation ITU-T G.7712/Y.1703 (2010), *Architecture and specification of data communication network*, [plus Amendment 1\(2013\)](#) and [Amendment 2 \(2016\)](#).
- [ITU-T G.8001] Recommendation ITU-T G.8001/Y.1354 (2013), *Terms and definitions for Ethernet frames over transport*.
- [ITU-T G.8010] Recommendation ITU-T G.8010/Y.1306 (2004), *Architecture of Ethernet layer networks*.
- [ITU-T G.8012] Recommendation ITU-T G.8012/Y.1308 (2004), *Ethernet UNI and Ethernet NNI* plus Amendment 1 (2006) [and Amendment 2 \(2016\)](#).
- [ITU-T G.8013] Recommendation ITU-T G.8013/Y.1731 (~~2011~~2015), *OAM functions and mechanisms for Ethernet- based networks*.
- [ITU-T G.8021] Recommendation ITU-T G.8021/Y.1341 (~~2012~~2016), *Characteristics of Ethernet transport network equipment functional blocks*.
- [ITU-T M.20] Recommendation ITU-T M.20 (1992), *Maintenance philosophy for telecommunication networks*.
- [ITU-T M.3010] Recommendation ITU-T M.3010 (2000), *Principles for a telecommunications management network*.

- [ITU-T M.3013] Recommendation ITU-T M.3013 (2000), *Considerations for a telecommunications management network*.
- [ITU-T M.3100] Recommendation ITU-T M.3100 (2005), *Generic network information model*.
- [ITU-T X.700] Recommendation ITU-T X.700 (1992), *Management framework for Open Systems Interconnection (OSI) for CCITT applications*.
- [ITU-T X.701] Recommendation ITU-T X.701 (1997) | ISO/IEC 10040:1998, *Information technology – Open Systems Interconnection – Systems management overview*.
- [ITU-T X.733] Recommendation ITU-T X.733 (1992) | ISO/IEC 10164-4:1992, *Information technology – Open Systems Interconnection – Systems Management: Alarm reporting function*.
- [ITU-T X.735] Recommendation ITU-T X.735 (1992) | ISO/IEC 10164-6:1993, *Information technology – Open Systems Interconnection – Systems Management: Log control function*.
- [ITU-T Y.1563] Recommendation ITU-T Y.1563 (2009), *Ethernet frame transfer and availability performance*.
- [IEEE 802.3] IEEE 802.3 (201502), *IEEE Standard for Information technology – Local and metropolitan area networks – Specific requirements – Part 3: Carrier Sense Multiple Access with Collision Detection (CSMA/CD) Access Method and Physical Layer Specifications*.

3 Definitions

3.1 Terms defined elsewhere

This Recommendation uses the following terms defined elsewhere:

3.1.1 Terms defined in [ITU-T G.806]:

- Atomic function (AF);
- Management point (MP).

3.1.2 Terms defined in [ITU-T G.7710]:

- Local craft terminal;
- Management application function (MAF).

3.1.3 Term defined in [ITU-T G.7712]:

- Data communication network (DCN).

3.1.4 Terms defined in [ITU-T G.8001]:

- ET management network (ET.MN);
- ET management subnetwork (ET.MSN);
- ET network element (ET.NE);
- Ethernet management communication channel (ET MCC)

– [Traffic conditioning function](#);

– [Traffic shaping function](#).

3.1.5 Terms defined in [ITU-T M.3010]:

- Network element (NE);
- Network element function (NEF);

- Operations system (OS);
 - Q-interface;
 - Workstation function (WF).
- 3.1.6** Term defined in [ITU-T M.3013]:
- Message communication function (MCF).
- 3.1.7** Terms defined in [ITU-T M.3100]:
- Alarm reporting;
 - Alarm reporting control (ARC);
 - Managed entity;
 - Management interface;
 - Persistence interval;
 - Operations system (OS);
 - Operations system function (OSF);
 - Qualified problem;
 - Reset threshold report;
 - Threshold report;
 - Timed interval.
- 3.1.8** Term defined in [ITU-T X.700]:
- Managed object (MO).
- 3.1.9** Terms defined in [ITU-T X.701]:
- Agent;
 - Manager;
 - Managed object class (MOC)

3.2 Terms defined in this Recommendation

None.

4 Abbreviations and acronyms

This Recommendation uses the following abbreviations:

1DM	One-way Delay Measurement
1SL	One-way Synthetic Loss measurement
AcSL	Accepted Signal Label
AF	Atomic Function
AIS	Alarm Indication Signal
ALM	ALarM reporting
APP	Access Point Pool
ARC	Alarm Reporting Control
CC	Continuity Check
CCM	Continuity Check Message

CLNE	Client Layer Network Entity
COMMS	Communication channel
CSF	Client Signal Fail
CTP	Connection Termination Point
CtrlP	Control Plane
DA	Destination Address
DCN	Data Communication Network
DE	Drop Eligibility
DEG	Degraded
DEGM	Degraded M
DEGTHR	Degraded Threshold
DMM	Delay Measurement Message
DMR	Delay Measurement Reply
ECC	Embedded Communication Channel
ELNE	Ethernet Layer Network Entity
EMF	Equipment Management Function
ET	Ethernet Transport
ET.C	ET Channel layer
ET.MN	ET Management Network
ET.MSN	ET Management SubNetwork
ET.NE	ET Network Element
ET.P	ET Path layer
ET.S	ET Section layer
ETHx	Ethernet MAC layer network – x, x=s for section, x=p for path, x=t for TCM
FCAPS	Fault, Configuration, Account, Performance and Security Management
FFS	For Further Study
FLR	Frame Loss Ratio
FM	Fault Management
FTS	Forced Transmitter Shutdown
GNE	Gateway Network Element
IP	Interworking Protocol
IS	Intermediate System
LAN	Local Area Network
LCN	Local Communications Network
LMM	Loss Measurement Message
LMR	Loss Measurement Reply
MAF	Management Application Function

MCC	Management Communication Channel
MCF	Message Communication Function
MD	Mediation Device
ME	Maintenance Entity
MEG	ME Group
MEL	MEG Level
MEP	MEG End Point
MIP	MEG Intermediate Point
MF	Mediation Function
MI	Management Information
MIB	Management Information Base
MN	Management Network
MO	Managed Object
MOC	Managed Object Class
MgmtP	Management Plane
MP	Management Point
MSN	Management SubNetwork
NALM	No ALaRm reporting
NALM-CD	No ALaRm reporting, Countdown
NALM-NR	No ALaRm reporting, NotReady
NALM-QI	No ALaRm reporting, Qualified Inhibit
NALM-TI	No ALaRm reporting, Timed Inhibit
NE	Network Element
NEF	Network Element Function
NEL	Network Element Layer
OAM	Operations, Administration, Maintenance
OAM&P	Operations, Administration, Maintenance and Provisioning
OS	Operations System
OSF	Operations System Function
OSI	Open Systems Interconnection
P	Priority
PDU	Protocol Data Unit
PM	Performance Management
PMC	Performance Monitoring Clock
PS	Protection Switching
QoS	Quality of Service
RDI	Remote Defect Indication

RTC	Real-Time Clock
SA	Source Address
SES	Severely Errored Seconds
SL	Synthetic Loss
SLM	Synthetic Loss Message
SLNE	Server Layer Network Entity
SLR	Synthetic Loss Reply
TCM	Tandem Connection Monitoring
TF	Transmitted Frames
TMN	Telecommunications Management Network
TTP	Trail Termination Point
WTR	Wait To Restore

5 Conventions

In this Recommendation, ET.MN stands for ET management network, ET.MSN for ET management subnetwork, ET.NE for ET network element, ET.C for ET channel layer, ET.P for ET path layer, and ET.S for ET section layer.

6 ET management architecture

See clause 6 of [ITU-T G.7710] for the generic architecture for managing transport equipment. ET specific management architecture is described below.

6.1 ET network management architecture

The transport layer networks of Ethernet over transport are described in [ITU-T G.8010], [ITU-T G.8012] and [ITU-T G.8013]. The management of the ET layer networks is separable from that of its client layer networks so that the same means of management can be used regardless of the client.

6.1.1 Relationship between TMN, ET.MN and ET.MSN

The ET management network (ET.MN) may be partitioned into ET management subnetworks (ET.MSNs). The inter-relationship between a management network, its subnetworks and a telecommunications management network (TMN), as generically described in clause 6 of [ITU T-G.7710], is applicable to ET.

6.1.2 Access to the ET.MSN

See clause 6.1.2 of [ITU-T G.7710] for the generic requirements.

6.1.3 ET.MSN requirements

See clause 6.1.3 of [ITU-T G.7710] for the generic requirements.

Furthermore, all ET network elements (ET.NEs) must support management communication functions. The message communication function (MCF) of an ET.NE initiates/terminates (in the sense of the lower protocol layers), forwards, or otherwise processes management messages over management communication channels (MCCs), or over other data communication network (DCN) interfaces. In addition:

- All ET.NEs are required to terminate the ET.S-MCCs, see clause 6.1.4. In open systems interconnection (OSI) terms, this means that each network element (NE) must be able to perform the functions of an end system.
- ET.NEs may also be required to forward management messages between ports according to routing control information held in the ET.NE. In OSI terms, this means that some ET.NEs may be required to perform the functions of an intermediate system.
- In addition to supporting interfaces for the ET.S-MCC, an ET.NE may also be required to support other DCN interfaces, which may include ET.P-MCCs or ET.C-MCCs or an Ethernet DCN interface.

The use of the ET.P-MCCs and ET.C-MCCs for management communications is within the scope of this Recommendation, see clause 6.1.7.

6.1.4 ET.MSN data communication network

Refer to clause 6.1.4 of [ITU-T G.7710] for the generic requirements.

6.1.4.1 Management communication channel

The ET.MN supports three management communication channels (MCCs):

1. ET.S-MCC (MCC_S);
2. ET.P-MCC (MCC_P);
3. ET.C-MCC (MCC_C).

ET.S-, ET.P- and ET.C-MCCs are specified in [ITU-T G.8010].

Figure 6-1 illustrates a network scenario consisting of two operators. Operator B provides an ET path layer service to Operator A (i.e., Operator B transports the ET path layer signal that begins and ends Operator A's domain). According to [ITU-T G.8010], the MCC_P and the MCC_C signals passed transparently through Operator B's network.

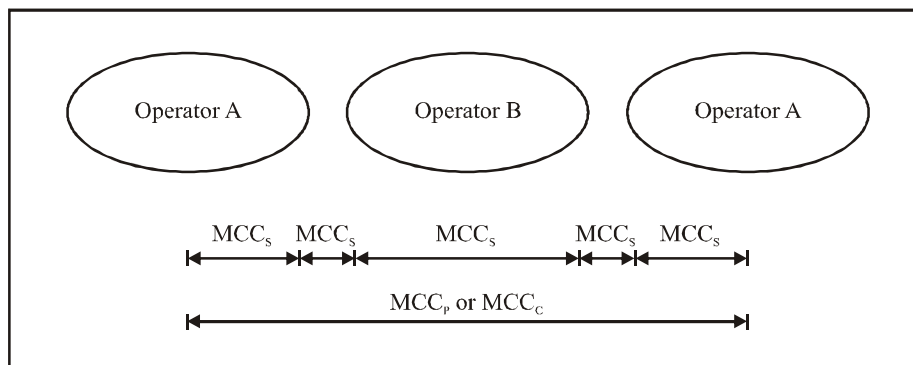

G.8051-Y.1345(07)_F6-1

Figure 6-1 – MCC scenarios

The physical layer is terminated in every network element, and its related adaptation function provides the ET section layer signals as well as the MCC_S . Hence, the MCC_S cannot cross administrative domains. Figures 6-1, 6-2 and 6-3 illustrate scenarios where the MCC_P is transported transparently through Operator B's domain (the Operator B network elements are not shown in Figures 6-2 and 6-3). In these scenarios, it is possible that Operator B may use the MCC_S within its own domain for the management of its domain.

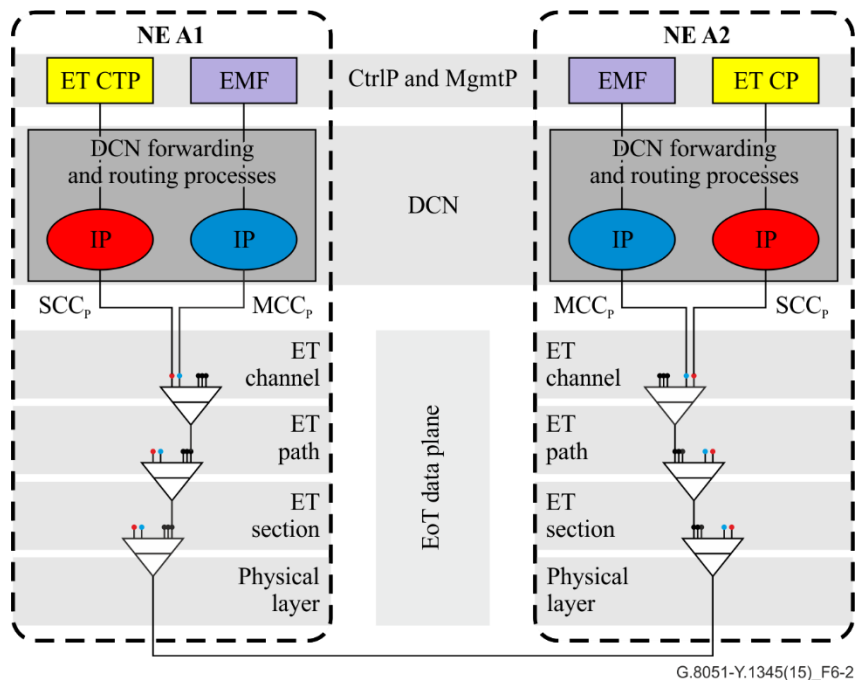

Figure 6-2 – MCC_P scenario example

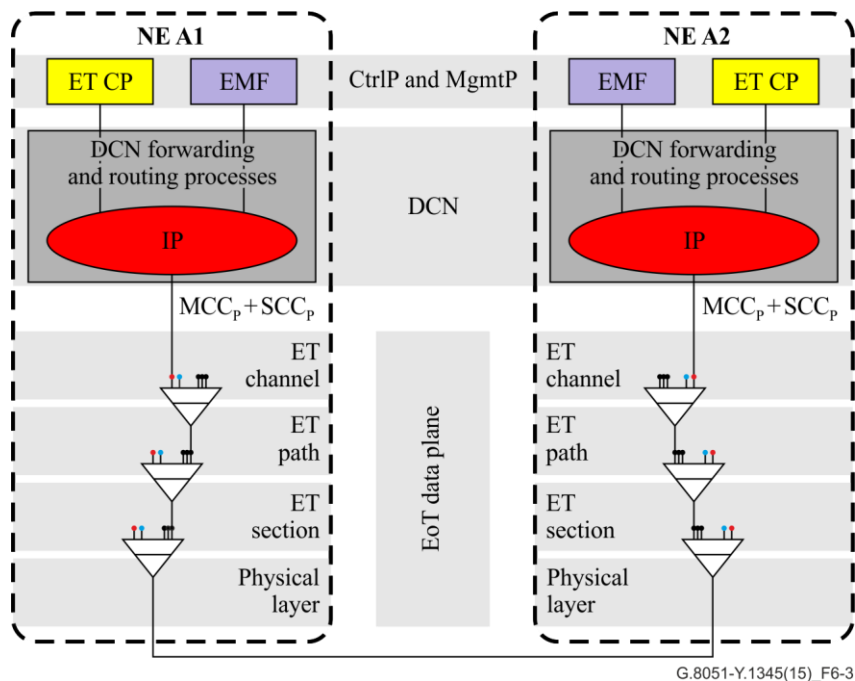

Figure 6-3 – MCC_P scenario example

6.1.4.2 MCC physical characteristics

The ET.S-, ET.C- and ET.P-MCCs are logical elements within the ET Transport Module (ETM-n). The MCC provides general management communications between two ET network elements with access to the ET.S, ET.P and ET.C characteristic information respectively. The ET.S-, ET.P-, or ET.C-MCC is provided by the ET operations, administration, maintenance (OAM) function at section, path or channel layer as defined in [ITU-T G.8013] or by any other embedded communication channel (ECC) of the ET transport network.

The ET.S MCCs shall operate as a single message channel between ET.S termination points. The bit rate of the MCCs shall be configurable.

The ET.P management communication channel (MCC_P) shall operate as a single message channel between any network elements that terminate the ET.P layer. The MCC_P is transported transparently through ET.NEs that only terminate the ET.S layer and forward the ET.P signal. The bit rate of the MCC_P shall be configurable.

The ET.C management communication channel (MCC_C) shall operate as a single message channel between any network elements that terminate the ET.C layer. The MCC_C is transported transparently through ET.NEs that only terminate the ET.S layer or the ET.S and ET.P layers and forward the ET.C signal. The bit rate of the MCC_C shall be configurable.

6.1.4.3 MCC data link layer protocol

The MCC data link protocols for management applications are under study for [ITU-T G.7712].

6.1.5 Management of DCN

See clause 6.1.5 of [ITU-T G.7710] for the generic requirements.

6.1.6 Remote log-in

See clause 6.1.6 of [ITU-T G.7710] for the generic requirements.

6.1.7 Relationship between technology domains

See clause 6.1.7 of [ITU-T G.7710] for the generic requirements.

6.2 ET equipment management function architecture

This clause provides an overview of the minimum functions, which are required to support inter-vendor/network communications and single-ended maintenance of ET NEs within an MSN, or between communicating peer ET NEs across a network interface. Single-ended maintenance is the ability to access remotely located ET NEs to perform maintenance functions (see the performance management applications, clause 10.1 of [ITU-T G.7710]).

It should be noted that the management functions have been categorized according to the classifications given in [ITU-T X.700].

Detailed specifications of the management functions, in terms of managed objects (MOs) classes, attributes and message specification, are for further study.

The ET equipment management function (EMF) (see Figure 6-4) provides the means through which the ET network element function (NEF) is managed by an internal or external manager. If a NE contains an internal manager, this manager will be part of the ET EMF.

The ET EMF interacts with the other atomic functions (AFs) (refer to [ITU-T G.8021]) by exchanging information across the MP reference points. See [ITU-T G.806] and [ITU-T G.8021] for more information on AFs and on management points (MP). The ET EMF contains a number of functions that provide a data reduction mechanism on the information received across the MP reference points. The outputs of these functions are available to the agent via the network element resources and management applications functions (MAF), which represent this information as managed objects.

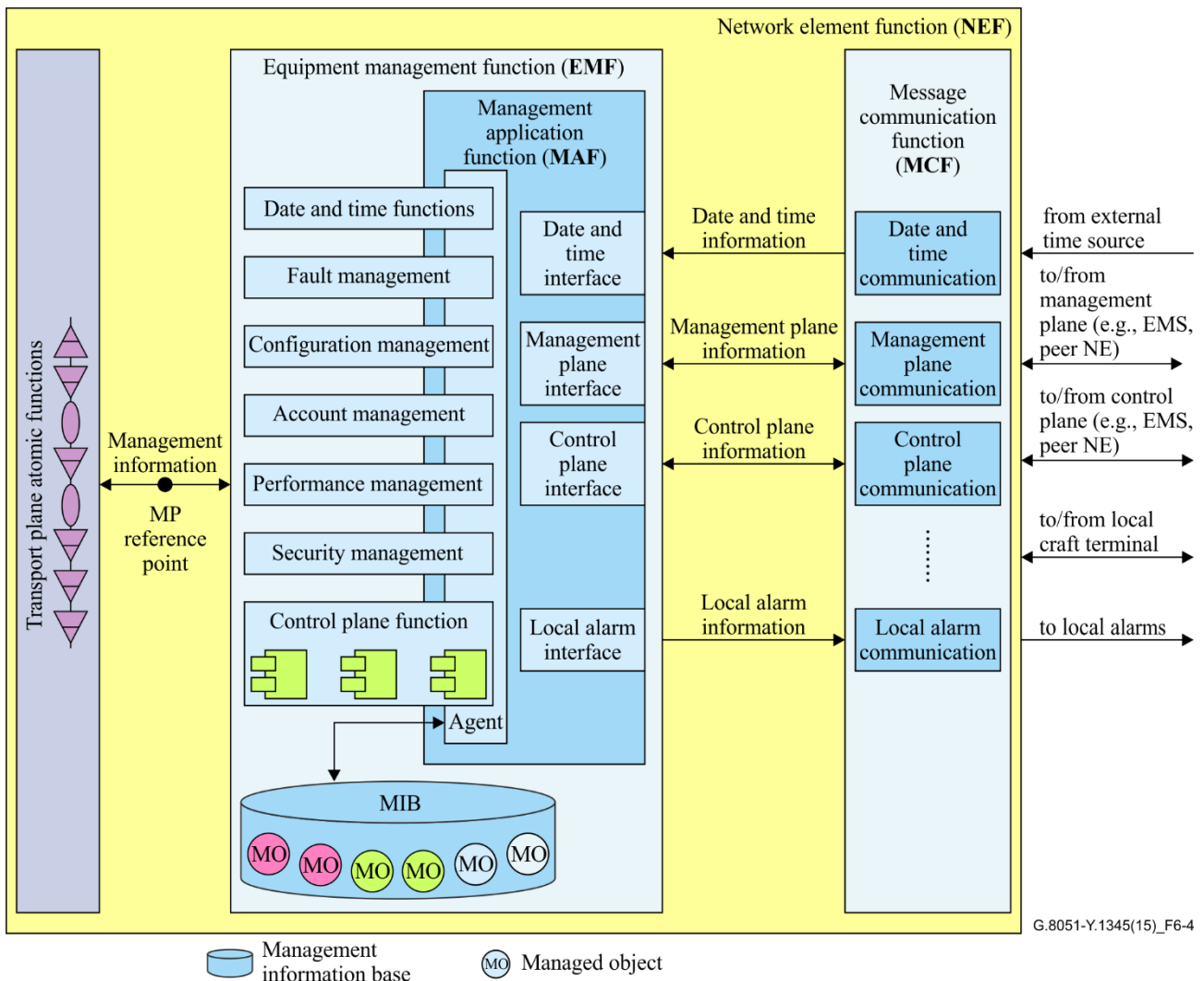

Figure 6-4 – ET equipment management function

Network element resources provide event processing and storage. The MAF processes the information provided to and by the NE resources. The agent converts this information to management messages and responds to management messages from the manager by performing the appropriate operations on the managed objects.

This information to and from the agent is passed across the V reference point to the MCF.

6.3 Information flows over management points

The information flows described in this clause are functional. The existence of these information flows in the equipment will depend on the functionality provided by the ET.NE and the options selected.

The information flow over the MP reference points that arises from anomalies and defects detected in the AFs is described in specific details for each AF in [ITU-T G.8021].

The information flow over the MP reference points that arises from provisioning and reporting data is described in specific details for each AF in [ITU-T G.8021]. The information listed under the Input column refers to the provisioning data that is passed from the ET EMF to the AFs. The information listed under the Output column refers to the reports passed to the ET EMF from the AFs.

7 Fault (maintenance) management

Fault management is a set of functions which enables the detection, isolation and correction of abnormal operation of the telecommunication network and its environment. It provides facilities for the performance of the maintenance phases from [ITU-T M.20]. The quality assurance measurements for fault management include component measurements for reliability, availability and survivability.

7.1 Fault management applications

See [ITU-T G.7710] for a description of the basic fault management applications.

7.1.1 Supervision

The supervision process describes the way in which the actual occurrence of a disturbance or fault is analysed with the purpose of providing an appropriate indication of performance and/or detected fault condition to maintenance personnel. The supervision philosophy is based on the concepts underlying the functional model of [ITU-T G.805], [ITU-T G.8010] and the alarm reporting function of [ITU-T X.733].

The five basic supervision categories are related to transmission, quality of service (QoS), processing, equipment and environment. These supervision processes are able to declare fault causes, which need further validation before the appropriate alarm is reported. See [ITU-T G.7710] for additional discussion of these categories.

The ET.NE shall indicate to the OS when a termination point is no longer able to supervise the signal (e.g., implementing equipment has a fault or loss of power).

7.1.1.1 Transmission supervision

See clause 7.1.1.1 of [ITU-T G.7710] for a general description of transmission supervision.

For ET NE, the following defects are monitored for the purpose of transmission supervision:

- Continuity supervision: Loss of continuity defect (dLOC[i])
Ethernet continuity check (CC) management jobs, using ITU-T G.8013/Y.1731 continuity check message (CCM), can be separately established (within a MEP) for fault management, performance management and protection switching.
As a default, one maintenance entity group (MEG) end point (MEP) (with MEG level (MEL) = 7, OAM message period = 1 second and priority = 7) has to be instantiated per trail termination point (TTP) for fault management (i.e., remote defect indication (RDI)).
- Connectivity supervision: Unexpected MEL defect (dUNL), MisMerge defect (dMMG) and unexpected MEP defect (dUNM).
- Signal quality supervision: Degraded signal defect (dDEG).
- Configuration supervision: Unexpected periodicity defect (dUNP) and unexpected priority defect (dUNPr).
- Maintenance signal supervision: Remote defect indicator defect (dRDI[]), alarm indication signal defect (dAIS) and locked defect (dLCK).

The AF associated failure conditions are listed in clause 7.2.1.

7.1.1.2 Quality of service supervision

See [ITU-T G.7710] for a description of QoS supervision.

7.1.1.3 Processing supervision

See [ITU-T G.7710] for a description of processing supervision.

7.1.1.4 Hardware supervision

See [ITU-T G.7710] for a description of equipment supervision.

7.1.1.5 Environment supervision

See [ITU-T G.7710] for a description of environment supervision.

7.1.2 Validation

See [ITU-T G.7710] for a description of fault cause validation.

7.1.3 Alarm handling

7.1.3.1 Severity assignment

See [ITU-T G.7710] for a description of severity categories.

7.1.3.2 Alarm reporting control

Alarm reporting control (ARC) provides an automatic in-service provisioning capability.

The following ARC states may be specified for a managed entity:

ALM	ALarM reporting; alarm reporting is turned on.
NALM	No ALarM reporting; alarm reporting is turned off.
NALM-CD	No ALarM reporting Countdown; this is a substate of NALM-QI and performs the persistence timing countdown function when the managed entity is qualified problem free.
NALM-NR	No ALarM reporting, NotReady; this is a substate of NALM-QI and performs a wait function until the managed entity is qualified problem free.
NALM-QI	No ALarM reporting, Qualified Inhibit; alarm reporting is turned off until the managed entity is qualified problem free for a specified persistence interval.
NALM-TI	No ALarM reporting, Timed Inhibit; alarm reporting is turned off for a specified timed interval.

Alarm reporting may be turned off (using NALM, NALM-TI or NALM-QI) on a per-managed entity basis to allow sufficient time for customer testing and other maintenance activities in an "alarm free" state. Once a managed entity is ready, alarm reporting is automatically turned on (to ALM). The managed entity may be automatically turned on either by using NALM-TI or NALM-QI and allowing the resource to transition out automatically, or by invoking first the NALM state from an EMS and when maintenance activity is done, invoking the ALM state. This latter automation is carried out by the EMS. For further details relating to ARC, see [ITU-T M.3100].

7.1.3.3 Reportable failures

See [ITU-T G.7710] for a description of reportable failures.

7.1.3.4 Alarm reporting

Alarm surveillance is concerned with the detection and reporting of relevant events and conditions which occur in the network. In a network, events and conditions detected within the equipment and incoming signals should be reportable. In addition, a number of events external to the equipment should also be reportable. Alarms are indications that are automatically generated by an NE as a result of the declaration of a failure. The OS shall have the ability to define which events and conditions generate autonomous reports, and which shall be reported on request.

The following alarm-related functions shall be supported:

1. autonomous reporting of alarms;

2. request for reporting of all alarms;
3. reporting of all alarms;
4. allow or inhibit of autonomous alarm reporting;
5. reporting on request status of allow or inhibit alarm reporting;
6. reporting of protection switch events.

7.1.3.4.1 Local reporting

See [ITU-T G.7710] for a description of local reporting.

7.1.3.4.2 TMN reporting

See [ITU-T G.7710] for a description of TMN reporting.

7.2 Fault management functions

Figure 7-1 contains the functional model of fault management inside the ET EMF. This model is consistent with the alarm flow functional model, specified in [ITU-T M.3100]. It must be noted that it does not address configuration aspects relating to fault management, the full ARC functional model, nor does it define where all possible event report parameters get assigned. Figure 7-1 is intended only to illustrate which well-known functions are impacted by ARC, and which are not, and to provide a generalized alarm flow view.

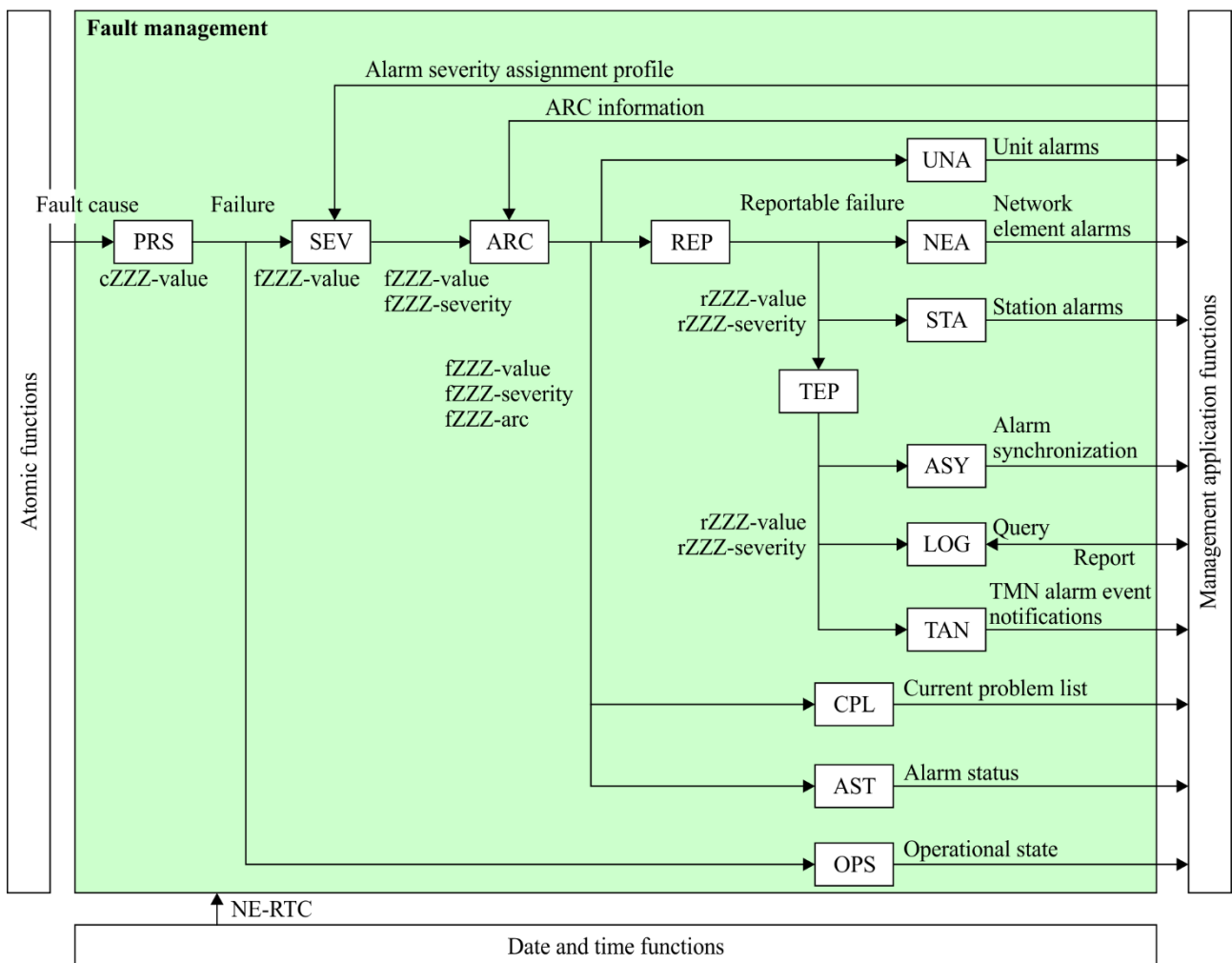

G.8051-Y.1345(15)_F7-1

Figure 7-1 – Fault management within the ET EMF

7.2.1 Fault cause persistency function – PRS

The defect correlations provide a data reduction mechanism on the fault and performance monitoring primitives' information presented at the MP reference points.

The EMF within the network element performs a persistency check on the fault causes (that are reported across the MP reference points) before it declares a fault cause a failure. In addition to the transmission failures, hardware failures with signal transfer interruption are also reported at the input of the fault cause function for further processing. See Figure 7-2.

Symbol

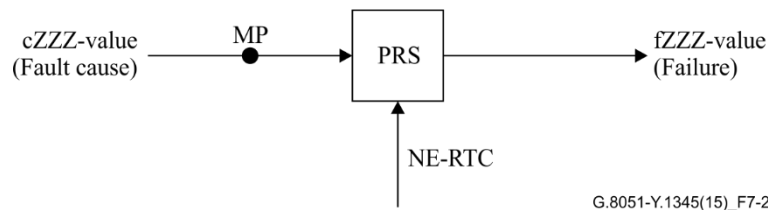

Figure 7-2 – Fault cause persistency function

For an ET.NE that supports the AFs listed in Table 7-1, the EMF PRS process shall support the persistency check for the associated fault causes.

Inputs and outputs

Table 7-1 – Inputs/outputs for the fault cause persistency function

Atomic function (see [ITU-T G.8021])	Input	Output
ETH_C per Ring protection process	cFOP-PM	fFOP-PM
ETH_C per Ring port process	cFOP-TO	fFOP-TO
ETHx_FT_Sk	cSSF cLCK cLOC[i] cMMG cUNM cUNP cUNPri cUNL cDEG cRDI	fSSF fLCK fLOC[i] fMMG fUNM fUNP fUNPri fUNL fDEG fRDI
ETHG_FT_Sk	cLOC[i] cUNL cMMG cUNM cDEG cUNP cUNPr cRDI cSSF cLCK	fLOC[i] fUNL fMMG fUNM fDEG fUNP fUNPr fRDI fSSF fLCK
ETHx/ETH_A_Sk	cCSF	fCSF
ETHx/ETH-m_A_Sk	cCSF	fCSF

Table 7-1 – Inputs/outputs for the fault cause persistency function

Atomic function (see [ITU-T G.8021])	Input	Output
ETHG/ETH_A_Sk	cCSF	fCSF
ETYn-Np/ETH-LAG-Na_A_Sk	cPLL[1..Na] cTLL[1..Na]	fPLL[1..Na] fTLL[1..Na]
ETH-LAG_FT_Sk	cSSF	fSSF
ETYn_TT_Sk	cLOS cRDI cFDI	fLOS fRDI fFDI
Sn/ETH_A_Sk	cPLM cLFD cUPM cEXM cCSF	fPLM fLFD fUPM fEXM fCSF
Sn-X-L/ETH_A_Sk	cPLM cLFD cUPM cEXM cCSF	fPLM fLFD fUPM fEXM fCSF
Sm/ETH_A_Sk	cPLM cLFD cUPM cEXM cCSF	fPLM fLFD fUPM fEXM fCSF
Sm-X-L/ETH_A_Sk	cPLM cLFD cUPM cEXM cCSF	fPLM fLFD fUPM fEXM fCSF
Sn-X/ETC3_A_Sk	cPLM cLFD cUPM cEXM cCSF	fPLM fLFD fUPM fEXM fCSF
Pq/ETH_A_Sk	cPLM cLFD cUPM cEXM cCSF	fPLM fLFD fUPM fEXM fCSF
Pq-X-L/ETH_A_Sk	cPLM cLFD cUPM cEXM cCSF	fPLM fLFD fUPM fEXM fCSF
ODUKP/ETH_A_Sk	cPLM cLFD cUPM cEXM cCSF	fPLM fLFD fUPM fEXM fCSF

Table 7-1 – Inputs/outputs for the fault cause persistency function

Atomic function (see [ITU-T G.8021])	Input	Output
ODUKP-X-L/ETH-A-Sk	eVePLM eLFD eUPM eEXM eCSF	fVePLM fLFD fUPM fEXM fCSF
ODU2P/ETHPP-OS_A_Sk	cPLM cLFD cUPM cEXM cCSF	fPLM fLFD fUPM fEXM fCSF

Process

The EMF within the network element performs a persistency check on the fault causes before it declares a fault cause a failure.

A transmission failure (fXXX) shall be declared if the fault cause persists continuously for 2.5 ± 0.5 s. The failure shall be cleared if the fault cause is absent continuously for 10 ± 0.5 s.

The specific set of failures associated with each AF is listed in Table 7-1.

The failure declaration and clearing shall be time-stamped. The time-stamp shall indicate the time at which the fault cause is activated at the input of the fault cause persistency (i.e., defect-to-failure integration) function, and the time at which the fault cause is deactivated at the input of the fault cause persistency function.

7.2.2 Severity assignment function – SEV

See [ITU-T G.7710] for a description of the severity assignment function.

7.2.3 Alarm reporting control function – ARC

The ARC function allows a management system to control the alarm reporting on a managed entity basis as defined in [ITU-T M.3100].

The alarms that can be controlled with this function are defined for each AF in [ITU-T G.8021].

The ARC states that may be specified for a managed entity are defined in clause 7.1.3.2. For ET.NE:

- The ALM state is required for all managed entities that can detect alarms;
- In addition, at least one of the states: NALM, NALM-TI or NALM-QI must be supported;
- If NALM-QI is supported, then NALM-NR is required and NALM-CD is optional.

In Table 7-2 below, for each managed entity a subset of the plausible failures (defined in Table 7-1) are selected as qualified problems. These qualified problems are recommended as they are deemed essential to the operability of the subject managed entity. Note that for each managed entity, one or more of the qualified problems could then be further selected by the management system to be included in the ARC list (see clause 7.2.3 of [ITU-T G.7710]) for controlling the reporting of alarm for the entity. When an entity is put in the ARC state of NALM-QI, alarm reporting for the entity is turned off until the managed entity is free of all the failures specified in the ARC list.

Default ARC state is also specified for each managed entity. If the ARC function is supported by the ET.NE and an ARC state is not explicitly provisioned from the management system for the managed entity, then the default ARC specified in Table 7-2 should be in effect.

For an ET.NE that supports the AFs listed in Table 7-2, the EMF ARC process shall support alarm reporting control for the associated fault causes

Table 7-2 – ARC specifications for ET

Atomic function	Qualified problems	QoS reporting	Default state value
ETH_C per Ring protection process	fFOP-PM	FFS	ALM
ETH_C per Ring port process	fFOP-TO	FFS	ALM
ETHx_FT_Sk	fSSF fLCK fLOC[i] fMMG fUNM fUNP fUNPri fUNL fDEG fRDI	For further study (FFS)	ALM
ETHG_FT_Sk	fLOC[i] fUNL fMMG fUNM fDEG fUNP fUNPr fRDI fSSF fLCK	FFS	ALM
ETHx/ETH_A_Sk	fCSF	FFS	ALM
ETHx/ETH-m_A_Sk	fCSF	FFS	ALM
ETHG/ETH_A_Sk	fCSF	FFS	ALM
ETYn-Np/ETH-LAG-Na_A_Sk	fPLL[1..Na] fTLL[1..Na]	FFS	ALM
ETH-LAG_FT_Sk	fSSF	FFS	ALM
ETYn_TT_Sk	fLOS fRDI fFDI	FFS	ALM
Sn/ETH_A_Sk	fPLM fLFD fUPM fEXM fCSF	FFS	ALM
Sn-X-L/ETH_A_Sk	fPLM fLFD fUPM fEXM fCSF	FFS	ALM

Table 7-2 – ARC specifications for ET

Atomic function	Qualified problems	QoS reporting	Default state value
Sm/ETH_A_Sk	fPLM fLFD fUPM fEXM fCSF	FFS	ALM
Sm-X-L/ETH_A_Sk	fPLM fLFD fUPM fEXM fCSF	FFS	ALM
Sn-X/ETC3_A_Sk	fPLM fLFD fUPM fEXM fCSF	FFS	ALM
Pq/ETH_A_Sk	fPLM fLFD fUPM fEXM fCSF	FFS	ALM
Pq-X-L/ETH_A_Sk	fPLM fLFD fUPM fEXM fCSF	FFS	ALM
ODUKP/ETH_A_Sk	fPLM fLFD fUPM fEXM fCSF	FFS	ALM
ODUKP-X-L/ETH_A_Sk	fPLM fLFD fUPM fEXM fCSF	FFS	ALM
ODU2P/ETHPP-OS_A_Sk	fPLM fLFD fUPM fEXM fCSF	FFS	ALM

7.2.4 Reportable failure function – REP

See [ITU-T G.7710] for a description of the reportable failure function.

7.2.5 Unit alarms function – UNA

See [ITU-T G.7710] for a description of the unit alarms function.

7.2.6 Network element alarms function – NEA

See [ITU-T G.7710] for a description of the network element alarms function.

7.2.7 Station alarms function – STA

See [ITU-T G.7710] for a description of the station alarms function.

7.2.8 TMN event pre-processing function – TEP

See [ITU-T G.7710] for a description of the TMN event pre-processing alarm function.

7.2.9 Alarm synchronization function – ASY

See [ITU-T G.7710] for a description of the alarm synchronization function.

7.2.10 Logging function – LOG

Alarm history management is concerned with the recording of alarms. Historical data shall be stored in registers in the NE. Each register contains all the parameters of an alarm message.

Registers shall be readable on demand or periodically. The OS can define the operating mode of the registers as wrapping or stop when full. The OS may also flush the registers or stop recording at any time.

NOTE – Wrapping is the deletion of the earliest record to allow a new record when a register is full. Flushing is the removal of all records in the register. See [ITU-T X.735] for additional details.

See [ITU-T G.7710] for a description of the logging function.

7.2.11 TMN alarm event notifications function – TAN

See [ITU-T G.7710] for a description of the TMN alarm event notifications function.

7.2.12 Current problem list function – CPL

See [ITU-T G.7710] for a description of the current problem list function.

7.2.13 Alarm status function – AST

See [ITU-T G.7710] for a description of the alarm status function.

7.2.14 Operational state function – OPS

See [ITU-T G.7710] for a description of the operational state function.

Table 7-3 lists the failures that could influence the operational state of the related objects.

For an ET.NE that supports the AFs listed in Table 7-3, the EMF OPS process shall support operational state for the associated fault causes.

Table 7-3 – Operational state function input and output signals for Ethernet

Atomic function	Failure input (fZZZ value)	Operational state output (Enabled/Disabled) of the trail object
ETH_C per Ring protection process	fFOP-PM	Enabled
ETH_C per Ring port process	fFOP-TO	Enabled

Table 7-3 – Operational state function input and output signals for Ethernet

Atomic function	Failure input (fZZZ value)	Operational state output (Enabled/Disabled) of the trail object
ETHx_FT_Sk	fSSF fLOC[i] fMMG fUNM fUNP fUNPri fUNL fRDI	Enabled Enabled Enabled Enabled Enabled Enabled Enabled Enabled
ETHG_FT_Sk	fLOC[i] fUNL fMMG fUNM fDEG fUNP fUNPr fRDI fSSF fLCK	Enabled Enabled Enabled Enabled Enabled Enabled Enabled Enabled Enabled Enabled
ETHx/ETH_A_Sk	fCSF	Enabled
ETHx/ETH-m_A_Sk	fCSF	Enabled
ETHG/ETH_A_Sk	fCSF	Enabled
ETYn-Np/ETH-LAG-Na_A_Sk	fPLL[1..Na] fTLL[1..Na]	Enabled Enabled
ETH-LAG_FT_Sk	fSSF	Enabled
ETYn_TT_Sk	fLOS fRDI fFDI	Disabled Enabled Enabled
Sn/ETH_A_Sk	fPLM fLFD fUPM fEXM fCSF	Enabled Enabled Enabled Enabled Enabled
Sn-X-L/ETH_A_Sk	fPLM fLFD fUPM fEXM fCSF	Enabled Enabled Enabled Enabled Enabled
Sm/ETH_A_Sk	fPLM fLFD fUPM fEXM fCSF	Enabled Enabled Enabled Enabled Enabled

Table 7-3 – Operational state function input and output signals for Ethernet

Atomic function	Failure input (fZZZ value)	Operational state output (Enabled/Disabled) of the trail object
Sm-X-L/ETH_A_Sk	fPLM fLFD fUPM fEXM fCSF	Enabled Enabled Enabled Enabled Enabled
Sn-X/ETC3_A_Sk	fPLM fLFD fUPM fEXM fCSF	Enabled Enabled Enabled Enabled Enabled
Pq/ETH_A_Sk	fPLM fLFD fUPM fEXM fCSF	Enabled Enabled Enabled Enabled Enabled
Pq-X-L/ETH_A_Sk	fPLM fLFD fUPM fEXM fCSF	Enabled Enabled Enabled Enabled Enabled
ODUKP/ETH_A_Sk	fPLM fLFD fUPM fEXM fCSF	Enabled Enabled Enabled Enabled Enabled
ODUKP-X-L/ETH_A_Sk	fPLM fLFD fUPM fEXM fCSF	Enabled Enabled Enabled Enabled Enabled
ODU2P/ETHPP-OS_A_Sk	fPLM fLFD fUPM fEXM fCSF	Enabled Enabled Enabled Enabled Enabled

7.2.15 External events

For further study.

8 Configuration management

See [ITU-T G.7710] for the generic requirements for configuration management. ET specific specifications, if needed, are explicitly described.

8.1 Hardware

See [ITU-T G.7710] for a description of hardware management.

8.2 Software

See [ITU-T G.7710] for a description of software management.

8.3 Protection switching

~~For further study.~~

~~See [ITU-T G.7710] for a description of protection switching.~~

~~This function allows a user to provision and monitor the operation of protection processes deployed in an ETH Connection function.~~

~~MI signals concerning the protection processes are listed in Table 8-4 and communicated between the EMF and the protection process through the management point. According to these MI signals, the EMF generates a corresponding event notification and state report signals to the MAF.~~

~~For the protection processes supported by an ET.NE, the ET.NE EMF shall support the following management functions:~~

- ~~– Provisioning the protection switching management information~~
- ~~– Retrieving the protection switching management information~~
- ~~– Notifying the changes of the protection switching management information~~
- ~~– Receiving the monitored protection switching management information~~

8.4 Trail termination

See [ITU-T G.7710] for a description of trail termination management.

This function allows a user to provision and monitor the operation of the Ethernet PHY trail termination process.

The MI signals listed in Table 8-1 are communicated between the EMF and the PHY trail termination process across the management point within the ET NE.

For the trail termination functions supported by an ET.NE, the ET.NE EMF shall support the following management functions:

- Provisioning the trail termination management information;
- Retrieving the trail termination management information;
- Notifying the changes of the trail termination management information;
- Receiving the monitored trail termination management information.

Table 8-1 – Provisioning and reporting for PHY trail termination functions

MI signal	Value range	Default value
Provisioning		
ETYn_TT_So_MI_FTSEnable	true, false	false
Reporting		
ETYn_TT_So_MI_PHYType	See IEEE 802.3 clause 30.3.2.1.2	–
ETYn_TT_So_MI_PHYTypeList	See IEEE 802.3 clause 30.3.2.1.3	–
NOTE – According to [ITU-T G.8021].		

8.5 Flow termination

This function allows a user to provision and monitor the operation of the ETHx and ETH-LAG flow termination processes.

The MI signals listed in Table 8-2 are communicated between the EMF and the flow termination processes across the management point within the ET NE.

For the flow termination functions supported by an ET.NE, the ET.NE EMF shall support the following management functions:

- Provisioning the trail termination management information;
- Retrieving the trail termination management information;
- Notifying the changes of the trail termination management information;
- Receiving the monitored trail termination management information.

Table 8-2 – Provisioning and reporting for flow termination functions

MI signal	Value range	Default value
Provisioning		
ETHx_FT_So_MI_MEL	0, 1, 2, 3, 4, 5, 6, 7	By agreement
ETHx_FT_So_MI_MEP_MAC	Per [ITU-T G.8021]	–
ETHx_FT_So_MI_CC_Enable	true, false	false
ETHx_FT_So_MI_LMC_Enable	true, false	true
ETHx_FT_So_MI_MEG_ID	See Annex A of [ITU-T G.8013]	–
ETHx_FT_So_MI_MEP_ID	0..8191; see Figure 9.2-3 of [ITU-T G.8013]	–
ETHx_FT_So_MI_CC_Period	3.33 ms, 10 ms, 100 ms, 1 s, 10 s, 1 min, 10 min	1 s
ETHx_FT_So_MI_CC_Pri	0, 1, 2, 3, 4, 5, 6, 7	7
ETHx_FT_So_MI_LML_Enable[1...M _{LM}]	true, false	true
ETHx_FT_So_MI_LM_MAC_DA[1...M _{LM}]	Per [ITU-T G.8021]	–
ETHx_FT_So_MI_LM_Period[1...M _{LM}]	100 ms, 1 s, 10 s	100 ms
ETHx_FT_So_MI_LM_Pri[1...M _{LM}]	0, 1, 2, 3, 4, 5, 6, 7	7
ETHx_FT_So_MI_DM_Enable[1...M _{DM}]	true, false	false
ETHx_FT_So_MI_DM_MAC_DA[1...M _{DM}]	Per [ITU-T G.8021]	–
ETHx_FT_So_MI_DM_Test_ID[1...M _{DM}]	Non-negative integer (optional)	–
ETHx_FT_So_MI_DM_Length[1...M _{DM}]	Non-negative integer representing number of byte for the length of the padding TLV. Note that the total frame size of the DM protocol data unit (PDU) should be between 64 and 9216 bytes.	0
ETHx_FT_So_MI_DM_Period[1...M _{DM}]	100 ms, 1 s, 10 s	100 ms
ETHx_FT_So_MI_DM_Pri[1...M _{DM}]	0, 1, 2, 3, 4, 5, 6, 7	7
ETHx_FT_So_MI_1DM_Enable[1...M _{IDM}]	true, false	false
ETHx_FT_So_MI_1DM_MAC_DA[1...M _{IDM}]	Per [ITU-T G.8021]	–
ETHx_FT_So_MI_1DM_Test_ID[1...M _{IDM}]	Non-negative integer (optional)	–

Table 8-2 – Provisioning and reporting for flow termination functions

MI signal	Value range	Default value
ETHx_FT_So_MI_1DM_Length[1...M _{1DM}]	Non-negative integer representing number of byte for the length of the padding TLV. Note that the total fame size of the DM PDU should be between 64 and 9216 bytes.	0
ETHx_FT_So_MI_1DM_Period[1...M _{1DM}]	100 ms, 1 s, 10 s	100 ms
ETHx_FT_So_MI_1DM_Pri[1...M _{1DM}]	0, 1, 2, 3, 4, 5, 6, 7	7
ETHx_FT_So_MI_SL_Enable[1...M _{SL}]	true, false	false
ETHx_FT_So_MI_SL_MAC_DA[1...M _{SL}]	Per [ITU-T G.8021]	–
ETHx_FT_So_MI_SL_Test_ID[1...M _{SL}]	Non-negative integer (optional)	–
ETHx_FT_So_MI_SL_Length[1...M _{SL}]	Non-negative integer representing number of byte for the length of the padding TLV. Note that the total fame size of the DM PDU should be between 64 and 9216 bytes.	0
ETHx_FT_So_MI_SL_Period[1...M _{SL}]	10 ms, 100 ms, 1 s, 10 s	100 ms
ETHx_FT_So_MI_SL_Pri[1...M _{SL}]	0, 1, 2, 3, 4, 5, 6, 7	7
ETHx_FT_So_MI_1SL_Enable[1...M _{1SL}]	true, false	false
ETHx_FT_So_MI_1SL_MAC_DA[1...M _{1SL}]	Per [ITU-T G.8021]	–
ETHx_FT_So_MI_1SL_Test_ID[1...M _{1SL}]	Non-negative integer (optional)	–
ETHx_FT_So_MI_1SL_Length[1...M _{1SL}]	Non-negative integer representing number of byte for the length of the padding TLV. Note that the total fame size of the DM PDU should be between 64 and 9216 bytes.	0
ETHx_FT_So_MI_1SL_Period[1...M _{1SL}]	10 ms, 100 ms, 1 s, 10 s	100 ms
ETHx_FT_So_MI_1SL_Pri[1...M _{1SL}]	0, 1, 2, 3, 4, 5, 6, 7	7
ETHx_FT_Sk_MI_CC_Enable	true, false	false
ETHx_FT_Sk_MI_LMC_Enable	true, false	true
ETHx_FT_Sk_MI_1second	–	–
ETHx_FT_Sk_MI_LM_DEGM	2-10; see Table 7-1 of [ITU-T G.806]	10
ETHx_FT_Sk_MI_LM_M	2-10	10
ETHx_FT_Sk_MI_LM_DEGTHR	0% .. 100%; see Table 7-1 of [ITU-T G.806]	30%
ETHx_FT_Sk_MI_LM_TFMIN	FFS	FFS
ETHx_FT_Sk_MI_MEL	0, 1, 2, 3, 4, 5, 6, 7	By agreement
ETHx_FT_Sk_MI_MEG_ID	See Annex A of [ITU-T G.8013]	–
ETHx_FT_Sk_MI_PeerMEP_ID[i]	List of peer MEP IDs; 0..8191 for each ID; see Figure 9.2-3 of [ITU-T G.8013]	–

Table 8-2 – Provisioning and reporting for flow termination functions

MI signal	Value range	Default value
ETHx_FT_Sk_MI_CC_Period	3.33 ms, 10 ms, 100 ms, 1 s, 10 s, 1 min, 10 min	1 s
ETHx_FT_Sk_MI_CC_Pri	0..7	7
ETHx_FT_Sk_MI_GetSvdCCM	(NOTE – Use to request the saved latest CCM frame that caused a defect to be raised.)	–
ETHx_FT_Sk_MI_1DM_Enable[1...M _{1DM}]	true, false	false
ETHx_FT_Sk_MI_1DM_MAC_SA[1...M _{1DM}]	Per [ITU-T G.8021]	–
ETHx_FT_Sk_MI_1DM_Pri[1...M _{1DM}]	0..7	7
ETHx_FT_Sk_MI_1DM_Test_ID[1...M _{1DM}]	Non-negative integer (optional)	–
ETHx_FT_Sk_MI_1SL_Enable[1...M _{1SL}]	true, false	false
ETHx_FT_Sk_MI_1SL_MAC_SA[1...M _{1SL}]	Per [ITU-T G.8021]	–
ETHx_FT_Sk_MI_1SL_Test_ID[1...M _{1SL}]	Non-negative integer (optional)	–
ETHx_FT_Sk_MI_MEP_MAC	Per [ITU-T G.8021]	–
Reporting		
ETHx_FT_Sk_MI_SvdCCM	Last received CCM frame that caused defect	–
ETHx_FT_Sk_MI_BW_Report(SA, PortID, NominalBW, CurrentBW)	Per configured at peer source	–
Provisioning		
ETHG_FT_So_MI_MEL	0, 1, 2, 3, 4, 5, 6, 7	By agreement
ETHG_FT_So_MI_MEP_MAC	Per [ITU-T G.8021]	–
ETHG_FT_So_MI_CC_Enable	true, false	false
ETHG_FT_So_MI_LMC_Enable	true, false	true
ETHG_FT_So_MI_MEG_ID	See Annex A of [ITU-T G.8013]	–
ETHG_FT_So_MI_MEP_ID	0..8191; see Figure 9.2-3 of [ITU-T G.8013]	–
ETHG_FT_So_MI_CC_Period	3.33 ms, 10 ms, 100 ms, 1 s, 10 s, 1 min, 10 min	1 s
ETHG_FT_So_MI_CC_Pri	0, 1, 2, 3, 4, 5, 6, 7	7
ETHG_FT_So_MI_LML_Enable[1...M _{LM}]	true, false	true
ETHG_FT_So_MI_LM_MAC_DA[1...M _{LM}]	Per [ITU-T G.8021]	–
ETHG_FT_So_MI_LM_Period[1...M _{LM}]	100 ms, 1 s, 10 s	100 ms
ETHG_FT_So_MI_LM_Pri[1...M _{LM}]	0, 1, 2, 3, 4, 5, 6, 7	7
ETHG_FT_So_MI_DM_Enable[1...M _{DM}]	true, false	false
ETHG_FT_So_MI_DM_MAC_DA[1...M _{DM}]	Per [ITU-T G.8021]	–
ETHG_FT_So_MI_DM_Test_ID[1...M _{DM}]	Non-negative integer (optional)	–

Table 8-2 – Provisioning and reporting for flow termination functions

MI signal	Value range	Default value
ETHG_FT_So_MI_DM_Length[1...M _{DM}]	Non-negative integer representing number of byte for the length of the padding TLV. Note that the total fame size of the DM PDU should be between 64 and 9216 bytes.	0
ETHG_FT_So_MI_DM_Period[1...M _{DM}]	100 ms, 1 s, 10 s	100 ms
ETHG_FT_So_MI_DM_Pri[1...M _{DM}]	0, 1, 2, 3, 4, 5, 6, 7	7
ETHG_FT_So_MI_1DM_Enable[1...M _{1DM}]	true, false	false
ETHG_FT_So_MI_1DM_MAC_DA[1...M _{1DM}]	Per [ITU-T G.8021]	–
ETHG_FT_So_MI_1DM_Test_ID[1...M _{1DM}]	Non-negative integer (optional)	–
ETHG_FT_So_MI_1DM_Length[1...M _{1DM}]	Non-negative integer representing number of byte for the length of the padding TLV. Note that the total fame size of the DM PDU should be between 64 and 9216 bytes.	0
ETHG_FT_So_MI_1DM_Period[1...M _{1DM}]	100 ms, 1 s, 10 s	100 ms
ETHG_FT_So_MI_1DM_Pri[1...M _{1DM}]	0, 1, 2, 3, 4, 5, 6, 7	7
ETHG_FT_So_MI_SL_Enable[1...M _{SL}]	true, false	false
ETHG_FT_So_MI_SL_MAC_DA[1...M _{SL}]	Per [ITU-T G.8021]	–
ETHG_FT_So_MI_SL_Test_ID[1...M _{SL}]	Non-negative integer (optional)	–
ETHG_FT_So_MI_SL_Length[1...M _{SL}]	Non-negative integer representing number of byte for the length of the padding TLV. Note that the total fame size of the DM PDU should be between 64 and 9216 bytes.	0
ETHG_FT_So_MI_SL_Period[1...M _{SL}]	10 ms, 100 ms, 1 s, 10 s	100 ms
ETHG_FT_So_MI_SL_Pri[1...M _{SL}]	0, 1, 2, 3, 4, 5, 6, 7	7
ETHG_FT_So_MI_1SL_Enable[1...M _{1SL}]	true, false	false
ETHG_FT_So_MI_1SL_MAC_DA[1...M _{1SL}]	Per [ITU-T G.8021]	–
ETHG_FT_So_MI_1SL_Test_ID[1...M _{1SL}]	Non-negative integer (optional)	–
ETHG_FT_So_MI_1SL_Length[1...M _{1SL}]	Non-negative integer representing number of byte for the length of the padding TLV. Note that the total fame size of the DM PDU should be between 64 and 9216 bytes.	0
ETHG_FT_So_MI_1SL_Period[1...M _{1SL}]	10 ms, 100 ms, 1 s, 10 s	100 ms
ETHG_FT_So_MI_1SL_Pri[1...M _{1SL}]	0, 1, 2, 3, 4, 5, 6, 7	7
Provisioning		
ETHG_FT_Sk_MI_CC_Enable	true, false	false
ETHG_FT_Sk_MI_LMC_Enable	true, false	true
ETHG_FT_Sk_MI_1Second	–	–
ETHG_FT_Sk_MI_LM_DEGM	2-10; see Table 7-1 of [ITU-T G.806]	10

Table 8-2 – Provisioning and reporting for flow termination functions

MI signal	Value range	Default value
ETHG_FT_Sk_MI_LM_M	2-10	10
ETHG_FT_Sk_MI_LM_DEGTHR	0% .. 100%; see Table 7-1 of [ITU-T G.806]	30%
ETHG_FT_Sk_MI_LM_TFMIN	FFS	FFS
ETHG_FT_Sk_MI_MEL	0, 1, 2, 3, 4, 5, 6, 7	By agreement
ETHG_FT_Sk_MI_MEG_ID	See Annex A of [ITU-T G.8013]	–
ETHG_FT_Sk_MI_PeerMEP_ID[i]	List of peer MEP IDs; 0..8191 for each ID; see Figure 9.2-3 of [ITU-T G.8013]	–
ETHG_FT_Sk_MI_CC_Period	3.33 ms, 10 ms, 100 ms, 1 s, 10 s, 1 min, 10 min	1 s
ETHG_FT_Sk_MI_CC_Pri	0..7	7
ETHG_FT_Sk_MI_GetSvdCCM	(NOTE – Use to request the saved latest CCM frame that caused a defect to be raised.)	–
ETHG_FT_Sk_MI_IDM_Enable[1...M _{IDM}]	true, false	false
ETHG_FT_Sk_MI_IDM_MAC_SA[1...M _{IDM}]	Per [ITU-T G.8021]	–
ETHG_FT_Sk_MI_IDM_Pri [1...M _{IDM}]	0..7	7
ETHG_FT_Sk_MI_IDM_Test_ID[1...M _{IDM}]	Non-negative integer (optional)	–
ETHG_FT_Sk_MI_1SL_Enable[1...M _{1SL}]	true, false	false
ETHG_FT_Sk_MI_1SL_MAC_SA[1...M _{1SL}]	Per [ITU-T G.8021]	–
ETHG_FT_Sk_MI_1SL_Test_ID[1...M _{1SL}]	Non-negative integer (optional)	–
ETHG_FT_Sk_MI_MEP_MAC	Per [ITU-T G.8021]	–
Reporting		
ETHG_FT_Sk_MI_SvdCCM	Last received CCM frame that caused defect	–
ETHG_FT_Sk_MI_BW_Report(SA, PortID, NominalBW, CurrentBW)	Per configured at peer source	--
Provisioning		
ETH-LAG_FT_Sk_MI_SSF_Reported	true, false	true

8.6 Adaptation

See clause 8.5 of [ITU-T G.7710] for a description of adaptation management.

An Access Point that has multiple adaptation functions connected to it, thereby allowing different clients to be transported via the server signal, requires a mechanism for the selection of the active client.

This function allows a user to provision and monitor the operation of the ET adaptation processes.

The MI signals listed in Table 8-3 are communicated between the EMF and the adaptation processes across the management point within the ET NE.

For the adaptation functions supported by an ET.NE, the ET.NE EMF shall support the following management functions:

- Provisioning the adaptation management information;
- Retrieving the adaptation management information;
- Notifying the changes of the adaptation management information.

Table 8-3 – Provisioning and reporting for adaptation functions

MI signal	Value range	Default value
ETHx/ETH_A_So Provisioning		
ETHx/ETH_A_So_MI_Active	true, false	true
ETHx/ETH_A_So_MI_MEP_MAC	6 byte Unicast MAC address	–
ETHx/ETH_A_So_MI_Client_MEL	0..7	–
ETHx/ETH_A_So_MI_LCK_Period	1 s, 1 min	1 s
ETHx/ETH_A_So_MI_LCK_Pri	0..7	7
ETHx/ETH_A_So_MI_Admin_State	LCK, Normal	Normal
ETHx/ETH_A_So_MI_MEL	0..7	–
ETHx/ETH_A_So_MI_APS_Pri	0..7	7
ETHx/ETH_A_So_MI_CSF_Period	1 s, 1 min	1 s
ETHx/ETH_A_So_MI_CSF_Pri	0..7	7
ETHx/ETH_A_So_MI_CSF_Enable	true, false	true
ETHx/ETH_A_So_MI_CSFrdifdiEnable	true, false	true
ETHx/ETH_A_So_MI_CSFdciEnable	true, false	true
ETHx/ETH_A_Sk Provisioning		
ETHx/ETH_A_Sk_MI_Active	true, false	true
ETHx/ETH_A_Sk_MI_MEP_MAC	6 byte Unicast MAC address	–
ETHx/ETH_A_Sk_MI_Client_MEL	0..7	–
ETHx/ETH_A_Sk_MI_LCK_Period	1 s, 1 min	1 s
ETHx/ETH_A_Sk_MI_LCK_Pri	0..7	7
ETHx/ETH_A_Sk_MI_Admin_State	LCK, Normal	Normal
ETHx/ETH_A_Sk_MI_AIS_Period	1 s, 1 min	1 s
ETHx/ETH_A_Sk_MI_AIS_Pri	0..7	7
ETHx/ETH_A_Sk_MI_MEL	0..7	7
ETHx/ETH_A_Sk_MI_CSF_Reported	true, false	true
ETHx/ETH_A_Sk_MI_CSFrdifdiEnable	true, false	true
ETHx/ETH-m_A_So Provisioning		
ETHx/ETH-m_A_So_MI_Active	true, false	true
ETHx/ETH-m_A_So_MI_MEP_MAC	6 byte Unicast MAC address	–
ETHx/ETH-m_A_So_MI_Client_MEL[1...M]	0..7	–
ETHx/ETH-m_A_So_MI_LCK_Period[1...M] (for each of the 1 through M VLANs)	1 s, 1 min	1 s

Table 8-3 – Provisioning and reporting for adaptation functions

MI signal	Value range	Default value
ETHx/ETH-m_A_So_MI_LCK_Pri[1...M]	0..7	7
ETHx/ETH-m_A_So_MI_Admin_State	LCK, Normal	Normal
ETHx/ETH-m_A_So_MI_VLAN_Config[1...M]	(Note)	(Note)
ETHx/ETH-m_A_So_MI_Etype	2 byte integer ≥ 0x0600	S-Tag: 0x88a8 C-Tag: 0x8100
ETHx/ETH-m_A_So_PCP_Config	8P0D, 7P1D, 6P2D, 5P3D, 4P4D, DEI	8P0D
ETHx/ETH-m_A_So_MI_MEL	0..7	7
ETHx/ETH-m_A_So_MI_CSF_Period	1 s, 1 min	1 s
ETHx/ETH-m_A_So_MI_CSF_Pri	0..7	7
ETHx/ETH-m_A_So_MI_CSF_Enable	true, false	false
ETHx/ETH-m_A_So_MI_CSFrdifdiEnable	true, false	false
ETHx/ETH-m_A_So_MI_CSFdciEnable	true, false	true
ETHx/ETH-m_A_Sk Provisioning		
ETHx/ETH-m_A_Sk_MI_Active	true, false	true
ETHx/ETH-m_A_Sk_MI_Admin_State	LCK, Normal	Normal
ETHx/ETH-m_A_Sk_MI_MEP_MAC	6 byte Unicast MAC address	–
ETHx/ETH-m_A_Sk_MI_Client_MEL[1...M]	0..7	–
ETHx/ETH-m_A_Sk_MI_LCK_Period[1...M]	1 s, 1 min	1 s
ETHx/ETH-m_A_Sk_MI_LCK_Pri[1...M]	0..7	7
ETHx/ETH-m_A_Sk_MI_AIS_Period[1...M]	1 s, 1 min	1 s
ETHx/ETH-m_A_Sk_MI_AIS_Pri[1...M]	0..7	7
ETHx/ETH-m_A_Sk_MI_VLAN_Config[1...M]	(Note)	(Note)
ETHx/ETH-m_A_Sk_MI_P_Regenerate	(Note)	(Note)
ETHx/ETH-m_A_Sk_MI_PVID	(Note)	(Note)
ETHx/ETH-m_A_Sk_MI_PCP_Config	8P0D, 7P1D, 6P2D, 5P3D, 4P4D, DEI	8P0D
ETHx/ETH-m_A_Sk_MI_Etype	2 byte integer ≥ 0x0600	S-Tag: 0x88a8 C-Tag: 0x8100
ETHx/ETH-m_A_Sk_MI_MEL	0..7	–
ETHx/ETH-m_A_Sk_MI_CSF_Reported	true, false	true
ETHx/ETH-m_A_Sk_MI_CSFrdifdiEnable	true, false	true
ETHx/ETH-m_A_Sk_MI_Frametype_Config	AllowTaggedOnly; AllowUntaggedOnly; AllowAll	AllowUntagged Only
ETHx/ETH-m_A_Sk_MI_Filter_Config	(Note)	(Note)
ETHG/ETH_A_So Provisioning		
ETHG/ETH_A_So_MI_Active	true, false	true

Table 8-3 – Provisioning and reporting for adaptation functions

MI signal	Value range	Default value
ETHG/ETH_A_So_MI_MEP_MAC	6 byte Unicast MAC address	–
ETHG/ETH_A_So_MI_Client_MEL[1...M]	0..7	–
ETHG/ETH_A_So_MI_LCK_Period[1...M]	1 s, 1 min	1 s
ETHG/ETH_A_So_MI_LCK_Pri[1...M]	0..7	7
ETHG/ETH_A_So_MI_Admin_State	LCK, Normal	Normal
ETHG/ETH_A_So_MI_MEL	0..7	–
ETHG/ETH_A_So_MI_APS_Pri	0..7	7
ETHG/ETH_A_So_MI_CSF_Period	1 s, 1 min	1 s
ETHG/ETH_A_So_MI_CSF_Pri	0..7	7
ETHG/ETH_A_So_MI_CSF_Enable	true, false	false
ETHG/ETH_A_So_MI_CSFrdifdiEnable	true, false	false
ETHG/ETH_A_So_MI_CSFdciEnable	true, false	true
ETHG/ETH_A_Sk Provisioning		
ETHG/ETH_A_Sk_MI_Active	true, false	true
ETHG/ETH_A_Sk_MI_MEP_MAC	6 byte Unicast MAC address	–
ETHG/ETH_A_Sk_MI_Client_MEL[1...M]	0..7	–
ETHG/ETH_A_Sk_MI_LCK_Period[1...M]	1 s, 1 min	1 s
ETHG/ETH_A_Sk_MI_LCK_Pri[1...M]	0..7	7
ETHG/ETH_A_Sk_MI_Admin_State	LCK, Normal	Normal
ETHG/ETH_A_Sk_MI_AIS_Period[1...M]	1 s, 1min	1 s
ETHG/ETH_A_Sk_MI_AIS_Pri[1...M]	0..7	7
ETHG/ETH_A_Sk_MI_MEL	0..7	–
ETHG/ETH_A_Sk_MI_CSF_Reported	true, false	true
ETHG/ETH_A_Sk_MI_CSFrdifdiEnable	true, false	true
ETHx/ETHG_A_So Provisioning		
ETHx/ETHG_A_So_MI_Active	true, false	true
ETHx/ETHG_A_So_MI_MEP_MAC	6 byte Unicast MAC address	–
ETHx/ETHG_A_So_MI_Client_MEL[1...M]	0..7	–
ETHx/ETHG_A_So_MI_LCK_Period[1...M] (for each of the 1 through M VLANs)	1 s, 1 min	1 s
ETHx/ETHG_A_So_MI_LCK_Pri[1...M]	0..7	7
ETHx/ETHG_A_So_MI_Admin_State	LCK, Normal	Normal
ETHx/ETHG_A_So_MI_VLAN_Config[1...M]	(Note)	(Note)
ETHx/ETHG_A_So_MI_Etype	2 byte integer ≥ 0x0600	S-Tag: 0x88a8 C-Tag: 0x8100
ETHx/ETHG_A_So_PCP_Config	8P0D, 7P1D, 6P2D, 5P3D, 4P4D, DEI	8P0D

Table 8-3 – Provisioning and reporting for adaptation functions

MI signal	Value range	Default value
ETHx/ETHG_A_So_MI_MEL	0..7	7
ETHx/ETHG_A_Sk Provisioning		
ETHx/ETHG_A_Sk_MI_Active	true, false	true
ETHx/ETHG_A_Sk_MI_Admin_State	LCK, Normal	Normal
ETHx/ETHG_A_Sk_MI_MEP_MAC	6 byte Unicast MAC address	–
ETHx/ETHG_A_Sk_MI_Client_MEL[1...M]	0..7	–
ETHx/ETHG_A_Sk_MI_LCK_Period[1...M]	1 s, 1 min	1 s
ETHx/ETHG_A_Sk_MI_LCK_Pri[1...M]	0..7	7
ETHx/ETHG_A_Sk_MI_AIS_Period[1...M]	1 s, 1 min	1 s
ETHx/ETHG_A_Sk_MI_AIS_Pri[1...M]	0..7	7
ETHx/ETHG_A_Sk_MI_VLAN_Config[1...M]	(Note)	(Note)
ETHx/ETHG_A_Sk_MI_P_Regenerate	(Note)	(Note)
ETHx/ETHG_A_Sk_MI_PVID	(Note)	(Note)
ETHx/ETHG_A_Sk_MI_PCP_Config	8P0D, 7P1D, 6P2D, 5P3D, 4P4D, DEI	8P0D
ETHx/ETHG_A_Sk_MI_Etype	2 byte integer ≥ 0x0600	S-Tag: 0x88a8 C-Tag: 0x8100
ETHx/ETHG_A_Sk_MI_MEL	0..7	–
ETHx/ETHG_A_Sk_MI_Frametype_Config	AllowTaggedOnly; AllowUntaggedOnly; AllowAll	AllowUntagged Only
ETHx/ETHG_A_Sk_MI_Filter_Config	(Note)	(Note)
ETHx/MCC_A_So Provisioning		
ETHx/MCC_A_So_MI_Active	true, false	true
ETHx/MCC_A_So_MI_MEL	0..7	–
ETHx/MCC_A_So_MI_MEP_MAC	6 byte Unicast MAC address	–
ETHx/MCC_A_So_MI_MCC_Pri	0..7	7
ETHx/MCC_A_So_MI_MEP_ID	0..8191; see Figure 9.2-3 of [ITU-T G.8013]	–
ETHx/MCC_A_So_MI_EDM_Enable	true, false	false
ETHx/MCC_A_So_MI_EDM_Period	For further study	For further study
ETHx/MCC_A_So_MI_EDM_Duration	Integer represents number of seconds	=
ETHx/MCC_A_Sk Provisioning		
ETHx/MCC_A_Sk_MI_Active	true, false	true
ETHx/MCC_A_Sk_MI_MEP_MAC	6 byte Unicast MAC address	–

Table 8-3 – Provisioning and reporting for adaptation functions

MI signal	Value range	Default value
ETHx/MCC_A_Sk_MI_MEL	0..7	–
ETHx/MCC_A_Sk Reporting		
ETHx/MCC_A_Sk_MI_EDM_received (MEP_ID, Duration)	Per provisioning at ETHx/MCC_A_So	–
ETHDi/ETH_A_So Provisioning		
ETHDi/ETH_A_So_MI_Active	true, false	false
ETHDi/ETH_A_So_MI_MEL	0..7	–
ETHDi/ETH_A_So_MI_RAPS_Pri	0..7	7
ETHDi/ETH_A_So_MI_MIP_MAC	6 byte MAC unicast address	–
ETHDi/ETH_A_Sk Provisioning		
ETHDi/ETH_A_Sk_MI_Active	true, false	false
ETHDi/ETH_A_Sk_MI_MEL	0..7	–
ETYn-Np/ETH-LAG-Na_A_So Provisioning		
ETYn-Np/ETH-LAG-Na_A_So_MI_Active	true, false	true
ETYn-Np/ETH-LAG-Na_A_So_MI_TxPauseEnable	true, false	false
ETYn-Np/ETH-LAG-Na_A_So_MI_Agg[1..Na]_AP_List	(Note)	(Note)
ETYn-Np/ETH-LAG-Na_A_So_MI_AggPort[1..Np]_ActorAdmin_State	See IEEE 802.3 clause 30.7.2.1.20	–
ETYn-Np/ETH-LAG-Na_A_So Reporting		
ETYn-Np/ETH-LAG-Na_A_So_MI_Agg[1..Na]_ActorSystemID	See IEEE 802.3 clause 30.7.1.1.4	–
ETYn-Np/ETH-LAG-Na_A_So_MI_Agg[1..Na]_ActorSystemPriority	See IEEE 802.3 clause 30.7.1.1.5	–
ETYn-Np/ETH-LAG-Na_A_So_MI_Agg[1..Na]_ActorOperKey	See IEEE 802.3 clause 30.7.1.1.8	–
ETYn-Np/ETH-LAG-Na_A_So_MI_Agg[1..Na]_PartnerSystemID	See IEEE 802.3 clause 30.7.1.1.10	–
ETYn-Np/ETH-LAG-Na_A_So_MI_Agg[1..Na]_PartnerSystemPriority	See IEEE 802.3 clause 30.7.1.1.11	–
ETYn-Np/ETH-LAG-Na_A_So_MI_Agg[1..Na]_PartnerOperKey	See IEEE 802.3 clause 30.7.1.1.12	–
ETYn-Np/ETH-LAG-Na_A_So_MI_Agg[1..Na]_DataRate	See IEEE 802.3 clause 30.7.1.1.16	–
ETYn-Np/ETH-LAG-Na_A_So_MI_Agg[1..Na]_CollectorMaxDelay	See IEEE 802.3 clause 30.7.1.1.32	–
ETYn-Np/ETH-LAG-Na_A_So_MI_AggPort[1..Np]_ActorOperKey	See IEEE 802.3 clause 30.7.2.1.5	–
ETYn-Np/ETH-LAG-Na_A_So_MI_AggPort[1..Np]_PartnerOperSystemPriority	See IEEE 802.3 clause 30.7.2.1.7	–
ETYn-Np/ETH-LAG-Na_A_So_MI_AggPort[1..Np]_PartnerOperSystemID	See IEEE 802.3 clause 30.7.2.1.9	–

Table 8-3 – Provisioning and reporting for adaptation functions

MI signal	Value range	Default value
ETYn-Np/ETH-LAG-Na_A_So_MI_AggPort[1..Np]_PartnerOperKey	See IEEE 802.3 clause 30.7.2.1.11	–
ETYn-Np/ETH-LAG-Na_A_So_MI_AggPort[1..Np]_ActorPort	See IEEE 802.3 clause 30.7.2.1.14	–
ETYn-Np/ETH-LAG-Na_A_So_MI_AggPort[1..Np]_ActorPortPriority	See IEEE 802.3 clause 30.7.2.1.15	–
ETYn-Np/ETH-LAG-Na_A_So_MI_AggPort[1..Np]_PartnerOperPort	See IEEE 802.3 clause 30.7.2.1.17	–
ETYn-Np/ETH-LAG-Na_A_So_MI_AggPort[1..Np]_PartnerOperPortPriority	See IEEE 802.3 clause 30.7.2.1.19	–
ETYn-Np/ETH-LAG-Na_A_So_MI_AggPort[1..Np]_ActorOperState	See IEEE 802.3 clause 30.7.2.1.21	–
ETYn-Np/ETH-LAG-Na_A_So_MI_AggPort[1..Np]_PartnerOperState	See IEEE 802.3 clause 30.7.2.1.23	–
ETYn-Np/ETH-LAG-Na_A_Sk Provisioning		
ETYn-Np/ETH-LAG-Na_A_Sk_MI_Active	true, false	true
ETYn-Np/ETH-LAG-Na_A_Sk_MI_PLLThr[1..Na]	(Note)	(Note)
ETH-LAG/ETH_A_So Provisioning		
ETH-LAG/ETH_A_So_MI_Active	true, false	false
ETH-LAG/ETH_A_Sk Provisioning		
ETH-LAG/ETH_A_Sk_MI_Active	true, false	false
ETH-LAG/ETH_A_Sk_MI_FilterConfig	(Note)	(Note)
ETYn/ETH_A_So Provisioning		
ETYn/ETH_A_So_MI_Active	true, false	true
ETYn/ETH_A_So_MI_TxPauseEnable	true, false	false
ETYn/ETH_A_Sk Provisioning		
ETYn/ETH_A_Sk_MI_Active	true, false	true
ETYn/ETH_A_Sk_MI_FilterConfig	(Note)	(Note)
ETYn/ETH_A_Sk_MI_MAC_Length	1518, 1522, 2000	2000
ETY3/ETC3_A_So Provisioning		
ETY3/ETC3_A_So_MI_Active	true, false	true
ETY3/ETC3_A_Sk Provisioning		
ETY3/ETC3_A_Sk_MI_Active	true, false	true
ETY4/ ETHPP-OS_A_So Provisioning		
ETY4/ETHPP-OS_A_So_MI_Active	true, false	true
ETY4/ ETHPP-OS_A_Sk Provisioning		
ETY4/ETHPP-OS_A_Sk_MI_Active	true, false	true
Sn/ETH_A_So Provisioning		
Sn/ETH_A_So_MI_Active	true, false	true
Sn/ETH_A_So_MI_CSFEnable	true, false	true

Table 8-3 – Provisioning and reporting for adaptation functions

MI signal	Value range	Default value
Sn/ETH_A_So_MI_CSFrdifdiEnable	true, false	true
Sn/ETH_A_Sk Provisioning		
Sn/ETH_A_Sk_MI_Active	true, false	true
Sn/ETH_A_Sk_MI_FilterConfig	(Note)	(Note)
Sn/ETH_A_Sk_MI_CSF_Reported	true, false	false
Sn/ETH_A_Sk_MI_MAC_Length	1518, 1522, 2000	2000
Sn/ETH_A_Sk_MI_CSFrdifdiEnable	true, false	true
Sn/ETH_A_Sk Reporting		
Sn/ETH_A_Sk_MI_AcSL (see Table 9-11 of [ITU-T G.707])	0..255	–
Sn/ETH_A_Sk_MI_AcEXI (see Table 6-2 of [ITU-T G.7041])	0..15	–
Sn/ETH_A_Sk_MI_AcUPI (see Table 6-3 of [ITU-T G.7041])	0..255	–
Sn-X-L/ETH_A_So Provisioning		
Sn-X-L/ETH_A_So_MI_Active	true, false	true
Sn-X-L/ETH_A_So_MI_CSFEnable	true, false	true
Sn-X-L/ETH_A_So_MI_CSFrdifdiEnable	true, false	true
Sn-X-L/ETH_A_Sk Provisioning		
Sn-X-L/ETH_A_Sk_MI_Active	true, false	true
Sn-X-L/ETH_A_Sk_MI_FilterConfig	(Note)	(Note)
Sn-X-L/ETH_A_Sk_MI_CSF_Reported	true, false	false
Sn-X-L/ETH_A_Sk_MI_MAC_Length	1518, 1522, 2000	2000
Sn-X-L/ETH_A_Sk_MI_CSFrdifdiEnable	true, false	true
Sn-X-L/ETH_A_Sk Reporting		
Sn-X-L/ETH_A_Sk_MI_AcSL (see Table 9-11 of [ITU-T G.707])	0..255	–
Sn-X-L/ETH_A_Sk_MI_AcEXI (see Table 6-2 of [ITU-T G.7041])	0..15	–
Sn-X-L/ETH_A_Sk_MI_AcUPI (see Table 6-3 of [ITU-T G.7041])	0..255	–
Sm/ETH_A_So Provisioning		
Sm/ETH_A_So_MI_Active	true, false	true
Sm/ETH_A_So_MI_CSFEnable	true, false	true
Sm/ETH_A_So_MI_CSFrdifdiEnable	true, false	true
Sm/ETH_A_Sk Provisioning		
Sm/ETH_A_Sk_MI_Active	true, false	true
Sm/ETH_A_Sk_MI_FilterConfig	(Note)	(Note)
Sm/ETH_A_Sk_MI_CSF_Reported	true, false	false
Sm/ETH_A_Sk_MI_MAC_Length	1518, 1522, 2000	2000
Sm/ETH_A_Sk_MI_CSFrdifdiEnable	true, false	true
Sm/ETH_A_Sk Reporting		

Table 8-3 – Provisioning and reporting for adaptation functions

MI signal	Value range	Default value
Sm/ETH_A_Sk_MI_AcSL (see Tables 9-12 and 9-13 of [ITU-T G.707])	0..255	–
Sm/ETH_A_Sk_MI_AcEXI (see Table 6-2 of [ITU-T G.7041])	0..15	–
Sm/ETH_A_Sk_MI_AcUPI (see Table 6-3 of [ITU-T G.7041])	0..255	–
Sm-X-L/ETH_A_So Provisioning		
Sm-X-L/ETH_A_So_MI_Active	true, false	true
Sm-X-L/ETH_A_So_MI_CSFEnable	true, false	true
Sm-X-L/ETH_A_So_MI_CSFrdifdiEnable	true, false	true
Sm-X-L/ETH_A_Sk Provisioning		
Sm-X-L/ETH_A_Sk_MI_Active	true, false	true
Sm-X-L/ETH_A_Sk_MI_FilterConfig	(Note)	(Note)
Sm-X-L/ETH_A_Sk_MI_CSF_Reported	true, false	false
Sm-X-L/ETH_A_Sk_MI_MAC_Length	1518, 1522, 2000	2000
Sm-X-L/ETH_A_Sk_MI_CSFrdifdiEnable	true, false	true
Sm-X-L/ETH_A_Sk Reporting		
Sm-X-L/ETH_A_Sk_MI_AcSL (see Tables 9-12 and 9-13 of [ITU-T G.707])	0..255	–
Sm-X-L/ETH_A_Sk_MI_AcEXI (see Table 6-2 of [ITU-T G.7041])	0..15	–
Sm-X-L/ETH_A_Sk_MI_AcUPI (see Table 6-3 of [ITU-T G.7041])	0..255	–
Sn-X/ETC3_A_So Provisioning		
Sn-X/ETC3_A_So_MI_Active	true, false	true
Sn-X/ETC3_A_So_MI_CSFEnable	true, false	true
Sn-X/ETC3_A_Sk Provisioning		
Sn-X/ETC3_A_Sk_MI_Active	true, false	true
Sn-X/ETC3_A_Sk_MI_CSF_Reported	true, false	false
Sn-X/ETC3_A_Sk Reporting		
Sn-X/ETC3_A_Sk_MI_AcSL (see Table 9-11 of [ITU-T G.707])	0..255	–
Sn-X/ETC3_A_Sk_MI_AcEXI (see Table 6-2 of [ITU-T G.7041])	0..15	–
Sn-X/ETC3_A_Sk_MI_AcPFI (see clause 6.1.3.1 of [ITU-T G.7041])	0 or 1	–
Sn-X/ETC3_A_Sk_MI_AcUPI (see Table 6-3 of [ITU-T G.7041])	0..255	–
Pq/ETH_A_So Provisioning		
Pq/ETH_A_So_MI_Active	true, false	true
Pq/ETH_A_So_MI_CSFEnable	true, false	true
Pq/ETH_A_So_MI_CSFrdifdiEnable	true, false	true
Pq/ETH_A_Sk Provisioning		

Table 8-3 – Provisioning and reporting for adaptation functions

MI signal	Value range	Default value
Pq/ETH_A_Sk_MI_Active	true, false	true
Pq/ETH_A_Sk_MI_FilterConfig	(Note)	(Note)
Pq/ETH_A_Sk_MI_CSF_Reported	true, false	false
Pq/ETH_A_Sk_MI_MAC_Length	1518, 1522, 2000	2000
Pq/ETH_A_Sk_MI_CSFrdifdiEnable	true, false	false
Pq/ETH_A_Sk Reporting		
Pq/ETH_A_Sk_MI_AcSL (see clause 2.1.2 of [ITU-T G.832])	0..7	–
Pq/ETH_A_Sk_MI_AcEXI (see Table 6-2 of [ITU-T G.7041])	0..15	–
Pq/ETH_A_Sk_MI_AcUPI (see Table 6-3 of [ITU-T G.7041])	0..255	–
Pq-X-L/ETH_A_So Provisioning		
Pq-X-L/ETH_A_So_MI_Active	true, false	true
Pq-X-L/ETH_A_So_MI_CSFEnable	true, false	true
Pq-X-L/ETH_A_So_MI_CSFrdifdiEnable	true, false	true
Pq-X-L/ETH_A_Sk Provisioning		
Pq-X-L/ETH_A_Sk_MI_Active	true, false	true
Pq-X-L/ETH_A_Sk_MI_FilterConfig	(Note)	(Note)
Pq-X-L/ETH_A_Sk_MI_CSF_Reported	true, false	false
Pq-X-L/ETH_A_Sk_MI_MAC_Length	1518, 1522, 2000	2000
Pq-X-L/ETH_A_Sk_MI_CSFrdifdiEnable	true, false	false
Pq-X-L/ETH_A_Sk Reporting		
Pq-X-L/ETH_A_Sk_MI_AcSL (see clause 2.1.2 of [ITU-T G.832])	0..7	–
Pq-X-L/ETH_A_Sk_MI_AcEXI (see Table 6-2 of [ITU-T G.7041])	0..15	–
Pq-X-L/ETH_A_Sk_MI_AcUPI (see Table 6-3 of [ITU-T G.7041])	0..255	–
ODUkP/ETH_A_So Provisioning		
ODUkP/ETH_A_So_MI_Active	true, false	true
ODUkP/ETH_A_So_MI_CSFEnable	true, false	true
ODUkP/ETH_A_So_MI_CSFrdifdiEnable	true, false	true
ODUkP/ETH_A_Sk Provisioning		
ODUkP/ETH_A_Sk_MI_Active	true, false	true
ODUkP/ETH_A_Sk_MI_FilterConfig	(Note)	(Note)
ODUkP/ETH_A_Sk_MI_CSF_Reported	true, false	false
ODUkP/ETH_A_Sk_MI_MAC_Length	1518, 1522, 2000	2000
ODUkP/ETH_A_Sk_MI_CSFrdifdiEnable	true, false	true
ODUkP/ETH_A_Sk Reporting		
ODUkP/ETH_A_Sk_MI_AcPT (see Table 15-8 of [ITU-T G.709])	0..255	–

Table 8-3 – Provisioning and reporting for adaptation functions

MI signal	Value range	Default value
ODUKP/ETH_A_Sk_MI_AcEXI (see Table 6-2 of [ITU-T G.7041])	0..15	–
ODUKP/ETH_A_Sk_MI_AcUPI (see Table 6-3 of [ITU-T G.7041])	0..255	–
ODUKP X L/ETH_A_So Provisioning		
ODUKP X L/ETH_A_So_MI_Active	true, false	true
ODUKP X L/ETH_A_So_MI_CSFEEnable	true, false	true
ODUKP X L/ETH_A_So_MI_CSFRdifiEnable	true, false	true
ODUKP X L/ETH_A_Sk Provisioning		
ODUKP X L/ETH_A_Sk_MI_Active	true, false	true
ODUKP X L/ETH_A_Sk_MI_FilterConfig	(Note)	(Note)
ODUKP X L/ETH_A_Sk_MI_CSF_Reported	true, false	false
ODUKP X L/ETH_A_Sk_MI_MAC_Length	1518, 1522, 2000	2000
ODUKP X L/ETH_A_Sk_MI_CSFRdifiEnable	true, false	true
ODUKP X L/ETH_A_Sk Reporting		
ODUKP X L/ETH_A_Sk_MI_AcVcPT (see Table 18-1 of [ITU-T G.709])	0..255	–
ODUKP X L/ETH_A_Sk_MI_AcEXI (see Table 6-2 of [ITU-T G.7041])	0..15	–
ODUKP X L/ETH_A_Sk_MI_AcUPI (see Table 6-3 of [ITU-T G.7041])	0..255	–
ODU2P/ETHPP OS_A_So Provisioning		
ODU2P/ETHPP OS_A_So_MI_Active	true, false	true
ODU2P/ETHPP OS_A_So_MI_CSFEEnable	true, false	true
ODU2P/ETHPP OS_A_Sk Provisioning		
ODU2P/ETHPP OS_A_Sk_MI_Active	true, false	true
ODU2P/ETHPP OS_A_Sk_MI_CSF_Reported	true, false	false
ODUKP X L/ETH_A_Sk Reporting		
ODU2P/ETHPP OS_A_Sk_MI_AcPT	0..255	–
ODU2P/ETHPP OS_A_Sk_MI_AcEXI	0..15	–
ODU2P/ETHPP OS_A_Sk_MI_AcUPI	0..255	–
NOTE – According to [ITU-T G.8021].		

8.7 Connection

See clause 8.6 of [ITU-T G.7710] for a description of connection management.

This function allows a user to provision the operation of an ETH connection process.

The MI signals listed in Table 8-4 are communicated from the EMF to the connection process through the management point.

For the connection functions supported by an ET.NE, the ET.NE EMF shall support the following management functions:

- Provisioning the connection management information;
- Retrieving the connection management information;
- Notifying the changes of the connection management information.

Table 8-4 – Provisioning and reporting for connection functions

MI signal	Value range	Default value
ETH_C Provisioning		
ETH_C_MI_Create_FF	(Note)	(Note)
ETH_C_MI_Modify_FF	(Note)	(Note)
ETH_C_MI_Delete_FF	(Note)	(Note)
ETH_C Provisioning per Flow Forwarding Process		
ETH_C_MI_FF_Set_PortIds	(Note)	(Note)
ETH_C_MI_FF_ConnectionType	(Note)	(Note)
ETH_C_MI_FF_Flush_Learned	–	–
ETH_C_MI_FF_Flush_Config	–	–
ETH_C_MI_FF_Group_Default	(Note)	(Note)
ETH_C_MI_FF_ETH_FF	(Note)	(Note)
ETH_C_MI_FF_Ageing	10 to 10 ⁶ s	300 s
ETH_C_MI_FF_Learning	(Note)	(Note)
ETH_C_MI_FF_STP_Learning_State[i] (for each port)	true, false	true
ETH_C Provisioning per SNC/S protection process		
ETH_C_MI_PS_WorkingPortId	(Note)	(Note)
ETH_C_MI_PS_ProtectionPortId	(Note)	(Note)
ETH_C_MI_PS_ProtType	(Note)	(Note)
ETH_C_MI_PS_OperType	(Note)	(Note)
ETH_C_MI_PS_HoTime	(Note)	(Note)
ETH_C_MI_PS_WTR	(Note)	(Note)
ETH_C_MI_PS_ExtCMD	(Note)	(Note)
ETH_C_MI_PS_BridgeType	0 (Selector bridge), 1 (Broadcast bridge)	0
ETH_C_MI_PS_SD_Protection	disabled, enabled	disabled
ETH_C Provisioning per Ring protection process		
ETH_C_MI_RAPS_PortIds[0...1]	(Note)	(Note)
ETH_C_MI_RAPS_RPL_Owner_Node	(Note)	(Note)
ETH_C_MI_RAPS_RPL_Neighbour_Node	(Note)	(Note)
ETH_C_MI_RAPS_Propagate_TC[1...M]	(Note)	(Note)
ETH_C_MI_RAPS-Compatible_Version	(Note)	(Note)
ETH_C_MI_RAPS_Revertive	(Note)	(Note)
ETH_C_MI_RAPS_Sub_Ring_Without_Virtual_Channel	(Note)	(Note)
ETH_C_MI_RAPS_HoTime	(Note)	(Note)
ETH_C_MI_RAPS_WTR	(Note)	(Note)
ETH_C_MI_RAPS_GuardTime	(Note)	(Note)

Table 8-4 – Provisioning and reporting for connection functions

MI signal	Value range	Default value
ETH_C_MI_RAPS_ExtCMD	(Note)	(Note)
ETH_C_MI_RAPS_RingID	1 to 239 (0x01 to EF)	1
<u>ETH_C Reporting per Ring protection process</u>		
<u>ETH_C_MI_RAPS_NodeState</u>	<u>"-", "Idle", "Protection", "Manual switch", "Forced switch", "Pending"</u>	=
<u>ETH_C_MI_RAPS_PortState[0..1]</u>	<u>"Blocked", "Unblocked"</u>	=
NOTE – According to [ITU-T G.8021].		

8.8 Diagnostic

This function allows a user to provision the operation of an ETH diagnostic process.

The MI signals listed in Table 8-5 are communicated from the EMF to the diagnostic process across the management point within the ET NE.

For the diagnostic functions supported by an ET.NE, the ET.NE EMF shall support the following management functions:

- Provisioning the trail termination management information;
- Retrieving the trail termination management information;
- Notifying the changes of the trail termination management information;
- Receiving the monitored trail termination management information.

Table 8-5 – Provisioning and reporting for diagnostic functions

MI signal	Value range	Default value
Provisioning of diagnostic flow termination source for MEP		
ETHDe_FT_So_MI_LM_Start(DA,P,Period)	For Period: 100 ms, 1 s, 10 s (Also see Notes 1 and 2 for destination address (DA) and P)	For period: 100 ms
ETHDe_FT_So_MI_LM_Intermediate_Request	–	–
ETHDe_FT_So_MI_LM_Terminate	–	–
ETHDe_FT_So_MI_LB_Discover(P)	(Note 2)	–
ETHDe_FT_So_MI_LB_Series(DA,DE,P,N,Length,Period)	(Notes 1 and 2)	–
ETHDe_FT_So_MI_LB_Test(DA,DE,P,Pattern, Length, Period)	(Notes 1 and 2)	–
ETHDe_FT_So_MI_LB_Test_Terminate	–	–

Table 8-5 – Provisioning and reporting for diagnostic functions

MI signal	Value range	Default value
ETHDe_FT_So_MI_DM_Start(DA,P, Test_ID,Length,Period)	For Period: 100 ms, 1 s, 10 s (Also see Notes 1 and 2 for DA and P)	For period: 100 ms
ETHDe_FT_So_MI_DM_Intermediate_Request	–	–
ETHDe_FT_So_MI_DM_Terminate	–	–
ETHDe_FT_So_MI_1DM_Start(DA,P, Test_ID,Length,Period)	For Period: 100 ms, 1 s, 10 s (Also see Notes 1 and 2 for DA and P)	For period: 100 ms
ETHDe_FT_So_MI_1DM_Terminate	–	–
ETHDe_FT_So_MI_TST(DA,DE,P,Pattern, Length, Period)	(Notes 1 and 2)	–
ETHDe_FT_So_MI_TST_Terminate	–	–
ETHDe_FT_So_MI_LT(TA,TTL,P)	(Note 1)	–
ETHDe_FT_So_MI_MEP_MAC	6 byte MAC unicast address	–
ETHDe_FT_So_MI_MEL	0..7	–
ETHDe_FT_So_MI_MEP_ID	0..8191; see Figure 9.2-3 of [ITU-T G.8013]	–
ETHDe_FT_So_MI_SL_Start(DA,P, Test_ID,Length,Period)	For Period: 10 ms, 100 ms, 1 s, 10 s (Also see Notes 1 and 2 for DA and P)	For period: 100 ms
ETHDe_FT_So_MI_SL_Intermediate_Request	–	–
ETHDe_FT_So_MI_SL_Terminate	–	–
ETHDe_FT_So_MI_1SL_Start(DA,P,Test_ID,Length,Period)	For Period: 10 ms, 100 ms, 1 s, 10 s (Also see Notes 1 and 2 for DA and P)	For period: 100 ms
ETHDe_FT_So_MI_1SL_Terminate	–	–
Reporting of diagnostic flow termination source for MEP		
ETHDe_FT_So_MI_LM_Result(N_TF, N_LF, F_TF, F_LF)	(Note 1)	–
ETHDe_FT_So_MI_LB_Discover_Result(MACs)	6 byte MAC unicast address	–
ETHDe_FT_So_MI_DM_Result(count,B_FD[],F_FD[],N_FD[])		

Table 8-5 – Provisioning and reporting for diagnostic functions

MI signal	Value range	Default value
ETHDe_FT_So_MI_LB_Series_Result(REC,ERR,OO)	(Note 1)	–
ETHDe_FT_So_MI_LB_Test_Result(Sent, REC, CRC, BER, OO)	(Note 1)	–
ETHDe_FT_So_MI_TST_Result(Sent)	(Note 1)	–
ETHDe_FT_So_MI_LT_Results(Results)	(Note 1)	–
ETHDe_FT_So_MI_SL_Result(N_TF,N_LF,F_TF,F_LF)	(Note 1)	–
Provisioning of diagnostic flow termination sink for MEP		
ETHDe_FT_Sk_MI_MEL	0..7	–
ETHDe_FT_Sk_MI_MEP_MAC	6 byte Unicast MAC address	–
ETHDe_FT_Sk_MI_1DM_Start(SA, P,Test_ID)	6 byte Unicast MAC address, Non-negative integer	–
ETHDe_FT_Sk_MI_1DM_Intermediate_Request	–	–
ETHDe_FT_Sk_MI_1DM_Terminate	–	–
ETHDe_FT_Sk_MI_TST_Start(SA, pattern)	(Note 1)	–
ETHDe_FT_Sk_MI_TST_Terminate	–	–
ETHDe_FT_Sk_MI_1SL_Start(SA,MEP ID, Test ID)	(Notes 1 and 2)	–
ETHDe_FT_Sk_MI_1SL_Intermediate_Request	–	–
ETHDe_FT_Sk_MI_1SL_Terminate	–	–
Reporting of diagnostic flow termination sink for MEP		
ETHDe_FT_Sk_MI_1DM_Result(count,N_FD[])	(Note 1)	–
ETHDe_FT_Sk_MI_1SL_Result(N_TF,N_LF)	(Note 1)	–
ETHDe_FT_Sk_MI_TST_Result(REC, CRC, BER, OO)	(Note 1)	–
Provisioning of diagnostic flow termination source for MEG intermediate point (MIP)		
ETHDi_FT_So_MI_MEL	0..7	–
ETHDi_FT_So_MI_MIP_MAC	6 byte MAC unicast address	–
Provisioning of diagnostic flow termination sink for MIP		
ETHDi_FT_Sk_MI_MEL	0..7	–
ETHDi_FT_Sk_MI_MIP_MAC	6 byte MAC unicast address	–
NOTE 1 – According to [ITU-T G.8021].		
NOTE 2 – DA is 6-byte MAC address, P is 0..7, drop eligibility (DE) is 0..1.		

8.9 Traffic conditioning and shaping

This function allows a user to provision the operation of an ETH traffic conditioning and shaping process.

The MI signals listed in Table 8-6 are communicated between the EMF and the traffic conditioning and shaping process across the management point within the ET NE.

For the traffic conditioning and shaping functions supported by an ET.NE, the ET.NE EMF shall support the following management functions:

- Provisioning the trail termination management information;
- Retrieving the trail termination management information;
- Notifying the changes of the trail termination management information;
- Receiving the monitored trail termination management information.

Table 8-6 – Provisioning for traffic conditioning and shaping functions

MI signal	Value range	Default value
ETH_TCS_So Provisioning		
ETH_TCS_So_MI_PrioConfig	(Note)	(Note)
ETH_TCS_So_MI_QueueConfig[]	(Note)	(Note)
ETH_TCS_So_MI_SchedConfig	(Note)	(Note)
ETH_TCS_Sk Provisioning		
ETH_TCS_Sk_MI_PrioConfig	(Note)	(Note)
ETH_TCS_Sk_MI_CondConfig[]	(Note)	(Note)
ETH_GTCS_So Provisioning		
ETH_GTCS_So_MI_PrioConfig[]	(Note)	(Note)
ETH_GTCS_So_MI_QueueConfig[][]	(Note)	(Note)
ETH_GTCS_So_MI_SchedConfig[]	(Note)	(Note)
NOTE – According to [ITU-T G.8021].		

8.10 XXX_Reported

See clause 8.8 of [ITU-T G.7710] for a description of XXX_Reported management.

Table 8-7 provides the MI signals that need to be provisioned for consequential defect/failure.

For the XXX_Reported functions supported by an ET.NE, the ET.NE EMF shall support the following management functions:

- Provisioning the trail termination management information;
- Retrieving the trail termination management information;
- Notifying the changes of the trail termination management information.

Table 8-7 – Consequential defect/failure related provisioning

MI signal	Value range	Default value
MI_CSF_Reported	true, false	false

8.11 Alarm severity

See clause 8.9 of [ITU-T G.7710] for a description of alarm severity.

8.12 Alarm reporting control

See clause 8.10 of [ITU-T G.7710] for a description of ARC.

8.13 PM thresholds

For further study.

8.14 TCM activations

For further study.

8.15 Date and time

The date and time functions within the ET EMF comprise the local real-time clock (RTC) function and the performance monitoring clock (PMC) function. The message communication function within the ET NEF shall be capable of setting the local RTC function.

The date and time values are incremented by a free running local clock, or by an external timing source. The fault, configuration, account, performance and security management (FCAPS) functions that need date and time information, e.g., to time-stamp event reports, obtain this information from the date and time function.

8.15.1 Date and time application

Clause 8.13.1 of [ITU-T G.7710] identifies three date and time applications. These are:

- time-stamping;
- performance monitoring clock signals;
- activity scheduling.

The ET NEF functional requirements for these applications are specified in the following subclauses.

8.15.1.1 Time-stamping

See clause 8.13.1.1 of [ITU-T G.7710] for a description of the time-stamping application.

8.15.1.2 Performance monitoring clock signals

See clause 8.13.1.2 of [ITU-T G.7710] for a description of the PMC signals.

8.15.1.3 Activity scheduling

See clause 8.13.1.3 of [ITU-T G.7710] for a description of the activity scheduling application.

8.15.2 Date and time functions

There are three date and time functions defined. The local RTC function is required for time-stamping and activity scheduling. The local RTC alignment function is required for aligning the clock with an external time reference. The PMC function, in addition to RTC, is typical for digital counter measurements.

8.15.2.1 Local RTC function

The local RTC function is specified in clause 8.13.2.1 of [ITU-T G.7710].

8.15.2.2 Local RTC alignment function with external time reference

The local RTC alignment function with external time reference is specified in clause 8.13.2.2 of [ITU-T G.7710].

8.15.2.3 Performance monitoring clock function

The performance monitoring clock function is specified in clause 8.13.2.3 of [ITU-T G.7710].

9 Accounting management

For further study.

10 Performance management

See clause 10 of [ITU-T G.7710] for the generic requirements for performance management. ET specific management requirements are described below.

10.1 Performance management applications

See clause 10.1 of [ITU-T G.7710] for the generic description for performance management applications.

10.2 Performance monitoring functions

See clause 10.2 of [ITU-T G.7710] for the generic requirements of performance monitoring functions. The following are ET specific performance management requirements:

1. PM measurements are managed at TTPs and connection termination points (CTPs) (i.e., MEPs/MIPs are created and deleted)
2. One MEP has to be created per MEL if that has to be supervised
3. Two kinds of measurement jobs have to be supported: proactive, on-demand
4. Proactive measurement jobs are managed at MEPs (establish, disable, enable, terminate)
5. On-demand measurement jobs are managed at MEPs (establish, modify, abort)
6. On-demand measurements can be done using four different OAM PDU generation mechanisms: single instance, repetitive instance, single series and repetitive series. To describe these mechanisms, the following terms are used:
 - OAM PDU generation type:
Generation pattern of the on-demand OAM message
Valid types are: single instance, repetitive instance, single series and repetitive series.
 - message period (x)
Frequency of the OAM message generation within a series.
Note that a value of zero (i.e., $x = 0$) means that only one OAM message per measurement interval is generated.
 - measurement interval (y)
Defines discrete non-overlapping periods of time during which measurements are performed (i.e., OAM messages are generated) and reports are gathered at the end of the measurement intervals.
Note that a value of zero means a degenerated measurement interval with a single OAM message and the report is sent as immediately as possible.
 - repetition period (z)
The time between the start of two measurement intervals. This *is* applicable for the repetitive instance type and *may* be applicable for the repetitive series type.
Note that a value of zero means not applicable (NA), which is for the cases of single instance, single series, or repetitive series without extra gap in between the measurement intervals (i.e., also as known as continuous series).
 - start time
Define the start of the on-demand session

- stop time
Define the stop of the on-demand session
- session duration
Stop time – start time.

Note that session duration is not a configuration parameter. That is, it is not needed in the configuration.

The four on-demand measurements are illustrative in Figure 10-1. In each mechanism, the mandatory parameters (i.e., the required minimum set of parameters) are in red font. The optional parameters are in black font. Optional parameters are not needed but may be used for validation purpose.

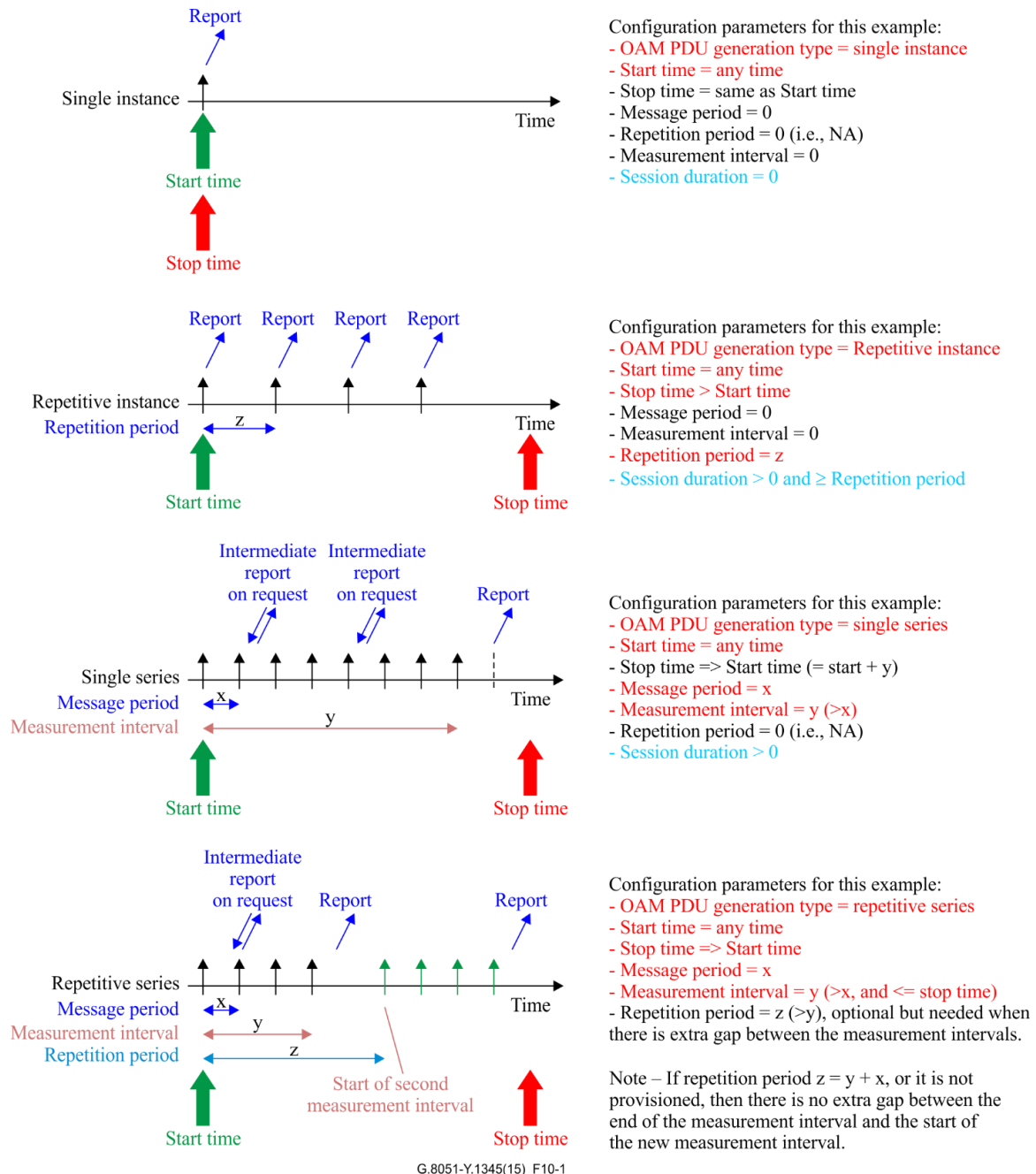

Figure 10-1 – On-demand OAM PDU generation mechanisms

Note that in the repetitive series case, if the repetition period $z = y + x$, or the value is not provisioned, then there is no extra gap between the end of the measurement interval and the start of the new measurement interval. This pattern is also known as the continuous series cases. The repetition period (z) is needed if there is extra gap between the measurement intervals.

7. It shall be possible to configure the following on-demand measurement parameters (including the default values)
 - a) OAM PDU generation type; default = repetitive instance;
 - b) start time; default = current time;
 - c) stop time; default = current time + 1 hour;
 - d) OAM message period; default = 0;
 - e) measurement interval; default = 0;
 - e) repetition period; default = 0.
8. Parallel measurement jobs, one per priority, can be established
9. Performance data is stored in registers associated to the measurement job
10. On-demand measurement jobs are automatically terminated after (last) report is sent
11. Threshold profiles are managed at the managed element (create, modify, delete)
12. It shall be possible to retrieve the following configuration information:
 - a) all existing MEPs/MIPs within a TP (TTP or CTP);
 - b) all existing measurement jobs within a MEP;
 - c) all existing threshold profiles within a network element;
 - d) all threshold settings within a proactive PM measurement job.
13. It shall be possible to retrieve all proactive PM measurement current and history performance data within a MEP
14. It shall be possible to request intermediate reports on an on-demand PM measurement job of "single series" and "repetitive series" types
15. It shall be possible to request an autonomous continuous reporting of performance data from all proactive PM measurement jobs within a MEP (i.e., automatic "push" of the measured PM data)
16. On-demand loss measurement can be measured by directly counting the data traffic (e.g., using the [ITU-T G.8013] defined loss measurement message (LMM)/loss measurement reply (LMR)) or can be inferred by counting the synthetic traffic (e.g., using the ITU-T G.8013 defined SLM/SLR or one-way synthetic loss measurement (1SL)). If on-demand loss measurement is supported, for each measurement interval, the Ethernet NE should:
 - receive from the transport plane the measurements (i.e., N_TF, N_LF, F_TF, F_LF) at the end of each measurement interval.

Note that according to the definition of near-end and far-end frame loss in clause 8.1 of [ITU-T G.8013], for a MEP, N_TF and N_LF refer to the transmitted and lost ingress frames while F_TF and F_LF refer to the transmitted and lost egress frames.

Note that 1SL can provide only near-end measurement (i.e., N_TF, N_LF);
 - store the measurements (TN_TF, TN_LF, TF_TF, TF_LF) and calculate the frame loss ratios (FLRs) ($TN_FLR = TN_LF / TN_TF$, $TF_FLR = TF_LF / TF_TF$). The measurements and FLRs shall be reported to the management system;

- at the instruction of the management system, the NE shall be able to request from the transport plane the intermediate (i.e. before the end of the measurement interval) measurements, calculate the intermediate FLRs and report the intermediate results (TN_TF, TN_LF, TN_FLR, TF_TF, TF_LF, TF_FLR) to the management system.

NOTE – An on-demand LM or DM session could be a single series of OAM messages or a single instance of OAM message. A single instance OAM could be considered as a special case of a single series OAM.

17. Proactive loss measurement can be measured by directly counting the data traffic (e.g., using the [ITU-T G.8013] defined CCM or LMM/LMR) or can be inferred by counting the synthetic traffic (e.g., using the [ITU-T G.8013] defined SLM/SLR or 1SL). If proactive loss measurement is supported, for each loss measurement session the Ethernet NE should:

- receive from the transport plane the measurements (i.e., pN_TF, pN_LF, pF_TF, pF_LF) for each OAM period.

Note that 1SL can support only near-end measurement (i.e., N_TF, N_LF);

- calculate the FLRs ($N_FLR = pN_LF / pN_TF$, $F_FLR = pF_LF / pF_TF$) for each OAM period; store the temporal minimum, average, and maximum statistics (mN_FLR, aN_FLR, xN_FLR, mF_FLR, aF_FLR, xF_FLR) in the current 15-minute and 24-hour registers. The stored statistics shall be available for retrieval by the management system;
- the FLR measurements of a monitored entity measured during severely errored seconds (SES) shall be included in the computation of its FLR statistics, unless the SES is part of the unavailable time period.

NOTE – This is in line with the definition made in Note 1 of clause 1 in [ITU-T Y.1563];

- at the maturity of the current 15-minute and 24-hour periods, the statistics in the current registers shall move to the history registers and then reset the current registers to zeros. See detailed requirements in [ITU-T G.7710].

18. If on-demand 1-way DM (i.e., 1DM) is supported, for each on-demand 1-way DM measurement interval, the Ethernet NE should:

- receive from the transport plane the array of near-end measurements (count, N_FD[]) at the end of each measurement interval;
- store the measurements, compute the corresponding array of N_FD V[] and report the near-end measurements (count, N_FD[], N_FD V[]) to the management system;
- at the instruction of the management system, the NE shall be able to request from the transport plane the intermediate measurements, calculate the intermediate N_FD V[], and report the intermediate results (count, N_FD[], N_FD V[]) to the management system.

19. If proactive 1-way DM (i.e., 1DM) is supported, for each proactive 1-way DM session the Ethernet NE should:

- receive from the transport plane the near-end measurements (pN_FD, pN_FD V) for each OAM period;
- store the temporal minimum, average, and maximum (N_FD, N_FD V) in the current 15-minute and 24-hour registers. The stored statistics shall be available for retrieval by the management system;
- at the maturity of the current 15-minute and 24-hour periods, the statistics in the current registers shall move to the history registers and then reset the current registers to zeros. See detailed requirements in [ITU-T G.7710].

NOTE – Version 1 of the 1DM PDU format has been defined in the 2011 revision of [ITU-T G.8013] to support both proactive and on-demand 1-way DM applications, in which proactive and on-demand 1DM applications are distinguished by using the Type bit of the Flags field of the 1DM PDU. Proactive 1DM application is configured at the ETHx flow termination functions (ETHx_FT) with

the Type bit is set to 1, while the on-demand 1DM application is configured at the ETH diagnostic flow termination function (ETHDe_FT) with the Type bit being set to 0. See clause 8.1.11 of [ITU-T G.8021] for details.

20. If on-demand 2-way DM (i.e., delay measurement message (DMM)/delay measurement reply (DMR)) is supported, for each on-demand 2-way DM measurement interval, the Ethernet NE should:
- receive from the transport plane the array of near-end, far-end and bidirectional measurements (count, N_FD[], F_FD[], B_FD[]) at the end of each measurement interval;
 - store the measurements, compute the corresponding array of FDV[], and report the near-end, far-end and bidirectional (2-way) measurements (count, N_FD[], F_FD[], B_FD[]; N_FDV[], F_FDV[], B_FDV[]) to the management system;
 - at the instruction of the management system, the NE shall be able to request from the transport plane the intermediate measurements, calculate the intermediate FDV[], and report the intermediate results (count, N_FD[], F_FD[], B_FD[]; N_FDV[], F_FDV[], B_FDV[]) to the management system.
21. If proactive 2-way DM (i.e., DMM/DMR) is supported, for each proactive 2-way DM session the Ethernet NE should:
- receive from the transport plane the near-end, far-end and bidirectional measurements (N_FD, F_FD, B_FD; N_FDV, F_FD, B_FD) for each OAM period;
 - store the temporal minimum, average, and maximum for each type of the measurements (N_FD, F_FD, B_FD; N_FD, F_FD, B_FD) for the current 15-minute and 24-hour registers. The stored statistics shall be available for retrieval by the management system;
 - at the maturity of the current 15-minute and 24-hour periods, the statistics in the current registers shall move to the history registers and then reset current registers to zeros. See detailed requirements in [ITU-T G.7710].
- NOTE – Version 1 of the 1DM PDU format has been defined in the 2011 revision of [ITU-T G.8013] to support both proactive and on-demand 1-way DM applications, in which proactive and on-demand 1DM applications are distinguished by using the Type bit of the Flags field of the 1DM PDU. Proactive 1DM application is configured at the ETHx flow termination functions (ETHx_FT) with the Type bit is set to 1, while the on-demand 1DM application is configured at the ETH diagnostic flow termination function (ETHDe_FT) with the Type bit being set to 0. See clause 8.1.11 of [ITU-T G.8021] for details.
22. The Ethernet NE should support the ability to configure for the start and stop at the respondent-end MEP of a single-ended measurement session (such as LMM/LMR and DMM/DMR).

For illustrative purpose, Figure 10-2 through Figure 10-5 below illustrate the derivation of the loss measurement from the counter values provided by the single-ended and dual-ended mechanisms.

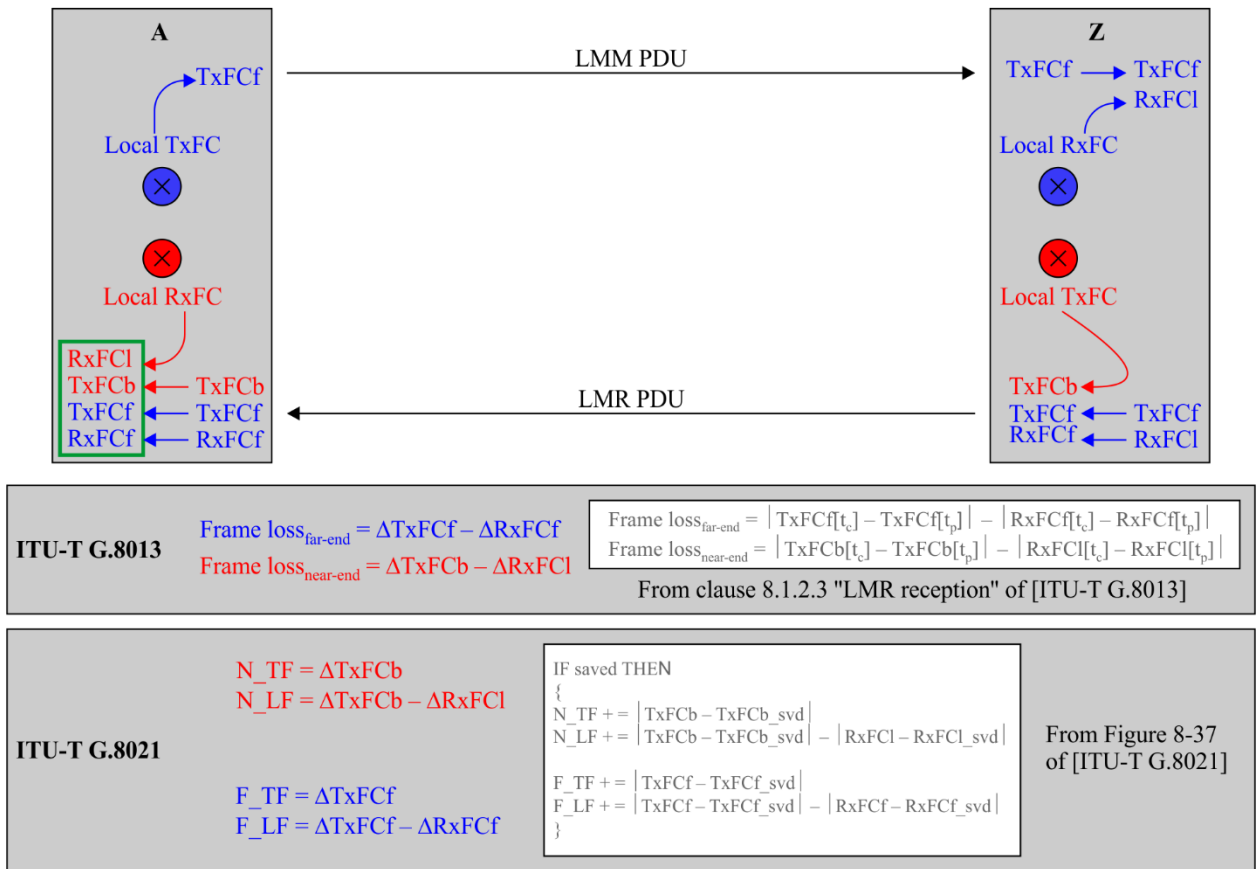

Figure 10-2 – Single-ended loss measurement using LMM/LMR

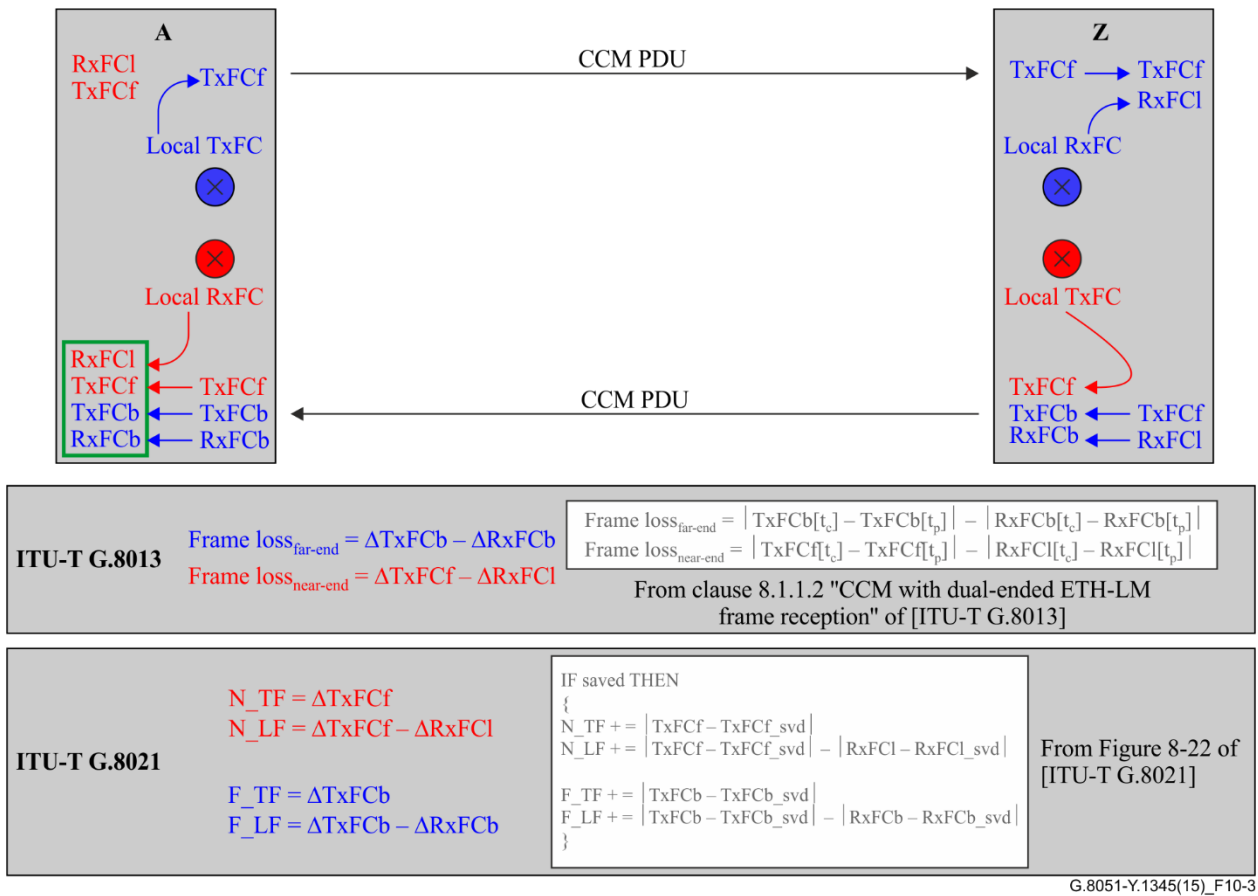

Figure 10-3 – Dual-ended loss measurement using CCM

(Note that for loss measurement, CCM is proactive only.)

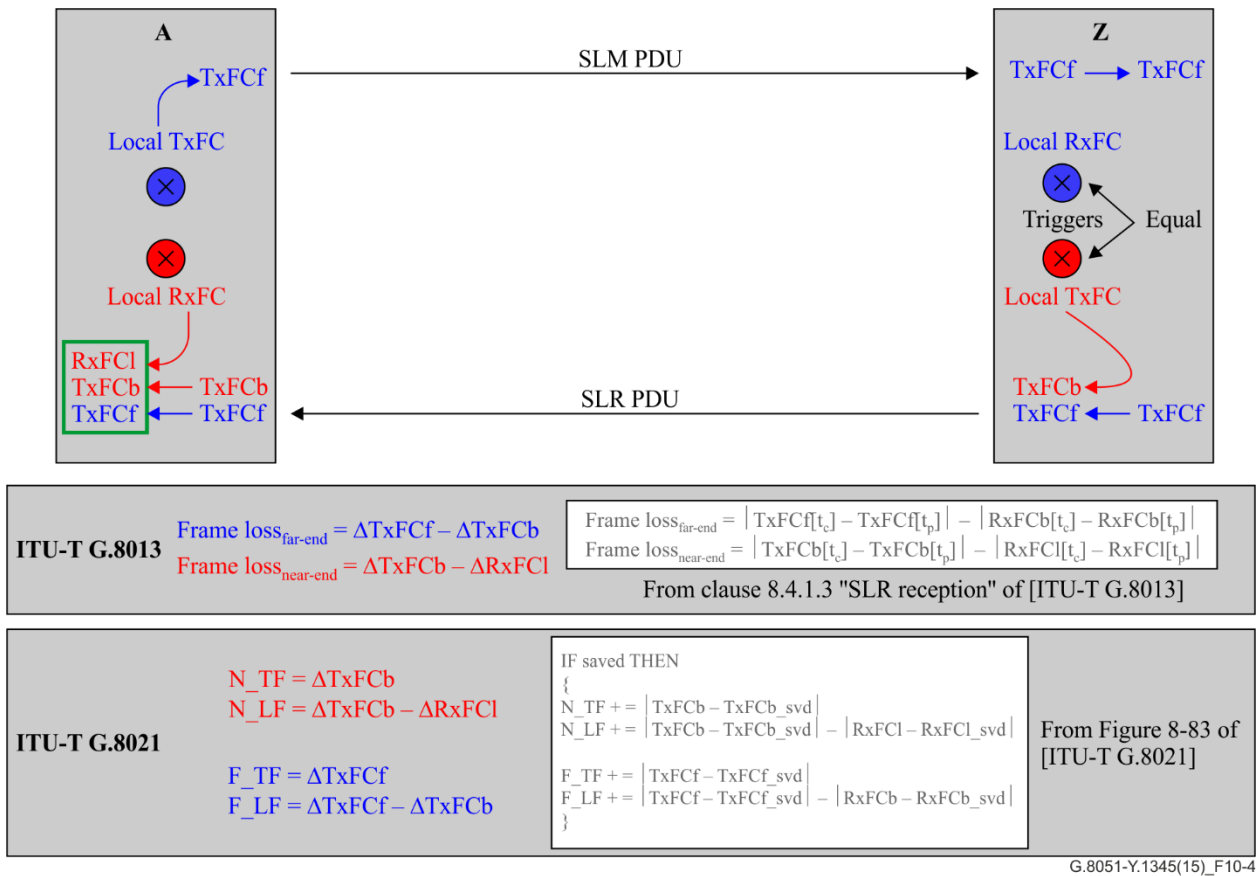

Figure 10-4 – Single-ended loss measurement using SLM/SLR

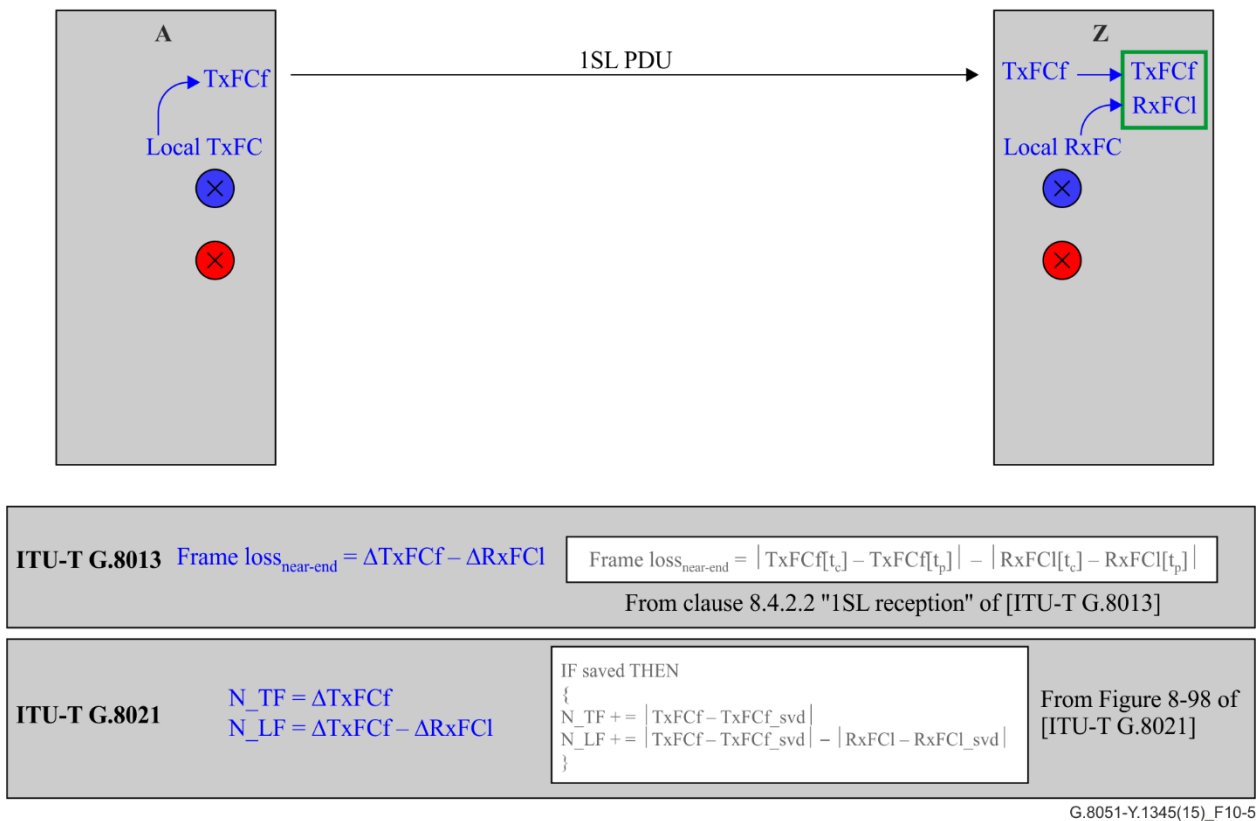

Figure 10-5 – Dual-ended loss measurement using 1SL

ET.NE provides the following PM management information (see Table 10-1).

Table 10-1 – PM management information

PM management information	G.8021 function
ETH_FT_Sk_MI_pN_LF ETH_FT_Sk_MI_pN_TF ETH_FT_Sk_MI_pF_LF ETH_FT_Sk_MI_pF_TF ETH_FT_Sk_MI_pF_DS ETH_FT_Sk_MI_pN_DS ETH_FT_Sk_MI_pB_FD ETH_FT_Sk_MI_pB_FDV ETH_FT_Sk_MI_pF_FD ETH_FT_Sk_MI_pF_FDV ETH_FT_Sk_MI_pN_FD ETH_FT_Sk_MI_pN_FDV	ETHx_FT_Sk
ETHx_FT_Sk_MI_pN_TF ETHx_FT_Sk_MI_pN_LF ETHx_FT_Sk_MI_pF_TF ETHx_FT_Sk_MI_pF_LF	ETHDe_FT_So
ETHG_FT_Sk_MI_pN_TF ETHG_FT_Sk_MI_pN_LF ETHG_FT_Sk_MI_pF_TF ETHG_FT_Sk_MI_pF_LF ETHG_FT_Sk_MI_pF_DS ETHG_FT_Sk_MI_pN_DS ETHG_FT_Sk_MI_pB_FD ETHG_FT_Sk_MI_pB_FDV ETHG_FT_Sk_MI_pF_FD ETHG_FT_Sk_MI_pF_FDV ETHG_FT_Sk_MI_pN_FD ETHG_FT_Sk_MI_pN_FDV	ETHG_FT_Sk
ETYn-Np/ETH-LAG-Na_A_So_MI_pAggOctetsTxOK[1..Na] ETYn-Np/ETH-LAG-Na_A_So_MI_pAggFramesTxOK[1..Na] ETYn-Np/ETH-LAG-Na_A_So_MI_pFramesTransmittedOK[1..Np] ETYn-Np/ETH-LAG-Na_A_So_MI_pOctetsTransmittedOK[1..Np]	ETYn-Np/ETH-LAG-Na_A_So
ETYn-Np/ETH-LAG-Na_A_Sk_MI_pAggOctetsRxOK[1..Na] ETYn-Np/ETH-LAG-Na_A_Sk_MI_pAggFramesRxOK[1..Na] ETYn-Np/ETH-LAG-Na_A_Sk_MI_pFramesReceivedOK[1..Np] ETYn-Np/ETH-LAG-Na_A_Sk_MI_pOctetsReceivedOK[1..Np] ETYn-Np/ETH-LAG-Na_A_Sk_MI_pFCSErrors[1..Np]	ETYn-Np/ETH-LAG-Na_A_Sk
ETYn/ETH_A_So_MI_pFramesTransmittedOK ETYn/ETH_A_So_MI_pOctetsTransmittedOK	ETYn/ETH_A_So
ETYn/ETH_A_Sk_MI_pErrors ETYn/ETH_A_Sk_MI_pFramesReceivedOK ETYn/ETH_A_Sk_MI_pOctetsReceivedOK	ETYn/ETH_A_Sk
Sn/ETH_A_Sk_MI_pFCSErrors	Sn/ETH_A_Sk
Sn-X-L/ETH_A_Sk_MI_pFCSError	Sn-X-L/ETH_A_Sk

Table 10-1 – PM management information

PM management information	G.8021 function
Sm/ETH_A_Sk_MI_pFCSError	Sm/ETH_A_Sk
Sm-X-L/ETH_A_Sk_MI_pFCSError	Sm-X-L/ETH_A_Sk
Sn-X/ETC3_A_Sk_MI_pCRC16Errors	Sn-X/ETC3_A_Sk
Pq/ETH_A_Sk_MI_pFCSError	Pq/ETH_A_Sk
Pq-X-L/ETH_A_Sk_MI_pFCSError	Pq-X-L/ETH_A_Sk
ODUKP/ETH_A_Sk_MI_pFCSErrors	ODUKP/ETH_A_Sk
ODUKP-X-L/ETH_A_Sk_MI_pFCSError	ODUKP-X-L/ETH_A_Sk
ODU2P/ETHPP-OS_A_Sk_MI_pFCSErrors ODU2P/ETHPP-OS_A_Sk_MI_pCRC16Errors	ODU2P/ETHPP-OS_A_Sk

The EMF shall support the following function:

- Notifying of the PM management information.

11 Security management

See [ITU-T G.7710] for a description of security management.

Appendix I

MI signals/parameters for PM tools in ITU-T G.8021

(This appendix does not form an integral part of this Recommendation.)

The following two tables summarize the MI signals defined in [ITU-T G.8021] for the proactive and on-demand performance monitoring tools.

Table I.1 – MI signals for proactive PM (ETHx_FT)

OAM Type	dir	MI signals								
		Enable	MAC		ID		Length	Period	Pri	Others
			DA	SA	Test	MEP				
CC	So	✓LMC (*1)	(*6)				(*5)	✓	✓	
	Sk	✓LMC (*1)						✓(*7)	✓(*7)	GetSvdCCM, SvtCCM
LM	So	✓LML (*1)	✓		(*3)		(*5)	✓	✓	
	Sk									Degraded M (DEGM), M, DEGHER, TFMIN
ISL	So	✓	✓		✓		✓	✓	✓	
	Sk	✓		✓(*2)	✓	(*4)				
SL	So	✓	✓		✓		✓	✓	✓	
	Sk									
IDM	So	✓	✓		✓		✓	✓	✓	
	Sk	✓		✓(*2)	✓					
DM	So	✓	✓		✓		✓	✓	✓	
	Sk									

Table I.1 – MI signals for proactive PM (ETHx_FT)

NOTES:

*1 MI_{LMC,LML}_Enable are used to activate the loss measurement process by proactive CCM/ LMx, respectively. Since the calculation of CCM is performed at sink side, the MI_LMC_Enable signal is required at sink side (as well as source side, where other protocols have). Note that the latest [ITU-T G.8021] has removed the functionality of MI signals for the allocation of the local counter resources.

*2 MI_MAC_SA for 1SL/1DM is used to verify that the received PDU is properly sent from the expected peer node.

*3 MI_Test_ID is not specified in LM until now.

*4 MI_MEP_ID was removed during [ITU-T G.8021] v4 AAP because MEP_ID carried in PDU is not evaluated at sink side

*5 MI_Length is not applicable for CC/LM because the length of both PDUs is always fixed.

*6 MI_MAC_DA is not explicitly specified for CCM protocol because it uses the multicast class 1 address as the default MAC DA.

*7 MI_Period/Priority are configured for sink side of CCM process (as well as the source side) to detect the mismatch defects (dUNP and dUNPr). Note that other protocols do not need to specify neither of MI signals at sink side.

Table I.2 – MI signals/parameters for on-demand PM (ETHDe_FT)

OAM Type	dir	MI_Enable	MI_Start ()						MIs for retrieval			
			MAC		ID		Length	Period	Pri	MI_Terminate	MI_Intermediate_Request	MI_Result()
			DA	SA	Test	MEP						
LM	So	(*1)	✓		(*3)		(*5)	✓	✓	✓	✓	✓ (N_TF, N_LF, F_TF, F_LF)
	Sk	(*1)										
1SL	So		✓		✓		✓	✓	✓	✓		
	Sk			✓ (*2)	✓ (*4)				✓	✓		✓ (N_TF, N_LF)
SL	So		✓		✓		✓	✓	✓	✓		✓ (N_TF, N_LF, F_TF, F_LF)
	Sk											
1DM	So		✓		✓		✓	✓	✓			
	Sk			✓ (*2)	✓				✓	✓		✓ (count, N_FD[])
DM	So		✓		✓		✓	✓	✓	✓		✓ (count, B_FD[], F_FD[], N_FD[])
	Sk											

Table I.2 – MI signals/parameters for on-demand PM (ETHDe_FT)

NOTES:

*1 MI_Enable is no longer used to allocate the counter resources for loss measurement. Note that the latest [ITU-T G.8021] has removed MI signals for the allocation of the local counter resources.

*2 The parameter 'SA' for MI_{1SL,1DM}_Start() is used to verify that the received PDU is properly sent from the expected peer node.

*3 The parameter 'Test_ID' for MI_LM_Start() is not specified in LM until now.

*4 The parameter 'MEP_ID' for MI_1SL_Start() was removed during [ITU-T G.8021] v4 AAP because MEP_ID carried in PDU is not evaluated at sink side.

*5 The parameter 'Length' is not applicable for CC/LM because the length of both PDUs is always fixed

ITU-T Y-SERIES RECOMMENDATIONS

GLOBAL INFORMATION INFRASTRUCTURE, INTERNET PROTOCOL ASPECTS, NEXT-GENERATION NETWORKS, INTERNET OF THINGS AND SMART CITIES

GLOBAL INFORMATION INFRASTRUCTURE	
General	Y.100–Y.199
Services, applications and middleware	Y.200–Y.299
Network aspects	Y.300–Y.399
Interfaces and protocols	Y.400–Y.499
Numbering, addressing and naming	Y.500–Y.599
Operation, administration and maintenance	Y.600–Y.699
Security	Y.700–Y.799
Performances	Y.800–Y.899
INTERNET PROTOCOL ASPECTS	
General	Y.1000–Y.1099
Services and applications	Y.1100–Y.1199
Architecture, access, network capabilities and resource management	Y.1200–Y.1299
Transport	Y.1300–Y.1399
Interworking	Y.1400–Y.1499
Quality of service and network performance	Y.1500–Y.1599
Signalling	Y.1600–Y.1699
Operation, administration and maintenance	Y.1700–Y.1799
Charging	Y.1800–Y.1899
IPTV over NGN	Y.1900–Y.1999
NEXT GENERATION NETWORKS	
Frameworks and functional architecture models	Y.2000–Y.2099
Quality of Service and performance	Y.2100–Y.2199
Service aspects: Service capabilities and service architecture	Y.2200–Y.2249
Service aspects: Interoperability of services and networks in NGN	Y.2250–Y.2299
Enhancements to NGN	Y.2300–Y.2399
Network management	Y.2400–Y.2499
Network control architectures and protocols	Y.2500–Y.2599
Packet-based Networks	Y.2600–Y.2699
Security	Y.2700–Y.2799
Generalized mobility	Y.2800–Y.2899
Carrier grade open environment	Y.2900–Y.2999
FUTURE NETWORKS	Y.3000–Y.3499
CLOUD COMPUTING	Y.3500–Y.3999
INTERNET OF THINGS AND SMART CITIES AND COMMUNITIES	
General	Y.4000–Y.4049
Definitions and terminologies	Y.4050–Y.4099
Requirements and use cases	Y.4100–Y.4249
Infrastructure, connectivity and networks	Y.4250–Y.4399
Frameworks, architectures and protocols	Y.4400–Y.4549
Services, applications, computation and data processing	Y.4550–Y.4699
Management, control and performance	Y.4700–Y.4799
Identification and security	Y.4800–Y.4899
Evaluation and assessment	Y.4900–Y.4999

For further details, please refer to the list of ITU-T Recommendations.

SERIES OF ITU-T RECOMMENDATIONS

Series A	Organization of the work of ITU-T
Series D	Tariff and accounting principles and international telecommunication/ICT economic and policy issues
Series E	Overall network operation, telephone service, service operation and human factors
Series F	Non-telephone telecommunication services
Series G	Transmission systems and media, digital systems and networks
Series H	Audiovisual and multimedia systems
Series I	Integrated services digital network
Series J	Cable networks and transmission of television, sound programme and other multimedia signals
Series K	Protection against interference
Series L	Environment and ICTs, climate change, e-waste, energy efficiency; construction, installation and protection of cables and other elements of outside plant
Series M	Telecommunication management, including telecommunication network management and network maintenance
Series N	Maintenance: international sound programme and television transmission circuits
Series O	Specifications of measuring equipment
Series P	Telephone transmission quality, telephone installations, local line networks
Series Q	Switching and signalling, and associated measurements and tests
Series R	Telegraph transmission
Series S	Telegraph services terminal equipment
Series T	Terminals for telematic services
Series U	Telegraph switching
Series V	Data communication over the telephone network
Series X	Data networks, open system communications and security
Series Y	Global information infrastructure, Internet protocol aspects, next-generation networks, Internet of Things and smart cities
Series Z	Languages and general software aspects for telecommunication systems