



INTERNATIONAL TELECOMMUNICATION UNION

ITU-T

TELECOMMUNICATION
STANDARDIZATION SECTOR
OF ITU

G.806

Amendment 1
(06/2011)

SERIES G: TRANSMISSION SYSTEMS AND MEDIA,
DIGITAL SYSTEMS AND NETWORKS

Digital networks – General aspects

Characteristics of Transport Equipment –
Description Methodology and Generic Functionality

Amendment 1

CAUTION !

PREPUBLISHED RECOMMENDATION

This prepublication is an unedited version of a recently approved Recommendation. It will be replaced by the published version after editing. Therefore, there will be differences between this prepublication and the published version.

FOREWORD

The International Telecommunication Union (ITU) is the United Nations specialized agency in the field of telecommunications, information and communication technologies (ICTs). The ITU Telecommunication Standardization Sector (ITU-T) is a permanent organ of ITU. ITU-T is responsible for studying technical, operating and tariff questions and issuing Recommendations on them with a view to standardizing telecommunications on a worldwide basis.

The World Telecommunication Standardization Assembly (WTSA), which meets every four years, establishes the topics for study by the ITU-T study groups which, in turn, produce Recommendations on these topics.

The approval of ITU-T Recommendations is covered by the procedure laid down in WTSA Resolution 1.

In some areas of information technology which fall within ITU-T's purview, the necessary standards are prepared on a collaborative basis with ISO and IEC.

NOTE

In this Recommendation, the expression "Administration" is used for conciseness to indicate both a telecommunication administration and a recognized operating agency.

Compliance with this Recommendation is voluntary. However, the Recommendation may contain certain mandatory provisions (to ensure, e.g., interoperability or applicability) and compliance with the Recommendation is achieved when all of these mandatory provisions are met. The words "shall" or some other obligatory language such as "must" and the negative equivalents are used to express requirements. The use of such words does not suggest that compliance with the Recommendation is required of any party.

INTELLECTUAL PROPERTY RIGHTS

ITU draws attention to the possibility that the practice or implementation of this Recommendation may involve the use of a claimed Intellectual Property Right. ITU takes no position concerning the evidence, validity or applicability of claimed Intellectual Property Rights, whether asserted by ITU members or others outside of the Recommendation development process.

As of the date of approval of this Recommendation, ITU [had/had not] received notice of intellectual property, protected by patents, which may be required to implement this Recommendation. However, implementers are cautioned that this may not represent the latest information and are therefore strongly urged to consult the TSB patent database at <http://www.itu.int/ITU-T/ipr/>.

© ITU 2011

All rights reserved. No part of this publication may be reproduced, by any means whatsoever, without the prior written permission of ITU.

Recommendation ITU-T G.806 (2009) Amendment 1

Characteristics of Transport Equipment – Description Methodology and Generic Functionality

Amendment 1

Summary

Amendment 1 to Recommendation ITU-T G.806 (2009) provides:

- Updates in clause 5 which covers functions defined in G.798 and G.8021 in generic.
- Updates clause 6.2 and 6.5 which cover the defects and parameters' description in G.783.
- G.798, G.8021 and G.7710 in generic.
- Update in Client-specific GFP-T source processe. RAdisable is defined.
- Updates the clause 2, 3 and 4 according to the updates in clause 5 and 6.
- Updated Appendix I and new Appendix IX are also included.

Recommendation ITU-T G.806 (2009) Amendment 1

Characteristics of Transport Equipment – Description Methodology and Generic Functionality

Amendment 1

1) Clause 2

Update following references in this clause as below:

- [ITU-T G.709] Recommendation ITU-T G.709/Y.1331 (~~2003~~2009), *Interfaces for the Optical Transport Network (OTN)*.
- [ITU-T G.781] Recommendation ITU-T G.781 (~~1999~~2008), *Synchronization layer functions*.
- [ITU-T G.798] Recommendation ITU-T G.798 (~~2006~~2010), *Characteristics of optical transport network hierarchy equipment functional blocks*.
- [ITU-T G.808.1] Recommendation ITU-T G.808.1 (~~2006~~2010), *Generic protection switching – Linear trail and subnetwork protection*.
- [ITU-T G.7710] Recommendation ITU-T G.7710/Y.1701 (~~2010~~04), *Common equipment management function requirements*.
- [ITU-T G.8010] Recommendation ITU-T G.8010/Y.1306 (2004), *Architecture of Ethernet layer networks*
- [ITU-T G.8021] Recommendation ITU-T G.8021/Y.1341 (2010), *Characteristics of Ethernet transport network equipment functional block*.
- [ITU-T G.842] Recommendation ITU-T G.842 (1997), *Interworking of SDH network protection architectures*.
- [ITU-T I.732] Recommendation ITU-T I.732 (2000), *Functional characteristics of ATM equipment*.
- [ITU-T M.125] Recommendation ITU-T M.125 (1988), *Digital loopback mechanisms*.

2) Clause 3

Add following terminologies to clauses 3.1 and 3.2 respectively

- 3.1.aa flow termination:** [ITU-T G.8021]
- 3.1.cc termination flow point:** [ITU-T G.8021]
- 3.1.dd traffic conditioning function:** [ITU-T G.8001]
- 3.1.ee maintenance entity:** [ITU-T G.8001]
- 3.1.ff maintenance entity group:** [ITU-T G.8001]
- 3.1.gg MEG End Point (MEP) :** [ITU-T G.8001]
- 3.1.hh MEG Intermediate Point (MIP) :** [ITU-T G.8001]

3.2.xx protection information (PI): The information passing across a protection point

3.2.yy protection point (PP): A reference point where the output of a trail termination sink function of a bidirectional trail termination is bound to the input of its trail termination source function for the purpose of conveying information to the protection end

3.2.zz Replication information (PI): The information delivered across a replication point

3.2.ww Replication point (PP): A reference point between adaptation source and sink. Characteristic information from source flow point is replicated and delivered across flow replication point to termination flow point

3) Clause 4

Add following abbreviations to this clause as below:

APS	Automatic Protection Switch
COMMS	Communication access
COMMS_AC	COMMS access function
D_FT	Diagnostic Flow Termination
D_TT	Diagnostic Trail Termination
DE	Drop Eligible
ETCn	Ethernet physical coding sublayer
ETH	Ethernet VLAN
ETYn	Ethernet physical
FDI	Forward Defect Indication
FOP-CM	Failure Of Protocol Configuration Mismatch
FOP-NR	Failure Of Protocol No Response
FOP-PM	Failure Of Protocol Provisioning Mismatch
FOP-TO	Failure Of Protocol Timeout
FP	Flow Point
FT	Flow Termination
LBC	Lost Block Count
LCK	Locked
LOC	Loss Of Continuity
ME	Maintenance Entity
MEG	Maintenance Entity Group
MEP	Maintenance Entity Group End Point
MIP	Maintenance Entity Group Intermediate Point
MMG	Mismerge
NCM	Network Connection Monitoring
OCh	OTN optical channel

ODU	OTN optical channel data unit
OMS _n	OTN optical multiplex section
OPS _n	OTN optical physical section
OTS _n	OTN optical transmission section
OTU	OTN optical channel transport unit
P	Priority
PI	Protection reference point information
PI	Replication information
PP	Protection reference point
PP	Replication Point
TCS	Traffic Conditioning & Shaping
TFP	Termination Flow Point
UNP	Unexpected Priority
UNPr	Unexpected Period
VC	ATM virtual channel
VP	ATM virtual path

4) **Clause 5.1**

Update clause 5.1 as below:

The methodology to describe transport network functionality of network elements is based on the generic functional architecture of transport networks, the architectural entities and transport processing functions defined in [ITU-T G.805].

The functionality of transport processing functions within network elements is represented by atomic functions for each layer of the transport network and a set of combination rules for these functions. The basic set of atomic functions of a layer is shown in Figure 5-1 and consists of:

- Trail and flow termination function.
- Adaptation function.
- Connection functions.

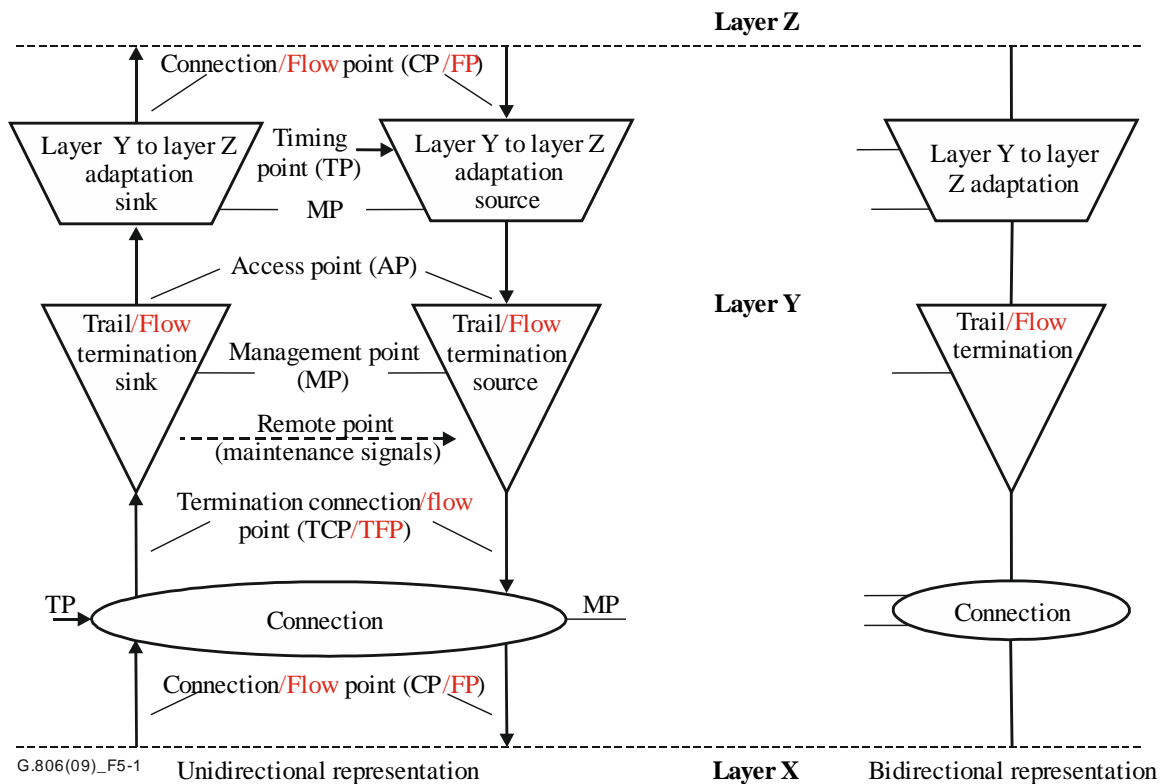

Figure 5-1 – Atomic functions and reference points

The interworking atomic function shown in Figure 5-2 is used for the special application of interworking between two network layers with similarly characteristic information.

The diagrammatic convention for a communication access (COMMS) atomic function is shown in Figure 5-A. The COMMS function provides access at intermediate connection points along a connection to general purpose communication channels.

The diagrammatic convention for a traffic conditioning & shaping (TCS) atomic function is shown in Figure 5-B. The TCS sink function provides the traffic conditioning process. The TCS source function provides the shaping process.

An atomic function is described by the processes within the function, its reference points and the information flow via these reference points.

<..>

5) Clause 5.2

Update Table 5-1 in this clause as below:

Table 5-1 – Transmission layers

Name	Layer	Defined in
OSn	STM-n optical section	[ITU-T G.783]
ES1	STM-1 electrical section	[ITU-T G.783]
RSn	STM-n regenerator section	[ITU-T G.783]
MSn	STM-n multiplex section	[ITU-T G.783]
MSnP	STM-n multiplex section protection sublayer	[ITU-T G.783]
Sn	SDH VC-n path layer	[ITU-T G.783]
SnP	SDH VC-n trail protection sublayer	[ITU-T G.783]
SnD	SDH VC-n TCM option 2 sublayer	[ITU-T G.783]
SnT	SDH VC-n TCM option 1 sublayer	[ITU-T G.783]
Eq	PDH electrical section	[ITU-T G.705]
Pqe	Plesiochronous framed PDH layer	[ITU-T G.705]
Pqs	Synchronous framed PDH layer	[ITU-T G.705]
Pqx	Unframed PDH layer	[ITU-T G.705]
NS	Network synchronization layer	[ITU-T G.781]
SD	Synchronization distribution layer	[ITU-T G.781]
<u>VC</u>	<u>ATM virtual channel</u>	<u>[ITU-T I.732]</u>
<u>VP</u>	<u>ATM virtual path</u>	<u>[ITU-T I.732]</u>
<u>ODU</u>	<u>OTN optical channel data unit</u>	<u>[ITU-T G.798]</u>
<u>OTU</u>	<u>OTN optical channel transport unit</u>	<u>[ITU-T G.798]</u>
<u>OCh</u>	<u>OTN optical channel</u>	<u>[ITU-T G.798]</u>
<u>OMSn</u>	<u>OTN optical multiplex section</u>	<u>[ITU-T G.798]</u>
<u>OTSn</u>	<u>OTN optical transmission section</u>	<u>[ITU-T G.798]</u>
<u>OPSn</u>	<u>OTN optical physical section</u>	<u>[ITU-T G.798]</u>
<u>ETH</u>	<u>Ethernet VLAN</u>	<u>[ITU-T G.8021]</u>
<u>ETYn</u>	<u>Ethernet physical</u>	<u>[ITU-T G.8021]</u>
<u>ETCn</u>	<u>Ethernet physical coding sublayer</u>	<u>[ITU-T G.8021]</u>

6) Clause 5.3

Update clause 5.3 as below:

5.3 Atomic function naming and diagrammatic conventions

The naming of adaptation, trail and flow termination and connection functions follow the following rules:

Adaptation function <layer>/<client layer>_A[_<direction>]

Trail termination function <layer>_TT[_<direction>]

Flow termination function <layer> FT[_<direction>]

Tandem connection trail termination function <layer>T TT[_<direction>]

Diagnostic trail termination function <layer>D TT[_<direction>]

~~Diagnostic trail termination function <layer>D TT[_<direction>]~~

Diagnostic flow termination function <layer>D_FT[_<direction>]

Connection function <layer>_C

Layer network interworking function <layer>[<>/>/<]<layer>[(set of accepted client layers X)]_I

Communication access function <layer>/COMMS AC[_<direction>]

Traffic conditioning and shaping function <layer> TCS <direction>]

Examples are: MS1/S4_A, S12/P12s_A_So, S4_TT, RS16_TT_Sk, S3_C, ETH_FT, ETY/ETH_A.

The diagrammatic conventions and nomenclature for adaptation, termination, ~~and~~ connection and layer interworking functions (used to describe the atomic functions) are shown in Figure 5-3.

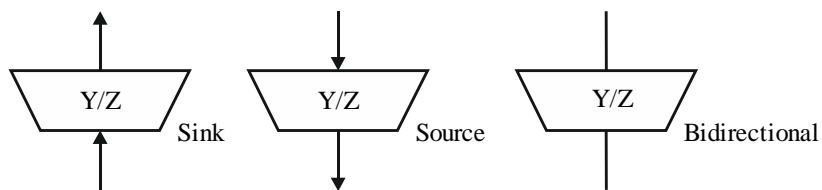

a) Adaptation functions from server layer Y to client layer Z

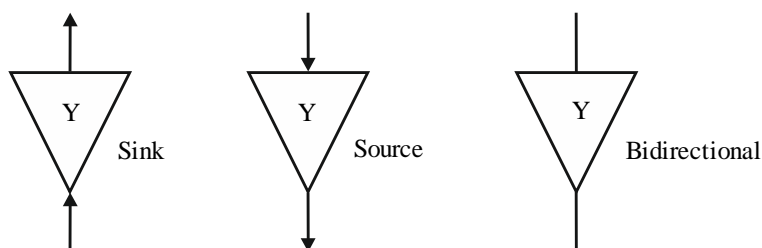

b) Trail/Flow termination functions in layer Y

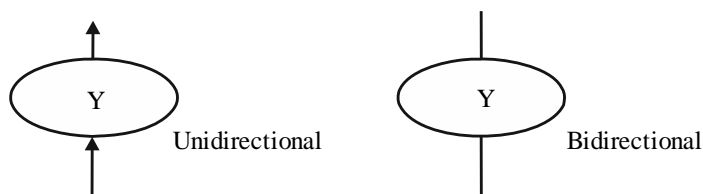

c) Connection functions in layer Y

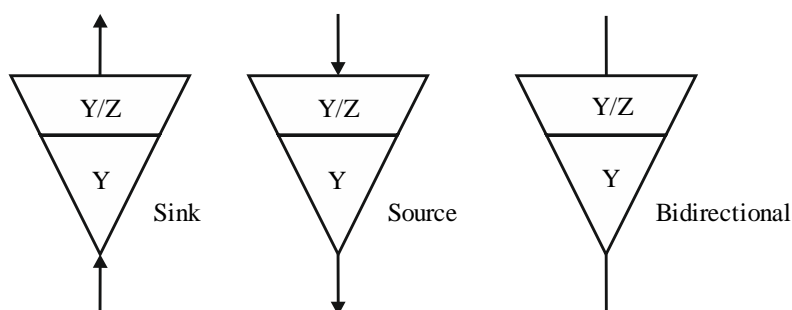

d) Trail/Flow termination function in layer Y and adaptation function to layer Z

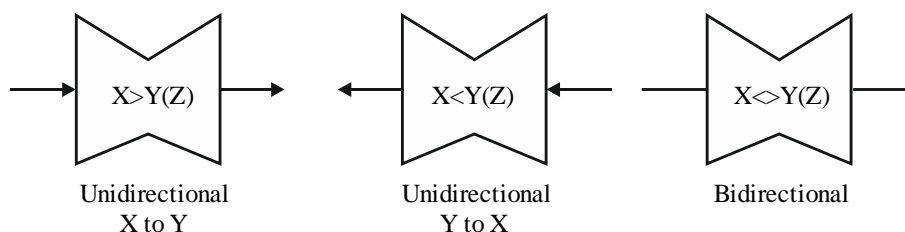

e) Interworking function between layer X and layer Y

NOTE 1 – If the above symbols are used for generic figures, i.e., not for specific layers, the layer references Y and Z may be omitted. Alternatively, the references may be to the type of function or layer, e.g., supervision, protection.

NOTE 2 – The order of the layers in the name of an interworking function can be changed (e.g., X>Y is identical to Y<X).

G.806(09)_F5-3

Figure 5-3 – Symbols and diagrammatic conventions

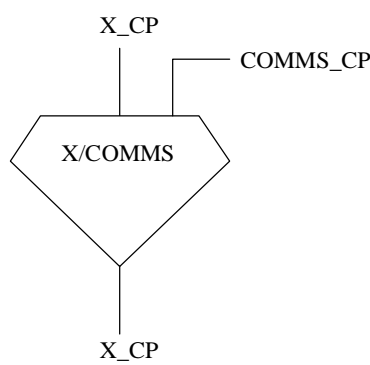

Figure 5-A – Diagrammatic convention for communication access function

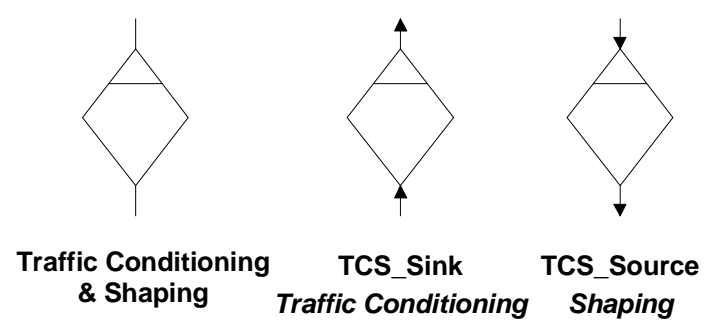

Figure 5-B – Diagrammatic convention for traffic conditioning & shaping function

<..>

7) Clause 5.4

Update clause 5.4 and 5.4.1 as below:

5.4 Reference point naming

The atomic functions are defined between fixed reference points at which defined information is assumed to be present. That is, at a given reference point, specific types of information can always be assumed to be present. There are several different types of reference points within the functional model, including reference points for:

- Transmission signals.
- Management information.
- Timing references.
- Remote information.
- Protection information.
- Replication information.

5.4.1 Transmission reference points

Because they are so numerous, and their detailed characteristics are so important to the functional model, transmission reference points are designated with a more complex naming convention. A

transmission reference point name is formed by a transmission layer designation, followed by an underscore character, followed by either AP or CP or FP, depending on whether that reference point is an access point (AP) or a connection/flow point (CP/FP). As described in [ITU-T G.805], the information at an access point is a signal into which the client signal(s) has been mapped, but which does not include the full complement of overhead or OAM information for the given layer. The information at a connection/flow point is a signal that includes the full complement of overhead or OAM information. The access point is at the server side of adaptation functions and the client side of termination functions. The connection/flow point is at the client side of adaptation functions and the server side of termination functions (Figure 5-1). Thus, a transmission reference point name is formed according to the syntax:

<TransmissionReferencePointName> = <LayerName>_<AP or CP or FP>

<TransmissionReferencePointNameDiagnostic> = <LayerName>D_<AP>

<TransmissionReferencePointNameTandem> = <LayerName>T_<AP>

Connection and flow points represent the same type of reference points in two types of layer networks. The term connection point is used in layer networks which support uni- and bi-directional 2-port point-to-point and n-port (n>2) uni-directional point-to-multipoint connections, in which the forwarding of information applied at the input port is performed by means of broadcasting/flooding that information towards all output ports with the exception of the output port associated with the input port. The term flow point is used in layer networks which support besides the uni- and bi-directional 2-port point-to-point and n-port (n>2) uni-directional point-to-multipoint connections also bi-directional n-port (n>2) rooted-multipoint and n-port (n>2) multipoint-to-multipoint connections, in which the forwarding of information applied at one of the input ports is performed by means of either unicasting towards a single output port, multicasting towards a subset of the output ports, or broadcasting/flooding that information towards all output ports (with the exception of the output port associated with the input port).

Create clause 5.4.5 and 5.4.6 as below:

5.4.5 Protection reference points

Protection reference points are named directly after the name of the associated layer according to the syntax:

<ProtectionReferencePointName> = <LayerName>_PP

Thus, for example, the protection reference point for the ODU layer is named ODU_PP. The protection reference point is used to transport automatic protection switch (APS) information between a layer's connection function and its server adaptation function in the case of compound link subnetwork connection group protection with inherit monitoring (CL-SNCG/I).

5.4.6 Replication reference points

Replication reference points are named directly after the name of the associated layer according to the syntax:

<ReplicationReferencePointName> = <LayerName>_PP

8) Clause 5.5

Update clause 5.5.1 as below:

5.5.1 Transmission reference point information naming

The coding of the characteristic information (CI) and adapted information (AI) in the model follows the following rules:

	<layer>_<information type>_<signal type>[/<number>].
[...]	optional term
<layer>	represents one of the layer names (e.g., RS1)
<information type>	CI or AI
<signal type>	CK (clock), or D (data), or FS (frame start), or SSF (server signal fail), or TSF (trail signal fail), or SSD (server signal degrade), or TSD (trail signal degrade), <u>or</u> <u>APS (automatic protection switch), or</u> <u>P (priority), or</u> <u>DE (drop eligible)</u>
<number>	indication of multiplex/inverse multiplex number; e.g., (1,1,1) for the case of a TU-12 within a VC-4

AI and CI coding examples are: MS1_CI_D, RS16_AI_CK, P12x_AI_D, S2_AI_So_D(2,3,0).

Within the network each access point is uniquely identified by means of its access point identifier (API) (see [ITU-T G.831]). The termination connection/flow point (TCP/TFP) (see Figure 5-1), can be uniquely identified by means of the same API. The connection/flow point (CP/FP) (see Figure 5-1), can be uniquely identified by the API extended with the multiplex number, e.g., the AU or TU number, the VPI or VCI, or the VLAN ID, the VPI or VCI, or the VLAN ID.

Example: a VC12 CP (S12_CP) can be identified by means of the API of the S4_AP, extended with the TU12 TUG number (K,L,M) and an ETH FP (ETH_FP) can be identified by means of the API of the ETH AP, extended with the VLAN Identifier (VID).

Create clause 5.5.5 and 5.5.6 as below:

5.5.5 Protection reference point information naming

The coding of the PI signals follows the following rule:

<layer>_PI_<PI signal type: APS>

5.5.6 Replication reference point information naming

The coding of the PI signals follows the following rule:

<layer>_PI_<PI signal type: D, DE, P>

9) Clause 5.6

Update clause 5.6.1, 5.6.2 and 5.6.3 as below:

5.6.1 Connection function

The connection function provides flexibility within a layer. It may be used by the network operator to provide routing, grooming, protection and restoration.

The model describes the connection function as a space switch that provides connectivity between its inputs and outputs. Connections might be set up, modified or turned down based on management commands via the MI interface. A connection is supported by a flow forwarding (FF) process. Multiple types of flow forwarding processes are illustrated in Appendix iX.

The connectivity between inputs and outputs of the connection function might be limited due to implementation constraints. Several examples are given in Appendix I.

<..>

5.6.2 Trail termination function

The trail termination function performs the signal integrity supervision of the layer. This includes:

- connectivity supervision;
- continuity supervision;
- signal quality supervision;
- processing of maintenance information (forward/backward indications).

In the source direction, it generates and adds some or all of the following:

- error detection code or forward error indication (e.g., bit interleaved parity (BIP), cyclic redundancy check (CRC), incoming error count);
- frame or packet loss measurement information;
- synthetic frame or packet loss measurement information;
- frame or packet delay and delay variation measurement information;
- trail trace identifier (i.e., source address);
- maintenance entity group identifier;
- maintenance entity group end point identifier;

It conveys back the following remote information:

- remote error indicator signal (e.g., REI, OEI, E-bit), containing the number of detected error detection code violations in the received signal;
- remote defect indicator signal (e.g., RDI, ODI, A-bit), representing the defect status of the received signal;
- remote frame or packet loss measurement information;
- remote synthetic frame or packet loss measurement information;
- remote frame or packet delay and delay variation measurement information.

In the sink direction, it monitors for some or all of the following:

- signal quality (e.g., bit errors);

- (mis-)connection;
- near-end performance;
- far-end performance;
- server signal fail (i.e., alarm indication signal (AIS) instead of data);
- signal loss (disconnection, idle signal, unequipped signal).

NOTE – Functionality is reduced in the physical section layer termination functions, which can only monitor the signal loss. In addition, the physical section termination source function performs logical/optical or logical/electrical conversion. In addition, the physical section termination sink function performs optical/logical or electrical/logical conversion.

Bit errors are detectable via line code violations, parity violations or CRC violations; i.e., error detection code violations. Frame or packet loss is detectable via comparison of transmitted frame or packet count and received frame or packet count information. Synthetic frame or packet loss is detectable via comparison of transmitted synthetic frame or packet identifiers and received synthetic frame or packet identifiers. Frame or packet delay is detectable via comparison of transmitted frame or packet timestamps and received frame or packet timestamps.

5.6.3 Adaptation function

An adaptation function represents the conversion process between server and client layers. One or more of the following processes may be present in an adaptation function:

- scrambling/descrambling;
- encoding/decoding;
- alignment (framing, pointer interpretation, FAS/PTR generation);
- bit rate adaptation;
- frequency justification;
- time slot/wavelength assignment/access;
- multiplexing/demultiplexing;
- timing recovery;
- smoothing;
- payload type identification;
- payload composition selection;-
- administrative locking;
- forward error correction;
- port identification.

<..>

Many layers are able to transport a variety of client signals applied to the layer via different adaptation functions. To monitor the provisioning process, the source adaptation inserts the appropriate code in the trail signal label (TSL). The sink adaptation will check the **composition of the payload**, comparing the received TSL number with its own.

The **administrative locking** process controls the forwarding of the characteristic information signals in an adaptation function depending on the administrative state (refer to X.731). Forwarding of characteristic information is blocked when the administrative state is LOCKED and forwarding

is enabled when the administrative state is UNLOCKED. In a locked condition, the LCK maintenance signal replaces the client's characteristic information.

The **forward error correction** process is a coding process which adds redundancy to the transmitted characteristic information using a predetermined algorithm such that the redundancy added by the coding allows the decoding to detect and correct a limited number of bit errors.

The **port identification** process adds source and destination port identifiers (typically referred to as addresses) to the adapted characteristic information to control delivery of this information to the intended subset of ports on a multipoint connection.

10) Clause 5.7

Update clause 5.7.2, 5.7.3 and 5.7.7 as below:

5.7.2 Binding at connection/flow points

The connection/flow point input (output) of an adaptation function may be bound to the connection/flow point output (input) of either a connection function, layer network interworking function or an adaptation function. The connection/flow point of a layer network interworking function may be bound to the connection/flow point of either a connection function or an adaptation function, as shown in Figure 5-8.

Example: An S12_CP of an S12_C function may be connected to an S12_CP of an S4/S12_A function.

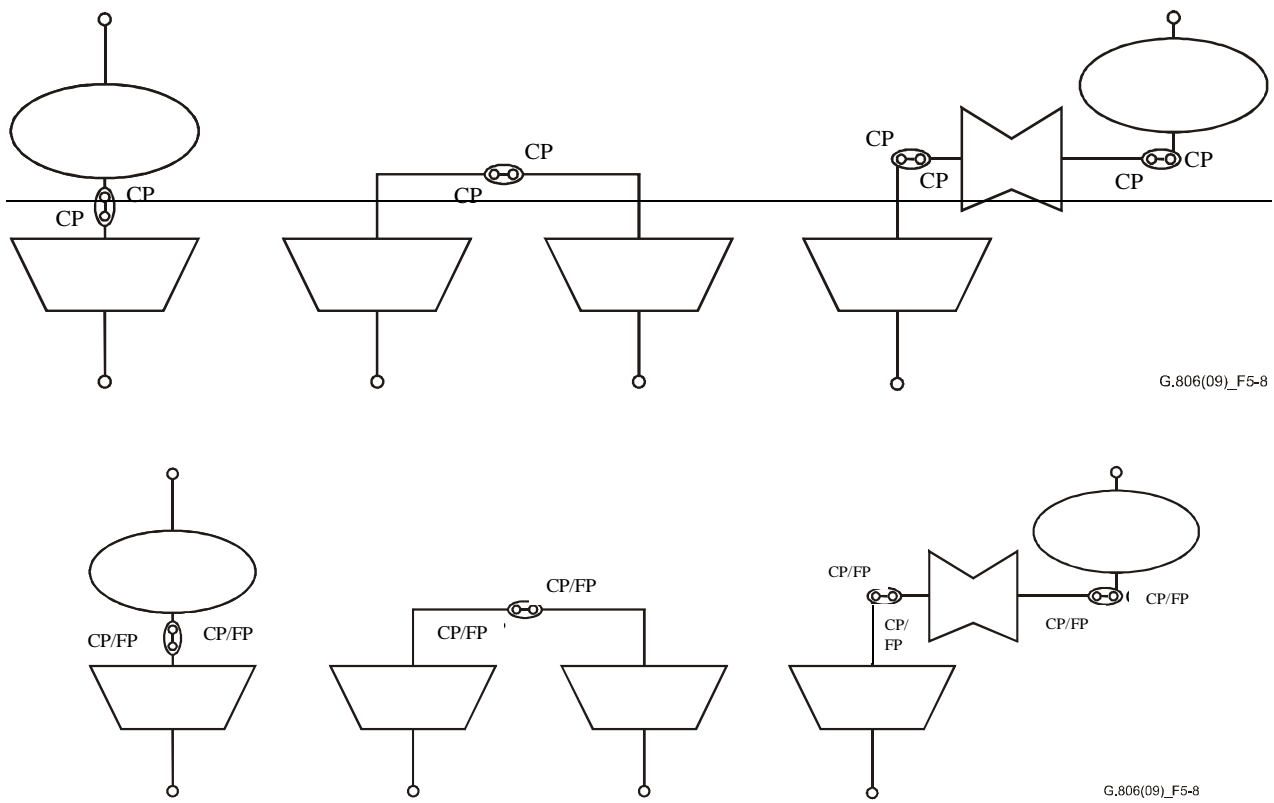

Figure 5-8 – Binding of connection/flow points (CP-CP binding)

5.7.3 Binding at (termination) connection/flow points

The termination connection/flow point output (input) of a trail termination function may be bound to the connection/flow point input (output) of either an adaptation function, layer network interworking function or a connection function or the termination connection/flow point input (output) of a trail termination function, as shown in Figure 5-9.

NOTE – Once bound, the CP/FP and TCP/TFP are referred to as a termination connection/flow point.

Example: An S12_TCP of an S12_TT function may be connected to an S12_CP of an S12_C function.

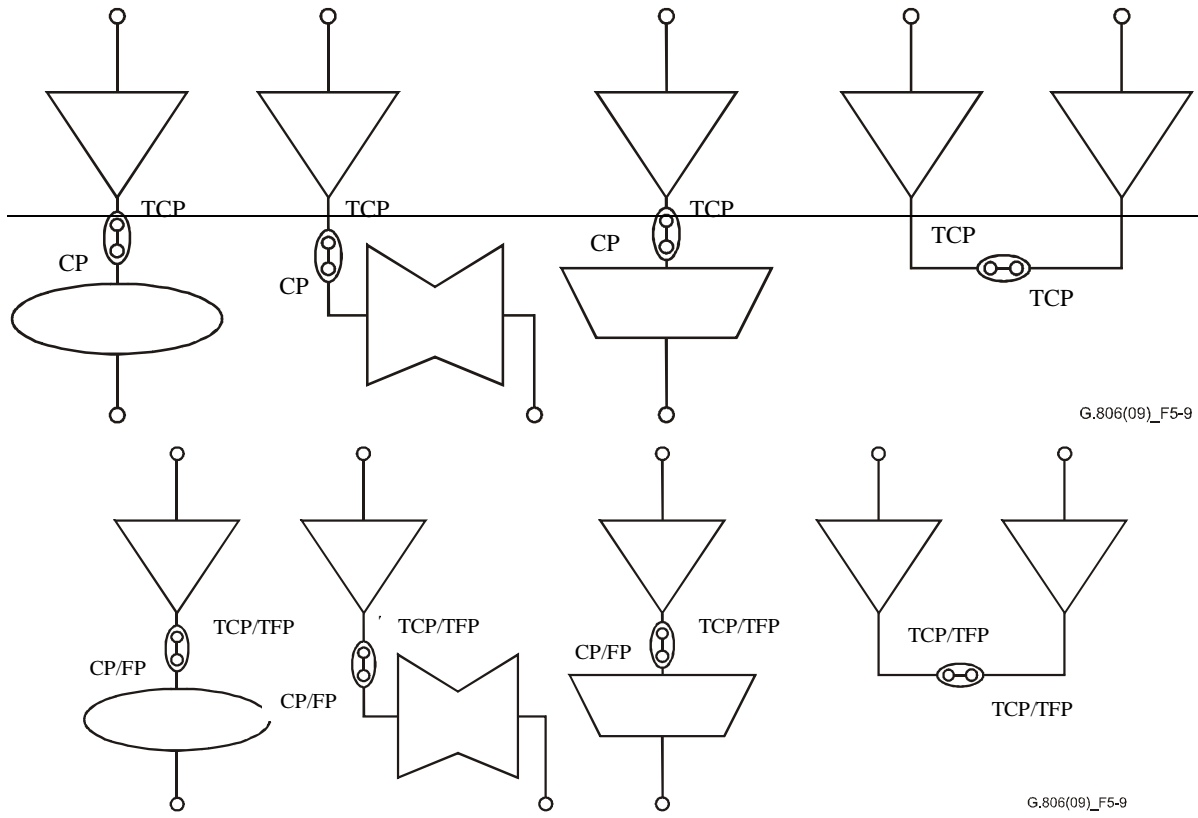

Figure 5-9 – Binding involving a termination of connection/flow points (TCP-CP/TFP-FP and TCP-TCP/TFP-FP binding)

5.7.7 Compound functions

Combinations of atomic functions in one or more layer(s) may be identified by a special symbol, a compound function. Three examples are shown in Figures 5-12, 5-13 and 5-14.

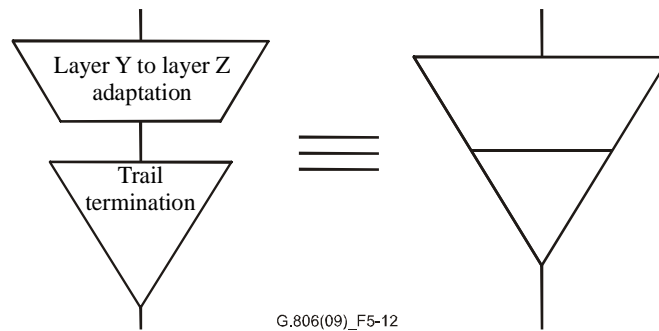

Figure 5-12 – Compound termination/adaptation function

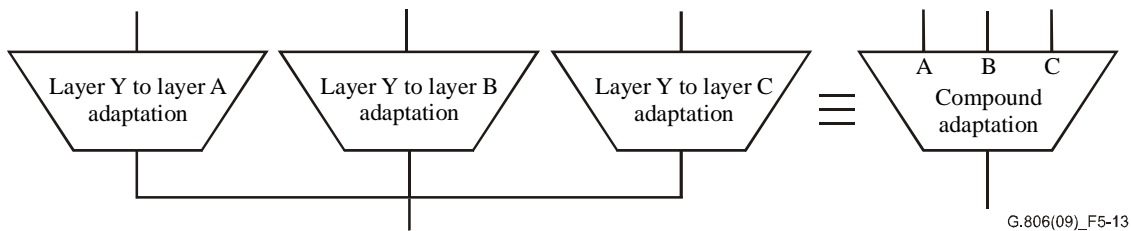

Figure 5-13 – Compound adaptation function

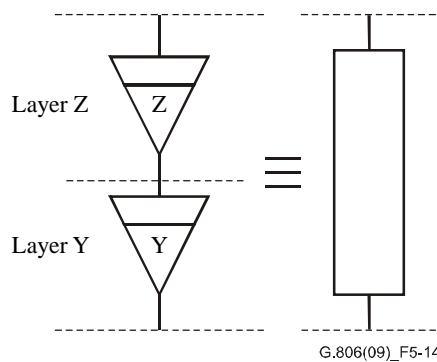

Figure 5-14 – Compound function spanning multiple layers

The diagrammatic conventions for NCM MEG End Point (NCM MEP) compound functions are shown in Figure 5-J. NCM MEP functions may either have a single termination connection/flow port and access port (left) or multiple termination connection/flow ports and multiple access ports (right).

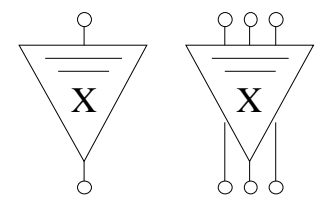

Figure 5-L – Diagrammatic convention for NCM MEP compound functions

The diagrammatic conventions for TCM MEG End Point (TCM MEP) compound functions are shown in Figure 5-K. TCM MEP functions may either have a single termination connection/flow port and access port (left) or multiple termination connection/flow ports and multiple access ports (right).

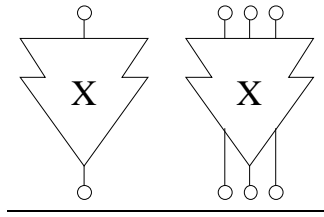

Figure 5-K – Diagrammatic convention for TCM MEP compound functions

The diagrammatic conventions for MEG Intermediate Point (MIP) compound functions are shown in Figure 5-L. The MIP compound functions consists of two pairs of the diagnostic adaptation & trail/flow termination functions, each facing in opposite directions. MIP functions may either have a single connection/flow port (left) or multiple connection/flow ports (right).

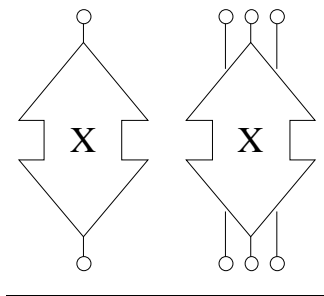

Figure 5-L – Diagrammatic convention for MEG Intermediate Point (MIP) compound functions

A variant of the MIP compound function is the half MIP compound function, which consists of a single pair of the diagnostic adaptation & trail/flow termination functions (Figure 5-M). Half MIP functions may either have a single connection/flow port (left) or multiple connection/flow ports (right).

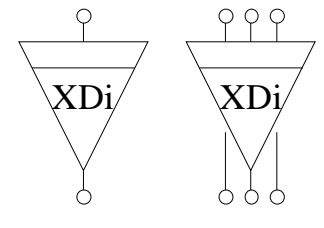

Figure 5-M – Half MIP compound functions

11) Clause 6.2

Update clause 6.2.1.2 as below:

6.2.1.2 Loss Of Signal defect (dLOS)

LOS signal supervision is used at the physical layer. For the specific detection processes refer to the Recommendations for the specific hierarchies ([ITU-T G.783], [ITU-T G.705], ~~and~~[ITU-T G.781], ~~and~~[ITU-T G.798], and [ITU-T G.8021]).

Create clause 6.2.1.4 as below:

6.2.1.4. Loss of Continuity defect (dLOC)

The Loss of Continuity defect is calculated at a network layer. It monitors the presence of continuity in trails.

Its detection and clearance are defined in Figure 6-x. The 'period' in Figure 6-x is the period as carried in the CC (Continuity check) frame triggering the expCC event that means reception of a CC frame.

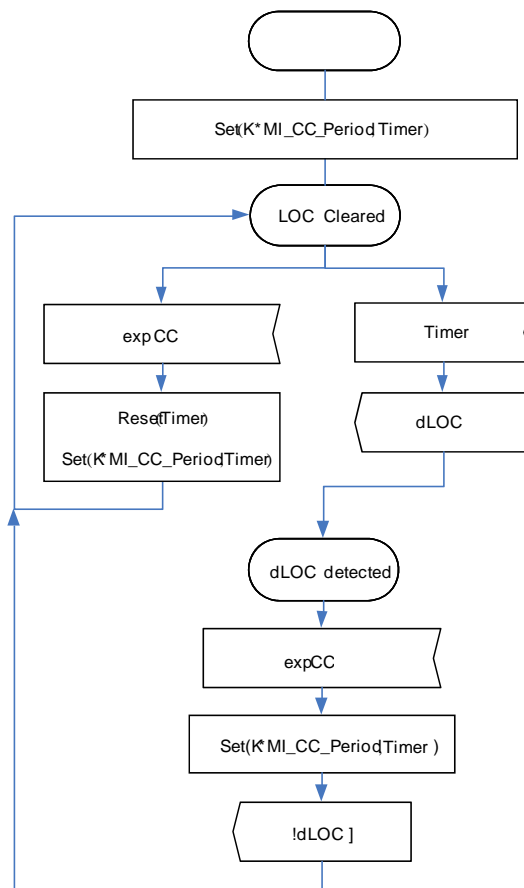

Figure 6-x – dLOC detection and clearance process

Create clauses 6.2.2.3, 6.2.2.4, and 6.2.2.5 as below:

6.2.2.3 Mismerge defect (dMMG)

The Mismerge defect is calculated at defect is calculated at the layer where MEG (Maintenance Entity Group) and MEP ((MEG) End Point) define. It monitors the connectivity in a Maintenance Entity Group.

Its detection and clearance are defined in Figure 6-y. The <Defect> in Figure 6-2 is dMMG. The <Event> in Figure 6-2 is the Mismerge defect event as generated by the continuous check frame reception process and the Period is the Period carried in the frame that triggered the event, unless an earlier continuous check frame triggering an MMG event carried a greater period.

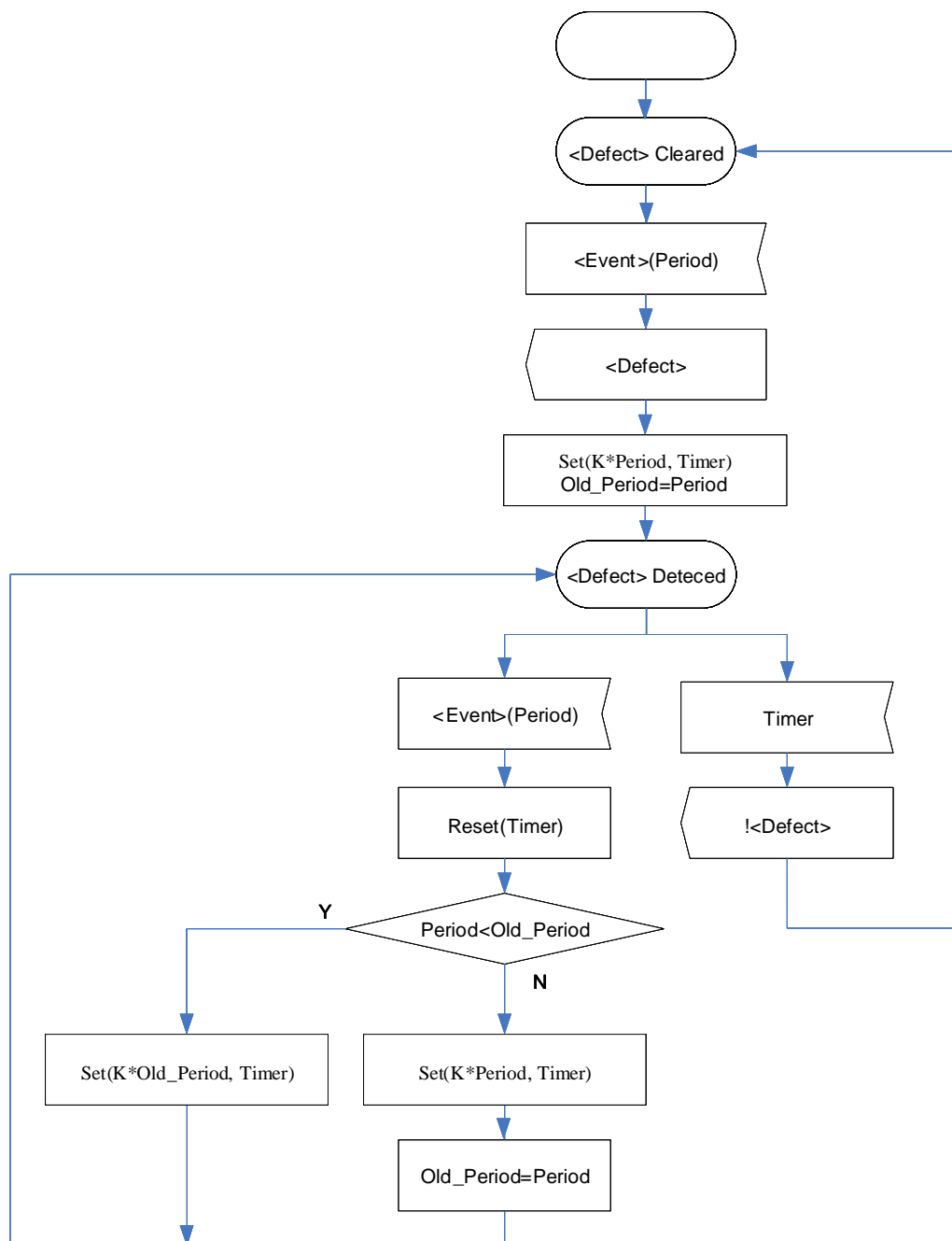

Figure 6-y – Defect detection and clearance process

6.2.2.4 Unexpected MEP defect (dUNM)

The Unexpected MEP (Maintenance Entity Group (MEG) End Point) defect is calculated at the layer where MEG and MEP define. It monitors the connectivity in a Maintenance Entity Group.

Its detection and clearance are defined in Figure 6-y. The <Defect> in Figure 6-y is dUNM. The <Event> in Figure 6-y is the Unexpected MEP event (as generated by the continuous check frame reception process) and the Period is the Period carried in the frame that triggered the event, unless an earlier continuous check frame triggering an Unexpected MEP event carried a greater period.

6.2.2.5 Degraded signal defect (dDEG)

See 6.2.3.1

Update clause 6.2.3.1 as below:

6.2.3.1 Generic behaviour

Signal quality supervision, in general, monitors the performance of a trail. If the performance falls below a certain threshold, this might activate a defect. For the generic performance monitoring process see 8.3.

For networks where the network operator assumes a **Poisson distribution of errors**, an excessive error defect and a degraded signal defect are to be detected.

For networks where the operator assumes a **bursty distribution of errors**, a degraded signal defect is to be detected. The excessive error defect, for this case, is assumed to be false.

For networks where the network operator assumes **Bad Second on frame calculation**, only a degraded signal defect is to be detected.

The applicability of the two is in the province of the regional standards.

Create clause 6.2.3.1.3 as below:

6.2.3.1.3 Degraded signal defects (dDEG) assuming Bad Second on frame calculation

The Degraded Signal defect is calculated by frame loss measurement mechanism at a network layer. It monitors the connectivity of an Trail.

Its detection and clearance are defined in Figure 6-z.

Every second the state machine receives the one-second counters for near end received and transmitted frames and determines whether the second was a Bad Second. The defect is detected if there are MI_LM_DEGM consecutive Bad Seconds and cleared if there are MI_LM_M consecutive Good Seconds.

In order to declare a Bad Second the number of transmitted frames must exceed a threshold (MI_LM_TFMIN). Furthermore, if the Frame Loss Ratio (lost frames/transmitted frames) is greater than MI_LM_DEGTHR, a Bad Second is declared

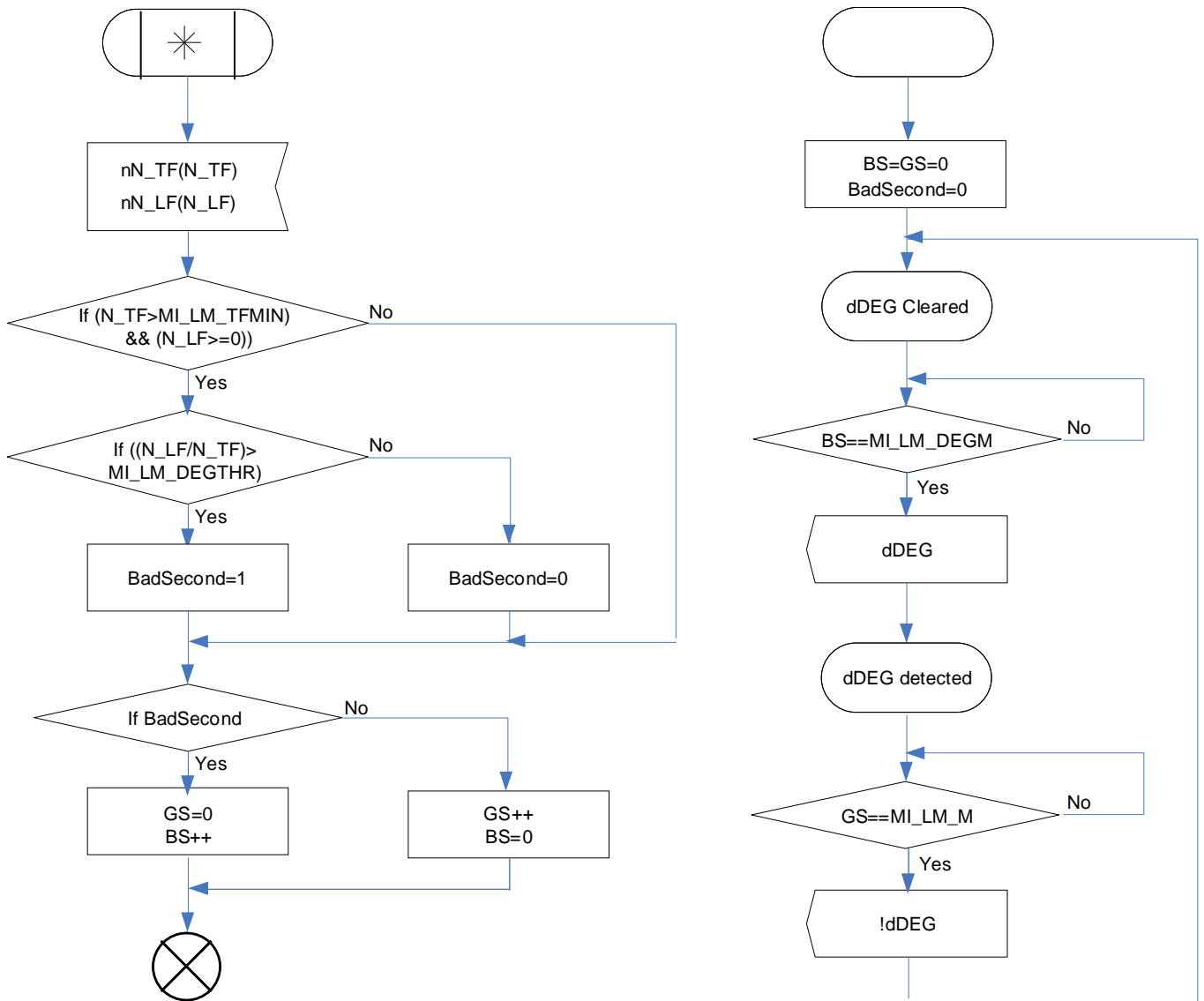

Figure 6-z – dDEG detection and clearance process

Create clauses 6.2.5.3 and 6.2.5.4 as below:

6.2.5.3 Loss Of Frame defect (dLOF)

A loss of frame (LOF) defect shall be declared if the frame alignment process is in the out-of-frame (OOF) state for certain period. dLOF shall be cleared when the frame alignment process enters in the in-frame (IF) state and/or the state persists consistently for certain time.

In SDH and OTUk, dLOF shall be cleared when the IF state persists continuously for 3 ms. (See [ITU-T G.783] and [ITU-T G.798]).

6.2.5.4 Loss Of Multiframe defect (dLOM)

A loss of multiframe (LOM) defect shall be declared if the multiframe alignment process is in the out-of-frame (OOF) state for certain period. dLOM shall be cleared when the multiframe alignment process is in the in-multiframe (IM) state.

Update clauses 6.2.6.2 as below:

6.2.6.2 Alarm Indication Signal–AIS defect (dAIS)

An Alarm Indication Signal (AIS) defect is calculated at a network layer. It monitors the presence of an AIS maintenance signal. For AIS generation see 6.3.1.

Basic function sink direction

If z consecutive frames contain the AIS activation pattern in the AIS overhead or the frame indicating AIS is received, an AIS defect shall be detected. The dAIS defect shall be cleared if z consecutive frames contain the AIS deactivation pattern in the AIS overhead or the frame indicating AIS is not received within certain period.

Details on the AIS defect by activation/deactivation pattern are provided in Table 6-9.

<..>

6.2.6.2.1 dAIS for CBR client signals (Generic AIS)

<..>

Table 6-9B/G.806 – Generic AIS defect details

Hierarchy	Layer	Type
SDH	STM-N	STM-AIS
802.3	ETX	ETX-AIS

Update clauses 6.2.6.3 as below:

6.2.6.3 Remote/Outgoing Defect Indication defect (dRDI/ODI)

Basic function source direction

The generation of RDI/ODI is required for bidirectional trail/flow termination functions. For RDI/ODI generation, see 6.3.2. The value inserted is the value received via RI_RDI/ODI from the associated basic sink function. The RDI/ODI value is inserted into the RDI/ODI overhead or the frame indicating RDI/ODI.

NOTE – For unidirectional trail termination functions not being paired with a termination sink function, the RDI/ODI signal output should be inactive, but can be undefined in old equipment not explicitly supporting unidirectional transport.

Basic function sink direction

The RDI/ODI overhead or the frame is recovered from the CP.

If z consecutive frames contain the RDI/ODI activation pattern in the RDI/ODI overhead or the frame indicating RDI/ODI is received, a dRDI/ODI defect shall be detected. The dRDI/ODI defect shall be cleared if z consecutive frames contain the RDI/ODI deactivation pattern in the RDI/ODI overhead or the frame indicating RDI/ODI is not received within certain period.

dRDI/ODI shall be cleared during SSF conditions. A new evaluation period for dRDI/ODI shall start after SSF is cleared.

Details on the RDI/ODI defects by activation/deactivation pattern are provided in Table 6-10.

Update clauses 6.2.6.4 as below:

6.2.6.4 GFP Client Signal Fail defect (dCSF)

~~GFP Client Signal Fail (dCSF) is raised when a GFP frame with correct tHEC, with aPTI = "100" and a valid and supported UPI code is received. dCSF is cleared when:~~

- ~~• no such GFP client management frame is received in $N \times 1000$ ms. A value of 3 is suggested for N, or~~
- ~~• A valid GFP client data frame is received, or~~
- ~~• A GFP[cmf] with UPI = DCI is received.~~

Client Signal Fail (dCSF) is raised when a signal that identifies client signal fail is received. dCSF defines following defects:

- dCSF-LOS (Client Loss of Signal)
- dCSF-FDI (Client Forward Defect Indication)
- dCSF-RDI (Client Reverse Defect Indication)

dCSF is raised when a frame indicating dCSF is received. dCSF is cleared when

- no such frame is received in certain period, or
- A frame indicating CSF defect clear indication is received.

6.2.6.4.1 GFP Client Signal Fail detect

GFP Client Signal Fail (dCSF) is raised when a GFP frame with correct tHEC, with aPTI = "100" and a valid and supported UPI code is received. dCSF is cleared when:

- no such GFP client management frame is received in $N \times 1000$ ms. A value of 3 is suggested for N, or
- A valid GFP client data frame is received, or
- A GFP[cmf] with UPI = DCI is received.

6.2.6.4.2 OPU Client Signal Fail defect

dCSF shall be declared if the CSF bit in the OPUk PSI overhead is "1" for X consecutive 256 frame multi-frames. dCSF shall be cleared if the CSF bit is "0" for consecutive 256 frame multi-frames. X shall be 3.

Create new sub-clauses as below:

6.2.6.5 Locked defect (dLCK)

The Locked defect is calculated at a network layer. It monitors the presence of a Locked maintenance signal.

If z consecutive frames contain the LCK activation pattern in the LCK overhead or a frame indicating LCK is received, an AIS defect shall be detected. The dLCK defect shall be cleared if z consecutive frames contain the LCK deactivation pattern in the LCK overhead or a frame indicating LCK is not received within certain period.

Update clauses 6.2.7.2 as below:

6.2.7.2 Failure of Protocol defect (dFOP)

The dFOP defect indicates a failure in the automatic protection switching protocol. The detailed behaviour is defined at the specific atomic functions.

6.2.7.2.1 Failure of Protocol Provisioning Mismatch defect (dFOP-PM)

The Failure of Protocol Provisioning Mismatch defect is calculated at a network layer. It monitors provisioning mismatch of the transmitted and the received APS protocol,

6.2.7.2.2 Failure of Protocol No Response defect (dFOP-NR)

The Failure of Protocol No Response defect is calculated at a network layer. It monitors incompleteness of protection switching by comparing the transmitted “Requested Signal” values and the received “Requested Signal” in the APS protocol.

6.2.7.2.3 Failure of Protocol Configuration Mismatch defect (dFOP-CM)

The Failure of Protocol Configuration Mismatch defect is calculated at a network layer. It monitors working and protection configuration mismatch by detecting the reception of APS protocol from the working transport entity.

6.2.7.2.4 Failure of Protocol Timeout defect (dFOP-TO)

The Failure of Protocol Timeout defect is calculated at a network layer. It monitors the timeout defect by detecting prolonged absence of expected APS protocol information.

Create new sub-clauses as below:

6.2.7.3 Unexpected Periodicity defect (dUNP)

The Unexpected Periodicity defect is calculated at the network layer where MEG and MEP defines. It detects the configuration of different periodicities of Continuity Check frames at different MEPs belonging to the same MEG.

Its detection and clearance are defined in Figure 6-y. The <Defect> in Figure 6-y is dUNP. The <Event> in Figure 6-y is the unexpPeriod event as generated by the Continuity Check frame reception process and the Period is the Period carried in the Continuity Check frame that triggered the event, unless an earlier Continuity Check frame triggering an unexpPeriod event carried a greater period.

6.2.7.4 Unexpected Priority defect (dUNPr)

The Unexpected Priority defect is calculated at the network layer. It detects the configuration of different Priorities Continuity Check frames at different MEPs belonging to the same MEG.

Its detection and clearance are defined in Figure 6-y. The <Defect> in Figure 6-y is dUNPr. The <Event> in Figure 6-y is the unexpPriority event as generated by the Continuity Check frame reception process and the Period is the Period carried in the Continuity Check frame that triggered the event, unless an earlier Continuity Check frame triggering an unexpPriority event carried a greater period.

12) Clause 6.5

Update clause 6.5, 6.5.1, and 6.5.3 as below

6.5 One-second performance monitoring filters

The one-second filters perform a simple integration of reported anomalies and defects by counting during a one-second interval. At the end of each one-second interval the contents of the counters is made available to the performance monitoring processes within the EMF for further processing (see ITU-T Rec. G.7710). Generically, the following (superset of) counter outputs will be provided:

- near-end/far-end errored or lost block counts;
- near-end/far-end transmitted block counts
- near-end/far-end defect seconds;
- pointer justification counts (see [ITU-T Rec. G.783]).

This clause presents in generic terms the performance monitoring primitive generation within atomic functions. Specific details are presented in each atomic function ~~(see specific equipment functional Recommendations ITU-T Recs G.783 and G.705).~~

NOTE – Near-end/far-end processing includes also outgoing near-end/far-end processing.

6.5.1 Near-end Errored Block Count (pN_EBC) and Near-end Lost Blocked Count (pN-LBC)

Every second, the number of errored near-end blocks (N_Bs) within that second is counted as the Near-end Error Block Count (pN_EBC) for circuit layer. For packet layer, the number of lost near-end blocks within that second is counted as the Near-end Lost Block Count (pN_LBC)

The errored near-end blocks (N_Bs) are defined in Table 6-11.

<...>

6.5.3 Far-end Errored Block Count (pF_EBC) and Far-end Lost Blocked Count (pN-LBC)

Every second, the number of errored far-end blocks (F_Bs) within that second is counted as the Far-end Error Block Count (pF_EBC) for circuit layer. For packet layer, the number of lost near-end blocks within that second is counted as the Near-end Lost Block Count (pN_LBC).

The errored far-end blocks (F_Bs) are defined Table 6-12.

<...>

13) Clause 8.5

Update clause 8.5.4.2.1 as below:

8.5.4.2.1 Client-specific GFP-T source processes

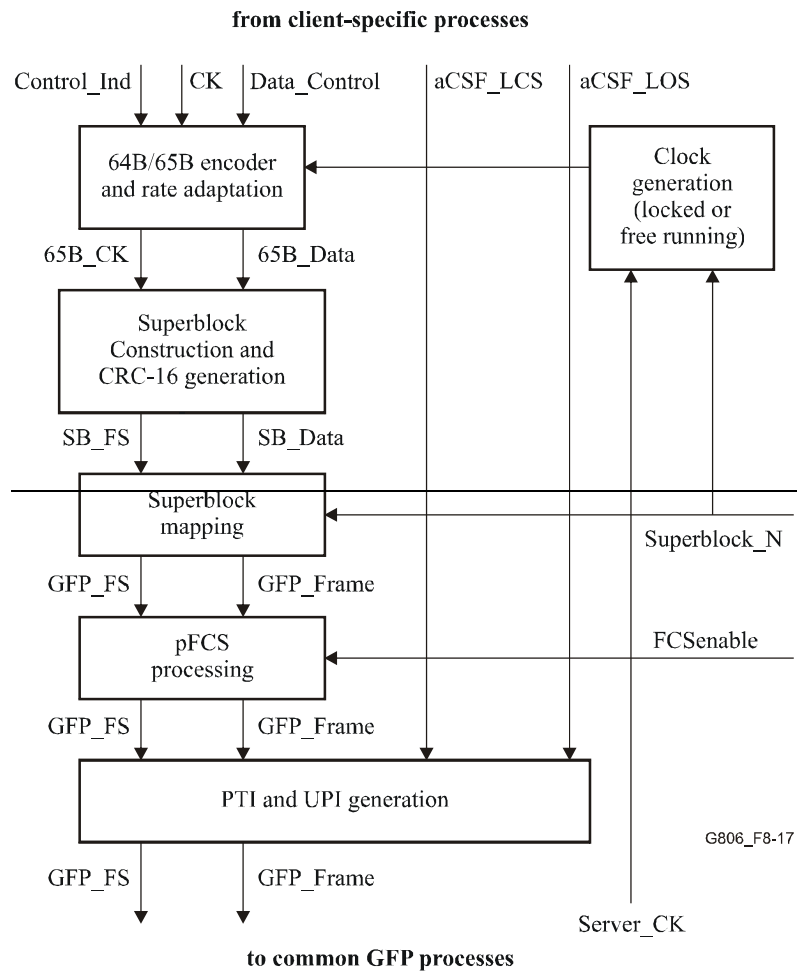

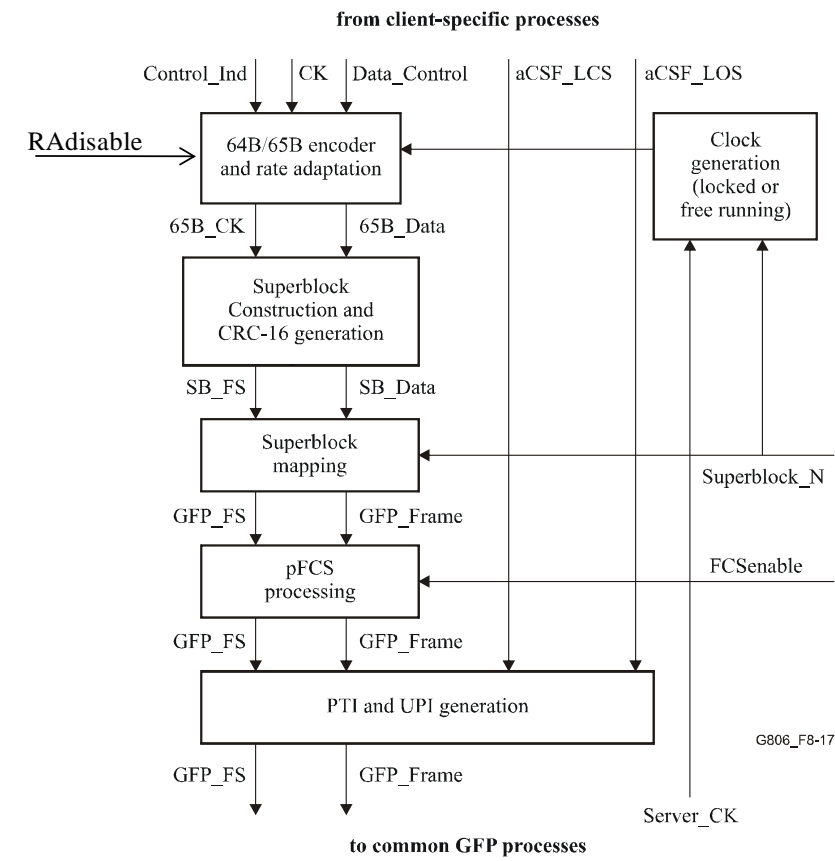

Figure 8-17/G.806 – Client-specific GFP-T source processes

Figure 8-17 shows the client-specific GFP-T source processes. The input to the process is a stream of data and control octets (Data_Control), an indication that the current octet is a control octet (Control_Ind), a clock (CK) and a Loss of Signal (CSF_LOS) and Loss of Character Synchronization (CSF_LCS) indication from the server layer. The basic functionality is described below. Client layer-specific deviations or extensions to the processes might be defined in the adaptation functions of the technology-specific equipment Recommendations.

Clock generation: The process generates the clock for the generation of the GFP frames. The clock rate has to be such that client data can be accommodated at its maximum rate. The clock is locked to the server layer clock (Server_CK). Optionally, a free-running clock can be used. In the latter case, an additional rate adaptation to the server layer will be performed at the server layer-specific GFP processes using GFP-Idle frames.

64B/65B encoder and rate adaptation: The process constructs 64B/65B code word from eight consecutive received data or control words as defined in 8.1.1/G.7041/Y.1303. If no data or control word is available and rate adaptation is enabled (RAdisable=false), a 65B_PAD character is inserted instead as defined in 8.1.1.2/G.7041/Y.1303.

NOTE – RAdisable is implicitly set to false in equipment designed to earlier versions of G.806

14) Appendix I

Add following sub-clauses (I.8 and I.9) as below:

I.8 Connection matrix example for 3-port groups (address slot group switching)

The set of input and output ports is divided into three groups, each containing both input and output ports, west (W), east (E), add/drop (A/D) as shown in Figure I.3. In addition to the limitations of type I above, connections from W to E and E to W are limited to the same address slot groups as shown in Table I.8.

Table I.8 – Connection matrix example for 3-port groups (address slot group switching)

		V_i		
		W	E	A/D
V_j	W	–	Y	X
	E	Y	–	X
	A/D	X	X	–

X Indicates V_i - V_j connection possible for any $(i_1, i_2, i_3 \dots i_N)$ and $(j_1, j_2, j_3 \dots j_N)$.
 Y Indicates V_i - V_j connections possible only in the case that $(i_1, i_2, i_3 \dots i_N) = (j_1, j_2, j_3 \dots j_N)$ (e.g., waveband switching).
 – Indicates no connection possible.

I.9 Connection matrix example for 4-port groups (address slot group switching)

The set of input and output ports is divided into four subsets, each containing both input and output ports, west (W), east (E), add/drop east (A/DE) and add/drop west (A/DW) as shown in Figure I.4. In addition to the limitations of type I above, connections from W to E and E to W are limited to the same address slot groups as shown in Table I.9.

Table I.9 – Connection matrix example for 4-port groups (address slot group switching)

		V_i			
		W	E	A/DW	A/DE
V_j	W	–	Y	X	–
	E	Y	–	–	X
	A/DW	X	–	–	–
	A/DE	–	X	–	–

X Indicates V_i - V_j connection possible for any $(i_1, i_2, i_3 \dots i_N)$ and $(j_1, j_2, j_3 \dots j_N)$.
 Y Indicates V_i - V_j connections possible only in the case that $(i_1, i_2, i_3 \dots i_N) = (j_1, j_2, j_3 \dots j_N)$ (e.g., waveband switching).
 – Indicates no connection possible.

15) Appendix IX

Create new Appendix as below:

Appendix IX

Types of Flow Forwarding processes

There are two main classes of flow forwarding processes; the flow unaware forwarding processes and the flow aware forwarding processes.

A flow unaware forwarding process forwards information applied at an input port to all the connected output port or ports or to a subset of those output ports. The forwarding is performed independent of information within the characteristic information.

- Connectivity of a Type Ia and Type IIa flow forwarding process can not be changed. Information applied at the input port is forwarded to all output ports.
- Connectivity of a Type Ib flow forwarding process can be changed under control of MI, in which case a loopback can be established or removed; refer to [ITU-T M.125] for loopback types and their specific connectivity.
- Connectivity of a Type III, IVa and IVb flow forwarding process can be modified under control of signal fail/degrade states of the incoming signals themselves or external protection switch commands (i.e. protection switch).

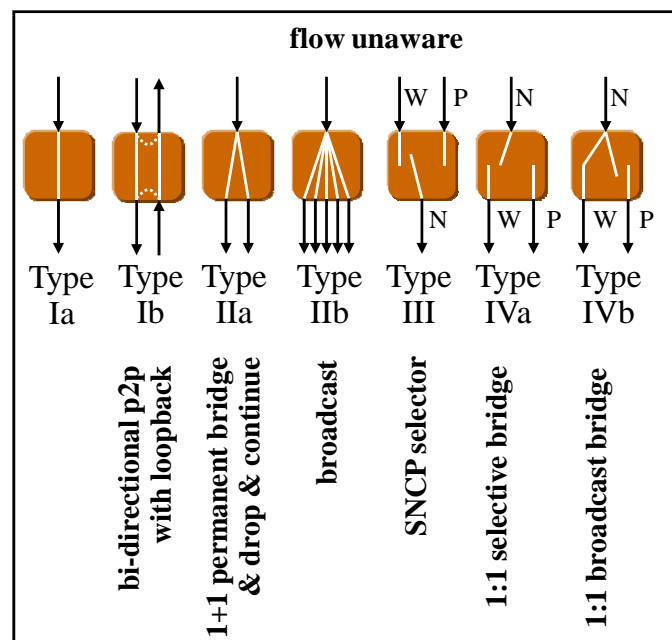

Figure IX-1 – Basic flow unaware forwarding process types

Flow unaware forwarding processes may be compounded to create more complex flow forwarding processes. Figure 5-D illustrates a number of such compound flow unaware forwarding processes which support specific protection switching capabilities.

- The two top left compound flow forwarding processes support two stage SNC protection switch selectors with three or four input signals.
- The two top middle compound flow forwarding processes support the [b-ITU-T G.842] path selector and service selector.

- The two top left compound flow forwarding processes support two types of dual node interconnect (DNI) protection for the case that the two subnetworks are interconnected via two nodes which have NNI ports in both subnetworks. It provides for a variation of dual node interconnection scenarios described in [ITU-T G.842], in which the interfaces between the two subnetworks are virtualized; i.e. supported within the switch fabric of one node.
- The bottom compound flow forwarding process supports the [ITU-T G.808.1] (adaptive) compound link SNC group protection with load sharing.

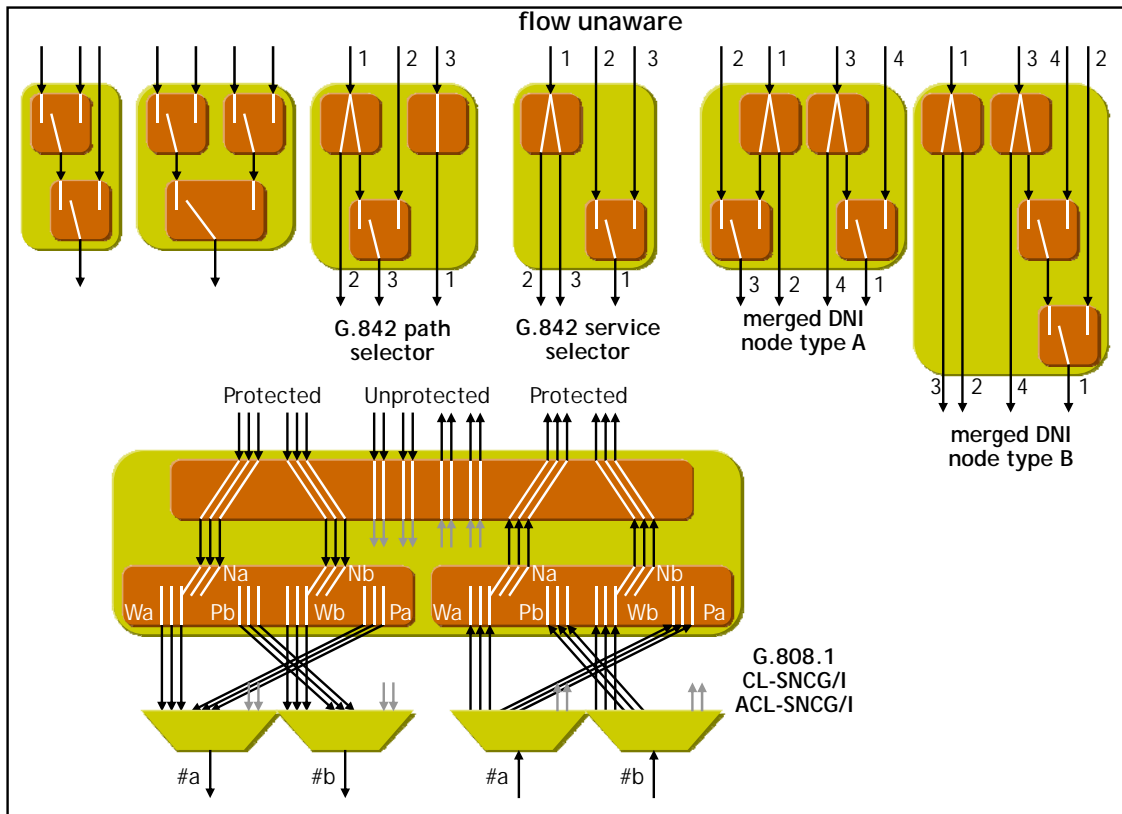

Figure IX-2 – compound flow unaware forwarding process types

A flow aware forwarding process forwards information applied at an input port either to one of the output ports, or to a subset of the output ports, or to all output ports with exception of the output port associated with the input port. The forwarding is performed on the basis of information elements within the characteristic information and configured relationships (under control of local learning, network management and/or control plane) associating specific values of these information elements with one or more or all of the output ports.

- Connectivity of a Type Va flow forwarding process is any input to any output with exception of the output port associated with the input port.
- Connectivity of a Type Vb flow forwarding process is
 - # from an external input port E to any internal output port I and any external output port E with exception of the output port E associated with the input port E
 - # from an internal input port I to any external output port E
- Connectivity of a Type Vc flow forwarding process is

- # from an external input port E to any internal output port I and any external output port E with exception of the output port E associated with the input port E
- # from an internal input port Ia or Ib to any external output port E
- # from an internal input port Ia to any internal output port Ib
- # from an internal input port Ib to any internal output port Ia
- Connectivity of a Type VIa flow forwarding process is
 - # from the root input port R to any leaf output port
 - # from a leaf input port I to the root output port R
- Connectivity of a Type VIb flow forwarding process is
 - # from a root input port R to any leaf output port L and any root output port R with exception of the root output port R associated with the input port R
 - # from a leaf input port L to any root output port R
- Connectivity of a Type VIc flow forwarding process is
 - # from a root input port R to any leaf output port L and any root output port R with exception of the output port R associated with the input port R
 - # from a leaf input port L to any root output port R
 - # from a leaf group input port Gi to any root output port R and any leaf group output port Gi with exception of the output port Gi associated with the input port Gi

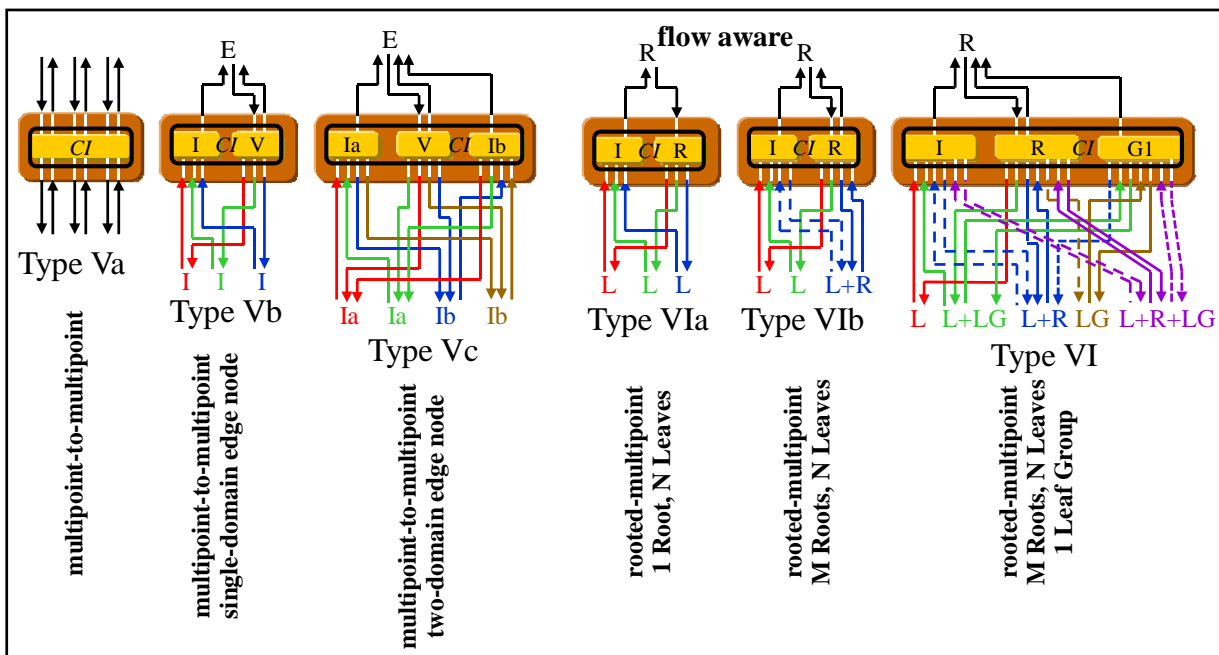

Figure IX-3 – Basic flow aware forwarding process types