

**ITU-T**

**G.8152/Y.1375**

TELECOMMUNICATION  
STANDARDIZATION SECTOR  
OF ITU

(12/2018)

SERIES G: TRANSMISSION SYSTEMS AND MEDIA,  
DIGITAL SYSTEMS AND NETWORKS

Packet over Transport aspects – MPLS over Transport  
aspects

SERIES Y: GLOBAL INFORMATION  
INFRASTRUCTURE, INTERNET PROTOCOL ASPECTS,  
NEXT-GENERATION NETWORKS, INTERNET OF  
THINGS AND SMART CITIES

Internet protocol aspects – Transport

---

**Protocol-neutral management information  
model for the MPLS-TP network element**

Recommendation ITU-T G.8152/Y.1375

ITU-T G-SERIES RECOMMENDATIONS  
**TRANSMISSION SYSTEMS AND MEDIA, DIGITAL SYSTEMS AND NETWORKS**

INTERNATIONAL TELEPHONE CONNECTIONS AND CIRCUITS	G.100–G.199
GENERAL CHARACTERISTICS COMMON TO ALL ANALOGUE CARRIER-TRANSMISSION SYSTEMS	G.200–G.299
INDIVIDUAL CHARACTERISTICS OF INTERNATIONAL CARRIER TELEPHONE SYSTEMS ON METALLIC LINES	G.300–G.399
GENERAL CHARACTERISTICS OF INTERNATIONAL CARRIER TELEPHONE SYSTEMS ON RADIO-RELAY OR SATELLITE LINKS AND INTERCONNECTION WITH METALLIC LINES	G.400–G.449
COORDINATION OF RADIOTELEPHONY AND LINE TELEPHONY	G.450–G.499
TRANSMISSION MEDIA AND OPTICAL SYSTEMS CHARACTERISTICS	G.600–G.699
DIGITAL TERMINAL EQUIPMENTS	G.700–G.799
DIGITAL NETWORKS	G.800–G.899
DIGITAL SECTIONS AND DIGITAL LINE SYSTEM	G.900–G.999
MULTIMEDIA QUALITY OF SERVICE AND PERFORMANCE – GENERIC AND USER-RELATED ASPECTS	G.1000–G.1999
TRANSMISSION MEDIA CHARACTERISTICS	G.6000–G.6999
DATA OVER TRANSPORT – GENERIC ASPECTS	G.7000–G.7999
PACKET OVER TRANSPORT ASPECTS	G.8000–G.8999
Ethernet over Transport aspects	G.8000–G.8099
<b>MPLS over Transport aspects</b>	<b>G.8100–G.8199</b>
Synchronization, quality and availability targets	G.8200–G.8299
Service Management	G.8600–G.8699
ACCESS NETWORKS	G.9000–G.9999

*For further details, please refer to the list of ITU-T Recommendations.*

# Recommendation ITU-T G.8152/Y.1375

## Protocol-neutral management information model for the MPLS-TP network element

### Summary

Recommendation ITU-T G.8152/Y.1375 contains the protocol neutral unified modelling language (UML) model for multi-protocol label switching – transport profile (MPLS-TP) network element (NE) management.

This Recommendation provides a representation of the MPLS-TP technology using the methodologies that have been used for other transport technologies (e.g., SDH, OTN and Ethernet).

The 2018 revision of this Recommendation up-versions the UML model tool to Papyrus v3.2.0 and the profile to v0.2.13, updates the model to add the MEP proactive measurement MI, MEP configuration MI and MIP configuration MI, adds the Spec model for MPLS-TP model, replaces the G.8152NE and MT\_NE with the MMPLS-TP constraint domain, and MT\_SubnetworkProtectionGroup specifies the FcSwitch, and MT\_CrossConnection specifies the ForwardingConstruct.

### History

Edition	Recommendation	Approval	Study Group	Unique ID*
1.0	ITU-T G.8152/Y.1375	2016-12-22	15	<a href="http://handle.itu.int/11.1002/1000/13104">11.1002/1000/13104</a>
2.0	ITU-T G.8152/Y.1375	2018-12-14	15	<a href="http://handle.itu.int/11.1002/1000/13799">11.1002/1000/13799</a>

### Keywords

Information model, MPLS-TP, protocol-neutral, transport resource, UML.

---

\* To access the Recommendation, type the URL <http://handle.itu.int/> in the address field of your web browser, followed by the Recommendation's unique ID. For example, <http://handle.itu.int/11.1002/1000/11830-en>.

## FOREWORD

The International Telecommunication Union (ITU) is the United Nations specialized agency in the field of telecommunications, information and communication technologies (ICTs). The ITU Telecommunication Standardization Sector (ITU-T) is a permanent organ of ITU. ITU-T is responsible for studying technical, operating and tariff questions and issuing Recommendations on them with a view to standardizing telecommunications on a worldwide basis.

The World Telecommunication Standardization Assembly (WTSA), which meets every four years, establishes the topics for study by the ITU-T study groups which, in turn, produce Recommendations on these topics.

The approval of ITU-T Recommendations is covered by the procedure laid down in WTSA Resolution 1.

In some areas of information technology which fall within ITU-T's purview, the necessary standards are prepared on a collaborative basis with ISO and IEC.

## NOTE

In this Recommendation, the expression "Administration" is used for conciseness to indicate both a telecommunication administration and a recognized operating agency.

Compliance with this Recommendation is voluntary. However, the Recommendation may contain certain mandatory provisions (to ensure, e.g., interoperability or applicability) and compliance with the Recommendation is achieved when all of these mandatory provisions are met. The words "shall" or some other obligatory language such as "must" and the negative equivalents are used to express requirements. The use of such words does not suggest that compliance with the Recommendation is required of any party.

## INTELLECTUAL PROPERTY RIGHTS

ITU draws attention to the possibility that the practice or implementation of this Recommendation may involve the use of a claimed Intellectual Property Right. ITU takes no position concerning the evidence, validity or applicability of claimed Intellectual Property Rights, whether asserted by ITU members or others outside of the Recommendation development process.

As of the date of approval of this Recommendation, ITU had not received notice of intellectual property, protected by patents, which may be required to implement this Recommendation. However, implementers are cautioned that this may not represent the latest information and are therefore strongly urged to consult the TSB patent database at <http://www.itu.int/ITU-T/ipr/>.

© ITU 2019

All rights reserved. No part of this publication may be reproduced, by any means whatsoever, without the prior written permission of ITU.

## Table of Contents

	<b>Page</b>
1 Scope .....	1
2 References .....	3
3 Definitions .....	4
3.1 Terms defined elsewhere .....	4
3.2 Terms defined in this Recommendation .....	4
4 Abbreviations and acronyms .....	5
5 Conventions .....	7
5.1 Information modelling conventions .....	7
5.2 Equipment function conventions.....	7
6 Overview of the model.....	11
6.1 Basic configuration structure .....	13
6.2 MI grouping and mapping .....	21
7 Modelling of MPLS-TP functions .....	32
7.1 OAM compound functions .....	32
7.2 Fault management .....	50
7.3 Performance monitoring .....	50
7.4 MPLS-TP multiplexing .....	50
7.5 Connection function .....	51
7.6 SCC/MCC access function .....	52
8 UML model file .....	54
Annex A – MPLS-TP Specification model.....	55
A.1 LTP/LP Spec model .....	55
Appendix I – UML modelling guidelines .....	58
Appendix II – Mapping of ITU-T G.8121 atomic functions to ITU-T G.8152/Y.1375 model artefacts.....	59
Appendix III – UML model data dictionary.....	60
Bibliography .....	61

## Introduction

This Recommendation contains the object classes for the MPLS-TP NE management. It includes the termination points (TP), maintenance entity group (MEG) end point (MEP), MEG intermediate point (MIP), traffic conditioning and shaping (TCS), loss measurement (LM), delay measurement (DM), and the general performance monitoring (PM) current data (CD) and history data (HD).

The TP, MEP, MIP, LM, DM, and TCS object classes support the configuration and fault management functions as specified in [ITU-T G.8151].

The MPLS-TP TPs are modelled as subclasses of the generic GlobalClass defined in [ITU-T G.7711] and extending the LTP and LP classes of [ITU-T G.7711].

The MPLS-TP general PM CD and HD object classes are modelled as subclasses of the generic current data and history data defined in [ITU-T Q.822].

The MPLS-TP general CD and HD object classes support only the quality of service (QoS) directly related PM parameters, i.e., severely errored second (SES) and unavailable second (UAS), for service level agreement (SLA) verification. The additional PM object classes for supporting loss measurement and delay measurement monitoring uses the general CD and HD object classes as super classes.

The object model defined in this Recommendation is protocol-neutral with respect to management protocols. The model could be used as the base for further defining the information model for any specific management protocol.

The model in this Recommendation has been specified using the open source UML modelling tool "Papyrus".

# Recommendation ITU-T G.8152/Y.1375

## Protocol-neutral management information model for the MPLS-TP network element

### 1 Scope

This Recommendation provides a management/control-protocol-neutral information model for managing/controlling network elements in the MPLS-TP transport network as defined in [ITU-T G.8110.1]. It identifies the managed entities required for the management/control of MPLS-TP transport network elements. These entities are relevant to information exchanged across standardized interfaces defined in the [ITU-T M.3010] TMN architecture. The management/control protocol-neutral information model should be used as the base for defining management protocol-specific information models, for example XML (web service or Netconf/Yang) information model, common object request broker architecture (CORBA) interface definition language (IDL) model, and simple network management protocol (SNMP) management information base (MIB).

The information model defined in this Recommendation is an augmentation to the generic code model specified in [ITU-T G.7711] for managing MPLS-TP transport resources. The core information model defined in [ITU-T G.7711] can be used as the base for the extension of MPLS-TP-specific information models.

The specific mapping of the management/control protocol-neutral model into management/control-protocol-specific model is the decision of the management/control-protocol-specific solution design. For example, an object class defined in this Recommendation may be mapped into multiple tables in a SNMP MIB. Protocol-specific solutions and their mapping from the protocol-neutral model may be described in other Recommendations and is out of the scope of this Recommendation.

This Recommendation applies to MPLS-TP transport network elements and those systems that manage/control such network elements. The management/control system could be an NMS, EMS, SDN controller or a hybrid of them. [ITU-T G.7701] defines the management-control-continuum (MCC) concept whereby management and control functions are considered to be a continuum. Those systems are thus referred to as a management-control system (MCS) in general in this Recommendation. Functional capabilities of MPLS-TP transport equipment are defined in [ITU-T G.8121], [ITU-T G.8121.1], [ITU-T G.8121.2] and requirements of the management of MPLS-TP transport equipment are provided in [ITU-T G.7710] and [ITU-T G.8151]. The information model specified in this Recommendation applies to the management/control interface, as shown in Figure 1-1, specifically for managing/controlling the MPLS-TP functional capabilities of the NE.

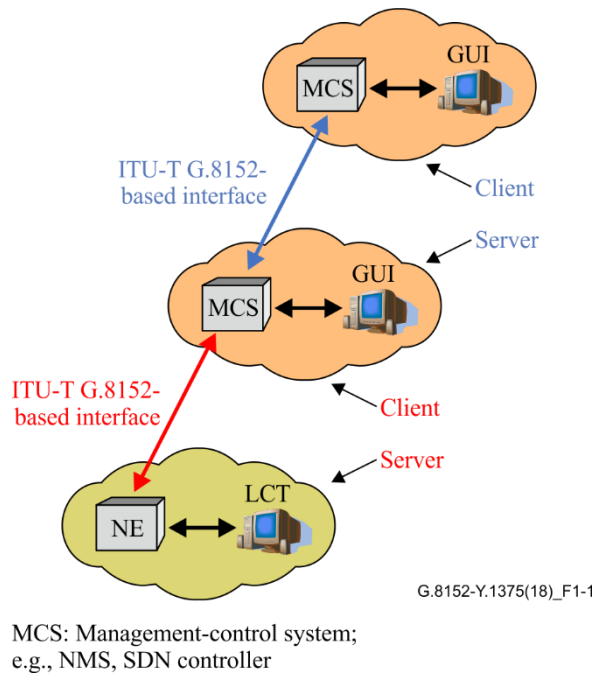

**Figure 1-1 – Scope of ITU-T G.8152 interface**

The object classes defined in this Recommendation cover the areas of fault management, configuration management, and performance management.

There are several different perspectives from which management information may be defined for management purposes. The network element viewpoint is concerned with the information that is required to manage a network element. This refers to information required to manage the network element function and the physical aspects of the network element. This Recommendation addresses only the network element view of Ethernet transport network management.

The management/control-protocol-neutral information model specified in this Recommendation consists of a set of transport-technology-specific managed object classes, i.e., MPLS-TP-specific managed object classes. These MPLS-TP-specific managed object classes are inherited from the generic managed object classes defined in other ITU-T Recommendation such as [ITU-T G.7711] and [ITU-T M.3160], including managed element, termination point and its subclasses, subnetwork, and subnetwork connection. Because of object class inheritance, the MPLS-TP management information model also inherits the generic object management capabilities, such as object creation/deletion, notification of object creation/deletion, attribute value retrieval/modification, notification of attribute/state value change, scoped and filtered retrieval of object instances, and abortion of outstanding operations. The description of these generic object management capabilities is provided in other ITU-T Recommendations, such as the ITU-T M.3700 series, and therefore is outside the scope of this Recommendation.

The object classes defined in this Recommendation cover the areas of fault management, configuration management, and performance management.

This Recommendation provides a representation of the MPLS-TP technology using the methodologies that have been used for other transport technologies (e.g., SDH, OTN and Ethernet).



## 2 References

The following ITU-T Recommendations and other references contain provisions which, through reference in this text, constitute provisions of this Recommendation. At the time of publication, the editions indicated were valid. All Recommendations and other references are subject to revision; users of this Recommendation are therefore encouraged to investigate the possibility of applying the most recent edition of the Recommendations and other references listed below. A list of the currently valid ITU-T Recommendations is regularly published. The reference to a document within this Recommendation does not give it, as a stand-alone document, the status of a Recommendation.

- [ITU-T G.7701] Recommendation ITU-T G.7701 (2016), *Common control aspects*, plus Amendment 1 (2018).
- [ITU-T G.7710] Recommendation ITU-T G.7710/Y.1701 (2012), *Common equipment management function requirements*, plus Amendment 1 (2016).
- [ITU-T G.7711] Recommendation ITU-T G.7711/Y.1702 (2018), *Generic protocol-neutral information model for transport resources*.
- [ITU-T G.8013] Recommendation ITU-T G.8013/Y.1731 (2015), *Operations, administration and maintenance (OAM) functions and mechanisms for Ethernet-based networks*
- [ITU-T G.8052] Recommendation ITU-T G.8052/Y.1346 (2016), *Protocol-neutral management information model for the Ethernet transport capable network element*.
- [ITU-T G.8110.1] Recommendation ITU-T G.8110.1/Y.1370.1 (2011), *Architecture of the Multi-Protocol Label Switching transport profile layer network*.
- [ITU-T G.8113.1] Recommendation ITU-T G.8113.1/Y.1372.1 (2016), *Operations, administration and maintenance mechanism for MPLS-TP in packet transport network*.
- [ITU-T G.8113.2] Recommendation ITU-T G.8113.2/Y.1372.2 (2015), *Operations, administration and maintenance mechanisms for MPLS-TP networks using the tools defined for MPLS*.
- [ITU-T G.8121] Recommendation ITU-T G.8121/Y.1381 (2018), *Characteristics of MPLS-TP equipment functional blocks*.
- [ITU-T G.8121.1] Recommendation ITU-T G.8121.1/Y.1381.1 (2018), *Characteristics of MPLS-TP equipment functional blocks supporting ITU-T G.8113.1/Y.1373.1 OAM mechanisms*.
- [ITU-T G.8121.2] Recommendation ITU-T G.8121.2/Y.1381.2 (2018), *Characteristics of MPLS-TP equipment functional blocks supporting ITU-T G.8113.2/Y.1373.2 OAM mechanisms*.
- [ITU-T G.8131] Recommendation ITU-T G.8131/Y.1382 (2014), *Linear protection switching for MPLS transport profile*, plus Amendment 1 (2016).
- [ITU-T G.8151] Recommendation ITU-T G.8151/Y.1374 (2018), *Management aspects of the MPLS-TP network element*.
- [ITU-T M.3010] Recommendation ITU-T M.3010 (2000), *Principles for a telecommunications management network*.
- [ITU-T M.3160] Recommendation ITU-T M.3160 (2008), *Generic protocol-neutral management information model*.
- [ITU-T Q.822] Recommendation ITU-T Q.822 (1994), *Stage 1, stage 2 and stage 3 description for the Q3 interface – Performance management*.

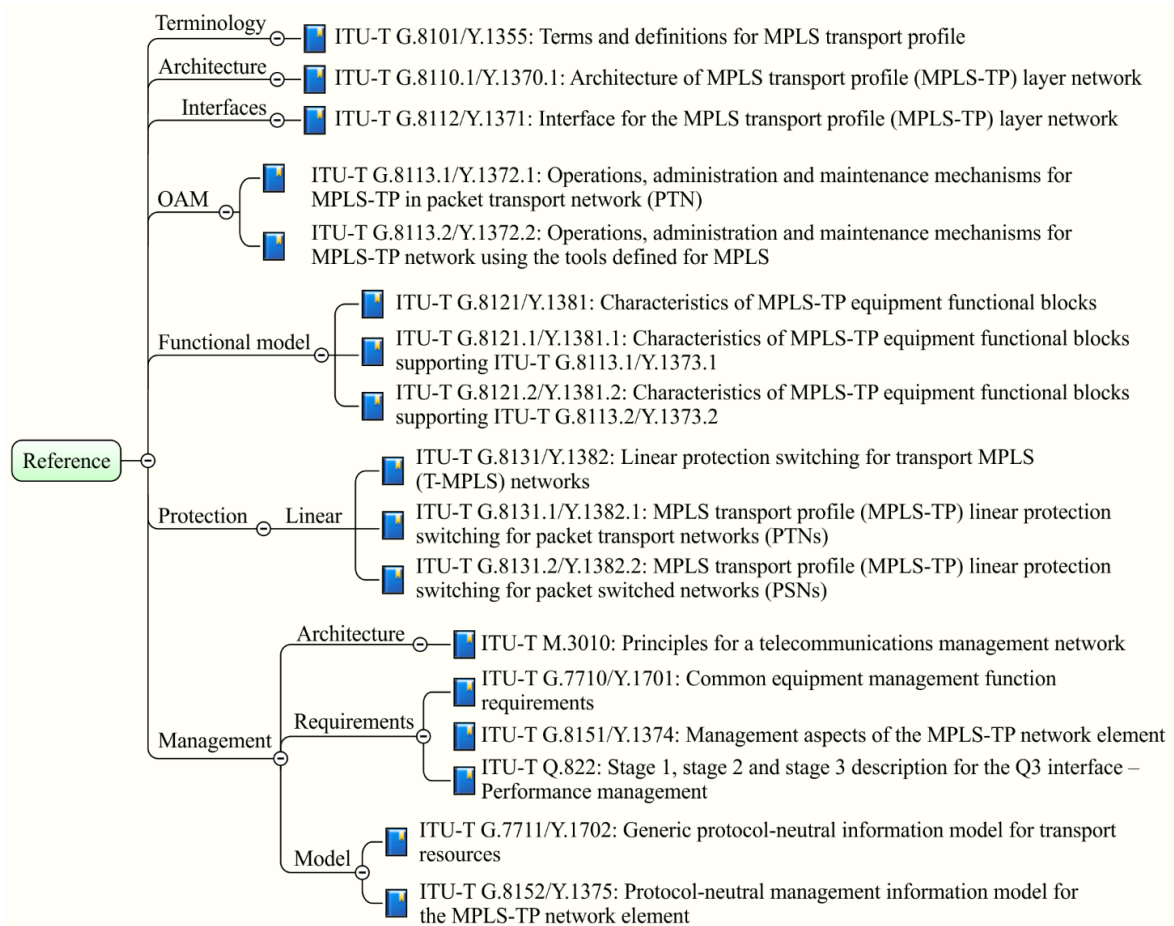

G.8152-Y.1375(16)\_F2-1

**Figure 2-1 – Structure of references**

### 3 Definitions

#### 3.1 Terms defined elsewhere

This Recommendation uses the following terms defined elsewhere:

**3.1.1 maintenance entity (ME):** [ITU-T G.8013]

**3.1.2 maintenance entity group (MEG):** [ITU-T G.8013]

**3.1.3 maintenance entity group end point (MEP) compound function:** [ITU-T G.8052]

**3.1.4 maintenance entity group intermediate point (MIP) compound function:** [ITU-T G.8052]

**3.1.5 on-demand monitoring:** [ITU-T G.8013]

**3.1.6 proactive monitoring:** [ITU-T G.8013]

**3.1.7 dual-ended:** [ITU-T G.8013]

**3.1.8 one-way:** [ITU-T G.8013]

**3.1.9 single-ended:** [ITU-T G.8013]

**3.1.10 two-way:** [ITU-T G.8013]

#### 3.2 Terms defined in this Recommendation

None.

#### 4 Abbreviations and acronyms

This Recommendation uses the following abbreviations and acronyms:

1DM	One-way Delay Measurement
1DMo	On-demand one-way Delay Measurement
1DMp	Proactive one-way Delay Measurement
AIS	Alarm Indication Signal
APS	Automatic Protection Switching
CCM	Continuity Check Message
CD	Current Data
CORBA	Common Object Request Broker Architecture
CTP	Connection Termination Point
CW	Control Word
DEG	Degraded
DM	Delay Measurement
DMo	On-demand Delay Measurement
DMp	Proactive Delay Measurement
DP	Data Plane
ECC	Embedded Communication Channel
EMS	Element Management System
ETH	Ethernet MAC layer network
G-ACh	Generic Associated Channel
GAL	Generic Associated Channel (G-ACh) Label
GFP	Generic Framing Procedure
HD	History Data
IDL	Interface Definition Language
LCK	Locked
LM	Loss Measurement
LMo	On-demand Loss Measurement
LMp	Proactive Loss Measurement
LMR	Loss Measurement Reply
LOC	Loss of Continuity
LSP	Label Switched Path
LT	Link Trace
MAC	Medium Access Control
MCC	Management Communication Channel
ME	Maintenance Entity
MEG	Maintenance Entity Group

MEP	Maintenance entity group End Point
MI	Management Information
MIB	Management Information Base
MIP	Maintenance entity group Intermediate Point
MPLS	Multi-Protocol Label Switching
MPLS-TP	Multi-Protocol Label Switching – Transport Profile
MT	Multi-Protocol Label Switching – Transport Profile
MTD	MPLS-TP Diagnostic function
MTDi	MPLS-TP Diagnostic function within MTx MIP
MTS	MPLS-TP Section
NC	Network Connection
NCM	Network Connection Monitoring
NE	Network Element
OAM	Operation, Administration and Maintenance
PHB	Per Hop Behaviour
PM	Performance Monitoring
PRI	Priority
PSC	PHB Scheduling Class
QoS	Quality of Service
RDI	Remote Defect Indication
SCC	Signalling Communication Channel
SCC Type	Signalling Communication Channel Type
SES	Severely Errored Second
Sk	Sink
SLA	Service Level Agreement
SL	Synthetic Loss Measurement
SLp	Proactive Synthetic Loss Measurement
SLo	On-demand Synthetic Loss Measurement
SN	Sub-Network
SNC	Sub-Network Connection
SNCP	Sub-Network Connection Protection
SNMP	Simple Network Management Protocol
So	Source
SQ	Sequence
TC	Traffic Class
TCM	Tandem Connection Monitoring
TCS	Traffic Conditioning and Shaping

TH	Throughput
TMN	Telecommunications Management Network
TP	Termination Point
TSNUM	Tributary Slot Number
TT	Trail Termination
TTL	Time-To-Live
TTP	Trail Termination Point
UAS	Unavailable Second
UML	Unified Modelling Language

## **5 Conventions**

### **5.1 Information modelling conventions**

See clause 5.1 of [ITU-T G.7711].

#### **5.1.1 UML modelling conventions**

See clause 5.1 of [ITU-T G.7711].

#### **5.1.2 Model Artefact Lifecycle Stereotypes conventions**

See clause 5.2 of [ITU-T G.7711].

#### **5.1.3 Forwarding entity terminology conventions**

See clause 5.3 of [ITU-T G.7711].

#### **5.1.4 Conditional package conventions**

See clause 5.4 of [ITU-T G.7711].

#### **5.1.5 Pictorial diagram conventions**

See clause 5.5 of [ITU-T G.7711].

### **5.2 Equipment function conventions**

#### **5.2.1 Maintenance entity group end point (MEP) [ITU-T G.8121]**

MEG end points (MEPs) terminate maintenance entities (MEs) which can span the end-to-end network connection or a portion of the network connection defined as a tandem connection.

The diagrammatic convention for network connection monitoring MEP (NCM MEP) compound functions is shown in Figure 5-1:

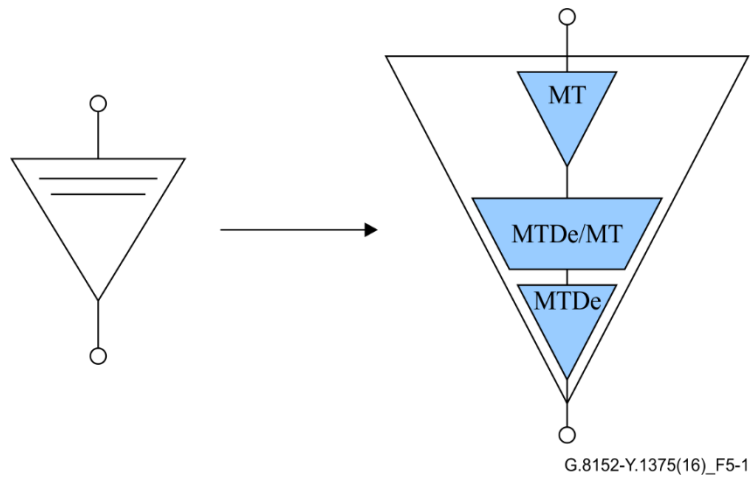

**Figure 5-1 – MT NCM MEP compound functions  
(Same as Figure 9-39 of [ITU-T G.8121])**

The diagrammatic convention for tandem connection monitoring MEP (TCM MEP) compound functions is shown in Figure 5-2.

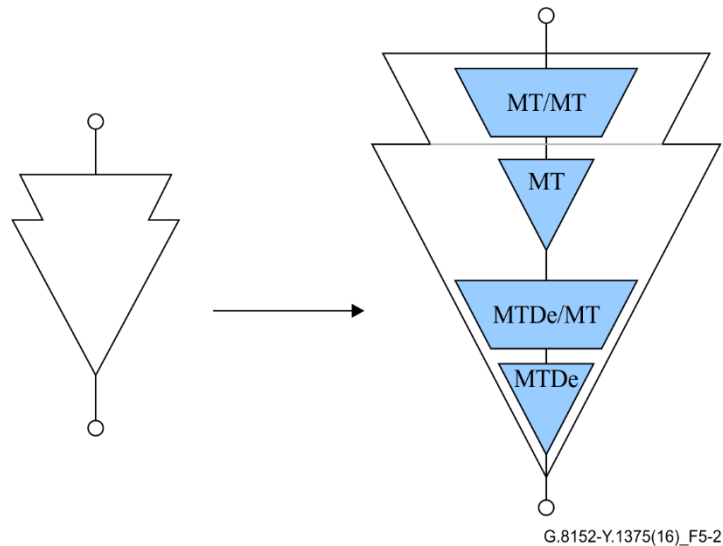
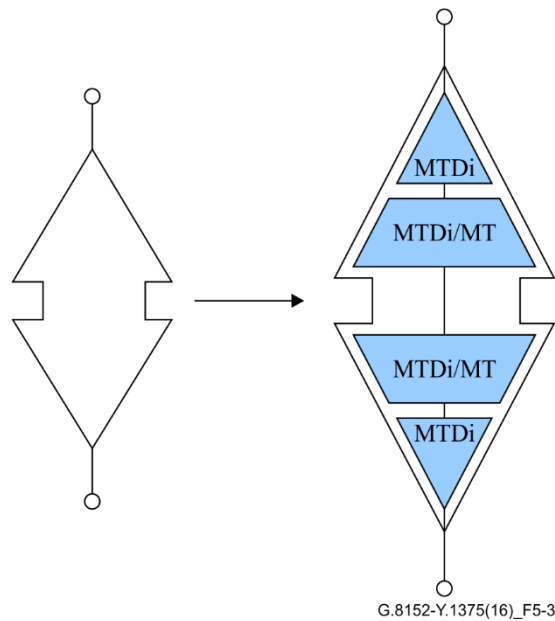

**Figure 5-2 – MT TCM MEP compound functions  
(Same as Figure 9-40 of [ITU-T G.8121])**

NOTE – Unlike the Ethernet technology, the same MT/MT atomic function defined in [ITU-T G.8121] can be used either within the optional TCM MEP (i.e., not "stand alone") or at the layer boundary (i.e., "stand alone" and not be a part of a MEP), regardless of the number of client signals (even in case of only one signal when there is no multiplexing).

### 5.2.2 Maintenance entity group intermediate point (MIP) [ITU-T G.8121]

The diagrammatic convention for MIP compound functions is shown in Figure 5-3.



**Figure 5-3 – MT MIP compound functions  
(Same as Figure 9-41 of [ITU-T G.8121])**

The diagrammatic convention for half MIP compound functions is shown in Figure 5-4.

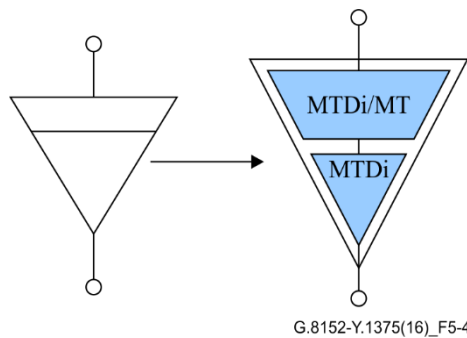

**Figure 5-4 – MT half MIP compound functions  
(Same as Figure 9-42 of [ITU-T G.8121])**

### 5.2.3 MEPs and MIPs along a Maintenance Entity

The diagrammatic convention for MEPs and MIPs along an individual ME as shown in Figure 5-5:

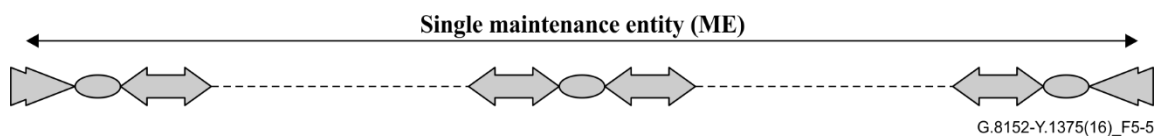

**Figure 5-5 – MEPs and MIPs along a maintenance entity (ME)**

Note that the ME can span the whole end-to-end network connection or a portion of it called a tandem connection.

## 5.3 Conventions defined in this Recommendation

This Recommendation uses the following conventions:

### 5.3.1 Colour code convention

The following "colour code" is used in this Recommendation:

**Table 5-1 – Colour code convention**

"colour code"	ITU-T G.8152 object class
	MaintenanceEntityGroupEndPoint
	MT_TrailTerminationPoint
	MT_ConnectionTerminationPoint
	OnDemandMeasurementJob
	ProActiveMeasurementJob
	MaintenanceJob
	TerminationPointPool
	Specific highlighting
	Not in scope

### 5.3.2 Modelling convention for adaptation functions

Every adaptation function has a MI\_Active parameter. This is not modelled since it will always be active in the MPLS-TP technology.

#### 5.3.2.1 MPLS-TP server adaptation modelling

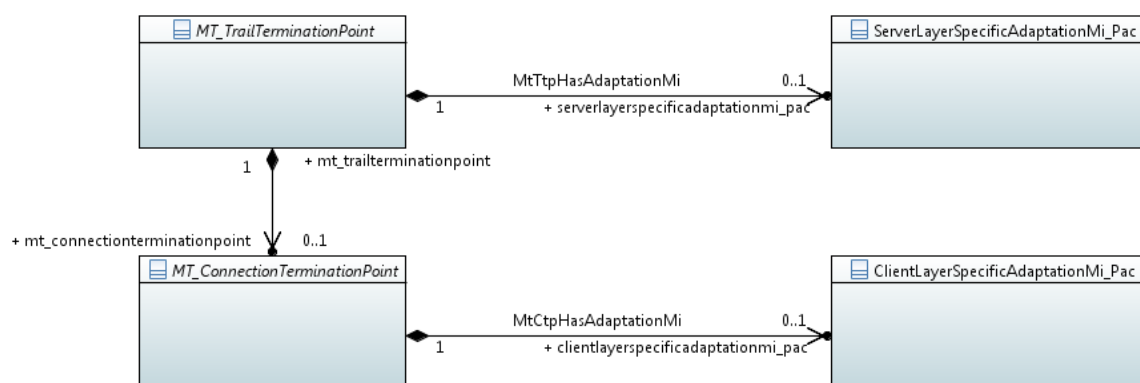

**Figure 5-6 – Illustrative diagram for MPLS-TP server adaptation modelling**

#### 5.3.2.2 Non-MPLS-TP server adaptation modelling

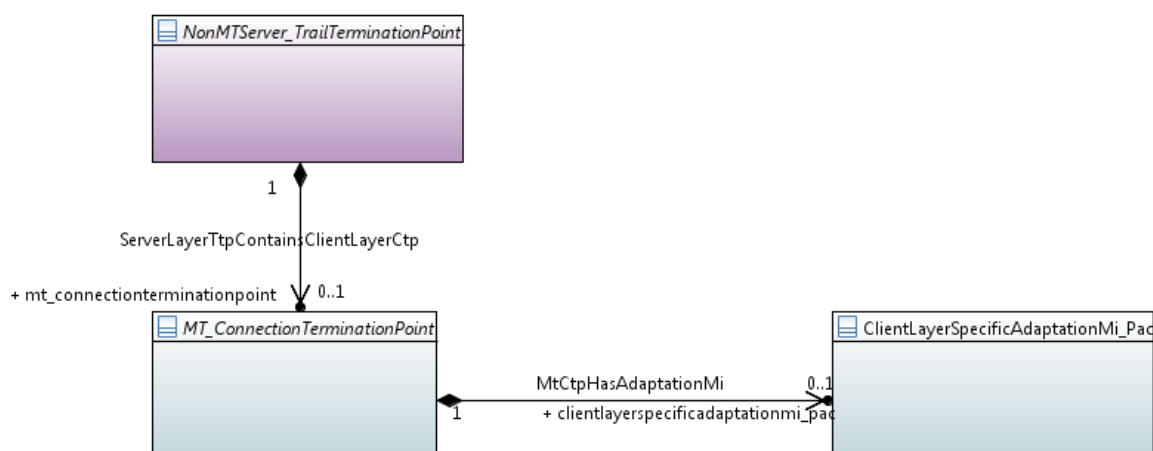

NOTE – This figure is also available from the ITU website [here](#).

**Figure 5-7 – Illustrative diagram for non-MPLS-TP server adaptation modelling**



## 6 Overview of the model

Figure 6-1 below shows the mapping between the object classes and the MPLS-TP atomic functions based on Figure 1 of [ITU-T G.8121].

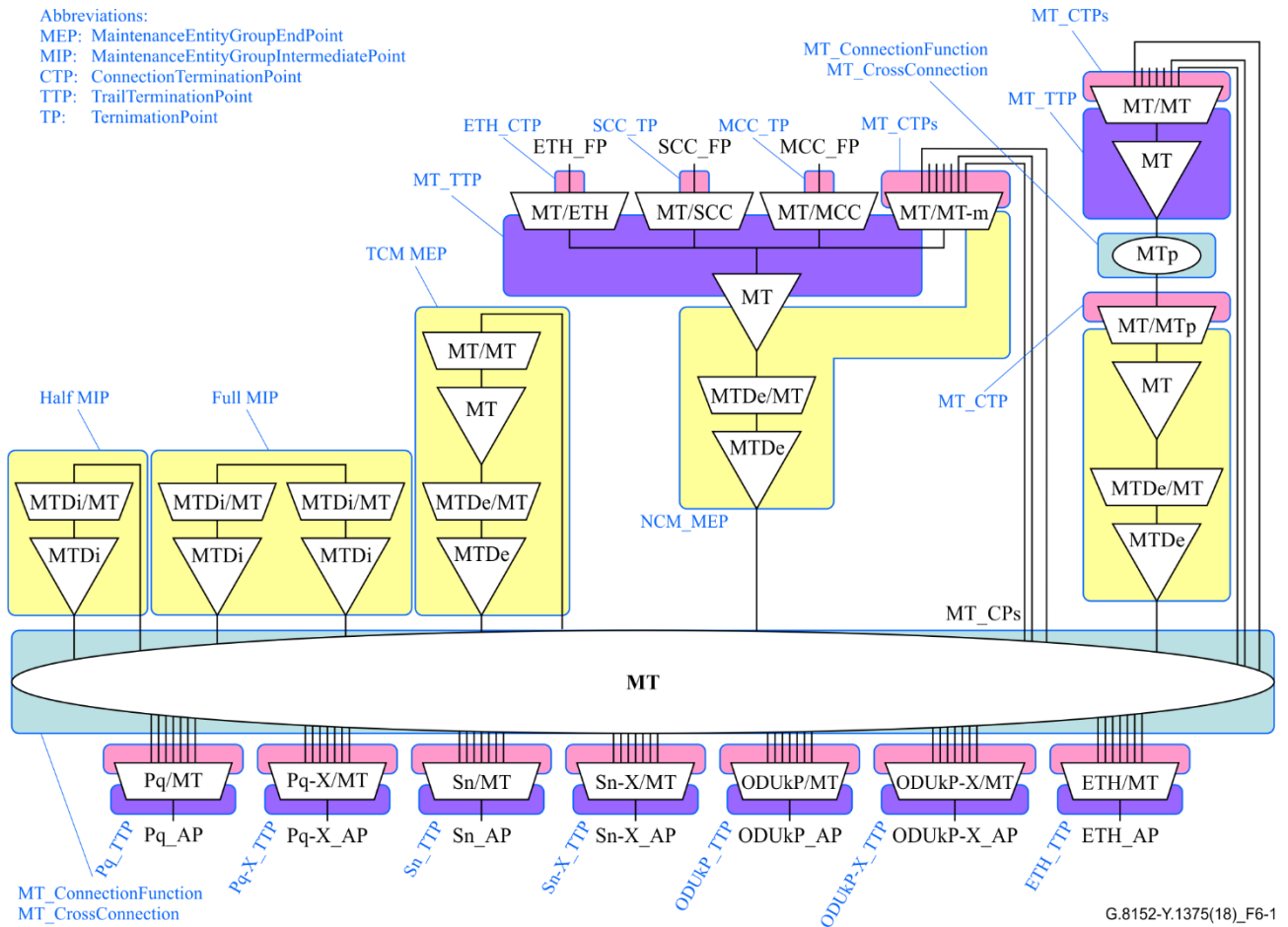

**Figure 6-1 – Overview of object class mapping to ITU-T G.8121 atomic functions  
 (Based on Figure 1 of [ITU-T G.8121])**

Figure 6-2 below shows the containment relationship among the MPLS-TP object classes defined in this Recommendation. The containment relationship reflects the lifecycle dependency between object instances.

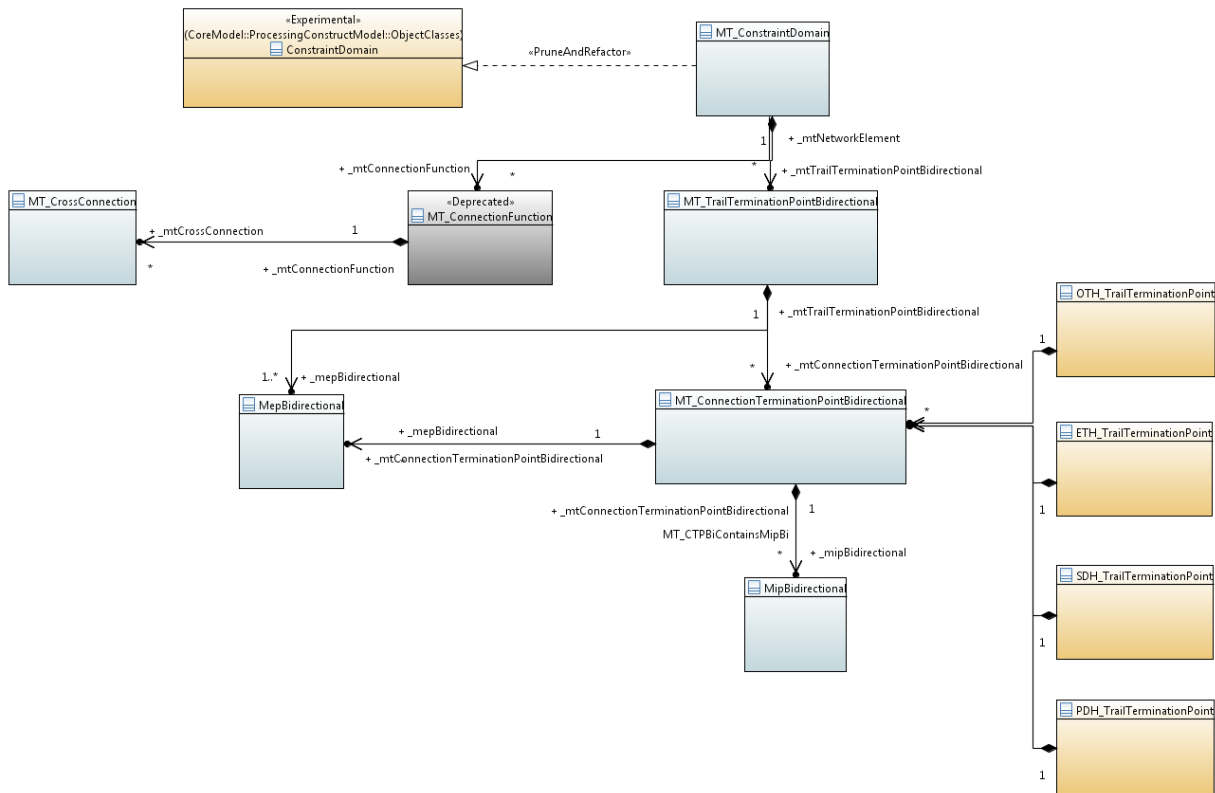

NOTE – This figure is also available from the ITU website [here](#).

**Figure 6-2 – MPLS-TP object class containment relationship**

Figure 6-3 below shows the relationship of the MPLS-TP object classes to the GlobalClass and LocalClass objects defined in the [ITU-T G.7711] Core Model for inheriting the uuid or the localIdList attributes. See [ITU-T G.7711] Annex C for how the identifier attributes uuid and localIdList are used for identifying object instance.

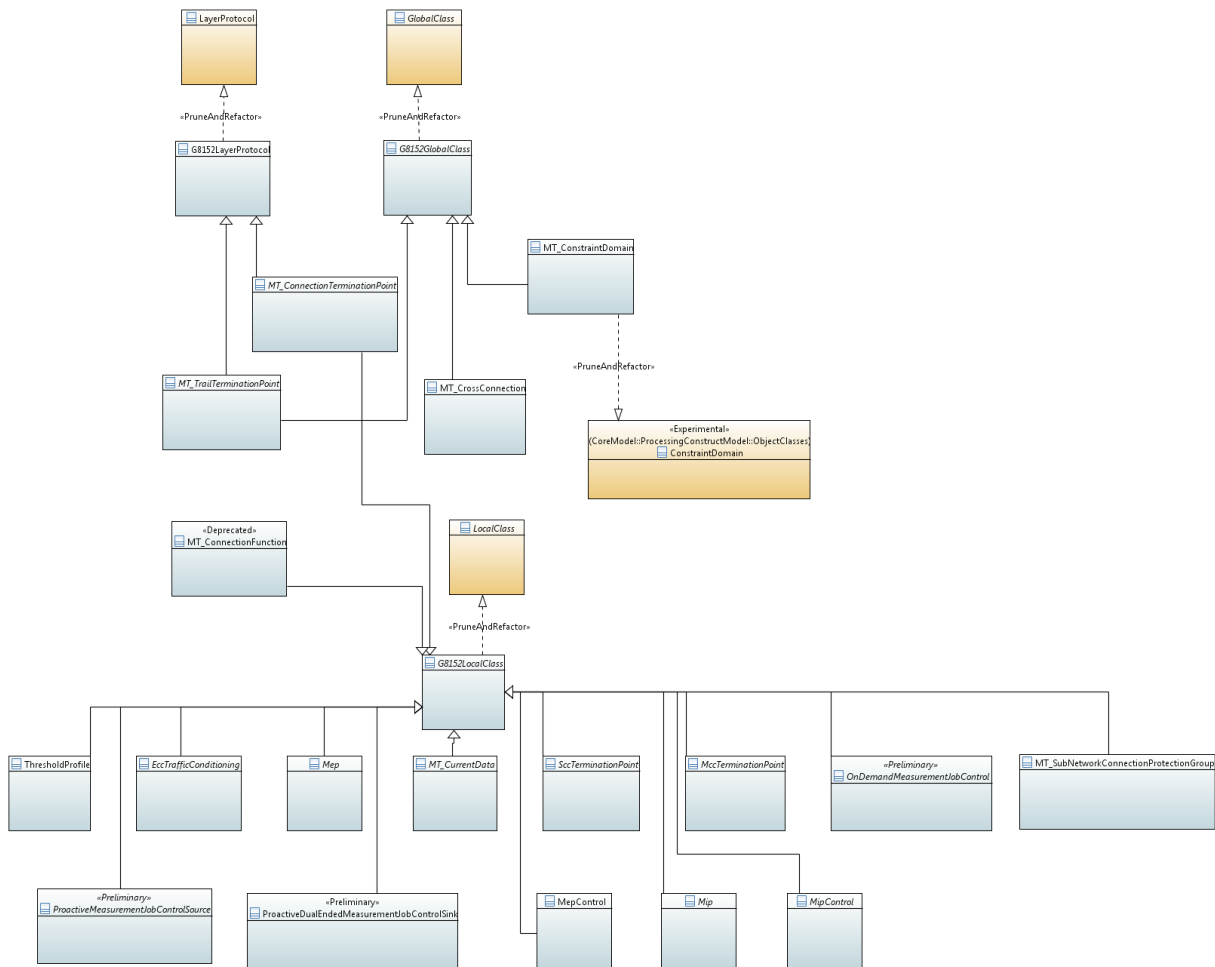

NOTE – This figure is also available from the ITU website [here](#).

**Figure 6-3 – MPLS-TP object class identifier**

## 6.1 Basic configuration structure

This clause contains the initial high level class diagrams. Once completed, they will be moved to the corresponding sections in the Recommendation.

### 6.1.1 High-level TP containment class diagram

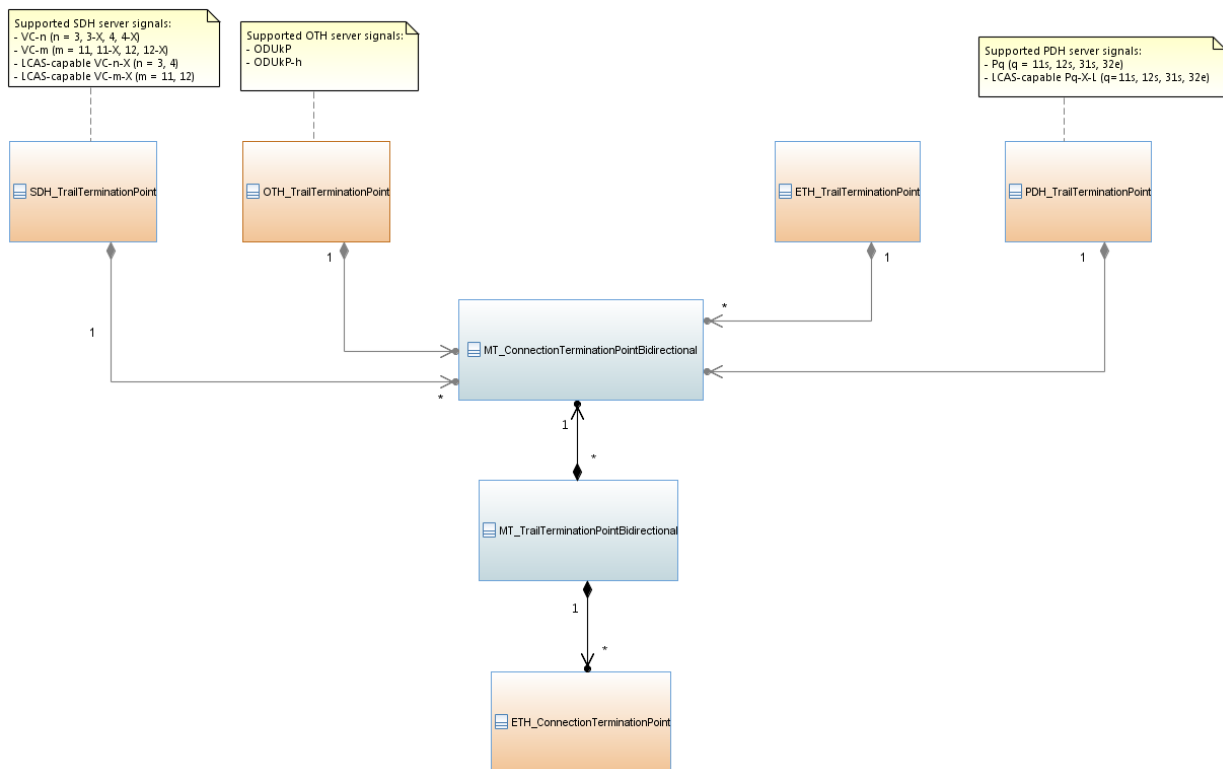

NOTE – This figure is also available from the ITU website [here](#).

**Figure 6-4 – High-level TP containment class diagram**

## 6.1.2 TP inheritance class diagram

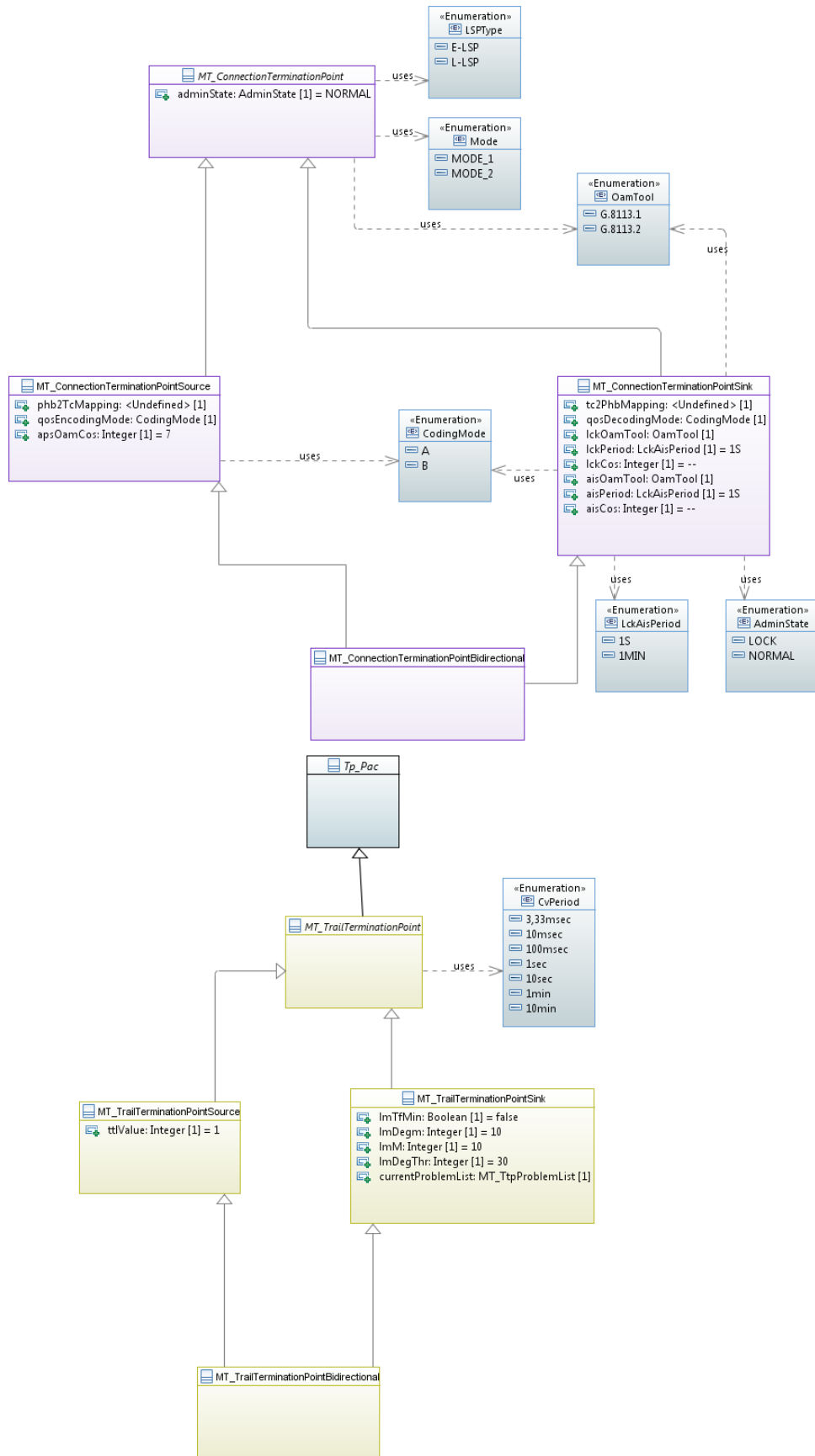

NOTE – This figure is also available from the ITU website [here](#).

**Figure 6-5 – TP inheritance class diagram**

### 6.1.3 Connection fragment class diagram

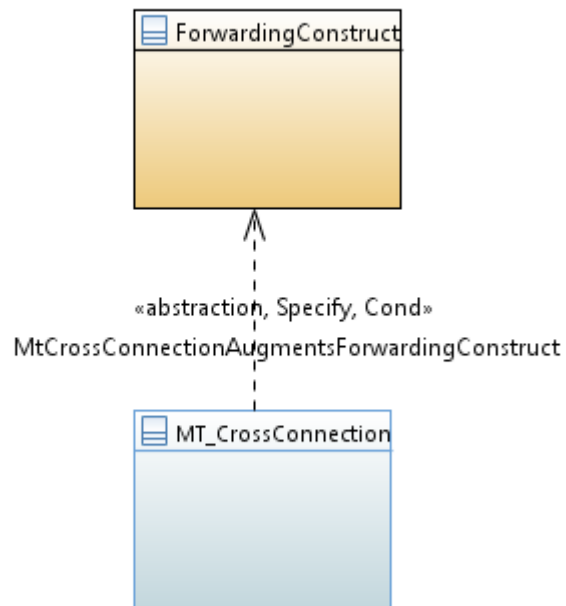

NOTE – This figure is also available from the ITU website [here](#).

**Figure 6-6 – Connection fragment class diagram**

## 6.1.4 MEP class diagram

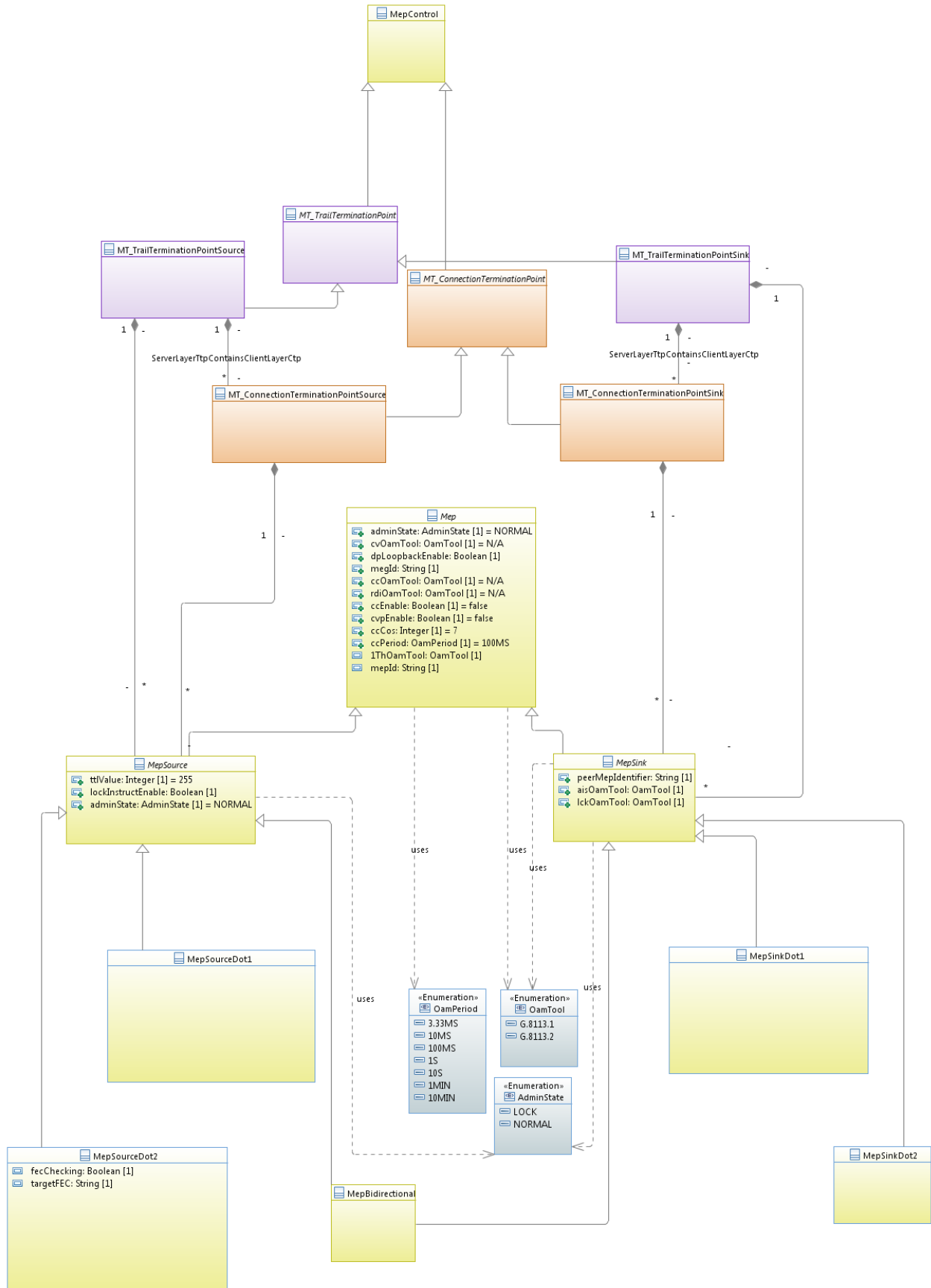

NOTE – This figure is also available from the ITU website [here](#).

Figure 6-7 – MEP class diagram

## 6.1.5 MIP class diagram

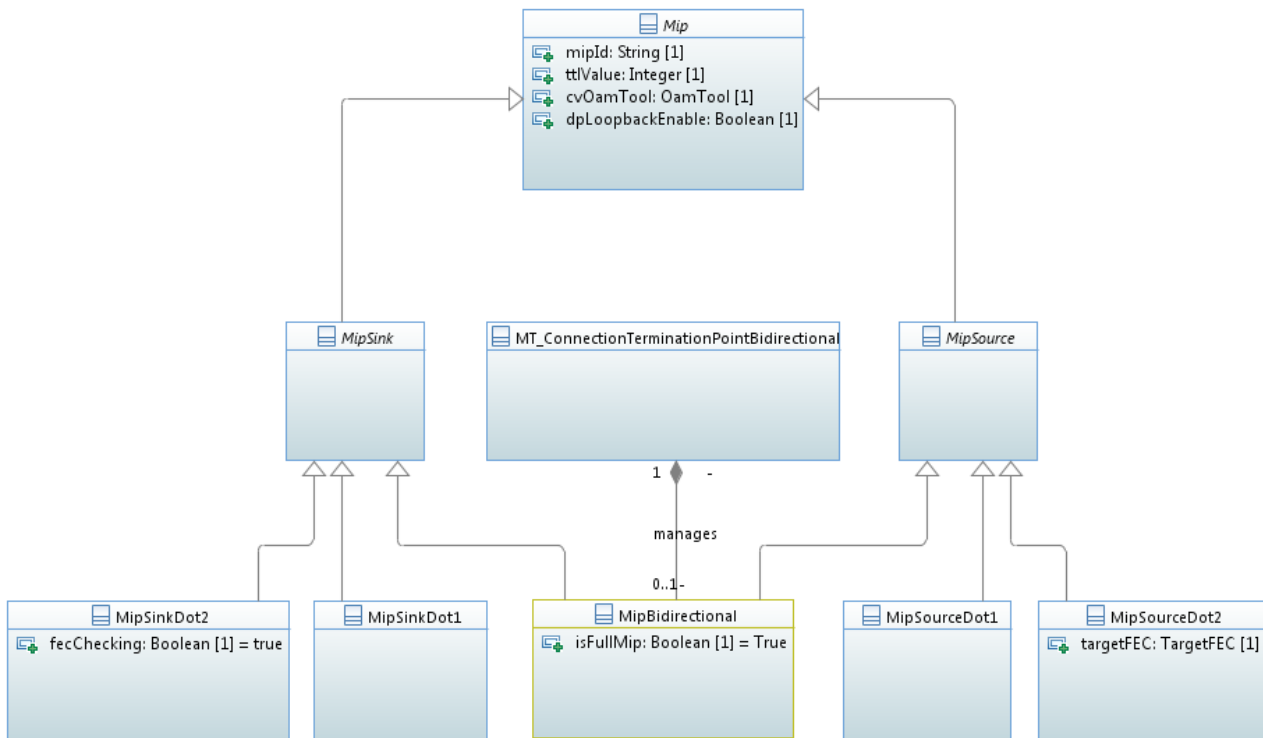

NOTE – This figure is also available from the ITU website [here](#).

**Figure 6-8 – MIP and Dot1 and Dot2 class diagram**



## 6.1.6 On-demand measurement class diagram

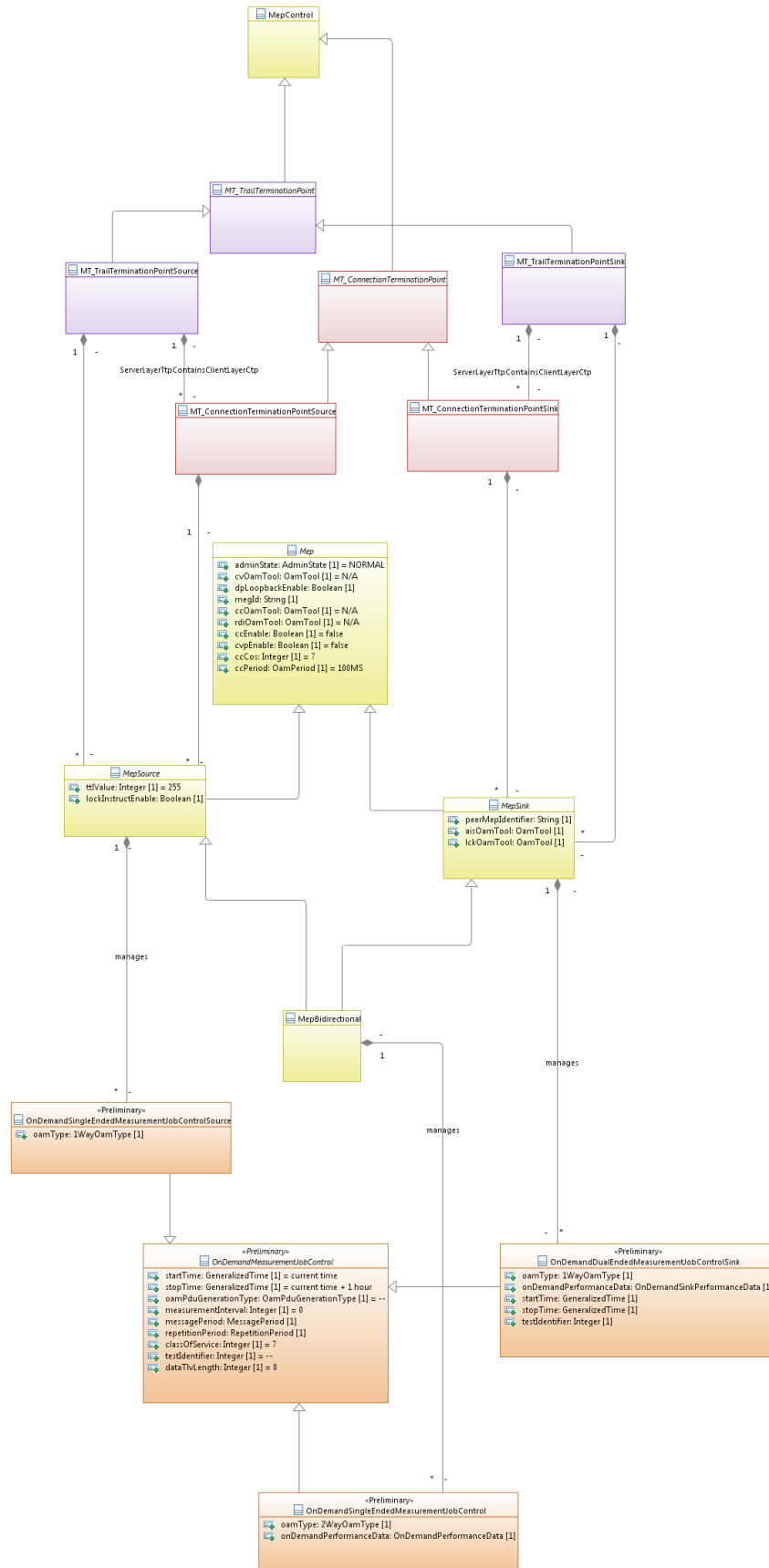

NOTE – This figure is also available from the ITU website [here](#).

**Figure 6-9 – On-demand measurement class diagram**

## 6.1.7 Proactive measurement class diagram

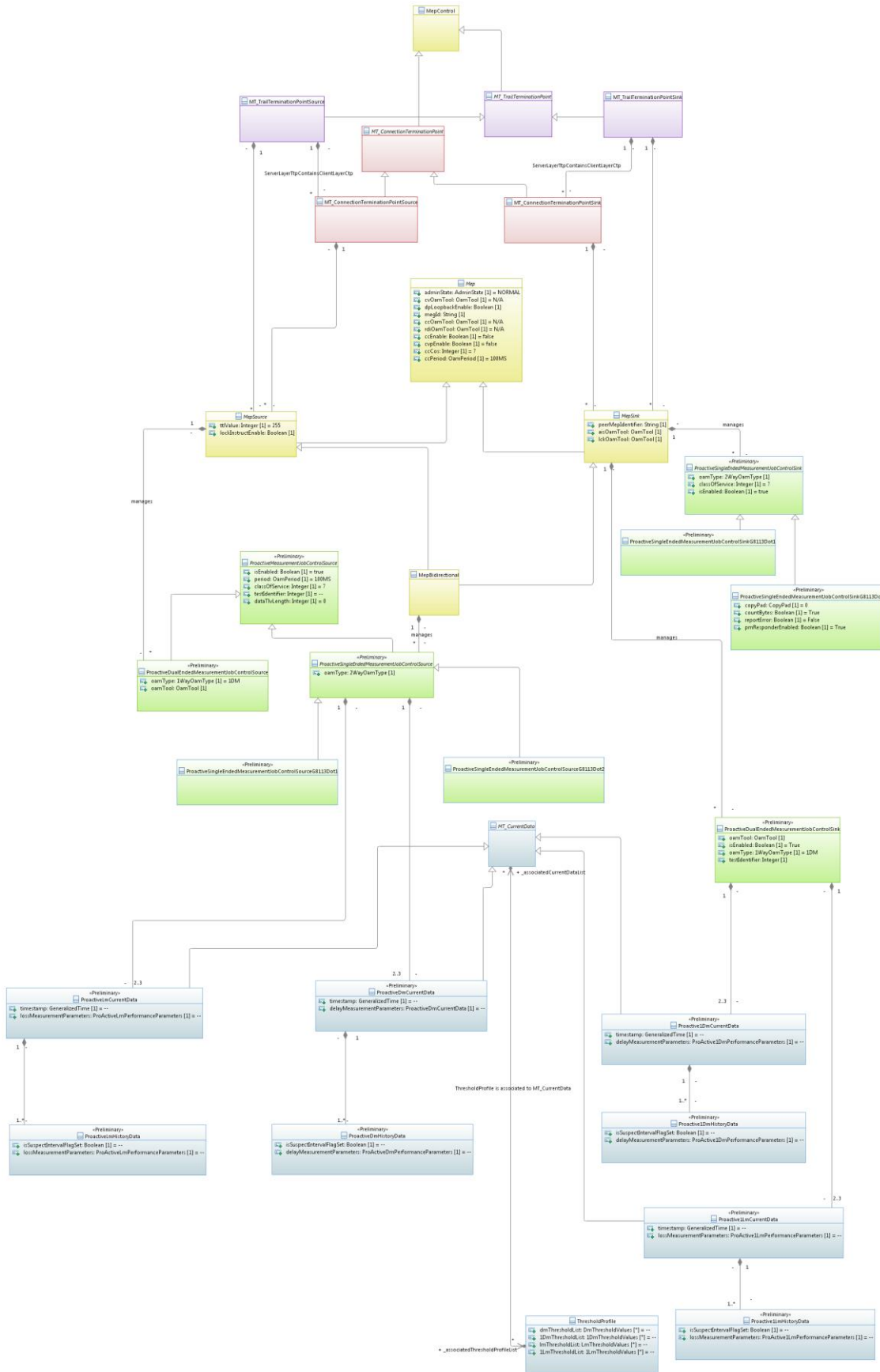

NOTE – This figure is also available from the ITU website [here](#).

Figure 6-10 – Proactive measurement and generic class diagram

## 6.2 MI grouping and mapping

This clause lists (from [ITU-T G.8121]) all atomic functions together with their MI. It is structured according to clause 9 of [ITU-T G.8121].

Conventions used in the tables:

- Atomic functions having the same list of MI are grouped.
- Fault and performance MIs are not shown.
- MI of adaptation functions are identified as "client layer related" (blue) or "server layer related" (red).

### 6.2.1 MPLS-TP connection function (MT\_C)

**Table 6-1 – MI groupings of the MPLS-TP connection function**

Symbol	Management information	Managed object class
MPLS-TP connection function		
	MI_MatrixControl <i>per matrix connection:</i> MI_ConnectionType MI_Return_CP_ID MI_ConnectionPortIds <i>per SNCP protection group:</i> MI_PS_WorkingPortId MI_PS_ProtectionPortId MI_PS_ProtType MI_PS_OperType MI_PS_HoTime MI_PS_WTR MI_PS_ExtCMD MI_PS_BridgeType MI_PS_SD_Protection	

### 6.2.2 MPLS-TP termination function (MT\_TT)

**Table 6-2 – MI groupings of the MPLS-TP termination function**

Symbol	Management information	Managed object class
MPLS-TP (MT) trail termination source function		
	MI_GAL_Enable MI_TTLVALUE MI_MEG_ID MI_MEP_ID MI_CC_OAM_Tool MI_RDI_OAM_Tool MI_CC_Enable MI_CVp_Enable MI_CC_CoS MI_CC_Period MI_LMp_OAM_Tool	

**Table 6-2 – MI groupings of the MPLS-TP termination function**

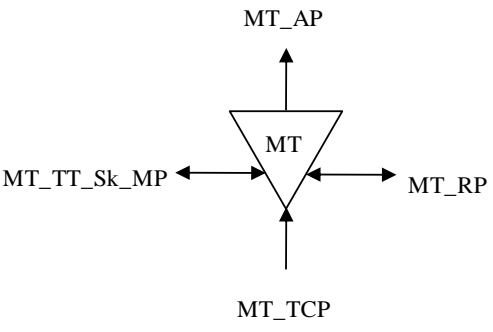
Symbol	Management information	Managed object class
	MI_LMp_Enable[i] MI_LMp_Period[i] MI_LMp_CoS[i] MI_DMp_OAM_Tool MI_DMp_Enable[i] MI_DMp_Period[i] MI_DMp_Test_ID[i] MI_DMp_CoS[i] MI_DMp_Length[i] MI_1DMp_OAM_Tool MI_1DMp_Enable[i] MI_1DMp_Period[i] MI_1DMp_Test_ID[i] MI_1DMp_Length[i] MI_1DMp_CoS[i] MI_SLp_OAM_Tool MI_SLp_Enable[i] MI_SLp_Period[i] MI_SLp_Test_ID[i] MI_SLp_Length[i] MT_TT_So_MI_SLp_CoS[i]	
G.8121.1 specific	MI_LMC_Enable	
G.8121.2 specific	MI_CCCV_Mode[i] MI_Local_Discr MI_DMp_CopyPad[i] MI_LMp_Test_ID[i] MI_LMp_LMType[1...MLMp] MI_LMp_CountBytes[i]	
<b>MPLS-TP (MT) trail termination sink function</b>		
	MI_GAL_Enable MI_MEG_ID MI_PeerMEP_ID MI_CC_OAM_Tool MI_RDI_OAM_Tool MI_CC_Enable MI_CVp_Enable MI_CC_Period MI_CC_CoS MI_Get_SvdCC MI_LMp_OAM_Tool MI_LMp_Enable[i] MI_LMp_CoS[i] MI_LM_DEGM MI_LM_M	

**Table 6-2 – MI groupings of the MPLS-TP termination function**

Symbol	Management information	Managed object class
	MI_LM_DEGTHR MI_LM_TFMIN MI_DMp_OAM_Tool MI_DMp_Enable[i] MI_DMp_CoS[i] MI_1DMp_OAM_Tool MI_1DMp_Enable[i] MI_1DMp_Test_ID[i] MI_Slp_OAM_Tool MI_Slp_Enable[i] MI_Slp_CoS[i] MI_AIS_OAM_Tool MI_LCK_OAM_Tool MI_1second	
G.8121.1 specific	MI_LMC_Enable	
G.8121.2 specific	MI_CCCV_Mode[i] MI_Remote_Discr[i] MI_PM_ClearError MI_PM_Responder_Enable	

**6.2.3 MPLS-TP to MPLS-TP adaptation function (MT/MT\_A)**

**Table 6-3 – MI Groupings of the MPLS-TP to MPLS-TP adaptation function**

Symbol	Management information (blue: client layer related red: server layer related)	Managed object class
MPLS-TP to MPLS-TP adaptation source function		
	MI_Active MI_Admin_State MI_Label[i] MI_LSPTType[i] MI_CoS[i] MI_PHB2TCMapping[i] MI_QoSEncodingMode[i] MI_Mode MI_LCK_Period[i] MI_LCK_CoS[i] MI_LCK_OAM_Tool[i] MI_GAL_Enable[i] (NOTE – Should be MI_GAL_Enable set double (Server and client?)) MI_APS_CoS MI_APS_OAM_Tool	

**Table 6-3 – MI Groupings of the MPLS-TP to MPLS-TP adaptation function**

Symbol	Management information (blue: client layer related red: server layer related)	Managed object class
MPLS-TP to MPLS-TP adaptation sink function		
	<b>MI_Active</b> MI_AdminState MI_Label[i] MI_LSPTType[i] MI_CoS[i] MI_TC2PHBMapping[i] MI_QoSDecodingMode[i] MI_Mode MI_AIS_Period[i] MI_AIS_CoS[i] MI_AIS_OAM_Tool[i] MI_LCK_Period[i] MI_LCK_CoS[i] MI_LCK_OAM_Tool[i] <b>MI_APS_OAM_Tool</b> MI_GAL_Enable [i] (NOTE – Should be MI_GAL_Enable set double (Server and cliene)?)	
G.8121.2 specific	MI_Local_Defect[i]	

**6.2.4 MT diagnostic functions (MTDe and MTDi)**

**Table 6-4 – MI groupings of the MT diagnostic functions**

Symbol	Management information	Managed object class
MT diagnostic trail termination source function for MEP (MTDe_TT_So)		
	MI_GAL_Enable MI_TTLVALUE MI_CV_OAM_Tool MI_CV_Series () MTDe_TT_So_MI_1TH_OAM_Tool MI_1TH_Start (CoS,Length,Period) MI_1TH_Terminate MI_LMo_OAM_Tool MI_LMo_Start(CoS,Period) [i] MI_LMo_Terminate[i] MI_DMo_OAM_Tool MI_DMo_Start (CoS,Test_ID,Length,Period)[i] MI_DMo_Terminate[i] MI_1DMo_OAM_Tool	

**Table 6-4 – MI groupings of the MT diagnostic functions**

Symbol	Management information	Managed object class
	MI_1DMo_Start(CoS,Test_ID,Length,Period)[i] MI_1DMo_Terminate[i] MI_SLo_OAM_Tool MI_SLo_Start (CoS,Test_ID,Length,Period)[i] MI_SLo_Terminate[i] MI_Admin_State MI_Lock_Instruct_Enable MI_DP_Loopback_Enable	
G.8121.1 specific	MI_MEP_ID MI_CV_Series (Target MEP/MIP ID, CoS, N, Length, Period) MI_CV_Test(CoS, Pattern, Length, Period)	
G.8121.2 specific	MI_CV_Series (Session_ID, Count, Period, CoS, Size, ValidateFEC, ValidateReverse, TargetFECStack) MI_CV_Trace (Session_ID, CoS, ValidateFEC, ValidateReverse, TargetFECStack) MI_FEC_Checking MI_Target_FEC MI_Iffnum MI_MTU MI_DMo_Start(CoS, Test_ID, Length, Period, CopyPad)[i] MI_LMo_Start(CoS, Test_ID, Period, LMType,CountBytes)[i] LMDMo_Start(CoS, Test_ID, Length, Period, LMType, CountBytes, CopyPad)[i] MI_LMDMo_Terminate [i] MI_LI_Period MI_LI_MEPID MI_LI_CoS	

**Table 6-4 – MI groupings of the MT diagnostic functions**

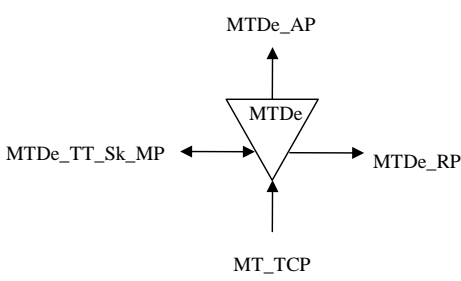
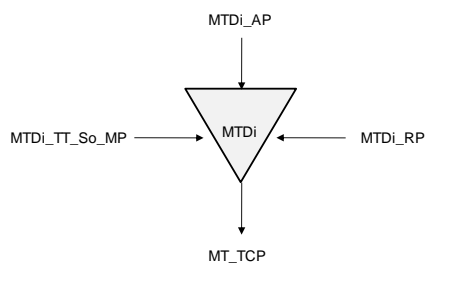
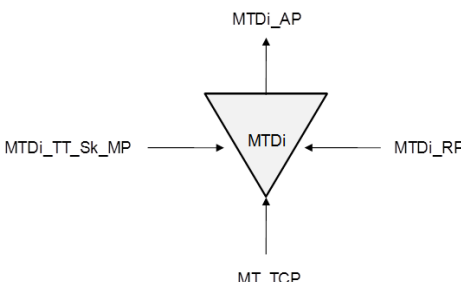
Symbol	Management information	Managed object class
<b>MT diagnostic trail termination sink function for MEP (MTDe_TT_Sk)</b>		
	MI_GAL_Enable MI_CV_OAM_Tool MI_1TH_OAM_Tool MI_1TH_Start MI_1TH_Terminate MI_LMo_OAM_Tool MI_DMo_OAM_Tool MI_1DMo_OAM_Tool MI_1DMo_Start(Test_ID)[i] MI_1DMo_Terminate[i] MI_SLo_OAM_Tool MI_DP_Loopback_Enable	
G.8121.1 specific	MI_MEP_ID MI_1TH_Start(Period)	
G.8121.2 specific	MI_FEC_Checking PM_Responder_Enable	
<b>MT diagnostic trail termination source function for MIP (MTDi_TT_So)</b>		
	MI_GAL_Enable MI_TTLVALUE MI_MIP_ID MI_CV_OAM_Tool MI_DP_Loopback_Enable	
G.8121.2 specific	MI_Target_FEC MI_Ifnun MI_MTU	
<b>MT diagnostic trail termination sink function for MIP (MTDi_TT_Sk)</b>		
	MI_GAL_Enable MI_MIP_ID MI_CV_OAM_Tool MI_DP_Loopback_Enable	
G.8121.2 specific	MI_FEC_Checking	



## 6.2.5 MPLS-TP to non-MPLS-TP client adaptation functions

**Table 6-5 – MI groupings of the MPLS-TP to non-MPLS-TP client adaptation functions**

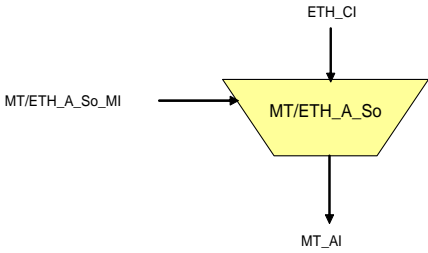
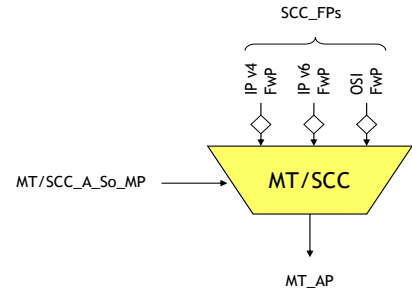
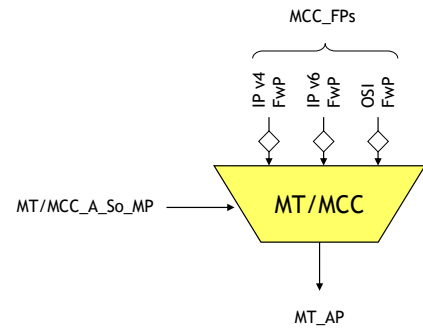
Symbol	Management information (blue: client layer related red: server layer related)	Managed object class
MPLS-TP to non-MPLS-TP client adaptation <b>source</b> functions		
	<ul style="list-style-type: none"> <li>MI_AdminState</li> <li>MI_FCSEnable</li> <li>MI_CWEnable</li> <li>MI_SQUse</li> <li>MI_PRI2PSCMapping</li> <li>MI_MEP_MAC*</li> <li>MI_Client_MEL*</li> <li>MI_LCK_Period*</li> <li>MI_LCK_Pri*</li> <li>MI_MEL*</li> <li>* ETH OAM related</li> </ul>	
	<ul style="list-style-type: none"> <li>MI_Active</li> <li>MI_ECC_CoS</li> <li>MI_GAL_Enable</li> </ul>	
	<ul style="list-style-type: none"> <li>MI_Active</li> <li>MI_ECC_CoS</li> <li>MI_GAL_Enable</li> </ul>	

**Table 6-5 – MI groupings of the MPLS-TP to non-MPLS-TP client adaptation functions**

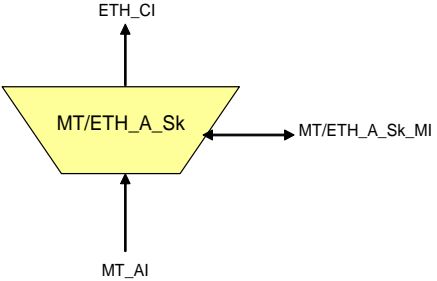
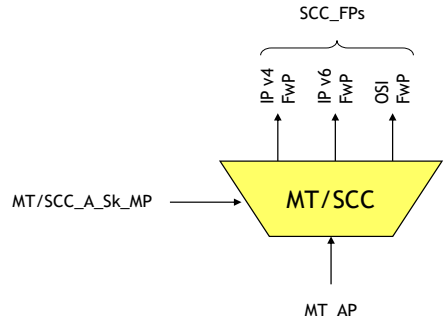
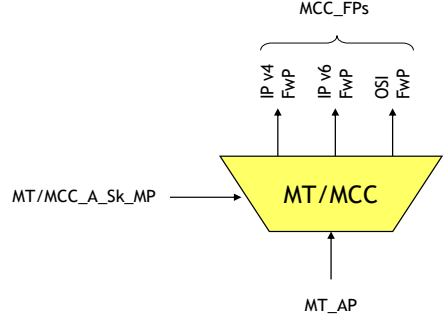
Symbol	Management information (blue: client layer related red: server layer related)	Managed object class
MPLS-TP to non-MPLS-TP client adaptation <b>sink</b> functions		
	<p>MI_Admin_State  MI_LCK_Period *  MI_LCK_Pri *  MI_Client_MEL *  MI_MEP_MAC *  MI_AIS_Pri *  MI_AIS_Period *  MI_MEL  MI_FCSEnable  MI_CWEnable  MI_SQUse  MI_GAL_Enable  MI_CoS2PRIMapping  * ETH OAM related</p>	
	<p>MI_Active  MI_GAL_Enable</p>	
	<p>MI_Active  MI_GAL_Enable</p>	

## 6.2.6 Non-MPLS-TP server to MPLS-TP adaptation functions

**Table 6-6 – MI groupings of the non-MPLS-TP server to MPLS-TP adaptation functions**

Symbol	Management information (blue: client layer related red: server layer related)	Managed object class
Non-MPLS-TP server to MPLS-TP adaptation <b>source</b> functions		
	<p>MI_Active</p> <p>MI_SCCType (not in ETH/MT)</p> <p>MI_Etype (only in ETH/MT)</p> <p>MI_Label[1...M]</p> <p>MI_LSPTType[1...M]</p> <p>MI_CoS[1...M]</p> <p>MI_PHB2TCMapping[1...M]</p> <p>MI_QoSEncodingMode[1...M]</p> <p>MI_Mode[1...M]</p> <p>MI_GAL_Enable[1...M]</p> <p>Only in ODUkP-h/MT:</p> <p>MI_INCREASE</p> <p>MI_DECREASE</p> <p>MI_TSNUM</p> <p>MI_ODUflexRate</p>	

**Table 6-6 – MI groupings of the non-MPLS-TP server to MPLS-TP adaptation functions**

Symbol	Management information (blue: client layer related red: server layer related)	Managed object class
Non-MPLS-TP server to MPLS-TP adaptation <b>sink</b> functions		
	<p>MI_Active</p> <p>MI_SCCType (not in ETH/MT)</p> <p>MI_Etype (only in ETH/MT)</p> <p>MI_Frame_Type_Config (only in ETH/MT)</p> <p>MI_Label[1...M]</p> <p>MI_LSPTType[1...M]</p> <p>MI_CoS[1...M]</p> <p>MI_TC2PHBMapping[1...M]</p> <p>MI_QoSDecodingMode[1...M]</p> <p>MI_Mode</p> <p>MI_LCK_Period[1...M]</p> <p>MI_LCK_CoS[1...M]</p> <p>MI_Admin_State</p> <p>MI_AIS_Period[1...M]</p> <p>MI_AIS_CoS[1...M]</p> <p>MI_GAL_Enable[1...M]</p> <p>MI_LCK_OAM_Tool [1...M]</p> <p>MI_AIS_OAM_Tool[1...M]</p> <p>Only in ODUkP-h/MT:</p> <p>MI_INCREASE</p> <p>MI_DECREASE</p> <p>MI_AcSL</p> <p>MI_AcEXI</p> <p>MI_LastInvalidUPI</p> <p>MI_cPLM</p> <p>MI_cLFD</p> <p>MI_cEXM</p> <p>MI_cUPM (not ETH/MT)</p>	
G.8121.2 specific	MI_Local_Defect[i]	

Based on the groupings above the following packages have been identified.

**Table 6-7 – Derived MI groupings of the MPLS-TP functions**

MI groupings	Package/Object class name
<b>TTP MI source grouping</b>	
MI_Active	
MI_INCREASE MI_DECREASE MI_TSNUM MI_ODUflexRate	HaoCapableTtpSource_Pac
<b>TTP MI sink grouping</b>	
MI_Active	
MI_Frame_Type_Config	EthServerTtpSink_Pac
MI_INCREASE MI_DECREASE	HaoCapableTtpSink_Pac
<b>TTP MI grouping</b>	
MI_SCCType	GfpMapping_Pac
MI_Etype	EthServerTtp_Pac
<b>MT_CTP MI source grouping</b>	
MI_PHB2TCMapping[1...M] MI_QoSEncodingMode[1...M] MI_APS_OAM_CoS[1...M]	MT_ConnectionTerminationPointSource
<b>MT_CTP MI sink grouping</b>	
MI_TC2PHBMapping[1...M] MI_QoSDecodingMode[1...M] MI_LCK_Period[1...M] MI_LCK_CoS[1...M] MI_Admin_State MI_AIS_Period[1...M] MI_AIS_CoS[1...M] MI_LCK_OAM_Tool [1...M] MI_AIS_OAM_Tool[1...M]	MT_ConnectionTerminationPointSink
<b>MT_CTP MI grouping</b>	
MI_Label[1...M] MI_LSPTType[1...M] MI_CoS[1...M] MI_Mode[1...M] MI_GAL_Enable[1...M] MI_APS_OAM_Tool[1...M]	MT_ConnectionTerminationPoint

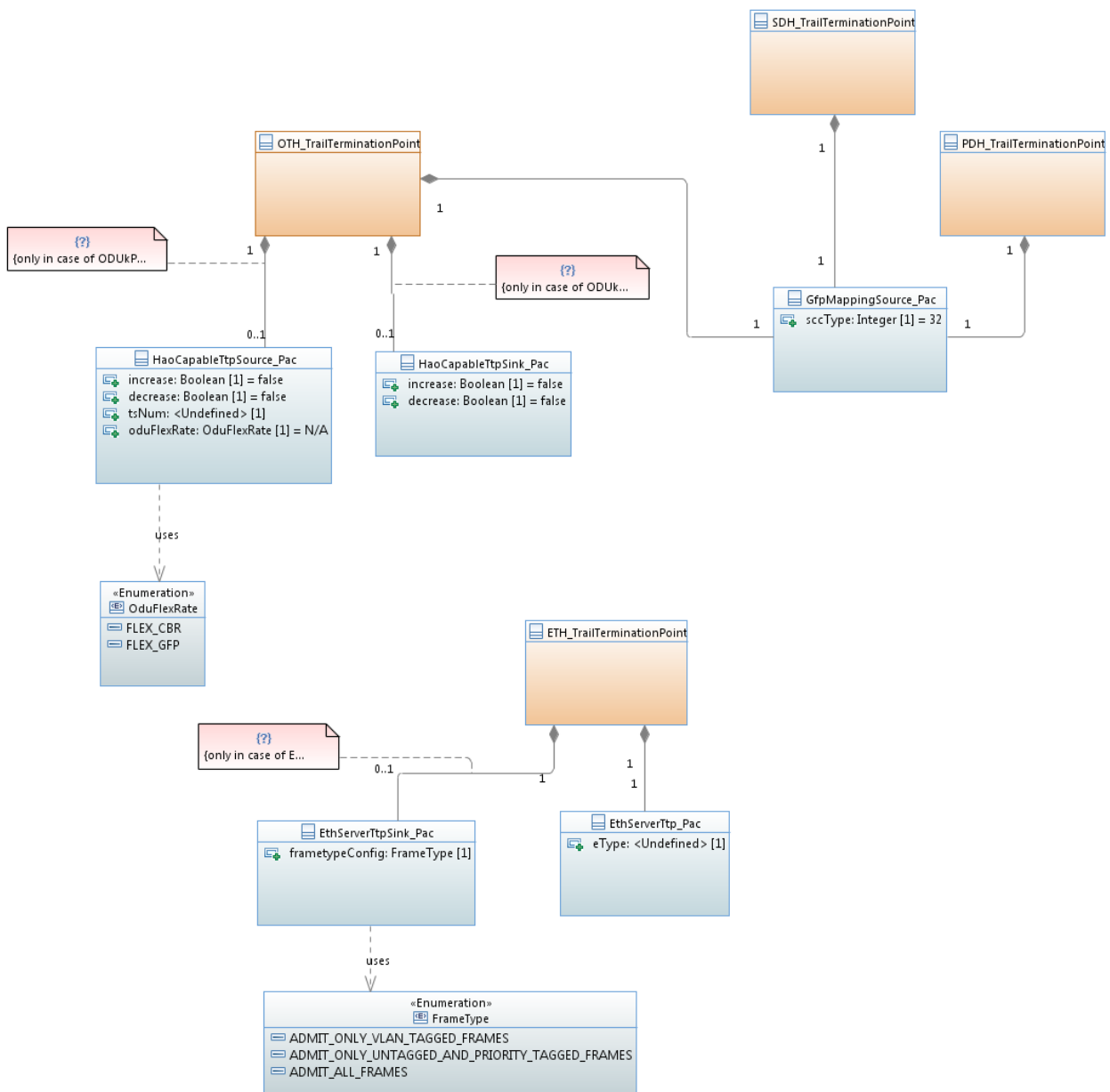

NOTE – This figure is also available from the ITU website [here](#).

**Figure 6-11 – Modelling of non-MPLS-TP server adaptation MI groupings**

## 7 Modelling of MPLS-TP functions

### 7.1 OAM compound functions

OAM is done in the network by creating maintenance entities (ME). In multipoint services multiple MEs are grouped together forming a maintenance entities group (MEG); see definitions in clause 8 (MPLS-TP OAM Architecture) of [ITU-T G.8110.1].

Each MEG is terminated by a set of MEG end points (MEPs). It is also possible to perform OAM functions on a MEG by MEG intermediate points (MIPs) which allow a limited set of OAM functions along the MEs.

**Table 7-1 – OAM capability support**

OAM function		OAM mechanism	
Compound function	MEP	Network connection monitoring	
		Tandem connection monitoring	
	MIP		(on-demand) CV
	TCS		–
Proactive measurement	Loss measurement	one-way	CCM (G.8121.1)
		two-way	LM (G.8121, G.8121.2), <i>LMDM (G.8121.2)</i>
		one-way synthetic	–
		two-way synthetic	SLM (G.8121) LM (G.8121.2) <i>LMDM (G.8121.2)</i>
	Delay measurement	one-way	IDM (G.8121)
		two-way	DM (G.8121, G.8121.2) <i>LMDM (G.8121.2)</i>
On-demand measurement	Loss measurement	two-way	LM (G.8121, G.8121.2), LMDM (G.8121.2)
		one-way synthetic	–
		two-way synthetic	SLM (G.8121) LM (G.8121.2) <i>LMDM (G.8121.2)</i>
	Delay measurement	one-way	IDM (G.8121, G.8121.1)
		two-way	DM (G.8121, G.8121.1, G.8121.2) <i>LMDM (G.8121.2)</i>
	Maintenance	one-way throughput test	1TH (G.8121, G.8121.1)
		On-demand loop back	CV (G.8121, G.8121.1, G.8121.2)
		On-demand link trace	CV (G.8121) CV (G.8121.2)
	Proactive fault management	Continuity check and connectivity verification	
Remote defect indication		RDI (G.8121, G.8121.1, G.8121.2)	
Alarm indication signal		AIS (G.8121, G.8121.1, G.8121.2)	
Locked signal (Lock report)		LCK (G.8121, G.8121.1, G.8121.2)	
On-demand fault management	Connectivity verification		CV (G.8121, G.8121.1, G.8121.2)
	Lock instruction		LKI (G.8121.2)
	Automatic protection switching		APS (G.8121)
	Management communication channel/ Signalling communication channel		MCC/SCC (G.8121)
NOTE 1 – OAM mechanisms for MEP are all the OAMs defined in [ITU-T G.8121] series. (The exception is APS. NCM MEP does not support APS.)			
NOTE 2 – OAM mechanism for MIP is (on-demand) CV only.			

### 7.1.1 MEP compound function

There are two different types of MEP compound functions:

- mandatory NCM MEPs at the boundary of a layer network, monitoring a network connection
- optional TCM MEPs in the middle of a layer network, monitoring a tandem connection.

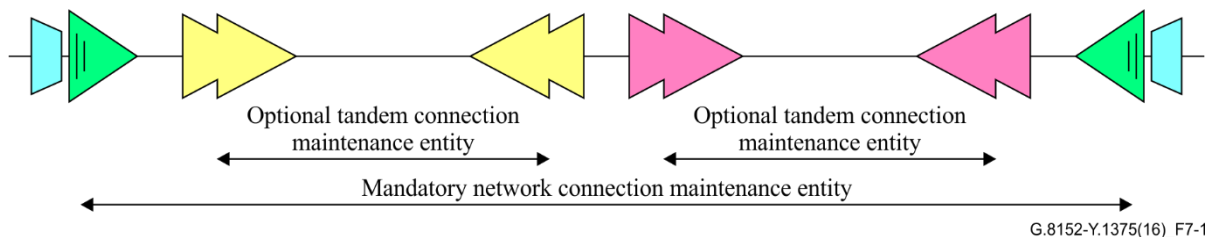

**Figure 7-1 – Mandatory and optional MEPs**

From management point of view a MEP has the following constraints:

- A MEP can be unidirectional or bidirectional; unidirectional MEPs have a limited set of OAM functionality.
- A MEP belongs to one, and only one, MEL. MEPs terminate MEGs and each MEG is associated to one MEL.
- A MEP is addressed by one, and only one, MAC address. The MAC address (or more precise the EUI-48) is bound to a physical subsystem and one physical subsystem can hold thousands of MEP functions, and all those MEP functions share in such case one MAC address.

The MEP compound function supports three applications which are organised in "jobs":

- On-demand measurement job.
- Proactive measurement job.
- Maintenance job.



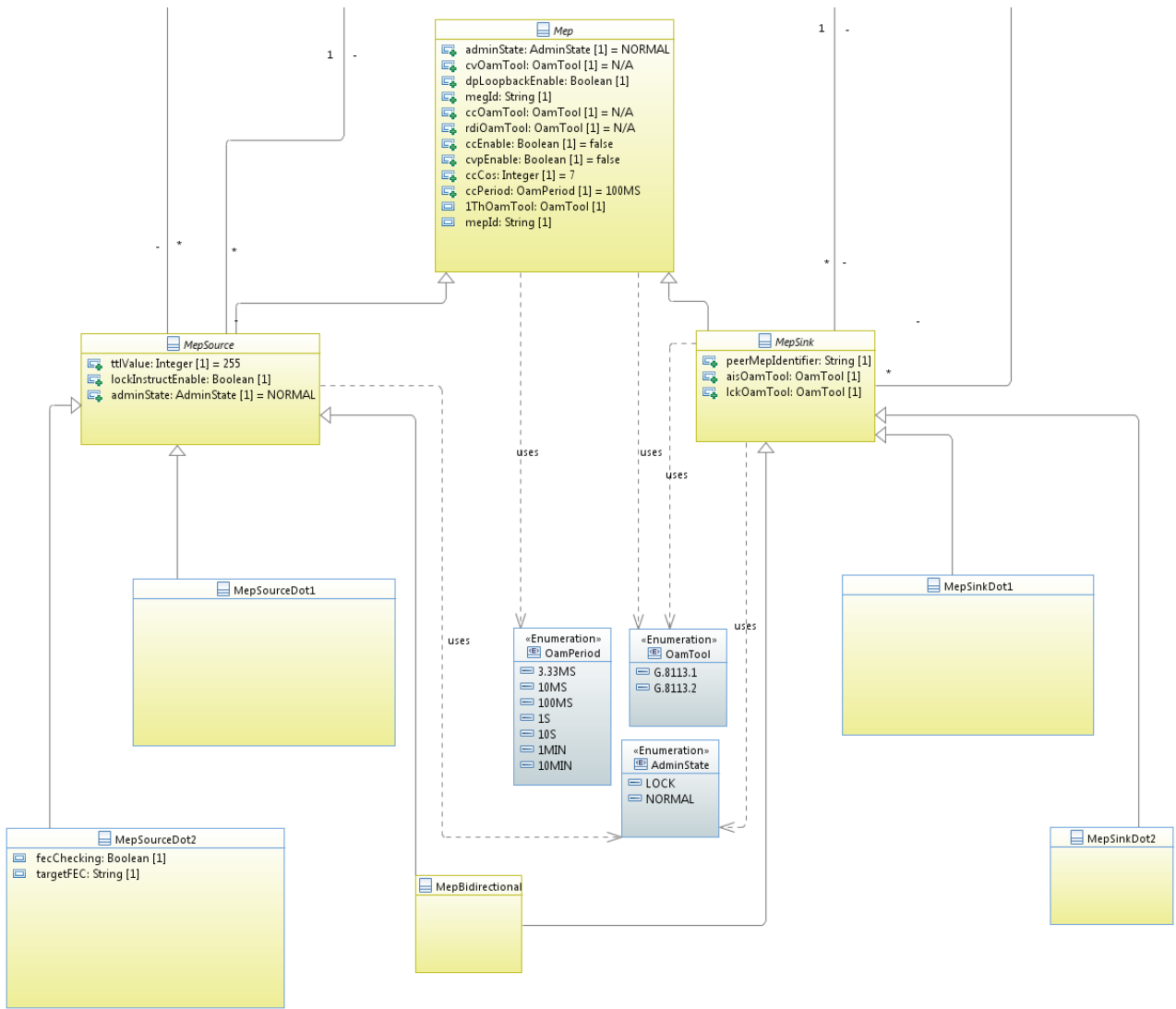

**Figure 7-2 – MEP class diagram**

NOTE –See also the lower part of Figure 6-7.

The management information (MI) of the compound functions (defined in [ITU-T G.8121]) needs to be mapped to ITU-T G.8152/Y.1375 artefacts. The following sections list all the MIs defined for the MEP compound function in tables and associate them to applications (coloured background). The corresponding part of the model is shown below the table.

### 7.1.1.1 MEP on-demand diagnostic function

The MEP on-demand diagnostic function exists in NCM and TCM MEPs.

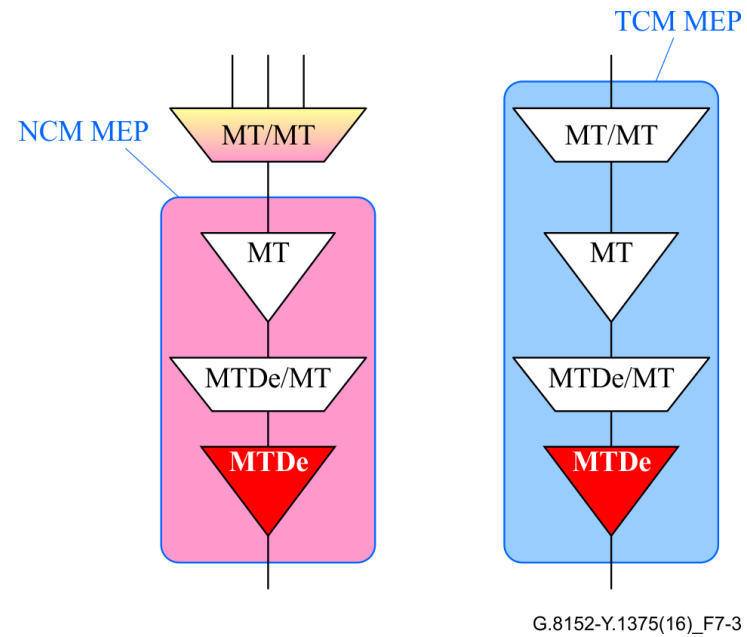

**Figure 7-3 – MEP on-demand diagnostic function**

[ITU-T G.8121] defines the following management information (MI) for on-demand measurements and maintenance as shown in Table 7-2.

**Table 7-2 – On-demand measurement and maintenance MI list**

Functionality	ITU-T G.8121 MTDe_TT_So_MI	ITU-T G.8121 MTDe_TT_Sk_MI	ITU-T G.8121.1 MTDe_TT_So_MI	ITU-T G.8121.1 MTDe_TT_Sk_MI	ITU-T G.8121.2 MTDe_TT_So_MI	ITU-T G.8121.2 MTDe_TT_Sk_MI
General	GAL_Enable	GAL_Enable	GAL_Enable	GAL_Enable	GAL_Enable	GAL_Enable
	TTLVALUE		TTLVALUE			
			MEP_ID	MEP_ID		
Two-way on-demand loss of frame measurement	LMo_OAM_Tool	LMo_OAM_Tool	LMo_OAM_Tool	LMo_OAM_Tool	LMo_OAM_Tool	LMo_OAM_Tool
	LMo_Start(CoS,Period)[1..M <sub>LMo</sub> ]		LMo_Start(CoS,Period)[1..M <sub>LMo</sub> ]		LMo_Start(CoS, Test_ID, Period, LMType, CountBytes)[1..M <sub>LMo</sub> ]	
	LMo_Intermediate_Request[1..M <sub>LMo</sub> ]		LMo_Intermediate_Request[1..M <sub>LMo</sub> ]		LMo_Intermediate_Request[1..M <sub>LMo</sub> ]	
	LMo_Terminate[1..M <sub>LMo</sub> ]		LMo_Terminate[1..M <sub>LMo</sub> ]		LMo_Terminate[1..M <sub>LMo</sub> ]	
	LMo_Result(N_TF,N_LF,F_TF,F_LF)[1..M <sub>LMo</sub> ]		LMo_Result(N_TF,N_LF,F_TF,F_LF)[1..M <sub>LMo</sub> ]		LMo_Result(N_TF, N_LF, F_TF, F_LF)[1..M <sub>LMo</sub> ]	
					LMo_ReportError(Error)[1..M <sub>LMo</sub> ]	
					LMo_PeriodChanged[1..M <sub>LMo</sub> ]	
One-way on-demand synthetic loss of frame measurement						
Two-way on-demand synthetic loss of frame measurement	SLo_OAM_Tool	SLo_OAM_Tool				
	SLo_Start(CoS,Test_ID,Length,Period)[1..M <sub>SLo</sub> ]					
	SLo_Intermediate_Request[1..M <sub>SLo</sub> ]					
	SLo_Terminate[1..M <sub>SLo</sub> ]					
	SLo_Result(N_TF,N_LF,F_TF,F_LF)[1..M <sub>SLo</sub> ]					
	IDMo_OAM_Tool	IDMo_OAM_Tool	IDMo_OAM_Tool	IDMo_OAM_Tool		

**Table 7-2 – On-demand measurement and maintenance MI list**

Functionality	ITU-T G.8121 MTDe_TT_So_MI	ITU-T G.8121 MTDe_TT_Sk_MI	ITU-T G.8121.1 MTDe_TT_So_MI	ITU-T G.8121.1 MTDe_TT_Sk_MI	ITU-T G.8121.2 MTDe_TT_So_MI	ITU-T G.8121.2 MTDe_TT_Sk_MI
One-way on-demand frame delay measurement	1DMo_Start (CoS,Test_ID,Length,Period)[1...M <sub>IDMo</sub> ]	1DMo_Start(Test_ID)[1...M <sub>IDMo</sub> ]	1DMo_Start (CoS,,Length,Period)[1...M <sub>IDMo</sub> ]	1DMo_Start[1...M <sub>IDMo</sub> ]		
	1DMo_Terminate[1...M <sub>IDMo</sub> ]	1DMo_Terminate[1...M <sub>IDMo</sub> ]	1DMo_Terminate[1...M <sub>IDMo</sub> ]	1DMo_Terminate[1...M <sub>IDMo</sub> ]		
Two-way on-demand frame delay measurement	DMo_OAM_Tool	DMo_OAM_Tool	DMo_OAM_Tool	DMo_OAM_Tool	DMo_OAM_Tool	DMo_OAM_Tool
	DMo_Start (CoS,Test_ID,Length,Period)[1...M <sub>DMo</sub> ]		DMo_Start (CoS,Length,Period)[1...M <sub>DMo</sub> ]		DMo_Start(CoS, Test_ID, Length, Period, CopyPad)[1...M <sub>DMo</sub> ]	
	DMo_Intermediate_Request[1...M <sub>LMo</sub> ]		DMo_Intermediate_Request[1...M <sub>LMo</sub> ]		DMo_Intermediate_Request[1...M <sub>LMo</sub> ]	
	DMo_Terminate[1...M <sub>DMo</sub> ]		DMo_Terminate[1...M <sub>DMo</sub> ]		DMo_Terminate[1...M <sub>DMo</sub> ]	
	<i>DMo_Result(count,B_FD[],F_FD[],N_FD[])[1...M<sub>DMo</sub>]</i>	<i>IDMo_Result(count,N_FD[])[1...M<sub>DMo</sub>]</i>	<i>DMo_Result(count,B_FD[],F_FD[],N_FD[])[1...M<sub>DMo</sub>]</i>		<i>DMo_Result(count, B_FD[], F_FD[], N_FD[])[1...M<sub>DMo</sub>]</i>	
					<i>DMo_ReportError(Error)[1...M<sub>DMo</sub>]</i>	
				<i>DMo_PeriodChanged[1...M<sub>DMo</sub>]</i>		
Two-way on-demand frame loss / frame delay measurement					LMDMo_OAM_Tool (Note1)	
					DMo_OAM_Tool (Note2)	
					LMDMo_Start(CoS, Test_ID, Length, Period, LMType, CountBytes, CopyPad)[1...M <sub>LMDMo</sub> ]	
					LMDMo_IntermediateReport[1...M <sub>LMDMo</sub> ]	
					LMDMo_Terminate[1...M <sub>LMDMo</sub> ]	
					<i>LMDMo_Result(N_TF, N_LF, F_TF, F_LF)[1...M<sub>LMo</sub>]</i>	

**Table 7-2 – On-demand measurement and maintenance MI list**

Functionality	ITU-T G.8121 MTDe_TT_So_MI	ITU-T G.8121 MTDe_TT_Sk_MI	ITU-T G.8121.1 MTDe_TT_So_MI	ITU-T G.8121.1 MTDe_TT_Sk_MI	ITU-T G.8121.2 MTDe_TT_So_MI	ITU-T G.8121.2 MTDe_TT_Sk_MI
					<i>DMo_Result(count, B_FD[], F_FD[], N_FD[][1...MDMo])</i>	
					<i>LMO_ReportError(Error) [1...MLMo]</i>	
					<i>LMO_PeriodChanged [1...MLMo]</i>	
On-demand loop back	CV_OAM_Tool	CV_OAM_Tool	CV_OAM_Tool	CV_OAM_Tool	CV_OAM_Tool	CV_OAM_Tool
	CV_Series()		CV_Series (TTL,CoS,N,Length,Period)		CV_Series (Session_ID, Count, Period, CoS, Size, ValidateFEC, ValidateReverse, TargetFECStack)	
	<i>CV_Series_Result()</i>		<i>CV_Series_Result(REC,ERR,OO)</i>		FEC_Checking	FEC_Checking
					Target_FEC	FEC_Checking
					<i>CV_Series_Result(Session_ID, Rcv, OOO, FWErr, BWErr)</i>	
					<i>CV_FWErr(Session_ID, Seq, RC, SubRC, ErrTLV)</i>	
					<i>CV_BWErr(Session_ID, Seq, RC, SubRC, ErrTLV)</i>	
On-demand lock instruct	Admin_State	<i>Admin_State_Request</i>			Admin_State	<i>Admin_State_Request</i>
	Lock_Instruct_Enable				Lock_Instruct_Enable	
	LI_Period				LI_Period	
	LI_MEPID				LI_MEPID	
	LI_CoS				LI_CoS	

**Table 7-2 – On-demand measurement and maintenance MI list**

Functionality	ITU-T G.8121 MTDe_TT_So_MI	ITU-T G.8121 MTDe_TT_Sk_MI	ITU-T G.8121.1 MTDe_TT_So_MI	ITU-T G.8121.1 MTDe_TT_Sk_MI	ITU-T G.8121.2 MTDe_TT_So_MI	ITU-T G.8121.2 MTDe_TT_Sk_MI
One-way on-demand throughput test	1TH_OAM_Tool	1TH_OAM_Tool	1TH_OAM_Tool	1TH_OAM_Tool		
	1TH_Start (CoS, Length, Period)	1TH_Start	1TH_Start (CoS, Pattern, Length, Period)	1TH_Start (Period)		
	1TH_Terminate	1TH_Terminate	1TH_Terminate	1TH_Terminate		
	<i>1TH_Result(Sent)</i>	<i>1TH_Result(REC, CRC, BE R, OO)</i>	<i>1TH_Result(Sent)</i>	<i>1TH_Result(REC, CRC, BE R, OO)</i>		
On-demand link trace	CV_OAM_Tool	CV_OAM_Tool	CV_OAM_Tool	CV_OAM_Tool	CV_OAM_Tool	CV_OAM_Tool
					CV_Trace (Session_ID, CoS, ValidateFEC, ValidateReverse, TargetFECStack)	
					<i>CV_Trace_Result (Session_ID, Result)</i>	
					<i>CV_FWErr(Session_ID, Seq, RC, SubRC, ErrTLV)</i>	
					<i>CV_BWErr(Session_ID, Seq, RC, SubRC, ErrTLV)</i>	
On-demand test	CV_OAM_Tool	CV_OAM_Tool	CV_OAM_Tool	CV_OAM_Tool		
			CV_Test (CoS, Pattern, Length, Period)			
			CV_Terminate			
			<i>CV_Test_Result(Sent, REC, REC, ERR, OO)</i>			

### 7.1.1.2 MEP proactive measurement function

The MEP proactive measurement function exists in NCM and TCM MEPs.

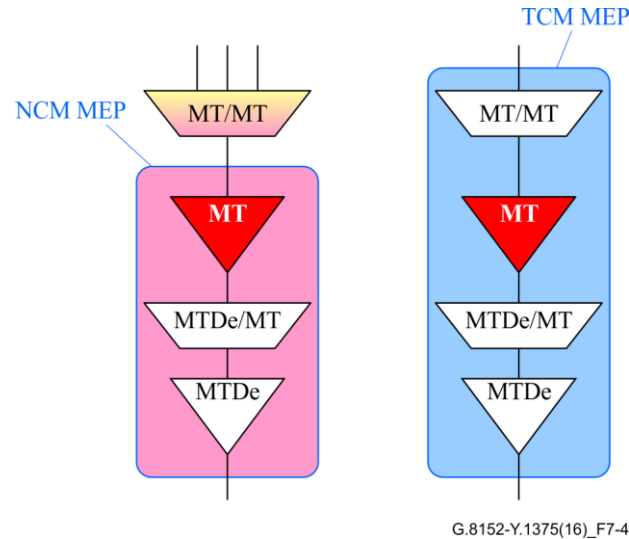

**Figure 7-4 – MEP proactive measurement function**

[ITU-T G.8121] defines the following management information (MI) for pro-active measurements:

**Table 7-3 – Pro-active measurement MI list**

Functionality	ITU-T G.8121 MT_TT_So_MI	ITU-T G.8121 MT_TT_Sk_MI	ITU-T G.8121.1 MT_TT_So_MI	ITU-T G.8121.1 MT_TT_Sk_MI	ITU-T G.8121.2 MT_TT_So_MI	ITU-T G.8121.2 MT_TT_Sk_MI
General	GAL_Enable	GAL_Enable	GAL_Enable	GAL_Enable	GAL_Enable	GAL_Enable
	TTLVALUE		TTLVALUE		TTLVALUE	
	MEG_ID	MEG_ID	MEG_ID	MEG_ID		
	MEP_ID	PeerMEP_ID	MEP_ID	PeerMEP_ID	MEP_ID	PeerMEP_ID
		AIS_OAM_Tool				
		LCK_OAM_Tool				
						PM_ClearError
						PM_Responder_Enable

**Table 7-3 – Pro-active measurement MI list**

Functionality	ITU-T G.8121 MT_TT_So_MI	ITU-T G.8121 MT_TT_Sk_MI	ITU-T G.8121.1 MT_TT_So_MI	ITU-T G.8121.1 MT_TT_Sk_MI	ITU-T G.8121.2 MT_TT_So_MI	ITU-T G.8121.2 MT_TT_Sk_MI
Continuity check and Connectivity Verification	CC_OAM_Tool	CC_OAM_Tool	CC_OAM_Tool	CC_OAM_Tool	CC_OAM_Tool	CC_OAM_Tool
	RDI_OAM_Tool	RDI_OAM_Tool	RDI_OAM_Tool	RDI_OAM_Tool	RDI_OAM_Tool	RDI_OAM_Tool
	CC_Enable (Note1)	CC_Enable (Note1)	CC_Enable (Note2)	CC_Enable	CC_Enable[1...Mcccv]	
	CVp_Enable (Note1)	CVp_Enable (Note1)			CVp_Enable[1...Mcccv]	
					CCCV_Mode[1...Mcccv]	
	MEP_ID	PeerMEP_ID	MEP_ID	PeerMEP_ID	MEP_ID[1...Mcccv]	PeerMEP_ID[1...Mcccv]
	CC_CoS	CC_CoS	CC_CoS	CC_CoS	CC_CoS[1...Mcccv]	CC_CoS[1...Mcccv]
	CC_Period	CC_Period	CC_Period	CC_Period	CC_Period	CC_Period
		Get_SvdCC		Get_SvdCC		Get_SvdCC[1...Mcccv]
		SvdCC		SvdCC		SvdCC
<p><i>NOTE 1 – MI_CC_Enable and MI_CVp_Enable are used to enable CC and CV functions respectively. The possible combinations are:</i></p> <ul style="list-style-type: none"> <li>– no CC function and no CV function: MI_CC_Enable = false and MI_CVp_Enable = false</li> <li>– CC-only function: MI_CC_Enable = true and MI_CVp_Enable = false</li> <li>– CC and CV functions: MI_CC_Enable = true and MI_CVp_Enable = true</li> </ul> <p><i>NOTE 2 – MI_CVp_Enable defined in [ITU-T G.8121] is automatically configured true by setting MI_CC_Enable true.</i></p>						
one-way pro-active loss of frame measurement using CC	CC_OAM_Tool	CC_OAM_Tool	CC_OAM_Tool	CC_OAM_Tool		
	1LMp_Enable	1LMp_Enable	LMC_Enable	LMC_Enable		
			MEP_ID	PeerMEP_ID		
			CC_CoS	CC_CoS		
			CC_Period	CC_Period		



**Table 7-3 – Pro-active measurement MI list**

Functionality	ITU-T G.8121 MT_TT_So_MI	ITU-T G.8121 MT_TT_Sk_MI	ITU-T G.8121.1 MT_TT_So_MI	ITU-T G.8121.1 MT_TT_Sk_MI	ITU-T G.8121.2 MT_TT_So_MI	ITU-T G.8121.2 MT_TT_Sk_MI
two-way pro- active loss of frame measurement	LMp_OAM_Tool	LMp_OAM_Tool	LMp_OAM_Tool	LMp_OAM_Tool	LMp_OAM_Tool	LMp_OAM_Tool
	LMp_Enable[1...M <sub>LMp</sub> ]	LMp_Enable[1... M <sub>LMp</sub> ]	LMp_Enable[1...M <sub>LMp</sub> ]	LMp_Enable[1... M <sub>LMp</sub> ]	LMp_Enable[1...M <sub>LMp</sub> ]	LMp_Enable[1... M <sub>LMp</sub> ]
	LMp_Period[1...M <sub>LMp</sub> ]		LMp_Period[1...M <sub>LMp</sub> ]		LMp_Period[1...M <sub>LMp</sub> ]	
	LMp_CoS[1...M <sub>LMp</sub> ]	LMp_CoS[1... M <sub>LMp</sub> ]	LMp_CoS[1...M <sub>LMp</sub> ]	LMp_CoS[1... M <sub>LMp</sub> ]	LMp_CoS[1...M <sub>LMp</sub> ]	
					LMp_Test_ID[1...M <sub>LMp</sub> ]	
					LMp_LMType[1...M <sub>LMp</sub> ]	
					LMp_CountBytes[1...M <sub>LMp</sub> ]	
					<i>LMp_PeriodChanged[1... M<sub>LMp</sub>]</i>	
						<i>LMp_ReportError(Error) [1...M<sub>LMp</sub>]</i>
		LM_DEGM			LM_DEGM	
		LM_M			LM_M	
		LM_DEGTHR			LM_DEGTHR	
	LM_TFMIN			LM_TFMIN		
one-way pro- active synthetic loss of frame measurement	1SLp_OAM_Tool	1SLp_OAM_Tool				
	1SLp_Enable[1...M <sub>1SLp</sub> ]	1SLp_Enable[1...M <sub>1SLp</sub> ]				
	1SLp_Period[1...M <sub>1SLp</sub> ]					
	1SLp_Test_ID[1...M <sub>1SLp</sub> ]	1SLp_Test_ID[1...M <sub>1SLp</sub> ]				
	1SLp_Length[1...M <sub>1SLp</sub> ]					
	1SLp_CoS[1...M <sub>1SLp</sub> ]					
two-way pro- active synthetic loss of frame measurement	SLp_OAM_Tool	SLp_OAM_Tool			(covered by DMp)	(covered by DMp)
	SLp_Enable[1...M <sub>SLp</sub> ]	SLp_Enable[1... M <sub>SLp</sub> ]				
	SLp_Period[1...M <sub>SLp</sub> ]					
	SLp_Test_ID[1...M <sub>SLp</sub> ]					
	SLp_Length[1...M <sub>SLp</sub> ]					
	SLp_CoS[1...M <sub>SLp</sub> ]	SLp_CoS[1... M <sub>SLp</sub> ]				

**Table 7-3 – Pro-active measurement MI list**

Functionality	ITU-T G.8121 MT_TT_So_MI	ITU-T G.8121 MT_TT_Sk_MI	ITU-T G.8121.1 MT_TT_So_MI	ITU-T G.8121.1 MT_TT_Sk_MI	ITU-T G.8121.2 MT_TT_So_MI	ITU-T G.8121.2 MT_TT_Sk_MI
one-way pro-active frame delay measurement	1DMp_OAM_Tool	1DMp_OAM_Tool				
	1DMp_Enable[1...M <sub>1DMp</sub> ]	1DMp_Enable[1...M <sub>1DMp</sub> ]				
	1DMp_Period[1...M <sub>1DMp</sub> ]					
	1DMp_Test_ID[1...M <sub>1DMp</sub> ]	1DMp_Test_ID[1...M <sub>1DMp</sub> ]				
	1DMp_Length[1...M <sub>1DMp</sub> ]					
	1DMp_CoS[1...M <sub>1DMp</sub> ]					
two-way pro-active frame delay measurement	DMp_OAM_Tool	DMp_OAM_Tool	DMp_OAM_Tool	DMp_OAM_Tool	DMp_OAM_Tool	DMp_OAM_Tool
	DMp_Enable[1...M <sub>DMp</sub> ]	DMp_Enable[1... M <sub>DMp</sub> ]	DMp_Enable[1...M <sub>DMp</sub> ]	DMp_Enable[1... M <sub>DMp</sub> ]	DMp_Enable[1...M <sub>DMp</sub> ]	DMp_Enable[1... M <sub>DMp</sub> ]
	DMp_Period[1...M <sub>DMp</sub> ]		DMp_Period[1...M <sub>DMp</sub> ]		DMp_Period[1...M <sub>DMp</sub> ]	
	DMp_Test_ID[1...M <sub>DMp</sub> ]		DMp_Test_ID[1...M <sub>DMp</sub> ]		DMp_Test_ID[1...M <sub>DMp</sub> ]	
	DMp_CoS[1...M <sub>DMp</sub> ]	DMp_CoS[1... M <sub>DMp</sub> ]	DMp_CoS[1...M <sub>DMp</sub> ]	DMp_CoS[1... M <sub>DMp</sub> ]	DMp_CoS[1...M <sub>DMp</sub> ]	
	DMp_Length[1...M <sub>DMp</sub> ]		DMp_Length[1...M <sub>DMp</sub> ]		DMp_Length[1...M <sub>DMp</sub> ]	
					DMp_CopyPad[1...M <sub>DMp</sub> ]	
					<i>DMp_PeriodChanged[1...M<sub>LMp</sub>]</i>	
					<i>DMp_ReportError(Error)[1...M<sub>DMp</sub>]</i>	
Fault cause list		cSSF cLCK cLOC cMMG cUNM cUNP cUNC cDEG cRDI		cSSF cLCK cLOC cMMG cUNM cUNP cUNC cDEG cRDI		cSSF cLCK cLOC[] cMMG cUNM  cUNC cDEG cRDI

**Table 7-3 – Pro-active measurement MI list**

Functionality	ITU-T G.8121 MT_TT_So_MI	ITU-T G.8121 MT_TT_Sk_MI	ITU-T G.8121.1 MT_TT_So_MI	ITU-T G.8121.1 MT_TT_Sk_MI	ITU-T G.8121.2 MT_TT_So_MI	ITU-T G.8121.2 MT_TT_Sk_MI
Performance primitive list		pN_LF[1...P] pN_TF[1...P] pF_LF[1...P] pF_TF[1...P] pF_DS pN_DS pB_FD[1...P] pB_FDV[1...P] pN_FD[1...P] pN_FDV[1...P] pF_FD[1...P] pF_FDV[1...P]		pN_LF pN_TF pF_LF pF_TF pF_DS pN_DS		pN_LF[1...P] pN_TF[1...P] pF_LF[1...P] pF_TF[1...P] pF_DS pN_DS pB_FD[1...P] pB_FDV[1...P] pN_FD[1...P] pN_FDV[1...P] pF_FD[1...P] pF_FDV[1...P]

### 7.1.1.3 MEP configuration function

The MEP configuration function exists in NCM and TCM MEPs.

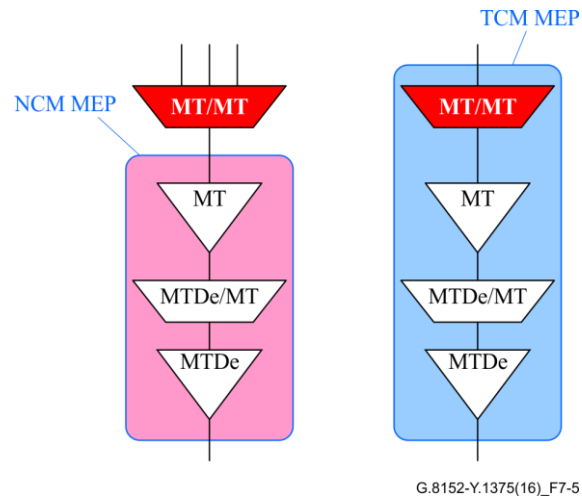

**Figure 7-5 – MEP configuration function**

[ITU-T G.8121] defines the following management information (MI) for configuring a MEP, as given in Table 7-4.

**Table 07-4 – MEP configuration MI list**

Functionality	ITU-T G.8121 MT/MT_A_So_MI	ITU-T G.8121 MT/MT_A_Sk_MI	ITU-T G.8121.1 MT/MT_A_So_MI	ITU-T G.8121.1 MT/MT_A_Sk_MI	ITU-T G.8121.2 MT/MT_A_So_MI	ITU-T G.8121.2 MT/MT_A_Sk_MI
General	GAL_Enable	GAL_Enable				
	TTLVALUE					
Lock	Admin_State	Admin_State				
	LCK_Period	LCK_Period				
	LCK_CoS	LCK_CoS				
	LCK_OAM_Tool	LCK_OAM_Tool				
Alarm indication signal (Note)	AIS_Period	AIS_Period			Local_Defect	
	AIS_CoS	AIS_CoS				
	AIS_OAM_Tool	AIS_OAM_Tool				
Client signal fail	CSF_Tool	CSF_Tool				
	CSF_Period					
	CSF_CoS					
	CSF_Enable					
	CSFrdifdiEnable	CSFrdifdiEnable				
		CSF_Reported				
Automatic protection switching	APS_OAM_Tool	APS_OAM_Tool				
	APS_CoS					

NOTE – MIs for AIS at source are configured at server MEP.

## 7.1.2 MIP compound function

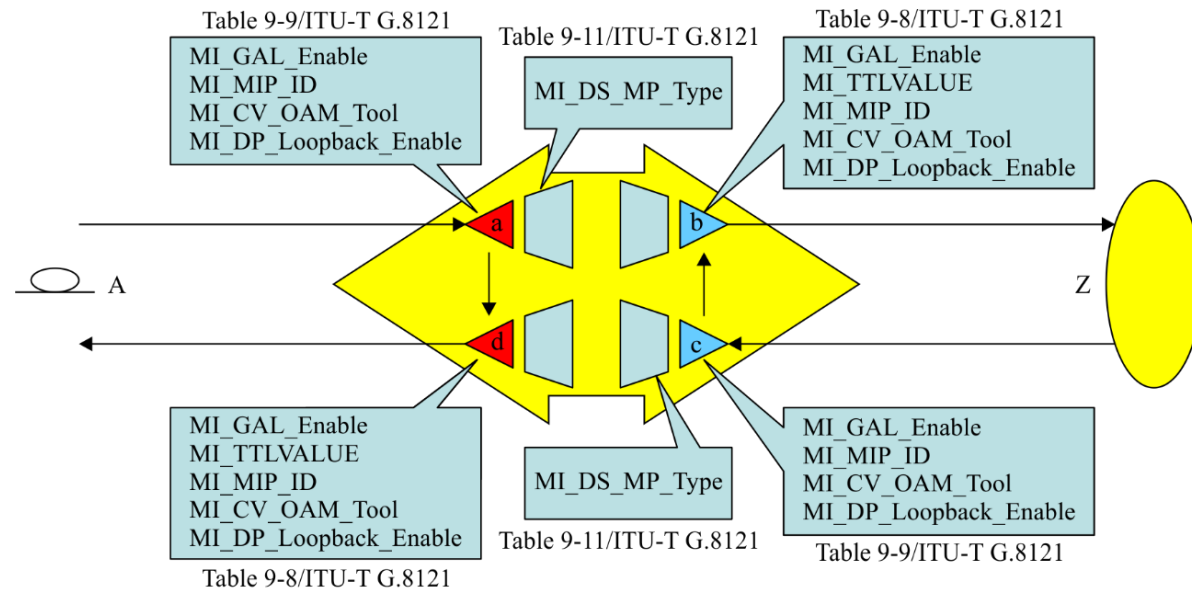

G.8152-Y.1375(16)\_F7-6

**Figure 7-6 – MIP configuration parameters**

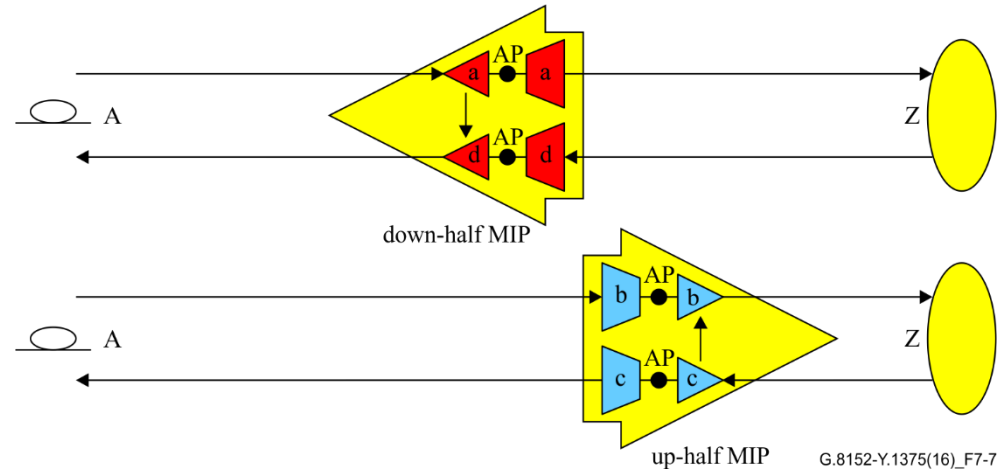

**Figure 7-7 – "half MIP" compound function**

The management information (MI) of the MIP compound function (defined in [ITU-T G.8121/Y.1381]) is mapped to the MipBidirectional object class.

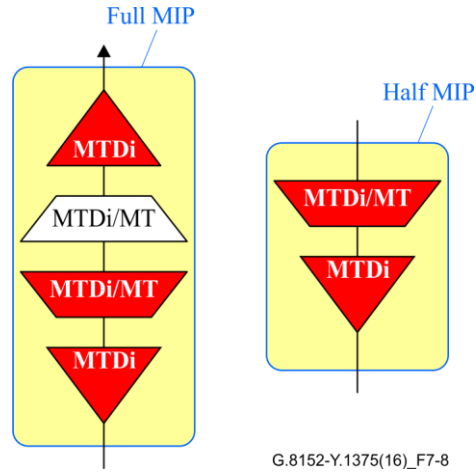

**Figure 7-8 – MIP/half MIP configuration function**

[ITU-T G.8121/Y.1381] defines the following management information (MI) for configuring a MIP, as given in Table 7-5.

**Table 07-5 – MIP configuration MI list**

Functionality	ITU-T G.8121 MTDi_TT_So_MI	ITU-T G.8121 MTDi_TT_Sk_MI	ITU-T G.8121.1 MTDi_TT_So_MI	ITU-T G.8121.1 MTDi_TT_Sk_MI	ITU-T G.8121.2 MTDi_TT_So_MI	ITU-T G.8121.2 MTDi_TT_Sk_MI
General	GAL_Enable	GAL_Enable				
	TTLVALUE					
	MIP_ID	MIP_ID				
		DS_MP_Type [Note]				
	[Note] DS_MP_type is configured at MTDi/MT_A_Sk					
On-demand CV	CV_OAM_Tool	CV_OAM_Tool			Target_FEC	

## **7.2 Fault management**

FFS.

## **7.3 Performance monitoring**

Performance monitoring allows measurement of different performance parameters like frame loss ratio, frame delay and frame delay variation.

### **7.3.1 Loss Measurement**

The frame loss measurement (LM) provides performance data that is based on the lost frames between the ingress and the egress of a maintenance entity (ME); i.e., between two maintenance group end points (MEPs).

LM is restricted to MEGs which have only a single ME.

The following LM functions are defined:

- two-way on-demand LM
- one-way on-demand synthetic LM
- two-way on-demand synthetic LM
- two-way proactive LM
- one-way proactive synthetic LM
- two-way proactive synthetic LM.

The single-ended on-demand LM function is managed only at the source MEP. The sink MEP does not need any management.

The dual-ended pro-active LM function is managed at source and sink MEP.

### **7.3.2 Delay measurement**

The frame delay measurement (DM) provides performance data that is based on the delay of the frames between the ingress and the egress of a maintenance entity (ME); i.e., between two maintenance group end points (MEPs).

The following DM functions are defined:

- one-way on-demand DM
- two-way (round-trip) on-demand DM.
- one-way proactive DM
- two-way (round-trip) proactive DM.

The one-way DM function is started at the source MEP and enabled at the sink MEP.

The two-way DM function is managed only at the source MEP. The sink MEP does not need any management.

## **7.4 MPLS-TP multiplexing**

This clause maps the MPLS-TP multiplexing related MIs to the corresponding object classes.

The MPLS-TP multiplexing configuration function exists only in MT TTP and MT CTP.



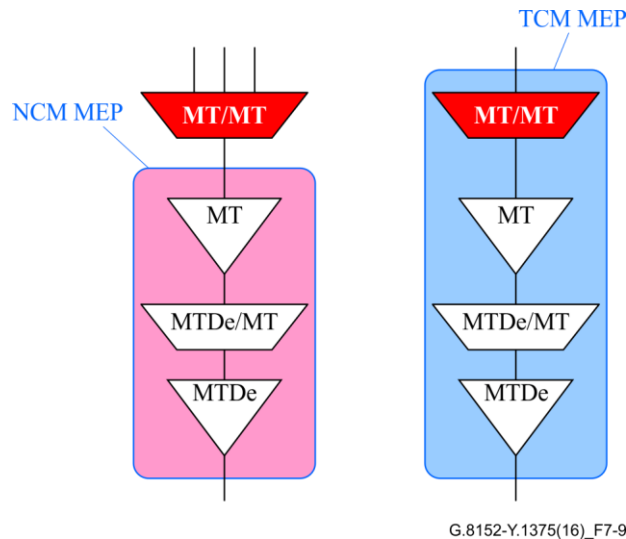

**Figure 7-9 – MPLS-TP multiplexing configuration function**

[ITU-T G.8121] defines the following management information (MI) for configuring the MPLS-TP multiplexing function, as given in Table 7-5bis.

**Table 7-5bis – Mapping of multiplexing related MI to ITU-T G.8152 artefacts**

Functionality	ITU-T G.8121 MT/MT_A_So_MI	ITU-T G.8121 MT/MT_A_Sk_MI
TTP associated MI	Label[1...M]	Label[1...M]
	LSPTType[1...M]	LSPTType[1...M]
	CoS[1...M]	CoS[1...M]
	PHB2TCMapping[1...M]	TC2PHBMapping[1...M]
	QoSEncodingMode[1...M]	QoSDecodingMode[1...M]
	Mode	Mode
CTP associated MI		

## 7.5 Connection function

This clause maps the connection function related MIs to the corresponding object classes.

**Table 7-6 – Mapping of connection function related MI to ITU-T G.8152 artefacts**

Functionality	MT_C_MI	ITU-T G.8152
General connection management	Create_MC	
	Modify_MC	
	Delete_MC	
Individual connection point management	MT_C_MP per input and output connection point	
	<i>for further study</i>	
Individual connection management	MT_C_MP per matrix connection:	
	MT_C_MI_ConnectionType	
	MT_C_MI_Return_CP_ID	

**Table 7-6 – Mapping of connection function related MI to ITU-T G.8152 artefacts**

Functionality	MT_C_MI	ITU-T G.8152
	MT_C_MI_ConnectionPortIds	
SNCP configuration	MT_C_MP per SNC/S protection process:	
	<i>for further study</i>	

**7.5.1 Linear protection function**

The MPLS-TP linear protection function is defined in [ITU-T G.8131]. The related "Management Information" is listed in [ITU-T G.8121].

This function is modelled by the MT\_SNCP\_Group object class.

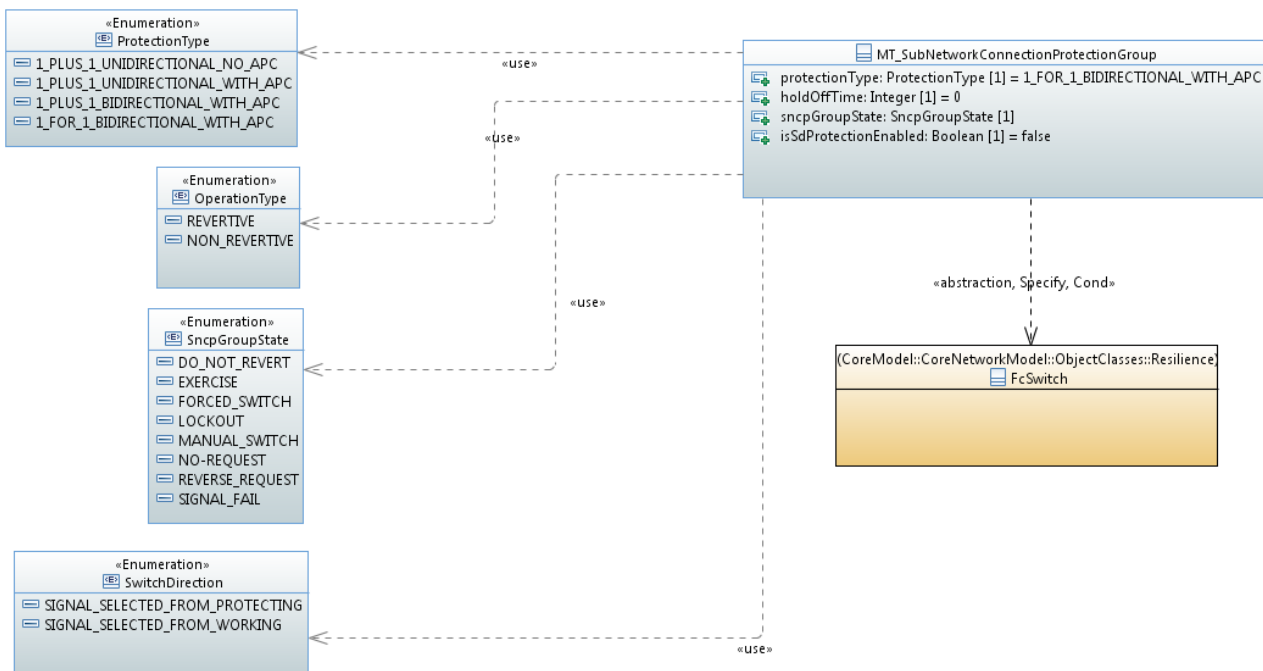

NOTE – This figure is also available from the ITU website [here](#).

**Figure 7-10 – MPLS-TP linear protection**

**7.6 SCC/MCC access function**

Signalling communication channel (SCC) and management communication channel (MCC) can be accessed when the containing LSP is terminated. Each channel is able to transport IPv4, IPv6 and OSI structured signals. The diamonds in Figure 7-11 represent traffic shaping and conditioning functions that may be needed to prevent the SCC/MCC forwarding points from exceeding their committed bandwidth in congestion situations.

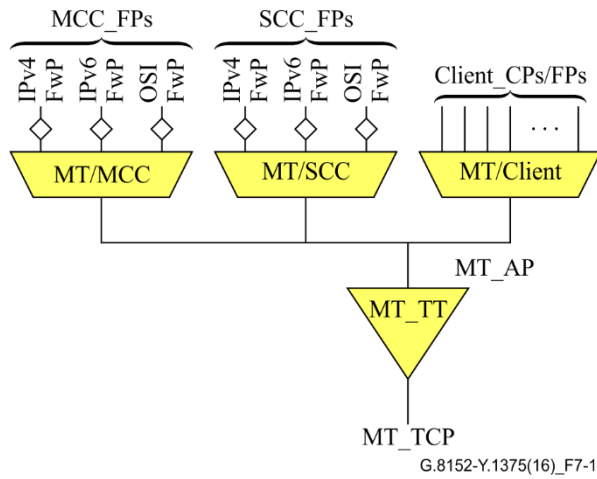
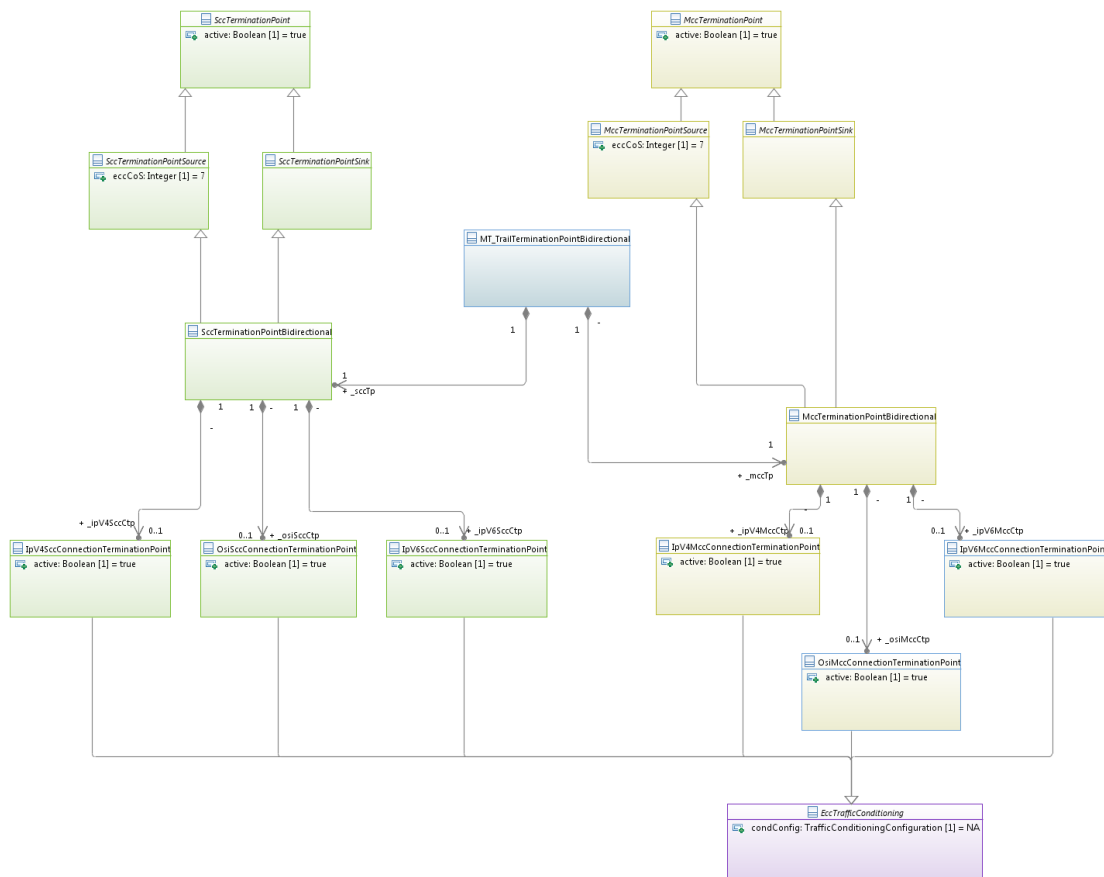

**Figure 7-11 – MT/SCC\_A function, MT/MCC\_A function, and MT/client\_A function (Copy from Figure 10-5 [ITU-T G.8121])**

SCC and MCC access are modelled using the same pattern. Only the bidirectional SCC/MCC termination point (TP) can be instantiated. Each termination point contains one connection termination point (CTP) for IPv4 access, one CTP for IPv6 access and one CTP for OSI access. These CTPs have the capability to shape and condition the communication signals.

The management of the SCC/MCC access function has been added to the bidirectional MT TTP.

Figure 7-12 contains the related class diagram.



NOTE – This figure is also available from the ITU website [here](#).

**Figure 7-12 – SCC/MCC access class diagram**

## 8 UML model file

The ITU-T G.8152/Y.1375 UML model is contained in a repository website. The following links provide the pointers to the ITU-T G.8152/Y.1375 UML model files and supporting materials.

– [G.8152 v2.00 PAP.zip](#)

This zip file contains the ITU-T G.8152/Y.1375 model files, i.e., the .project, .di, .notation, and .uml files and the profiles.

The ITU-T G.8152 v2.0 model uses the following modelling tool and profiles:

- Eclipse 4.7.2 (i.e., version Oxygen),
- Papyrus 3.2.0,
- OpenModel\_Profile 0.2.13,
- OpenInterfaceModel\_Profile 0.8,
- ProfileLifecycle\_Profile 0.0.4, and
- Gendoc v0.7.0 milestone 2.

– [G.8152 v2.0 DD.zip](#)

This zip file is the data dictionary.

– [G.7711 v2.02 PAP.zip](#)

This zip is the [ITU-T G.7711] model files. In order to use the ITU-T G.8152/Y.1375 model, one also needs to install the ITU-T G.7711 base model.

NOTE – The ITU-T G.8152/Y.1375 UML information model and the Open Model Profile are specified using the Papyrus open source modeling tool. In order to view and further extend or modify the information model, one will need to install the open source Eclipse software and the Papyrus tool, which are available at [b-Eclipse-Papyrus]. The installation guide for Eclipse and Papyrus can be found in [b-ONF TR-515].

# Annex A

## MPLS-TP Specification model

(This annex forms an integral part of this Recommendation.)

This annex describes how the [ITU-T G.7711] specification model is used to augment the Core model with the ETH specific properties.

### A.1 LTP/LP Spec model

#### A.1.1 Overview of the Core LTP/LP Spec model

Clause G.3.2 of [ITU-T G.7711] a generic LTP and LP Spec model that provides a representation of Layer Protocol (LP) specific parameters for the LTP. Reproduced below is Figure G.3-18 of [ITU-T G.7711], which shows the LTP/LP spec elements.

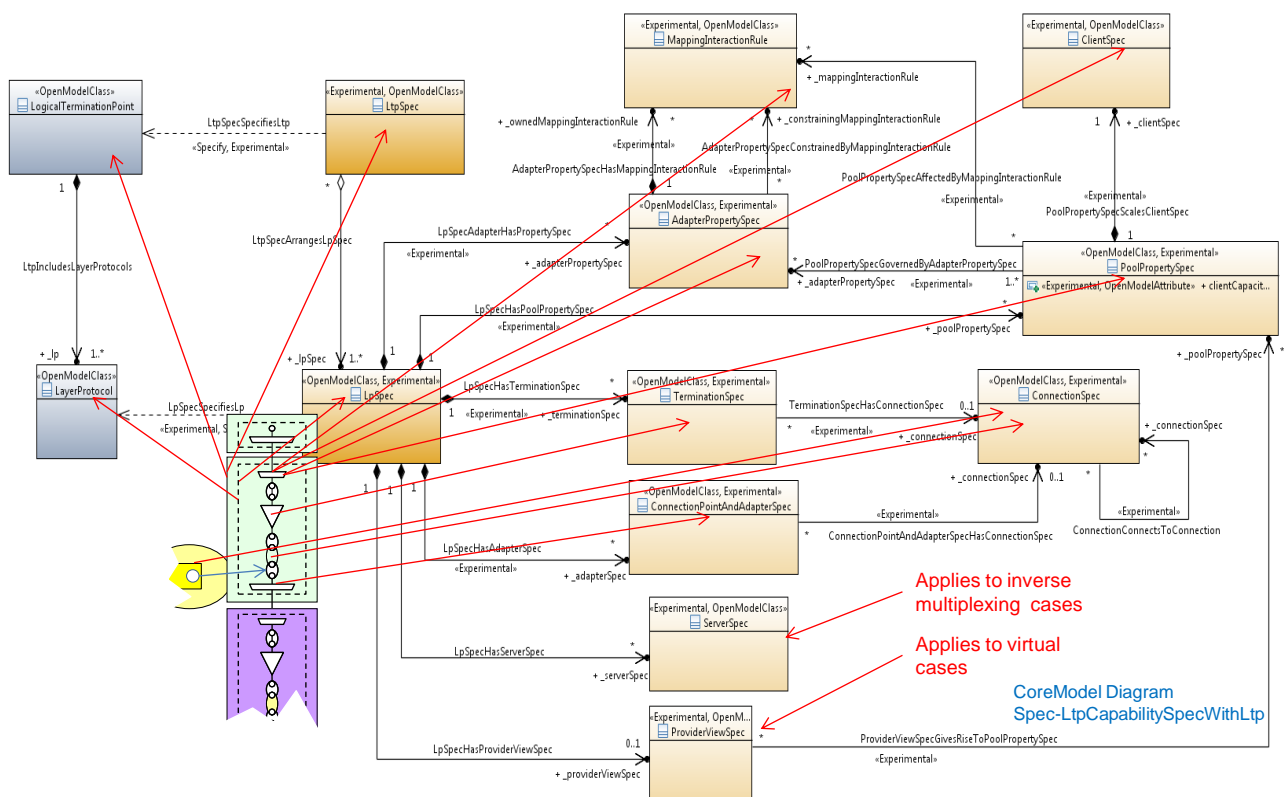

**Figure A.1-1 Relating LTP/LP spec elements**  
 (From Figure G.3-18 of [ITU-T G.7711] – Relating LTP/LP spec elements)

As shown in the figure, the LpSpec class is the touch point to anchor the spec elements for specifying the various capabilities of a specific type of LP. Among the Spec elements, the following two are particularly relevant to the layer specific parameters of the termination points defined in the technology specific recommendations.

ConnectionPointAndAdapterSpec is defined in G.3.2.3.3 of [ITU-T G.7711] as following:

*The specification of the server facing connection point and the adapter that deals with the transformation of a single signal of the layer protocol to/from the server. Equivalent to an ITU-T CTP [ITU-T G.8052].*

TerminationSpec is defined in G.3.2.3.11 of [ITU-T G.7711] as following:

*The specification of the layer protocol termination (including framing, modulation etc.). For example, the specification of the function that takes a MAC frame and extracts the content (removing the MAC address in the process).*

Although it was not explicitly stated, the TerminationSpec is obviously equivalent to an ITU-T TTP.

### **A.1.2 Consideration of MPLS-TP specification cases for LTP/LP**

Considering

- The benefit of easy traceability between the attributes of the technology-specific MPLS-TP TTP/CTP of the information models with the corresponding management information (i.e., the MI signals) of the ITU-T G.8121 MPLS-TP technology specific equipment function specifications,
  - This Recommendation continues to keep the current TTP/CTP in the technology-specific information models.
- The equivalency of the TTP/CTP to the spec elements, namely TerminationSpec and ConnectionPointAndAdapterSpec respectively,
  - This Recommendation enhances the technology-specific information models to augment, for each layer, the core model generic TerminationSpec and ConnectionPointAndAdapterSpec with the technology-specific TTP and CTP.

### **A.1.3 MPLS-TP specification classes for LTP/LP**

For each MPLS-TP layer, the core model generic TerminationSpec and ConnectionPointAndAdapterSpec is augmented with the TTP and CTP object classes as shown in the following UML diagram.

### A.1.3.1 MPLS-TP specification classes for LTP/LP

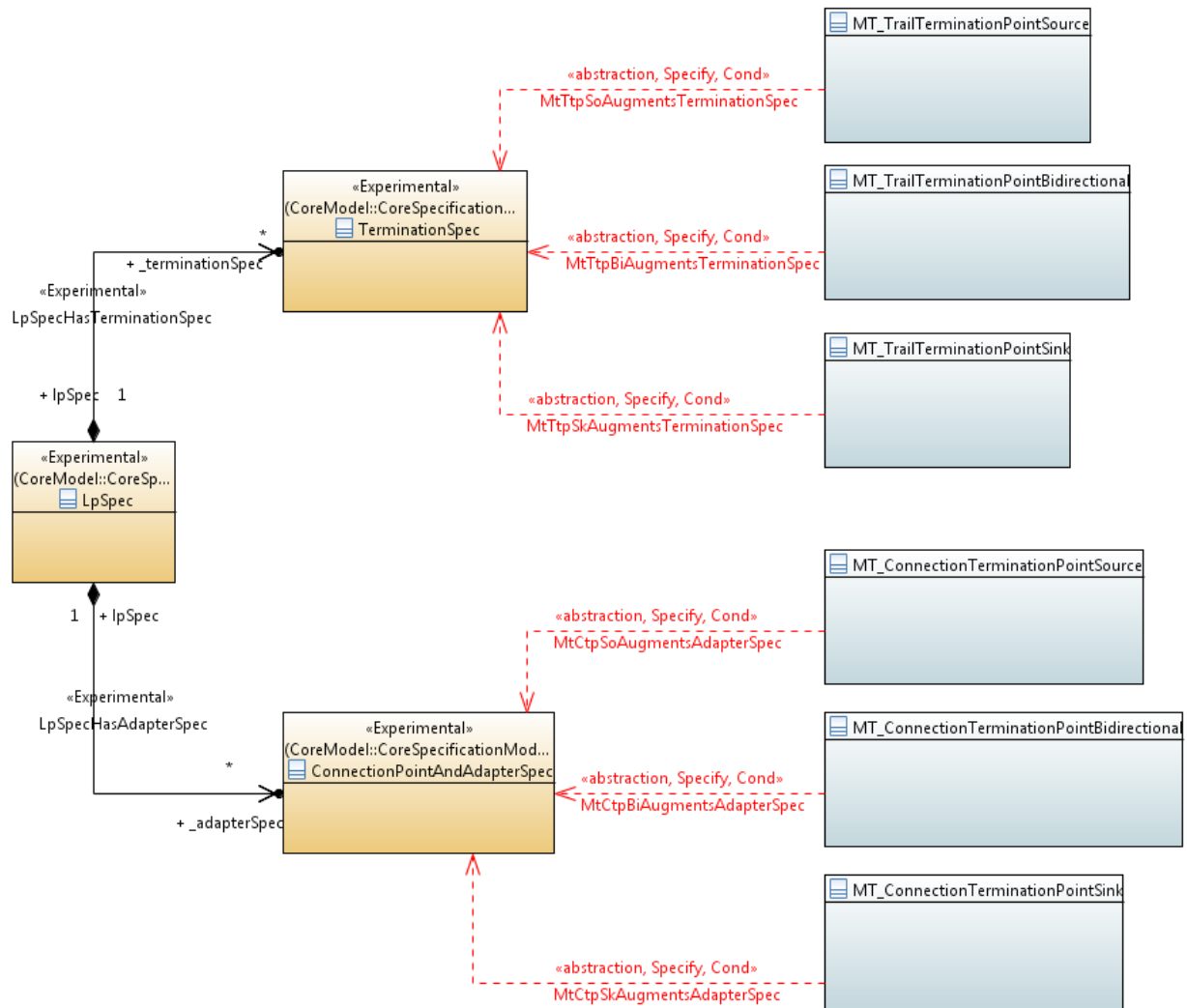

NOTE – This figure is also available from the ITU website [here](#).

**Figure A.1-2 MPLS-TP Spec case**

## **Appendix I**

### **UML modelling guidelines**

(This appendix does not form an integral part of this Recommendation.)

See Annex A of [ITU-T G.7711].

NOTE – The UML modelling guidelines specified in the 7/2013 version of this Recommendation has been enhanced and normatively specified in Annex A of [ITU-T G.7711].



## Appendix II

### Mapping of ITU-T G.8121 atomic functions to ITU-T G.8152/Y.1375 model artefacts

(This appendix does not form an integral part of this Recommendation.)

This appendix provides further detailed mapping between the [ITU-T G.8121] atomic functions and the ITU-T G.8152/Y.1375 UML model artefacts. Note that in some cases a 1:1 mapping is not possible.

**Table II.1 – Mapping between ITU-T G.8121 Ethernet atomic functions  
and UML model artefacts**

ITU-T G.8121 section	ITU-T G.8121 atomic function	ITU-T G.8152/Y.1375 model artefact	Note

For further study.

## **Appendix III**

### **UML model data dictionary**

(This appendix does not form an integral part of this Recommendation.)

The data dictionary contains, in MS Word document format, the details of the MPLS-TP NE management-protocol-neutral information model, including the description and properties of the object classes and their attributes and operations. These details information are generated automatically by a Gendoc tool from the UML model.

The ITU-T G.8152/Y.1375 data dictionary is provided in the G.8152\_v2.00\_DD.zip file at the repository website mentioned in clause 8 above.

## Bibliography

- [b-Eclipse-Papyrus] Papyrus Eclipse UML Modelling Tool  
<https://www.eclipse.org/papyrus/>
- [b-ONF TR-515] ONF TR-515\_Papyrus-Guidelines.docx  
[https://www.opennetworking.org/wp-content/uploads/2018/08/TR-515\\_Papyrus\\_Guidelines\\_v1.3-1-1.pdf](https://www.opennetworking.org/wp-content/uploads/2018/08/TR-515_Papyrus_Guidelines_v1.3-1-1.pdf)



ITU-T Y-SERIES RECOMMENDATIONS

**GLOBAL INFORMATION INFRASTRUCTURE, INTERNET PROTOCOL ASPECTS, NEXT-GENERATION NETWORKS, INTERNET OF THINGS AND SMART CITIES**

<b>GLOBAL INFORMATION INFRASTRUCTURE</b>	
General	Y.100–Y.199
Services, applications and middleware	Y.200–Y.299
Network aspects	Y.300–Y.399
Interfaces and protocols	Y.400–Y.499
Numbering, addressing and naming	Y.500–Y.599
Operation, administration and maintenance	Y.600–Y.699
Security	Y.700–Y.799
Performances	Y.800–Y.899
<b>INTERNET PROTOCOL ASPECTS</b>	
General	Y.1000–Y.1099
Services and applications	Y.1100–Y.1199
Architecture, access, network capabilities and resource management	Y.1200–Y.1299
<b>Transport</b>	<b>Y.1300–Y.1399</b>
Interworking	Y.1400–Y.1499
Quality of service and network performance	Y.1500–Y.1599
Signalling	Y.1600–Y.1699
Operation, administration and maintenance	Y.1700–Y.1799
Charging	Y.1800–Y.1899
IPTV over NGN	Y.1900–Y.1999
<b>NEXT GENERATION NETWORKS</b>	
Frameworks and functional architecture models	Y.2000–Y.2099
Quality of Service and performance	Y.2100–Y.2199
Service aspects: Service capabilities and service architecture	Y.2200–Y.2249
Service aspects: Interoperability of services and networks in NGN	Y.2250–Y.2299
Enhancements to NGN	Y.2300–Y.2399
Network management	Y.2400–Y.2499
Network control architectures and protocols	Y.2500–Y.2599
Packet-based Networks	Y.2600–Y.2699
Security	Y.2700–Y.2799
Generalized mobility	Y.2800–Y.2899
Carrier grade open environment	Y.2900–Y.2999
<b>FUTURE NETWORKS</b>	<b>Y.3000–Y.3499</b>
<b>CLOUD COMPUTING</b>	<b>Y.3500–Y.3999</b>
<b>INTERNET OF THINGS AND SMART CITIES AND COMMUNITIES</b>	
General	Y.4000–Y.4049
Definitions and terminologies	Y.4050–Y.4099
Requirements and use cases	Y.4100–Y.4249
Infrastructure, connectivity and networks	Y.4250–Y.4399
Frameworks, architectures and protocols	Y.4400–Y.4549
Services, applications, computation and data processing	Y.4550–Y.4699
Management, control and performance	Y.4700–Y.4799
Identification and security	Y.4800–Y.4899
Evaluation and assessment	Y.4900–Y.4999

*For further details, please refer to the list of ITU-T Recommendations.*

## SERIES OF ITU-T RECOMMENDATIONS

Series A	Organization of the work of ITU-T
Series D	Tariff and accounting principles and international telecommunication/ICT economic and policy issues
Series E	Overall network operation, telephone service, service operation and human factors
Series F	Non-telephone telecommunication services
<b>Series G</b>	<b>Transmission systems and media, digital systems and networks</b>
Series H	Audiovisual and multimedia systems
Series I	Integrated services digital network
Series J	Cable networks and transmission of television, sound programme and other multimedia signals
Series K	Protection against interference
Series L	Environment and ICTs, climate change, e-waste, energy efficiency; construction, installation and protection of cables and other elements of outside plant
Series M	Telecommunication management, including TMN and network maintenance
Series N	Maintenance: international sound programme and television transmission circuits
Series O	Specifications of measuring equipment
Series P	Telephone transmission quality, telephone installations, local line networks
Series Q	Switching and signalling, and associated measurements and tests
Series R	Telegraph transmission
Series S	Telegraph services terminal equipment
Series T	Terminals for telematic services
Series U	Telegraph switching
Series V	Data communication over the telephone network
Series X	Data networks, open system communications and security
Series Y	Global information infrastructure, Internet protocol aspects, next-generation networks, Internet of Things and smart cities
Series Z	Languages and general software aspects for telecommunication systems