

Recommendation

ITU-T G.8273.2/Y.1368.2 (06/2023)

SERIES G: Transmission systems and media, digital systems and networks

Packet over Transport aspects – Synchronization, quality and availability targets

SERIES Y: Global information infrastructure, Internet protocol aspects, next-generation networks, Internet of Things and smart cities

Internet protocol aspects – Transport

Timing characteristics of telecom boundary clocks and telecom time synchronous clocks for use with full timing support from the network



ITU-T G-SERIES RECOMMENDATIONS
Transmission systems and media, digital systems and networks

INTERNATIONAL TELEPHONE CONNECTIONS AND CIRCUITS	G.100-G.199
GENERAL CHARACTERISTICS COMMON TO ALL ANALOGUE CARRIER-TRANSMISSION SYSTEMS	G.200-G.299
INDIVIDUAL CHARACTERISTICS OF INTERNATIONAL CARRIER TELEPHONE SYSTEMS ON METALLIC LINES	G.300-G.399
GENERAL CHARACTERISTICS OF INTERNATIONAL CARRIER TELEPHONE SYSTEMS ON RADIO-RELAY OR SATELLITE LINKS AND INTERCONNECTION WITH METALLIC LINES	G.400-G.449
COORDINATION OF RADIOTELEPHONY AND LINE TELEPHONY	G.450-G.499
TRANSMISSION MEDIA AND OPTICAL SYSTEMS CHARACTERISTICS	G.600-G.699
DIGITAL TERMINAL EQUIPMENTS	G.700-G.799
DIGITAL NETWORKS	G.800-G.899
DIGITAL SECTIONS AND DIGITAL LINE SYSTEM	G.900-G.999
MULTIMEDIA QUALITY OF SERVICE AND PERFORMANCE – GENERIC AND USER-RELATED ASPECTS	G.1000-G.1999
TRANSMISSION MEDIA CHARACTERISTICS	G.6000-G.6999
DATA OVER TRANSPORT – GENERIC ASPECTS	G.7000-G.7999
PACKET OVER TRANSPORT ASPECTS	G.8000-G.8999
Ethernet over Transport aspects	G.8000-G.8099
MPLS over Transport aspects	G.8100-G.8199
Synchronization, quality and availability targets	G.8200-G.8299
Mobile network transport aspects	G.8300-G.8399
Service Management	G.8600-G.8699
ACCESS NETWORKS	G.9000-G.9999

For further details, please refer to the list of ITU-T Recommendations.

Recommendation ITU-T G.8273.2/Y.1368.2

Timing characteristics of telecom boundary clocks and telecom time synchronous clocks for use with full timing support from the network

Summary

Recommendation ITU-T G.8273.2/Y.1368.2 specifies minimum requirements for time and phase for telecom boundary clocks and telecom time synchronous clocks used in synchronization network equipment that operates in the network architecture as defined in Recommendations ITU-T G.8271, ITU-T G.8271.1, ITU-T G.8275 and ITU-T G.8275.1. It supports time and/or phase synchronization distribution for packet-based networks.

This version of the Recommendation only applies to full timing support from the network.

These requirements apply under the normal environmental conditions specified for the equipment.

History *

Edition	Recommendation	Approval	Study Group	Unique ID
1.0	ITU-T G.8273.2/Y.1368.2	2014-05-14	15	11.1002/1000/12196
1.1	ITU-T G.8273.2/Y.1368.2 (2014) Amd. 1	2015-01-13	15	11.1002/1000/12395
1.2	ITU-T G.8273.2/Y.1368.2 (2014) Amd. 2	2015-08-13	15	11.1002/1000/12543
2.0	ITU-T G.8273.2/Y.1368.2	2017-01-12	15	11.1002/1000/13109
2.1	ITU-T G.8273.2/Y.1368.2 (2017) Amd. 1	2017-08-13	15	11.1002/1000/13326
2.2	ITU-T G.8273.2/Y.1368.2 (2017) Amd. 2	2019-01-12	15	11.1002/1000/13821
3.0	ITU-T G.8273.2/Y.1368.2	2019-08-29	15	11.1002/1000/14015
3.1	ITU-T G.8273.2/Y.1368.2 (2019) Amd. 1	2020-03-15	15	11.1002/1000/14213
4.0	ITU-T G.8273.2/Y.1368.2	2020-10-29	15	11.1002/1000/14507
4.1	ITU-T G.8273.2/Y.1368.2 (2020) Amd. 1	2022-02-13	15	11.1002/1000/14904
4.2	ITU-T G.8273.2/Y.1368.2 (2020) Amd. 2	2022-11-13	15	11.1002/1000/15153
5.0	ITU-T G.8273.2/Y.1368.2	2023-06-13	15	11.1002/1000/15554

Keywords

Boundary clock, frequency synchronization, phase synchronization, synchronous Ethernet, time synchronization.

* To access the Recommendation, type the URL <https://handle.itu.int/> in the address field of your web browser, followed by the Recommendation's unique ID.

FOREWORD

The International Telecommunication Union (ITU) is the United Nations specialized agency in the field of telecommunications, information and communication technologies (ICTs). The ITU Telecommunication Standardization Sector (ITU-T) is a permanent organ of ITU. ITU-T is responsible for studying technical, operating and tariff questions and issuing Recommendations on them with a view to standardizing telecommunications on a worldwide basis.

The World Telecommunication Standardization Assembly (WTSA), which meets every four years, establishes the topics for study by the ITU-T study groups which, in turn, produce Recommendations on these topics.

The approval of ITU-T Recommendations is covered by the procedure laid down in WTSA Resolution 1.

In some areas of information technology which fall within ITU-T's purview, the necessary standards are prepared on a collaborative basis with ISO and IEC.

NOTE

In this Recommendation, the expression "Administration" is used for conciseness to indicate both a telecommunication administration and a recognized operating agency.

Compliance with this Recommendation is voluntary. However, the Recommendation may contain certain mandatory provisions (to ensure, e.g., interoperability or applicability) and compliance with the Recommendation is achieved when all of these mandatory provisions are met. The words "shall" or some other obligatory language such as "must" and the negative equivalents are used to express requirements. The use of such words does not suggest that compliance with the Recommendation is required of any party.

INTELLECTUAL PROPERTY RIGHTS

ITU draws attention to the possibility that the practice or implementation of this Recommendation may involve the use of a claimed Intellectual Property Right. ITU takes no position concerning the evidence, validity or applicability of claimed Intellectual Property Rights, whether asserted by ITU members or others outside of the Recommendation development process.

As of the date of approval of this Recommendation, ITU had not received notice of intellectual property, protected by patents/software copyrights, which may be required to implement this Recommendation. However, implementers are cautioned that this may not represent the latest information and are therefore strongly urged to consult the appropriate ITU-T databases available via the ITU-T website at <http://www.itu.int/ITU-T/ipr/>.

© ITU 2023

All rights reserved. No part of this publication may be reproduced, by any means whatsoever, without the prior written permission of ITU.

Table of Contents

		Page
1	Scope.....	1
2	References.....	1
3	Definitions	2
	3.1 Terms defined elsewhere	2
	3.2 Terms defined in this Recommendation	2
4	Abbreviations and acronyms	3
5	Conventions	3
6	Physical layer frequency performance requirements.....	3
	6.1 Synchronous equipment clock interfaces	4
	6.2 Enhanced synchronous equipment clock interfaces	4
7	T-BC packet layer performance requirements for full timing support from the network	4
	7.1 Time error noise generation.....	4
	7.2 Noise tolerance	8
	7.3 Noise transfer.....	9
	7.4 Transient response and holdover performance	10
	7.5 Interfaces	13
	Annex A – Telecom boundary clock and telecom synchronous clock models	15
	Annex B – Control of the phase transient due to rearrangements in the physical layer network	17
	Annex C – Control of the phase transient due to rearrangements in the enhanced physical layer network	19
	Appendix I – Mitigation of time error due to physical layer frequency input transients.....	21
	Appendix II – Derivation of T-BC/T-TSC output transient mask due to physical layer frequency network rearrangement	22
	II.1 Background on assumptions for and derivation of T-BC output phase error due to a physical layer frequency network rearrangement	22
	II.2 Construction and simplification of the physical layer frequency input transient limit.....	28
	II.3 T-BC output phase transient mask for the physical layer frequency network rearrangement case	31
	II.4 Construction and simplification of the enhanced physical layer frequency input transient limit.....	33
	II.5 T-BC output phase transient mask for the enhanced physical layer frequency network rearrangement case	35
	Appendix III – Background to performance requirements of the T-BC/T-TSC.....	38
	III.1 Noise generation requirements	39
	III.2 Noise tolerance	39
	III.3 Noise transfer.....	40

	Page
III.4 Holdover	42
Appendix IV – Consideration on T-TSC embedded in end applications	44
Appendix V – Performance estimation for cascaded media converters acting as T-BCs and for T-BC chains.....	45
V.1 Noise generation	45
V.2 Noise tolerance	47
V.3 Noise transfer.....	47
V.4 Transient response and holdover performance.....	47
Appendix VI – Choice of frequencies for measuring noise transfer.....	48
VI.1 Envelope repeat frequency	48
VI.2 Choice of artefact frequency	50
VI.3 Possible frequencies	50
VI.4 Expected filter response (PTP to PTP and PTP to 1 PPS noise transfer).....	51
VI.5 Expected filter response (Physical layer frequency to PTP and Physical layer frequency to 1 PPS noise transfer)	54
Appendix VII – Synchronization IWF F-P node limits	59
Appendix VIII – Measurement of relative time error between two T-BC output ports	60
VIII.1 Introduction	60
VIII.2 Definition of relative time error	60
Appendix IX – PTP noise tolerance testing for T-BC and T-TSC clocks	61
IX.1 Testing set-up for PTP noise tolerance testing	61
IX.2 Time/Phase error noise model	62
IX.3 Explanation of Transients.....	64
IX.4 Clock output requirements	65
IX.5 Noise model parameters	66
Appendix X – Derivation of T-BC/T-TSC output transient response due to long term rearrangement of physical layer frequency transport	67
X.1 Background on assumptions for and derivation of T-BC output max TE requirements	67
X.2 Derivation of T-BC/T-TSC output max TE requirements	67
Bibliography.....	69

Recommendation ITU-T G.8273.2/Y.1368.2

Timing characteristics of telecom boundary clocks and telecom time synchronous clocks for use with full timing support from the network

1 Scope

This Recommendation specifies minimum requirements for time and phase synchronization devices used in synchronization network equipment that operates in the network architecture as defined in [ITU-T G.8271], [ITU-T G.8271.1] and [ITU-T G.8275]. It supports time and/or phase synchronization distribution for packet-based networks.

This Recommendation allows for proper network operation for phase/time synchronization distribution when network equipment embedding a telecom boundary clock (T-BC) and telecom time synchronous clock (T-TSC) is timed from another T-BC or a telecom grandmaster (T-GM). The current version of this Recommendation addresses only the distribution of phase/time synchronization with the full timing support architecture defined in [ITU-T G.8275] and the related profile defined in [ITU-T G.8275.1].

This Recommendation defines the minimum requirements for T-BCs and T-TSCs in network elements. These requirements apply under the normal environmental conditions specified for the equipment. The current version of this Recommendation focuses on the case of physical layer frequency support. Requirements related to the case without physical layer frequency support (i.e., the PTP only case) are for further study.

This Recommendation includes noise generation, noise tolerance, noise transfer and transient response for T-BCs and T-TSCs.

For T-BC and T-TSC classes A and B, this version of the Recommendation was developed based on the simulations done for time transport via precision time protocol (PTP) and frequency transport via [ITU-T G.8262] option 1 (and via [ITU-T G.813] option 1 as the requirements are identical). [ITU-T G.8262] option 2 and [ITU-T G.813] option 2 are for further study. [ITU-T G.8262.1] is a higher accuracy clock compared to [ITU-T G.8262], therefore it can also be used for T-BC and T-TSC classes A and B

For T-BC and T-TSC classes C and D, this version of the Recommendation was developed based on the simulations done for time transport via PTP and frequency transport via [ITU-T G.8262.1].

For information on the applicability of ITU-T G.8273.2/Y.1368.2 requirements to a standalone T-TSC or a T-TSC embedded in an end application, refer to clause 7 of [ITU-T G.8271.1].

NOTE – This Recommendation does not modify the physical layer reference chain behaviour, according to [ITU-T G.803] and [ITU-T G.8261]. This Recommendation does not exclude the use of other physical layer clocks (e.g., [ITU-T G.812] Type I) within the frequency transport network. The equipment specification of a T-BC assisted by a physical layer equipment clock, other than [ITU-T G.8262] option 1 and [ITU-T G.8262.1], such as [ITU-T G.812] Type I, is for further study.

2 References

The following ITU-T Recommendations and other references contain provisions which, through reference in this text, constitute provisions of this Recommendation. At the time of publication, the editions indicated were valid. All Recommendations and other references are subject to revision; users of this Recommendation are therefore encouraged to investigate the possibility of applying the most recent edition of the Recommendations and other references listed below. A list of the currently valid ITU-T Recommendations is regularly published. The reference to a document within this Recommendation does not give it, as a stand-alone document, the status of a Recommendation.

- [ITU-T G.703] Recommendation ITU-T G.703 (2016), *Physical/electrical characteristics of hierarchical digital interfaces*.
- [ITU-T G.709] Recommendation ITU-T G.709 (2020), *Interfaces for the optical transport network*.
- [ITU-T G.781] Recommendation ITU-T G.781 (2020), *Synchronization layer functions for frequency synchronization based on the physical layer*.
- [ITU-T G.803] Recommendation ITU-T G.803 (2000), *Architecture of transport networks based on the synchronous digital hierarchy (SDH)*.
- [ITU-T G.810] Recommendation ITU-T G.810 (1996), *Definitions and terminology for synchronization networks*.
- [ITU-T G.812] Recommendation ITU-T G.812 (2004), *Timing requirements of slave clocks suitable for use as node clocks in synchronization networks*.
- [ITU-T G.813] Recommendation ITU-T G.813 (2003), *Timing characteristics of SDH equipment slave clocks (SEC)*.
- [ITU-T G.8260] Recommendation ITU-T G.8260 (2022), *Definitions and terminology for synchronization in packet networks*.
- [ITU-T G.8261] Recommendation ITU-T G.8261/Y.1361 (2019), *Timing and synchronization aspects in packet networks*.
- [ITU-T G.8262] Recommendation ITU-T G.8262/Y.1362 (2018), *Timing characteristics of a synchronous equipment slave clock*.
- [ITU-T G.8262.1] Recommendation ITU-T G.8262.1/Y.1362.1 (2022), *Timing characteristics of an enhanced synchronous equipment slave clock*.
- [ITU-T G.8264] Recommendation ITU-T G.8264/Y.1364 (2017), *Distribution of timing information through packet networks*.
- [ITU-T G.8271] Recommendation ITU-T G.8271/Y.1366 (2020), *Time and phase synchronization aspects of telecommunication networks*.
- [ITU-T G.8271.1] Recommendation ITU-T G.8271.1/Y.1366.1 (2022), *Network limits for time synchronization in packet networks with full timing support from the network*.
- [ITU-T G.8273] Recommendation ITU-T G.8273/Y.1368 (2023), *Framework of phase and time clocks*.
- [ITU-T G.8275] Recommendation ITU-T G.8275/Y.1369 (2020), *Architecture and requirements for packet-based time and phase distribution*.
- [ITU-T G.8275.1] Recommendation ITU-T G.8275.1/Y.1369.1 (2022), *Precision time protocol telecom profile for phase/time synchronization with full timing support from the network*.

3 Definitions

3.1 Terms defined elsewhere

This Recommendation uses the following terms defined elsewhere:

Definitions related to synchronization are contained in [ITU-T G.810] and [ITU-T G.8260].

3.2 Terms defined in this Recommendation

None.

4 Abbreviations and acronyms

This Recommendation uses the following abbreviations and acronyms:

1 PPS	One Pulse Per Second
cTE	Constant Time Error
dTE	Dynamic Time Error
eEEC	enhanced synchronous Ethernet Equipment Clock
EEC	synchronous Ethernet Equipment Clock
eSEC	enhanced Synchronous Equipment Clock
ESMC	Ethernet Synchronization Messaging Channel
GbE	Gigabit Ethernet
IWF	Interworking Function
MTIE	Maximum Time Interval Error
NE	Network Element
OTN	Optical Transport Network
PCS	Physical Coding Sublayer
PEC	Packet-based Equipment Clock
PRC	Primary Reference Clock
PRTC	Primary Reference Time Clock
PTP	Precision Time Protocol
SDH	Synchronous Digital Hierarchy
SEC	Synchronous Equipment Clock
SSM	Synchronization Status Message
SyncE	Synchronous Ethernet
T-BC	Telecom Boundary Clock
TDEV	Time Deviation
TE	Time Error
T-GM	Telecom Grandmaster
ToD	Time of Day
TR	timeReceiver
TT	timeTransmitter
T-TSC	Telecom Time Synchronous Clock

5 Conventions

None.

6 Physical layer frequency performance requirements

The list of the applicable physical layer frequency interfaces is provided in clause 7.5.3.

6.1 Synchronous equipment clock interfaces

Synchronous equipment clock interfaces used in combination with the telecom boundary clock (T-BC) and telecom time synchronous clock (T-TSC) classes A and B are specified in [ITU-T G.8262]. They generate and process Ethernet synchronization messaging channel (ESMC) messages as specified in [ITU-T G.8264]. For optical transport network (OTN) equipment, it shall generate and process OTN synchronization message channel (OSMC) to transport SSM messages as specified in [ITU-T G.709].

Synchronous digital hierarchy (SDH) interfaces and SDH equipment clocks used in combination with the T-BC are specified in [ITU-T G.813] and generate and process synchronization status messages (SSMs) as specified in [ITU-T G.781].

NOTE – The ITU-T G.8273.2 T-BC model does not exclude the use of other physical layer clocks (e.g., [ITU-T G.812] Type I) within the equipment related to the operation between the physical layer input to physical layer output interface behaviour, in accordance to the existing ITU-T G.803 reference chain and ITU-T G.8261 network limits. In such cases, the equipment behaviour related to the interaction between the physical layer input and the PTP output is for further study.

6.2 Enhanced synchronous equipment clock interfaces

Enhanced synchronous equipment clocks used in combination with T-BC and T-TSC are specified in [ITU-T G.8262.1]. They generate and process Ethernet synchronization messaging channel (ESMC) messages as specified in [ITU-T G.8264]. For OTN equipment, it shall generate and process OTN synchronization message channel (OSMC) to transport SSM messages as specified in [ITU-T G.709].

Enhanced synchronous equipment clock can be used in combination with all the T-BC and T-TSC classes. To achieve the required performance of T-BC and T-TSC classes C and D, they can only be used in combination with enhanced synchronous equipment clock as specified in [ITU-T G.8262.1].

7 T-BC packet layer performance requirements for full timing support from the network

See Appendix III for background information on performance requirements of the T-BC and T-TSC.

NOTE 1 – The 1 PPS input pertains to telecom grandmaster functions and it is for further study.

NOTE 2 – The impact on 1 PPS and PTP performance due to 1000 BASE-T and 10G BASE-T link renegotiation is for further study.

7.1 Time error noise generation

The noise generation of a T-BC and a T-TSC represents the amount of noise produced at the output of the T-BC/T-TSC when there is an ideal input reference packet timing signal.

Under normal, locked operating conditions, the time output of the T-BC and the T-TSC should be accurate to within the maximum absolute time error (TE) ($\max|TE|$). This value includes all the noise components, i.e., the constant time error (cTE) and the dynamic time error (dTE) noise generation.

In order to support different performance requirements at the end application specified in Table 1 of [ITU-T G.8271] using different network topologies and network technologies, the maximum absolute time error, the time error and dTE noise generation requirements for T-BCs and T-TSCs are divided into four classes: class A, class B, class C, and class D.

At the precision time protocol (PTP) and 1 pulse per second (PPS) outputs, the maximum absolute time error ($\max|TE|$) for T-BC/T-TSC is shown in Table 7-1. This includes all time error components (unfiltered).

Table 7-1 – Maximum absolute time error (max|TE|)

T-BC/T-TSC class	Maximum absolute time error – max TE (ns)
A	100 ns
B	70 ns
C	30 ns
D	For further study

NOTE – The values in Tables 7-1, 7-3, 7-4, 7-5, 7-6, 7-7, 7-8 and 7-9 are valid for 1 PPS interfaces and for 1GbE, 10GbE, 25GbE, 40GbE and 100GbE interfaces. Values for other interfaces are for further study. For 25GbE, 40GbE and 100GbE the accuracy can be severely impacted if Idle insertion/removal, alignment marker/codeword marker insertion/removal is not accounted for. For 40GbE and 100GbE the accuracy can also be severely impacted if physical coding sublayer (PCS) lane distribution/merging is not accounted for.

For class D, the maximum time error measured through a first-order low-pass filter with a bandwidth of 0.1 Hz, max|TE_L|, is shown in Table 7-2.

Table 7-2 – Maximum absolute time error low-pass filtered (max|TE_L|)

T-BC/T-TSC class	Maximum absolute time error – max TE _L (ns)
D	5 ns

The noise generation is divided into two components, the cTE and the dTE noise generation.

7.1.1 Constant time error noise generation (cTE)

At the PTP and 1 PPS outputs, the cTE generation is shown in Table 7-3.

Table 7-3 – T-BC/T-TSC permissible range of constant time error

T-BC/T-TSC class	Permissible range of constant time error – cTE (ns)
A	±50
B	±20
C	±10
D	For further study

NOTE 1 – Constant time error definition and the method to estimate constant time error are defined in [ITU-T G.8260]. For the purpose of testing the limits in Table 7-3, an estimate of constant time error should be obtained by averaging the time error sequence over 1 000 s.

NOTE 2 – Interfaces whose optical modules have uncontrolled asymmetric latency are for further study.

NOTE 3 – The constant time error (cTE) is measured at constant temperature (within ±1K).

7.1.2 Dynamic time error low-pass filtered noise generation (dTE_L)

The dynamic time error low-pass filtered noise generation (dTE_L) for a T-BC/T-TSC under constant temperature (within ±1 K) is shown in Tables 7-4 and 7-5. A T-BC and a T-TSC class A or class B containing an option 1 clock, as specified in [ITU-T G.8262], or containing an enhanced synchronous equipment clock, as specified in [ITU-T G.8262.1] should meet the limits for class A or class B. A T-BC and a T-TSC class C or class D containing an enhanced synchronous equipment clock, as specified in [ITU-T G.8262.1] should meet the limits for class C or class D.

When the T-BC/T-TSC is operating in locked mode synchronized to both a wander-free time reference at the PTP input and a wander-free frequency reference at the physical layer frequency input, the MTIE and TDEV under constant temperature (within ±1 K) at the PTP and 1 PPS outputs,

measured through a first-order low-pass filter with bandwidth of 0.1 Hz, should meet the limits in Table 7-4 and Table 7-5 respectively.

**Table 7-4 – Dynamic time error low-pass filtered noise generation (MTIE)
for T-BC/T-TSC with constant temperature (within ± 1 K)**

T-BC/T-TSC class	MTIE limit [ns]	Observation interval τ [s]
A	40	$m \leq \tau \leq 1\ 000$ (Note)
B	40	$m \leq \tau \leq 1\ 000$ (Note)
C	10	$m \leq \tau \leq 1\ 000$ (Note)
D	For further study	For further study

NOTE – The minimum τ value m is determined by packet rate of 16 packet per second ($m = 1/16$) or 1 PPS signal ($m = 1$).

**Table 7-5 – Dynamic time error low-pass filtered noise generation (TDEV)
for T-BC/T-TSC with constant temperature (within ± 1 K)**

T-BC/T-TSC class	TDEV limit [ns]	Observation interval τ [s]
A	4	$m < \tau \leq 1\ 000$ (Note)
B	4	$m < \tau \leq 1\ 000$ (Note)
C	2	$m \leq \tau \leq 1\ 000$ (Note)
D	For further study	For further study

NOTE – The minimum τ value m is determined by packet rate of 16 packet per second ($m = 1/16$) or 1 PPS signal ($m = 1$).

When temperature effects are included, the MTIE requirement is defined in Table 7-6 for a T-BC/T-TSC with physical layer frequency support; in this case the maximum observation interval is increased to 10 000 s.

**Table 7-6 – Dynamic time error low-pass filtered noise generation
(MTIE) for T-BC/T-TSC with variable temperature**

T-BC/T-TSC class	MTIE limit [ns]	Observation interval τ [s]
A	40	$m \leq \tau \leq 10\ 000$ (Note)
B	40	$m \leq \tau \leq 10\ 000$ (Note)
C	10	$m \leq \tau \leq 10\ 000$ (Note)
D	For further study	For further study

NOTE – The minimum τ value m is determined by packet rate of 16 packet per second ($m = 1/16$) or 1 PPS signal ($m = 1$).

NOTE – Guidelines for variable temperature testing are described in Appendix I of [ITU-T G.8273].

7.1.3 Dynamic time error high-pass filtered noise generation (dTE_H)

For a T-BC/T-TSC class A or class B containing an option 1 clock, as specified in [ITU-T G.8262], or containing an enhanced synchronous equipment clock, as specified in [ITU-T G.8262.1], and operating in a locked mode synchronized to both a noise-free time reference at the PTP input and a noise-free frequency reference at the physical layer frequency input, the peak-to-peak time error at the T-BC/T-TSC output interfaces, measured over a 1 000 second measurement interval, with a first-order high-pass filter of 0.1 Hz should be less than 70 ns.

NOTE – The value of 70 ns is a conservative limit based on the [ITU-T G.8262] noise generation specification. This is based on the assumption that most of this noise is generated by the high-pass filtered noise of the [ITU-T G.8262] oscillator. It is expected that implementations based on better clocks can result in significantly lower values. It is not intended and not assumed that the component of the high-pass filtered noise due to timestamp granularity is a major portion of the 70 ns.

For a T-BC/T-TSC class C containing an enhanced synchronous equipment clock, as specified in [ITU-T G.8262.1], and operating in a locked mode synchronized to both a noise-free time reference at the PTP input and a noise-free frequency reference at the physical layer frequency input, the peak-to-peak time error at the T-BC/T-TSC output interfaces, measured over a 1 000 second measurement interval, with a first-order high-pass filter of 0.1 Hz should be less than 30 ns.

NOTE – The value of 30 ns is a conservative limit based on the ITU-T G.8262.1 noise generation specification. This is based on the assumption that most of this noise is generated by the high-pass filtered noise of the ITU-T G.8262.1 oscillator. It is expected that implementations based on better clocks can result in significantly lower values. It is not intended and not assumed that the component of the high-pass filtered noise due to timestamp granularity is a major portion of the 30 ns.

The dynamic time error high-pass filtered noise generation (dTE_H) is for further study for T-BC/T-TSC classes D.

Table 7-7 – Dynamic time error high-pass filtered noise generation for T-BC/T-TSC

T-BC/T-TSC class	Maximum dTE _H (peak to peak) (ns)
A	70
B	70
C	30
D	For further study

7.1.4 Relative time error noise generation

The relative time error noise generation of a T-BC represents the difference between two timing signals carrying time. For the definition of relative time error (TE_R), see clause 3.1.24 of [ITU-T G.8260].

The maximum relative time error (max|TE_R|) between any two phase and time output ports (1 PPS, PTP) of a T-BC is for further study.

NOTE 1 – The relative time error, max|TE_R|, cTE_R, dTE_{RL}, is required by some applications that have a relative time error requirement between two end applications, e.g., the case of cooperating radio units.

NOTE 2 – Some end applications or deployments may not need the relative time error requirement for proper operation.

7.1.4.1 Relative constant time error noise generation (cTE_R)

For clock class C, the relative constant time error (cTE_R) between any two phase and time output ports (1 PPS, PTP) of a T-BC is shown in Table 7-8. For clock classes A, B and D, cTE_R is for further study.

Table 7-8 – T-BC permissible range of relative constant time error

T-BC class	Permissible range of relative constant time error – cTE _R (ns)
C	±12

NOTE 1 – Relative constant time error definition and the method to estimate relative constant time error are defined in [ITU-T G.8260]. For the purpose of testing the limits in Table 7-8, an estimate of constant time error should be obtained by averaging the time error sequence over 1 000 s.

NOTE 2 – Interfaces whose optical modules have uncontrolled asymmetric latency are for further study.

7.1.4.2 Relative dynamic time error low-pass filtered noise generation (dT_{ERL})

For T-BC classes A, B, and D, dT_{ERL} is for further study.

For a class C T-BC containing an enhanced synchronous equipment clock as specified in [ITU-T G.8262.1], the relative dynamic time error low-pass filtered noise generation (dT_{ERL}) between any two phase and time output ports (1 PPS, PTP) is shown in Table 7-9.

This applies under the following conditions:

- the T-BC is operating in locked mode synchronized to both a wander-free time reference at the PTP input and a wander-free frequency reference at the physical layer frequency input;
- the T-BC is operating under constant temperature (within ±1 K);
- the output time signals from the two ports are both measured through a first-order low-pass filter of bandwidth 0.1 Hz before re-sampling to align the sampling instants, as described in [ITU-T G.8260].

Table 7-9 – Relative dynamic time error low-pass filtered noise generation (MTIE) for T-BC with constant temperature (within ±1 K)

T-BC class	MTIE limit [ns]	Observation interval τ [s]
C	14	$m \leq \tau \leq 1\ 000$ (Note)

NOTE – The minimum τ value m is determined by packet rate of 16 packet per second ($m = 1/16$) or 1 PPS signal ($m = 1$).

The TDEV requirements for relative dynamic time error low-pass filtered noise generation are for further study.

7.2 Noise tolerance

The noise tolerance of a T-BC/T-TSC indicates the minimum dynamic time error level at the input of the clock that should be accommodated while:

- not causing any alarms;
- not causing the clock to switch reference;
- not causing the clock to go into holdover.

NOTE – There is no requirement related to cTE tolerance.

7.2.1 Noise tolerance for clock classes A and B

A T-BC/T-TSC classes A and B for use in the full timing support profile should be capable of tolerating the following levels of dTE and phase wander simultaneously:

- dTE according to [ITU-T G.8271.1] network limit, clause 7.3 at the PTP input;
- wander tolerance according to [ITU-T G.8262], clause 9.1.1 at the synchronous equipment clock input;

- wander tolerance according to [ITU-T G.813], clause 8.1 at the SDH input.

7.2.2 Noise tolerance for clock class C

A T-BC/T-TSC classes C for use in the full timing support profile should be capable of tolerating the following levels of dTE and phase wander simultaneously:

- dTE according to [ITU-T G.8271.1] network limit, clause 7.3 at the PTP input;
- wander tolerance according to [ITU-T G.8262.1], clause 9 at the enhanced synchronous equipment clock input;

The noise tolerance for T-BC/T-TSC class D is for further study.

7.3 Noise transfer

The transfer characteristic of the T-BC/T-TSC determines its properties with regard to the transfer of time error from the PTP input interface to the PTP and 1 PPS output interfaces. It also accounts for the transfer of phase wander from the physical layer interface to the PTP and 1 PPS output interfaces.

NOTE 1 – For purposes of measuring the noise transfer, the impact of the test method may be critical. For example, it is known that some signal artefacts (known as sub-Nyquist artefacts) may be present due to improper test frequency selection. In particular, when using direct measurement methods or when measuring the noise transfer of a nonlinear filter, test signal frequencies that are equal to (m/n) multiplied by the Nyquist frequency, where (m/n) is a reduced fraction and m and n are small integers (e.g., less than 10) should be avoided. For instance, for a Nyquist frequency of 0.5 Hz, examples of frequencies that should be avoided are 0.1 Hz ($m = 1, n = 5$), 0.25 Hz ($m = 1, n = 2$), 0.3 Hz ($m = 3, n = 5$), 0.5 Hz ($m = 1, n = 1$), 0.7 Hz ($m = 7, n = 5$), 1 Hz ($m = 2, n = 1$), 2 Hz ($m = 4, n = 1$), etc. and frequencies very close to these frequencies. Other mathematical processing methods may be less restricted with the choice of frequencies used. However, frequencies of the type $(m,1)$ should be avoided as they cannot be measured. Details on specific methods are for further study.

NOTE 2 – At all permissible noise input levels, the gain peaking from PTP to PTP, or from physical layer frequency to PTP is far lower than the permitted noise generation of the clock at the PTP and 1 PPS outputs. Therefore, it may be difficult to verify the gain peaking at either the PTP or 1 PPS outputs.

7.3.1 PTP to PTP and PTP to 1 PPS noise transfer

The bandwidth of a T-BC/T-TSC should not exceed 0.1 Hz and should not be less than 0.05 Hz.

In the passband, the phase gain of the T-BC/T-TSC should be smaller than 0.1 dB (1.1%).

NOTE 1 – Noise transfer only applies to dynamic time noise; there is no requirement related to cTE transfer.

NOTE 2 – See Note 1 and Note 2 in clause 7.4.

NOTE 3 – Since the PTP message rate is nominally 16 Hz, the maximum observable input frequency content would be 8 Hz.

NOTE 4 – When measuring on the 1 PPS output, the response to an input frequency component above 0.5 Hz will be measured as an aliased component.

7.3.2 Physical layer frequency to PTP and physical layer frequency to 1 PPS noise transfer for T-BC/T-TSC classes A and B

The output PTP signal and 1 PPS signal must correspond to the input physical layer frequency input signal on which a band-pass filter whose lower corner frequency is between 0.05 Hz and 0.1 Hz and whose upper corner frequency is between 1 Hz and 10 Hz has been applied.

In the passband, the phase gain of the synchronous equipment clock should be smaller than 0.2 dB (2.3%).

NOTE 1 – The above requirement applies to the case where a physical layer clock is implemented as per [ITU-T G.8262] option 1 to assist the T-BC/T-TSC, where the filter bandwidth is between 1 Hz and 10 Hz. When a different physical layer clock is used with a lower filter bandwidth to assist the T-BC/T-TSC, such as [ITU-T G.812] Type I, the input physical layer frequency noise transferred to the output PTP (1 PPS) signal is

further attenuated. The detailed characteristics of the T-BC/T-TSC based on clocks different from [ITU-T G.8262] option 1 and from [ITU-T G.8262.1] is for further study, such as the impact on Annex B (control of transients due to rearrangements in the physical layer frequency network), and noise accumulation in a chain of T-BCs.

NOTE 2 – See Note 1 and Note 2 in clause 7.4.

NOTE 3 – When measuring on the PTP output, the response to an input frequency component above 8 Hz will be measured as an aliased component.

NOTE 4 – When measuring on the 1 PPS output, the response to an input frequency component above 0.5 Hz will be measured as an aliased component.

7.3.3 Physical layer frequency to PTP and physical layer frequency to 1 PPS noise transfer for T-BC/T-TSC classes C and D

The output PTP signal and 1 PPS signal must correspond to the input physical layer frequency input signal on which a band-pass filter whose lower corner frequency is between 0.05 Hz and 0.1 Hz and whose upper corner frequency is between 1 Hz and 3 Hz has been applied.

In the passband, the phase gain of the enhanced synchronous equipment clock should be smaller than 0.2 dB (2.3%).

NOTE 1 – The above requirement applies to the case where a physical layer clock is implemented as per [ITU-T G.8262.1] to assist the T-BC/T-TSC, where the filter bandwidth is between 1 Hz and 3 Hz. When a different physical layer clock is used with a lower filter bandwidth to assist the T-BC/T-TSC, such as [ITU-T G.812] Type I, the input physical layer frequency noise transferred to the output PTP (1 PPS) signal is further attenuated. The detailed characteristics of the T-BC/T-TSC based on clocks different from [ITU-T G.8262.1] is for further study, such as the impact on Annex C (Control of the phase transient due to rearrangements in the enhanced physical layer network), and noise accumulation in a chain of T-BCs.

NOTE 2 – See Note 1 and Note 2 in clause 7.4.

NOTE 3 – When measuring on the PTP output, the response to an input frequency component above 8 Hz will be measured as an aliased component.

NOTE 4 – When measuring on the 1 PPS output, the response to an input frequency component above 0.5 Hz will be measured as an aliased component.

7.4 Transient response and holdover performance

7.4.1 Transient response

7.4.1.1 PTP output and 1 PPS output transient response due to rearrangement of physical layer frequency transport and PTP network

The transient response of the T-BC/T-TSC due to a simultaneous or nearly coincident rearrangement of both the PTP network and the physical layer frequency transport is for further study.

7.4.1.2 PTP output and 1 PPS output transient response due to rearrangement of PTP network

The requirements for the cases of PTP-to-PTP and PTP-to-1 PPS transient response due to a rearrangement of the PTP network are for further study.

For further information, refer to Appendix X of [ITU-T G.8271.1].

7.4.1.3 PTP output and 1 PPS output transient response due to rearrangement of physical layer frequency transport

The physical layer frequency to PTP and physical layer frequency to 1 PPS transient response due to a rearrangement of the physical layer frequency transport is specified in Annex B for clock classes A and B, and in Annex C for clock class C.

The physical layer frequency to PTP and physical layer frequency to 1 PPS transient response due to a rearrangement of the physical layer frequency transport is for further study for clock class D.

7.4.1.4 PTP output and 1 PPS output transient response due to long term rearrangement of physical layer frequency transport

When a T-BC/T-TSC loses all its physical layer frequency references, the T-BC/T-TSC may rely on a phase and time input.

This requirement reflects the performance of the clock in cases when the physical layer frequency input is ideal followed by long-term rearrangement of the physical layer frequency input. The PTP input is ideal. See Appendix X for further details.

At the precision time protocol (PTP) and 1 pulse per second (PPS) outputs, over any period of $S > 15$ s (longer than specified in Annex C), the maximum absolute time error ($\max|TE|$), excluding any constant time error (cTE), is constrained to below 58 ns for T-BC/T-TSC class C with constant temperature (within ± 1 K) or variable temperature. The requirement is evaluated without a measurement filter on the TE samples. This requirement is for further study for T-BC classes A, B, and D.

NOTE – A measurement period of one hour for constant temperature and 10 000 s for variable temperature can be used for testing purposes. The constant time error should be estimated before the physical layer frequency reference is removed or degraded, so that it can be removed from the test results.

7.4.2 Holdover performance

The requirements in this clause bound the maximum excursions in the PTP and 1 PPS output signal during loss of PTP input and/or physical layer frequency input. Additionally, it restricts the accumulation of the phase movement during input signal impairments or internal disturbances.

NOTE – The requirement for the case of long-term rearrangement of physical layer frequency with an ideal PTP input is not considered holdover, and therefore is specified in clause 7.4.1.4.

7.4.2.1 T-BC/T-TSC performance during loss of physical layer frequency assistance and loss of phase and time input reference

When a T-BC/T-TSC loses all its physical layer frequency and phase and time inputs, it enters the phase/time holdover state. Under these circumstances, the T-BC/T-TSC may rely on a local oscillator.

This requirement reflects the performance of the clock in cases when the PTP input and physical layer frequency input are ideal followed by disconnection of the PTP input and physical layer frequency input.

The phase/time holdover (both physical layer and PTP inputs are lost) requirements applicable to a T-BC/T-TSC are for further study.

7.4.2.2 T-BC/T-TSC classes A and B performance with physical layer frequency assistance during loss of PTP input reference

When a T-BC/T-TSC classes A and B loses all of its input phase and time references, it enters the phase/time holdover state. Under these circumstances, the T-BC/T-TSC may rely on a physical layer frequency assistance reference traceable to a primary reference clock (PRC).

This requirement reflects the performance of the clock in cases when the PTP input is ideal followed by disconnection of the PTP input. The physical layer frequency input is ideal.

The phase/time output will be measured through a first order low-pass filter with bandwidth of 0.1 Hz.

The phase/time performance during loss of PTP input reference requirements based on physical layer frequency applicable to a T-BC/T-TSC under constant temperature conditions is shown in Table 7-10 and Figure 7-1. Under constant temperature conditions (within ± 1 K) the maximum observation interval is 1 000 seconds.

Table 7-10 – Performance allowance during loss of PTP input (MTIE) for T-BC/T-TSC classes A and B with constant temperature

MTIE limit [ns]	Observation interval τ [s]
$22 + 40 \tau^{0.1}$	$1 \leq \tau \leq 100$
$22 + 25.25 \tau^{0.2}$	$100 < \tau \leq 1\ 000$

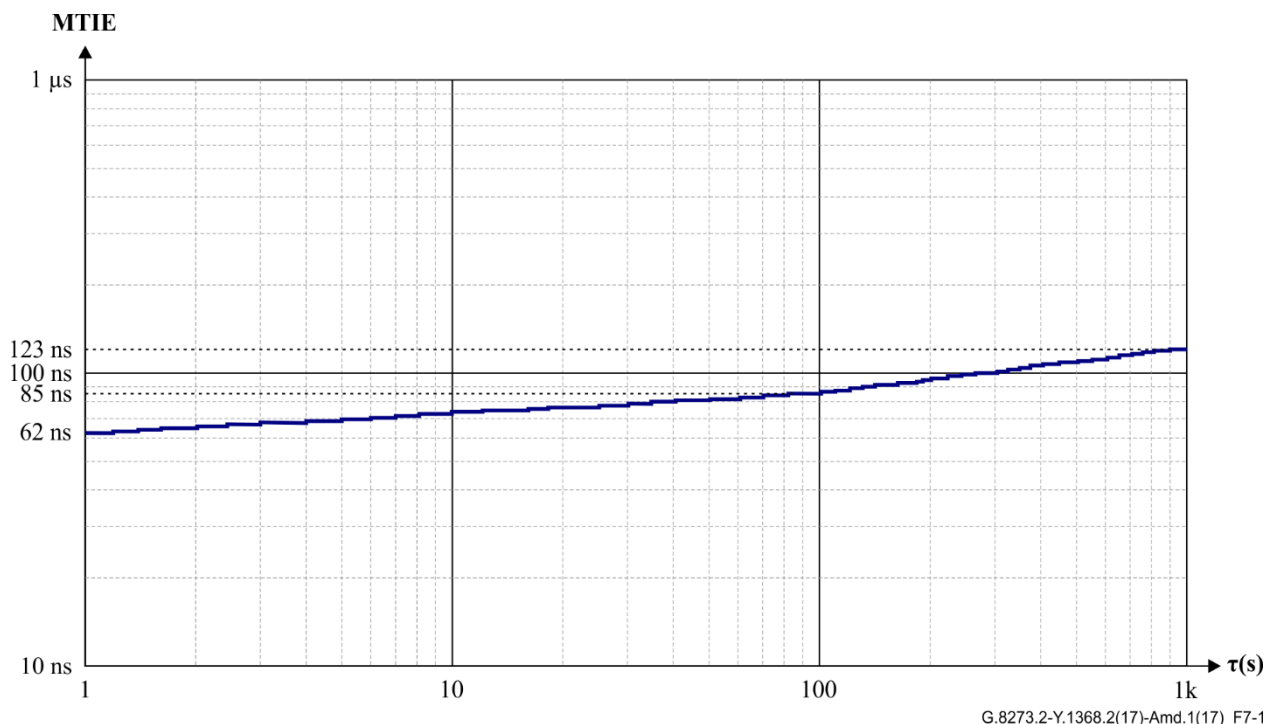

Figure 7-1 – Performance allowance during loss of PTP input (MTIE) for T-BC/T-TSC with constant temperature

The phase/time performance during loss of PTP input reference requirements based on physical layer frequency applicable to a T-BC/T-TSC under variable temperature conditions is shown in Table 7-11 and Figure 7-2. Under variable temperature conditions the maximum observation interval is 10 000 seconds.

Table 7-11 – Performance allowance during loss of packet signal input (MTIE) for T-BC/T-TSC classes A and B with variable temperature

MTIE limit [ns]	Observation interval τ [s]
$22 + 40 \tau^{0.1} + 0.5 \tau$	$1 \leq \tau \leq 100$
$72 + 25.25 \tau^{0.2}$	$100 < \tau \leq 1\ 000$
for further study	$1\ 000 < \tau \leq 10\ 000$

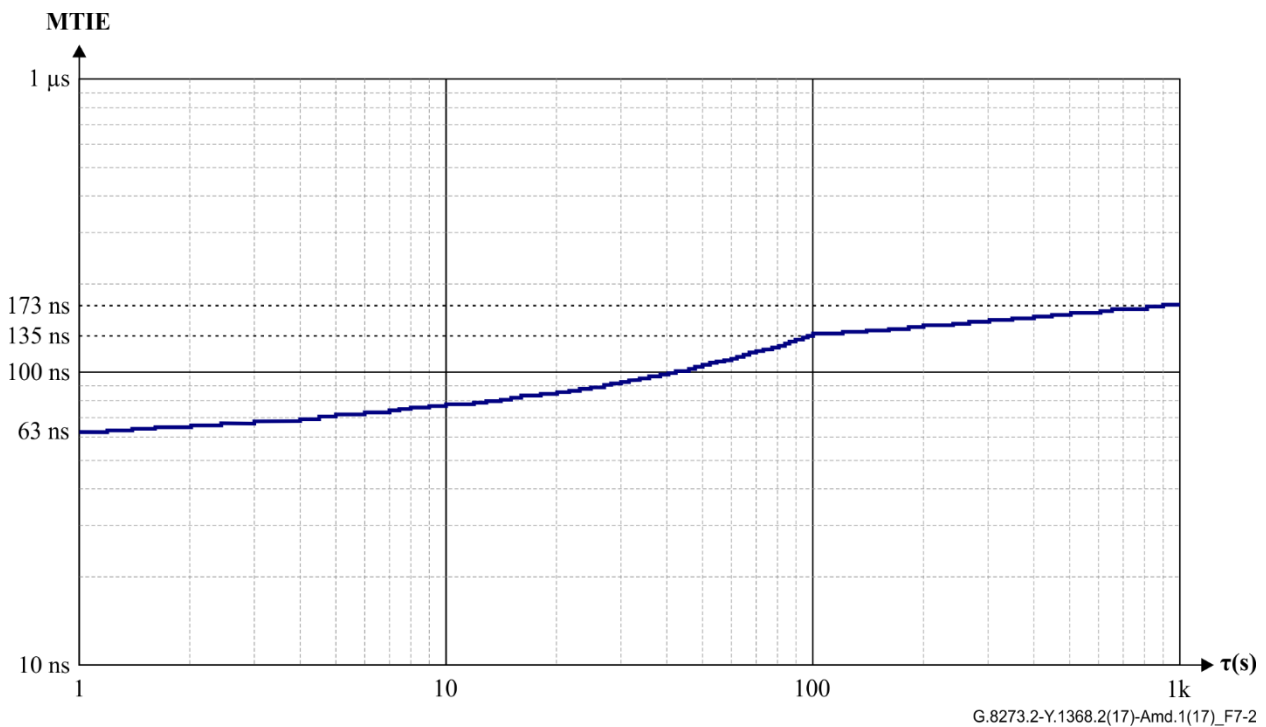

Figure 7-2 – Performance allowance during loss of PTP input (MTIE) for T-BC/T-TSC classes A and B with variable temperature

NOTE – Guidelines for variable temperature testing are described in Appendix I of [ITU-T G.8273].

7.4.2.3 T-BC/T-TSC classes C and D performance with physical layer frequency assistance during loss of PTP input reference

When a T-BC/T-TSC classes C and D loses all of its input phase and time references, it enters the phase/time holdover state. Under these circumstances, the T-BC/T-TSC may rely on a physical layer frequency assistance reference traceable to a primary reference clock (PRC).

This requirement reflects the performance of the clock in cases when the PTP input is ideal followed by disconnection of the PTP input. The physical layer frequency input is ideal.

The phase/time holdover (with physical layer frequency assistance during loss of PTP input reference) requirements applicable to a T-BC/T-TSC classes C and D are for further study.

7.5 Interfaces

The requirements in this Recommendation are related to reference points which may be internal to the equipment or network element (NE) in which the T-BC/T-TSC is embedded and are therefore not necessarily available for measurement or analysis by the user. Consequently, the performance of the T-BC/T-TSC is not specified at these internal reference points, but rather at the external interfaces of the equipment.

Note that not all of the interfaces below need to be implemented on all equipment.

7.5.1 Phase and time interfaces for T-BC/T-TSC classes A and B

The phase and time interfaces specified for the equipment in which the T-BC/T-TSC may be contained are:

- Ethernet interface carrying PTP messages;

NOTE – Ethernet interfaces can combine synchronous Ethernet for frequency and PTP messages. These interfaces may also carry other traffic in addition to PTP traffic.

- ITU-T V.11-based time/phase distribution interface, as defined in [ITU-T G.703] and [ITU-T G.8271];
- 1 PPS 50 Ω phase-synchronization measurement interface, as defined in [ITU-T G.703] and [ITU-T G.8271];
- other interfaces are for further study.

7.5.2 Phase and time interfaces for T-BC/T-TSC classes C and D

The phase and time interfaces specified for the equipment in which the T-BC/T-TSC may be contained are:

- Ethernet interface carrying PTP messages;

NOTE 1 – Ethernet interfaces can combine Synchronous Ethernet for frequency and PTP messages. These interfaces may also carry other traffic in addition to PTP traffic.

NOTE 2 – Ethernet interfaces can be used as measurement interfaces.

- 1 PPS 50 Ω phase-synchronization measurement interface, as defined in [ITU-T G.703] and [ITU-T G.8271];

For the measurement of T-BC/T-TSC class-C and class-D, the following requirements apply:

- The measurement reference point of the 1 PPS 50 Ω measurement interface should be set to the 50% 1 PPS signal level.
- The cable delay should be accurately determined and compensated for.
- A high-quality cable with a maximum length of 3 m should be used.
- Other interfaces are for further study.

7.5.3 Frequency interfaces

The frequency interfaces specified for the equipment in which the T-BC/T-TSC may be contained are:

- 2 048 kHz interfaces according to [ITU-T G.703] with additional jitter and wander requirements as specified herein;
- 1 544 kbit/s interfaces according to [ITU-T G.703] with additional jitter and wander requirements as specified herein;
- 2 048 kbit/s interfaces according to [ITU-T G.703] with additional jitter and wander requirements as specified herein;
- STM-N traffic interfaces;
- synchronous Ethernet interfaces;

(NOTE – Ethernet interfaces can combine PTP and synchronous Ethernet. These interfaces may also carry other traffic in addition to PTP and ESMC traffic.)

- Other interfaces are for further study.

Annex A

Telecom boundary clock and telecom synchronous clock models

(This annex forms an integral part of this Recommendation.)

Figure A.1 illustrates a telecom boundary clock and telecom synchronous clock models.

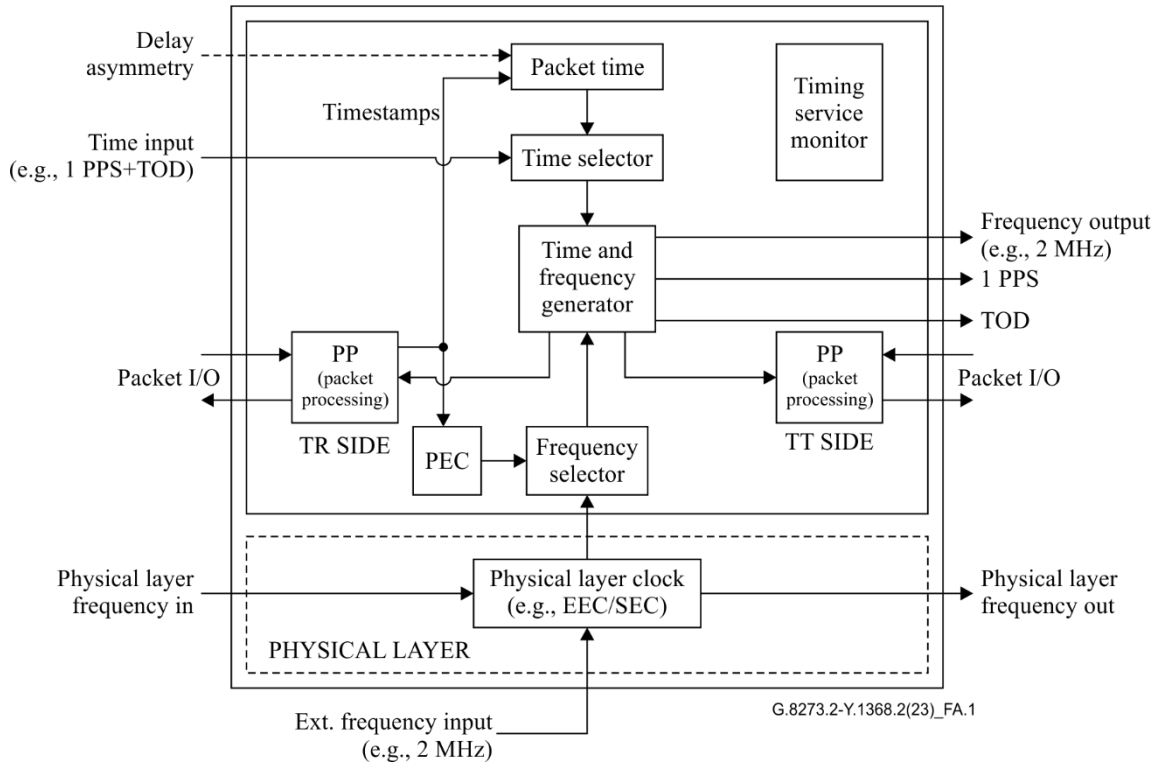

Figure A.1 – Telecom boundary clock and telecom synchronous clock models

NOTE 1 – The physical layer frequency signal may be bidirectional for SyncE/SDH.

NOTE 2 – The "Physical layer clock" includes a selection mechanism as there may be multiple inputs.

NOTE 3 – T-BC functional model is also applicable to the T-TSC, except for the PTP timeTransmitter side (the T-TSC functional model includes the 1 PPS and ToD interface). Physical layer frequency output (e.g., SyncE) is optional for T-TSC.

Figure A.1 shows a functional model of a telecom boundary clock and telecom synchronous clock. It is not intended to specify any specific implementation. Any implementation specific detail is outside the scope of this Recommendation.

The packet timing signal is processed by the packet processing block, the timestamps are sent to the packet time and to the packet-based equipment clock (PEC) blocks for further processing. The time information carried in the timestamps are used as an input to the time control to generate the time information to control the local time scales. Delay asymmetry established by means beyond the scope of the protocol-layer messages can be provided as a correction term. The frequency information carried in the timestamps is used in the PEC to generate the local frequency.

The time selector block may select either the time information recovered from the timestamps, or the local time input (e.g., 1 PPS+ time of day (ToD)).

The frequency selector block may select either the frequency information recovered from the timestamps, or the frequency recovered from a physical layer clock (e.g., synchronous Ethernet, or SDH).

The timing service monitor block provides monitoring of a timing service received by the clock according to key performance indicators. As an example, it may monitor the PTP timing service by analysing the PTP timestamps from the packet processing block (timeReceiver side) and raise an unusable alarm based on implementation specific criteria.

Annex B

Control of the phase transient due to rearrangements in the physical layer network

(This annex forms an integral part of this Recommendation.)

NOTE 1 – This annex is valid for T-BCs and T-TSCs classes A and B embedding a physical layer physical clock per [ITU-T G.8262] (e.g., SyncE). A T-BC and T-TSC shall properly limit the generation of phase/time error due to a rearrangement of the physical layer frequency transport (e.g., SyncE, SDH) by using ingress QL information (e.g., ESMC message). In the worst-case, the input signal frequency will experience a rearrangement transient as detailed in Figure 12 of [ITU-T G.8262] and Figure 12 of [ITU-T G.813]. When a physical layer frequency network rearrangement occurs, the T-BC or T-TSC may experience an initial output transient when the physical layer frequency input loses PRC-traceability and a second output transient when or after the physical layer frequency input again becomes PRC-traceable. The absolute value of T-BC and T-TSC output phase error shall meet the following requirements when these transients occur: the T-BC output phase error at the PTP and 1 PPS outputs and the T-TSC output phase error at the 1 PPS output shall not exceed the mask of Figure B.1 and Table B.1.

NOTE 2 – The mask of Figure B.1 assumes that the physical layer frequency input signal loses PRC traceability at time zero and becomes traceable again at 15 s (i.e., the physical layer frequency input transient is completed by 15 s). The re-establishment of PRC-traceability will be earlier in smaller rings; the exact time depends on the number of synchronous equipment clocks in the ring and the exact values of the SSM message delays. The mask is extended to 50 s to allow time for the T-BC and the T-TSC to either re-acquire the physical layer frequency input signal or begin using the T-BC and the T-TSC filter again after PRC-traceability has been re-established.

The physical layer frequency input transient test is done without a measurement filter and should exclude any constant time error. Ideally, the absolute value of unfiltered dTE is desired.

See Appendix II for background on the assumptions and derivations for the masks of Figure B.1 and Table B.1.

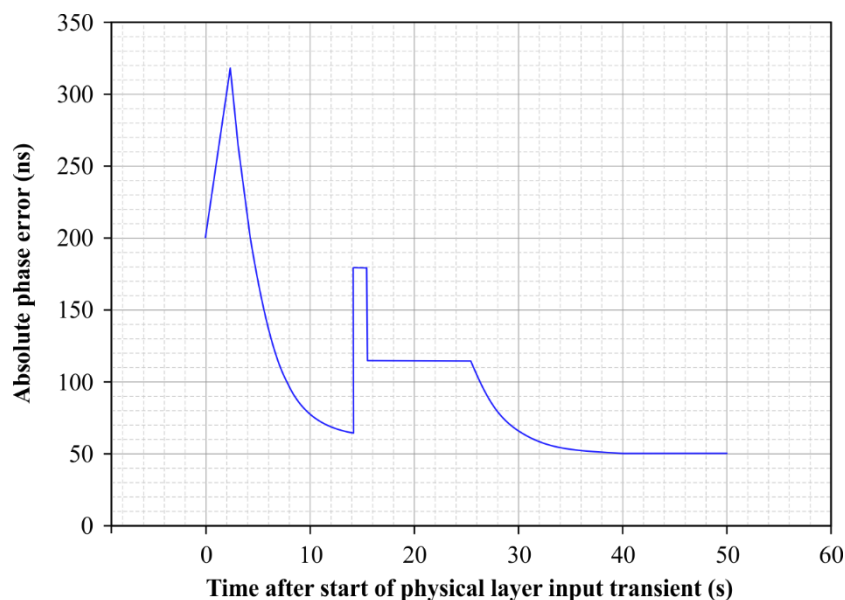

G.8273.2-Y.1368.2(23)_FB.1

Figure B.1 – Phase error limit for PTP and 1 PPS output phase error transient after the start of the physical layer frequency input transient

Table B.1 – T-BC and the T-TSC output phase transient mask for PTP and 1 PPS output transient after start of physical layer frequency rearrangement (at and just after loss of - traceability by the physical layer frequency input signal)

Time S after start of physical layer frequency input transient (s)	T-BC and the T-TSC output absolute phase error (ns)
$0 \leq S < 2.4$	$200 + 50 S$
$2.4 \leq S < 14.25$	$50 + 270 e^{-2\pi(0.05)(S - 2.4)}$
$14.25 \leq S < 15.5$	180
$15.5 \leq S < 25.5$	115
$25.5 \leq S \leq 50$	$50 + 65 e^{-2\pi(0.05)(S - 25.5)}$

NOTE 3 – As per [ITU-T G.8264] SSM might be disabled by the operator. The impact on the mitigation of time error due to physical layer frequency network rearrangement when not using SSM is under the responsibility of the operator and is for further study.

Annex C

Control of the phase transient due to rearrangements in the enhanced physical layer network

(This annex forms an integral part of this Recommendation.)

NOTE 1 – This annex is valid for T-BCs and T-TSCs class C embedding an enhanced physical layer physical clock per [ITU-T G.8262.1].

A T-BC and T-TSC shall properly limit the generation of phase/time error due to a rearrangement of the physical layer frequency transport (e.g., enhanced SyncE) by using ingress QL information (e.g., ESMC message). In the worst-case, the enhanced physical layer signal will experience a rearrangement transient as detailed in Figure 6 of [ITU-T G.8262.1]. When an enhanced physical layer frequency network rearrangement occurs, the T-BC or T-TSC may experience an initial output transient when the enhanced physical layer frequency input loses PRC traceability and a second output transient when or after the enhanced physical layer frequency input again becomes PRC traceable. The absolute value of T-BC and T-TSC output phase error shall meet the following requirements when these transients occur: the T-BC output phase error at the PTP and 1 PPS outputs and the T-TSC output phase error at the 1 PPS output shall not exceed the mask of Figure C.1 and Table C.1 below.

NOTE 2 – The mask of Figure C.1 assumes that the enhanced physical layer frequency input signal loses PRC traceability at time zero and becomes traceable again at 15 s (i.e., the enhanced physical layer frequency input transient is completed by 15 s). The re-establishment of PRC traceability will be earlier in smaller rings; the exact time depends on the number of synchronous equipment clocks in the ring and the exact values of the SSM message delays. The mask is extended to 50 s to allow time for the T-BC and the T-TSC to either re-acquire the enhanced physical layer frequency input signal or begin using the T-BC and the T-TSC filter again after PRC-traceability has been re-established.

The enhanced physical layer frequency input transient test is done without a measurement filter and should exclude any constant time error. Ideally, the absolute value of unfiltered dTE is desired.

See Appendix II for background on the assumptions and derivations for the masks of Figure C.1 and Table C.1.

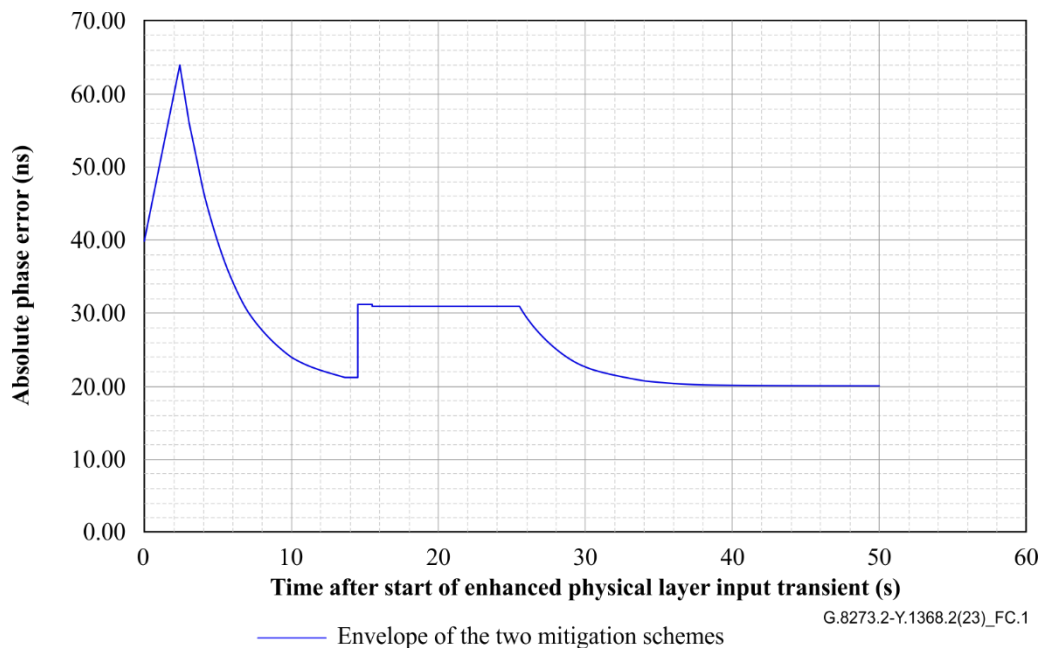

Figure C.1 – Phase error limit for PTP and 1 PPS output phase error transient after the start of the enhanced physical layer frequency input transient

Table C.1 – T-BC and the T-TSC output phase transient mask for PTP and 1 PPS output transient after start of enhanced physical layer frequency input transient (at and just after loss of PRC-traceability by the enhanced physical layer frequency input signal)

Time S after start of physical layer frequency input transient (s)	T-BC output absolute phase error (ns)
$0 \leq S < 2.4$	$40 + 10 S$
$2.4 \leq S < 13.75$	$20 + 44 e^{-2\pi(0.05)(S - 2.4)}$
$13.75 \leq S < 14.5$	21.3
$14.5 \leq S < 15.5$	31.3
$15.5 \leq S < 25.5$	31
$25.5 \leq S \leq 50$	$20 + 11 e^{-2\pi(0.05)(S - 25.5)}$

NOTE 3 – As per [ITU-T G.8264] SSM might be disabled by the operator. The impact on the mitigation of time error due to physical layer frequency network rearrangement when not using SSM is under the responsibility of the operator and is for further study.

Appendix I

Mitigation of time error due to physical layer frequency input transients

(This appendix does not form an integral part of this Recommendation.)

NOTE – This appendix is valid for T-BCs and T-TSCs classes A and B.

Appendix II, clause II.1.2 of [ITU-T G.8271.1], illustrates hypothetical reference models for the transport of phase/time via PTP with physical layer frequency support. Figure II.2 of [ITU-T G.8271.1] illustrates the congruent scenario, where the frequency and phase/time transports follow the same synchronization path. Figure II.3 of ITU-T G.8271.1 illustrates the non-congruent scenario, where the frequency and phase/time transports follow different synchronization paths. A rearrangement of the physical layer frequency, e.g., SyncE, transport results in phase/time error at each T-BC, the T-TSC and the end application.

In the congruent scenario, the time error due to the physical layer frequency network (e.g., SyncE, SDH) rearrangement can be reduced to an acceptable level if the physical layer signal is rejected after the physical layer transient is detected. Note that the rejection of the physical layer signal is an implementation method. This method permits switching temporarily, for a short period, upon detection of a physical layer frequency input failure (e.g., using the SSM information), from a mode where physical layer frequency input support is used for frequency transport to a mode where only the PTP messages are used to recover frequency; after the physical layer frequency input reconfiguration is completed, the mode of operation is still expected to become again based on physical layer frequency input for frequency transport. Specifically, the physical layer frequency input signal is rejected when the SSM indicating the physical layer frequency input signal is no longer PRC-traceable is received by the synchronous equipment clock collocated with that T-BC or T-TSC, and the physical layer frequency input signal is again used at a time T_{reacq} after receipt of the SSM indicating the physical layer frequency input signal is again PRC-traceable is received by the synchronous equipment clock collocated with that T-BC or T-TSC.

In the non-congruent scenario, the time error will be acceptable if the T-BCs, T-TSC and end application have maximum bandwidth of 0.1 Hz and maximum gain peaking of 0.1 dB, and if the frequency plane clocks collocated with the T-BCs, T-TSC and end application are synchronous equipment clocks. This is true whether or not the physical layer frequency input transient is rejected at each T-BC/T-TSC.

Appendix II

Derivation of T-BC/T-TSC output transient mask due to physical layer frequency network rearrangement

(This appendix does not form an integral part of this Recommendation.)

NOTE 1 – This appendix is valid for two types of T-BC and T-TSC:

- T-BC/T-TSC embedding a SEC (e.g., classes A and B T-BC) and assuming the physical layer frequency input signal (e.g., SyncE/SDH) undergoes the transient of Figure 12 of [ITU-T G.8262] at the input port of the T-BC of interest,
- T-BC/T-TSC embedding an eSEC (e.g., class C T-BC) and assuming the enhanced physical layer frequency input signal (e.g., SyncE) undergoes the transient of Figure 6 of [ITU-T G.8262.1] at the input port of the T-BC of interest.

Class D clocks are for further study.

NOTE 2 – The derivation of T-BC output transient mask due to physical layer frequency network rearrangement explained in this Appendix is also applicable to case of the T-TSC.

The absolute value of T-BC output phase transient due to a physical layer frequency network rearrangement is derived for the following two mitigation schemes:

- a) Reject the physical layer frequency input signal on receipt of the SSM that indicates the physical layer frequency input is no longer PRC-traceable, and
- b) Turn off the T-BC filter on receipt of the SSM that indicates the physical layer frequency input is no longer PRC-traceable

In the derivation for physical layer frequency, the input transient is assumed to be as specified in Figure 12 of [ITU-T G.8262], with the initial 120 ns phase change starting at time zero and the final 120 ns phase change ending 15 s later. In the derivation for the enhanced physical layer frequency, the input transient is assumed to be as specified in Figure 6 of [ITU-T G.8262.1] with the initial 10 ns phase change starting at time zero and the final 10 ns phase change ending 15 s later. The output transients for schemes (a) and (b) are obtained and the transient mask is taken as the upper envelope of these two output transients.

II.1 Background on assumptions for and derivation of T-BC output phase error due to a physical layer frequency network rearrangement

The T-BC output phase error mask of Figure B.1 of Annex B is based on two possible techniques for mitigating the output phase error due to the HRM2 (hypothetical reference model 2) rearrangement for T-BC/T-TSC classes A and B. Similarly, the T-BC output phase error mask of Figure C.1 of Annex C is based on the same two mitigation techniques, for T-BC/T-TSC class C.

With the first technique, the physical layer frequency clock (e.g., EEC) co-located with the T-BC informs the T-BC that the physical layer frequency input is no longer PRC-traceable when the physical layer frequency clock receives the SSM indicating this. When the T-BC is notified, it rejects the physical layer frequency input transient and operates in the PTP only mode (i.e., without the use of physical layer frequency input to recover frequency). When the physical layer frequency clock switches a second time and is again PRC-traceable, it informs the T-BC. The T-BC then reacquires the physical layer frequency input signal. The T-BC typically waits at least 10 s after it is informed that the physical layer frequency input is again traceable to reacquire the physical layer frequency input, to ensure that the physical layer frequency transient is completed; however, the important condition is that the mask of Figure B.1 (for T-BC/T-TSC classes A and B) or Figure C.1 (for T-BC/T-TSC class C) is satisfied (i.e., the T-BC can reacquire the physical layer frequency input signal before 10 s have elapsed if it can satisfy the mask).

With the second technique, the physical layer frequency keeps being used for the recovered frequency, however the T-BC filter is turned off when the T-BC is notified by the SEC/eSEC that the physical layer frequency input is no longer traceable (i.e., when the SEC/eSEC receives the SSM indicating this). The turning off of the filter means that it is no longer applied to the incoming PTP signal (as a low-pass filter) or to the physical layer frequency input signal (as a high-pass filter). When the T-BC is notified by the physical layer frequency clock that the synchronous equipment clock is again traceable, the filter is again turned on. As with the first technique, the T-BC typically waits at least 10 s after it is informed that the physical layer frequency input is again traceable to turn the filter on, to ensure that the physical layer frequency input transient is completed; however, the important condition is that the mask of Figure B.1 (for T-BC/T-TSC classes A and B) or Figure C.1 (for T-BC/T-TSC class C) is satisfied (i.e., the T-BC can turn the filter back on before 10 s have elapsed if it can satisfy the mask). To avoid a transient when the T-BC filter is turned back on, the filter continues to operate on the physical layer frequency input signal (with the physical layer frequency input transient present) and the PTP signal and the state of the filter is computed throughout the transient (i.e., at each sampling instant). However, the filter output is not used while the filter is turned off; the computations are done only so that the filter state will be known. When the filter is turned back on, the computed filter state at that instant is used as the initial state.

The mask of Figure B.1 (for T-BC/T-TSC classes A and B) is obtained by computing the absolute value of T-BC filter output phase error history, for each of the above techniques, assuming the physical layer frequency input undergoes the transient of Figure 12 of [ITU-T G.8262]. With each technique, it is found that the T-BC filter output history contains an initial transient when physical layer frequency input traceability is lost and a second transient when or shortly after physical layer frequency input traceability is regained. The actual duration of the time interval between the two transients depends on how large the physical layer frequency clock network is (the interval is longer for larger clock networks). However, in Figure 12 of [ITU-T G.8262] the time interval between the start of the initial transient (i.e., the first 120 ns phase change at a rate of 7.5 ppm) and the start of the second transient (i.e., the second 120 ns phase change at a rate of 7.5 ppm) is 14.984 s.

Similarly, the mask of Figure C.1 (for T-BC/T-TSC class C) is obtained by computing the absolute value of T-BC filter output phase error history, for each of the above techniques, assuming the enhanced physical layer frequency input undergoes the transient of Figure 6 of [ITU-T G.8262.1]. With each technique, it is found that the T-BC filter output history contains an initial transient when enhanced physical layer frequency input traceability is lost and a second transient when or shortly after enhanced physical layer frequency input traceability is regained. The actual duration of the time interval between the two transients depends on how large the enhanced physical layer frequency clock network is (the interval is longer for larger clock networks). However, in Figure 6 of [ITU-T G.8262.1] the time interval between the start of the initial transient (i.e., the first 10 ns sudden phase change) and the start of the second transient (i.e., the second 10 ns sudden phase change) is 15 s.

The steady-state T-BC noise generation requirements are provided in clause 7.1.

The physical layer frequency input transient test is done without a measurement filter and should exclude any constant time error. Ideally, the absolute value of unfiltered dTE is desired.

The simulations done for T-BC classes A and B showed that the unfiltered dTE does not exceed 80 ns peak-to-peak. While selected results were not highly asymmetric, they did exhibit some asymmetry. To allow margin for some asymmetry, it will be assumed that the unfiltered dTE $\max|TE|$ is 50 ns. It is further assumed that the 50 ns maximum dTE is due to steady-state physical layer frequency clock noise accumulation and timestamp granularity. Any phase error due to the physical layer frequency network rearrangement is added to this. In addition, this value does not include cTE. For testing purpose, if it is not convenient to remove cTE, this should be added to the mask derived below, i.e., the total $\max|TE|$ from Table 7-1 (100 ns for class A and 70 ns for class B) should be used instead of the assumed 50 ns zero-to-peak for dTE.

Similarly, for enhanced physical layer frequency for T-BC class C, a value of 20 ns for the unfiltered dTE is used. For testing purposes, if it is not convenient to remove cTE, this should be added to the mask derived below, i.e., the total max|TE| from Table 7-1 (30 ns for class C) should be used instead of the assumed 20 ns zero-to-peak for dTE.

In all cases, it is assumed that the T-BC input is a PTP packet timing signal with mean Sync message rate of 16 messages/s. If other assumptions were made, e.g., if the input timing signal were 1 PPS instead of PTP, or if packet selection were performed that caused the mean rate of selected Sync message to be less than 16 messages/s, these cases would need to be analysed. In addition, the T-BC output phase computed is the actual phase (time) error; there is no additional measurement filter.

Note that:

- in Figure III.2 of [ITU-T G.8273], which gives the physical layer frequency input transient used in testing T-BC classes A and B, the 120 ns phase changes and 50 ns/s phase rate of change are reduced to 104 ns and 45 ns/s respectively. This was done to allow some margin in the test. The mask is derived here using the input transient of Figure 12 of [ITU-T G.8262];
- in Figure III.3 of [ITU-T G.8273], which gives the enhanced physical layer frequency input transient used in testing T-BC class C, the 10 ns phase changes and 10 ns/s phase rate of change are reduced to 7 ns and 9 ns/s respectively. This was done to allow some margin in the test. The mask is derived here using the input transient of Figure 6 of [ITU-T G.8262.1].

In addition, Appendix III of [ITU-T G.8273] presents three test cases. In the analysis here, we make conservative assumptions to produce a single mask that is applicable to all three test cases. In particular, the input transient of Figure 12 of [ITU-T G.8262] (and Figure 6 of [ITU-T G.8262.1] for enhanced physical layer frequency) is assumed to be the transient output of the upstream synchronous equipment clock, which is input to the T-BC (but subject to the assumptions of the two schemes). This is subject to the assumptions that (a) in Test case 1 of Appendix III of [ITU-T G.8273] the filtering of the synchronous equipment clock can be neglected and (b) in Test case 2 of Appendix III of [ITU-T G.8273] the output of the synchronous equipment clock does not exceed the mask of Figure 12 of [ITU-T G.8262] (and Figure 6 of [ITU-T G.8262.1] for enhanced physical layer frequency) when the physical layer frequency signal input to interface Y (Figure III.1 of [ITU-T G.8273]) is cut off. Test case 3 of Appendix III of [ITU-T G.8273] is less stringent, because in this method the ESMC QL is changed but no physical layer frequency input transient is applied.

The following are the assumptions made in computing the T-BC output phase error due to the physical layer frequency network rearrangement, using the first technique, i.e., rejection of the physical layer frequency input transient:

- a) The physical layer frequency input transient to class A and B T-BC at interface Y of Figure III.1 of [ITU-T G.8273] is given by Figure 12 of [ITU-T G.8262]. Similarly, the enhanced physical layer frequency input transient to class C T-BC at interface Y of Figure III.1 of [ITU-T G.8273] is given by Figure 6 of [ITU-T G.8262.1].
- b) The input PTP packet signal (i.e., carried by Sync and Delay_Req messages) is perfect, i.e., there is no phase error associated with this signal.
- c) The T-BC filter bandwidth is 0.05 Hz. This is the minimum T-BC and T-TSC bandwidth. It is modelled as a first-order filter and gain peaking is not modeled.
- d) The SEC/eSEC co-located with the T-BC receives an input SSM, indicating the physical layer frequency input signal is no longer PRC-traceable. This occurs 500-2 000 ms after the transient begins and represents the holdover message delay, i.e., T_{HM} . Clause 5.14 of [ITU-T G.781] specifies that T_{HM} is in this range.
- e) The SEC/eSEC co-located with the T-BC sends to the T-BC, via interface Z of Figure III.1 of [ITU-T G.8273], an SSM indicating it is no longer PRC-traceable between 0 and 200 ms after it receives the changed SSM. This is the non-switching message delay (see clause 5.14 of [ITU-T G.781]). This delay is due to software processing in the SEC/eSEC.

- f) The physical layer frequency input transient is rejected by the T-BC after a time interval has elapsed following the receipt of the SSM. This delay is due to software processes in the T-BC; it is approximated as having an upper bound that is equal to the non-switching message delay, i.e., 200 ms in clause 5.14 of [ITU-T G.781] and a lower bound of zero.
- g) There is a 30 ns phase jump at the class A and B T-BC input when the physical layer frequency input is rejected and a 60 ns phase jump when it is reacquired (simulations showed that $\max|TE|$ for HRM2, for a chain of 20 T-BCs, could be kept to within 200 ns with these phase jumps).

Similarly, there is a 10 ns phase jump at the class C T-BC input when the enhanced physical layer frequency input is rejected and a 10 ns phase jump when it is reacquired (simulations showed that $\max|TE|$ for HRM2, for a chain of 20 class C T-BCs, could be kept to within 100 ns with these phase jumps).

- h) The initial part of the physical layer frequency input transient is a 7.5 ppm phase ramp over 16 ms, followed by a 50 ns/s phase ramp, followed by a 30 ns phase jump when the physical layer frequency input signal is rejected. Based on (d), (e) and (f), the earliest the rejection can occur is at 0.5 s (500 ms) after the PRC-traceability is lost. The latest the rejection can occur is at 2.4 s (2 400 ms) after PRC-traceability is lost. The 30 ns phase jump can therefore occur anywhere between 500 ms and 2.4 s; to accommodate the worst case, we should take the envelope of all possibilities. For this envelope, we have an initial 7 500 ns/s slope until the time error changes by 120 ns, followed by a 50 ns/s slope to time 500 ms, followed by a 30 ns phase step, followed by a 50 ns/s slope to time 2 400 ms. A constant 50 ns phase is added to this entire transient to account for the phase error due to steady-state physical layer frequency clock phase noise (see above).

Similarly, the initial part of the enhanced physical layer frequency input transient has a sudden phase jump of 10 ns, followed by a 10 ns/s phase ramp, followed by a 10 ns phase jump on the 1 PPS or PTP output when the physical layer input signal is rejected. Based on (d), (e) and (f), the earliest the rejection can occur is at 0.5 s (500 ms) after the PRC-traceability is lost. The latest the rejection can occur is at 2.4 s (2 400 ms) after PRC-traceability is lost. The 10 ns phase jump on the 1 PPS or PTP output can therefore occur anywhere between 500 ms and 2.4 s; to accommodate the worst case, we should take the envelope of all possibilities. For this envelope, we have an initial 10 ns jump, followed by a 10 ns/s slope to time 500 ms, followed by another 10 ns phase jump, followed by a 10 ns/s slope to time 2 400 ms. A constant 20 ns phase is added to this entire transient to account for the phase error due to steady-state enhanced physical layer frequency clock phase noise.

- i) The phase increases described in (g) are assumed to be rapid enough that they are above the 0.1 Hz T-BC filter corner frequency. Since the T-BC filter acts as a high-pass filter on the physical layer frequency input signal, this initial part of the physical layer frequency input transient is passed through the filter approximately unaffected and the effect of the high-pass filtering can be ignored. This assumption is conservative, as accounting for the high-pass filter could only decrease the output phase error.

NOTE – There exist signals for which the zero-to-peak and peak-to-peak values are increased by high-pass filtering, e.g., a square wave whose period is much longer than the high-pass filter time constant, i.e., much smaller than the high-pass filter corner frequency. However, the signal of Figure 12 of [ITU-T G.8262] above is not in this category, and neither is the one of Figure 6 of [ITU-T G.8262.1].

- j) At 2.4 s, the SSM is received by the T-BC and the physical layer frequency input signal is rejected. The T-BC output phase error is an exponential decay with time constant $1/(2\pi \cdot 0.05 \text{ Hz})$ due to the relaxation of the filter.

k) At time 14.984 s after the start of the transient, the physical layer frequency input signal undergoes a 120 ns phase change, at a rate of 7.5 ppm and is traceable again. This phase jump has minimal impact on the T-BC output as the physical layer signal is currently rejected in this mitigation scheme. Between 180 ms and 500 ms after this (this is the range for the switching message delay specified in clause 5.14.1 of [ITU-T G.781]), the synchronous equipment clock sends an SSM indicating this to the T-BC. At some time within 10 s of this, the physical layer frequency input signal is restored and there is a 60 ns phase step, followed by an exponential decay with time constant $1/(2\pi \cdot 0.05 \text{ Hz})$ to the 50 ns level. This means that the 60 ns phase step can occur at any time between $14.984 \text{ s} + 0.18 \text{ s} = 15.164 \text{ s}$, and $14.984 \text{ s} + 0.5 \text{ s} + 10 \text{ s} = 25.484 \text{ s}$. The resulting mask will be taken as the upper envelope of all possible 60 ns phase steps in the range 15.164-25.484 s, with each phase step followed by an exponential decay.

Similarly, at time 15 s after the start of the transient, the enhanced physical layer frequency clock undergoes another sudden 10 ns phase jump and is traceable again. This sudden phase jump has minimal impact on the T-BC output as the enhanced physical layer signal is currently rejected in this mitigation scheme. Between 180 ms and 500 ms after this (this is the range for the switching message delay specified in clause 5.14.1 of [ITU-T G.781]), the enhanced synchronous equipment clock sends an SSM indicating this to the T-BC. Some time within 10 s of this, the enhanced physical layer frequency input is restored and there is a 10 ns phase jump, followed by an exponential decay with time constant $1/(2\pi \cdot 0.05 \text{ Hz})$ to the 20 ns level. This means that the 10 ns phase jump on the 1 PPS or PTP output can occur at any time between $15 \text{ s} + 0.18 \text{ s} = 15.18 \text{ s}$, and $15 \text{ s} + 0.5 \text{ s} + 10 \text{ s} = 25.5 \text{ s}$. The resulting mask will be taken as the upper envelope of all possible 10 ns phase jumps in the range 15.18-25.5 s, with each phase step followed by an exponential decay.

The following assumptions were made in computing the T-BC output phase error due to the physical layer frequency network rearrangement, using the second technique, i.e., turning off the T-BC filter:

- l) This assumption is the same as assumption (a) above for rejection of the physical layer frequency input signal.
- m) This assumption is the same as assumption (b) above for rejection of the physical layer frequency input signal.
- n) This assumption is the same as assumption (c) above for rejection of the physical layer frequency input signal.
- o) This assumption is the same as assumption (d) above for rejection of the physical layer frequency input signal.
- p) This assumption is the same as assumption (e) above for rejection of the physical layer frequency input signal.
- q) The T-BC filter is turned off after a time interval has elapsed following the receipt of the SSM. This delay is due to software processes in the T-BC; it is taken to have an upper bound equal to the non-switching message delay, i.e., 200 ms in clause 5.14 of [ITU-T G.781], and a lower bound of zero. When the next Sync message is received, an immediate correction to the time is made. While this Sync message carries the GM time, the T-BC phase error immediately after the correction is not zero because the most recent mean propagation delay computation was, in worst-case, based on previously received Sync and Delay_Req messages whose arrival and departure, respectively, were timestamped during the physical layer frequency input transient. The mean propagation delay is given by $[(T_4 - T_1) - (T_3 - T_2)]/2$. If we assume that the time interval between the receipt of the most recent Sync and the most recent Delay_Req is, in worst-case, two mean Delay_Req intervals, then the error in mean propagation delay is equal to the accumulated phase error over these two mean Delay_Req intervals, divided by 2. This value is $(2)(0.0625 \text{ s})(50 \text{ ns/s})/2 = 3.125 \text{ ns}$ for [ITU-T G.8262], and $(2)(0.0625 \text{ s})(10 \text{ ns/s})/2 = 0.625 \text{ ns}$ for [ITU-T G.8262.1]. Then, the T-BC phase error

due to the physical layer frequency input transient decreases to 3.125 ns above the 50 ns steady-state error, or 53.125 ns, when this next Sync message is received. Similarly, the T-BC phase error due to the enhanced physical layer frequency input transient decreases to 0.625 ns above the 20 ns steady-state error, or 20.625 ns, when this next Sync message is received. This occurs at most 0.125 s later, or at 2.525 s (i.e., at most two mean Sync intervals, since it is assumed that the actual time between Sync messages is bounded by 2 mean Sync intervals). When the next Sync message after this one is received, which is at most 0.125 s after 2.525 s, or 2.65 s, the T-BC phase error decreases to 50 ns (in case of SEC) or 20 ns (in case of eSEC).

- r) For SEC, between 2.65 s and when the physical layer frequency input signal is again traceable, at 14.984 s, the physical layer frequency input signal has a 50 ns/s frequency offset. This means that, since T-BC filtering is turned off, the T-BC phase error increases by $(50 \text{ ns/s})(0.125 \text{ s}) = 6.25 \text{ ns}$ over the interval between successive Sync messages (the inter-message interval is taken as 0.125 s because clause 6.2.8 of [ITU-T G.8275.1] specifies that the actual Sync interval should not exceed two mean Sync intervals). When the next Sync message is received, this component of the phase error decreases to zero and then increases again until the next Sync message is received. The actual output transient over this time interval is a sawtooth. Since, as will be seen later, the time error for the first technique (i.e., rejecting the physical layer frequency input transient) is larger over most of the interval between 2.45 s and 14.984 s, we approximate this component of error by simply adding a constant 6.25 ns. Then, in (q) above, we approximate the error as 59.375 ns in the range 2.525-2.65 s, and 56.25 ns in the range 2.65-14.984 s.

For eSEC, between 2.4 s and when the signal is again traceable, at 15 s, the signal has a 10 ns/s frequency offset. This means that, since T-BC filtering is turned off, the T-BC phase error increases by $(10 \text{ ns/s})(0.125 \text{ s}) = 1.25 \text{ ns}$ over the interval between successive Sync messages (the inter-message interval is taken as 0.125 s because clause 6.2.8 of [ITU-T G.8275.1] specifies that the actual Sync interval should not exceed two mean Sync intervals). When the next Sync message is received, this component of the phase error decreases to zero and then increases again until the next Sync message is received. The actual output transient over this time interval is a sawtooth. Since, as will be seen later, the time error for the first technique (i.e., rejecting the enhanced physical layer frequency input transient) is larger over most of the interval between 2.4 s and 15 s (actually until 13.75 s), we approximate this component of error by simply adding a constant 1.25 ns. Then, in (q) above, we approximate the error as $20.625 \text{ ns} + 1.25 \text{ ns} = 21.875 \text{ ns}$ in the range 2.525-2.65 s, and $20 \text{ ns} + 1.25 \text{ ns} = 21.250 \text{ ns}$ in the range 2.65-15 s.

- s) When the physical layer frequency input is again traceable, at 14.984 s, the second 120 ns phase change over 16 ms interval (i.e., a 7.5 ppm phase ramp) appears on the T-BC output. This 120 ns phase error lasts for at most 2 Sync intervals (i.e., as indicated above, this is the longest interval that elapses before the next Sync message is received, because clause 6.2.8 of [ITU-T G.8275.1] specifies that the actual Sync interval should not exceed two mean Sync intervals) and then the error is immediately corrected because the T-BC filter is still turned off. The SSM is received between 180 ms and 500 ms later (i.e., in the range 15.164 s to 15.484 s) indicating the physical layer frequency input is again traceable and the T-BC filter is turned back on between 0 and 10 s later (i.e., in the range 15.164 s to 25.484 s). As was the case when the T-BC filter was turned off (see (q) above), there is still phase error due to the fact that the most recent Sync and Delay_Req messages, which were used for the most recent propagation delay measurement, occurred during the transient when the physical layer frequency clock reacquires its reference. In this case, the worst-case is when T_2 was taken just when the physical layer frequency input again became traceable, and T_3 was taken 0.125 s later. The phase error during this interval between the T_3 and T_2 timestamps is $[(0.016 \text{ s})(7500 \text{ ns/s}) + (0.125 \text{ s} - 0.016 \text{ s})(0 \text{ ns/s})]/2 = 60 \text{ ns}$. Then, on receipt of the next Sync message after the T-BC filter is turned on, the T-BC phase error decreases to

$56.25 \text{ ns} + 60 \text{ ns} = 116.25 \text{ ns}$. When the next Sync message is received 0.125 s after this, the T-BC phase error decreases to 50 ns.

Similarly, when the enhanced physical layer frequency input is again traceable, at 15 s, the second 10 ns phase sudden change appears on the T-BC output. Before the next Sync message is received (in the range of 15 s to 15.125 s), the time error would be added with the second 10 ns phase sudden change, i.e., $21.25 \text{ ns} + 10 \text{ ns} = 31.25 \text{ ns}$. Then the error is corrected down to 20 ns after next received Sync and Delay_Resp messages, which is maximum 125 ms later, because the T-BC filter is still turned off and the 10 ns/s ramp is no longer present on the input. The SSM is received between 180 ms and 500 ms later (i.e., in the range 15.180 s to 15.500 s) indicating the physical layer is again traceable and the T-BC filter is turned back on between 0 and 10 s later (i.e., in the range 15.180 s to 25.500 s). The T-BC phase error stays 20 ns after turning on the low pass filter.

II.2 Construction and simplification of the physical layer frequency input transient limit

The above assumptions (a) – (q) produce the T-BC output transients given in Tables II.1 and II.2. In addition to these assumptions, the physical layer frequency input signal was assumed to again be PRC-traceable after 15 s. The transients are continued to 50 s after the loss of traceability. The transients are shown in Figure II.1.

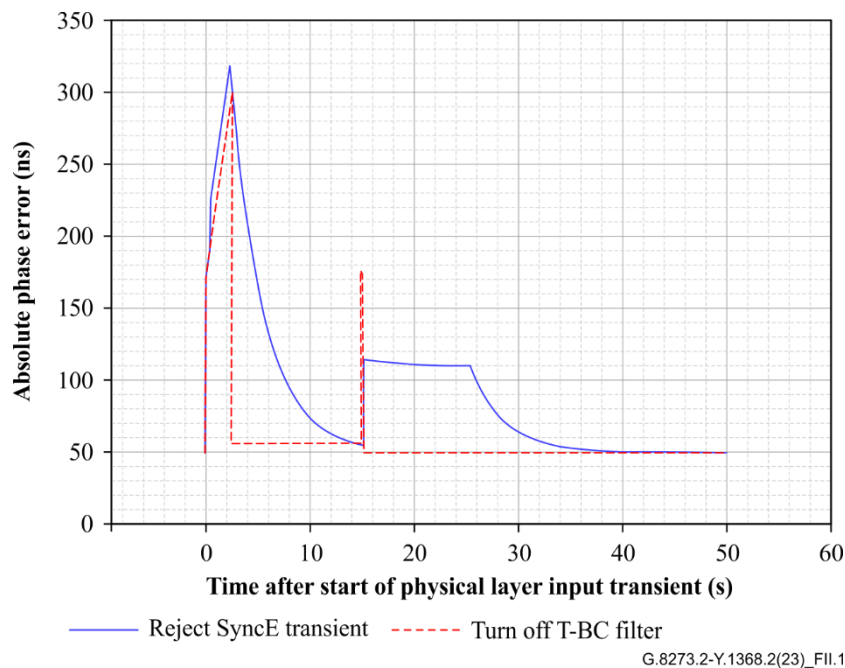

Figure II.1 – T-BC output phase error histories for each of the two techniques, assuming physical layer frequency input transient starts at time zero

**Table II.1 – T-BC output phase error history using scheme
(a) (rejection of physical layer frequency input transient)**

Time S after start of physical layer frequency input transient (s)	T-BC output absolute phase error (ns)
$0 \leq S < 0.016$	$50 + 7\,500 S$
$0.016 \leq S < 0.5$	$170 + 50 (S - 0.016)$
$0.5 \leq S < 2.4$	$224.2 + 50 (S - 0.5)$
$2.4 \leq S < 15.164$	$50 + 269.2 e^{-2\pi(0.05)(S - 2.4)}$
$15.164 \leq S \leq 25.484$	$110 + 269.2 e^{-2\pi(0.05)(S - 2.4)}$
$25.484 \leq S \leq 50$	$50 + 60.193 e^{-2\pi(0.05)(S - 25.484)}$

**Table II.2 – T-BC output phase error history using scheme
(b) (turning off T-BC filter during physical layer frequency input transient)**

Time S after start of physical layer frequency input transient (s)	T-BC output absolute phase error (ns)
$0 \leq S < 0.016$	$50 + 7\,500 S$
$0.016 \leq S < 2.525$	$170 + 50 (S - 0.016)$
$2.525 \leq S < 2.65$	59.375
$2.65 \leq S < 14.984$	56.25
$14.984 \leq S < 15.0$	$56.25 + 7\,500 (S - 14.984)$
$15.0 \leq S < 15.125$	176.25
$15.125 \leq S < 15.25$	116.25
$15.25 \leq S \leq 50$	50

Figure II.1 and Table II.2 show that the output transient for scheme (b) (turning off the T-BC filter during the transient) contains a very sharp, narrow peak between 14.984 s and 15.25 s, i.e., over a period of 0.266 s. This peak is due to the second phase jump of 120 ns beginning at 14.984 s and ending at 15 s. In a test, the test set would have to begin and end the phase jump at exactly these times, otherwise the actual peak would occur at slightly different times and the equipment might fail. It would be desirable to allow some margin for the test set; this can be done by allowing the phase jump to begin as early as 14.5 s and end as late as 15.5 s (i.e., allow the phase jump to occur at any time during a 1 s interval). If this is done, the mask for scheme (b) should be computed as the envelope of all possible output transients with the second phase jump occurring during this interval. The modified output mask for scheme (b) is shown in Figure II.2 and Table II.3.

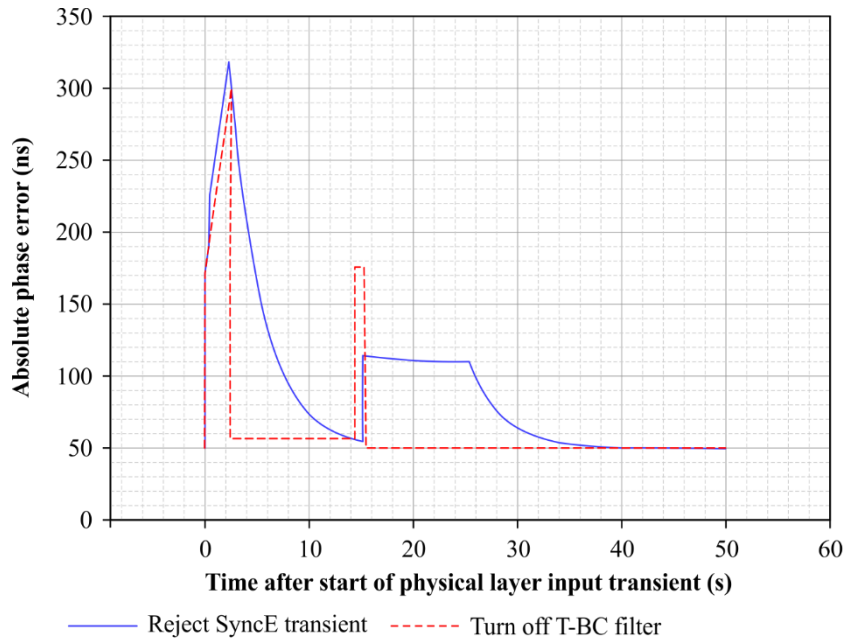

G.8273.2-Y.1368.2(23)_FII.2

Figure II.2 – T-BC output phase error histories for each of the two techniques, assuming physical layer frequency input transient starts at time zero, and allowing 1 s of margin for the time of second 120 ns phase jump for scheme (b)

Table II.3 – Modified T-BC output phase error history using scheme (b) (turning off T-BC filter during physical layer frequency input transient), allowing 1 s of margin for time of second 120 ns phase jump

Time S after start of physical layer frequency input transient (s)	T-BC output absolute phase error (ns)
$0 \leq S < 0.016$	$50 + 7\,500 S$
$0.016 \leq S < 2.525$	$170 + 50 (S - 0.016)$
$2.525 \leq S < 2.65$	59.375
$2.65 \leq S < 14.5$	56.25
$14.5 \leq S < 14.516$	$56.25 + 7\,500 (S - 14.5)$
$14.516 \leq S < 15.375$	176.25
$15.375 \leq S < 15.5$	116.25
$15.5 \leq S \leq 50$	50

Finally, note that the Figure II.2 and Table II.3 mask is still somewhat complex for observation intervals in the range 14.5-15.5 s. The mask can be simplified by allowing it to take on the maximum level in this range, i.e., 176.25 ns. The result is given in Figure II.3 and Table II.4.

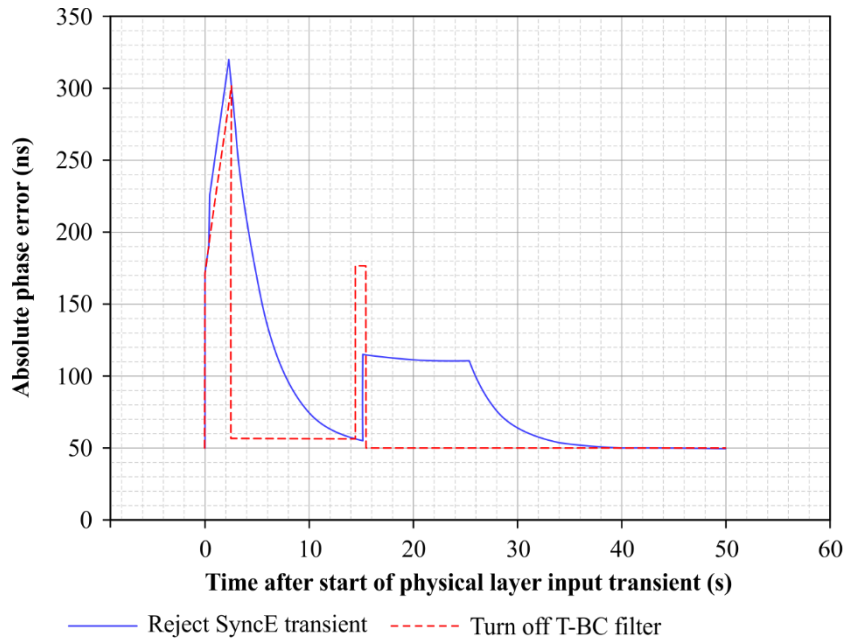

G.8273.2-Y.1368.2(23)_FII.3

Figure II.3 – T-BC output phase error histories for each of the two techniques, assuming physical layer frequency input transient starts at time zero, and allowing 1 s of margin for the time of second 120 ns phase jump for scheme (b)

Table II.4 – Modified T-BC output phase error history using scheme (b) (turning off T-BC filter during physical layer frequency input transient), allowing 1 s of margin for time of second 120 ns phase jump

Time S after start of physical layer frequency input transient (s)	T-BC output absolute phase error (ns)
$0 \leq S < 0.016$	$50 + 7\,500 S$
$0.016 \leq S < 2.525$	$170 + 50 (S - 0.016)$
$2.525 \leq S < 2.65$	59.375
$2.65 \leq S < 14.5$	56.25
$14.5 \leq S < 15.5$	176.25
$15.5 \leq S \leq 50$	50

II.3 T-BC output phase transient mask for the physical layer frequency network rearrangement case

The T-BC output phase transient mask for the physical layer frequency rearrangement case is taken as the upper envelope of the two output transients of Tables II.1 and II.4 and Figure II.3 above. This is given by the mask of Figure II.4 and Table II.5 below.

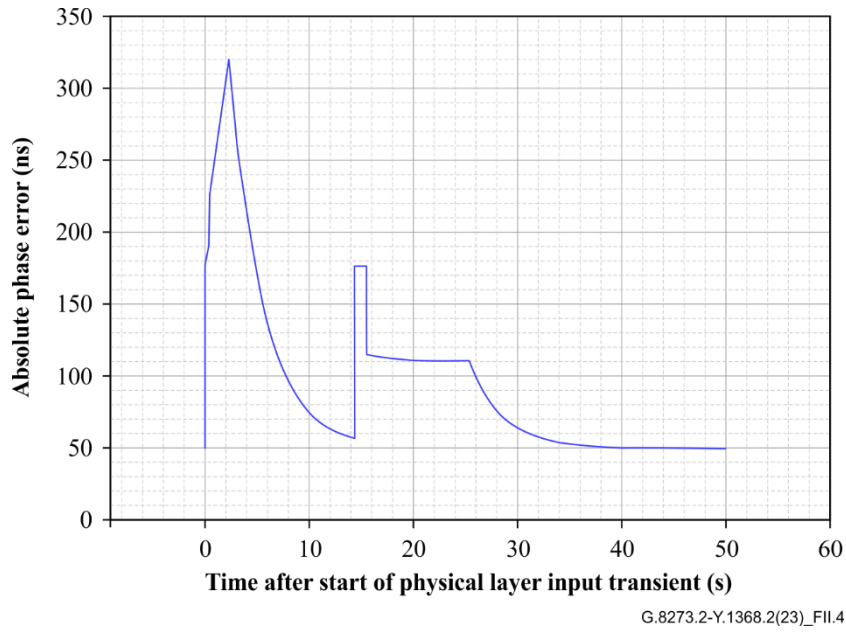

Figure II.4 – Upper envelope of masks of Figure II.3 and Table II.4

Table II.5 – Upper envelope of masks of Figure II.3 and Table II.4

Time S after start of physical layer frequency input transient (s)	T-BC output absolute phase error (ns)
$0 \leq S < 0.016$	$50 + 7\,500 S$
$0.016 \leq S < 0.5$	$170 + 50 (S - 0.016)$
$0.5 \leq S < 2.4$	$224.2 + 50 (S - 0.5)$
$2.4 \leq S < 14.3776$	$50 + 269.2 e^{-2\pi(0.05)(S - 2.4)}$
$14.3776 \leq S \leq 14.5$	56.25
$14.5 \leq S < 15.5$	176.25
$15.5 \leq S < 25.484$	$110 + 269.2 e^{-2\pi(0.05)(S - 2.4)}$
$25.484 \leq S \leq 50$	$50 + 60.193 e^{-2\pi(0.05)(S - 25.484)}$

Further simplifications are possible. First, in Figure II.4 and Table II.5, the limit of 56.25 ns for observation intervals between 14.3776 s and 14.5 s is of very short duration. The mask can be simplified by extending the limit of 176.25 ns, currently for observation intervals between 14.3776 s and 14.5 s, to the range 14.3776-14.5 s and rounding the lower end of the range to 14.25 s. The result is given by the mask of Figure II.5 and Table II.6 below.

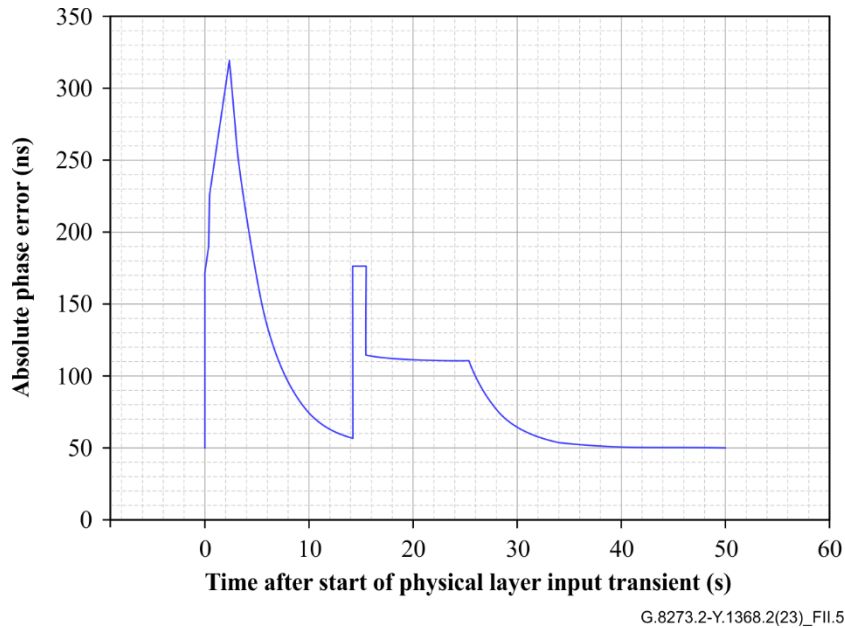

Figure II.5 – Upper envelope of masks of Figure II.3 and Table II.4 after applying simplifications in the range 14.25-14.5 s

Table II.6 – Upper envelope of masks of Figure II.3 and Table II.4 after applying simplifications in the range 14.25-14.5 s

Time S after start of physical layer frequency input transient (s)	T-BC output absolute phase error (ns)
$0 \leq S < 0.016$	$50 + 7\,500 S$
$0.016 \leq S < 0.5$	$170 + 50 (S - 0.016)$
$0.5 \leq S < 2.4$	$224.2 + 50 (S - 0.5)$
$2.4 \leq S < 14.25$	$50 + 269.2 e^{-2\pi(0.05)(S - 2.4)}$
$14.25 \leq S < 15.5$	176.25
$15.5 \leq S < 25.484$	$110 + 269.2 e^{-2\pi(0.05)(S - 2.4)}$
$25.484 \leq S \leq 50$	$50 + 60.193 e^{-2\pi(0.05)(S - 25.484)}$

Second, the portion of the mask in the third region, which extends from 0.5 s to 2.4 s, may be extended into the first two regions (0 to 0.5 s). This will increase the mask in the first two regions. However, note that the mask already increases rapidly during the first 0.5 s and that 170 ns of the increase occurs over the first 0.016 s. Third, values are rounded up to at most three significant figures. Fourth, the second to last region, which extends from 15.5 s to 25.484 s, is replaced by the maximum value of the mask in this region, i.e., 115 ns after the rounding up described above. This may be done because the total decay in the value of the mask in this region is less than 5 ns. The final result is given by the mask of Figure B.1 and Table B.1 of Annex B.

II.4 Construction and simplification of the enhanced physical layer frequency input transient limit

The above assumptions (a) – (q) produce the T-BC output transients given in Tables II.7 and II.8. In addition to these assumptions, the enhanced physical layer frequency input was assumed to again be PRC-traceable after 15 s. The transients are continued to 50 s after the loss of traceability. The transients are shown in Figure II.6.

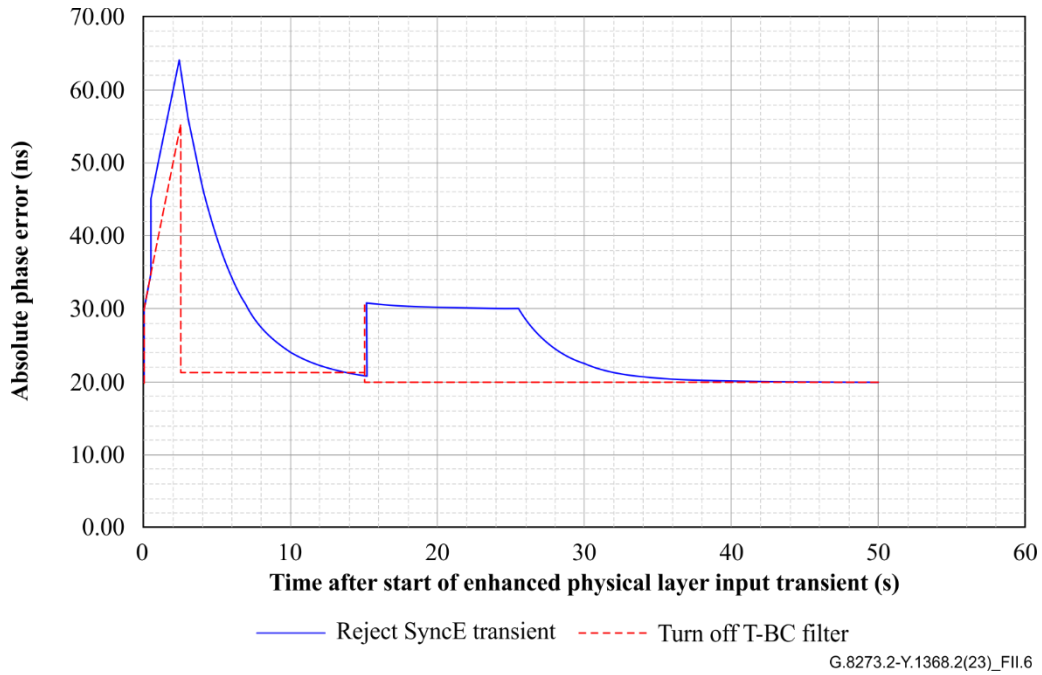

Figure II.6 – T-BC output phase error histories for each of the two techniques, assuming enhanced physical layer frequency input transient starts at time zero

Table II.7 – T-BC class C output phase error history using scheme (a) (rejection of enhanced physical layer frequency input transient)

Time S after start of enhanced physical layer frequency input transient(s)	T-BC output absolute phase error (ns)
$0 \leq S < 0.5$	$30 + 10 S$
$0.5 \leq S < 2.4$	$40 + 10 S$
$2.4 \leq S < 15.18$	$20 + 44 e^{-2\pi(0.05)(S-2.4)}$
$15.18 \leq S < 25.5$	$30 + 44 e^{-2\pi(0.05)(S-2.4)}$
$25.5 \leq S \leq 50$	$20 + 10 e^{-2\pi(0.05)(S-25.5)}$

Table II.8 – T-BC class C output phase error history using scheme (b) (turning off T-BC filter during enhanced physical layer frequency input transient)

Time S after start of enhanced physical layer frequency input transient (s)	T-BC output absolute phase error (ns)
$0 \leq S < 2.4$	$30 + 10 S$
$2.4 \leq S < 2.525$	20.625
$2.525 \leq S < 2.65$	21.875
$2.65 \leq S < 15$	21.25
$15.0 \leq S < 15.125$	31.25
$15.125 \leq S < 50$	20

Figure II.6 and Table II.8 show that the output transient for scheme (b) (turning off the T-BC filter during the transient) contains a very sharp, narrow peak between 15 s and 15.125 s, i.e., over a period of 0.125 s. This peak is due to the second phase jump of 10 ns beginning at 15 s. In a test, the test set would have to begin and end the phase jump at exactly these times, otherwise the actual peak would occur at slightly different times and the equipment might fail. It would be desirable to allow some

margin for the test set; this can be done by allowing the phase jump to begin as early as 14.5 s and end as late as 15.5 s (i.e., allow the phase jump to occur at any time during a 1 s interval). If this is done, the mask for scheme (b) should be computed as the envelope of all possible output transients with the second phase jump occurring during this interval. The modified output mask for scheme (b) is shown in Figure II.7 and Table II.9.

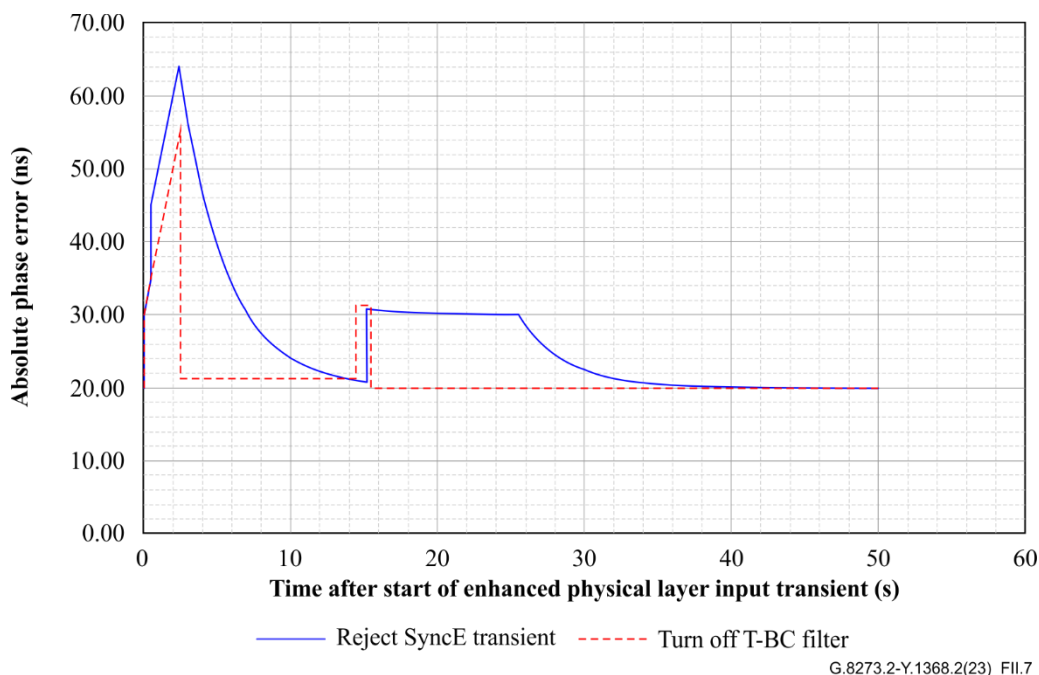

Figure II.7 – T-BC output phase error histories for each of the two techniques, assuming enhanced physical layer frequency input transient starts at time zero, and allowing 1 s of margin for the time of second phase jump for scheme (b)

Table II.9 – Modified T-BC output phase error history using scheme (b) (turning off T-BC filter during enhanced physical layer frequency input scheme (b), allowing 1 s of margin for time of second 10 ns phase jump)

Time S after start of enhanced physical layer frequency input transient (s)	T-BC output absolute phase error (ns)
$0 \leq S < 2.4$	$30 + 10 S$
$2.4 \leq S < 2.525$	20.625
$2.525 \leq S < 2.65$	21.625
$2.65 \leq S < 14.5$	21.25
$14.5 \leq S < 15.5$	31.25
$15.5 \leq S \leq 50$	20

II.5 T-BC output phase transient mask for the enhanced physical layer frequency network rearrangement case

The T-BC class C output phase transient mask for the enhanced physical layer frequency case is taken as the upper envelope of the two output transients of Tables II.7 and II.9.

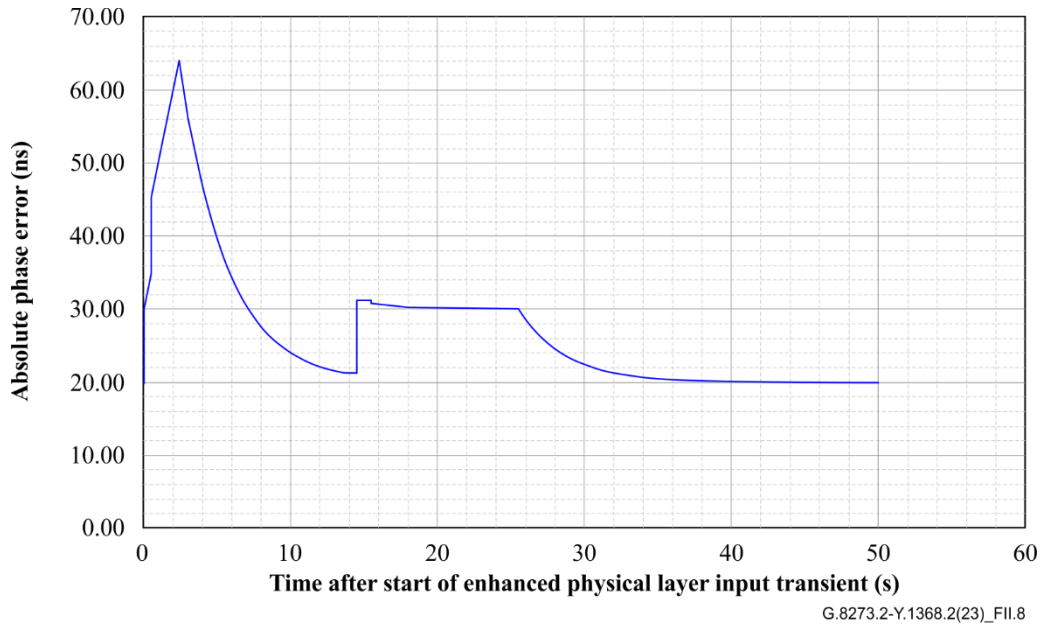

Figure II.8 – Upper envelope of masks of Figure II.7

Table II.10 – Upper envelope of masks of Table II.7 and Table II.9

Time S after start of enhanced physical layer frequency input transient (s)	T-BC output absolute phase error (ns)
$0 \leq S < 0.5$	$30 + 10 S$
$0.5 \leq S < 2.4$	$40 + 10 S$
$2.4 \leq S < 13.75$	$20 + 44 e^{-2\pi(0.05)(S - 2.4)}$
$13.75 \leq S < 14.5$	21.25
$14.5 \leq S < 15.5$	31.25
$15.5 \leq S < 25.5$	$30 + 44 e^{-2\pi(0.05)(S - 2.4)}$
$25.5 \leq S \leq 50$	$20 + 10 e^{-2\pi(0.05)(S - 25.5)}$

Further simplification is proposed in a similar way as done in clause II.3: the portion of the mask that extends from 0.5 s to 2.4 s, may be extended into the first regions (0 to 0.5 s). This will increase the mask in the first two regions. Also, values are rounded up to at most three significant figures. Finally, the centre regions, which extend from 15.5 s to 25.5 s, are replaced by the maximum value of the mask in this region, i.e., 31 ns after the rounding up described above. This may be done because the total decay in the value of the mask in this region is less than 5 ns. The final result is given by the mask of Figure II.9 (reused as Figure C.1) and Table II.11 (reused as Table C.1).

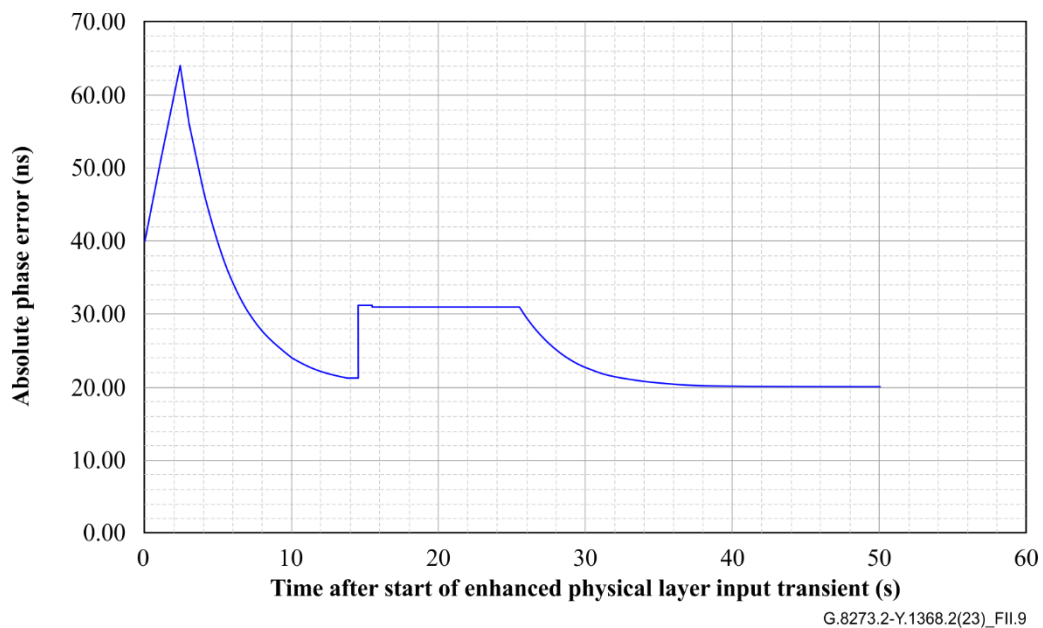

Figure II.9 – Final upper envelope

Table II.11 – Upper envelope of masks of Table II.10 after applying simplifications

Time S after start of enhanced physical layer frequency input transient (s)	T-BC output absolute phase error (ns)
$0 \leq S < 2.4$	$40 + 10 S$
$2.4 \leq S < 13.75$	$20 + 44 e^{-2\pi(0.05)(S - 2.4)}$
$13.75 \leq S < 14.5$	21.3
$14.5 \leq S < 15.5$	31.3
$15.5 \leq S < 25.5$	31
$25.5 \leq S \leq 50$	$20 + 11 e^{-2\pi(0.05)(S - 25.5)}$

Appendix III

Background to performance requirements of the T-BC/T-TSC

(This appendix does not form an integral part of this Recommendation.)

Annex A describes a detailed model of a telecom boundary clock and telecom synchronous clock. Figure III.1 is a simpler representation showing the timing signal flows between the main functional blocks during normal operation.

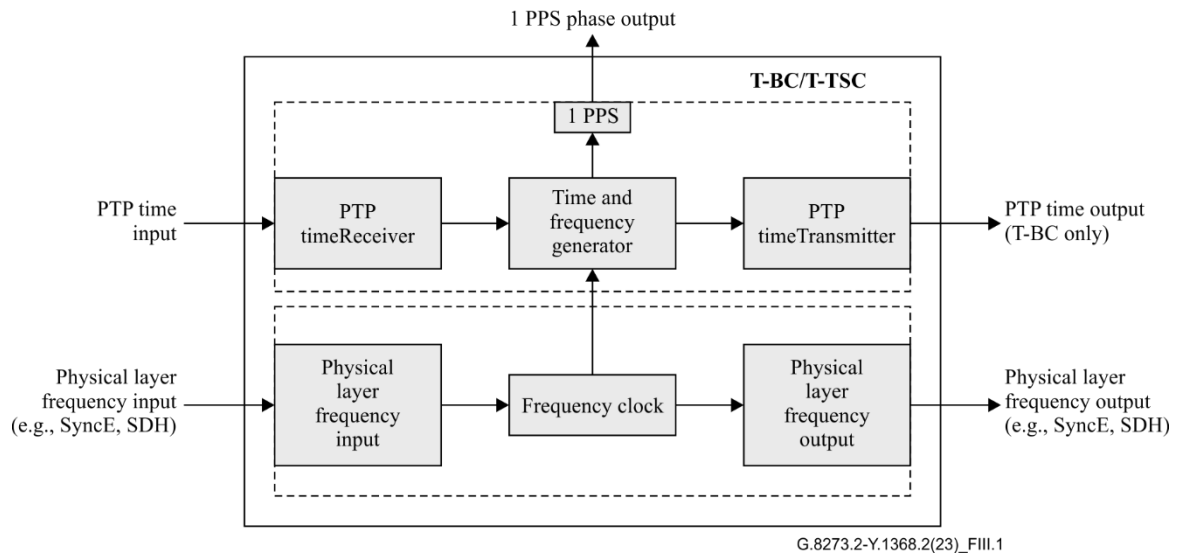

Figure III.1 – Model of T-BC/T-TSC showing signal flows in normal operation

NOTE – The term "PTP output" only applies to T-BC in this appendix.

From this diagram, it can be seen that there are basically two clocks in a T-BC/T-TSC, a frequency clock locked to the physical layer frequency input, and a time clock locked to the PTP input. The frequency clock refers to clocks defined in [ITU-T G.8262], [ITU-T G.813], and [ITU-T G.8262.1]. The two clocks are shown in Figure III.2:

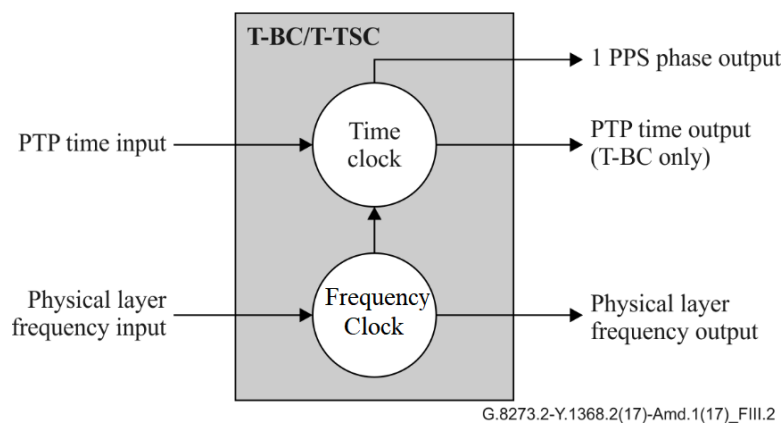

Figure III.2 – Simplified model of T-BC/T-TSC showing clocks

Since the 1 PPS output is a measurement point intended to reflect the performance of the time clock, it is expected that it should be broadly equivalent to the PTP output, aside from the different noise characteristics of the respective signal types.

Therefore, there are three primary timing flows in a T-BC/T-TSC:

- 1) PTP time input to PTP and 1 PPS time/phase outputs;
- 2) Physical layer frequency input to physical layer frequency output;
- 3) Physical layer frequency input to PTP and 1 PPS outputs.

III.1 Noise generation requirements

The noise generation of a clock is defined as the noise (normally phase wander) at the output of the clock, with a wander-free reference at the input of the clock.

The noise generation at the physical layer frequency output is affected only by the physical layer frequency input, and is defined by [ITU-T G.8262], [ITU-T G.813], and [ITU-T G.8262.1].

The PTP and 1 PPS signals are the output of the time clock within the T-BC/T-TSC. For these outputs noise basically means time error. This can be defined by three parameters:

- 1) cTE – the mean value of the time error function, measured over a long observation interval;
- 2) dTE – the variation of the time error function;
- 3) maximum time error ($\max|TE|$) – the maximum absolute value of the time error.

For a T-BC/T-TSC, the maximum noise generation is defined in terms of cTE and dTE. The $\max|TE|$ parameter is generally used for network limits.

There are two inputs that can affect the output of the Time Clock, the physical layer frequency input and the PTP input. Therefore, the noise generation at the PTP and 1 PPS outputs is defined as the noise present at the output with a time-error free time reference at the PTP input, and a wander-free frequency reference at the physical layer frequency input. This is shown in Figure III.3:

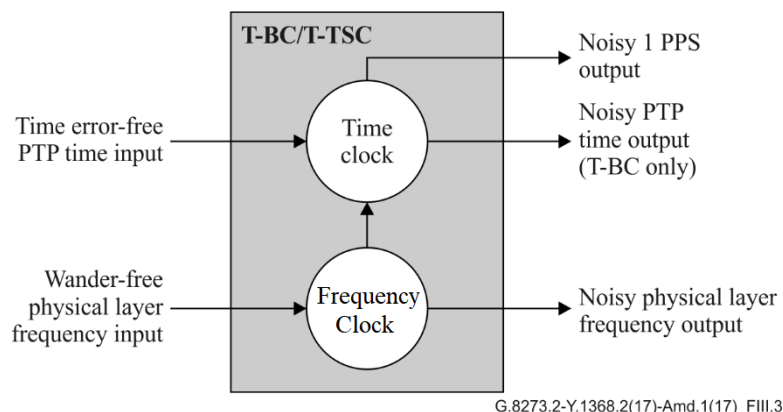

Figure III.3 – Noise generation of a T-BC/T-TSC

III.2 Noise tolerance

The noise tolerance of a T-BC/T-TSC is the maximum level of noise at the inputs of a T-BC/T-TSC that should be tolerated while continuing to work normally. In the real network, both inputs of a clock may be noisy at the same time, therefore the noise tolerance requirements are defined to apply simultaneously on both inputs.

For the PTP input, noise tolerance is defined in terms of the dTE of the input signal. cTE is not considered, since PTP is effectively "blind" to cTE; it cannot detect constant time error at its input without additional information (e.g., asymmetry measurements). The amount of dTE is based on network limit in [ITU-T G.8271.1].

For the physical layer frequency input, the maximum phase wander that should be tolerated is described in [ITU-T G.8262], [ITU-T G.813], and [ITU-T G.8262.1].

There are no output performance requirements on the output of the T-BC/T-TSC during a noise tolerance test. This is because the T-BC/T-TSC is a node within a chain. The noise accumulation through the chain is governed by the noise generation of the clock, and the network limits provide the overall limit on the performance of the chain. A clock is merely expected to work normally during a noise tolerance test, i.e., not switch references, generate any alarms, or go into holdover.

Noise tolerance is shown in Figure III.4:

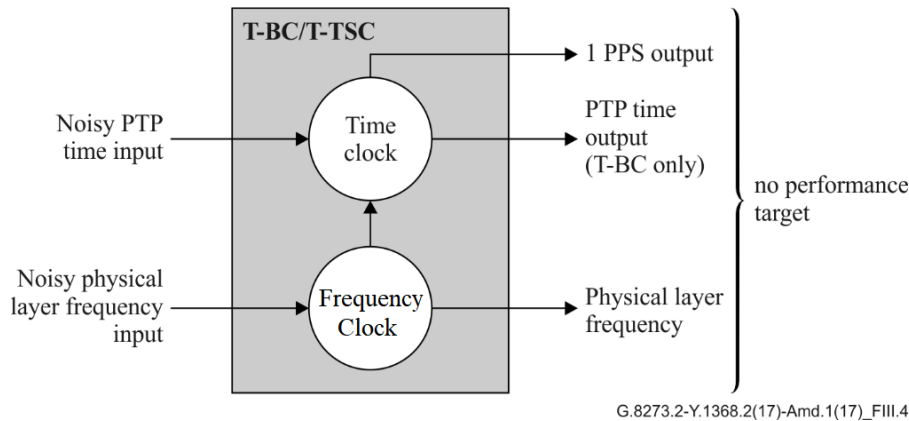

Figure III.4 – Noise tolerance of a T-BC/T-TSC

III.3 Noise transfer

The noise transfer of a clock describes how any noise present on the input of a clock is passed to the output of the clock. It is basically the transfer function of the clock, and is usually expressed in terms of bandwidth, since the clock acts a filter to the noise.

As discussed before, there are three primary signal flows through a T-BC/T-TSC, as shown in Figure III.5:

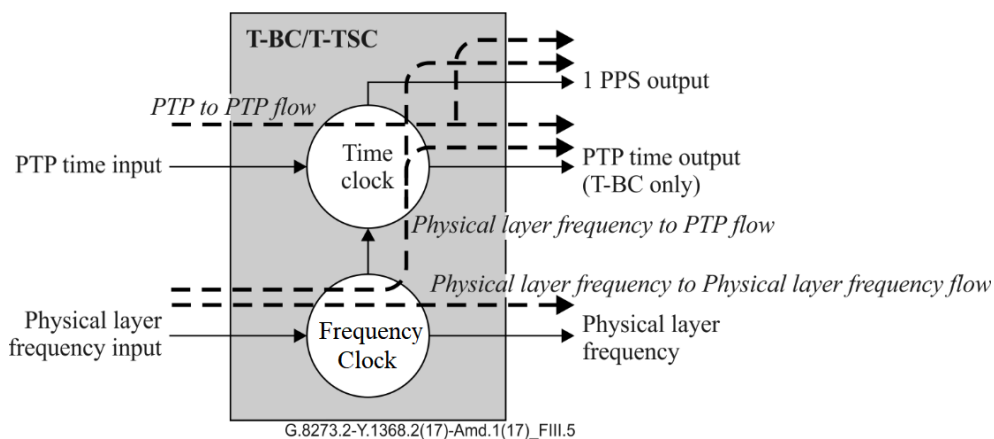

Figure III.5 – Signal flows through a T-BC/T-TSC

Each of these flows has a bandwidth associated with it. The PTP to PTP (and PTP to 1 PPS) bandwidth is explicitly defined in clause 7.3.1, as a low-pass filter with a maximum bandwidth of 0.1 Hz, and a minimum bandwidth of 0.05 Hz.

The physical layer to physical layer frequency bandwidth is defined in [ITU-T G.8262], [ITU-T G.813], and [ITU-T G.8262.1].

NOTE 1 – SEC (synchronous equipment clock) is a generic term representing the SDH equipment clock [ITU-T G.813], the Ethernet equipment clock (EEC) [ITU-T G.8262] and the OTN equipment clock (OEC) [ITU-T G.8262].

NOTE 2 – eSEC (enhanced synchronous equipment clock) is a generic term representing the enhanced Ethernet equipment clock (eEEC) [ITU-T G.8262.1] and the enhanced OTN equipment clock (eOEC) [ITU-T G.8262.1].

For the physical layer frequency to PTP (and physical layer frequency to 1 PPS) path, the physical layer frequency signal is first low-pass filtered by the SEC or eSEC, then high-pass filtered by the time clock. This is because the time clock acts as a low-pass filter to its time input, but as a high-pass filter to its frequency input. This is a natural consequence of how the clock functions – basically it follows the time input at low frequencies, to stay locked to the time reference, but follows the frequency input at high frequencies (e.g., in between PTP packets, the frequency input provides the "ticking" to maintain the time output).

Therefore, the cumulative effect is a band-pass function, with the lower cutoff at 0.05-0.1 Hz, and the upper cutoff at 1-10 Hz. Table III.1 summarizes the transfer functions, while Figure III.6 shows generalized schematics of the transfer functions.

Table III.1 – Transfer functions applicable to a T-BC/T-TSC

Input/output on the T-BC/T-TSC	Transfer function
PTP input to PTP output PTP input to 1 PPS output	0.05-0.1 Hz low-pass filter
Physical layer frequency input to physical layer frequency output ([ITU-T G.8262], [ITU-T G.813])	1-10 Hz low-pass filter
Physical layer frequency input to physical layer frequency output ([ITU-T G.8262.1])	1-3 Hz low-pass filter
Physical layer frequency input ([ITU-T G.8262], [ITU-T G.813]) to PTP output Physical layer frequency input ([ITU-T G.8262], [ITU-T G.813]) to 1 PPS output	[0.05-0.1; 1-10] Hz band-pass filter (Note)
Physical layer frequency input ([ITU-T G.8262.1]) to PTP output Physical layer frequency input ([ITU-T G.8262.1]) to 1 PPS output	[0.05-0.1; 1-3] Hz band-pass filter (Note)
NOTE – The band-pass filter description of the system behaviour from physical layer input to PTP/1_PPS output is representative of the expected behaviour. See Notes in clause 7.3.2, clause C.2.3.2, and clause D.2.3.2.	

- a) PTP to PTP (or 1 PPS) transfer function schematic.
- b) Physical layer frequency to physical layer frequency transfer function schematic.
- c) Physical layer frequency to PTP (or 1 PPS) transfer function schematic.

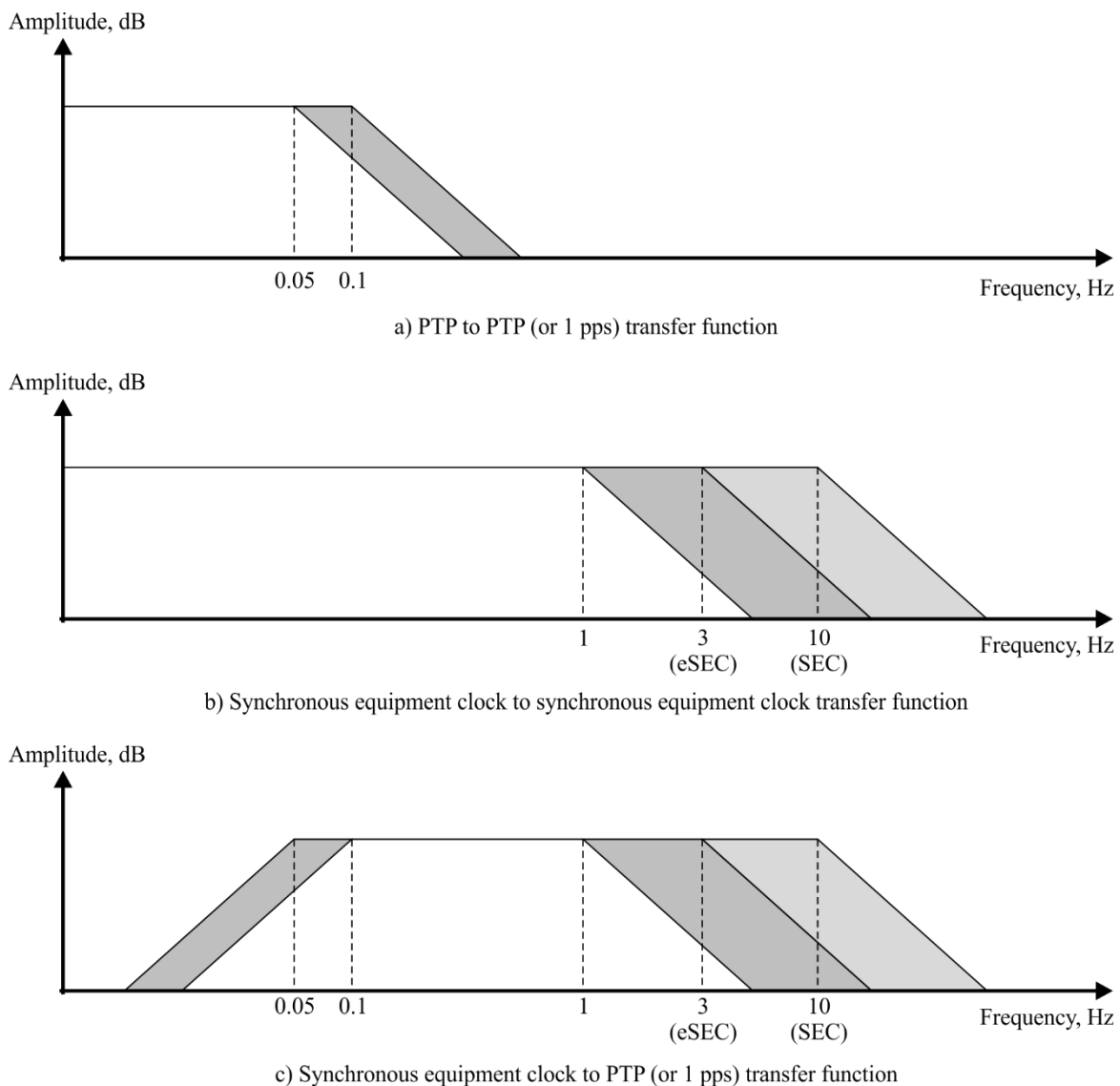

G.8273.2-Y.1368.2(19)_FIII.6

Figure III.6 – Generalized transfer function schematics of a T-BC/T-TSC

It should be noted that the diagrams in Figure III.6 are generalized schematics. The actual transfer function will be more rounded, and include the gain peaking defined in clause 7.3. In particular, the band-pass filter may not contain a flat area due to the closeness of the low-pass and high-pass corner frequencies.

III.4 Holdover

There are two types of holdover available in a T-BC/T-TSC. The first is where the T-BC/T-TSC loses its PTP time reference, but not the physical layer frequency reference, as shown in Figure III.7. In this case, the stable frequency reference is used to keep the time output "ticking" at approximately the correct rate. Since the long-term frequency of the physical layer frequency is traceable to a PRC, this is likely to maintain the correct time over a reasonable period of time.

The performance requirements to be met in this physical layer frequency-assisted holdover mode are not defined at present, and are for further study.

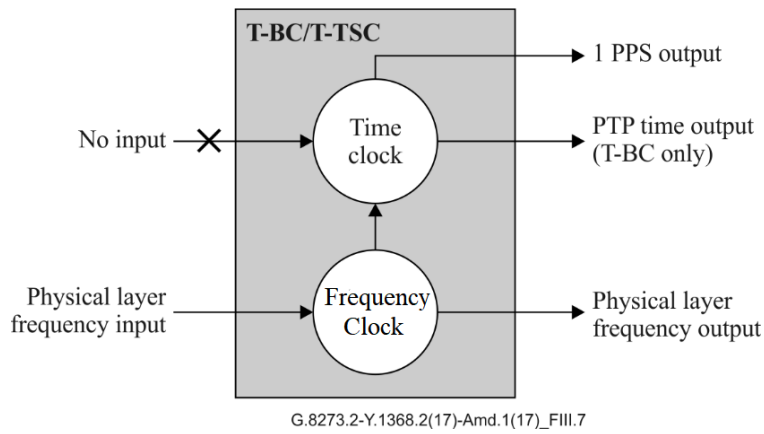

Figure III.7 – Physical layer frequency-assisted holdover

The second type is where both inputs are lost simultaneously, as shown in Figure III.8. The time output is then maintained using the local oscillator, but this is not expected to maintain accurate time for more than a few seconds, due to the drift rate of the oscillator. The performance requirements to meet in unassisted holdover are for further study.

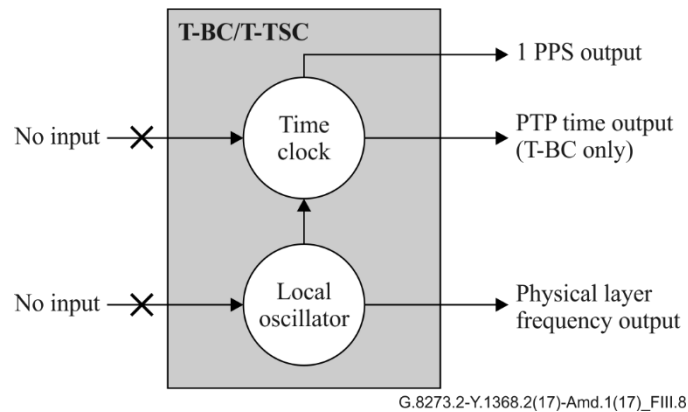

Figure III.8 – Unassisted holdover

Appendix IV

Consideration on T-TSC embedded in end applications

(This appendix does not form an integral part of this Recommendation.)

A time synchronization deployment is comprised of many network clocks such as primary reference time clocks (PRTC), T-GM, T-BC, T-TSC and end application time clocks. Two time synchronization deployment cases are shown in Figure 7-1 of [ITU-T G.8271.1]. In those deployment cases there is an 'end application time clock' that is shown as providing the output clock at interface D. The requirements of these end application time clocks and the performance at interface D is outside the scope of this Recommendation.

When the T-TSC is embedded inside the end application, as shown in deployment case 1 of Figure 7-1 of [ITU-T G.8271.1] the combination of the T-TSC and the end application time clock is implementation specific, where the combined performance may not behave as a stand-alone T-TSC described in this Recommendation. The T-TSC output interfaces may not be available external to the equipment for measurement.

In many end applications there is a need to have coherent frequency and time synchronization and/or to generate coherent frequency and time outputs. In such cases, it is important to properly design the end application time clock to implement the coherency.

Appendix V

Performance estimation for cascaded media converters acting as T-BCs and for T-BC chains

(This appendix does not form an integral part of this Recommendation.)

[ITU-T G.8273] describes the "back-to-back" testing of devices such as media converters, where the connecting interface may not be Ethernet and hence a suitable tester may not be available. This appendix discusses how to estimate the budget to use for back-to-back testing of such devices, where each device is allocated the budget equivalent to a single T-BC. A pair of such devices is modelled here as a pair of T-BCs, so the analysis can just as well apply to a pair of cascaded T-BCs and can be extended to a longer chain of cascaded T-BCs.

NOTE 1 – The analysis in this appendix is based on T-BCs of the same class, i.e., a chain containing solely class A, solely class B, or solely class C. Similar analysis can be applied to class D; this is for further study. A T-BC chain with mixed T-BC classes may require different analysis and is for further study. Also, the performance of cascaded clocks may depend on the specific media interconnecting the clocks.

NOTE 2 – Appendix IV.3 of [ITU-T G.8271.1] gives more details on the accumulation of time error in a chain of clocks.

V.1 Noise generation

The budget for the noise generation of a pair of cascaded T-BCs can be estimated as follows:

1) Constant time error limit (cTE)

cTE accumulates linearly in a chain of devices. For example, if each device has a cTE of 50 ns, the total cTE after two devices will be 100 ns.

2) Dynamic time error limit – low pass filtered (dTE_L)

dTE_L accumulates as noise power.

The accumulation of maximum time interval error (MTIE) of dTE_L is approximately the square root of the sum of squares of MTIE of the individual dTE_L components. For example, if each device has a dTE_L whose MTIE is 40 ns, the MTIE of the total dTE_L after N devices is $\sqrt{N} \cdot 40$ ns; for $N = 2$, this is:

$$\sqrt{40^2 + 40^2} \text{ ns} = \sqrt{2 \cdot 40^2} \text{ ns} = \sqrt{2} \cdot 40 \text{ ns} = 57 \text{ ns}$$

For the purposes of this estimation, the value is rounded up to 60 ns for classes A and B. For class C, it is 15 ns, as MTIE of dTE_L for the single T-BC is 10 ns rather than 40 ns.

TDEV of dTE_L accumulates, like MTIE of dTE_L, as the square root of the sum of the squares of TDEV of the individual dTE_L components. For example, if each device has a dTE_L with TDEV of 4 ns, the TDEV of the total dTE_L after two devices is:

$$\sqrt{4^2 + 4^2} \text{ ns} = \sqrt{2 \cdot 4^2} \text{ ns} = \sqrt{2} \cdot 4 \text{ ns} = 5.7 \text{ ns}$$

For the purposes of this estimation, the value is rounded up to 6 ns for classes A and B. For class C it is 3 ns, as TDEV of dTE_L, for the single T-BC is 2 ns rather than 4 ns.

NOTE – MTIE and TDEV are functions of the observation interval τ . In the examples of this section, MTIE and TDEV are constant, i.e., each can take on only a single value, over the respective ranges of observation interval of interest. Given this, the explicit indication of the dependence of MTIE and TDEV on τ can be omitted. If MTIE or TDEV vary with τ , the value at the desired observation interval should be used.

3) Dynamic time error limit – high pass filtered (dTE_H)

dTE_H from the first device is mostly removed by filtering in the second device. Therefore, the dTE_H of the combination is mainly due to the second device. For example, if each device

has a dTE_H whose peak-to-peak value is 70 ns, the peak-to-peak value of the total dTE_H after two devices still is 70 ns.

4) Maximum absolute time error limit – unfiltered max|TE|

The maximum absolute time error (max|TE|) of the T-BC is the maximum of the absolute value of the total time error, including all components, i.e., cTE, dTE_L, and dTE_H.

In calculating max|TE|, the symmetry of dTE_H should be considered. dTE_H is the result of passing dTE through a high-pass measurement filter. The high-pass filter removes any zero-frequency component, i.e., the time average, of dTE, which means that the time average of dTE_H is zero. However, in general dTE_H need not be symmetric, i.e., the peak (maximum) and trough (minimum) values of dTE_H need not have the same absolute value. In the symmetric case, the trough value is the negative of the peak value, and the peak-to-peak value is equal to twice the peak value. In this case, one-half the peak-to-peak value contributes to max|TE|. The other extreme is the completely asymmetric case, where the peak value is equal to the peak-to-peak value and the C is zero. In this case, the full peak-to-peak value contributes to max|TE|. The general case is somewhere between these two extremes.

The following two equations, denoted Method 1 and Method 2, show how max|TE| is calculated under the assumptions that dTE_H is completely asymmetric and dTE_H is symmetric, respectively. These equations follow Case 1 of Appendix IV of [ITU-T G.8271.1], which assumes that dTE_L is symmetric. The equations are based on Eq. (IV-13) of [ITU-T G.8271.1].

Method 1 (dTE_H is assumed to be completely asymmetric, and the peak-to-peak value is used).

$$\max|TE| = 2 \cdot cTE + \sqrt{2(0.5 \cdot dTE_L MTIE)^2 + dTE_H^2}$$

Method 2 (dTE_H is assumed to be symmetric, and one-half of the peak-to-peak value is used).

$$\max|TE| = 2 \cdot cTE + \sqrt{2(0.5 \cdot dTE_L MTIE)^2 + (0.5 \cdot dTE_H)^2}$$

The value of max|TE| in Table V.1 is the average of the values computed using Methods 1 and 2.

Table V.1 summarizes noise generation estimation for a pair of media converters based on the classes A, B, and C T-BC noise generation specifications. The values in Table V.1 are computed as described in points 1-4 above.

Table V.1 – Noise generation estimation for a pair of media converters

	Based on class A T-BC		Based on class B T-BC		Based on class C T-BC	
	Single T-BC	Pair of media converters	Single T-BC	Pair of media converters	Single T-BC	Pair of media converters
cTE (ns)	±50	±100	±20	±40	±10	±20
dTE _L MTIE (ns)	40	60	40	60	10	15
dTE _L TDEV (ns)	4	6	4	6	2	3
dTE _H (peak-to-peak, ns)	70	70	70	70	30	30
max TE (ns)	100	160	70	100	30	45

NOTE 1 – The values for a single class A, class B, and class C T-BC are defined in clause 7.1.

The above methodology can be extended to chains exceeding a pair of T-BCs. Consider N as the number of T-BCs:

- 1) For cTE, since the accumulation is additive, the value for the chain is the cTE for a single device multiplied by N. For five class C T-BCs this is $5 \cdot 10 = 50$ ns.
- 2) For quantities such as dTE_L MTIE and dTE_L TDEV, which have a square root of sum of squares accumulation, if the respective value for a single T-BC is x , the calculation is:

$$\sqrt{N \cdot x^2}$$

As an example, for the case of five class C T-BCs (with a dTE_L TDEV value of 2 ns each), the dTE_L TDEV for the five T-BCs is:

$$\sqrt{5 \cdot 2^2} \text{ ns} = \sqrt{20} \text{ ns} = 4.47 \text{ ns}$$

V.2 Noise tolerance

This clause applies to the cases of two cascaded T-BCs.

For noise tolerance, the input stimulus should be the same as defined in clause 7.2, with none of the cascaded clocks raising alarms, switching references or going into holdover.

V.3 Noise transfer

This clause applies to the cases of two cascaded T-BCs.

The noise transfer performance estimation for back-to-back T-BC is as follows:

The noise PTP-to-PTP and PTP-to-1 PPS transfer of the output of the cascaded media converter equipment clocks would have:

- A maximum gain of 0.2 dB;
- A maximum bandwidth of 0.1 Hz;
- A minimum gain of -6 dB for frequencies less than or equal to 0.05 Hz.

NOTE 1 – The minimum bandwidth specified for one T-BC is 0.05 Hz. If two clocks whose 3 dB bandwidths are 0.05 Hz are cascaded, the overall gain of the cascaded clocks taken together is -6 dB for frequencies less than or equal to 0.05 Hz. The 3 dB bandwidth of the cascaded clocks taken together is less than 0.05 Hz.

NOTE 2 – This clause does not add or modify requirements contained in the normative sections of this Recommendation.

NOTE 3 – The noise transfer test of one single media converter equipment clock could be done in isolation via its other interfaces, i.e., 2 048 kHz, 2 048 kbit/s or Ethernet.

V.4 Transient response and holdover performance

This clause applies to the cases of two cascaded T-BCs.

The transient response and holdover performance of pair of cascaded clocks is for further study.

For the holdover performance with physical layer frequency assistance (as defined in clause 7.4.2.1), the performance will depend on whether the physical layer frequency signal is still available if the technology-dependent interface fails.

Appendix VI

Choice of frequencies for measuring noise transfer

(This appendix does not form an integral part of this Recommendation.)

NOTE – This appendix is valid for T-BCs and T-TSCs classes A, B and C.

Note 1 in clause 7.3 provides some guidelines on the choice of frequencies used to measure the noise transfer of a T-BC. These guidelines are intended to ensure that the measured results properly reflect the response of the T-BC, and are not compromised by the presence of sub-Nyquist artefacts.

Sub-Nyquist artefacts are described in the paper by Isaac Amidror [b-Amidror]. This paper shows that where a tone frequency is sampled at a closely related frequency, a "sub-Nyquist artefact" frequency exists at a frequency ε , where:

$$f_t = \frac{m}{n} \cdot f_s + \varepsilon$$

where:

f_t = tone frequency

f_s = sampling frequency

m, n are small integers

ε is a small frequency difference, and can be positive or negative.

This can be seen in Figure VI.1. Here, the sampling frequency $f_s = 1$ Hz, and the tone frequency $f_t = 0.495$ Hz, giving $m = 1$, $n = 2$, and $\varepsilon = -0.005$ Hz:

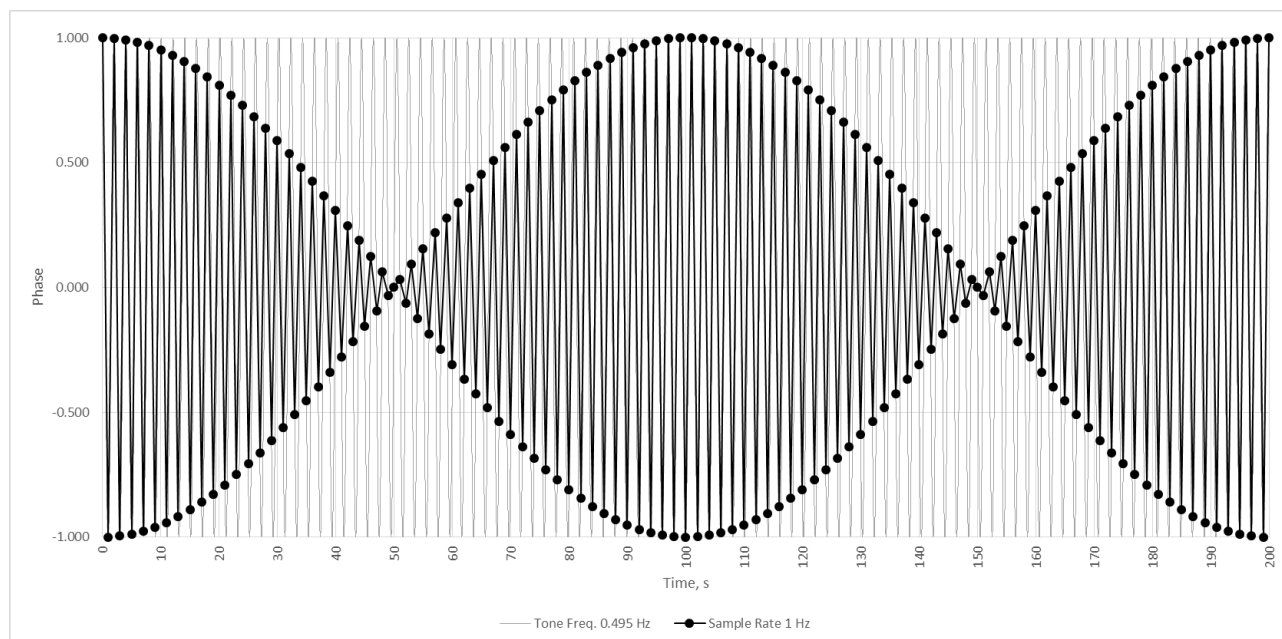

Figure VI.1 – Sub-Nyquist artefact for $m = 1$, $n = 2$, $\varepsilon = -0.005$ Hz

VI.1 Envelope repeat frequency

In Figure VI.1 it can be seen that while the artefact itself follows a frequency of 0.005 Hz (period of 200 s), there is an envelope pattern that repeats at 0.01 Hz (period of 100 s). In fact, this envelope pattern repeats at a frequency of:

$$E = |n \cdot \varepsilon|$$

Figure VI.2 shows $m = 1$, $n = 4$ and $\varepsilon = -0.005$ Hz, giving a tone frequency of 0.245 Hz. It can be seen that this time the envelope repeats at a frequency of 0.02 Hz:¹

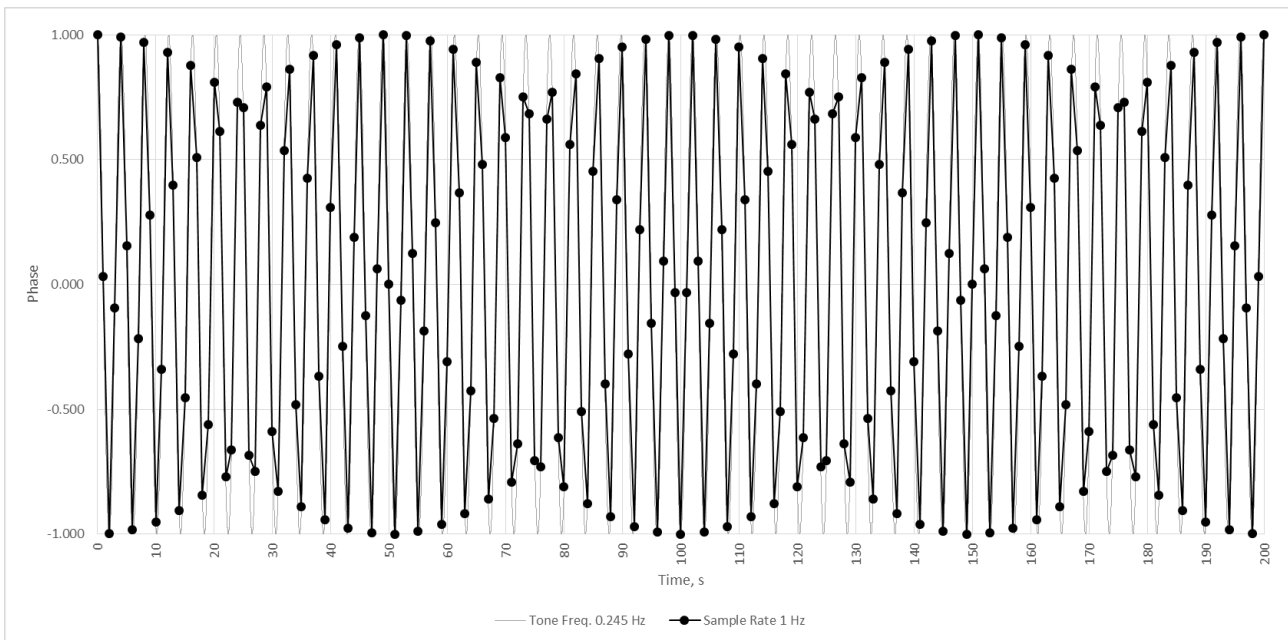

Figure VI.2 – Sub-Nyquist artefact for $m = 1$, $n = 4$, $\varepsilon = 0.005$ Hz

Figure VI.3 shows $m = 3$, $n = 4$ and $\varepsilon = -0.005$ Hz. Again, the envelope repeats at 0.02 Hz ($n * \varepsilon$), but the tone frequency is now 0.745 Hz because of the different value of m .

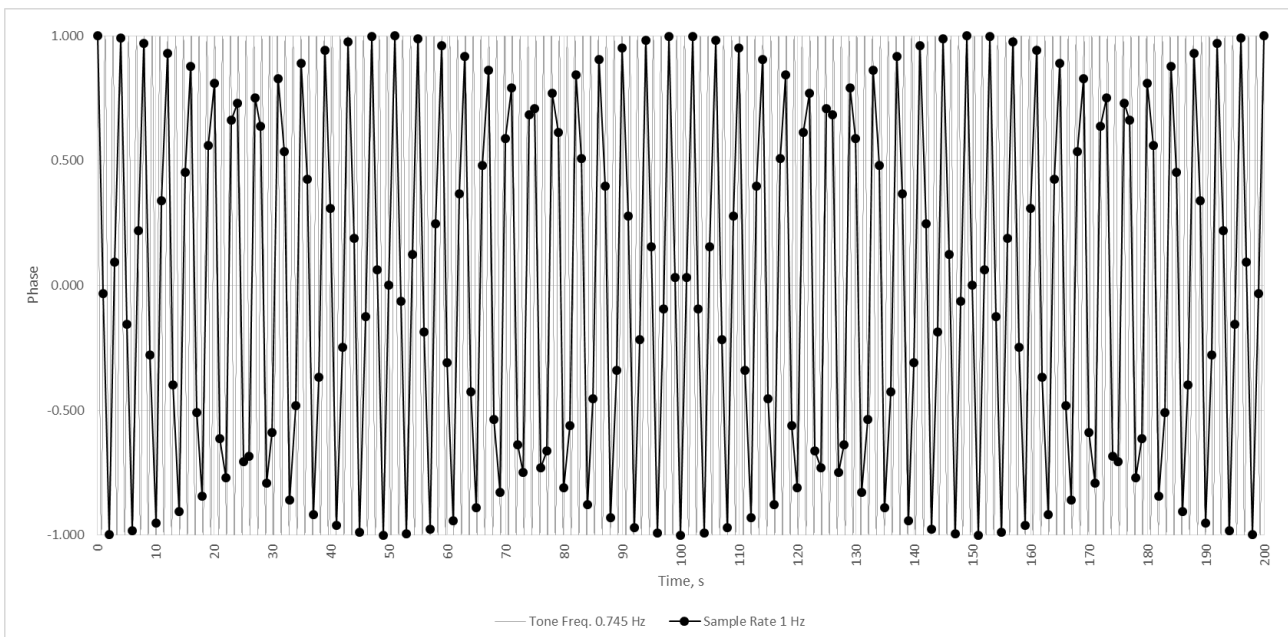

Figure VI.3 – Sub-Nyquist artefact for $m = 3$, $n = 4$, $\varepsilon = -0.005$ Hz

¹ Some literature (e.g., the Amidror paper) refer to the pattern as consisting of several interlaced envelopes at the artefact frequency, ε . In this document, the envelope repeat period refers to the period between crests of the overall envelope pattern.

When measuring noise transfer, it is the peak-to-peak magnitude of the output response that is measured. Therefore, the frequency of the envelope repeat should be high enough to give sufficient repeats of the envelope in a reasonable measurement period. Since this is related to the artefact frequency (ϵ), it can be controlled by setting the artefact frequency appropriately. It should be noted that where n is large, the envelope repeat frequency may approach or even exceed the tone frequency. In these cases, it loses its meaning.

VI.2 Choice of artefact frequency

Care should be taken that the artefact frequency is chosen correctly. For example, in Figure VI.4, $m = 1$, $n = 2$, and $\epsilon = 0.125$ Hz. In this case, the envelope never quite gets to $+1$ or -1 at its peak values, resulting in about a 0.7 dB loss in amplitude.

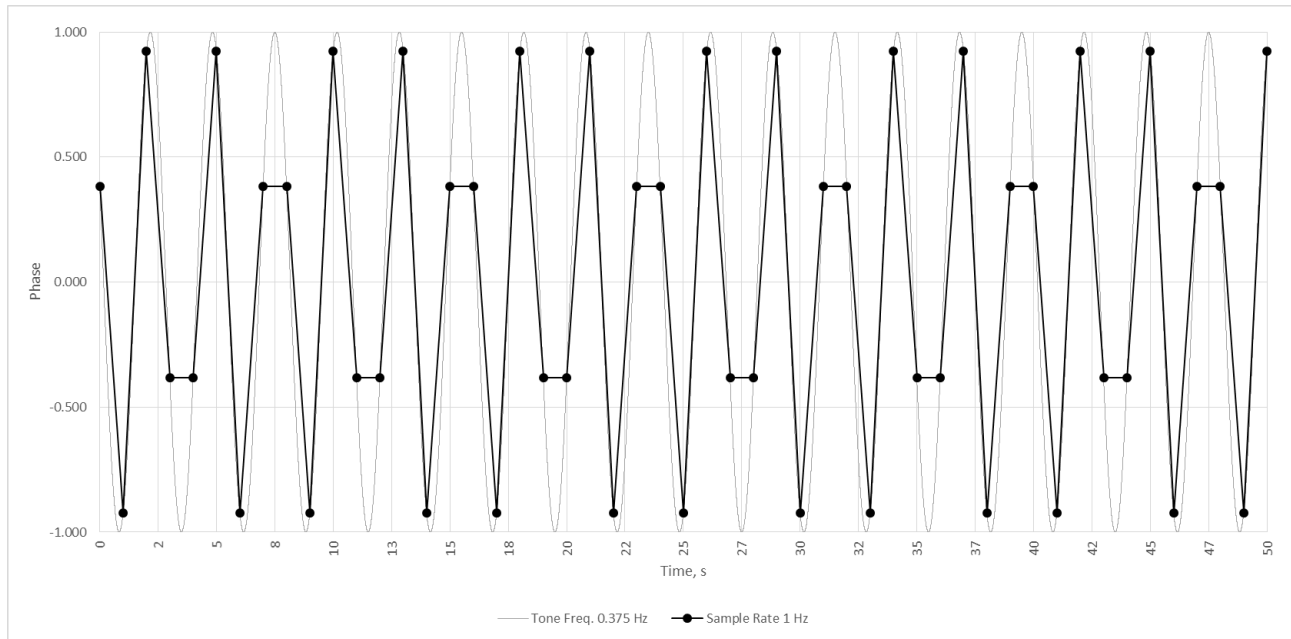

Figure VI.4 – Sub-Nyquist artefact for $m = 1$, $n = 2$, $\epsilon = 0.125$ Hz

This is because the artefact frequency is both too high relative to the sample rate (i.e., there are not enough samples in each artefact period), and also it is an integer divisor of the sampling rate (1/8), therefore every 16th sample occurs at the same phase of the artefact frequency.

Therefore, the artefact frequency should be chosen against the following criteria:

- low frequency relative to both the sampling rate and tone frequency, to ensure sufficient points in each period;
- not close to an integer divisor of the sampling rate;
- high enough that the envelope repeat period is reasonable, ensuring measurement times are not excessively long.

VI.3 Possible frequencies

Table VI.1 shows tone frequencies that could potentially be used to measure the transfer response of a T-BC. These tone frequencies assume a PTP event message rate (Sync and Delay_req) of precisely 16.000 Hz. When the message rate is not precisely 16.000 Hz (the allowed range in the standard is $16 \text{ Hz} \pm 30\%$ for Sync and $16 \text{ Hz} + 0\%$ to -30% for Delay_req), this will generate sub-Nyquist artefacts at different frequencies and therefore will require different input tone frequencies than shown in the table.

These tone frequencies have been chosen according to the following criteria:

- 1) The tone frequencies are separated by approximately a factor of two, giving both good coverage of the frequency space, and equal spacing on a logarithmic axis.
- 2) The artefact frequency ε is fixed at 0.015 times the nominal tone frequency, to ensure enough points in each artefact period.
- 3) The envelope frequency is fixed at 0.015 Hz at the 1 PPS output, to permit reasonable measurement times (200 s per frequency, apart from the lowest frequencies which require longer measurement times).
- 4) The range of frequencies extends more than a decade either side of the specified T-BC filter bandwidth range of 0.05 to 0.1 Hz.
- 5) For frequencies 0.03125 Hz and below, the n value is greater than 16 even for the 1 PPS output. Therefore, there is no requirement to adjust the nominal tone frequency.
- 6) The same frequencies may be used to measure at both the PTP and 1 PPS outputs, to allow the tests to be conducted concurrently.

Table VI.1 – Possible tone frequencies for measuring frequency response of T-BCs

Nominal frequency, Hz	Tone frequency, Hz	16 pkts/s PTP			1 PPS output		
		m, n	epsilon, Hz	envelope, Hz	m, n	epsilon, Hz	envelope, Hz
0.00390625	0.00390625	No requirement to adjust the nominal frequency ($n \geq 32$)			No requirement to adjust the nominal frequency ($n \geq 32$)		
0.0078125	0.0078125						
0.015625	0.015625						
0.03125	0.03125						
0.0625	0.0615625	1, 256	-0.0009375	n/a ($>0.5*f_i$)	1, 16	-0.0009375	-0.015
0.125	0.123125	1, 128	-0.001875		1, 8	-0.001875	-0.015
0.25	0.24625	1, 64	-0.00375		1, 4	-0.00375	-0.015
0.5	0.4925	1, 32	-0.0075	-0.24	1, 2	-0.0075	-0.015
1	0.985	1, 16	-0.015	-0.24	1, 1	-0.015	Aliased component at 0.015 Hz
2	1.985	1, 8	-0.015	-0.12	2, 1	-0.015	
4	3.985	1, 4	-0.015	-0.06	4, 1	-0.015	
8	7.985	1, 2	-0.015	-0.03	8, 1	-0.015	

VI.4 Expected filter response (PTP to PTP and PTP to 1 PPS noise transfer)

The frequency response of the clock is not completely defined in clause 7.3.1. In order to evaluate the performance of the clock, the following five criteria are recommended:

- 1) The minimum implementation should have a gain reduction of at least that of a first-order, -20 dB/decade filter for frequencies above the maximum permitted bandwidth.
- 2) The maximum permitted gain peaking for frequencies below the maximum permitted bandwidth should be 0.1 dB.
- 3) The maximum attenuation for frequencies below the minimum permitted bandwidth should be 3 dB.

- 4) The attenuation at the maximum permitted bandwidth point should be at least 3 dB.
- 5) The maximum attenuation at frequencies above the minimum permitted bandwidth should be undefined.

The maximum and minimum acceptable gain at different frequencies is given in Tables VI.2 and VI.3, and is shown in Figure VI.5. Any measured response within the grey zone is considered acceptable. This is before taking into account any noise generation of the clock. The expected response is similar for class A, B and C clocks.

Although Figure VI.5 could be interpreted as having a 'range' of acceptable frequency responses in the passband, once the filter response of the implementation has been established, it is expected that the frequency response will not change over time.

Table VI.2 – Maximum gain for PTP to PTP filter implementation (Classes A, B and C)

Frequency range, Hz	Maximum gain, dB	Notes
$f < 0.1$	0.1	1
$0.1 \leq f < 1$	$-10 \log_{10} \left[1 + \left(\frac{f}{0.1} \right)^2 \right]$	2
$f \geq 1$	-20	3
NOTE 1 – This is the maximum phase gain in the passband, per clause 7.3.1.		
NOTE 2 – Formula is based on a first-order low-pass filter response, using the maximum bandwidth from clause 7.3.1.		
NOTE 3 – Attenuation in the band above 1 Hz should be at least 20 dB.		

Table VI.3 – Minimum gain for PTP to PTP filter implementation (Classes A, B and C)

Frequency range	Minimum gain, dB	Notes
$f < 0.05$	-3 dB	(Note)
$f > 0.05$	No minimum gain specified	
NOTE – This is the minimum gain in the pass band.		

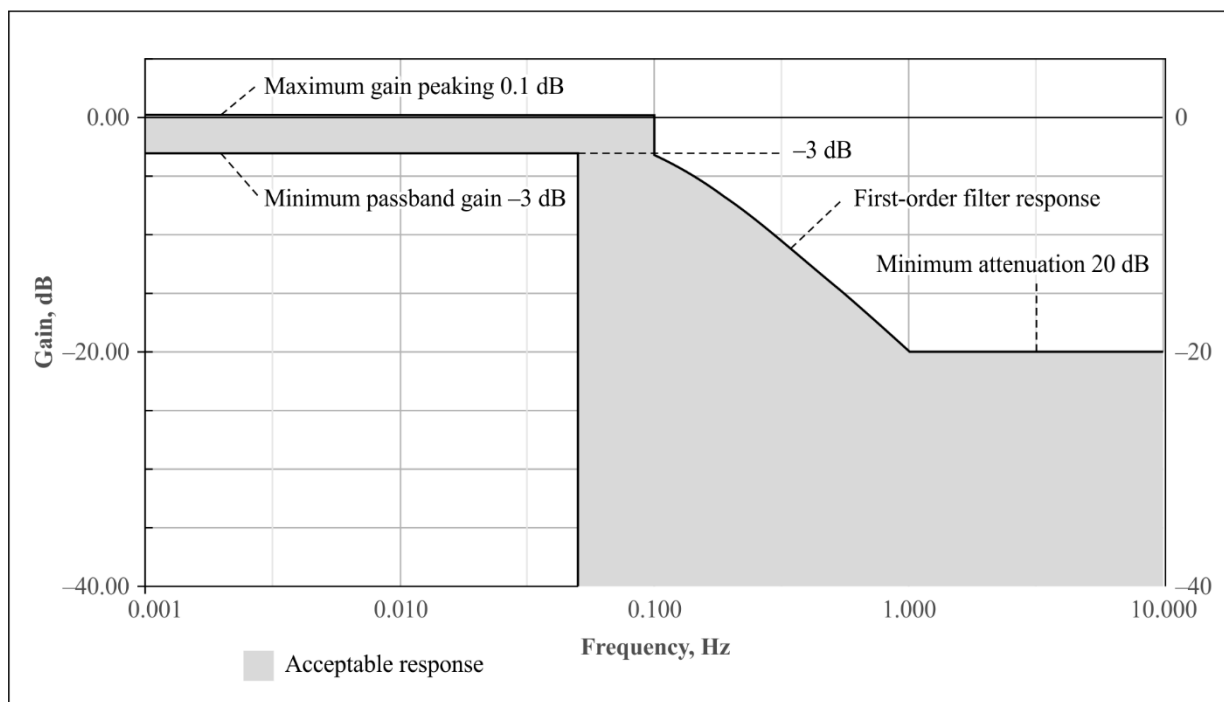

G.8273.2-Y.1368.2(19)_FVI.5

Figure VI.5 – Frequency response of acceptable PTP to PTP filter implementation (Classes A, B and C)

When measuring the performance of the clock, the noise generation of the clock should be taken into account. There are several methods that can be used to do this:

- 1) Allow up to ± 50 ns for noise generation. This is based on the difference between the maximum absolute time error and the constant time error a T-BC of 50 ns (100 ns and 50 ns respectively for class A T-BCs; 70 ns and 20 ns, respectively for class B T-BCs).
- 2) Measure the actual noise generation of the T-BC, and use this as the allowance. For example, the allowance could be $\pm x$ ns, where x is the peak to peak amplitude of the measured noise generation. This has the potential to be more accurate than the first method, but there is a risk that the DUT may be falsely declared as failing the test if the noise generated during the noise transfer test is different from when the noise generation was measured. Note that the test failure is caused by this method, not caused by the tested clock.
- 3) Use a least-squares estimation algorithm to remove the noise generation of the clock, and estimate the output amplitude of the sine wave test tone. This is capable of estimating the amplitude to a reasonable precision with a good level of confidence, provided the added noise is white phase modulation. The accuracy of this method when the added noise has different characteristics (e.g., random walk, other power-law noise types, or sinusoidal noise) is for further study.
- 4) Use a pulse-amplitude modulation method to re-construct the original signal. This involves taking a Fourier transform of the output to recover the tone frequency and its amplitude.

Table VI.4 lists each test frequency, with the permitted gain and expected output amplitude, both with and without added noise. The amount of noise, N , is dependent on which of the four methods is being used. The input tone amplitude used is 200 ns, based on the PTP noise tolerance of the clock. This table could be used as pass/fail criteria for the noise transfer of the clock.

Table VI.4 – Maximum and minimum expected output amplitudes at test frequencies for PTP-to-PTP and PTP-to-1 PPS noise transfer measurement (Classes A, B and C)

Test frequency, Hz	Peak-to-peak input amplitude, ns	Permitted gain, dB		Peak-to-peak output amplitude (clean), ns		Peak-to-peak output amplitude, with $\pm N$ ns added noise, ns	
		Maximum	Minimum	Maximum	Minimum	Maximum	Minimum
0.00390625	200	0.1	-3	205	140	205 + N	140 - N
0.0078125	200	0.1	-3	205	140	205 + N	140 - N
0.015625	200	0.1	-3	205	140	205 + N	140 - N
0.03125	200	0.1	-3	205	140	205 + N	140 - N
0.0615625	200	0.1	n/a	205	n/a	205 + N	n/a
0.123125	200	-4		130		130 + N	
0.24625	200	-8.5		80		80 + N	
0.4925	200	-14		40		40 + N	
0.985	200	-19.9		25		25 + N	
1.985	200	-20		20		20 + N	
<p>NOTE 1 – The frequencies in the above table assume an input PTP event message rate of precisely 16.00 messages/s. For other rates, different tone frequencies should apply as described earlier.</p> <p>NOTE 2 – The maximum amplitude values in the table have been rounded up to the nearest 5 ns in order to account for measurement equipment accuracy, while the minimum amplitude values have been rounded down to the nearest 5 ns.</p>							

VI.5 Expected filter response (physical layer frequency to PTP and physical layer frequency to 1 PPS noise transfer)

The frequency response of the clock is not completely defined in clause 7.3.2. In order to evaluate the performance of the clock, the following criteria are recommended:

- 1) The minimum implementation should have a gain reduction of at least that of a first-order, -20 dB/decade filter for frequencies below the minimum permitted lower corner frequency, and above the maximum permitted upper corner frequency.
- 2) The maximum permitted gain peaking for frequencies between the minimum permitted lower corner frequency and the maximum permitted upper corner frequency should be 0.2 dB.
- 3) The maximum attenuation for frequencies between the maximum permitted lower corner frequency and the minimum permitted upper corner frequency should be 3 dB.
- 4) The attenuation at the maximum permitted upper and minimum permitted lower corner frequencies should be at least 3 dB.
- 5) The maximum attenuation at frequencies below the maximum permitted lower corner frequency and above the minimum permitted upper corner frequency should be undefined.

The maximum acceptable gain at different frequencies is given in Tables VI.5 for classes A and B, and VI.6 for class C. The minimum acceptable gain for all classes of clock is shown in Table VI.7. Figure VI.6 shows the bandpass frequency response when the T-BC or T-TSC is assisted by a physical layer clock specified in [ITU-T G.8262] option 1 (for classes A, B) or [ITU-T G.8262.1] (for class C). The response when the T-BC or T-TSC is assisted by a different physical layer, such as [ITU-T G.812] Type I, is for further study.

Any measured response within the grey zone is considered acceptable. This is before taking into account any noise generation of the clock.

Although Figure VI.6 could be interpreted as having a 'range' of acceptable frequency responses in the passband, once the filter response of the implementation has been established, it is expected that the frequency response will not change over time.

Table VI.5 – Maximum gain for physical layer frequency to PTP filter implementation (Classes A and B)

Frequency range, Hz	Maximum gain, dB	Notes
$f \leq 0.005$	-20	1
$0.005 < f \leq 0.05$	$-10\log_{10} \left[1 + \left(\frac{0.05}{f} \right)^2 \right]$	2
$0.05 < f < 10$	0.2	3
$f \geq 10$	$-10\log_{10} \left[1 + \left(\frac{f}{10} \right)^2 \right]$	4

NOTE 1 – Attenuation in the band below 0.005 Hz should be at least 20 dB.
 NOTE 2 – Formula is based on a first-order high-pass filter response, using the minimum bandwidth from clause 7.4.2.
 NOTE 3 – This is the maximum phase gain in the passband, per clause 7.3.2.
 NOTE 4 – Formula is based on a first-order low-pass filter response, using the maximum bandwidth from clause 7.4.2.

Table VI.6 – Maximum gain for physical layer frequency to PTP filter implementation (Class C)

Frequency range, Hz	Maximum gain, dB	Notes
$f \leq 0.005$	-20	1
$0.005 < f \leq 0.05$	$-10\log_{10} \left[1 + \left(\frac{0.05}{f} \right)^2 \right]$	2
$0.05 < f < 3$	0.2	3
$f \geq 3$	$-10\log_{10} \left[1 + \left(\frac{f}{3} \right)^2 \right]$	4

NOTE 1 – Attenuation in the band below 0.005Hz should be at least 20 dB.
 NOTE 2 – Formula is based on a first-order high-pass filter response, using the minimum bandwidth from clause 7.4.2.
 NOTE 3 – This is the maximum phase gain in the passband, per clause 7.3.2.
 NOTE 4 – Formula is based on a first-order low-pass filter response, using the maximum bandwidth from clause 7.4.2.

Table VI.7 – Minimum gain for physical layer frequency to PTP filter implementation (Classes A, B and C)

Frequency range	Minimum gain, dB
$f < 0.1$	No minimum gain specified
$0.1 \leq f \leq 1$	-3
$f > 1$	No minimum gain specified

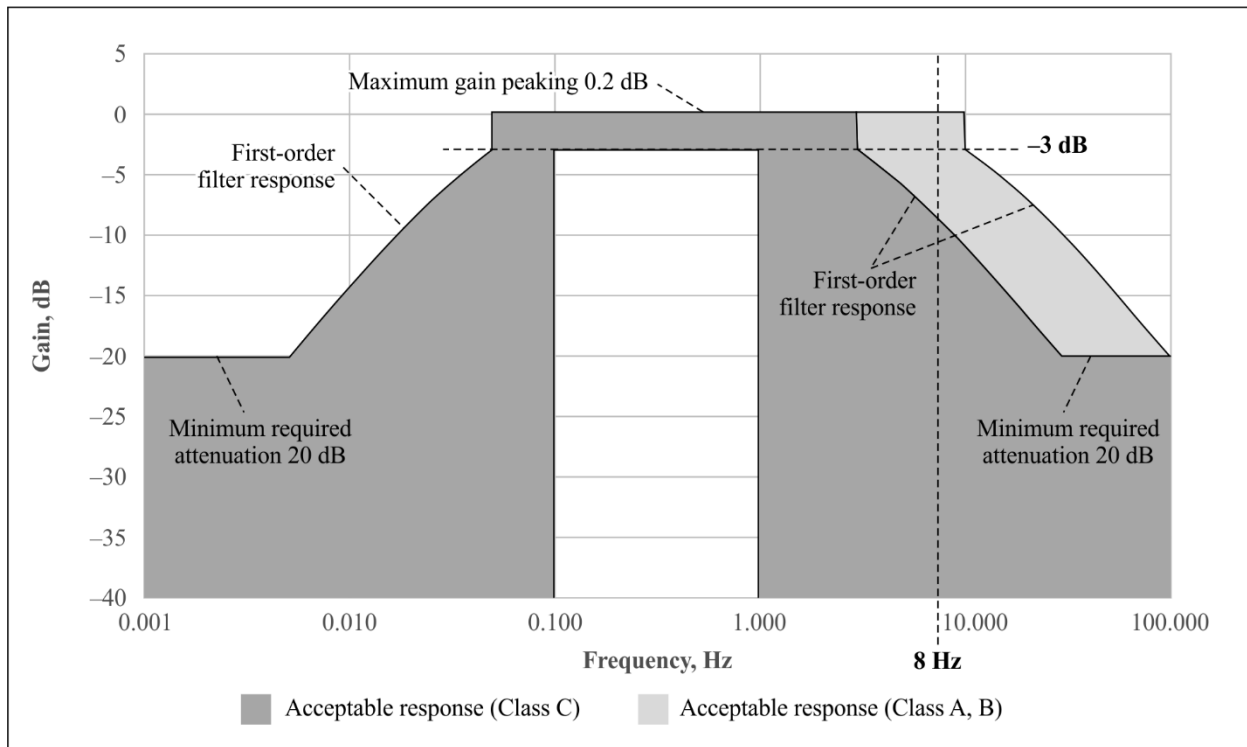

G.8273.2-Y.1368.2(20)-Amd.2(22)_FV1.6

Figure VI.6 – Frequency response of acceptable physical layer frequency to PTP filter implementation (Classes A, B and C)

NOTE – Since the PTP message rate is 16 Hz, it will not be possible to measure the frequency response above the Nyquist rate of 8 Hz. This means it might not be possible to verify the upper corner frequency of the bandpass filter.

When measuring the performance of the clock, the noise generation of the clock should be taken into account. The same methods as described above may be used to do this.

The input tone amplitude used is the maximum permitted at each tone frequency, based on the wander tolerance of the synchronous equipment clock, as defined in Figure 7 of [ITU-T G.8262]. Table VI.8 could be used as pass/fail criteria for the noise transfer of the class A and B clocks, while Table VI.9 could be used as pass/fail criteria for the noise transfer of the class C clocks.

Table VI.8 – Maximum and minimum expected output amplitudes at test frequencies for physical layer frequency to PTP and physical layer frequency to 1 PPS noise transfer measurement (Classes A and B)

Test frequency, Hz	Peak-to-peak input amplitude, ns	Permitted gain, dB		Peak-to-peak output amplitude (clean), ns		Peak-to-peak output amplitude, with $\pm N$ ns added noise, ns	
		Maximum	Minimum	Maximum	Minimum	Maximum	Minimum
0.00390625	2 000	-20	n/a	200	n/a	200 + N	n/a
0.0078125	2 000	-16.2		310		310 + N	
0.015625	2 000	-10.5		600		600 + N	
0.03125	1 000	-5.5		530		530 + N	
0.0615625	500	0.2		515		515 + N	

Table VI.8 – Maximum and minimum expected output amplitudes at test frequencies for physical layer frequency to PTP and physical layer frequency to 1 PPS noise transfer measurement (Classes A and B)

Test frequency, Hz	Peak-to-peak input amplitude, ns	Permitted gain, dB		Peak-to-peak output amplitude (clean), ns		Peak-to-peak output amplitude, with $\pm N$ ns added noise, ns	
		Maximum	Minimum	Maximum	Minimum	Maximum	Minimum
0.123125	250	0.2	-3	260	175	$260 + N$	$175 - N$
0.24625	250	0.2	-3	260	175	$260 + N$	$175 - N$
0.4925	250	0.2	-3	260	175	$260 + N$	$175 - N$
0.985	250	0.2	-3	260	175	$260 + N$	$175 - N$
1.985	250	0.2	n/a	260	n/a	$260 + N$	n/a
3.985	250	0.2		$260 + N$			
7.985	250	0.2		$260 + N$			

NOTE 1 – The frequencies in the above table assume an input PTP event message rate of precisely 16.00 messages/s. For other rates, different tone frequencies should apply as described earlier.

NOTE 2 – The maximum amplitude values in the table have been rounded up to the nearest 5 ns in order to account for measurement equipment accuracy, while the minimum amplitude values have been rounded down to the nearest 5 ns

Table VI.9 – Maximum and minimum expected output amplitudes at test frequencies for physical layer frequency to PTP and physical layer frequency to 1 PPS noise transfer measurement (Class C)

Test frequency, Hz	Peak-to-peak input amplitude, ns (see Note 3)	Permitted gain, dB		Peak-to-peak output amplitude (clean), ns		Peak-to-peak output amplitude, with $\pm N$ ns added noise, ns	
		Maximum	Minimum	Maximum	Minimum	Maximum	Minimum
0.00390625	2 000	-20	n/a	200	n/a	$200 + N$	n/a
0.0078125	2 000	-16.2		310		$310 + N$	
0.015625	2 000	-10.5		600		$600 + N$	
0.03125	1 000	-5.5		530		$530 + N$	
0.0615625	500	0.2		515		$515 + N$	
0.123125	250	0.2	-3	260	175	$260 + N$	$175 - N$
0.24625	250	0.2	-3	260	175	$260 + N$	$175 - N$
0.4925	250	0.2	-3	260	175	$260 + N$	$175 - N$
0.985	250	0.2	-3	260	175	$260 + N$	$175 - N$

Table VI.9 – Maximum and minimum expected output amplitudes at test frequencies for physical layer frequency to PTP and physical layer frequency to 1 PPS noise transfer measurement (Class C)

Test frequency, Hz	Peak-to-peak input amplitude, ns (see Note 3)	Permitted gain, dB		Peak-to-peak output amplitude (clean), ns		Peak-to-peak output amplitude, with $\pm N$ ns added noise, ns	
		Maximum	Minimum	Maximum	Minimum	Maximum	Minimum
1.985	250	0.2	n/a	260	n/a	$260 + N$	n/a
3.985	250	-4.4		155		$155 + N$	
7.985	250	-9.1		90		$90 + N$	

NOTE 1 – The frequencies in the above table assume an input PTP event message rate of precisely 16.00 messages/s. For other rates, different tone frequencies should apply as described earlier.

NOTE 2 – The maximum amplitude values in the table have been rounded up to the nearest 5 ns in order to account for measurement equipment accuracy, while the minimum amplitude values have been rounded down to the nearest 5 ns.

NOTE 3 – The peak-to-peak input amplitude assumes that the enhanced synchronous equipment clock in the T-BC can accept input wander up to wander tolerance level 2, as described in clause 9.2 of [ITU-T G.8262.1]. Lower amplitude tones should be used if level 1 wander tolerance is required.

Appendix VII

Synchronization IWF F-P node limits

(This appendix does not form an integral part of this Recommendation.)

[ITU-T G.8275] specifies the concept of a synchronization interworking function (IWF), where a node is used to translate between different segments of a network that are running different PTP profiles.

For a synchronization IWF F-P node, distributing PTP timing from a full timing support profile to a partial timing support profile, the clock performance limits mainly consider the full timing support type of network used on the timeReceiver port, regardless of the partial timing support used on the timeTransmitter port.

Therefore, all limits applied to the full timing support clocks in the scope of this Recommendation may also apply to such a synchronization IWF F-P node, even if it is not strictly a full timing support one.

Appendix VIII

Measurement of relative time error between two T-BC output ports

(This appendix does not form an integral part of this Recommendation.)

VIII.1 Introduction

Clause 7.1.4 defines two new relative time error generation limits between any two outputs of T-BC. This appendix provides additional information on how to measure and estimate the relative time error generation between ports.

VIII.2 Definition of relative time error

Relative time error (TE_R) is defined in [ITU-T G.8260] as "the difference between two timing signals carrying time". In the case of a T-BC, the two timing signals are the output ports of the same clock.

For two output ports, A and B, relative time error can be expressed mathematically, it can be expressed in two ways:

$$TE_R(t)_{(A,B)} = T(t)_{(A)} - T(t)_{(B)} \quad \text{(the difference between the times indicated by each port A and B at time instant } t \text{)}$$

$$= TE_R(t)_{(A,Ref)} - TE_R(t)_{(B,Ref)} \quad \text{(the difference between the time errors of each port at time instant } t \text{, relative to the same reference)}$$

From this, quantities such as cTE_R , dTE_R and $\max|TE_R|$ may be defined:

$$cTE_R_{(A,B)} = cTE_A - cTE_B \quad \text{(the difference between the mean values of the two time error measurements)}$$

$$dTE_R(t_0 + \tau)_{(A,B)} = TE_R(t_0 + \tau)_{(A,B)} - TE_R(t_0)_{(A,B)} \quad \text{(the difference in } TE_R \text{ since the start of the measurement at time } t_0 \text{. This is similar to TIE in conventional wander measurements)}$$

$$\max|TE_R|_{(A,B)} = \max_n |TE_R(t_0 + \tau)|_{\tau=n\tau_0} \quad \text{(the maximum absolute value of } TE_R(t) \text{ over the entire set of measurement samples)}$$

It should be noted that the new specifications defined in this Recommendation apply to low-pass filtered data, and therefore the two time error measurements should have a low-pass measurement filter of 0.1Hz bandwidth applied to them before computing the relationships.

Appendix IX

PTP noise tolerance testing for T-BC and T-TSC clocks

(This appendix does not form an integral part of this Recommendation.)

The PTP noise tolerance of a T-BC or T-TSC is defined as the maximum amount of noise the device is required to tolerate at its inputs without generating alarms, switching references, or going into holdover. The limits at both the PTP and physical layer frequency inputs are defined in clause 7.2. These limits should be tolerated at both inputs simultaneously.

This appendix describes how to generate suitable test signals to check conformance with this requirement. The description in this appendix concentrates on the non-enhanced case (i.e., T-BC classes A and B). Similar methods may be used for the enhanced case (T-BC classes C and D), but some changes in detail will be required.

IX.1 Testing set-up for PTP noise tolerance testing

The general testing set-up for PTP noise tolerance testing of a T-BC or T-TSC is shown in Figure IX.1.

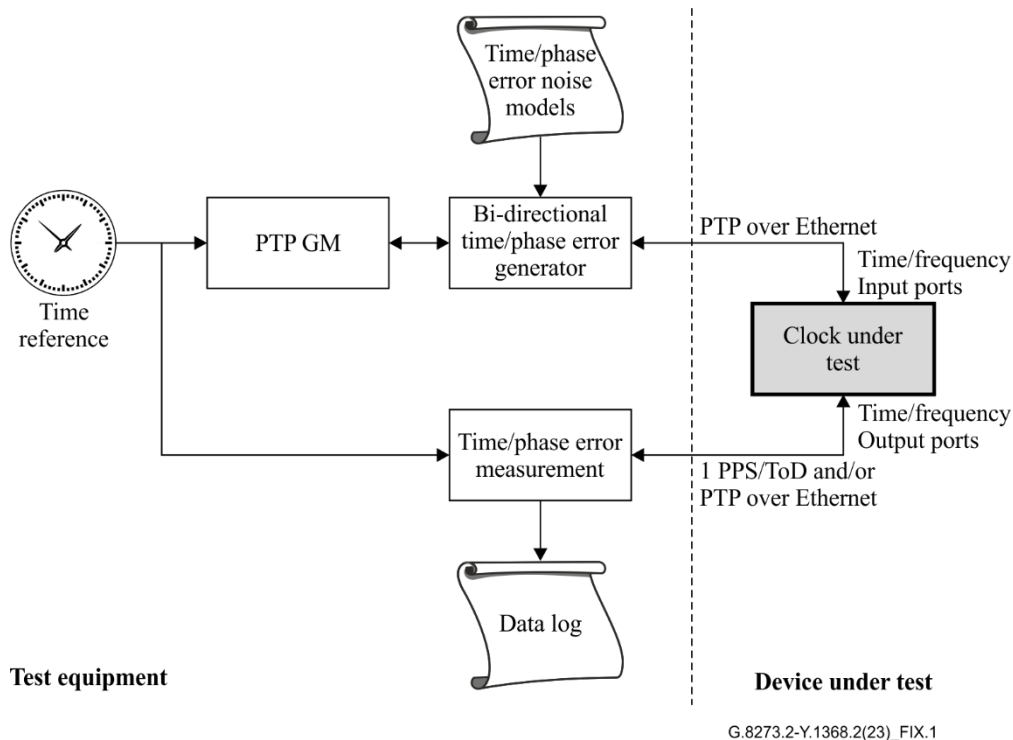

Figure IX.1 – PTP noise tolerance testing of a T-BC or T-TSC

The measurement system is timed by a central time reference clock. The PTP GM and the time/phase error measurement block are both timed from this same time reference.

The bi-directional time/phase error generator block applies time error to both directions of the PTP flow, and also phase error (wander) to the physical layer frequency signal. The time error sequences are generated by means of a noise model, with the parameters chosen to generate a delay distribution with properties similar to the network limits defined in clauses 7.3 and 7.5 of [ITU-T G.8271.1].

Phase wander sequences are also generated using a similar model for application to the synchronous equipment clock input. These are matched to the network limits defined in clause 9.2.1 of [ITU-T G.8261].

The output from the clock under test is either a 1 PPS/ToD (for a T-TSC) or PTP over Ethernet (for a T-BC). This can be measured relative to the time reference, although this is solely for information, as the noise tolerance requirements in clause 7.2 do not specify a limit on the output of the clock.

IX.2 Time/Phase error noise model

The tolerance limit for dTE at the PTP input of a T-BC is derived from the sum of the PRTC noise, plus the noise generated by the network, plus a suppressed physical layer frequency rearrangement transient, as described in Annexes B and C. Similarly, the tolerance limit for physical layer frequency input is also derived from the sum of the PRC noise, plus the noise generated by the network, plus a rearrangement transient.

One approach to generating test sequences to verify the noise tolerance is to use power-law noise signals, such as white noise and flicker noise, to model the phase noise generated by the PRTC and the network clocks. The transients can then be superimposed on top of the noise sequence.

White noise has the property of equal energy at all frequencies, i.e., the energy is uniform for the entire frequency band. On a TDEV plot, white noise slopes downwards with increasing observation interval. As the observation interval increases, each decade represents a tenth of the bandwidth of the previous decade, hence the white noise energy within that decade decreases. As a consequence, white noise is easy to average away – to reduce the noise energy more, simply average over a longer period.

Flicker noise (or self-similar noise), on the other hand, has the property of equal energy in each decade of bandwidth. For example, the band from 1 to 10 Hz contains the same energy as the band from 10 to 100 Hz, even though the bandwidth is ten times higher in the second case. This means that it is not possible to average away flicker noise, as increasing the averaging period simply maintains the same energy level. On a TDEV plot, flicker noise is represented by a flat line, with the TDEV value being the same for every observation interval.

Therefore, white noise is good for representing higher frequency noise components (the dTE_H component), while the lower frequencies (dTE_L) can be represented with flicker noise. Several filtered flicker noise sequences can be combined to match the breakpoints in the MTIE or TDEV masks to be modelled.

The basic combination process is shown in Figure IX.2.

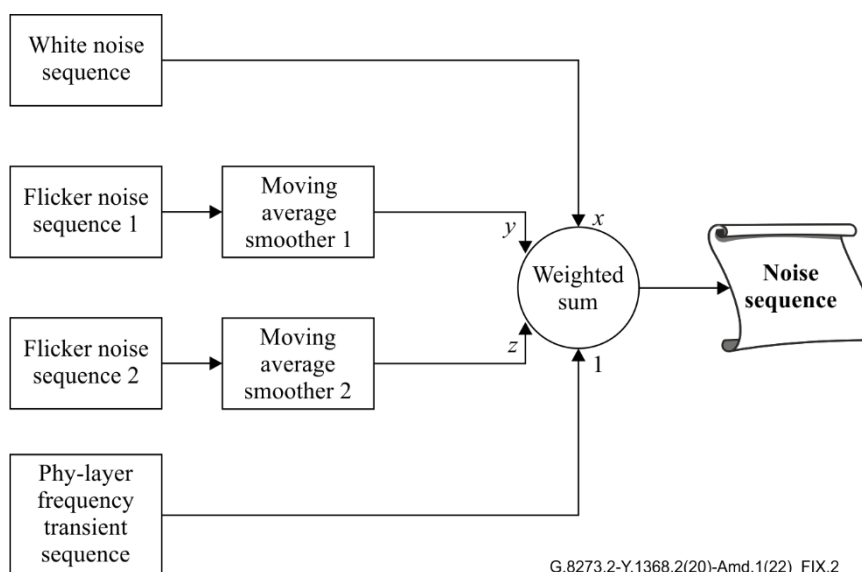

Figure IX.2 – Combination of noise sequences

- 1) White noise and flicker noise sequences are created, each with a packet rate of 16 packets/s.
- 2) The flicker noise sequences are each smoothed with a moving average filter. The length of the moving average window is chosen to match breakpoints on the MTIE mask. The diagram shows two separate flicker noise sequences, but depending on the complexity of the noise limit, one might be sufficient, or possibly even three might be required.
- 3) A physical-layer frequency rearrangement transient is also included. For the PTP input, this is based on the mitigation methods described in Appendix II. The position of this transient within the overall sequence can be controlled. For the physical layer clock, the transient is based on the rearrangement transient described in clause 11.1 of [ITU-T G.8262].
- 4) All four sequences are combined in a weighted sum. The weights and the moving average periods are determined to match the network limit as closely as possible.

The same process may be used to generate both the bi-directional time error for PTP time signals, and phase wander for the physical layer frequency.

An example of the two-way PTP time error generated by this process is shown in Figure IX.3. The suppressed physical layer rearrangement transient can be clearly seen in this example as a negative-going spike at about 4 300 s. The MTIE of this pattern is shown in Figure IX.4.

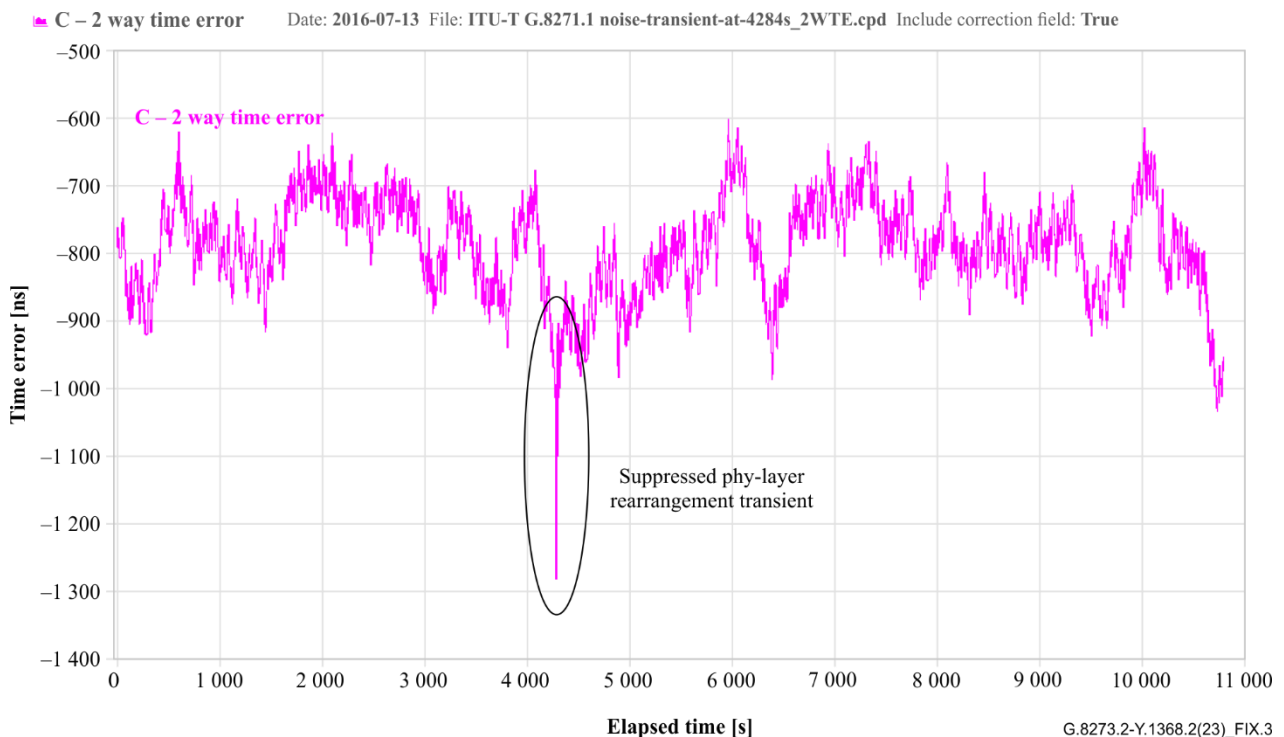

Figure IX.3 – Example power-law noise test sequence

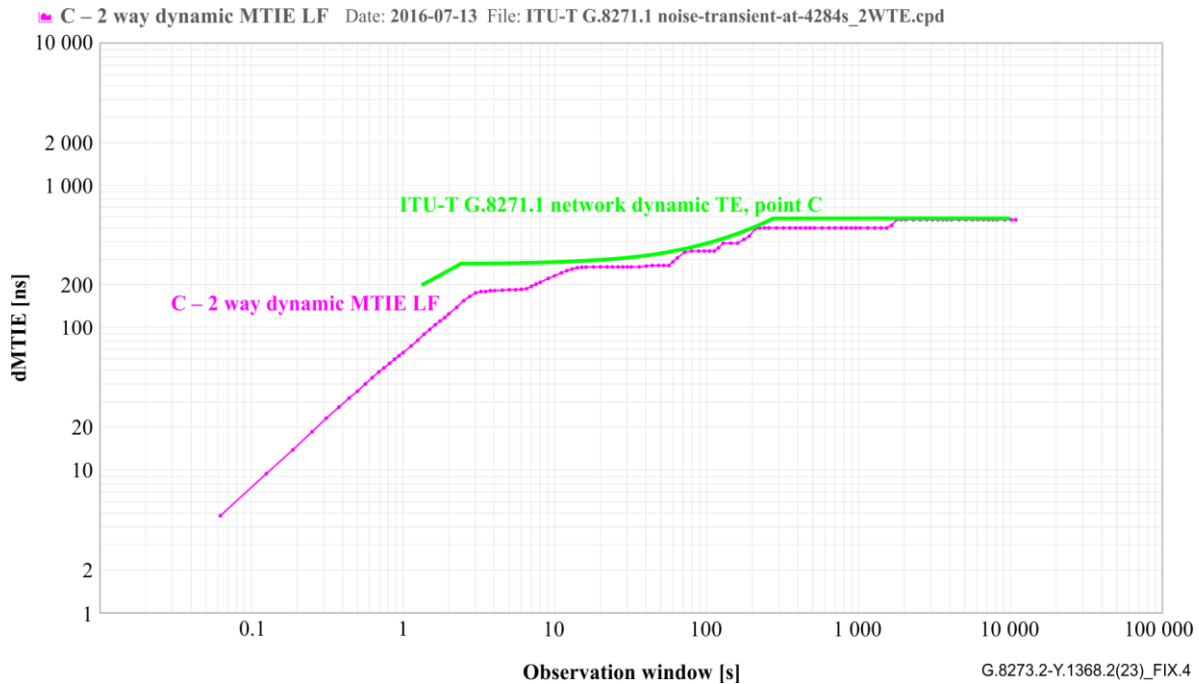

Figure IX.4 – MTIE plot of power-law noise test sequence

IX.3 Explanation of Transients

The clock under test has to be able to tolerate both a suppressed transient on the PTP input, and a rearrangement transient on the physical layer frequency input. Depending on whether the paths of the PTP and physical layer frequency signal are congruent or non-congruent (see Appendix II of [ITU-T G.8271.1]), these transients may or may not be simultaneous.

The congruent case (HRM-2 in Appendix II of [ITU-T G.8271.1]), is shown in Figure IX.5. A rearrangement transient is generated when a fault occurs in the primary physical layer frequency signal of the T-BC preceding the clock under test. The shape of this transient is described in clause 11.1 of [ITU-T G.8262] (or [ITU-T G.8262.1] for enhanced clocks). This transient is passed both to the co-located BC, and to the next T-BC downstream (the clock under test). The co-located BC is required to take avoiding action (as described in Annexes B and C), so only a suppressed transient is seen on the PTP input of the clock under test. The shape of this suppressed transient is described in Appendix II.

Therefore the congruent case results in two simultaneous transients for the clock under test: a suppressed transient at the PTP input, and a rearrangement transient at the physical layer frequency input, plus the appropriate changes in QL-value on the ESMC at the correct time relative to the transient events.

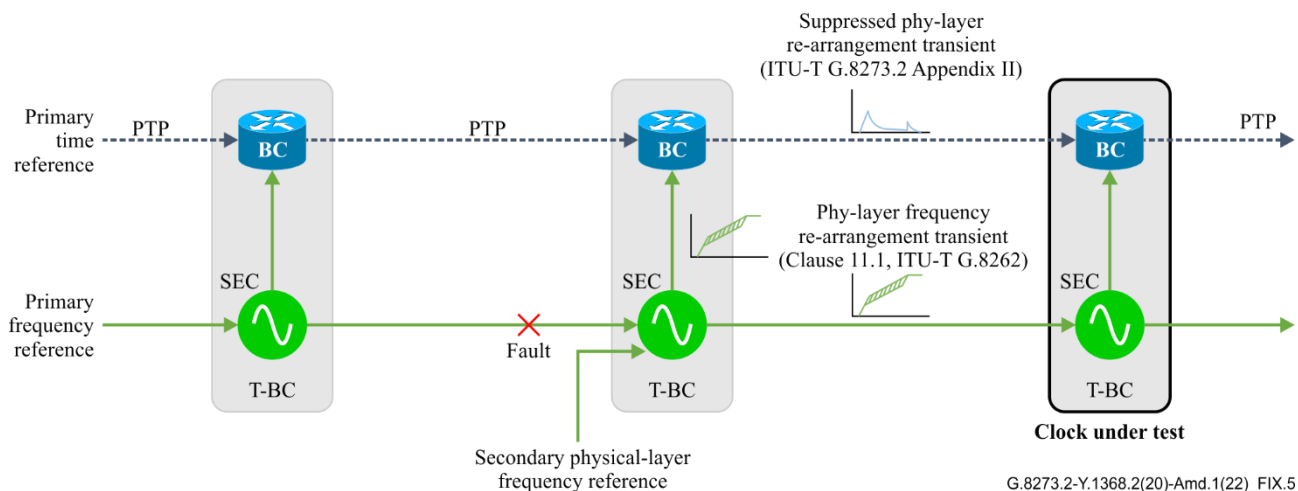

Figure IX.5 – Congruent model (HRM-2)

In the non-congruent case (HRM-3), the physical layer frequency signal is assumed to come from an independent source, and hence there will be no simultaneous rearrangement transients at the both the PTP and physical layer frequency inputs. There may be a rearrangement transient at the physical layer input at an unrelated time, with the associated ESMC changes.

The non-congruent case is shown in Figure IX.6:

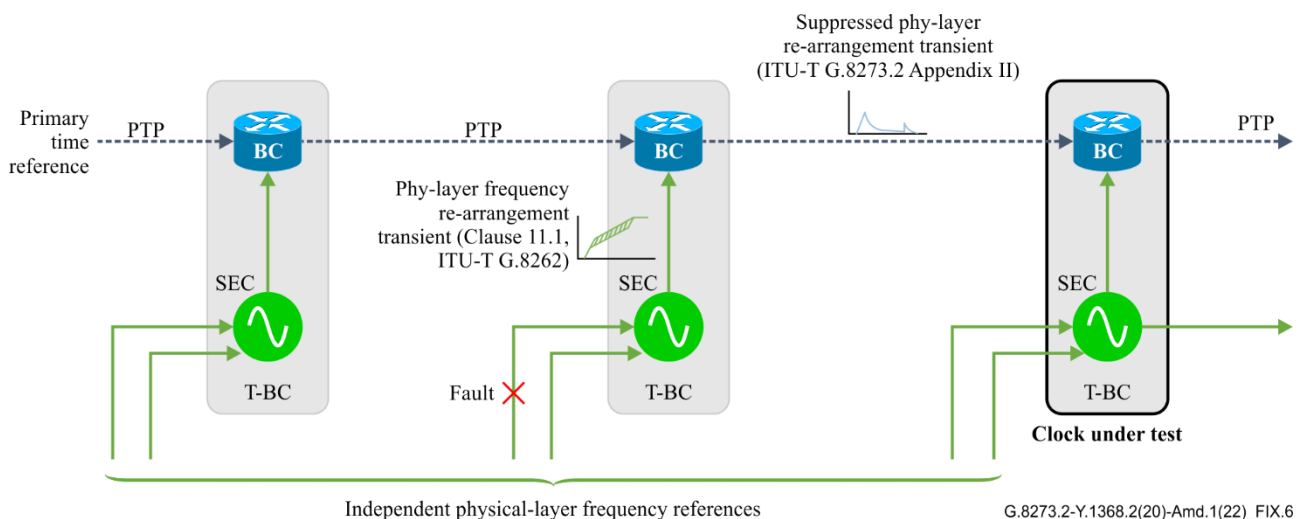

Figure IX.6 – Non-congruent model (HRM-3)

IX.4 Clock output requirements

In the presence of maximum noise at its input, a T-BC or T-TSC should maintain normal operation. In particular, it should:

- not cause any alarms (see note);
- not cause the clock to switch reference;
- not cause the clock to go into holdover.

NOTE – There may be alarms in response to the ESMC messages due to the mitigation schemes required by Annexes B and C. Provided these are not caused by failure of the clock to tolerate the input noise applied, they are acceptable during this test.

There is no defined limit on the maximum time error at the output of a clock under these conditions, therefore any measurement of the output time error of the clock is for information only.

IX.5 Noise model parameters

The parameters of the noise model required to generate noise patterns meeting the various tolerance limits are for further study.

Appendix X

Derivation of T-BC/T-TSC output transient response due to long term rearrangement of physical layer frequency transport

(This appendix does not form an integral part of this Recommendation.)

NOTE – This appendix is valid for T-BC and T-TSC class C embedding an enhanced physical layer clock per [ITU-T G.8262.1].

When the physical layer frequency of a T-BC/T-TSC has a long-term rearrangement (longer than 15 s assumed by the short-term rearrangement), the T-BC/T-TSC may only rely on a phase and time input, and the $\max|TE|$ requirement of the T-BC/T-TSC output is specified by clause 7.4.1.4 of this Recommendation.

The $\max|TE|$ of clause 7.4.1.4 is derived for the following two mitigation schemes:

- a) Reject the eSEC signal when enhanced physical layer frequency input signal is no longer PRC-traceable, and
- b) Turn off the T-BC filter when enhanced physical layer frequency input signal is no longer PRC-traceable

X.1 Background on assumptions for and derivation of T-BC output $\max|TE|$ requirements

In the derivation of the requirements, the physical layer input transient is assumed to have a phase jump of 10 ns due to the long-term rearrangement, as described in clause 11.1 of [ITU-T G.8262.1]. A second phase jump of 10 ns is also assumed to occur when the physical layer reference was recovered.

With the exceptions listed below, the assumptions used in Appendix II.1 are very similar to the assumptions used to derive the requirements for $\max|TE|$ of clause 7.4.1.4. The exceptions are:

1. The enhanced physical layer frequency input signal is not traceable to a PRC reference for a long period of time (longer than 15 s);
2. For scheme a), the characteristics of the noise of the PTP clock is based on [ITU-T G.8262] option 2 noise generation;
3. For scheme b), a waiting time of 600 s before the T-BC filter is turned back on is used;
4. The requirement of clause 7.4.1.4 is specified with $\max|TE|$ instead of $\max|dTE|$, which is used by the assumptions of clause II.1.

X.2 Derivation of T-BC/T-TSC output $\max|TE|$ requirements

The worst case scenario is considered to derive the requirements for clause 7.4.1.4, and therefore the assumptions used for mitigation scheme 1 are considered.

The noise generation of [ITU-T G.8262] option 2 is used for the T-BC/T-TSC during the long-term rearrangement of its physical layer input. According to Table 4 of [ITU-T G.8262], MTIE is 60 ns at observation intervals larger than 10 s. Therefore, the derivation of the requirements for dynamic time error would be as follows:

1. Take into consideration $\frac{1}{2}$ of the MTIE mask of the option 2 of [ITU-T G.8262], i.e., $60 \text{ ns}/2 = 30 \text{ ns}$;
2. Take into consideration 10 ns of phase jump when the physical layer clock is no longer PRC-traceable (note that, by the time the second transient happens, PTP has already corrected the first transient, so there is no need to add another 10 ns for the second transient);
3. Take into consideration timestamp noise, i.e., 8 ns.

Therefore, a $\max|dTE|$ of 48 ns is considered. Considering 10ns margin to account for other errors, $\max|dTE|$ excluding any constant time error (cTE) of 58 ns can be used. For testing purposes, if it is not possible to remove cTE from a test measurement, then the requirements defined in clause 7.4.1.4 is increased by 10 ns (cTE of T-BC/T-TSC class C), this would result in a value of $\max|TE|$ of 68 ns. The same requirement applies for constant and variable temperature conditions.

Bibliography

- [b-Amidror] Isaac Amidror, *Sub-Nyquist Artefacts and Sampling Moiré Effects*, Royal Society Open Science, 2015 March, 2(3): 140550, published online March 18, 2015
<http://rsos.royalsocietypublishing.org/content/2/3/140550>

ITU-T Y-SERIES RECOMMENDATIONS
**Global information infrastructure, Internet protocol aspects, next-generation networks,
Internet of Things and smart cities**

GLOBAL INFORMATION INFRASTRUCTURE	Y.100-Y.999
INTERNET PROTOCOL ASPECTS	Y.1000-Y.1999
General	Y.1000-Y.1099
Services and applications	Y.1100-Y.1199
Architecture, access, network capabilities and resource management	Y.1200-Y.1299
Transport	Y.1300-Y.1399
Interworking	Y.1400-Y.1499
Quality of service and network performance	Y.1500-Y.1599
Signalling	Y.1600-Y.1699
Operation, administration and maintenance	Y.1700-Y.1799
Charging	Y.1800-Y.1899
IPTV over NGN	Y.1900-Y.1999
NEXT GENERATION NETWORKS	Y.2000-Y.2999
FUTURE NETWORKS	Y.3000-Y.3499
CLOUD COMPUTING	Y.3500-Y.3599
BIG DATA	Y.3600-Y.3799
QUANTUM KEY DISTRIBUTION NETWORKS	Y.3800-Y.3999
INTERNET OF THINGS AND SMART CITIES AND COMMUNITIES	Y.4000-Y.4999

For further details, please refer to the list of ITU-T Recommendations.

SERIES OF ITU-T RECOMMENDATIONS

Series A	Organization of the work of ITU-T
Series D	Tariff and accounting principles and international telecommunication/ICT economic and policy issues
Series E	Overall network operation, telephone service, service operation and human factors
Series F	Non-telephone telecommunication services
Series G	Transmission systems and media, digital systems and networks
Series H	Audiovisual and multimedia systems
Series I	Integrated services digital network
Series J	Cable networks and transmission of television, sound programme and other multimedia signals
Series K	Protection against interference
Series L	Environment and ICTs, climate change, e-waste, energy efficiency; construction, installation and protection of cables and other elements of outside plant
Series M	Telecommunication management, including TMN and network maintenance
Series N	Maintenance: international sound programme and television transmission circuits
Series O	Specifications of measuring equipment
Series P	Telephone transmission quality, telephone installations, local line networks
Series Q	Switching and signalling, and associated measurements and tests
Series R	Telegraph transmission
Series S	Telegraph services terminal equipment
Series T	Terminals for telematic services
Series U	Telegraph switching
Series V	Data communication over the telephone network
Series X	Data networks, open system communications and security
Series Y	Global information infrastructure, Internet protocol aspects, next-generation networks, Internet of Things and smart cities
Series Z	Languages and general software aspects for telecommunication systems