

## Recommendation

# **ITU-T G.8275.1/Y.1369.1 (2022) Amd. 1 (01/2024)**

SERIES G: Transmission systems and media, digital systems and networks

Packet over Transport aspects – Synchronization, quality and availability targets

SERIES Y: Global information infrastructure, Internet protocol aspects, next-generation networks, Internet of Things and smart cities

Internet protocol aspects – Transport

---

Precision time protocol telecom profile for phase/time synchronization with full timing support from the network

## **Amendment 1**



ITU-T G-SERIES RECOMMENDATIONS  
**Transmission systems and media, digital systems and networks**

INTERNATIONAL TELEPHONE CONNECTIONS AND CIRCUITS	G.100-G.199
GENERAL CHARACTERISTICS COMMON TO ALL ANALOGUE CARRIER-TRANSMISSION SYSTEMS	G.200-G.299
INDIVIDUAL CHARACTERISTICS OF INTERNATIONAL CARRIER TELEPHONE SYSTEMS ON METALLIC LINES	G.300-G.399
GENERAL CHARACTERISTICS OF INTERNATIONAL CARRIER TELEPHONE SYSTEMS ON RADIO-RELAY OR SATELLITE LINKS AND INTERCONNECTION WITH METALLIC LINES	G.400-G.449
COORDINATION OF RADIOTELEPHONY AND LINE TELEPHONY	G.450-G.499
TRANSMISSION MEDIA AND OPTICAL SYSTEMS CHARACTERISTICS	G.600-G.699
DIGITAL TERMINAL EQUIPMENTS	G.700-G.799
DIGITAL NETWORKS	G.800-G.899
DIGITAL SECTIONS AND DIGITAL LINE SYSTEM	G.900-G.999
MULTIMEDIA QUALITY OF SERVICE AND PERFORMANCE – GENERIC AND USER-RELATED ASPECTS	G.1000-G.1999
TRANSMISSION MEDIA CHARACTERISTICS	G.6000-G.6999
DATA OVER TRANSPORT – GENERIC ASPECTS	G.7000-G.7999
PACKET OVER TRANSPORT ASPECTS	G.8000-G.8999
Ethernet over Transport aspects	G.8000-G.8099
MPLS over Transport aspects	G.8100-G.8199
<b>Synchronization, quality and availability targets</b>	<b>G.8200-G.8299</b>
Mobile network transport aspects	G.8300-G.8399
Service Management	G.8600-G.8699
ACCESS NETWORKS	G.9000-G.9999

*For further details, please refer to the list of ITU-T Recommendations.*

# Recommendation ITU-T G.8275.1/Y.1369.1

## Precision time protocol telecom profile for phase/time synchronization with full timing support from the network

### Amendment 1

#### Summary

Recommendation ITU-T G.8275.1/Y.1369.1 contains the ITU-T precision time protocol (PTP) profile for phase and time distribution with full timing support from the network. It provides the necessary details to utilize IEEE 1588 in a manner consistent with the architecture described in Recommendation ITU-T G.8275.

Amendment 1 incorporates the following updates:

- 1 Clarifications on some dataset members use in the dataset comparison algorithm;
- 2 Updates to PTSF functionality to include monitoring ports;
- 3 Clarifies the setting of the frequencyTraceable flag;
- 4 Clarifies defaultDS.deviceType;
- 5 Adds performance monitoring Annex F of Recommendation ITU-T G.8275 as an optional feature of this profile;
- 6 Adds clarification to Annex G and Annex K;
- 7 Revises terminology based on inclusive language;
- 8 Adds new dataset members into Table A.1 and Table A.5;
- 9 Adds new profileVersion 2.6 and 2.7 in clauses A.1 and A.11;
- 10 Added Appendices XVI and XVII.

#### History \*

Edition	Recommendation	Approval	Study Group	Unique ID
1.0	ITU-T G.8275.1/Y.1369.1	2014-07-22	15	11.1002/1000/12197
1.1	ITU-T G.8275.1/Y.1369.1 (2014) Cor. 1	2015-01-13	15	11.1002/1000/12397
2.0	ITU-T G.8275.1/Y.1369.1	2016-06-22	15	11.1002/1000/12815
2.1	ITU-T G.8275.1/Y.1369.1 (2016) Amd. 1	2017-08-29	15	11.1002/1000/13329
2.2	ITU-T G.8275.1/Y.1369.1 (2016) Amd. 2	2018-03-16	15	11.1002/1000/13553
2.3	ITU-T G.8275.1/Y.1369.1 (2016) Amd. 3	2019-08-29	15	11.1002/1000/14017
3.0	ITU-T G.8275.1/Y.1369.1	2020-03-15	15	11.1002/1000/14215
3.1	ITU-T G.8275.1/Y.1369.1 (2020) Amd. 1	2020-11-13	15	11.1002/1000/14543
3.2	ITU-T G.8275.1/Y.1369.1 (2020) Amd. 2	2021-06-29	15	11.1002/1000/14709
3.3	ITU-T G.8275.1/Y.1369.1 (2020) Amd. 3	2022-02-13	15	11.1002/1000/14913
4.0	ITU-T G.8275.1/Y.1369.1	2022-11-13	15	11.1002/1000/15131
4.1	ITU-T G.8275.1/Y.1369.1 (2022) Amd. 1	2024-01-13	15	11.1002/1000/15843

#### Keywords

IEEE 1588, phase, profile, PTP, time.

---

\* To access the Recommendation, type the URL <https://handle.itu.int/> in the address field of your web browser, followed by the Recommendation's unique ID.

## FOREWORD

The International Telecommunication Union (ITU) is the United Nations specialized agency in the field of telecommunications, information and communication technologies (ICTs). The ITU Telecommunication Standardization Sector (ITU-T) is a permanent organ of ITU. ITU-T is responsible for studying technical, operating and tariff questions and issuing Recommendations on them with a view to standardizing telecommunications on a worldwide basis.

The World Telecommunication Standardization Assembly (WTSA), which meets every four years, establishes the topics for study by the ITU-T study groups which, in turn, produce Recommendations on these topics.

The approval of ITU-T Recommendations is covered by the procedure laid down in WTSA Resolution 1.

In some areas of information technology which fall within ITU-T's purview, the necessary standards are prepared on a collaborative basis with ISO and IEC.

## NOTE

In this Recommendation, the expression "Administration" is used for conciseness to indicate both a telecommunication administration and a recognized operating agency.

Compliance with this Recommendation is voluntary. However, the Recommendation may contain certain mandatory provisions (to ensure, e.g., interoperability or applicability) and compliance with the Recommendation is achieved when all of these mandatory provisions are met. The words "shall" or some other obligatory language such as "must" and the negative equivalents are used to express requirements. The use of such words does not suggest that compliance with the Recommendation is required of any party.

## INTELLECTUAL PROPERTY RIGHTS

ITU draws attention to the possibility that the practice or implementation of this Recommendation may involve the use of a claimed Intellectual Property Right. ITU takes no position concerning the evidence, validity or applicability of claimed Intellectual Property Rights, whether asserted by ITU members or others outside of the Recommendation development process.

As of the date of approval of this Recommendation, ITU had not received notice of intellectual property, protected by patents/software copyrights, which may be required to implement this Recommendation. However, implementers are cautioned that this may not represent the latest information and are therefore strongly urged to consult the appropriate ITU-T databases available via the ITU-T website at <http://www.itu.int/ITU-T/ipr/>.

© ITU 2024

All rights reserved. No part of this publication may be reproduced, by any means whatsoever, without the prior written permission of ITU.

## Table of Contents

	<b>Page</b>
1	Scope..... 1
2	References..... 1
3	Definitions ..... 2
3.1	Terms defined elsewhere ..... 2
3.2	Terms defined in this Recommendation..... 3
4	Abbreviations and acronyms ..... 3
5	Conventions ..... 4
6	Use of PTP for phase/time distribution ..... 5
6.1	High-level design requirements..... 5
6.2	PTP modes and options ..... 6
6.3	Protection aspects and Alternate BTCA..... 10
6.4	Phase/time traceability information..... 17
7	ITU-T PTP profile for phase/time distribution with full timing support from the network ..... 20
8	Security aspects ..... 20
Annex A	– ITU-T PTP profile for phase/time distribution with full timing support from the network ..... 21
A.1	Profile identification ..... 21
A.2	PTP attribute values..... 21
A.3	PTP options ..... 28
A.4	Best timeTransmitter clock algorithm options ..... 29
A.5	Path delay measurement option (delay request/delay response) ..... 29
A.6	Clock identity format..... 29
A.7	Configuration management options ..... 29
A.8	Security aspects ..... 29
A.9	Other optional features of [IEEE 1588]..... 29
A.10	PTP common header flags..... 30
A.11	Profile version compatibility ..... 31
A.12	Other optional features used in this profile ..... 32
Annex B	– Options to establish the PTP topology with the Alternate BTCA ..... 33
Annex C	– Inclusion of an external phase/time input interface in a T-BC..... 34
Annex D	– Path trace (optional) ..... 35
Annex E	– Synchronization uncertain indication (optional)..... 36
Annex F	– Use of stepsRemoved to limit reference chain (optional)..... 37
Annex G	– Monitoring alternate timeTransmitter time information provided by a peer PTP port (optional) ..... 38
G.1	Use case 1 – PASSIVE port monitoring TIME_TRANSMITTER port ..... 39
G.2	Use case 2 – TIME_TRANSMITTER port monitoring PASSIVE port ..... 40

	<b>Page</b>
G.3 Use Case 3 – TIME_TRANSMITTER port monitoring TIME_TRANSMITTER port .....	41
Annex H – Transport of PTP over OTN .....	43
Annex I – Transport PTP over MTN .....	44
Annex J – Transport PTP over FlexE links.....	45
Annex K – Dynamic Monitoring based on PTSF (Optional) .....	46
Appendix I – Considerations on the use of transparent clock.....	48
Appendix II – Considerations on the transmission of Delay_Req messages.....	49
Appendix III – Considerations on the choice of the PTP Ethernet multicast destination address .....	51
Appendix IV – Considerations on the use of priority2 .....	52
Appendix V – Description of PTP clock modes and associated contents of Announce messages .....	53
Appendix VI – Operations over link aggregation.....	54
Appendix VII – Relationship between clockClass and holdover specification .....	55
Appendix VIII – Considerations on a T-TSC connected to an end application .....	57
Appendix IX – Calculation of offsetScaledLogVariance for T-GM timed by PRTC or ePRTC.....	58
IX.1 Observation interval and TDEV noise generation.....	58
IX.2 Computation of PTP variance from TDEV .....	58
IX.3 Computation of offsetScaledLogVariance from PTP variance .....	59
Appendix X – Description of a T-BC extended clockClass application.....	61
X.1 Purpose of T-BC extended clockClass application .....	61
X.2 DefaultDS data set member specifications under this extended application..	61
Appendix XI – Considerations on native access equipment.....	63
Appendix XII – Monitoring alternate timeTransmitter time information provided by a peer PTP port .....	66
Appendix XIII – Considerations on the use of [IEEE 1588-2019].....	67
Appendix XIV – Considerations in an environment of more than two PTP ports on a single PTP communication path when using transparent clocks and multicast addressing .....	68
Appendix XV – Considerations of deploying ePRTC and PRTC in the network .....	70
Appendix XVI – Considerations of using clockClass and priority2 in the synchronization network .....	71
Appendix XVII – Aspects of Ethernet switching and T-BC functionality within a network element.....	73
Bibliography.....	74

# Recommendation ITU-T G.8275.1/Y.1369.1

## Precision time protocol telecom profile for phase/time synchronization with full timing support from the network

### Amendment 1

*Editorial note: This is a complete-text publication. Modifications introduced by this amendment are shown in revision marks relative to Recommendation ITU-T G.8275.1/Y.1369.1 (2022).*

#### 1 Scope

This Recommendation specifies a profile for telecommunication applications based on IEEE 1588 precision time protocol (PTP). The profile specifies the IEEE 1588 functions that are necessary to ensure network element interoperability for the delivery of accurate phase/time synchronization. The profile is based on the full timing support from the network architecture as described in [ITU-T G.8275] and definitions described in [ITU-T G.8260].

This version of the profile specifies the high-level design requirements, modes of operation for the exchange of PTP messages, the PTP protocol mapping, the best ~~master-time~~ Transmitter clock algorithm (BMCABTCA) options, as well as the PTP protocol configuration parameters.

NOTE 1 – The parameters defined in this version of the profile are chosen based on the case where physical layer frequency support is provided, and the case without physical layer frequency support (i.e., PTP only) is for further study.

This Recommendation also specifies some aspects necessary for use in a telecom environment that are outside the scope of and complement the PTP profile.

An implementation compliant with this profile can claim compliance with either IEEE Std 1588-2008 [IEEE 1588-2008] or IEEE Std 1588-2019 [IEEE 1588-2019]. Considerations on the use of one or the other profile are provided in Appendix XIII. Compliance for a specific implementation with either the [IEEE 1588-2008] or [IEEE 1588-2019] versions of the standard should be stated when referring to this profile.

#### 2 References

The following ITU-T Recommendations and other references contain provisions which, through reference in this text, constitute provisions of this Recommendation. At the time of publication, the editions indicated were valid. All Recommendations and other references are subject to revision; users of this Recommendation are therefore encouraged to investigate the possibility of applying the most recent edition of the Recommendations and other references listed below. A list of the currently valid ITU-T Recommendations is regularly published. The reference to a document within this Recommendation does not give it, as a stand-alone document, the status of a Recommendation.

[ITU-T G.709] Recommendation ITU-T G.709/Y.1331 (2020), *Interfaces for the optical transport network*.

[ITU-T G.709.1] Recommendation ITU-T G.709.1/1331.1 (~~2018~~2024), *Flexible OTN short-reach interfaces*.

[ITU-T G.781] Recommendation ITU-T G.781 (~~2020~~2024), *Synchronization layer functions for frequency synchronization based on the physical layer*.

[ITU-T G.810] Recommendation ITU-T G.810 (1996), *Definitions and terminology for synchronization networks*.

[ITU-T G.7041] Recommendation ITU-T G.7041/Y.1303 (2016), *Generic framing procedure*.

- [ITU-T G.8260] Recommendation ITU-T G.8260 (2022), *Definitions and terminology for synchronization in packet networks*.
- [ITU-T G.8265.1] Recommendation ITU-T G.8265.1/Y.1365.1 (2022), *Precision time protocol telecom profile for frequency synchronization*.
- [ITU-T G.8271] Recommendation ITU-T G.8271/Y.1366 (2020), *Time and phase synchronization aspects of telecommunication networks*.
- [ITU-T G.8271.1] Recommendation ITU-T G.8271.1/Y.1366.1 (2022), *Network limits for time synchronization in packet networks with full timing support from the network*.
- [ITU-T G.8272] Recommendation ITU-T G.8272/Y.1367 (2018), *Timing characteristics of primary reference time clocks*.
- [ITU-T G.8272.1] Recommendation ITU-T G.8272.1 (~~2016~~2024), *Timing characteristics of enhanced primary reference time clocks*.
- [ITU-T G.8273] Recommendation ITU-T G.8273/Y.1368 (~~2018~~2023), *Framework of phase and time clocks*.
- [ITU-T G.8273.2] Recommendation ITU-T G.8273.2/Y.1368.2 (2023), *Timing characteristics of telecom boundary clocks and telecom ~~time slave clock~~time synchronous clocks for use with full timing support from the network*.
- [ITU-T G.8273.3] Recommendation ITU-T G.8273.3/Y.1368.3 (2020), *Timing characteristics of telecom transparent clocks for use with full timing support from the network*.
- [ITU-T G.8275] Recommendation ITU-T G.8275 (~~2020~~2024), *Architecture and requirements for packet-based time and phase distribution*.
- [ITU-T G.8312] Recommendation ITU-T G.8312 (2020), *Interfaces for metro transport networks*.
- [IEEE 802.1Q] IEEE 802.1Q-2022, IEEE Standard for Local and Metropolitan Area Networks – Media Access Control (MAC) Bridges and Virtual Bridged Local Area Networks.
- [IEEE 1588] Either [IEEE 1588-2008] or [IEEE 1588-2019] depending on the specific implementation. See clause 5 Conventions for more details.
- [IEEE 1588-2008] IEEE 1588-2008, *IEEE Standard for a Precision Clock Synchronization Protocol for Networked Measurement and Control Systems*.
- [IEEE 1588-2019] IEEE 1588-2019, *IEEE Standard for a Precision Clock Synchronization Protocol for Networked Measurement and Control Systems*.
- [OIF FLEXE IA] Optical Internetworking Forum, IA OIF-FLEXE-02.2 (2021), *FlexE 2.2 Implementation Agreement*.

### 3 Definitions

#### 3.1 Terms defined elsewhere

This Recommendation uses the following terms defined elsewhere:

The terms and definitions used in this Recommendation are contained in [ITU-T G.810] and [ITU-T G.8260].



## 3.2 Terms defined in this Recommendation

This Recommendation defines the following term:

**3.2.1 special port:** A PTP special port is a PTP port that translates between the native timing mechanism of a medium and PTP.

## 4 Abbreviations and acronyms

This Recommendation uses the following abbreviations and acronyms:

AVAR	Allan Variance
BC	Boundary Clock
<del>BMC</del> <u>ABTCA</u>	Best <del>Master</del> <u>Time Transmitter</u> Clock Algorithm
EEC	synchronous Ethernet Equipment Clock
ePRTC	Enhanced Primary Reference Time Clock
EUI	Extended Unique Identifier
FlexE	Flex Ethernet
FPM	Flicker Phase Modulation
GM	Grandmaster
GNSS	Global Navigation Satellite System
LAG	Link Aggregation
MA-L	MAC Address – Large
MA-M	MAC Address – Medium
MA-S	MAC Address – Small
MTN	Metro Transport Network
MVAR	Modified Allan Variance
OC	Ordinary Clock
OEC	OTN Equipment Clock
OSMC	OTN synchronization messaging channel
OUI	Organizationally Unique Identifier
PRC	Primary Reference Clock
PRS	Primary Reference Source
PRTC	Primary Reference Time Clock
PSD	Power Spectral Density
PTP	Precision Time Protocol
PTSF	Packet Timing Signal Fail
QL	Quality Level
SDH	Synchronous Digital Hierarchy
SSM	Synchronization Status Message
SSU	Synchronization Supply Unit

SSU-A	primary level SSU
SSU-B	secondary level SSU
ST2	Stratum 2
ST3E	Stratum 3 Enhanced
T-BC	Telecom Boundary Clock
TC	Transparent Clock
T-GM	Telecom Grandmaster
T-TC	Telecom Transparent Clock
T-TSC	Telecom <del>Time Slave Clock</del> <u>Time Synchronous Clock</u>
TLV	Type Length Value
<u>TR</u>	<u>timeReceiver, TimeReceiver, or TIME RECEIVER</u>
<u>TT</u>	<u>timeTransmitter, TimeTransmitter, or TIME TRANSMITTER</u>
TVAR	Time Variance
VLAN	Virtual Local Area Network
WPM	White Phase Modulation

## 5 Conventions

Within this Recommendation, the following conventions are used: the term PTP refers to the PTP defined in [IEEE 1588]. PTP messages used within this Recommendation are defined in [IEEE 1588] and are identified using italicized text.

The term telecom boundary clock (T-BC) refers to a device consisting of a boundary clock (BC) as defined in [IEEE 1588] and this Recommendation, with additional performance characteristics defined in [ITU-T G.8273.2].

The term telecom transparent clock (T-TC) refers to a device consisting of a transparent clock (TC) as defined in [IEEE 1588] and this Recommendation, with additional performance characteristics defined in [ITU-T G.8273.3].

The term telecom grandmaster (T-GM) refers to a device consisting of a grandmaster (GM) clock as defined in [IEEE 1588] and this Recommendation, with additional performance characteristics for further study.

The term telecom ~~time slave clock~~time synchronous clock (T-TSC) refers to a device consisting of a ~~slave-only~~timeReceiver-only ordinary clock (OC) as defined in [IEEE 1588] and this Recommendation, with additional performance characteristics defined in the Annex C of [ITU-T G.8273.2].

The term primary reference time clock (PRTC) refers to the clock defined in [ITU-T G.8272]. The term enhanced primary reference time clock (ePRTC) refers to an enhanced version of the PRTC, which is being studied.

Within this Recommendation, some requirements are stated as requiring compliance to [IEEE 1588]. For implementations based on [IEEE 1588-2008], the reference to [IEEE 1588] means compliance to [IEEE 1588-2008]. For implementations based on [IEEE 1588-2019], the reference to [IEEE 1588] means compliance to [IEEE 1588-2019]. Some of these references to [IEEE 1588] includes a specific clause number. In these cases, the clause number is the same in both [IEEE 1588-2008] and [IEEE 1588-2019]. If the requirements are in different clauses in the two versions of IEEE 1588, then

the text of this Recommendation shall include the specific clause for [IEEE 1588-2008] and the specific cause for [IEEE 1588-2019].

## 6 Use of PTP for phase/time distribution

The [IEEE 1588] standard defines the precision time protocol designed to enable accurate time transfer. It introduces the concept of "profile", whereby aspects of the protocol may be selected and specified for a particular application.

A PTP profile has been defined in [ITU-T G.8265.1] to address applications requiring frequency synchronization only. This Recommendation defines another PTP profile, for telecom applications requiring accurate phase and time synchronization. It supports the specific architecture described in [ITU-T G.8275] in order to allow the distribution of phase/time with full timing support from the network and is based on [IEEE 1588].

In order to claim compliance with the telecom profile, the requirements of this Recommendation and the relevant requirements of [IEEE 1588], as referenced in Annex A, must be met.

The detailed aspects related to the telecom profile are described in the following clauses, while the profile itself is contained in Annex A. It follows the general rules for profile specification developed in [IEEE 1588].

This PTP telecom profile defines the parameters from [IEEE 1588] to be used in order to guarantee protocol interoperability between implementations and specifies the optional features, default values of configurable attributes and mechanisms that must be supported. However, it does not guarantee that the performance requirements of a given application will be met. These performance aspects are defined in other ITU-T Recommendations and imply additional elements beyond the content of the PTP profile itself.

### 6.1 High-level design requirements

[IEEE 1588] states:

*"The purpose of a PTP profile is to allow organizations to specify specific selections of attribute values and optional features of PTP that, when using the same transport protocol, inter-work and achieve a performance that meets the requirements of a particular application."*

For operation in a telecom network, some additional criteria are also required to be consistent with standard telecom synchronization practices. Therefore, the PTP profile for time and phase distribution must meet the following high-level requirements:

- 1) Mechanisms must be specified to allow interoperability between the various phase/time clocks belonging to the architecture defined in [ITU-T G.8275] and described in [ITU-T G.8273].
- 2) Mechanisms must permit consistent operation over managed wide area telecom networks.
- 3) Packet-based mechanisms must allow the synchronization network to be designed and configured in a fixed arrangement.
- 4) Protection schemes used by packet-based systems must be based on standard telecom operational practice and allow telecom ~~time-slave clocks~~ time synchronous clocks the ability to take phase and time from multiple geographically separate telecom grandmaster clocks.
- 5) Phase/time reference source selection based on received phase/time traceability and local priority, as well as automatic establishment of the phase/time synchronization network topology, should be permitted.

## 6.2 PTP modes and options

### 6.2.1 PTP domains

A domain consists of a logical grouping of clocks communicating with each other using the PTP protocol.

PTP domains are used to partition a network within an administrative entity. The PTP messages and data sets are associated with a domain and therefore, the PTP protocol is independent for different domains.

In this PTP telecom profile, the default PTP domain number is 24, and the range of applicable PTP domain numbers is {24 – 43}.

NOTE – This range has been selected from the user-defined PTP domain number range defined in [IEEE 1588]. Although non-overlapping ranges have been considered for the different PTP telecom profiles so that interactions between the profiles are prevented, nothing precludes another industry from using the same user-defined PTP domain number range when defining a non-telecom PTP profile. It is the responsibility of the network operator to identify if the risk of unintentional interactions between PTP profiles exists, and to take the necessary actions to prevent such behaviour.

### 6.2.2 PTP messages used in the profile

This PTP profile uses the messages: *Sync*, *Follow\_Up*, *Announce*, *Delay\_Req*, and *Delay\_Resp*.

The use of *Signalling* and *Management* messages is for further study.

*Pdelay\_Req*, *Pdelay\_Resp*, and *Pdelay\_Resp\_Follow\_Up* messages are not used.

### 6.2.3 Types of PTP clocks supported in the profile

The ordinary clock (OC), boundary clock (BC) and transparent clock (TC) according to [IEEE 1588] are used in this profile.

There are two types of OCs:

- 1) An OC that can only be a grandmaster (T-GM according to the architecture defined in [ITU-T G.8275], and as included in [ITU-T G.8272]).
- 2) An OC that can only be a timeReceiverslave, i.e., ~~slave-only~~timeReceiver-only OC (T-TSC according to the architecture defined in [ITU-T G.8275], and compliant with [ITU-T G.8273.2]).

There are two types of BCs:

- 1) A BC that can only be a grandmaster (T-GM according to the architecture defined in [ITU-T G.8275], and as included in [ITU-T G.8272]).
- 2) A BC that can become a grandmaster and can also be ~~slaved to~~synchronized from another PTP clock (T-BC according to architecture defined in [ITU-T G.8275] and compliant with [ITU-T G.8273.2]).

NOTE – T-GM and grandmaster (GM) are different concepts; GM is a status defined in [IEEE 1588] that a PTP clock may obtain if it wins the best timeTransmitter ~~master~~-clock algorithm (BMCABTCA), while T-GM is a type of clock defined in the [ITU-T G.8275] architecture.

The transparent clock used in this profile (T-TC according to the architecture defined in [ITU-T G.8275] and compliant with [ITU-T G.8273.3]) is the end-to-end transparent clock defined in [IEEE 1588]. It is not permitted to use peer-to-peer transparent clocks in this profile.

The support of OTN ports on a T-TC is for further study.

The support of metro transport network (MTN) ports as defined in [ITU-T G.8312] on a T-TC is for further study.

The support of FlexE as defined in [OIF FlexE IA] on a T-TC is for further study.

The mapping between these PTP clockTypes and the phase/time clocks defined in the [ITU-T G.8275] architecture is described in Table 1.

**Table 1 – Mapping between [ITU-T G.8275.1] deviceTypes and PTP clockTypes**

deviceType from [ITU-T G.8275.1]	Description	clockType from [IEEE 1588]
T-GM	<del>MasterTimeTransmitter</del> master-only ordinary clock (timeTransmittermaster with a single PTP port, always a GM, cannot be <u>synchronized from</u> <del>slaved to</del> another PTP clock)	OC
	<del>TimeTransmitterMaster</del> only boundary clock (timeTransmittermaster with multiple PTP ports, always a GM, cannot be <u>synchronized from</u> <del>slaved to</del> another PTP clock)	BC
T-BC	Boundary clock (may become a GM, or may be <u>synchronized from</u> <del>slaved to</del> another PTP clock)	BC
T-TSC	<del>Slave-only</del> TimeReceiver-only ordinary clock (always a <u>timeReceiverslave</u> , cannot become a GM)	OC
T-TC	Transparent clock	End-to-end TC

### 6.2.3.1 Dataset member for PTP clocks supported in the profile

A management system can configure and/or read the deviceType of a PTP clock; this allows the management node to configure other properties that are specific for that type of clock implemented in the equipment that is being deployed in the network. Equipment may support different types of clocks, and therefore deviceType is a configurable attribute.

The data type for deviceType is Enumeration8, using the enumerated value per Table 2.

**Table 2 – deviceType enumeration value**

deviceType from [ITU-T G.8275.1]	Enumeration value (hex)
T-GM	0x10
T-BC	0x11
T-TSC	0x12
T-TC	0x13

### 6.2.4 One-way versus two-way operation

PTP operation must be two-way in this profile in order to transport phase/time synchronization, because propagation delay must be measured. Therefore, only two-way mode is allowed in this profile.

### 6.2.5 One-step versus two-step clock mode

Both one-step and two-step clocks are supported in the profile. A clock compliant with the profile may use either a one-step clock or a two-step clock.

To be compliant with [IEEE 1588], a timeReceiver slave port must be capable of receiving and processing messages from both one-step clocks and two-step clocks, without any particular configuration.

### 6.2.6 Ethernet multicast addressing for PTP messages

For the PTP profile specified in this Recommendation, when using the PTP mapping defined in [IEEE 1588-2008] Annex F or [IEEE 1588-2019] Annex E, Ethernet multicast addressing is used for the Ethernet frames that carry the PTP messages. Both the non-forwardable multicast address 01-80-C2-00-00-0E and the forwardable multicast address 01-1B-19-00-00-00 are supported.

A T-GM, T-BC, T-TSC or T-TC clock compliant with this profile must be capable of handling both the non-forwardable multicast address 01-80-C2-00-00-0E and the forwardable multicast address 01-1B-19-00-00-00 on all its PTP-capable Ethernet ports.

For a T-GM, T-BC and T-TSC clock, the choice of the multicast address is made by configuration on a per-port basis; all the PTP messages of an Ethernet port must use the configured address for transmitting PTP messages to the remote PTP port. In case the remote PTP port is configured with the other address, the local PTP port must accept and process the received messages.

The default address depends on the operator policy. See information in Appendix III.

On transmission, the default mode for a T-TC that supports only Ethernet transport does not require any configuration: the PTP messages retransmitted by the T-TC must use the same multicast destination address as the received PTP message. It is mandatory to support this default mode in transmission. The default mode of transmission at an Ethernet port for a T-TC that supports both Ethernet and non-Ethernet ports is for further study.

NOTE – This profile uses [IEEE 1588-2008] Annex F, *Transport of PTP over IEEE802.3/Ethernet*, or [IEEE 1588-2019] Annex E, *Transport of PTP over IEEE 802.3 transports* for the transport layer when the transport layer is Ethernet. In particular, according to the relevant Ethernet bridge models, the appropriate MAC address of the transmit Ethernet port is placed into the source address field of the header of the Ethernet frame encapsulating the PTP packets sent by any of the PTP clocks defined in this profile (i.e., T-GM, T-BC, T-TC or T-TSC).

### 6.2.7 PTP mapping

This PTP telecom profile is based on the PTP mapping defined in

- a) [IEEE 1588-2008] Annex F, *Transport of PTP over IEEE 802.3/Ethernet*, or [IEEE 1588-2019] Annex E, *Transport of PTP over IEEE 802.3 transports*,
- b) Annex H of this Recommendation, *Transport of PTP over OTN*,
- c) Annex I of this Recommendation, *Transport of PTP over MTN*, and
- d) Annex J of this Recommendation, *Transport of PTP over FlexE*.

Therefore, a PTP clock compliant with the profile described in this Recommendation must be compliant with [IEEE 1588] for ports that use Ethernet transport, with Annex H of this Recommendation for ports that use OTN transport, with Annex I of this Recommendation for ports that use MTN, and with Annex J of this Recommendation for ports that use FlexE. This profile processes PTP messages with:

- a) Ethernet multicast encapsulation when the transport layer is Ethernet;
- b) Either:
  - i) GFP-F encapsulation and insertion into the OTUk OSMC or FlexO OSMC, or
  - ii) Vendor-specific encapsulation into the OSC OSMC,

when the transport layer is OTN;

NOTE – OSC OSMC does not allow interoperability between different vendors. The test of this function is for further study.

- c) Ethernet multicast encapsulation, and insertion into the MTN overhead per clause 9.2.5 of [ITU-T G.8312], when the transport layer is MTN;

- d) Ethernet multicast encapsulation, and insertion into the Synchronization Messaging Channel per clause 7.3.5 of [OIF FlexE IA], when the transport layer is FlexE.

PTP messages with other encapsulations should be forwarded based on the forwarding rules of the respective transport.

The transportSpecific field is used in this profile and must be set to "0".

In the scenarios currently considered, e.g., based on full timing support with T-BC and T-TC, the insertion of a [IEEE 802.1Q] virtual local area network (VLAN) tag in the frames carrying PTP messages over Ethernet is not allowed for T-GMs, T-BCs and T-TSC. In this case, when receiving a PTP message within a frame containing a [IEEE 802.1Q] VLAN tag, this frame must be discarded by the T-GM, T-BC, and T-TSC.

Some specific T-TC based configurations are discussed in Appendix I.

Using [IEEE 802.1Q] VLAN tags in other scenarios is for further study.

### 6.2.8 Message rates

Within the scope of the profile, the following messages can be used, and the corresponding indicated nominal rates shall be respected:

- Sync messages (if used, Follow\_up messages will have the same rate) – nominal rate: 16 packets-per-second.
- Delay\_Req/Delay\_Resp messages – nominal rate: 16 packets-per-second.
- Announce messages – nominal rate: 8 packets-per-second.

Inter-message interval requirements shall also be respected for the transmission of Sync (clause 9.5.9 of [IEEE 1588]) and Announce (clause 9.5.8 of [IEEE 1588]) messages. In addition, the time between successive Sync messages shall not exceed twice the mean Sync interval specified above, and the time between successive Announce messages shall not exceed twice the mean Announce interval specified above.

The transmission of Delay\_Req messages is specified in clause 9.5.11.2 of [IEEE 1588].

In addition to clause 9.5.11.2 of [IEEE 1588-2008] (first and second dashed items) or of [IEEE 1588-2019] (items (a) and (b)), a clock compliant to this profile shall follow one of the following options:

- Transmission time requirements according to clause 9.5.11.2 of [IEEE 1588-2008] (third dashed item) or of [IEEE 1588-2019] (item (c), subitem (1)), using an implementation-specific distribution. In this case, the PTP node shall, with 90% confidence, issue Delay\_Req messages with inter-message intervals within  $\pm 30\%$  of  $2^{\log_{10} \text{MinDelayReqInterval}}$  seconds.
- Transmission time requirements specified in clause 9.5.11.2 of [IEEE 1588-2008] (forth dashed item) or of [IEEE 1588-2019] (item (c), subitem (2)).

In addition, the time between successive Delay\_Req messages shall not exceed  $2^{\log_{10} \text{MinDelayReqInterval}+1}$  seconds.

As per clause 9.5.12 of [IEEE 1588], the ~~Master~~ TimeTransmitter sets the logMessageInterval in the header of Delay\_Resp messages to a value accepted by the ~~TimeTransmitter~~ Master. In this profile that value is -4 (16 ~~messages per second~~pps).

Additional background information concerning the Delay\_Req message transmission specified in clause 9.5.11.2 of [IEEE 1588] is included in Appendix II.

The use of signalling and management messages is for further study.

## 6.3 Protection aspects and Alternate BMCABTCA

### 6.3.1 Alternate BMCABTCA

The PTP profile specified in this Recommendation uses an Alternate BMCABTCA, as described in clause 9.3.1 of [IEEE 1588]. This Alternate BMCABTCA differs from the default BMCABTCA of [IEEE 1588] as follows:

- a) This profile uses the per port Boolean attribute masterOnlytimeTransmitterOnly as specified in Annex E of [ITU-T G.8275].
- b) The profile uses the per port Boolean attribute notMasternotTimeTransmitter as specified in Annex E of [ITU-T G.8275].
- c) The profile allows for multiple clocks to be active GMs simultaneously (clocks with clockClass less than 128 cannot be a timeReceiverslave). If there are multiple active GMs, every clock that is not a GM is synchronized by a single GM in the PTP domain.
- d) The per-port attribute localPriority is assigned to each port r of a clock and is used in the determination of  $E_{r\text{best}}$  and  $E_{\text{best}}$ . Each parent clock or foreign timeTransmittermaster clock data set, whose *Announce* information was received on the port r, is appended with the localPriority attribute of the local port r before the data set comparison defined in Figure 2 and Figure 3 below is invoked. The localPriority attribute is not transmitted in *Announce* messages. This attribute is used as a tie-breaker in the data set comparison algorithm, in the event that all other previous attributes of the data sets being compared are equal. The localPriority attribute is set via the configurable, unsigned integer, port data set member portDS.localPriority. The data type for this attribute is UInteger8. The range of values for this attribute is {1-255}. The default value for this attribute is 128. A clock compliant with this PTP profile is allowed to support a subset of the values defined in the range.
- e) The attribute localPriority is assigned to the local clock, to be used if needed when the data associated with the local clock,  $D_0$ , is compared with data on another potential GM received via an *Announce* message. The local clock localPriority attribute is set via the configurable, unsigned integer, default data set member defaultDS.localPriority. The data type for this attribute is UInteger8. The range of values for this attribute is {1-255}. The default value for this attribute is 128. A clock compliant with this PTP profile is allowed to support a subset of the values defined in the range.
- f) The data set comparison algorithm is modified according to Figures 2 and 3 in clause 6.3.7.

NOTE 1 – For a T-BC, the ports for which the masterOnlytimeTransmitterOnly attribute is FALSE should be selected according to the network synchronization plan. One typical use case where this parameter should remain TRUE is to prevent timing from propagating from the access portion of the network to the core portion of the network.

NOTE 2 – The use of masterOnlytimeTransmitterOnly is intended primarily to be used in two scenarios:

- 1) A PTP port of a T-GM;
- 2) A PTP port of a T-BC that is facing the 'downstream' direction towards the access portion of a tree topology.

The use of the masterOnlytimeTransmitterOnly parameter in other scenarios, such as on PTP ports participating in a ring architecture, may result in unintended operation, especially during re-configuration or topology changes.

### 6.3.2 Considerations on the use of the localPriority attributes

The localPriority attributes provide a powerful tool in defining the synchronization network architecture.



The use of the default values for these attributes as defined by the Alternate [BMCABTCA](#) results in a timing-loop free synchronization network.

Proper planning will be mandatory to avoid timing-loops when configuring values different from the default ones.

### 6.3.3 Static clock attribute priority1

In this PTP profile, the clock attribute priority1 is static. It is initialized to a default value equal to the midpoint value, 128, of its range, and this value must not be changed.

The priority1 parameter is not used in this version of the PTP telecom profile. Future versions may consider using this attribute, this is for further study.

### 6.3.4 Clock attribute priority2

In this PTP profile, the clock attribute priority2 is configurable.

It is initialized to a default value, equal for T-GM and T-BC clocks to the midpoint value, 128, of its range {0-255}. The default value for T-TSC clocks is 255, and the range is {255}.

A T-GM or T-BC compliant with this PTP profile must support all the values of priority2 defined in the range. A T-TSC compliant with this profile must support, on reception, all the values of priority2 defined in the full [IEEE 1588] range (i.e., {0-255}).

Appendix IV describes possible use cases for the priority2 attribute; Appendix X describes possible use cases for the priority2 attribute under Note 3 of Table 3; other cases are for further study.

### 6.3.5 Other clock attributes

A PTP clock compliant with this PTP profile must support all the values of clockClass, clockAccuracy, and offsetScaledLogVariance upon reception [shall not discard] defined in the full [IEEE 1588] range.

The applicable values of the clock attribute clockClass are specified in clause 6.4.

NOTE – It is not expected that equipment compliant to this profile and deployed in an ITU-T G.8275.1 network will receive clockClass values not specified in Table 3 or Table 5. If a clockClass value not specified in Table 3 or Table 5 is received, then the equipment may raise an implementation specific alarm. Future revisions of this profile may include clockClass values not defined in Table 3 or Table 5.

The following values of the clock attribute clockAccuracy apply for the following situations:

- 0x20 for a T-GM connected to an enhanced primary reference time clock (ePRTC) in locked-mode (i.e., ePRTC traceable to global navigation satellite system (GNSS));
- 0x21 for a T-GM connected to a PRTC in locked-mode (i.e., PRTC traceable to GNSS) or a T-GM connected to an ePRTC where the ePRTC is in phase/time holdover within [ITU-T G.8272.1] ePRTC-A specification as specified in Table 3 of [ITU-T G.8272.1];
- 0xFE for a T-GM not connected to an ePRTC nor a PRTC in locked-mode, or a T-GM connected to an ePRTC in phase/time holdover but outside the holdover specification in Table 3 of [ITU-T G.8272.1];
- 0xFE for a T-BC, all the time.

The following values of the clock attribute offsetScaledLogVariance apply for the following situations:

- 0x4B32 for a T-GM connected to an ePRTC in locked-mode (i.e., ePRTC traceable to GNSS). This corresponds to TDEV of 10 ns, at observation interval of 1 000 000 s. The corresponding value of PTP Variance (PTPVAR) is  $1.271 \times 10^{-16} \text{ s}^2$  (see Appendix IX);

- 0x4E5D for a T-GM connected to a PRTC in locked-mode (i.e., PRTC traceable to GNSS). This corresponds to TDEV of 30 ns, at observation interval of 10 000 s. The corresponding value of PTP Variance (PTPVAR) is  $1.144 \times 10^{-15} \text{ s}^2$  (see Appendix IX);
- 0xFFFF for a T-GM not connected to an ePRTC in locked-mode nor to a PRTC in locked-mode;
- 0xFFFF for a T-BC, all the time.

### 6.3.6 State decision algorithm

The state decision algorithm applicable to the Alternate [BMCABTCA](#) of the PTP profile specified in this Recommendation is given in Figure 1. After a decision is reached by use of this algorithm, the data sets of the local clock are updated as specified in clause 9.3.5 of [IEEE 1588]. Details on the use of the algorithm are given in clause 9.3.3 of [IEEE 1588].

### 6.3.7 Data set comparison algorithm

The data set comparison algorithm for the Alternate [BMCABTCA](#) of the PTP profile specified in this Recommendation is given in Figures 2 and 3 below. With this algorithm, one clock is compared with another using the data sets representing those clocks, appended with the localPriority attribute. Details on the use of the algorithm are given in clause 9.3.4 of [IEEE 1588].

If either of the data sets, A or B, in Figures 2 and 3 contain the data of the parent clock or a foreign [timeTransmittermaster](#) clock, the corresponding localPriority for its data set is the localPriority of the local port r on which the information from that parent clock or foreign [timeTransmittermaster](#) clock has been received (see item (d) of clause 6.3.1).

If either of the data sets, A or B, in Figures 2 and 3 contain the data of the local clock, D<sub>0</sub>, the corresponding localPriority for that data set is the localPriority of the local clock (see item ~~(e)~~[\(c\)](#) of clause 6.3.1).

NOTE 1 – It is recommended that the entire data set comparison algorithm described in Figures 2 and 3 be implemented even if some parameters are currently static, because they may be used in future versions of this Recommendation.

NOTE 2 – The block in Figure 2 "GM clockClass of A is 127 or less" enables different T-BCs in the network to be synchronized by different T-GMs when multiple T-GMs are deployed.

NOTE 3 – If portDS.SF is TRUE on port r, then the PTP port should set the respective E<sub>r</sub><sup>rbest</sup> to the empty set. As a result, the computation of E<sub>best</sub> will not use the information contained in any Announce messages received on the port r. Signal fail (SF) is described in clause 6.3.9.

NOTE 4 – Procedures related to defaultDS.timeReceiverOnly are defined in clauses 9.2.2 of [IEEE 1588-2008] or 9.2.2.1 of [IEEE 1588-2019] and 9.3 of [IEEE 1588].

NOTE 5 – Procedures related to portDS.timeTransmitterOnly are defined in clause 9.2.2.2 of [IEEE 1588-2019] and Annex E of [ITU-T G.8275].

NOTE 6 – Procedures related to portDS.notTimeTransmitter are defined in Annex E of [ITU-T G.8275].

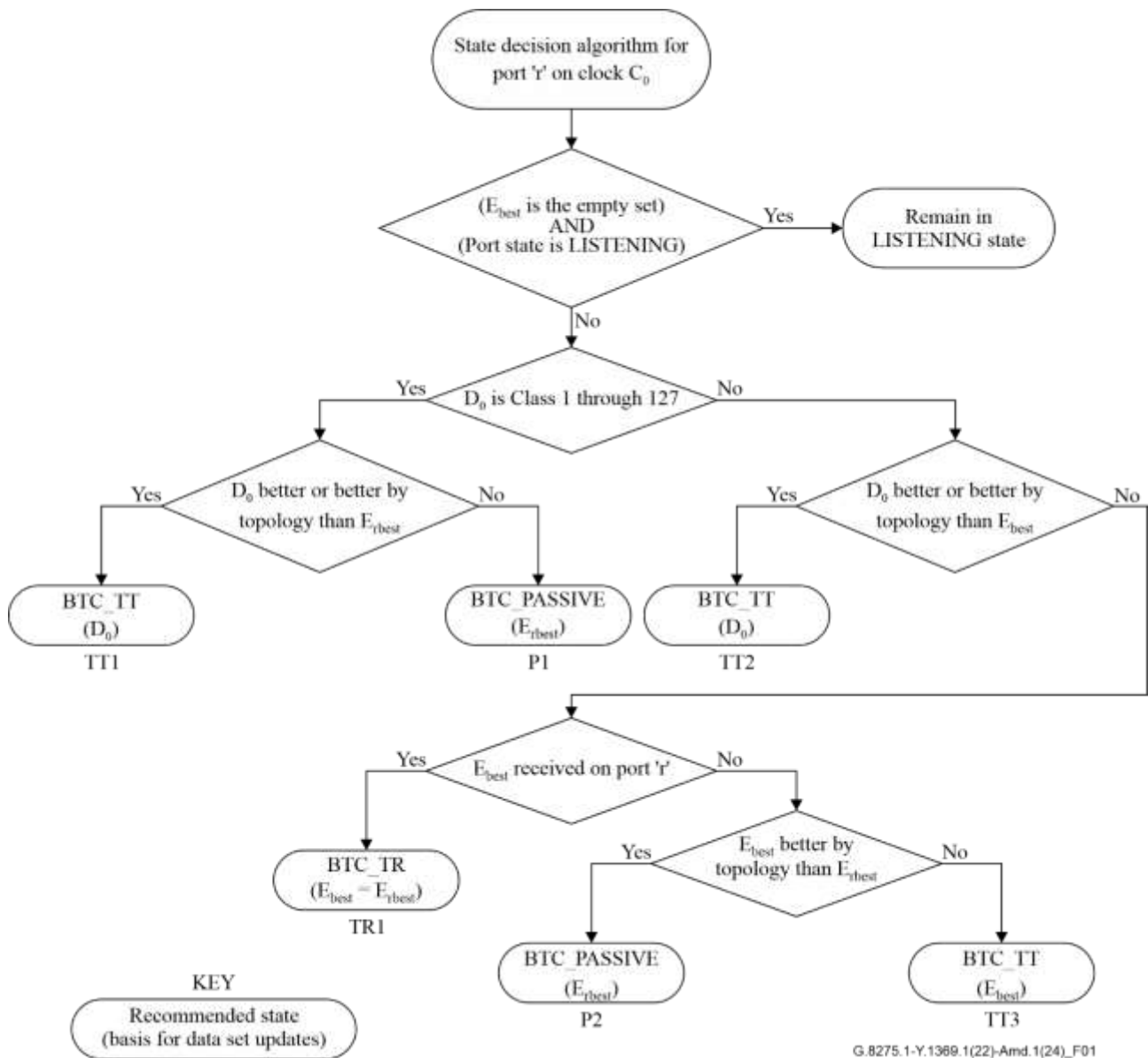

Figure 1 – State decision algorithm for Alternate [BMCABTCA](#)

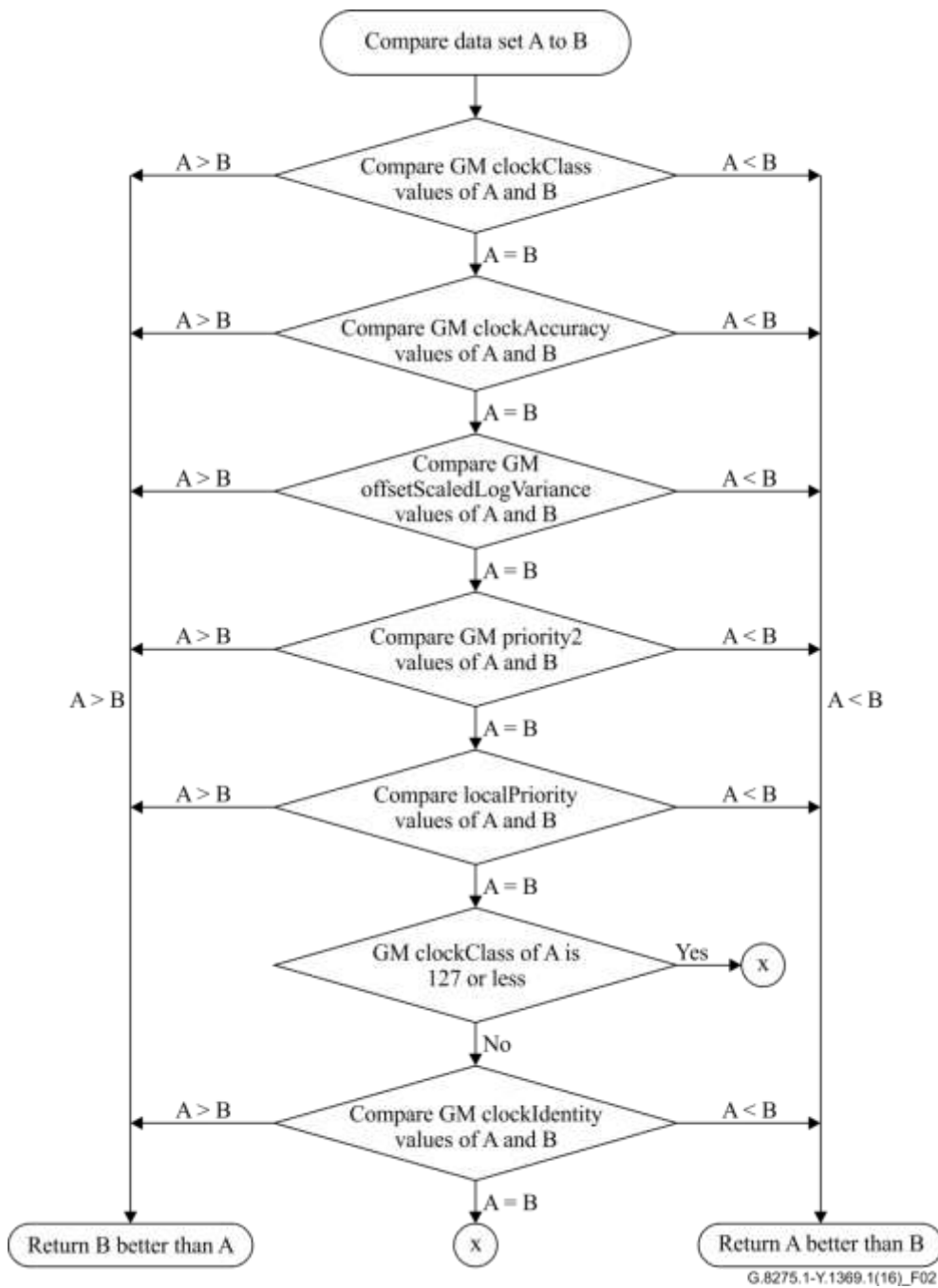

Figure 2 – Data set comparison algorithm, part 1, for Alternate [BMCABTCA](#)

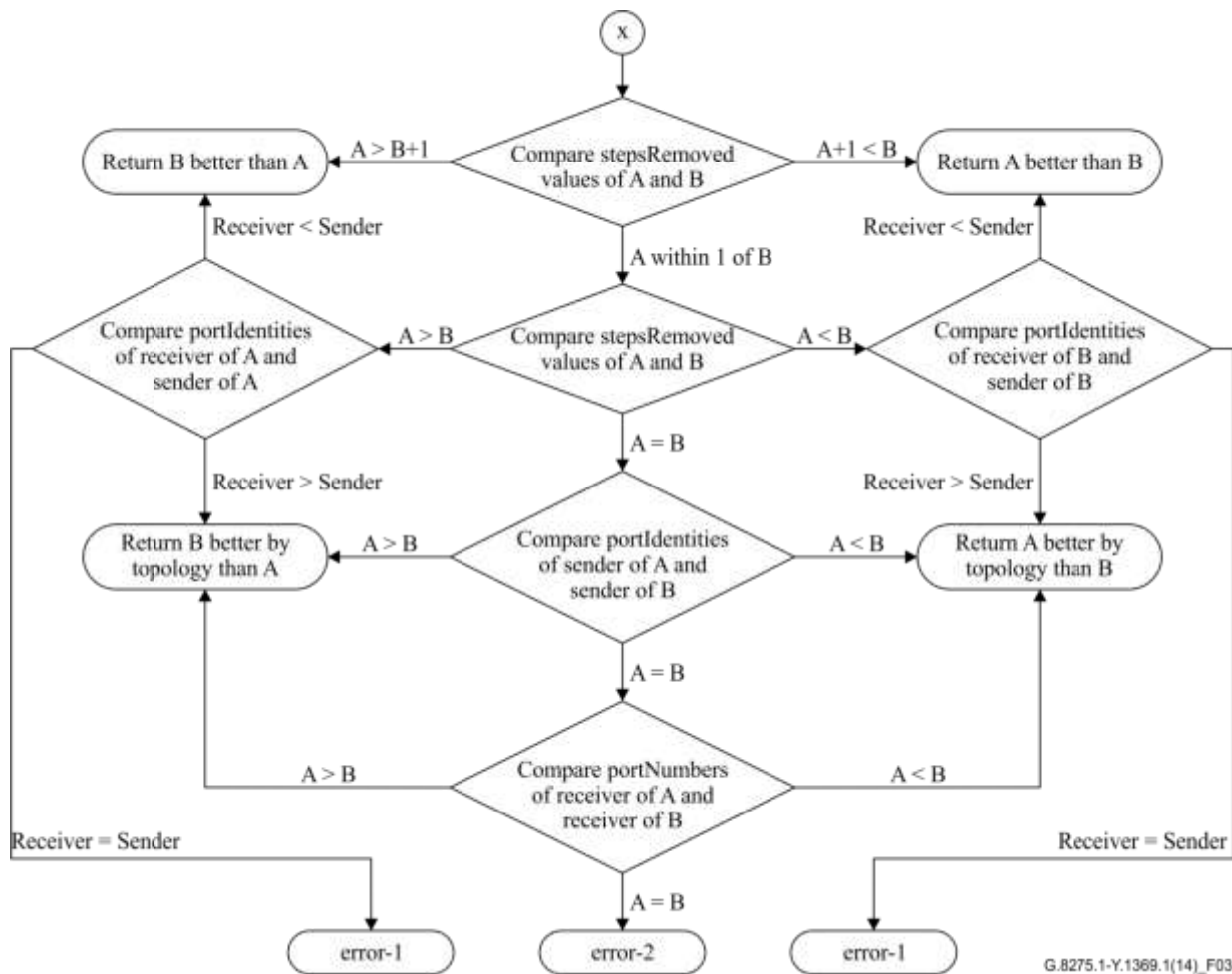

Figure 3 – Data set comparison algorithm, part 2, for Alternate [BMCABTCA](#)

### 6.3.8 Unused PTP fields

Some PTP fields are not used in this PTP profile. This clause defines the actions applicable to these unused PTP fields.

Table A.8 in clause A.10 of this Recommendation defines the PTP common header flag values, and whether or not each flag is used in this profile.

In addition, the following fields are not used in this profile:

- The "controlField" in the common header of PTP messages is not used in this profile. This field must be ignored by the receiver for all types of PTP messages;
- The "priority1" field in the *Announce* message is not used and must be set to a fixed value specified in clause 6.3.3.

When a PTP clock receives a PTP message with a field, whose use is not specified in this PTP profile, containing a value outside the allowed range, then this field of the PTP message must be ignored, without discarding the PTP message.

As an example, a PTP clock compliant with this PTP profile must ignore on reception the field value for the following fields. A clock compliant with this PTP profile must not update its local data sets with the ingress value for these fields:

- ~~flagField – alternateMasterFlag;~~
- ~~flagField – unicastFlag;~~
- flagField – PTP profile Specific 1;
- flagField – PTP profile Specific 2.

When a PTP clock receives a PTP message with a field, whose use is specified in this PTP profile, containing a value outside the allowed range for reception, then this entire PTP message must be discarded. The allowed range for a parameter on reception is the same as the range for the corresponding default dataset parameter, except for the attributes clockClass, clockAccuracy, offsetScaledLogVariance, and priority2 (see clauses 6.3.4 and 6.3.5).

As an example, a compliant clock must discard on reception the ingress packet (General and Event messages) when any of the following fields are outside of the allowed range for the profile:

- domainNumber;
- versionPTP.

The clock's local data set must not be updated with the ingress value.

NOTE 1 – If a clock receives an *Announce* message with the "priority1" field set to a value other than 128, and if the clock advertising this value is selected as the GM, then 128 must be re-advertised by the receiving clock. The unused attribute priority1 is ignored by the receiving clock for the purpose of the Alternate [BMCABTCA](#).

NOTE 2 – The allowed ranges for reception for the clock attributes priority2, clockClass, clockAccuracy, and offsetScaledLogVariance are the respective full [IEEE 1588] ranges, see clauses 6.3.4 and 6.3.5.

### 6.3.9 Packet timing signal fail

This clause is optional but, if implemented, it is necessary for the equipment to conform to the requirements contained herein. An implementation may support all, none, or a subset of these types of PTSF.

This clause defines the notion of packet timing signal fail (PTSF), which corresponds to a signal indicating a failure of the PTP packet timing signal received by a port.

The format used for PTSF notification is implementation-specific (e.g., event-based, state variable, etc.).

Three types of PTSF may be raised (and cleared) in a PTP clock:

- 1) PTSF-lossOfTimingMessages (short name PTSF-LOTM), lack of reception of PTP timing messages from a ~~master-peer port~~ (loss of the packet timing signal): as long as if the slave or passive port of a PTP clock no longer receives the expected ingress timing messages sent by a ~~master-peer PTP port~~ (i.e., Sync and subsequently Follow\_Up and Delay\_Resp messages when Delay\_Req messages are sent), then a PTSF-~~LOTM lossOfTimingMessages~~ associated with this ~~master-port~~ must occur. A timeout period for reception of Sync messages or Delay\_Resp messages (i.e., syncReceiptTimeout and delayRespReceiptTimeout) for these timing messages must be implemented in the PTP port before triggering the PTSF-~~LOTM lossOfTimingMessages~~ (the range and default value of these timeout parameters are defined in Table A.5).

The value of syncReceiptTimeout shall specify the number of Sync message intervals that have to pass without receipt of a Sync and, if the twoStep flag of the Sync message is TRUE, a Follow\_Up message before the triggering of the PTSF-lossOfTimingMessages ~~event~~.

The value of delayRespReceiptTimeout shall specify the number of Delay\_Req message intervals that have to pass without receipt of a Delay\_Resp message before the triggering of the PTSF-~~LOTM lossOfTimingMessages~~ event, if Delay\_Req messages are sent on the same port.

When the PTP port enters the UNCALIBRATED or PASSIVE state, or when port monitoring is enabled on this port as per Annex G or K, a timer-based mechanism should be activated to detect the potential loss and recovery of the expected ingress messages. PTSF-LOTM is therefore set when one or more type of expected messages is determined to be lost (as described above) and cleared if none of the expected messages are determined to be lost.

- 2) PTSF-unusable, unusable PTP packet timing signal received by the [timeReceiverSlave](#) or passive port of a PTP clock, exceeding the input tolerance of the PTP clock (noisy packet timing signal): as long as if the PTP packet timing signal is not usable for the PTP clock to achieve the performance target (e.g., excessive noise or abnormal PTP timestamps), then a PTSF-unusable associated with this [timeTransmitterMaster](#) must occur. The criteria used to determine that the packet timing signal is not suitable to be used or not are for further study.
- 3) PTSF-synchronizationUncertain (short name PTSF-SU): uncertain timing signal received by the [timeReceiverSlave](#) or passive port of a PTP clock, as long as if the synchronizationUncertain flag of an Announce message received from an upstream clock is TRUE, a PTSF-synchronizationUncertain associated with this [timeTransmitterMaster](#) must occur.

When the beginning or the end of a PTSF condition occurs, the clock may update set the PTP portDS.SF value to TRUE and generate a state decision event, which triggers the running of the alternate-Alternate BMCABTCA. As described in clause 6.3.7 a value of portDS.SF of TRUE can be used to exclude PTP ports from the alternate-Alternate BMCABTCA selection process. An implementation may set the PTP portDS.SF to TRUE for only a subset of PTSF listed above; that is, the implementation may set portDS.SF to TRUE for some PTSF and leave portDS.SF as FALSE for others. For example, when PTSF-synchroizationUncertain-SU is raised, if portDS.SF is not set to TRUE, then this would allow the PTP topology to be built as described in Annex D of [ITU-T G.8275].

NOTE 1 – See Appendix XIV for more discussion of deployments with transparent clocks.

NOTE 2 – Annex K includes an option for dynamic monitoring by a PTP port when its portDS.SF has been set to TRUE due to PTSF.

NOTE 3 – If a port reports the loss of Announce messages using the ANNOUNCE RECEIPT TIMEOUT event, then it may force portDS.SF to FALSE to avoid redundant alarms.

## 6.4 Phase/time traceability information

To deliver phase/time traceability information, the clockClass values described in Table 3 must be used in this PTP telecom profile. Additional information for interworking purposes is provided in Table 5.

When a PTP clock is synchronizing to an upstream PTP clock, the ~~The~~ frequencyTraceable flag present in the header of the PTP messages received from the parent clock on the [TimeReceiver](#) port is used to update the timePropertiesDS. The Announce PTP messages on the [TimeTransmitter](#) ports populate the frequencyTraceable flag based on the timePropertiesDS (see Note 3).

Otherwise, when the PTP clock is not synchronizing to an upstream PTP clock, so that the PTP clock timePropertiesDS is populated based on the status of the local clock, the frequencyTraceable flag present in the header of the Announce PTP messages on the [TimeTransmitter](#) ports is defined in this profile as follows: if the PTP clock

- is a T-GM that is traceable to a PRTC in locked mode or
- is a T-GM or a T-BC in holdover or free-run mode that has a timescale traceable to a primary reference clock (PRC),

then this parameter must be set to TRUE, otherwise it must be FALSE. This flag is not used in the Alternate [BMCABTCA](#) defined in clause 6.3; the values provided for this flag in Table 3 can be used by a network operator for monitoring purposes or by end applications to take definitive action as described in Appendix VIII.

When a T-GM first enters holdover, it downgrades the clockClass value that it uses to 7. It then calculates if the time error at its output is still within the holdover specification. When the T-GM determines that the time error at its output has exceeded the holdover specification, it downgrades the

clockClass value that it uses to 140, 150 or 160 depending on the quality of its frequency reference (internal oscillator or received physical layer frequency signal on an external interface).

When a T-BC first enters holdover, it downgrades the clockClass value that it uses to 135. It then calculates if the time error at its output is still within the holdover specification. When the T-BC determines that the time error at its output has exceeded the holdover specification, it downgrades the clockClass value that it uses to 165 (internal oscillator or received physical layer frequency signal on an external interface). The criteria, such as a configurable timer, a configurable time error threshold, or configurable immediate downgrade, that a T-BC uses to determine if its time error is still within the holdover specification, are for further study.

NOTE 1 – The applicable holdover specification depends on the design and budgeting of the synchronization network. See Appendix V of [ITU-T G.8271.1] for examples of network budgeting. A typical value for the holdover budget, described in the failure scenario (b) depicted in [ITU-T G.8271.1] Table V.1, when using the T-GM or T-BC for holdover while still meeting a total time error of 1.5 µs, is 400 ns.

NOTE 2 – When the term clockClass is used with respect to the property of the individual PTP clock (T-GM, T-BC, T-TSC) it is referring to data set member defaultDS.clockQuality.clockClass.

NOTE 3 – For the T-BC in locked mode, the traceability (including clockQuality) information of the currently selected best timeTransmittermaster clock will be passed to the downstream nodes, as per PTP. This means that the attributes and flags in the PTP header will always reflect the phase/time traceability (including clockQuality) information from the current parent clock, regardless of the frequency traceability of the T-BC's physical layer ~~clock~~. Failure scenarios including holdover are for further study.

**Table 3 – Applicable clockClass values**

<b>Phase/time traceability description</b>	<b>defaultDS. clockQuality. clockClass</b>	<b>frequencyTraceable flag</b>	<b>timeTraceable flag</b>
T-GM connected to a PRTC in locked mode (e.g., PRTC traceable to GNSS)	6	TRUE	TRUE
T-GM in holdover, within holdover specification, traceable to Category 1 frequency source (Note 1)	7	TRUE	TRUE
T-GM in holdover, within holdover specification, non-traceable to Category 1 frequency source (Note 1)	7	FALSE	TRUE
T-BC in holdover, within holdover specification, traceable to Category 1 frequency source (Note 1)	135	TRUE	TRUE
T-BC in holdover, within holdover specification, non-traceable to Category 1 frequency source (Note 1)	135	FALSE	TRUE
T-GM in holdover, out of holdover specification, traceable to Category 1 frequency source (Note 1)	140	TRUE	FALSE
T-GM in holdover, out of holdover specification, traceable to Category 2 frequency source (Note 1)	150	FALSE	FALSE
T-GM in holdover, out of holdover specification, traceable to Category 3 frequency source (Note 1)	160	FALSE	FALSE
T-BC in holdover, out of holdover specification (Note 1)	165	(Note 2)	FALSE



**Table 3 – Applicable clockClass values**

T-GM or T-BC in free-run mode	248	(Note 2)	FALSE
<u>TimeReceiver Slave</u> only OC (does not send <i>Announce</i> messages)	255	(Note 2)	As per PTP

NOTE 1 – The holdover specification threshold controlling the time spent advertising clockClass values 7 or 135 could be set to zero so that the T-GM or T-BC would advertise a degraded clockClass value directly after losing traceability to a PRTC. In this case, initially after advertising clockClass values 140, 150, 160, or 165, a clock may still be within the holdover specification.

NOTE 2 – The frequencyTraceable flag may be TRUE or FALSE, depending on the availability of a PRC-traceable physical layer frequency input signal.

NOTE 3 – As an option, the clockClass range of a T-BC can be extended from (135, 165, 248) to (135, 140, 150, 160, 165, 248) for some cases, where (a) 140, 150, 160, and 165 are related to the quality of the frequency reference, (b) the applicable circumstances of 140, 150, and 160 are the same as for the T-GM, and (c) 165 corresponds to synchronous Ethernet equipment clock (EEC) or the OTN equipment clock (OEC). Details are in Appendix X. If this option is used, then in a single PTP domain, all PTP clocks should implement this option (and should not be intermixed with clocks that do not implement this option). Details are for further study.

NOTE 4 – The term "holdover" in this table refers to "time holdover".

NOTE 5 – Refer to Appendix VII for more information about the behaviour of a T-BC that was previously synchronizing to a T-GM or a T-BC that is advertising 'within holdover specification', 'out of holdover specification', or 'free-run mode'.

NOTE 6 – A T-BC that is locked to a PRTC through virtual PTP port (refer to Figure II.1 in [ITU-T G.8275], Appendix II) and meets the holdover performance requirements of a T-GM, may follow the clockClass assignments of a T-GM if the T-BC enters holdover (a) due to the loss of the connectivity to that PRTC, and (b) no other PTP source is available.

NOTE 7 – Refer to Appendix XVI for more information on use-cases and the use of clockClass and priority2.

Table 4 describes how the clock quality levels (QLs) defined in [ITU-T G.781] are mapped to Category 1, 2 and 3 frequency sources used in Table 3.

**Table 4 – Mapping of [ITU-T G.781] clock QLs to Category 1, 2, 3 frequency sources**

Category (in Table 3 and 5)	ITU-T G.781 option I QLs	ITU-T G.781 option II QLs
Category 1 frequency source	QL-ePRTC, QL-PRTC, QL-ePRC, QL-PRC	QL-ePRTC, QL-PRTC, QL-ePRC, QL-PRS
Category 2 frequency source	QL-SSU-A	QL-ST2
Category 3 frequency source	QL-SSU-B	QL-ST3E

NOTE – Other frequency source categories, while not used in Table 3, are possible. An example is a category containing QL-EEC1 and QL-EEC2.

NOTE 4 – The case of a T-BC acting as a GM, with an external phase/time input coming from a PRTC, is handled by means of a virtual PTP port with associated  $E_{\text{rbest}}$  attributes as described in Annex C of this Recommendation. The general case of a T-BC with a phase/time external synchronization input different from PRTC is for further study.

Table 5 presents a subset of the clockClass values of Table 3 based on the quality of the frequency reference, and the mapping of the corresponding values used by some equipment deployed prior to this Recommendation.

NOTE 5 – When interoperability with equipment deployed prior to this Recommendation is needed, both sets of clockClass values would need to be supported. Other aspects may be required for full interoperability.

**Table 5 – clockClass values for equipment deployed prior to this Recommendation**

Phase/time traceability description	Values defined in Table 3	Values prior to this Rec.
T-GM connected to a PRTC in locked mode (e.g., PRTC traceable to GNSS)	6	6
T-GM in holdover, out of holdover specification, traceable to Category 1 frequency source (Note 1)	140	7
T-GM in holdover, out of holdover specification, traceable to Category 2 frequency source (Note 1)	150	(Note 2)
T-GM in holdover, out of holdover specification, traceable to Category 3 frequency source (Note 1)	160	52
T-BC in holdover, out of holdover specification, using unspecified frequency source (Note 1)	165	187
<u>TimeReceiverSlave</u> only OC (does not send <i>Announce</i> messages)	255	255
NOTE 1 – Initially after advertising clockClass values greater than 6, a clock may still be within the holdover specification. NOTE 2 – Refer to the applicable value specified for the equipment. NOTE 3 – The term "holdover" in this table refers to "time holdover".		

## 7 ITU-T PTP profile for phase/time distribution with full timing support from the network

The PTP profile for phase/time distribution with full timing support from the network is contained in Annex A.

## 8 Security aspects

For further study.

## Annex A

### ITU-T PTP profile for phase/time distribution with full timing support from the network

(This annex forms an integral part of this Recommendation.)

This annex contains the PTP telecom profile for phase/time distribution with full timing support from the network, as required by [IEEE 1588]. In order to claim compliance with this PTP telecom profile, the requirements in this annex and in the body of this Recommendation must both be met.

#### A.1 Profile identification

profileName: ITU-T PTP profile for phase/time distribution with full timing support from the network

profileVersion: 2.4-6 (for an implementation based on IEEE Std 1588-2008 [IEEE 1588-2008])

profileVersion: 2.5-7 (for an implementation based on IEEE Std 1588-2019 [IEEE 1588-2019])

profileIdentifier: 00-19-A7-01-02-04-06 (for an implementation based on IEEE Std 1588-2008 [IEEE 1588-2008])

profileIdentifier: 00-19-A7-01-02-07-5 (for an implementation based on IEEE Std 1588-2019 [IEEE 1588-2019])

See clause A.11 for details of compatibility between profile versions.

This profile is specified by ITU-T.

A copy may be obtained from [www.itu.int](http://www.itu.int).

#### A.2 PTP attribute values

The default values and ranges of the PTP attributes for use in this profile are contained in Tables A.1, A.2, A.3, A.4, A.5, A.6 and A.7. For the attributes clockClass, clockAccuracy, offsetScaledLogVariance, and priority2, the ranges shown are those for the defaultDS.

NOTE 1 – A boundary clock follows the rules of [IEEE 1588] for selection of parent clock, updating of parentDS, and transmission of Announce messages, so it may transmit values different from the defaultDS values.

Attributes not specified by this profile must use the default initialization values and ranges defined in [IEEE 1588].

These tables provide a default initialization value and range for each data set member for:

- Telecom grandmaster: ordinary clock or boundary clock that can only act as a GM (T-GM according to [ITU-T G.8275] – first PTP clock of the chain);
- Telecom ~~time slave clock~~ time synchronous clock: ordinary clock with a clockClass = 255 (T-TSC according to [ITU-T G.8275] – last PTP clock of the chain);
- Telecom boundary clock: boundary clock that may or may not be a GM; such a clock will be a GM if it is the best clock in the network (T-BC according to [ITU-T G.8275] – intermediate PTP clocks of the chain);
- Telecom transparent clock: end-to-end transparent clock (T-TC according to [ITU-T G.8275] – intermediate PTP clock of the chain).

The mapping between these PTP clockTypes and the phase/time clocks defined in the [ITU-T G.8275] architecture is described in Table 1, clause 6.2.3.

The attributes defined in Tables A.6 and A.7 are only required for implementations based on [IEEE 1588-2008]; they have been deprecated in [IEEE 1588-2019]. For implementations based on [IEEE 1588-2008], these transparent clock datasets are not used for telecom grandmasters, telecom ~~time slave clock~~ time synchronous clocks and telecom boundary clocks. For implementations based on [IEEE 1588-2008], they are mandatory for telecom transparent clocks. For implementations based on [IEEE 1588-2019], these transparent clock datasets are optional.

NOTE 2 – A feature that is deprecated by [IEEE 1588], is no longer recommended or required.

Some attributes in these tables are associated with optional features of this Recommendation. Therefore, these attributes are also optional, unless the associated feature is implemented, in which case these attributes must be supported.

Unless explicitly documented within these tables, the data type of a dataset member is as per PTP.

**Table A.1 – defaultDS data set member specifications**

[IEEE 1588-2008]		[IEEE 1588-2019]		Members of the data set	Telecom grandmaster requirements		Telecom <del>time slave clock</del> <u>time synchronous clock</u> requirements		Telecom boundary clock requirements	
Clause	Data type	Clause	Data type		Default initialization value (Note 5)	Range	Default initialization value (Note 5)	Range	Default initialization value (Note 5)	Range
8.2.1.2.1	As per PTP	(Note 3)	(Note 3)	defaultDS.twoStepFlag (static)	As per PTP	{FALSE, TRUE}	As per PTP	{FALSE, TRUE}	As per PTP	{FALSE, TRUE}
8.2.1.2.2	As per PTP	8.2.1.2.2	As per PTP	defaultDS.clockIdentity (static) (Note 2)	As per PTP	As per PTP	As per PTP	As per PTP	As per PTP	As per PTP
8.2.1.2.3	As per PTP	8.2.1.2.3	As per PTP	defaultDS.numberPorts (dynamic) (Note 2)	1 for OC As per PTP for BC	{1} for OC As per PTP for BC	1	{1}	As per PTP	As per PTP
8.2.1.3.1.1	As per PTP	8.2.1.3.1.2	As per PTP	defaultDS.clockQuality.clockClass (dynamic)	248	{6, 7, 140, 150, 160, 248}	255	{255}	248	{135, 165, 248}
8.2.1.3.1.2	As per PTP	8.2.1.3.1.3	As per PTP	defaultDS.clockQuality.clockAccuracy (dynamic)	0xFE	As per PTP (Note 1)	0xFE	{0xFE}	0xFE	{0xFE}
8.2.1.3.1.3	As per PTP	8.2.1.3.1.4	As per PTP	defaultDS.clockQuality.offsetScaledLogVariance (dynamic)	0xFFFF	As per PTP (Note 1)	0xFFFF	{0xFFFF}	0xFFFF	{0xFFFF}
8.2.1.4.1	As per PTP	8.2.1.4.1	As per PTP	defaultDS.priority1 (configurable)	128	{128}	128	{128}	128	{128}
8.2.1.4.2	As per PTP	8.2.1.4.2	As per PTP	defaultDS.priority2 (configurable)	128	{0-255}	255	{255}	128	{0-255}
8.2.1.4.3	As per PTP	8.2.1.4.3	As per PTP	defaultDS.domainNumber (configurable) (Note 2)	24	{24-43}	24	{24-43}	24	{24-43}
8.2.1.4.4	As per PTP	8.2.1.4.4	As per PTP	defaultDS.slaveOnlyTimeReceiverOnly (configurable)	FALSE	{FALSE}	TRUE	{TRUE}	FALSE	{FALSE}

**Table A.1 – defaultDS data set member specifications**

[IEEE 1588-2008]		[IEEE 1588-2019]		Members of the data set	Telecom grandmaster requirements		Telecom <del>time slave</del> <u>time synchronous</u> clock requirements		Telecom boundary clock requirements	
Clause	Data type	Clause	Data type		Default initialization value (Note 5)	Range	Default initialization value (Note 5)	Range	Default initialization value (Note 5)	Range
(Note 4)	As per PTP	8.2.1.4.5	As per PTP	defaultDS.sdoId (configurable) (Note 2)	0x000	0x000	0x000	0x000	0x000	0x000
New member	UInteger8	New member	UInteger8	defaultDS.localPriority (configurable)	128	{1-255}	128	{1-255}	128	{1-255}
New member	UInteger8	8.2.1.5.4	As per PTP	defaultDS.maxStepsRemoved (configurable)	255	{2-255}	255	{2-255}	255	{2-255}
New member	Enumeration8	New member	Enumeration8	defaultDS.deviceType (configurable)	(Note 6) (Note 8)	(Note 6) (Note 8)	(Note 6) (Note 8)	(Note 6) (Note 8)	(Note 6) (Note 8)	(Note 6) (Note 8)
New member	Octet[6]	New member	Octet[6]	defaultDS.profileIdentifier (configurable)	(Note 7)	(Note 7)	(Note 7)	(Note 7)	(Note 7)	(Note 7)
New member	Boolean	8.2.1.5.2	As per PTP	defaultDS.instanceEnable (configurable)	As per PTP	{FALSE, TRUE}	As per PTP	{FALSE, TRUE}	As per PTP	{FALSE, TRUE}

NOTE 1 - Examples of applicable values are shown in clause 6.3.5. Additional values, not specified in clause 6.3.5, may be applicable to future use cases. These additional values are for further study.

NOTE 2 - Applicable also to T-TC in case of an [IEEE 1588-2019] based implementation.

NOTE 3 – In case of [IEEE 1588-2019] based implementations this data set member is deprecated.

NOTE 4 – Applicable to [IEEE 1588-2019] based implementations; this data set member does not exist in [IEEE 1588-2008].

NOTE 5 – If a default value is not provided by this Recommendation, then it is implementation specific.

NOTE 6 – This attribute can be used to set the deviceType in use in the PTP clock instance. See clause 6.2.3.1 for more information and applicable values.

NOTE 7 – This dataset member is set according to the profileIdentifier specified in clause A.1

NOTE 8 – [IEEE-1588-2019] has defined a dataset member with a similar name (i.e., defaultDS.instanceType) that is used for a different purpose.

**Table A.2 – currentDS data set member specifications**

Clause from [IEEE 1588-2008]	Clause from [IEEE 1588-2019]	Members of the data set	Telecom grandmaster requirements		Telecom <del>time slave</del> <u>time synchronous</u> clock requirements		Telecom boundary clock requirements	
			Default initialization value (Note 3)	Range	Default initialization value (Note 3)	Range	Default initialization value (Note 3)	Range
8.2.2.2	8.2.2.2	currentDS.stepsRemoved (dynamic)	As per PTP	As per PTP	As per PTP	As per PTP	As per PTP	As per PTP
8.2.2.3	8.2.2.3	currentDS.offsetFromTimeTransmitMaster (dynamic)	As per PTP	As per PTP	As per PTP	As per PTP	As per PTP	As per PTP
8.2.2.4	(Note 1)	currentDS.meanPathDelay (dynamic)	As per PTP	As per PTP	As per PTP	As per PTP	As per PTP	As per PTP

**Table A.2 – currentDS data set member specifications**

Clause from [IEEE 1588-2008]	Clause from [IEEE 1588-2019]	Members of the data set	Telecom grandmaster requirements		Telecom <del>time slave</del> <u>time synchronous</u> clock requirements		Telecom boundary clock requirements	
			Default initialization value (Note 3)	Range	Default initialization value (Note 3)	Range	Default initialization value (Note 3)	Range
(Note 2)	8.2.2.4	currentDS.meanDelay (dynamic)	As per PTP	As per PTP	As per PTP	As per PTP	As per PTP	As per PTP

NOTE 1 – In case of [IEEE 1588-2019] based implementations this data set member is deprecated.  
 NOTE 2 – Applicable to [IEEE 1588-2019] based implementations; this data set member does not exist in [IEEE 1588-2008].  
 NOTE 3 – If a default value is not provided by this Recommendation, then it is implementation specific.

**Table A.3 – parentDS data set member specifications**

Clause from [IEEE 1588-2008]	Clause from [IEEE 1588-2019]	Members of the data set	Telecom grandmaster requirements		Telecom <del>time slave</del> <u>time synchronous</u> clock requirements		Telecom boundary clock requirements	
			Default initialization value (Note 2)	Range	Default initialization value (Note 2)	Range	Default initialization value (Note 2)	Range
8.2.3.2	8.2.3.2	parentDS.parentPortIdentity (dynamic)	As per PTP	As per PTP	As per PTP	As per PTP	As per PTP	As per PTP
8.2.3.3	8.2.3.3	parentDS.parentStats (dynamic)	(Note 1)	(Note 1)	(Note 1)	(Note 1)	(Note 1)	(Note 1)
8.2.3.4	8.2.3.4	parentDS.observedParentOffsetScaledLogVariance (dynamic)	(Note 1)	(Note 1)	(Note 1)	(Note 1)	(Note 1)	(Note 1)
8.2.3.5	8.2.3.5	parentDS.observedParentClockPhaseChangeRate (dynamic)	(Note 1)	(Note 1)	(Note 1)	(Note 1)	(Note)	(Note 1)
8.2.3.6	8.2.3.6	parentDS.grandmasterIdentity (dynamic)	As per PTP	As per PTP	As per PTP	As per PTP	As per PTP	As per PTP
8.2.3.7	8.2.3.7	parentDS.grandmasterClockQuality (dynamic)	As per PTP	As per PTP	As per PTP	As per PTP	As per PTP	As per PTP
8.2.3.8	8.2.3.8	parentDS.grandmasterPriority1 (dynamic)	As per PTP	As per PTP	As per PTP	As per PTP	As per PTP	As per PTP
8.2.3.9	8.2.3.9	parentDS.grandmasterPriority2 (dynamic)	As per PTP	As per PTP	As per PTP	As per PTP	As per PTP	As per PTP

NOTE 1 - It is not used in this profile, and therefore equipment is not required to support it.  
 NOTE 2 – If a default value is not provided by this Recommendation, then it is implementation specific.

**Table A.4 – timePropertiesDS data set member specifications**

Clause from [IEEE 1588-2008]	Clause from [IEEE 1588-2019]	Members of the data set	Telecom grandmaster requirements		Telecom <u>time slave clock</u> <u>time synchronous clock</u> requirements		Telecom boundary clock requirements	
			Default initialization value (Note 2)	Range	Default initialization value (Note 2)	Range	Default initialization value (Note 2)	Range
8.2.4.2	8.2.4.2	timePropertiesDS.currentUtcOffset (dynamic)	As per PTP	As per PTP	As per PTP	As per PTP	As per PTP	As per PTP
8.2.4.3	8.2.4.3	timePropertiesDS.currentUtcOffsetValid (dynamic)	FALSE	{FALSE, TRUE}	FALSE	{FALSE, TRUE}	FALSE	{FALSE, TRUE}
8.2.4.4	8.2.4.4	timePropertiesDS.leap59 (dynamic)	FALSE	{FALSE, TRUE}	FALSE	{FALSE, TRUE}	FALSE	{FALSE, TRUE}
8.2.4.5	8.2.4.5	timePropertiesDS.leap61 (dynamic)	FALSE	{FALSE, TRUE}	FALSE	{FALSE, TRUE}	FALSE	{FALSE, TRUE}
8.2.4.6	8.2.4.6	timePropertiesDS.timeTraceable (dynamic)	FALSE	{FALSE, TRUE}	FALSE	{FALSE, TRUE}	FALSE	{FALSE, TRUE}
8.2.4.7	8.2.4.7	timePropertiesDS.frequencyTraceable (dynamic)	FALSE	{FALSE, TRUE} (Note 1)	FALSE	{FALSE, TRUE} (Note 1)	FALSE	{FALSE, TRUE} (Note 1)
8.2.4.8	8.2.4.8	timePropertiesDS.ptpTimescale (dynamic)	TRUE	{TRUE}	TRUE	{TRUE}	TRUE	{TRUE}
8.2.4.9	8.2.4.9	timePropertiesDS.timeSource (dynamic)	0xA0	As per PTP	0xA0	As per PTP	0xA0	As per PTP

NOTE 1 - Refer to clause 6.4 for details on when each value applies.  
 NOTE 2 – If a default value is not provided by this Recommendation, then it is implementation specific.

**Table A.5 – portDS data set member specifications**

[IEEE 1588-2008]		[IEEE 1588-2019]		Members of the data set	<u>TimeTransmitterMaster</u> port requirements of telecom grandmaster		<u>TimeReceiverSlave</u> port requirements of telecom <u>time slave clock</u> <u>time synchronous clock</u>		Telecom boundary clock requirements	
Clause	Data type	Clause	Data type		Default initialization value (Note 7)	Range	Default initialization value (Note 7)	Range	Default initialization value (Note 7)	Range
8.2.5.2.1	As per PTP	8.2.15.2.1	As per PTP	portDS.portIdentity.clockIdentity (static) (Note 3)	As per PTP	As per PTP	As per PTP	As per PTP	As per PTP	As per PTP

**Table A.5 – portDS data set member specifications**

[IEEE 1588-2008]		[IEEE 1588-2019]		Members of the data set	<u>TimeTransmitterMaster</u> port requirements of telecom grandmaster		<u>TimeReceiverSlave</u> port requirements of telecom <del>time slave clock</del> <u>time synchronous clock</u>		Telecom boundary clock requirements	
Clause	Data type	Clause	Data type		Default initialization value (Note 7)	Range	Default initialization value (Note 7)	Range	Default initialization value (Note 7)	Range
8.2.5.2.1	As per PTP	8.2.15.2.1	As per PTP	portDS.portIdentity.portNumber (static) (Note 3)	1 for OC As per PTP for BC	{1} for OC As per PTP for BC	1	{1}	As per PTP	As per PTP
8.2.5.3.1	As per PTP	8.2.15.3.1	As per PTP	portDS.portState (dynamic)	As per PTP	As per PTP	As per PTP	As per PTP	As per PTP	As per PTP
8.2.5.3.2	As per PTP	8.2.15.3.2	As per PTP	portDS.logMinDelayReqInterval (dynamic) (Note 3)	-4	{-4}	-4	{-4}	-4	{-4}
8.2.5.3.3	As per PTP	(Note 4)	(Note 4)	portDS.peerMeanPathDelay (dynamic)	(Note 1)	(Note 1)	(Note 1)	(Note 1)	(Note 1)	(Note 1)
(Note 5)	(Note 5)	8.2.15.3.3	As per PTP	portDS.meanLinkDelay	(Note 1)	(Note 1)	(Note 1)	(Note 1)	(Note 1)	(Note 1)
8.2.5.4.1	As per PTP	8.2.15.4.1	As per PTP	portDS.logAnnounceInterval (configurable)	-3	{-3}	-3 (Note 2)	{-3} (Note 2)	-3	{-3}
8.2.5.4.2	As per PTP	8.2.15.4.2	As per PTP	portDS.announceReceiptTimeout (configurable)	3	{3 – z} z is FFS	3	{3 – z} z is FFS	3	{3 – z} z is FFS
8.2.5.4.3	As per PTP	8.2.15.4.3	As per PTP	portDS.logSyncInterval (configurable)	-4	{-4}	-4 (Note 2)	{-4} (Note 2)	-4	{-4}
8.2.5.4.4	As per PTP	8.2.15.4.4	As per PTP	portDS.delayMechanism (configurable)	01	{01}	01	{01}	01	{01}
8.2.5.4.5	As per PTP	8.2.15.4.5	As per PTP	portDS.logMinPdelayReqInterval (configurable)	(Note 1)	(Note 1)	(Note 1)	(Note 1)	(Note 1)	(Note 1)
8.2.5.4.6	As per PTP	8.2.15.4.6	As per PTP	portDS.versionNumber (configurable)	2	{2}	2	{2}	2	{2}
(Note 5)	(Note 5)	8.2.15.4.7	As per PTP	portDS.minorVersionNumber (configurable) (Note 3)	1	{1}	1	{1}	1	{1}



Table A.5 – portDS data set member specifications

[IEEE 1588-2008]		[IEEE 1588-2019]		Members of the data set	<del>TimeTransmitterMaster</del> port requirements of telecom grandmaster		TimeReceiverSlave port requirements of telecom <del>time slave clock</del> time synchronous clock		Telecom boundary clock requirements	
Clause	Data type	Clause	Data type		Default initialization value (Note 7)	Range	Default initialization value (Note 7)	Range	Default initialization value (Note 7)	Range
(Note 5)	(Note 5)	8.2.15.4.8	As per PTP	portDS.delayAsymmetry (configurable) (Note 3)	NA	NA	As per PTP	As per PTP	As per PTP	As per PTP
New member	Boolean	9.2.2.2	As per PTP	portDS. <del>masterOnlyTTOnly</del> (configurable) (Note 6)	TRUE	{TRUE, FALSE}	FALSE	{FALSE}	TRUE	{TRUE, FALSE}
New member	UInteger8	New member	UInteger8	portDS.localPriority (configurable)	128	{1-255}	128	{1-255}	128	{1-255}
New member	UInteger16	New member	UInteger16	portDS.syncReceiptTimeout (configurable)	NA	NA	FFS	FFS	FFS	FFS
New member	UInteger16	New member	UInteger16	portDS.delayRespReceiptTimeout (configurable)	NA	NA	FFS	FFS	FFS	FFS
New member	Boolean	New member	Boolean	portDS.SF (dynamic)	FALSE	{FALSE}	FALSE	{TRUE, FALSE}	FALSE	{TRUE, FALSE}
New member	Boolean	New member	Boolean	portDS. <del>notMasternotTT</del> (configurable) (Note 6)	FALSE	{TRUE, FALSE}	FALSE	{TRUE, FALSE}	FALSE	{TRUE, FALSE}
New member	Boolean	New member	Boolean	portDS.monitorSender (configurable)	FALSE	{TRUE, FALSE}	FALSE	{TRUE, FALSE}	FALSE	{TRUE, FALSE}
New member	Boolean	New member	Boolean	portDS.monitorReceiver (configurable)	FALSE	{TRUE, FALSE}	FALSE	{TRUE, FALSE}	FALSE	{TRUE, FALSE}
<u>New member</u>	<u>Boolean</u>	<u>New member</u>	<u>Boolean</u>	<u>portDS.SF-LOTM (dynamic)</u>	<u>FALSE</u>	<u>{FALSE}</u>	<u>FALSE</u>	<u>{TRUE, FALSE}</u>	<u>FALSE</u>	<u>{TRUE, FALSE}</u>
<u>New member</u>	<u>Boolean</u>	<u>New member</u>	<u>Boolean</u>	<u>portDS.SF-unusable (dynamic)</u>	<u>FALSE</u>	<u>{FALSE}</u>	<u>FALSE</u>	<u>{TRUE, FALSE}</u>	<u>FALSE</u>	<u>{TRUE, FALSE}</u>
<u>New member</u>	<u>Boolean</u>	<u>New member</u>	<u>Boolean</u>	<u>portDS.SF-SU (dynamic)</u>	<u>FALSE</u>	<u>{FALSE}</u>	<u>FALSE</u>	<u>{TRUE, FALSE}</u>	<u>FALSE</u>	<u>{TRUE, FALSE}</u>
<u>New member</u>	<u>Boolean</u>	8.2.15.5.1	As per PTP	<u>portDS.portEnable (configurable)</u>	<u>As per PTP</u>	<u>{FALSE, TRUE}</u>	<u>As per PTP</u>	<u>{FALSE, TRUE}</u>	<u>As per PTP</u>	<u>{FALSE, TRUE}</u>

NOTE 1 - It is not used in this profile, and therefore equipment is not required to support it.  
NOTE 2 - This type of message is not sent by a ~~slave-only~~timeReceiver-only OC.

**Table A.5 – portDS data set member specifications**

[IEEE 1588-2008]		[IEEE 1588-2019]		Members of the data set	<del>TimeTransmitterMaster</del> port requirements of telecom grandmaster		TimeReceiverSlave port requirements of telecom <del>time slave clock</del> time synchronous clock		Telecom boundary clock requirements	
Clause	Data type	Clause	Data type		Default initialization value (Note 7)	Range	Default initialization value (Note 7)	Range	Default initialization value (Note 7)	Range
<p>NOTE 3 - Applicable also to T-TC in case of an [IEEE 1588-2019] based implementation.</p> <p>NOTE 4 – In case of [IEEE 1588-2019] based implementations this data set member is deprecated.</p> <p>NOTE 5 – Applicable to [IEEE 1588-2019] based implementations; this data set member does not exist in [IEEE 1588-2008].</p> <p>NOTE 6 – Setting both <a href="#">portDS.TTOnly</a> (short name for <a href="#">portDS.masterOnlyTimeTransmitterOnly</a>) and <a href="#">portDS.notTT</a> (short name for <a href="#">portDS.notMasterNotTimeTransmitter</a>) with value TRUE concurrently is not permitted.</p> <p>NOTE 7 – If a default value is not provided by this Recommendation, then it is implementation specific.</p>										

**Table A.6 – transparentClockDefaultDS data set member specifications**

Clause from [IEEE 1588-2008]	Members of the data set	Telecom transparent clock requirements	
		Default initialization value (Note)	Range
8.3.2.2.1	transparentClockDefaultDS.clockIdentity (static)	As per PTP	As per PTP
8.3.2.2.2	transparentClockDefaultDS.numberPorts (dynamic)	As per PTP for TC	As per PTP for TC
8.3.2.3.1	transparentClockDefaultDS.delayMechanism (configurable)	01	{01}
8.3.2.3.2	transparentClockDefaultDS.primaryDomain (configurable)	24	{24-43}

NOTE – If a default value is not provided by this Recommendation, then it is implementation specific.

NOTE – According to [IEEE 1588-2019], the transparent clock data set members used in [IEEE 1588-2008] are deprecated. The relevant dataset members of a PTP instance should apply instead (see Tables A.1 and A.5).

**Table A.7 – transparentClockPortDS data set member specifications**

Clause from [IEEE 1588-2008]	Members of the data set	Telecom transparent clock requirements	
		Default initialization value (Note 2)	Range
8.3.3.2.1	transparentClockPortDS.portIdentity (static)	As per PTP	As per PTP
8.3.3.3.1	transparentClockPortDS.logMinPdelayReqInterval (dynamic)	(Note 1)	(Note 1)
8.3.3.3.2	transparentClockPortDS.faultyFlag (dynamic)	FALSE	{FALSE, TRUE}
8.3.3.3.3	transparentClockPortDS.peerMeanPathDelay (dynamic)	(Note 1)	(Note 1)

NOTE 1 – It is not used in this profile, and therefore equipment is not required to support it.

NOTE 2 – If a default value is not provided by this Recommendation, then it is implementation specific

NOTE – According to [IEEE 1588-2019], the transparent clock data set members used in [IEEE 1588-2008] are deprecated. The relevant dataset members of a PTP instance should apply instead (see Tables A.1 and A.5).

### **A.3 PTP options**

#### **A.3.1 Node types required, permitted, or prohibited**

In this profile, the permitted node types are: ordinary clocks, boundary clocks and end-to-end transparent clocks.

In this profile, the prohibited node types are: peer-to-peer transparent clocks.

#### **A.3.2 One-step versus two-step clock mode**

Both one-step and two-step clocks are permitted. A clock must be capable of receiving and handling messages transmitted from both one-step and two-step clocks. A clock is not required to support both one-step and two-step mode for transmitting messages.

#### **A.3.3 Transport mechanisms required, permitted, or prohibited**

In this profile, the allowed transport mechanisms are:

- a) IEEE 802.3/Ethernet, as per Annex F of [IEEE 1588-2008] or Annex E of [IEEE 1588-2019];
- b) OTN via: (i) GFP-F encapsulation as per [ITU-T G.7041], and insertion of the GFP-F frames into the OTUk OSMC as per clause 15.7.2.4 of [ITU-T G.709] or into the FlexO OSMC as per clause 9.2.10.1 of [ITU-T G.709.1], or (ii) the OSC OSMC as per clause 14.1 of [ITU-T G.709], where in this case the encapsulation is vendor-specific;
- c) MTN, with PTP in Ethernet frames transported per clause 9.2.5 of [ITU-T G.8312];
- d) FlexE links, with PTP in Ethernet frames transported per clause 7.3.5 of [OIF FlexE IA].

At least one of the four transport mechanisms must be supported. For transport over IEEE 802.3/Ethernet, both the non-forwardable multicast address, 01-80-C2-00-00-0E, and the forwardable multicast address, 01-1B-19-00-00-00, are required to be supported for compliance with this profile.

All other transport mechanisms are for further study within the scope of this profile.

#### **A.3.4 Unicast messages**

All messages are sent multicast, using one of the two multicast addresses in clause A.3.3. The unicast mode is not permitted in this version of the profile.

### **A.4 Best ~~timeTransmittermaster~~ clock algorithm options**

This profile uses the Alternate [BMCABTCA](#) described in clause 6.3.

#### **A.5 Path delay measurement option (delay request/delay response)**

The delay request/delay response mechanism is used in this profile. The peer delay mechanism must not be used in this profile.

#### **A.6 Clock identity format**

For implementations based on [IEEE 1588-2008], the procedures to use an EUI-48 to create the EUI-64 clockIdentity as described in clause 7.5.2.2.2 of [IEEE 1588-2008] are no longer recommended. If a clockIdentity is formed by mapping an EUI-48 to an EUI-64, and if the EUI-48 was assigned from an MA-M or MA-S, it is possible that the clockIdentity will be a duplicate of a clockIdentity formed directly from a different MA-M or MA-S (i.e., by appending bits to the end of that different MA-M or MA-S). Only if the EUI-48 was formed from an OUI (MA-L), is the uniqueness ensured. For new implementations based on [IEEE 1588-2008], the clockIdentity shall be

constructed as per clause 7.5.2.2.2 of [IEEE 1588-2019]. Non-IEEE clockIdentity formats are not supported.

For implementations based on [IEEE 1588-2019], the clockIdentity shall be constructed as per clause 7.5.2.2.2 of [IEEE 1588-2019].

### **A.7 Configuration management options**

Management aspects are for further study and will be specified in a future version of this profile.

### **A.8 Security aspects**

Security aspects are for further study.

### **A.9 Other optional features of [IEEE 1588]**

Other optional features of [IEEE 1588] are not used in this version of the profile.

For implementations based on [IEEE 1588-2008] these include unicast message negotiation (clause 16.1 of [IEEE 1588-2008]), alternate timescales (clause 16.3 of [IEEE 1588-2008]), grandmaster clusters (clause 17.3 of [IEEE 1588-2008]), unicast discovery (clause 17.5 of [IEEE 1588-2008]), acceptable timeTransmittermaster table (clause 17.6 of [IEEE 1588-2008]), and the experimental cumulative frequency scale factor offset (Annex L of [IEEE 1588-2008]).

For implementations based on [IEEE 1588-2019] these include unicast message negotiation (clause 16.1 of [IEEE 1588-2019]), alternate timescale offsets (clause 16.3 of [IEEE 1588-2019]), grandmaster clusters (clause 17.2 of [IEEE 1588-2019]), unicast discovery (clause 17.4 of [IEEE 1588-2019]), acceptable timeTransmittermaster table (clause 17.5 of [IEEE 1588-2019]), and the Cumulative frequency transfer method for synchronizing clocks (clause 16.10 of [IEEE 1588-2019]).

Some aspects of the optional feature of alternate timeTransmittermaster are used by optional Annexes G and K of this Recommendation.

### **A.10 PTP common header flags**

The PTP common header flag values, and whether or not each flag is used in this profile, are given in Table A.8.

NOTE – Some of these flags are used only in certain PTP messages, and not in all the PTP messages, see [IEEE 1588-2008] clause 13.3.2.6 or [IEEE 1588-2019] clause 13.3.2.8.

For implementations based on [IEEE 1588-2008] the following rule defined in [IEEE 1588-2008] clause 13.3.2.6, must be respected: "For message types where the bit is not defined in Table 20, the values shall be FALSE."

For implementations based on [IEEE 1588-2019] the following rule defined in [IEEE 1588-2019] clause 13.3.2.8, must be respected: "For message types where the bit is not defined in Table 37, the values shall be FALSE."

**Table A.8 – PTP flags**

Octet	Bit	Flag	Value to be sent	Behaviour for the receiving node
0	0	<del>alternateMaster</del> <del>alternateTimeTr</del> <del>ansmitter</del> Flag	<del>FALSE</del> (Note 7)	As per PTP
0	1	twoStepFlag	As per PTP	Used
0	2	unicastFlag	FALSE	Flag is ignored
0	5	PTP profile Specific 1	FALSE	Flag is ignored
0	6	PTP profile Specific 2	FALSE	Flag is ignored
0	7	Reserved	FALSE	Reserved by PTP and flag is ignored
1	0	leap61	As per PTP (Note 2)	Used
1	1	leap59	As per PTP (Note 2)	Used
1	2	currentUtcOffsetValid	As per PTP (Note 3)	Used (Notes 3, 4, 5, 6)
1	3	ptpTimescale	TRUE	Used
1	4	timeTraceable	See Table 3	Used
1	5	frequencyTraceable	See Table 3	Used
1	6	(Note 1)	(Note 1)	(Note 1)

NOTE 1 – An additional flag "synchronizationUncertain" has been defined in Annex E; the use of the "synchronizationUncertain" flag is optional.

NOTE 2 – When a clock is in holdover, within holdover specification, the PTP clock may continue to advertise the last known leap second event. If there was no pending leap second event, then the PTP clock continues to advertise FALSE for the pending leap second fields (leap59 and leap61). If there was a pending leap second event, the PTP clock may choose either to advertise FALSE for the pending leap second fields immediately or to continue to advertise the leap second event. In the latter instance the PTP clock would clear the leap59 and leap61 second event field(s) and adjust the UTC offset field at the appropriate time based on its local PTP time (i.e., the local PTP time's UTC timescale rolling over at UTC midnight) if the PTP clock is still in holdover, within holdover specification. When a clock is in holdover, out of holdover specifications, the PTP clock behaviour with respect to leap second event is implementation specific. It is recommended that the PTP clock continue to advertise any upcoming leap second event as appropriate.

NOTE 3 – When a clock is in holdover, within holdover specification, the PTP clock may continue to advertise the last known UTC offset with UTC offset valid TRUE. If the last known UTC offset valid was FALSE, then the PTP clock continues to advertise FALSE. If the last known UTC offset valid was TRUE then the PTP clock may choose either to advertise UTC offset valid FALSE immediately (freezing the UTC offset value) or to continue to advertise the last known UTC offset with UTC offset valid TRUE. The UTC offset field may be updated as described in Note 2 above. When a clock is in holdover, out of holdover specifications, the PTP clock behaviour with respect to UTC offset is implementation specific.

NOTE 4 – Usage of currentUtcOffset from an Announce message, which indicates currentUtcOffsetValid as FALSE, may lead to wrong UTC time calculation.

NOTE 5 – The ~~alternate~~ Alternate ~~ABMCABTCA~~ in this profile does not consider or use currentUtcOffsetValid or currentUtcOffset.

NOTE 6 – The PTP clocks in this profile do not use currentUtcOffsetValid or currentUtcOffset for phase/time synchronization.

NOTE 7 – The ~~alternateTimeTransmitterFlag~~ shall be transmitted with the value of FALSE except for the cases specified in Annex G.

## A.11 Profile version compatibility

A specific profile version may have backward compatibility with earlier versions of this profile. Table A.9 lists which earlier versions are compatible with each version. Compatibility means that the nodes can operate in the same network provided optional features in a specific profile that are not present in the earlier version are not enabled.

**Table A.9 – profileVersion compatibility**

profileVersion	Base IEEE version	<u>Created in ITU-T G.8275.1 Edition (and date)</u>	Compatible with the earlier profileVersions
<a href="#">2.7</a>	<a href="#">[IEEE 1588-2019]</a>	<a href="#">v2022 Amd1 (mm/yyyy) Edition 4.1</a>	<a href="#">2.6, 2.5, 2.4, 2.3, 2.2, 2.1, 2.0, 1.0 (Note)</a>
<a href="#">2.6</a>	<a href="#">[IEEE 1588-2008]</a>	<a href="#">v2022 Amd1 (mm/yyyy) Edition 4.1</a>	<a href="#">2.4, 2.2, 2.1, 2.0, 1.0 (Note)</a>
2.5	<a href="#">[IEEE 1588-2019]</a>	<a href="#">v2022e(11/2022) Edition 4.0</a>	2.4, 2.3, 2.2, 2.1, 2.0, 1.0 (Note)
2.4	<a href="#">[IEEE 1588-2008]</a>	<a href="#">v2022 (11/2022) Edition 4.0</a>	2.2, 2.1, 2.0, 1.0 (Note)
2.3	<a href="#">[IEEE 1588-2019]</a>	<a href="#">v2020 Amd2 (06/2021) Edition 3.2</a>	2.2, 2.1, 2.0, 1.0 (Note)
2.2	<a href="#">[IEEE 1588-2008]</a>	<a href="#">v2020 Amd1 (11/2020) Edition 3.1</a>	2.1, 2.0, 1.0 (Note)
2.1	<a href="#">[IEEE 1588-2008]</a>	<a href="#">v2016 Amd1 (08/2017) Edition 2.1</a>	2.0, 1.0 (Note)
2.0	<a href="#">[IEEE 1588-2008]</a>	<a href="#">v2016 (06/2016) Edition 2.0</a>	1.0 (Note)
1.0	<a href="#">[IEEE 1588-2008]</a>	<a href="#">v2014 (07/2014) Edition 1.0</a>	

NOTE – Version 1 of this profile enforced a limited range of acceptable values for clockClass, clockAccuracy, offsetScaledLogVariance and, for the T-TSC, priority2. Reception of values outside of the acceptable range caused the Announce message to be discarded. Version 2.x of the profile supports the full range of these attributes as defined by PTP. In networks deploying ePRTCs, which use new values of clockAccuracy and offsetScaledLogVariance that are outside of the version 1 range, all clocks need to use version 2.x of the profile. If no ePRTCs are to be deployed in the network, then the network can operate with a mixture of version 1 and version 2.x clocks.

## A.12 Other optional features used in this profile

Annex F of [ITU-T G.8275] provides performance monitoring functionality that can be used in this profile.

## **Annex B**

### **Options to establish the PTP topology with the Alternate BMCABTCA**

(This annex forms an integral part of this Recommendation.)

Options to establish the PTP topology with the Alternate BMCABTCA are described in Annex C of [ITU-T G.8275].

## **Annex C**

### **Inclusion of an external phase/time input interface in a T-BC**

(This annex forms an integral part of this Recommendation.)

The model for inclusion of a unidirectional, external phase/time interface on a PTP clock is provided in Annex B of [ITU-T G.8275].



## **Annex D**

### **Path trace (optional)**

(This annex forms an integral part of this Recommendation.)

In order to track the actual path of the PTP synchronization reference in the network, the Path trace option as per clause 16.2 in [IEEE 1588] can be optionally supported by the PTP clock compliant with this profile.

This feature is optional; however, if it is supported it is necessary that it be supported as described below.

As an example, this option can be used to support troubleshooting analysis in case of failures in the network.

It should be possible to configure a PTP clock so that the Path trace type length value (TLV) is not further forwarded by that clock (e.g., this could be required at the network administration interfaces).

NOTE 1 – There might be cases when not all PTP clocks in the network support the Path trace TLV. The expected behaviour is that in the case of an incoming Announce message carrying the Path trace TLV, this TLV is dropped by these nodes.

NOTE 2 – T-TCs in the path could add their own clockIdentity in the Path trace TLV.

## **Annex E**

### **Synchronization uncertain indication (optional)**

(This annex forms an integral part of this Recommendation.)

The synchronization uncertain indication is described in Annex D of [ITU-T G.8275].

## Annex F

### Use of stepsRemoved to limit reference chain (optional)

(This annex forms an integral part of this Recommendation.)

The parameter stepsRemoved is defined in [IEEE 1588] is used to indicate the distance between a clock and the grandmaster clock in the network. It was originally intended to be used as a helpful tool to detect cyclic paths that may occur in PTP systems. By default, it is required that a clock not qualify any Announce messages where the stepsRemoved field is equal to, or greater than, 255 in order to ensure that rogue frames are extinguished.

This profile includes a default dataset member, maxStepsRemoved, that allows the operator to configure the value to less than 255. The value configured is typically the same in all clocks in the PTP domain. When configured, a clock would not qualify any Announce messages received where the stepsRemoved field in the ingress header matched or exceeded the maxStepsRemoved field. There would be two primary use cases for this configurability.

First, referring to [ITU-T G.8271.1] and [ITU-T G.8275] analysis has been performed to show that up to 20 clocks may be traversed between the grandmaster and [timeReceiverSlave](#) while maintaining the proper network performance. If the operator wanted to ensure the network performance limit was not exceeded, or that the chain length was not exceeded, the operator may configure the value smaller (such as 20 or 21).

Second, if the operator does deploy PTP in a ring topology, the operator may configure the maxStepsRemoved parameter to a smaller value so that the clocks may more quickly identify rogue frames and take corrective action to extinguish them and update the topology.

## Annex G

### Monitoring alternate timeTransmittermaster time information provided by a peer PTP port (optional)

(This annex forms an integral part of this Recommendation.)

This annex is optional but, if implemented, it is necessary for the equipment to conform to the requirements contained herein.

A PTP clock must synchronize only to a PTP port of its parent clock that is in the MASTERTIME\_TRANSMITTER state. The synchronization must be received on, and only on, the port of the PTP clock that is in the SLAVETIME\_RECEIVER state. However, in some instances it may be desirable for a PTP port to monitor a peer PTP port in a ~~non-traditional~~ situation, where the local PTP port is not in the SLAVETIME\_RECEIVER state and/or the peer PTP port is not in the MASTERTIME\_TRANSMITTER state.

The monitoring is enabled through the use of the portDS.monitorSender and portDS.monitorReceiver. A port with either portDS.monitorSender or portDS.monitorReceiver configured as TRUE will send and receive any messages required by its portDS.portState. When portDS.monitorSender is TRUE, and the portDS.portState is not MASTERTIME\_TRANSMITTER, the PTP port also sends Announce, Sync, Follow\_Up and Delay\_Resp messages with the alternateMasteralternateTimeTransmitterFlag set to TRUE. When portDS.monitorReceiver is TRUE, and the portDS.portState is not SLAVETIME\_RECEIVER, the PTP port also sends Delay\_Req messages with alternateMasteralternateTimeTransmitterFlag set to FALSE. The message rates specified in clause 6.2.8 should be used for these specific messages sent when either portDS.monitorSender or portDS.monitorReceiver is TRUE.

These messages may allow a PTP port to acquire knowledge of the characteristics of the transmission path: typically by estimating the Time Error on this port (i.e., the time difference between the local PTP clock using the TIME\_RECEIVER port and the peer PTP clock connected via this port).

If the time error of the monitored port exceeds a threshold, this PTP clock may generate an alarm, which means that a fibre asymmetry, or a clock failure could be present in this PTP network. Note this alarm is just used for PTP monitoring and should not trigger the Alternate BTCA. Additionally, the threshold used for this alarm should be properly configured to avoid inappropriate alarms.

Some examples of use cases where a PTP port may want to acquire knowledge of the characteristics of the transmission path are included in the next sub-clauses.

If the port detects that all expected ingress messages to compute the time error are not received, the PTSF-lossOfTimingMessages may be set as specified in clause 6.3.9.

The monitoring feature uses some of the functionality of alternate timeTransmittermaster (clause 17.4 of [IEEE 1588-2008], clause 17.3 of [IEEE 1588-2019]), limited to the ability to transmit and processes PTP messages in the PTP port states as described above, with the alternateMasteralternateTimeTransmitterFlag set as appropriate.

The following table captures various combinations of Port A and Port B states showing when Port A is able to monitor Port B. Some combinations may occur due to the use of masterOnlytimeTransmitterOnly, notMasternotTimeTransmitter, slaveOnlytimeReceiverOnly or some other means to override the default behaviour.

**Table G.1 – Combination of PTP port states with monitoring**

Port A State	Port B State	Port A monitoring of Port B is supported when	
		Port A configuration of portDS.monitorReceiver	Port B configuration of portDS.monitorSender
<u>SLAVETIME RECEIVER</u>	<u>MASTERTIME TRANSMITTER</u>	(NOTE 1)	(NOTE 2)
PASSIVE	<u>MASTERTIME TRANSMITTER</u>	TRUE	(NOTE 2)
<u>MASTERTIME TRANSMITTER</u>	<u>SLAVETIME RECEIVER</u>	TRUE	TRUE
<u>MASTERTIME TRANSMITTER</u>	PASSIVE	TRUE	TRUE
<u>MASTERTIME TRANSMITTER</u>	<u>MASTERTIME TRANSMITTER</u>	TRUE	(NOTE 2)

NOTE 1 – The configuration of portDS.monitorReceiver does not impact the operation of a PTP port in the SLAVETIME RECEIVER state (i.e., is not required to be TRUE).  
NOTE 2 – The configuration of portDS.monitorSender does not impact the operation on a PTP port in the MASTERTIME TRANSMITTER state (i.e., is not required to be TRUE).

NOTE – Table G.1 lists the most typical combinations of PTP port states. The monitoring function described in this annex also applies to other combinations.

**G.1 Use case 1 – PASSIVE port monitoring MASTERTIME TRANSMITTER port**

Figure G.1 shows an example to illustrate where a PTP clock with a PTP port in the PASSIVE state (portDS.monitorReceiver is TRUE) monitors a peer PTP port in the MASTERTIME TRANSMITTER state. As shown below, T-BC #4 has a PTP port in the PASSIVE state and it is desirable to monitor T-BC #2 that has a PTP port in the MASTERTIME TRANSMITTER state. When the T-BC #4 PTP PASSIVE port receives the Sync and Delay\_Resp message from the T-BC #2 PTP MASTERTIME TRANSMITTER port, the T-BC #4 can get the time error (based on PTP timestamps) in reference to the local PTP clock (computed on the SLAVETIME RECEIVER port, based on the time of T-BC #3 PTP MASTERTIME TRANSMITTER port). ~~If the difference of the time error of PASSIVE port and the time error of SLAVE port exceeds a threshold, this PTP clock may generate an alarm, which means that a fibre asymmetric, or a clock failure could be present in this PTP network. Note this alarm is just used for PTP monitoring and should not trigger the BMCA. Additionally, the threshold used for this alarm should be properly configured to avoid inappropriate alarms.~~

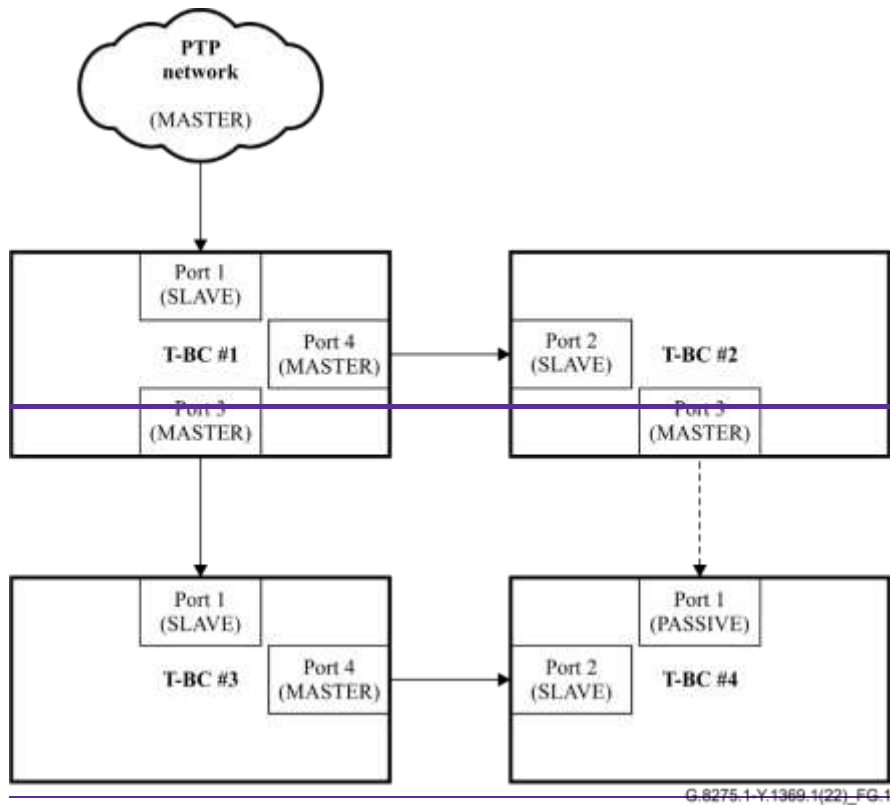

G.8275.1-Y.1369.1(22)\_FG.1

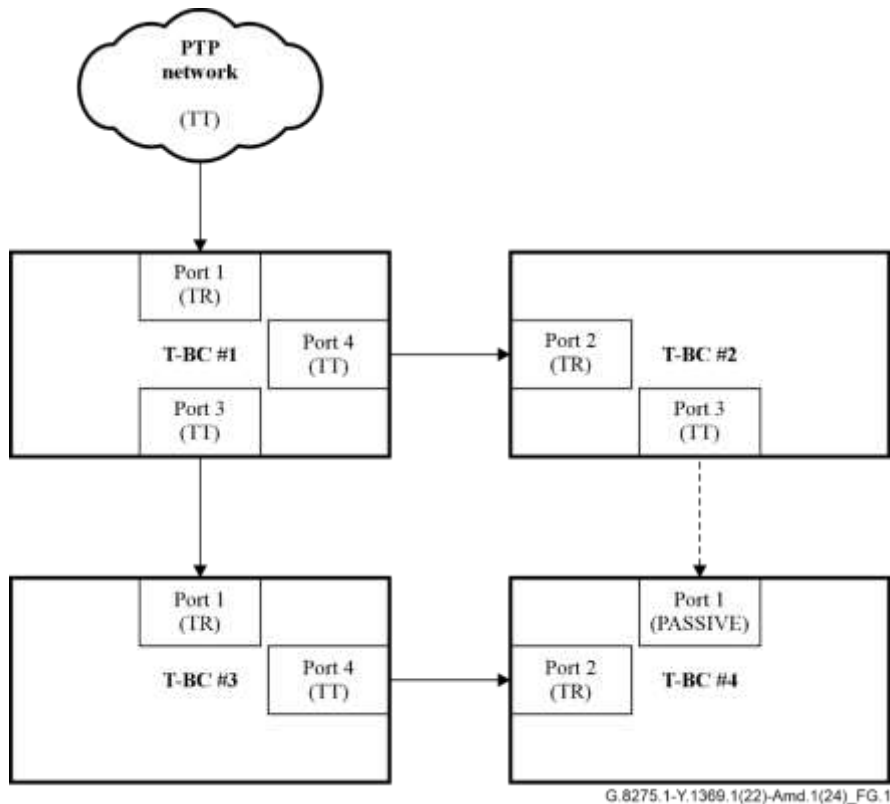

G.8275.1-Y.1369.1(22)-Amd.1(24)\_FG.1

Figure G.1 – PASSIVE port monitors MASTERTIME TRANSMITTER port

**G.2 Use case 2 – MASTERTIME TRANSMITTER port monitoring PASSIVE port**

Figure G.2 shows an example to illustrate where a PTP clock with a PTP port in the MASTERTIME TRANSMITTER state (portDS.monitorReceiver is TRUE) monitors a peer PTP port in the PASSIVE state (portDS.monitorSender is TRUE). In the situation shown, Port 2 could be a PTP port or a virtual PTP port in the SLAVETIME RECEIVER state preferring to synchronize to

the local GNSS receiver. Port 1 in the MASTERTIME TRANSMITTER state is used for monitoring of the PTP network, and through the monitoring function, the PTP clock is able to measure the time error on the PTP network-: when the PTP TIME TRANSMITTER port #1 receives the Sync and Delay\_Resp messages from the peer clock's PASSIVE port, the PTP clock can estimate the time error of the TIME TRANSMITTER port #1 in reference to the local PTP clock (computed on the TIME RECEIVER port #2, based on the time of the PRTC).

Note that in Figure G.2 it is assumed that the PTP Clock Port 1 is in the MASTERTIME TRANSMITTER state and the peer port in the PTP network is in the PASSIVE state, but that the opposite may also occur (where Port 1 is PASSIVE and the peer port in the PTP Network is MASTERTIME TRANSMITTER, which is described in clause G.1) depending on the network planning and the Alternate BMCABTCA.

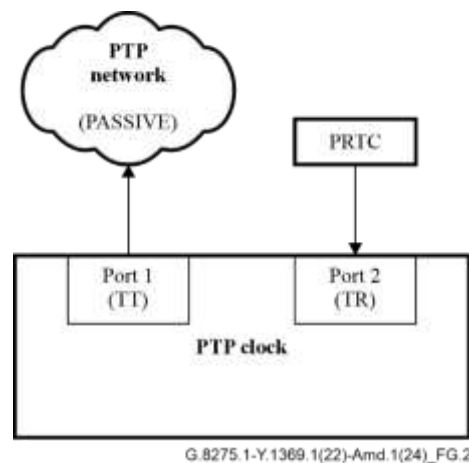
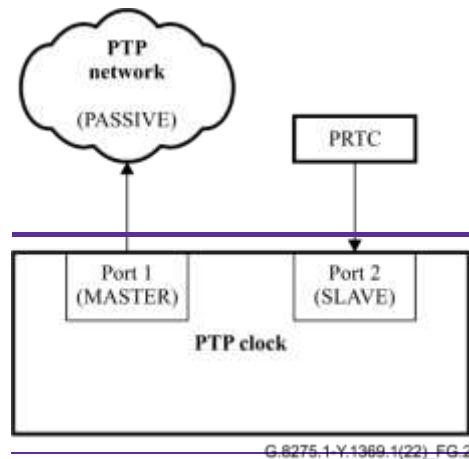

**Figure G.2 – MASTERTIME TRANSMITTER port monitors PASSIVE port**

### **G.3 Use Case 3 – MASTERTIME TRANSMITTER port monitoring MASTERTIME TRANSMITTER port**

Figure G.3 shows a use case where a PTP probe may monitor information from a PTP clock. Additionally, the PTP clock may likewise monitor information from the PTP probe. Considering a PTP probe working as a monitor function instead of a PTP reference, it is assumed that the PTP clock Port 2 is configured with portDS.masterOnlytimeTransmitterOnly TRUE in order to prevent the PTP probe from being selected by the Alternate BMCABTCA of the PTP clock. To allow the PTP probe to monitor the PTP clock, the port of the PTP probe is configured with portDS.monitorReceiver TRUE. To allow the PTP clock to monitor the PTP probe, Port 2 of PTP clock is configured with portDS.monitorReceiver TRUE. Once both are configured as described there may be a full exchange of information between the PTP probe and the PTP clock. As a result, the PTP probe may full

characterize/probe the PTP clock (receiving Sync & Delay\_Resp), but also the PTP clock may gain the full knowledge of the PTP probe, by reception of Sync & Delay\_Resp from the PTP probe: when the PTP TIME TRANSMITTER port #2 receives the Sync and Delay\_Resp messages from the probe's TIME\_TRANSMITTER port, the PTP clock can estimate the time error of the TIME\_TRANSMITTER port #2 in reference to the local PTP clock (computed on the TIME\_RECEIVER port #1, based on the time of the network's TIME\_TRANSMITTER port).

Note, for some use cases, it may be only necessary to monitor the timing of one direction but not both, e.g., a PTP probe monitors a PTP clock, or a PTP clock monitors a PTP probe to estimate its accuracy.

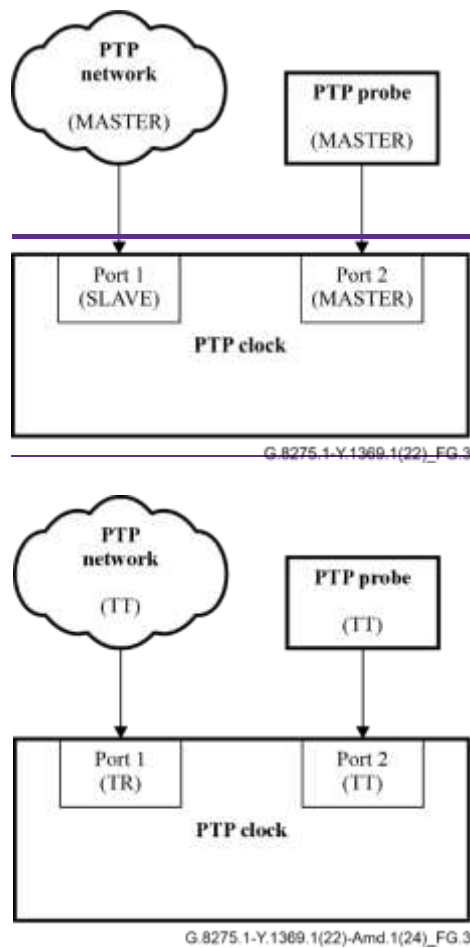

**Figure G.3 – MASTERTIME TRANSMITTER port monitors MASTERTIME TRANSMITTER port**



## **Annex H**

### **Transport of PTP over OTN**

(This annex forms an integral part of this Recommendation.)

The transport of PTP over OTN shall be performed by encapsulating the PTP messages into GFP-F frames as specified in clause 7.10 of [ITU-T G.7041], and then inserting the GFP-F frames into the OTUk OSMC as specified in clause 15.7.2.4 of [ITU-T G.709] and the FlexO OSMC as specified in clause 9.2.10 of [ITU-T G.709.1].

The PTP messages shall be timestamped as specified in clause 15.7.2.4.1 of [ITU-T G.709] and in clause 9.2.10.1 of [ITU-T G.709.1].

PTP messages may also be carried over the OSC OSMC as specified in clause 14.1 of [ITU-T G.709]. The PTP encapsulation in this latter case is vendor specific.

All bits of the transportSpecific field (see clause 13.3.2.1 of (IEEE 1588-2008)) shall be transmitted as zero and shall be ignored by the receiver.

The value of the networkProtocol enumeration for the transport of PTP over OTN shall be F000 (hex).

## **Annex I**

### **Transport PTP over MTN**

(This annex forms an integral part of this Recommendation.)

The transport of PTP over MTN is performed by encapsulating PTP messages into Ethernet frames that are transported by the MTN overhead per clause 9.2.5 of [ITU-T G.8312]. The PTP event messages are timestamped. The timestamp generation is for further study.

The value of the networkProtocol enumeration for the transport of PTP over MTN is F001 (hex).

## **Annex J**

### **Transport PTP over FlexE links**

(This annex forms an integral part of this Recommendation.)

The transport of PTP over FlexE shall be performed by encapsulating PTP messages into Ethernet frames that are transported by the FlexE overhead per clause 7.3.5 of [OIF FlexE IA]. The PTP event messages shall be timestamped as per clause 7.3.5 of [OIF FlexE IA].

The value of the networkProtocol enumeration for the transport of PTP over FlexE shall be F002 (hex).

## Annex K

### Dynamic Monitoring based on PTSF (Optional)

(This annex forms an integral part of this Recommendation.)

This annex is optional but, if implemented, it is necessary for the equipment to conform to the requirements contained herein.

This annex describes an approach to dynamic monitoring of a neighbour-peer PTP port by a PTP port with local PTSF. When this annex is implemented, a PTP port is additionally permitted to transmit Delay\_Req messages and process received Delay\_Resp messages irrespective of the PTP port state based on the PTSF status, as described below in the following cases:

- either UNCALIBRATED, TIME RECEIVER or PASSIVE state;
- or if portDS.SF is TRUE, regardless of the current port state;
- or if portDS.monitorReceiver is TRUE (as per Annex G), regardless of the current port state.

–The PTSF function is specified by clause 6.3.9.

When a PTSF event has occurred at a PTP port of a PTP clock, the PTP clock may set portDS.SF to TRUE according to clause 6.3.9. Upon the change of portDS.SF to TRUE, regardless of its current state, even if the PTP port state is not in the SLAVE state, the PTP port is allowed to send Delay\_Req message and monitor the correct reception of receive Delay\_Resp messages. This functionality allows the local PTP port to update the PTSF status. If it is verified that the PTSF has been cleared, portDS.SF of the PTP port is set to FALSE. As a result, the PTP port is considered as a candidate reference with normal handling of PTP messages and the Alternate BTCA can use Announce messages received on the port.

The monitoring feature uses some of the functionality of alternate timeTransmittermaster (clause 17.4 of [IEEE 1588-2008], clause 17.3 of [IEEE 1588-2019]), limited to the ability to transmit and processes PTP messages in the PTP port states as described above, with the alternateMasteralternateTimeTransmitterFlag set as appropriate.

An example for the case of T-BC is shown by Figure K.1.

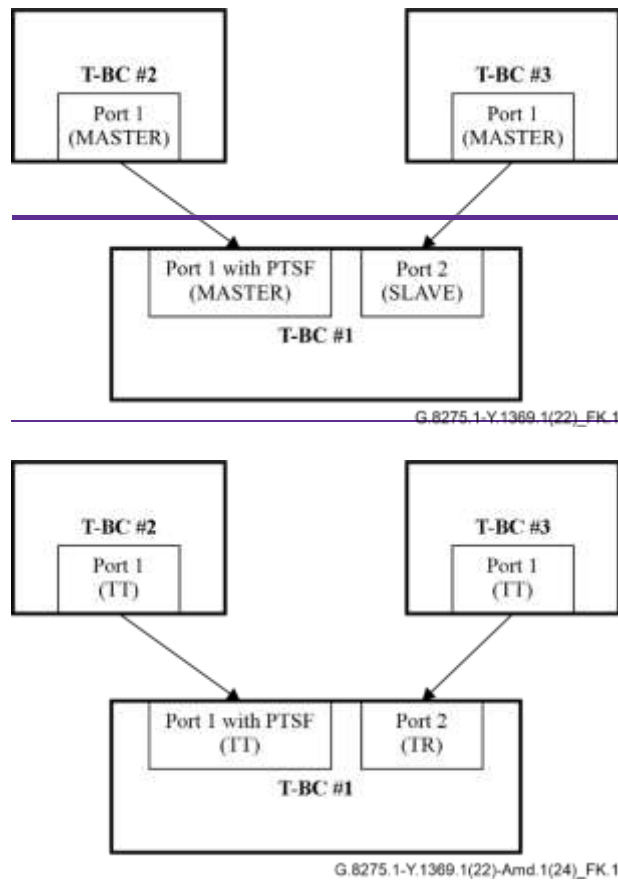

**Figure K.1 – An example of PTSF restoration**

In Figure K.1, Port 1 of T-BC #1 was previously in the SLAVETIME RECEIVER state synchronizing with Port 1 of T-BC #2. After a while, T-BC #1 detects a PTSF event at Port 1 and changes its portDS.SF to TRUE. According to clause 6.3.9, T-BC #1 runs its alternate—Alternate BMCABTCA, selects Port 1 of T-BC #3 as its new reference, and sets Port 2 to SLAVETIME RECEIVER, Port 1 to MASTERTIME TRANSMITTER (if configured with portDS.notTimeTransmitter FALSE) or PASSIVE (if configured with portDS.notTimeTransmitter TRUE).

In order to recover the PTSF failure of Port 1 of T-BC #1, that T-BC needs to continue to send messages towards T-BC#2 to detect when the SF condition is resolved. The event of portDS.SF with TRUE triggers Port 1 of T-BC #1 to continue to send Delay\_Req messages. Port 1 of T-BC #2 in MASTERTIME TRANSMITTER state is able to reply with Delay\_Resp messages. As a result, Port 1 of T-BC #1 will continue to receive Announce, Sync and Delay\_Resp messages in order to determine if the signal fail condition has been cleared. If the failure is cleared, T-BC #1 puts portDS.SF of Port 1 to FALSE and then Announce messages received on Port 1 of T-BC #1 can be considered in the alternate—Alternate BMCABTCA, which may select it as a SLAVETIME RECEIVER port again.

## Appendix I

### Considerations on the use of transparent clock

(This appendix does not form an integral part of this Recommendation.)

The integration of the transparent clock in this profile is considered of particular interest for applications such as 2-port type of devices.

For more complex topologies and multiport devices some careful analysis is recommended. In particular, some specific node configuration may be required if the operator wants to prevent multicast packets flooding the network.

Some options could be considered, e.g., by configuration of the T-TCs with insertion of a [\[IEEE 802.1Q\]](#) VLAN tag in the frames carrying PTP. In this case all T-TCs in the PTP communication path where this option is used should support this option. The last T-TC node would need to remove the [\[IEEE 802.1Q\]](#) VLAN tag. By using this option to connect the physical ports of the T-GM, T-BC, and T-TSCs through [\[IEEE 802.1Q\]](#) VLAN virtual connections across the T-TCs, the multicast flooding can be avoided. In this way the PTP port of a T-GM, T-BC or T-TSC would never process a [\[IEEE 802.1Q\]](#) VLAN tagged frame.

The related operational implications would need to be carefully considered.

## Appendix II

### Considerations on the transmission of Delay\_Req messages

(This appendix does not form an integral part of this Recommendation.)

This appendix discusses the requirements defined in [IEEE 1588] for the transmission of *Delay\_Req* messages when using the default uniform distribution defined in bullet 3 of clause 9.5.11.2 of [IEEE 1588-2008] and bullet (1) of clause 9.5.11.2 of [IEEE 1588-2019]. This uniform distribution is not used in the PTP telecom profile defined in this Recommendation; a profile-specific distribution has been defined in clause 6.2.8.

The second dashed item of the requirements defined in clause 9.5.11.2 of [IEEE 1588-2008] and bullet (b) of clause 9.5.11.2 of [IEEE 1588-2019] controls the variability of the times between successive *Delay\_Req* messages. It is analogous to the corresponding requirement for the sending of *Sync* and *Announce* messages, given in clause 7.7.2.1 of [IEEE 1588]. However, a key difference is that, while the requirement for *Sync* messages applies to the population of inter-message intervals, the requirement for *Delay\_Req* messages applies only to the mean of the population.

To be more precise, assume that a population of  $N$  inter-message intervals has been measured, and let  $T_j$  be the measured values,  $j = 1, 2, \dots, N$ . The sample mean,  $m$ , is just the numerical average, i.e.,

$$m = \frac{1}{N} \sum_{j=1}^N T_j \quad (\text{II.1})$$

Let  $T_{min}$  be the minimum *Delay Request* interval; it is equal to  $2^{\text{portDS.logMinDelayReqInterval}}$  s. The second dashed item above states that the mean of the distribution must be greater than or equal to  $T_{min}$  with 90% or greater statistical confidence.

The statistical test for this is well-known and is based on the fact that the distribution of  $m$  approaches a normal distribution as  $N$  becomes large (i.e., it is based on the central limit theorem). Let  $s$  be the standard deviation of the distribution of the inter-message times, i.e., the distribution of the  $T_j$ . Let  $z_{0.90}$  be the 90th percentile of the standard normal distribution; it is given by  $z_{0.90} = 1.281$ . Then, the probability that the true mean of the distribution exceeds the quantity

$$q_{0.1} = m - z_{0.90} \sqrt{\frac{\sigma}{N}} \quad (\text{II.2})$$

is 0.9, i.e., 90%. The probability that the mean of the distribution is less than this value is 0.1. In addition, if  $\sigma$  is not known, the sample standard deviation,  $s$ , may be used in equation (II.2) and the Normal distribution is replaced by the Student- $t$  distribution with  $N - 1$  degrees of freedom. The sample standard deviation is given by:

$$s = \left[ \frac{1}{N-1} \sum_{j=1}^N (T_j - m)^2 \right]^{1/2} \quad (\text{II.3})$$

To meet the requirement, the quantity  $q_{0.1}$  must exceed  $T_{min}$ . It is seen from equation (II.2) that  $q_{0.1}$  approaches  $m$  as  $N$  approaches infinity. Since  $m$  converges to the mean of the distribution of inter-message times as  $N$  approaches infinity, the requirement can be met for sufficiently large  $N$  as long as the mean of the distribution exceeds  $T_{min}$ . The mean of the distribution must exceed  $T_{min}$ ; the requirement cannot be met if the mean of the distribution is exactly equal to  $T_{min}$  or less than  $T_{min}$ .

If it is chosen to comply with the requirement of the third dashed item of clause 9.5.11.2 of [IEEE 1588-2008] or bullet (1) of clause 9.5.11.2 of [IEEE 1588-2019], one way of meeting this

requirement is to increase the upper end of the probability distribution by 10%. If this is done, the transmission times are selected such that the interval between successive *Delay\_Req* messages is taken from a uniform distribution over the interval between 0 and  $2.2T_{min}$ . A new random value for the transmission interval is computed for each message transmitted. When computing the mean *Delay\_Req* interval from measured samples to check if it exceeds  $T_{min}$  with 90% or greater statistical confidence (if the third dashed item is used), the number of measured samples  $N$  must be at least 1000. The granularity of the distribution must be less than or equal to  $1/16$  *Sync* interval.

If it is chosen to meet the requirement of the fourth dashed item of clause 9.5.11.2 of [IEEE 1588] or bullet (2) of clause 9.5.11.2 of [IEEE 1588-2019], a *Delay\_Req* message is transmitted as soon as possible after receipt of a *Sync* message, subject to not violating the second dashed item.



## Appendix III

### Considerations on the choice of the PTP Ethernet multicast destination address

(This appendix does not form an integral part of this Recommendation.)

This PTP profile supports both the non-forwardable multicast address 01-80-C2-00-00-0E and forwardable multicast address 01-1B-19-00-00-00 when the PTP mapping defined in Annex F of [IEEE 1588-2008] or Annex E of [IEEE 1588-2019] is used.

The Ethernet multicast address to be used depends on the operator policy; further considerations are provided hereafter.

Layer 2 bridging function associated with the PTP port of a T-BC or T-TC should not forward any frame with destination MAC address 01-1B-19-00-00-00; this could be done by properly provisioning this multicast address in the filtering database.

#### **Option 1 – Use of the non-forwardable multicast address 01-80-C2-00-00-0E**

Some network operators consider that the PTP messages must never be forwarded through PTP-unaware network equipment.

The use of the non-forwardable multicast address 01-80-C2-00-00-0E guarantees this property most of the time (exceptions exist for some older Ethernet equipment).

Therefore, in the case of network equipment misconfiguration (e.g., if the PTP functions are not enabled in PTP-aware network equipment), the use of this multicast address prevents incorrect distribution of synchronization, since the PTP messages will be blocked by the PTP-unaware network equipment.

#### **Option 2 – Use of the forwardable multicast address 01-1B-19-00-00-00**

Some network operators consider that using a forwardable multicast address is more flexible and that it is preferable to forward the PTP messages to keep the synchronization link running in case some equipment is misconfigured as non PTP nodes, although there are potentially risks of performance degradation. The network management system (NMS) will easily find the misconfiguration and will send alarms.

However, it is possible to block the PTP messages by properly provisioning this multicast address in the filtering database of each Ethernet equipment.

## Appendix IV

### Considerations on the use of priority2

(This appendix does not form an integral part of this Recommendation.)

The PTP attribute `priority2` is configurable in this profile. In some special circumstances, the use of the `priority2` attribute can simplify the network management. This appendix describes two use cases; other possible cases are for further study.

NOTE – Additional considerations on the use of `priority2` are provided in Appendix XVI.

#### Case 1

Operators can configure the PTP attribute `priority2` to make all of the T-BCs either traceable to one T-GM, or traceable to two different T-GMs at the same time.

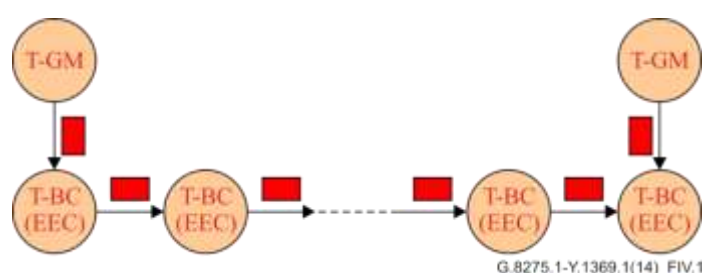
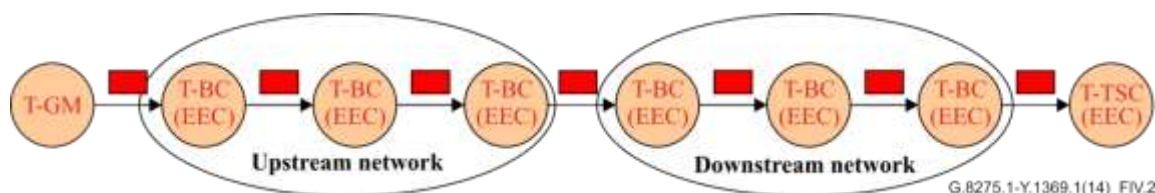

**Figure IV.1 – Use of `priority2` with two T-GMs in the network**

For example, in Figure IV.1, if all other PTP attributes of the two T-GMs are the same, and the two T-GMs are configured with the same `priority2` value, each T-BC will select the T-GM with the shortest path. If the two T-GMs are configured with different `priority2` values, all of the T-BCs will synchronize to the T-GM with the smallest `priority2` value.

#### Case 2

Operators can configure the PTP attribute `priority2` to prevent the T-BCs of an upstream network from synchronizing with the T-BCs of a downstream network when the T-GM is in failure.



**Figure IV.2 – Use of `priority2` with T-BCs of different network layers**

For example, in Figure IV.2, if all other PTP attributes of all of the T-BCs are the same, and the PTP attribute `priority2` of all of T-BCs are configured with the same value, then when the T-GM is in failure, the T-BCs in the upstream network can synchronize with the T-BCs in the downstream network, depending on the `clockIdentity` values of all of the T-BCs. If the T-BCs in the upstream network are configured with a smaller `priority2` value than the T-BCs in the downstream network then, when the T-GM is in failure, the T-BCs in the downstream network will synchronize to the T-BCs in the upstream network.

## **Appendix V**

### **Description of PTP clock modes and associated contents of Announce messages**

(This appendix does not form an integral part of this Recommendation.)

Description of PTP clock modes and associated contents of Announce messages are described in Appendix VIII of [ITU-T G.8275].

## **Appendix VI**

### **Operations over link aggregation**

(This appendix does not form an integral part of this Recommendation.)

When two devices embedding PTP clocks compliant with this profile are connected via a link aggregation (LAG) as defined in [b-IEEE 802.1AX], each physical link should be accessed directly to transmit PTP messages, bypassing the LAG. This method prevents potential asymmetries that may be present when the forward and reverse paths are delivered over different links belonging to the LAG.

Alternative solutions taking advantage of some LAG features exist, such as the bidirectional congruity as defined by [b-IEEE 802.1AX]. For the scenarios currently considered, the insertion of a VLAN tag in the frames carrying PTP messages is not allowed. However, the bidirectional congruity alternative solution can be applied to untagged PTP frames by assigning a conversation ID equal to zero to a given physical link. These solutions are for further study.

## Appendix VII

### Relationship between clockClass and holdover specification

(This appendix does not form an integral part of this Recommendation.)

The clockClass values that are used in this profile are described in Table 3. The values may be divided into four different categories:

- 1) T-GM locked to a PRTC or ePRTC;
- 2) T-GM or T-BC in holdover, within holdover specification;
- 3) T-GM or T-BC in holdover, outside of holdover specification;
- 4) TimeReceiverSlave clock, or clock that has not been synchronized.

A short footnote (Note 1 of clause 6.4) refers to Appendix V of [ITU-T G.8271.1] for more information on the meaning of "in holdover, within holdover specification" and "in holdover, out of holdover specification". That appendix describes possible budget models for the synchronization performance. The exact model depends on the operator's network and design parameters, but each budget is broken down into several components:

- 1) PRTC/T-GM allocation;
- 2) Random time error from noise accumulation through the network (dTE);
- 3) Node asymmetry (cTE, the sum of the asymmetry of all the nodes in the system);
- 4) Link asymmetry (cTE, the sum of the asymmetry of all the links in the system);
- 5) Holdover budget;
- 6) End application budget.

Table V.1 of [ITU-T G.8271.1] shows that for one example budget, 400 ns may be allocated to holdover within the network (this is termed failure scenario (b) in the table). The operator may have different budget allocations, depending on their deployment scenario. The 400 ns holdover budget is allocated to the entire synchronization chain, and not to an individual clock.

The intended operation of the T-GM is, therefore, as follows:

- When the T-GM is synchronised to a PRTC locked to GNSS, it outputs clockClass 6.
- If the PRTC loses its connection to GNSS, it enters holdover. The T-GM should degrade the advertised clockClass to indicate "in holdover, but within holdover specification" (clockClass 7).
- The T-GM estimates when the holdover budget will potentially be exceeded. Factors to consider include the known quality of any external frequency support (e.g., SyncE QL), temperature variations, and/or the quality of the internal oscillator.
- When the T-GM considers that the clock is out of holdover specification (i.e., it is now estimated to have drifted by more than the holdover budget), the T-GM will advertise a clockClass of 140, 150 or 160.

In the event of a network failure, where the T-GM is disconnected from the synchronization chain, a T-BC will take over as the grandmaster of the chain. That T-BC will be operating in holdover. The clockClass that the T-BC is allowed to advertise depends on the clockClass of the T-GM to which it was synchronized prior to losing connectivity.

For example, if the T-BC was synchronized to a T-GM of clockClass 6, none of the holdover budget will have been consumed, and therefore the T-BC may use a clockClass indicating "within holdover specification" (e.g., clockClass 135). This value is chosen to be higher-lower (i.e., better) than that of a T-GM that is out of holdover specification, since the T-BC is likely to have more accurate time because it has been locked to a traceable time source more recently. Therefore, if the two clocks (a

T-BC in holdover, within holdover specification and a T-GM in holdover, but out of holdover specification) are compared in the Alternate ~~BMC~~ABTCA operation of a subsequent clock, the subsequent clock will synchronize to the T-BC that is within holdover specification instead of a T-GM that is out of holdover specification.

In another example, if the T-BC was synchronized to a T-GM indicating that the T-GM is in holdover but out of holdover specification (e.g., parentDS clockClass 140, 150 or 160), the T-BC should also use a clockClass indicating "out of holdover specification" (e.g., defaultDS clockClass 165). This is because the T-GM was indicating that, in its estimation, the holdover budget has already been consumed.

In another example, if the T-BC was synchronized to another T-BC, and the other T-BC indicates that it is in holdover but out of holdover specification (e.g., parentDS clockClass 165), the original T-BC should also use a clockClass indicating "out of holdover specification" (e.g., defaultDS clockClass 165). This is because the other T-BC was indicating that, in its estimation, the holdover budget has already been consumed.

In a final example, if the T-BC was synchronized to a T-GM or another T-BC that was already in holdover but still within the holdover specification, the original T-BC could indicate "within holdover specification". However, some of the holdover budget will have already been consumed by the T-GM or T-BC. If it is not known how much of the budget is left, the T-BC should indicate "out of holdover specification".

NOTE 1 – When the term clockClass is used with respect to the property of the individual PTP clock (T-GM, T-BC, T-TSC) it is referring to data set member defaultDS.clockQuality.clockClass.

NOTE 2 – If a T-BC was synchronized to a T-GM or to another T-BC that was in free-run mode (advertising clockClass 248), the T-BC should continue to advertise clockClass 248 even after it loses its reference.

## Appendix VIII

### Considerations on a T-TSC connected to an end application

(This appendix does not form an integral part of this Recommendation.)

The default T-TSC clockclass 255 implies that the T-TSC will always lock to an external PTP reference when available.

The actual synchronization source ultimately used by the end application depends on the applicable synchronization needs. This process is out of the scope of this Recommendation.

As an example, the decision to use the PTP reference that has been selected by the T-TSC (e.g., instead of entering holdover), could depend on the actual clockQuality, frequencyTraceable flag, timeTraceable flag, and synchronizationUncertain flag associated to the external PTP reference. Additional aspects as related to performance monitoring of the external reference might also be considered. This is implementation specific.

As an example, when it is required to meet the network timing requirements as per e.g., [ITU-T G.8271.1], it would be necessary that the external PTP reference has clockClass 6, 7 or 135 and that the timeTraceable flag is TRUE in order to be used by the end application. When this condition is not met, the end application may decide to enter holdover (either using the internal oscillator or driven by SyncE).

NOTE – The specific behaviour for a T-TSC embedded in the end application is outside the scope of this Recommendation. It is assumed that interoperability with the profile is maintained.

## Appendix IX

### Calculation of offsetScaledLogVariance for T-GM timed by PRTC or ePRTC

(This appendix does not form an integral part of this Recommendation.)

#### IX.1 Observation interval and TDEV noise generation

The offsetScaledLogVariance is an offset, scaled representation of the PTP variance (PTPVAR). PTPVAR is described in clause 7.6.3 of [IEEE 1588]; it is equal to Allan variance multiplied by  $\tau^2/3$ , where  $\tau$  is the observation interval. PTP variance is therefore not a single value; it is a function of observation interval. Clause 7.6.3 of [IEEE 1588] specifies that the observation interval  $\tau$  shall be the value defined in the applicable PTP profile. Clause 7.6.3 of [IEEE 1588] refers to  $\tau$  as the sampling period. However, comparison of the equations in clause 7.6.3.2 of [IEEE 1588] with the equations for Allan variance in clause II.1 of [ITU-T G.810] indicates that  $\tau$  in clause 7.6.3 of [IEEE 1588] is the observation interval of [ITU-T G.810], and not the sampling interval  $\tau_0$ .

The offsetScaledLogVariance, i.e., defaultDS.clockQuality.offsetScaledLogVariance, is a clock attribute used in the [Alternate BMCABTCA](#). As indicated in clause 7.6.3.5 of [IEEE 1588], it is "an estimate of the variations of the local clock from a linear timescale when it is not synchronized to another clock using the protocol" (quoted text is from [IEEE 1588]; the "protocol" refers to the PTP protocol). Since a clock is not synchronized to another clock via PTP when it is grandmaster, the offsetScaledLogVariance should represent the long-term noise that the clock generates, because it is this noise that is generated if the clock is grandmaster. Therefore, the observation interval should be the longest interval over which noise generation for the clock in question is specified.

For a T-GM timed by a PRTC, i.e., a clock that meets the requirements of [ITU-T G.8272], the longest observation interval for which noise generation TDEV is specified is 10000 s (see Figure 2 of [ITU-T G.8272]). For this interval, TDEV is 30 ns. The specified noise type for intervals ranging from 1000 s to 10000 s is flicker phase modulation (FPM), with TDEV equal to 30 ns in this range. For a T-GM timed by an ePRTC, the longest observation interval for which noise generation TDEV is specified is  $10^6$  s. For this interval, TDEV is 10 ns. The specified noise type for intervals ranging from  $3 \times 10^5$  s to  $10^6$  s is FPM, with TDEV equal to 10 ns in this range.

The value of the observation interval is not used directly in the PTP protocol and is not carried in any PTP messages. It is used only in evaluating PTP variance.

The above values of observation interval and corresponding noise generation TDEV, for the PRTC and ePRTC, are summarized in Table IX.1.

**Table IX.1 – Observation intervals, and corresponding noise generation TDEV values and noise type, for T-GM timed by PRTC and T-GM timed by ePRTC**

Clock that T-GM is timed by	Observation interval ( $\tau$ ) for offsetScaledLogVariance (s)	$n = \tau/\tau_0$ (see clause IX.2 below)	Noise type	TDEV (ns)
PRTC	1000 – 10000	$1.6 \times 10^4$ to $1.6 \times 10^5$	FPM	30
ePRTC	300 000 – 1 000 000	$4.8 \times 10^6$ to $1.6 \times 10^7$	FPM	10

#### IX.2 Computation of PTP variance from TDEV

The next step is to compute PTP variance from the TDEV values given in the previous clause. Since PTP variance is equal to  $\tau^2/3$  multiplied by Allan variance, and time variance (TVAR) is equal to  $\tau^2/3$  multiplied by modified Allan variance, the ratio of TVAR to PTP variance is equal to the ratio of modified Allan variance (MVAR) to Allan variance. This latter ratio is discussed and computed for various noise types in section A.6 of [b-Sullivan]. The results given there are based on [b-Walls] and



[b-Lesage]. In addition, the relations between power spectral density (PSD) and Allan variance are given in Table 5.4 of [b-Bregni], and between PSD and modified Allan variance in Table 5.5 of [b-Bregni] (when using relations between PSD and various time-domain stability parameters, it is important to take note of whether the PSD is of time ( $S_x(f)$ ) or of frequency ( $S_y(f)$ )).

Let  $n$  be the ratio of observation interval  $\tau$  to sampling interval  $\tau_0$ , i.e.,  $\tau = n\tau_0$ . In general, the ratio of MVAR to AVAR, denoted  $R(n)$ , depends on  $n$ , though at least for the noise types white phase modulation (WPM), flicker FPM, white frequency modulation (WFM), flicker frequency modulation (FFM), and random-walk frequency modulation (RWFM), it approaches an asymptotic value for large  $n$ . In addition, for the case of FPM  $R(n)$  depends on the measurement system bandwidth (for WPM, both AVAR and MVAR individually depend on measurement system bandwidth, though their ratio does not). Since time synchronization information from whichever clock is selected as grandmaster is transported via Sync messages, the sampling interval  $\tau_0$  can be taken equal to the Sync interval. The actual successive Sync intervals vary with time, as allowed by clause 7.7.2.1 of [IEEE 1588]; for simplicity, we may take  $\tau_0$  equal to the mean Sync interval. This is 1/16 s in [ITU-T G.8275.1]. Then, using the observation interval values in Table IX.1 above, the corresponding values of  $n$  range from  $1.6 \times 10^4$  to  $1.6 \times 10^5$  for a T-GM timed by a PRTC, and from  $4.8 \times 10^5$  to  $1.6 \times 10^5$  for a T-GM timed by an ePRTC. The values of  $n$  are also summarized in Table IX.1 above.

From Table IX.1, it is seen that the range of  $n$  is different for the PRTC and ePRTC. This means that, even though the noise type in the ranges of interest for these clocks is the same,  $R(n)$  will be different, and TVAR for each clock will be adjusted by a different factor to obtain PTPVAR. However, the PRTC and ePRTC stability (as well as the stability of other clocks used in telecommunications) are specified using TDEV (i.e., square root of TVAR), and not using PTPDEV or PTPVAR. It therefore would be desirable to adjust TVAR for the PRTC and ePRTC by the same factor. In previous work, in which TVAR for the PRTC was compared to TVAR for a T-BC timed by SyncE,  $R(n)$  was equal to 0.787. This value is used here for convenience, for both the PRTC and ePRTC.

With the above assumption, PTPVAR for the PRTC is given by:

$$\text{PTPVAR (PRTC)} = \frac{\text{TVAR}}{R(n)} = \frac{(30 \times 10^{-9})^2 \text{ s}^2}{0.787} = 1.144 \times 10^{-15} \text{ s}^2 \quad (\text{IX.1})$$

and PTPVAR for the ePRTC is given by:

$$\text{PTPVAR (ePRTC)} = \frac{\text{TVAR}}{R(n)} = \frac{(10 \times 10^{-9})^2 \text{ s}^2}{0.787} = 1.271 \times 10^{-16} \text{ s}^2 \quad (\text{IX.2})$$

### IX.3 Computation of offsetScaledLogVariance from PTP variance

offsetScaledLogVariance is now computed from the PTPVAR results of the previous clause, using the procedure described in clause 7.6.3.3 of [IEEE 1588]. This procedure is:

- a) The logarithm to base 2 of PTPVAR expressed in units of  $\text{s}^2$  is computed;
- b) The result of (a) is multiplied by  $2^8$  to produce a scaled value;
- c) The scaled value is modified per the hysteresis specification of clause 7.6.3.3 of [IEEE 1588]. (This step is not needed here, because offsetScaledLogVariance is being computed from a specification, rather than from real-time measurements.);
- d) The result of (c) is represented as a 2s complement Integer16 (i.e., it is represented as a signed integer, where negative values are represented in 2s complement form (since PTPVAR is less than  $1 \text{ s}^2$  in almost all cases of practical interest, and certainly in the cases described in the previous clause, the result of (c) will almost always be negative));
- e) The value 0x8000 is added to the result of (d), and any overflow is ignored;

- f) The result of (e) is cast as an Integer16. This result, which may also be expressed in writing in hexadecimal form, is offsetScaledLogVariance.

### IX.3.1 Computation of offsetScaledLogVariance for a T-GM timed by a PRTC

From Eq. (IX.1),  $PTPVAR = 1.144 \times 10^{-15} \text{ s}^2$ . Using steps (a) – (f) above, we obtain

$$\begin{aligned} \log_2(PTPVAR) &= \frac{\ln(1.144 \times 10^{-15})}{\ln 2} = -49.6348 \\ 2^8 \log_2(PTPVAR) &= \frac{(256)\ln(1.144 \times 10^{-15})}{\ln 2} = -12706.5176 @ -12707 \end{aligned} \quad (IX.3)$$

Representing the above as a signed integer in 2s complement form produces

$$12707 = 31A3_{16} \supset CE5C_{16} \text{ (1s complement form)} \supset CE5D_{16} \text{ (2s complement form)} \quad (IX.4)$$

Adding  $8000_{16}$  to the above and ignoring any overflow produces

$$CE5D_{16} + 8000_{16} = 14E5D_{16} \supset 4E5D_{16} \quad (IX.5)$$

The resulting offsetScaledLogVariance is  $4E5D_{16}$ .

### IX.3.2 Computation of offsetScaledLogVariance for a T-GM timed by an ePRTC

The logarithm to base 2 of PTPVAR expressed in units of  $\text{s}^2$  is computed and the result is multiplied by  $2^8$  to produce a scaled value.

$$\begin{aligned} \log_2(PTPVAR) &= \frac{\ln(1.271 \times 10^{-16})}{\ln 2} = -52.8049 \\ 2^8 \log_2(PTPVAR) &= \frac{(256)\ln(1.271 \times 10^{-16})}{\ln 2} = -13518.0507 \cong -13518 \end{aligned} \quad (IX.6)$$

Representing the above as a signed integer in 2s complement form produces

$$13518 = 34CE_{16} \Rightarrow CB31_{16} \text{ (1s complement form)} \Rightarrow CB32_{16} \text{ (2s complement form)} \quad (IX.7)$$

Adding  $8000_{16}$  to the above and ignoring any overflow produces

$$CB32_{16} + 8000_{16} = 14B32_{16} \Rightarrow 4B32_{16} \quad (IX.8)$$

The resulting offsetScaledLogVariance is  $4B32_{16}$ .

## Appendix X

### Description of a T-BC extended clockClass application

(This appendix does not form an integral part of this Recommendation.)

Table 3 of [ITU-T G.8275.1] defines a T-BC extended clockClass application. This appendix describes the purpose of this extended application, and its corresponding value amendments, including defaultDS data set member specifications of Annex A of [ITU-T G.8275.1] (corresponding to Table A.1) and T-BC Announce message contents of Appendix V of [ITU-T G.8275.1] (corresponding to Table V.3).

#### X.1 Purpose of T-BC extended clockClass application

PTP is the only synchronization source in an [IEEE 1588] network, therefore the clockClass values have been only applied to the PTP clock for indicating its inherent characteristics. The clockClass in Table 5 of the [IEEE 1588-2008] and Table 4 of [IEEE 1588-2019], such as 6,7,52,187, only represents the T-GM. The clockClass may not reflect the change of synchronization states in the T-BCs deployed in the network.

Since it is possible that there are two separate synchronization sources (GNSS time and physical frequency) in a telecom network, an extension mechanism of the clockClass range to cover the case of both T-GM and T-BC changes is provided. The definition of the clockClass values is extended into two parts:

- 1) for a T-GM, the range of clockClass includes 6, 7, 140, 150 and 160. The clockClass values of 140/150/160 represent the time output of T-GM when it is in time holdover instead of tracking to GNSS. The time quality is consistent with the clock quality of the frequency category 1, 2, and 3 respectively;
- 2) for a T-BC, the clockClass includes 135 and 165. The value of 135 means that when a T-BC is in time holdover, the output time signal is within specification, clockClass 165 means that the output time signal is out of time holdover specification.

The case of two separated sources has been considered in [ITU-T G.8271.1] HRM-2 and HRM-3. In order to extend the advantages of two separated sources, it is better to treat a T-BC differently when it is traceable to frequency of a different quality. The clockClass of 165 could be assigned to a T-BC when the T-BC is traceable to a frequency in QL-SEC, and the T-BC could share the clockClass value of 140/150/160 with the T-GM when it is traceable to a different quality of frequency. In this way, the appropriate T-BC can be selected to be the GM of the network so that better time signals can be sent to the end-users.

For a telecom network, it is crucial to make sure that the best clock selection principle is valid in any PTP network, especially in the case where there exists an isolated time region (which cannot receive any signals from the T-GM) in the network. In this region, if the T-BC has a preferred frequency quality, the T-BC can act as a T-GM and send out precise time/phase signals (where the signal quality is still close to UTC). In telecom networks, from the perspective of synchronization performance, any of the T-BCs could supersede the old T-GM to be the new PTP source of the network.

#### X.2 DefaultDS data set member specifications under this extended application

In some cases, the values of clockClass/accuracy/variance will likely be the same as that delivered by the announce packets from the T-GM and T-BC per Table 3/Note 3. As such, the T-BC should synchronize the T-GM. It is suitable for priority 2 to achieve this goal, and the range of priority 2 should be divided into two parts, 0-127 for the T-GM, 128-255 for the T-BC.

In this PTP profile, the clock attribute priority2 is configurable.

If this feature is used, then the *priority2* for the T-GM should be set to a lower value compared to T-BCs, in particular the range for *priority2* could be allocated as follows:

- for T-GM, the range {0-127};
- for T-BC, the range {128-255}.

As an example of a default value for *priority2*, it is suggested to set the T-GM to 100 and the T-BC to 128.

## Appendix XI

### Considerations on native access equipment

(This appendix does not form an integral part of this Recommendation.)

In some deployments, native access equipment such as xDSL, xPON, and microwave equipment may have implemented T-BC functionality. This appendix provides information on how such equipment may be modeled as a pair of T-BCs defined in this Recommendation. The following Figure XI.1 shows an example of equipment that is transferring the PTP timing between native PTP and native access media. Examples of such equipment may be an xPON OLT & ONU, an xDSL DSLAM & RT-DSLAM, or microwave equipment. Only one PTP port and one Special port are shown in the diagram, although the equipment may contain multiple ports. Within this simplified diagram there are two PTP ports on the T-BC; one is a normal PTP port and one is a Special PTP port. On both the PTP port and the Special PTP port, the Announce information and Signalling messages are handled according to normal T-BC operation. The difference is that on the PTP port, the timing messages (Sync, Delay\_Req, Delay\_Resp) are handled normally, while on the Special PTP port they are not present as they are replaced by native timing messages. If the timing flow hierarchy is known in advance (such as that of a PON OLT, which will only transfer timing downstream on its Special PTP ports) then the PTP ports, Special PTP ports, or the PTP clock may be configured with masterOnlytimeTransmitterOnly or slaveOnlytimeReceiverOnly parameters (such as a PON OLT configured with Special PTP ports as masterOnlytimeTransmitterOnly TRUE, or a PON ONU configured with slaveOnlytimeReceiverOnly TRUE).

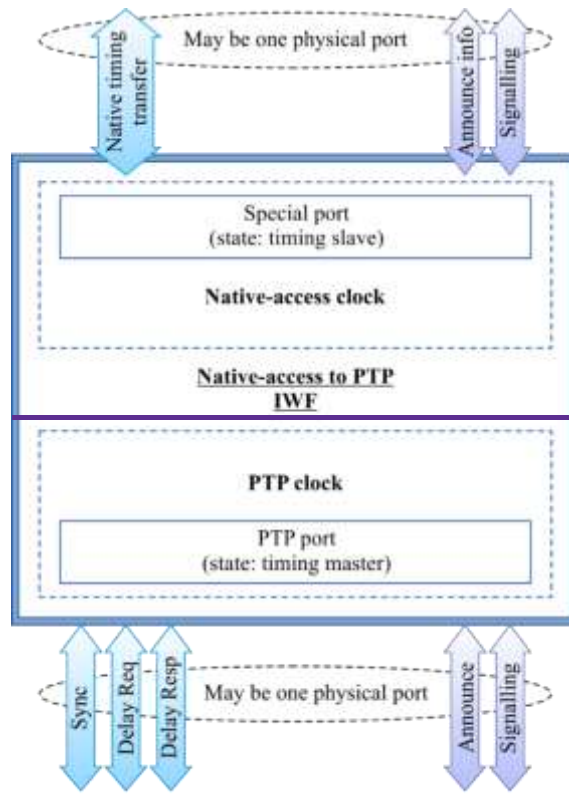

G.8275.1-Y.1369.1(16)-Amd.1(17)\_FXI.1

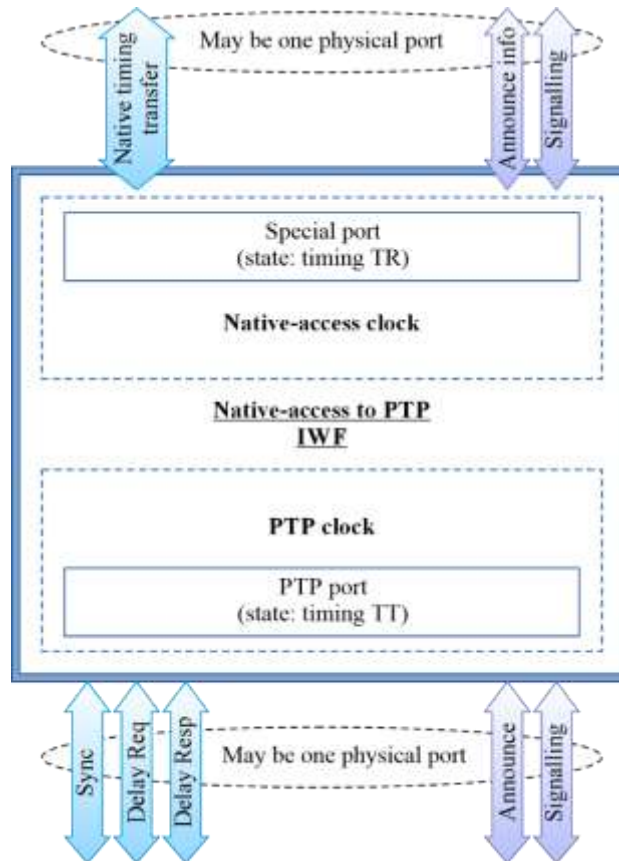

G.8275.1-Y.1369.1(22)-Amd.1(24)\_FXI.1

Figure XI.1 – Timing flow between native PTP and native access media

This appendix shows one possible way to model native access media (as a pair of T-BCs). Other ways to model native access media may exist.

## Appendix XII

### Monitoring alternate timeTransmittermaster time information provided by a peer PTP port

(This appendix does not form an integral part of this Recommendation.)

The contents of this appendix have been moved into Annex G.



## **Appendix XIII**

### **Considerations on the use of [IEEE 1588-2019]**

(This appendix does not form an integral part of this Recommendation.)

Considerations on the use of [IEEE 1588-2019] are discussed in Appendix IX of [ITU-T G.8275].

## Appendix XIV

### Considerations in an environment of more than two PTP ports on a single PTP communication path when using transparent clocks and multicast addressing

(This appendix does not form an integral part of this Recommendation.)

There are some aspects of PTP topology that are unique to a multicast environment that uses transparent clocks. When the network is restricted to ordinary and boundary clocks, each transport layer connection has only two PTP ports. On an ordinary clock or boundary clock each local PTP port will only ever communicate with one external PTP port. When transparent clocks are introduced, this situation changes and one local PTP port may communicate with more than one external PTP port.

In Figure XIV.1, PTP clocks A, B, and C are connected using a transparent clock. This makes the three PTP ports A.1, B.1, and C.1 endpoints of a single PTP communication path. Each of these ports shall have a portDS dataset within their respective clocks.

In this example, it is assumed that PTP ports A.1 and B.1 either have `masterOnlytimeTransmitterOnly` set to TRUE or, due to some transport layer distribution of Announce messages (not shown in Figure XIV.1) and/or the rules of the alternate BCMA of [ITU-T G.8275.1], both ports are in `MASTERTIME_TRANSMITTER` state. Both ports will transmit Announce messages advertising the quality of the grandmaster clocks they are using. Port C.1 will receive the Announce messages from ports A.1 and B.1 due to the transparent clock connection.

According to [IEEE 1588], port C.1 may use a foreign `timeTransmittermaster` table and compute an  $E_{r_{best}}$  based on the data of these two flows of Announce messages. In this example, the grandmaster information from port A.1 is better than the grandmaster information from port B.1. The `AlternateBMCABTCA` in clock C shall cause clock A to be the parent PTP instance, shall set `parentDS.parentPortIdentity` to be port A.1 and shall place port C.1 into `SLAVETIME_RECEIVER` state.

If there is a problem in the PTP communication between PTP port A.1 and PTP port C.1 then one of the events specified in clause 6.3.9 may be raised by clock C. These PTSF conditions may only apply to that PTP communication; there may be no such condition in the PTP communication between ports B.1 and C.1. Clock C should switch from using port A.1 to port B.1 as its source of timing.

If the PTP communication between Port A.1 and Port C.1 has a PTSF event, the Port C.1 should select the data set associated with the Port B.1 as its  $E_{r_{best}}$  data set instead of setting `portDS.SF` to TRUE. However, if both PTP communications with the Port A.1 and Port B.1 have a PTSF event, the Port C.1 should set `portDS.SF` to TRUE.

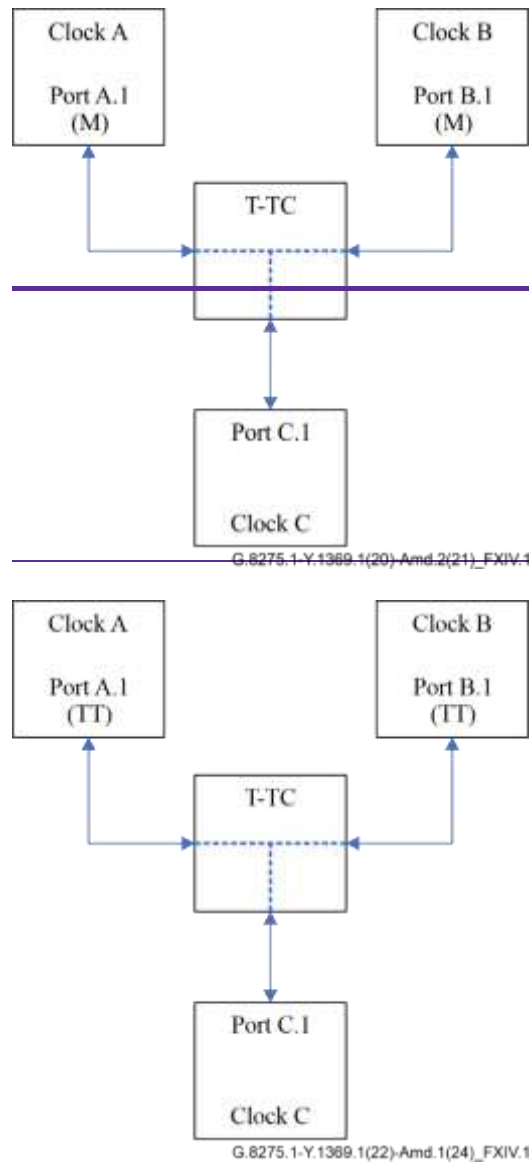

**Figure XIV.1 – Three PTP ports interconnected using a transparent clock with multicast addressing**

## Appendix XV

### Considerations of deploying ePRTC and PRTC in the network

(This appendix does not form an integral part of this Recommendation.)

In some deployment scenarios, both ePRTC and PRTC may be deployed in a same PTP network, e.g., an ePRTC in a central location in the network, and a PRTC closer to the end application. In this scenario, there could be several T-BCs between the ePRTC and the end application, and there will be PTP noise accumulation through the chain of T-BCs. Therefore, for the end application closer to a PRTC, it may be better to select the PRTC instead of an ePRTC due to the noise accumulation through the chain of T-BCs.

To allow the current Alternate [BMCABTCA](#) of this recommendation to choose a T-GM connected to a PRTC instead of an ePRTC in such deployment scenario as described above, operators may choose to use clock accuracy of 0x21 for the ePRTC instead of 0x20, and to use offsetScaledLogVariance of 0x4E5D for the ePRTC instead of 0x4B32.

NOTE – There may be other solutions to address this case (e.g., an Alternate [BMCABTCA](#) using an enhanced synchronization accuracy metrics TLV); they are for further study.

## Appendix XVI

### Considerations of using clockClass and priority2 in the synchronization network

(This appendix does not form an integral part of this Recommendation.)

In some deployment scenarios, when a T-GM fails, the Alternate BTCA is invoked and it may result in a T-BC in the middle of a chain to become the new T-GM, and this may not be desirable. This appendix addresses some use-cases and gives some approaches using priority2 and clockClass to achieve the desirable outcome from the Alternate BTCA.

NOTE – Additional considerations on the use of priority2 are provided in Appendix IV.

Use-Case 1 is depicted in Figure XVI.1. As an example, for this use-case, T-BC 1 does not support holdover within specification, and T-BC 2 to T-BC 20 all support holdover within specification.

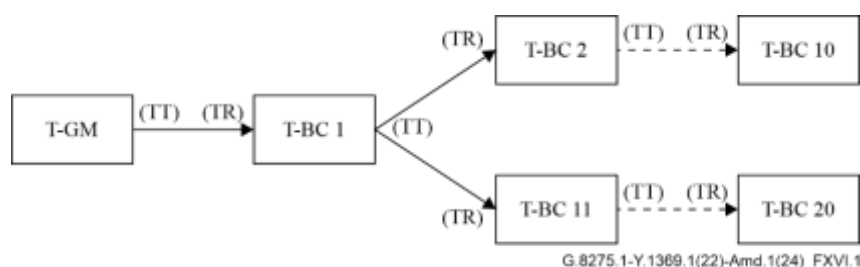

**Figure XVI.1 – Use-case 1**

If the defaultDS.clockQuality.clockClass of all T-BCs in the locked mode are upgraded to the value of the holdover mode, the clockClass for T-BC 1 would be 165 and for T-BC 2 to T-BC 20 would be 135. When T-GM fails, T-BC 1 goes into holdover and keeps its clockClass as 165. According to the Alternate BTCA specified in clause 6.3, the T-BC with the lowest clockIdentity within T-BC 2 to T-BC 20 will become the new T-GM, but a desirable topology could be to select T-BC 1 as the new T-GM.

In order to avoid the above issues, one approach is to use defaultDS.priority2 and set the holdover timer of T-BCs (see Note 1 of Table 3) to zero. In Figure XVII.1, the priority2 of T-BC 1 is set to a lower value than other T-BCs, and the holdover timer of all other T-BCs are set to zero.

Another approach is to set defaultDS.clockQuality.clockClass to 248 for T-BC in the locked mode. If a T-BC loses its input and goes into holdover, according to Appendix VII, it upgrades defaultDS.clockQuality.clockClass to 135 or 165. After this is done, when the T-GM is lost (see Figure XVI.1), T-BC 1 will be selected as their grandmaster.

Use-Case 2 is depicted in Figure XVI.2. As an example, for this use-case, all T-BCs support holdover within specification.

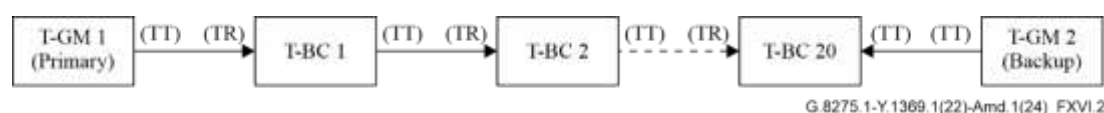

**Figure XVI.2 – Use-case 2**

Similarly, if the defaultDS.clockQuality.clockClass of all T-BCs in the locked mode are upgraded to the value of the holdover within specification, then clockClass for all T-BCs would be 135. When T-GM 1 fails, T-BC 1 goes into holdover and keeps its clockClass to 135. According to the Alternate BTCA specified in clause 6.3, the T-BC with the lowest clockIdentity within T-BC 1 to T-BC 20 will

become the new T-GM. Before T-GM 2 is selected, based on the order of clockIdentity of all T-BCs, the PTP topology may change several times until the synchronization topology is stable.

In order to avoid the above issues, one approach is to use defaultDS.priority2, and in this case, priority2 of T-BC 1 is set to a lower value than other T-BCs. Also, to account for failures in the other links, priority2 of each T-BC should be set accordingly to allow the desired synchronization topology.

Another approach is to also set defaultDS.clockQuality.clockClass to 248 for T-BC in the locked mode. If a T-BC loses its input and goes into holdover, according to Appendix VII, it upgrades defaultDS.clockQuality.clockClass to 135 or 165. After this is done, when the T-GM 1 is lost, then T-BC 1 will become the new T-GM until the T-GM 2 is selected.

## Appendix XVII

### Aspects of Ethernet switching and T-BC functionality within a network element

(This appendix does not form an integral part of this Recommendation.)

To ensure consistent and correct operation in a PTP network, it is important when configuring a PTP T-BC that all physical ports on the network element carrying PTP messages also have an associated PTP port. This is especially important when using the forwardable PTP MAC address. Not following this guideline can cause instability of the PTP network and/or time errors exceeding the intended performance of the network.

NOTE – If the forwardable address is not in the MAC address filtering database, this is equivalent to having a PTP-unaware device forwarding all ingress PTP messages with the forwardable PTP MAC address, regardless of the value of defaultDS.instanceEnable and portDS.enable.

## Bibliography

- [b-IEEE 802.1AX] IEEE 802.1AX (2020), *IEEE Standard for Local and metropolitan area networks – Link Aggregation*.
- [b-Bregni] Stefano Bregni, (2002), *Synchronization of Digital Telecommunications Networks*, Wiley.
- [b-Lesage] Paul Lesage and Theophane Ayi (1984), *Characterization of Frequency Stability: Analysis of the Modified Allan Variance and Properties of Its Estimate*, IEEE Transactions on Instrumentation and Measurement, Vol. IM-33, No. 4 (included in [b-Sullivan] as paper D.6).
- [b-Sullivan] D.B. Sullivan, D.W. Allan, D.A. Howe, and F.L. Walls (1990), *Characterization of Clocks and Oscillators*, NIST Technical Note 1337.
- [b-Walls] F.L. Walls, John Gary, Abbie O'Gallagher, Roland Sweet, and Linda Sweet (1991), *Time Domain Frequency Stability Calculated from the Frequency Domain Description: Use of the SIGINT Software Package to Calculate Time Domain Frequency Stability from the Frequency Domain*, NIST Report NISTR 89-3916 Revised (revision of 1989 version of this report).



## ITU-T Y-SERIES RECOMMENDATIONS

### Global information infrastructure, Internet protocol aspects, next-generation networks, Internet of Things and smart cities

GLOBAL INFORMATION INFRASTRUCTURE	Y.100-Y.999
INTERNET PROTOCOL ASPECTS	Y.1000-Y.1999
General	Y.1000-Y.1099
Services and applications	Y.1100-Y.1199
Architecture, access, network capabilities and resource management	Y.1200-Y.1299
<b>Transport</b>	<b>Y.1300-Y.1399</b>
Interworking	Y.1400-Y.1499
Quality of service and network performance	Y.1500-Y.1599
Signalling	Y.1600-Y.1699
Operation, administration and maintenance	Y.1700-Y.1799
Charging	Y.1800-Y.1899
IPTV over NGN	Y.1900-Y.1999
NEXT GENERATION NETWORKS	Y.2000-Y.2999
FUTURE NETWORKS	Y.3000-Y.3499
CLOUD COMPUTING	Y.3500-Y.3599
BIG DATA	Y.3600-Y.3799
QUANTUM KEY DISTRIBUTION NETWORKS	Y.3800-Y.3999
INTERNET OF THINGS AND SMART CITIES AND COMMUNITIES	Y.4000-Y.4999

*For further details, please refer to the list of ITU-T Recommendations.*

## SERIES OF ITU-T RECOMMENDATIONS

Series A	Organization of the work of ITU-T
Series D	Tariff and accounting principles and international telecommunication/ICT economic and policy issues
Series E	Overall network operation, telephone service, service operation and human factors
Series F	Non-telephone telecommunication services
<b>Series G</b>	<b>Transmission systems and media, digital systems and networks</b>
Series H	Audiovisual and multimedia systems
Series I	Integrated services digital network
Series J	Cable networks and transmission of television, sound programme and other multimedia signals
Series K	Protection against interference
Series L	Environment and ICTs, climate change, e-waste, energy efficiency; construction, installation and protection of cables and other elements of outside plant
Series M	Telecommunication management, including TMN and network maintenance
Series N	Maintenance: international sound programme and television transmission circuits
Series O	Specifications of measuring equipment
Series P	Telephone transmission quality, telephone installations, local line networks
Series Q	Switching and signalling, and associated measurements and tests
Series R	Telegraph transmission
Series S	Telegraph services terminal equipment
Series T	Terminals for telematic services
Series U	Telegraph switching
Series V	Data communication over the telephone network
Series X	Data networks, open system communications and security
<b>Series Y</b>	<b>Global information infrastructure, Internet protocol aspects, next-generation networks, Internet of Things and smart cities</b>
Series Z	Languages and general software aspects for telecommunication systems