

Recommendation

ITU-T G.9804.3 (2021) Amd. 2 (03/2024)

SERIES G: Transmission systems and media, digital systems and networks

Access networks – Optical line systems for local and access networks

50-Gigabit-capable passive optical networks (50G-PON): Physical media dependent (PMD) layer specification
Amendment 2

ITU-T G-SERIES RECOMMENDATIONS
Transmission systems and media, digital systems and networks

INTERNATIONAL TELEPHONE CONNECTIONS AND CIRCUITS	G.100-G.199
GENERAL CHARACTERISTICS COMMON TO ALL ANALOGUE CARRIER-TRANSMISSION SYSTEMS	G.200-G.299
INDIVIDUAL CHARACTERISTICS OF INTERNATIONAL CARRIER TELEPHONE SYSTEMS ON METALLIC LINES	G.300-G.399
GENERAL CHARACTERISTICS OF INTERNATIONAL CARRIER TELEPHONE SYSTEMS ON RADIO-RELAY OR SATELLITE LINKS AND INTERCONNECTION WITH METALLIC LINES	G.400-G.449
COORDINATION OF RADIOTELEPHONY AND LINE TELEPHONY	G.450-G.499
TRANSMISSION MEDIA AND OPTICAL SYSTEMS CHARACTERISTICS	G.600-G.699
DIGITAL TERMINAL EQUIPMENTS	G.700-G.799
DIGITAL NETWORKS	G.800-G.899
DIGITAL SECTIONS AND DIGITAL LINE SYSTEM	G.900-G.999
MULTIMEDIA QUALITY OF SERVICE AND PERFORMANCE – GENERIC AND USER-RELATED ASPECTS	G.1000-G.1999
TRANSMISSION MEDIA CHARACTERISTICS	G.6000-G.6999
DATA OVER TRANSPORT – GENERIC ASPECTS	G.7000-G.7999
PACKET OVER TRANSPORT ASPECTS	G.8000-G.8999
ACCESS NETWORKS	G.9000-G.9999
Metallic access networks	G.9700-G.9799
Optical line systems for local and access networks	G.9800-G.9899
In premises networks	G.9900-G.9999

For further details, please refer to the list of ITU-T Recommendations.

Recommendation ITU-T G.9804.3

50-Gigabit-capable passive optical networks (50G-PON): Physical media dependent (PMD) layer specification

Amendment 2

Summary

Recommendation ITU-T G.9804.3 describes a 50-Gigabit-capable passive optical network (50G PON) system in an optical access network for residential, business, mobile backhaul and other applications. This system operates over a point-to-multipoint optical access infrastructure at the nominal line rate of 50 Gbit/s in the downstream direction. In the upstream direction, 12.5 Gbit/s, 25 Gbit/s and 50 Gbit/s nominal line rates are defined. This Recommendation contains the references, the common definitions, acronyms, abbreviations and the specifications of the physical media dependent layer of the 50G-PON system.

Amendment 1 defines a third upstream wavelength "option 3" to support triple WDM coexistence with both GPON and XG(S)-PON, optical interface parameters of 50 Gbit/s upstream direction, optical interface parameters for non-MPM use cases, and the ONU out-of-band power spectral density requirements.

Amendment 2 defines the optical interface parameters of 50 Gbit/s upstream direction on further power budget classes besides N1 class.

History *

Edition	Recommendation	Approval	Study Group	Unique ID
1.0	ITU-T G.9804.3	2021-09-06	15	11.1002/1000/14714
1.1	ITU-T G.9804.3 (2021) Amd. 1	2023-02-22	15	11.1002/1000/15160
1.2	ITU-T G.9804.3 (2021) Amd. 2	2024-03-22	15	11.1002/1000/15822

Keywords

50-Gigabit-capable, 50G-PON, coexistence, line rates, multi-PON module (MPM), passive optical network (PON), physical medium dependent (PMD), transmitter and dispersion eye closure (TDEC).

* To access the Recommendation, type the URL <https://handle.itu.int/> in the address field of your web browser, followed by the Recommendation's unique ID.

FOREWORD

The International Telecommunication Union (ITU) is the United Nations specialized agency in the field of telecommunications, information and communication technologies (ICTs). The ITU Telecommunication Standardization Sector (ITU-T) is a permanent organ of ITU. ITU-T is responsible for studying technical, operating and tariff questions and issuing Recommendations on them with a view to standardizing telecommunications on a worldwide basis.

The World Telecommunication Standardization Assembly (WTSA), which meets every four years, establishes the topics for study by the ITU-T study groups which, in turn, produce Recommendations on these topics.

The approval of ITU-T Recommendations is covered by the procedure laid down in WTSA Resolution 1.

In some areas of information technology which fall within ITU-T's purview, the necessary standards are prepared on a collaborative basis with ISO and IEC.

NOTE

In this Recommendation, the expression "Administration" is used for conciseness to indicate both a telecommunication administration and a recognized operating agency.

Compliance with this Recommendation is voluntary. However, the Recommendation may contain certain mandatory provisions (to ensure, e.g., interoperability or applicability) and compliance with the Recommendation is achieved when all of these mandatory provisions are met. The words "shall" or some other obligatory language such as "must" and the negative equivalents are used to express requirements. The use of such words does not suggest that compliance with the Recommendation is required of any party.

INTELLECTUAL PROPERTY RIGHTS

ITU draws attention to the possibility that the practice or implementation of this Recommendation may involve the use of a claimed Intellectual Property Right. ITU takes no position concerning the evidence, validity or applicability of claimed Intellectual Property Rights, whether asserted by ITU members or others outside of the Recommendation development process.

As of the date of approval of this Recommendation, ITU had received notice of intellectual property, protected by patents/software copyrights, which may be required to implement this Recommendation. However, implementers are cautioned that this may not represent the latest information and are therefore strongly urged to consult the appropriate ITU-T databases available via the ITU-T website at <http://www.itu.int/ITU-T/ipr/>.

© ITU 2024

All rights reserved. No part of this publication may be reproduced, by any means whatsoever, without the prior written permission of ITU.

Table of Contents

	Page
1	Scope..... 1
2	References..... 1
3	Definitions 2
3.1	Terms defined elsewhere 2
3.2	Terms defined in this Recommendation 5
4	Abbreviations and acronyms 6
5	Conventions 7
6	Architecture of the optical access network 7
6.1	Classes for optical path loss 9
6.2	Categories for fibre differential distance 9
7	This clause is intentionally left blank 9
8	This clause is intentionally left blank 9
9	Optical network requirements..... 9
9.1	Layered structure of optical network..... 9
9.2	PMD layer requirements for the 50G-PON..... 10
10	X/S tolerance of 50G-PON ONU and OLT..... 36
10.1	Versatile WDM configuration 37
11	Upstream physical layer overhead 39
	Appendix I Relationship between OMA, penalty, extinction ratio and average power 40
	Appendix II Physical layer measurements required to support optical layer supervision 43
	Appendix III Allocation of the physical layer overhead time 44
	Appendix IV Relationship among optical interface parameters for 49.7664 Gbit/s downstream..... 47
	Bibliography..... 48

Recommendation ITU-T G.9804.3

50-Gigabit-capable passive optical networks (50G-PON): Physical media dependent (PMD) layer specification

Amendment 2

Editorial note: This is a complete-text publication. Modifications introduced by this amendment are shown in revision marks relative to Recommendation ITU-T G.9804.3 (2021) and its Amendment 1.

1 Scope

This Recommendation pertains to flexible access networks using optical fibre technology. The focus is primarily on a network supporting services with bandwidth requirements ranging from those of voice traffic to data services running at up to 50 Gbit/s. Also included are broadcast services.

This Recommendation describes the characteristics of the physical medium dependent (PMD) layer of an optical access network (OAN) with the capability of transporting various services between the user–network interface and the service node interface.

The OAN considered in this Recommendation enables the network operator to provide a flexible upgrade to meet future customer requirements, in particular, in the area of the optical distribution network (ODN). The ODN considered is based on a point-to-multipoint tree and branch option.

2 References

The following ITU-T Recommendations and other references contain provisions which, through reference in this text, constitute provisions of this Recommendation. At the time of publication, the editions indicated were valid. All Recommendations and other references are subject to revision; users of this Recommendation are therefore encouraged to investigate the possibility of applying the most recent edition of the Recommendations and other references listed below. A list of the currently valid ITU-T Recommendations is regularly published. The reference to a document within this Recommendation does not give it, as a stand-alone document, the status of a Recommendation.

- [ITU-T G.652] Recommendation ITU-T G.652 (2016), *Characteristics of a single-mode optical fibre cable.*
- [ITU-T G.657] Recommendation ITU-T G.657 (2016), *Characteristics of a bending loss insensitive single mode optical fibre and cable for the access network.*
- [ITU-T G.902] Recommendation ITU-T G.902 (1995): *Framework Recommendation on functional access networks (AN) – Architecture and functions, access types, management and service node aspects.*
- [ITU-T G.959.1] Recommendation ITU-T G.959.1 (~~2018~~2024), *Optical transport network physical layer interfaces.*
- [ITU-T G.982] Recommendation ITU-T G.982 (1996), *Optical access networks to support services up to the ISDN primary rate or equivalent bit rates.*
- [ITU-T G.983.1] Recommendation ITU-T G.983.1 (2005), *Broadband optical access systems based on Passive Optical Networks (PON).*
- [ITU-T G.984.2] Recommendation ITU-T G.984.2 (2019), *Gigabit-capable Passive Optical Networks (G-PON): Physical Media Dependent (PMD) layer specification.*
- [ITU-T G.984.5] Recommendation ITU-T G.984.5 (2022), *Gigabit-capable passive optical networks (G-PON): Enhancement band.*

[ITU-T G.987]	Recommendation ITU-T G.987 (2012), <i>10-Gigabit-capable passive optical network (XG-PON) systems: Definitions, abbreviations and acronyms.</i>
[ITU-T G.989]	Recommendation ITU-T G.989 (2015), <i>40-Gigabit-capable passive optical networks (NG-PON2): Definitions, abbreviations and acronyms.</i>
[ITU-T G.989.2]	Recommendation ITU-T G.989.2 (2019), <i>40-Gigabit-capable passive optical networks 2 (NG-PON2): Physical media dependent (PMD) layer specification – Amendment 1.</i>
[ITU-T G.9804.1]	Recommendation ITU-T G.9804.1 (2019), <i>Higher speed passive optical networks – Requirements – Amendment 1.</i>
[ITU-T G.9804.2]	Recommendation ITU-T G.9804.2 (2021), <i>Higher speed passive optical networks: Common transmission convergence layer specification.</i>
[ITU-T G.9807.1]	Recommendation ITU-T G.9807.1 (2023), <i>10-Gigabit-capable symmetric passive optical network (XGS-PON).</i>
[ITU-T L.313]	Recommendation ITU-T L.313/L.66 (2007), <i>Optical fibre cable maintenance criteria for in-service fibre testing in access networks.</i>
[IEEE 802.3]	IEEE 802.3-2022, <i>IEEE Standard for Ethernet.</i>

3 Definitions

3.1 Terms defined elsewhere

This Recommendations uses the following terms defined elsewhere:

3.1.1 10-Gigabit-capable PON encapsulation method (XGEM) [ITU-T G.9804.1]: A data frame transport scheme that is connection-oriented and that supports fragmentation of user data frames into variable sized transmission fragments.

3.1.2 10-Gigabit-capable passive optical network (XG(S)-PON) [ITU-T G.9804.1]: A PON system supporting nominal transmission rates on the order of 10 Gbit/s in at least one direction, and implementing the suite of protocols specified in ITU-T G.987.x series of Recommendations (XG-PON) or in the ITU-T G.9807.1 (XGS-PON), as the realization of next generation passive optical network 1 (NG-PON1).

3.1.3 attenuation: See optical path loss.

3.1.4 coexistence element [ITU-T G.9804.1]: A bidirectional functional element used to connect passive optical network (PON) systems defined in different Recommendation series to the same optical distribution network (ODN).

3.1.5 consecutive identical digit (CID) immunity [ITU-T G.9807.1]: The longest continuous sequence of identical bits that can be present in a digital signal without causing degradation such that the system specifications are no longer met.

3.1.6 differential fibre distance dynamic range [ITU-T G.9804.1]: An optical receiver characteristic that is equal to the ratio of the receiver overload to the receiver sensitivity.

3.1.7 dispersion [ITU-T G.9804.1]: A physical phenomenon comprising the dependence of the phase or group velocity of a light wave in the medium on its propagation characteristics such as optical frequency (wavelength) or polarization mode.

3.1.8 dynamic bandwidth assignment (DBA) [ITU-T G.9804.1]: A process by which the optical line terminal (OLT) distributes upstream passive optical network (PON) capacity between the traffic-bearing entities within optical network units (ONUs), based on the dynamic indication of their traffic activity and their configured traffic contracts.

3.1.9 extinction ratio [ITU-T G.9804.1]: With respect to a digital On-Off keying signal generated by an optical transmitter, the ratio of the average optical power level at the centre of the binary digit corresponding to the high intensity of light to the average optical power level at the centre of a binary digit corresponding to the low intensity of light. For the burst mode signal, averaging is performed over the time periods when the transmitter is enabled but excluding the associated transient times (see clause 5.13 in [ITU-T G.9804.1]). For the continuous mode signal, averaging is performed over the entire signal string.

3.1.10 fibre differential distance [ITU-T G.9804.1]: The absolute difference between the fibre distances of any two given paths between the R/S and S/R [or S/Rm] reference points in the same ODN.

3.1.11 gigabit-capable passive optical network (G-PON) [ITU-T G.9804.1]: A PON system supporting transmission rates in excess of 1 Gbit/s in at least one direction and implementing the suite of protocols specified in the ITU-T G.984.x series of Recommendations.

3.1.12 jitter (timing jitter) [b-ITU-T G.810]: The short-term variations of the significant instants of a timing signal from their ideal positions in time (where short-term implies that these variations are of frequency greater than or equal to 10 Hz).

3.1.13 line code [ITU-T G.9804.1]: In the higher speed PON (HSP) context, a code that transforms a binary digital signal into an amplitude- and time-discrete waveform for transmission over a physical channel.

3.1.14 nominal line rate [ITU-T G.9804.1]: The total number of bits that can be physically transferred per unit of time over a communication link. Nominal line rate accounts for useful data as well as for all possible protocol overheads and necessarily exceeds the effective data rate on any given protocol level.

3.1.15 ODN fibre distance class [ITU-T G.9807.1]: A categorization of an optical distribution network (ODN) based on the predefined values of minimum and maximum fibre distance between the S/R [or S/Rm] and any of R/S reference points.

3.1.16 ODN optical path loss class (ODN class) [ITU-T G.9804.1]: A categorization of an optical distribution network (ODN) based on the predefined values of minimum and maximum optical path loss over all possible paths between the S/R [or S/Rm] and any of the R/S reference points and over all possible operating wavelengths of a specific PON system.

3.1.17 optical access network (OAN) [ITU-T G.987]: A part of an access network whose network elements are interconnected by optical communication channels.

NOTE – An OAN may or may not extend all the way to the UNI, so that the user-side interface of the OAN does not necessarily coincide with the UNIs of the AN.

3.1.18 optical distribution network (ODN) [ITU-T G.9804.1]: A point-to-multipoint optical fibre infrastructure. A simple ODN is entirely passive and is represented by a single-rooted point-to-multipoint tree of optical fibres with splitters, combiners, filters and possibly other passive optical components. A composite ODN consists of two or more passive segments interconnected by active devices, each of the segments being either an optical trunk line segment or an optical distribution segment. A passive optical distribution segment is a simple ODN itself. Two ODNs with distinct roots can share a common subtree.

3.1.19 optical distribution segment (ODS) [ITU-T G.9804.1]: A simple optical distribution network (ODN), that is, a point-to-multipoint optical fibre infrastructure that is entirely passive and is represented by a single-rooted tree of optical fibres with splitters, combiners, filters, and possibly other passive optical components.

3.1.20 optical line termination (OLT) [ITU-T G.9804.1]: A network element in an ODN-based optical access network that terminates the root of at least one optical distribution network (ODN) and provides an optical access network (OAN) service node interface (SNI).

3.1.21 optical modulation amplitude (OMA) [ITU-T G.9807.1]: The absolute difference between the optical power of a logic one level and the optical power of a logic zero level. See Appendix I of [ITU-T G.9807.1] for more details on OMA.

3.1.22 optical network unit (ONU) [ITU-T G.9804.1]: A network element in an ODN-based optical access network that terminates a leaf of the optical distribution network (ODN) and provides an optical access network (OAN) user-network interface (UNI).

3.1.23 optical path loss: The reduction in the optical power of light having traversed the ODN expressed as a ratio in decibel units. This loss may be caused by the fibre, connectors, splices, splitters, wavelength couplers, attenuators, and other passive optical components.

3.1.24 optical path penalty (OPP) [ITU-T G.9804.1]: The apparent degradation of receiver sensitivity due to impairments from fibre transmission and apparent increase in ODN loss due to Raman depletion. The optical path penalty accounts for the effects of reflections, inter-symbol interference, mode partition noise, fibre dispersion, and fibre non-linearities.

3.1.25 optical return loss (ORL) [ITU-T G.9804.1]: The total reflection at the source reference point of the optical signal propagation path, measured as a ratio of the transmitted optical power to the reflected optical power.

3.1.26 out-of-band power spectral density (OOB-PSD) [b-ITU-T G.987.2]: The optical power spectral density outside the operating wavelength band measured at the appropriate reference point (S/R for downstream direction, R/S for upstream direction).

NOTE – Measurements are averaged over the time periods when the transmitter is enabled, or when the transmitter is not enabled but the allocated transient time has not yet elapsed, and these are expressed as the total integrated power within a sliding spectral window of defined width.

3.1.27 passive optical network (PON) system [ITU-T G.9804.1]: A combination of network elements in an ODN-based optical access network that includes an optical trunk line and one or more optical network unions and implements a particular coordinated suite of physical medium dependent layer, transmission convergence layer, and management protocols.

3.1.28 reflectance [ITU-T G.9804.1]: The reflection from any single discrete reflection point in the optical signal propagation path, which is defined to be the ratio of the reflected optical power present at a point, to the optical power incident to that point.

3.1.29 side mode suppression ratio [ITU-T G.9804.1]: The ratio of the power of the largest peak of the transmitter spectrum to that of the second largest peak. The second largest peak may be next to the main peak, or far removed from it. Within this definition, spectral peaks that are separated from the largest peak by the clock frequency are not considered to be side modes.

3.1.30 tolerance to reflected optical power [ITU-T G.9804.1]: A transmitter parameter that characterizes the maximum admissible ratio of the average reflected optical transmit power incident at the transmitter to the average optical transmit power.

3.1.31 transmission container (T-CONT) [ITU-T G.9804.1]: A traffic-bearing object within an optical network unit (ONU) that represents a group of logical connections, is managed via the ONU management and control channel (OMCC), and, through its TC layer Alloc-ID, is treated as a single entity for the purpose of upstream bandwidth assignment on the passive optical network (PON).

3.1.32 XG-PON [ITU-T G.9804.1]: Asymmetric 10-Gigabit Passive Optical Network.

3.1.33 XGS-PON [ITU-T G.9804.1]: A variant of 10-Gigabit-capable passive optical network system that operates at a nominal line rate of 10 Gbit/s downstream and upstream, implementing the suite of protocols specified in [ITU-T G.9807.1].

3.2 Terms defined in this Recommendation

This Recommendation defines the following terms:

3.2.1 differential optical path loss: The absolute difference between the optical losses, expressed in decibel units, of any two given paths between the R/S and S/R for channel group (S/R-CG) reference points in the same optical distribution network (ODN).

NOTE – Definition based on the one provided in [ITU-T G.9804.1].

3.2.2 fibre distance: The overall length of fibre (and, if applicable, equivalent fibre runs representing delay-inducing components) between the R/S and S/R for channel group (S/R-CG) reference points.

NOTE – Definition based on the one provided in [ITU-T G.9804.1].

3.2.3 mask of transmitter eye diagram: A general method of transmitter pulse shape characterisation that allows the combined specification of rise time, fall time, pulse overshoot/undershoot, ringing and jitter to ensure satisfactory operation with a compliant receiver. Transmitter mask compliance is required at the appropriate reference point (S/R for channel group (S/R-CG) for downstream, R/S for upstream).

NOTE – Definition based on the one provided in [ITU-T G.9804.1].

3.2.4 mean launch optical power: An optical transmitter characteristic expressing the average optical power of an optical signal transmitted into the fibre and carrying a given digital sequence, referring to the optical power of an individual wavelength channel at the appropriate reference point (S/R or S/R_m for downstream direction, R/S for upstream direction). When specified as a range, the minimum mean launch optical power provides the power level that the transmitter should guarantee at all times, and the maximum mean launch optical power provides the power level that the transmitter should never exceed. When applied to burst mode transmission, the term pertains to the time interval during which the transmitter is enabled and excludes possible starting and ending transient behaviour.

NOTE – Definition based on the one provided in [ITU-T G.9804.1].

3.2.5 overload: A receiver parameter equal to the maximum average received optical power that produces the specified bit error ratio (BER) reference level, referring to the optical power of an individual wavelength channel at the appropriate reference point (S/R-CG for upstream direction, R/S for downstream direction) measured with the worst-case signal, but without the optical path impairments.

NOTE – Definition based on the one provided in [ITU-T G.9804.1].

3.2.6 sensitivity: A receiver parameter equal to the minimum average received optical power that produces the specified bit error ratio (BER) reference level, referring to the optical power of an individual wavelength channel at the appropriate reference point (S/R-CG for upstream direction, R/S for downstream direction) measured with the worst-case signal, but without the optical path impairments.

NOTE – Definition based on the one provided in [ITU-T G.9804.1].

3.2.7 transmitter and dispersion eye closure (TDEC): TDEC is an optical transmitter quality metric derived using histograms extracted from the eye diagram. The optical transmitter is measured using a waveform monitoring device in a set-up that emulates the worst-case channel, including fibre, reference receiver and equalizer.

3.2.8 transmitter disable time: For a burst-mode transmitter, the allocated transient time on de-assertion of the TxEnable signal, measured in bit periods with respect to the transmitter nominal line rate.

NOTE – This definition is the same as that for transmitter disable transient time in [ITU-T G.9804.1].

3.2.9 transmitter enable time: For a burst-mode transmitter, the allocated transient time on assertion of the TxEnable signal, measured in bit periods with respect to the transmitter nominal line rate.

NOTE – This definition is the same as that for transmitter enable transient time in [ITU-T G.9804.1].

3.2.10 transmitter eye closure (TEC): TEC is an optical transmitter quality metric derived using histograms extracted from the eye diagram. The optical transmitter is measured using the same method as TDEC but without the optical path impairments.

3.2.11 transceiver option: The nomenclature given to distinguish two or more optional sets of optical specifications, any of which will satisfy the physical layer requirements of the optical distribution network (ODN) class. Note that there is no requirement for interoperability between multiple transceiver options.

4 Abbreviations and acronyms

This Recommendation uses the following abbreviations and acronyms:

APD	Avalanche Photodiode
BER	Bit Error Ratio
CE _x	Coexistence Element Type x (x = 1, 2, etc.)
CID	Consecutive Identical Digits
CRU	Clock Recovery Unit
DBA	Dynamic Bandwidth Assignment
DC	Direct Current
DD	Differential Distance
ER	Extinction Ratio
FEC	Forward Error Correction
FFE	Feedforward Equalizer
FFS	For Further Study
HSP	Higher Speed PON
LDPC	Low-density Parity Check
MPM	Multi-PON Module
NRZ	Non-Return to Zero
OAM	Operation, Administration and Maintenance
OAN	Optical Access Network
ODN	Optical Distribution Network
ODS	Optical Distribution Segment
O/E	Optical-to-electrical
OLT	Optical Line Terminal
OMA	Optical Modulation Amplitude
ONU	Optical Network Unit
OPL	Optical Path Loss

OPP	Optical Path Penalty
ORL	Optical Return Loss
PHY	Physical interface
PIN	Positive Intrinsic Negative (photodiode type)
PMD	Physical Medium Dependent
PON	Passive Optical Network
PSBu	Physical Synchronization Block, upstream
QoS	Quality of Service
R/S	Receive/Send reference point at the interface of the ONU to the ODN
Rx	Receiver
SLM	Single Longitudinal Mode (laser type)
S/R	Send/Receive reference point at the OLT side
S/Rm	Send/Receive reference point at the OLT side for MPM case
SSPR	Short Stressed Pattern Random
T-CONT	Transmission Container
TC	Transmission Convergence
TDEC	Transmitter and Dispersion Eye Closure
TEC	Transmitter Eye Closure
TDM	Time Division Multiplexing
Tx	Transmitter
UI	Unit Interval
WBF	Wavelength Blocking Filter
WDM	Wavelength Division Multiplexing
XG-PON	Asymmetric 10-Gigabit Passive Optical Network (ITU-T G.987 series)
XGS-PON	Symmetric 10-Gigabit Passive Optical Network [ITU-T G.9807.1]
XG(S)-PON	XG-PON or XGS-PON
XGEM	10-Gigabit-capable PON Encapsulation Method
X/S	Crosstalk-to-Signal Ratio

5 Conventions

See clause 5 of [ITU-T G.9804.1].

6 Architecture of the optical access network

When a PON system is migrated from a legacy PON to a 50G-PON, there can be several approaches, among which are the OLT multi-PON module (MPM) method [ITU-T G.984.5] Appendix IV, and the external wavelength division multiplexing (WDM) method [ITU-T G.984.5] Appendix I.

Figure 6-1 shows the general architectural reference diagram of 50G-PON coexisting with legacy PON using the OLT MPM method (see below for a definition of the reference points in the figure).

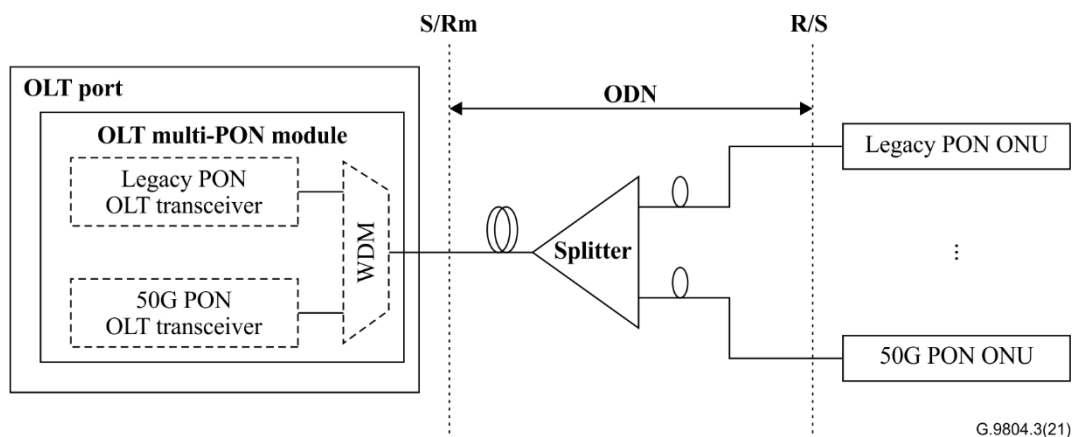

G.9804.3(21)

Figure 6-1 – General architectural reference diagram of 50G-PON coexisting with legacy PON using the OLT MPM method

Figure 6-2 shows the general architectural reference diagram of 50G-PON coexisting with legacy PON using the external coexistence element type x (CEx) method (see below for a definition of the reference points in the figure). When there is no coexistence requirement, the 50G-PON OLT may use a direct ODN connection.

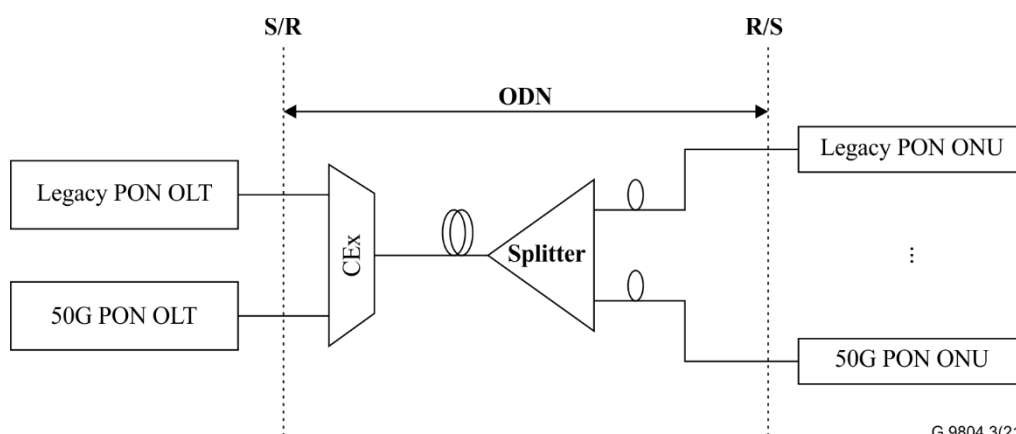

G.9804.3(21)

Figure 6-2 – General architectural reference diagram of 50G-PON coexisting with legacy PON using the external CEx method

The following reference points are defined in Figure 6-1 and Figure 6-2:

- S: Point on the optical fibre just after the OLT [Downstream]/ONU [Upstream] optical connection point (i.e., optical connector or optical splice).
- R: Point on the optical fibre just before the ONU [Downstream]/OLT [Upstream] optical connection point (i.e., optical connector or optical splice).
- S/Rm: Combination of points S and R existing simultaneously at the common port of WDM in a single fibre in the OLT MPM method, when operating in bidirectional mode.
- R/S: Combination of points R and S existing simultaneously in a single fibre, when operating in bidirectional mode.
- S/R: Combination of points S and R existing simultaneously in a single fibre in non-MPM and direct ODN connection use cases, when operating in bidirectional mode.

The two directions for optical transmission in the ODN are identified as follows:

- Downstream direction for signals travelling from the OLT to the ONU(s), and
- Upstream direction for signals travelling from the ONU(s) to the OLT.

Transmission in downstream and upstream directions takes place on the same fibre and components (duplex/diplex configuration).

6.1 Classes for optical path loss

The classes for optical path loss using the OLT MPM method and external CEx method (or direct ODN connection method) are shown in Table 6-1 and Table 6-2, respectively.

Table 6-1 – ODN optical path loss classes (ODN classes) for the OLT MPM method

OPL class	Class N1	Class C+
Minimum optical path loss	14 dB	17 dB
Maximum optical path loss	29 dB	32 dB

Table 6-2 – ODN optical path loss classes (ODN classes) for non-MPM use cases using external CEx or direct ODN connection methods

OPL class	Class N1	Class N2	Class E1	Class E2
Minimum optical path loss	14 dB	16 dB	18 dB	20 dB
Maximum optical path loss	29 dB	31 dB	33 dB	35 dB

6.2 Categories for fibre differential distance

The categories for fibre differential distance (DD) are shown in Table 6-3.

Table 6-3 – Categories for fibre DD defined in this Recommendation

	DD20	DD40
Maximum differential distance	20 km	40 km
NOTE – Specifications for DD40 are FFS.		

7 This clause is intentionally left blank

8 This clause is intentionally left blank

9 Optical network requirements

9.1 Layered structure of optical network

The protocol reference model is divided into the physical medium, as defined in this Recommendation, transmission convergence (TC) [ITU-T G.9804.2] and path layers (see [ITU-T G.902]). An example applied to 50G-PON is shown in Table 9-1.

Table 9-1 – Layered structure of 50G-PON protocol reference model

Path layer			
Transmission medium layer (see Note)	TC layer	Service adaptation	XGEM encapsulation
		Framing and PHY adaptation	DBA XGEM port bandwidth allocation QoS handling and T-CONT management Privacy and security Frame alignment Ranging Burst synchronization Bit/byte synchronization
	PMD layer		Electrical/Optical adaptation WDM Fibre connection
NOTE – The transmission medium layer provides the related OAM functions.			

9.2 PMD layer requirements for the 50G-PON

All parameters are specified as follows, and are in accordance with Tables 9-5 to 9-8.

All parameter values specified are worst-case values to be met over the range of standard operating conditions (i.e., temperature and humidity), and include ageing effects. The parameters are specified relative to an optical section design objective of a bit error ratio (BER) not worse than the values specified in Tables 9-5 to 9-8, for the extreme case of optical path attenuation and dispersion conditions.

9.2.1 Line rate

The transmission line rate is a multiple of 8 kHz. This Recommendation defines a downstream line rate of 49.7664 Gbit/s and three upstream line rates shown in Table 9-2.

Table 9-2 – 50G-PON Line rates

Direction	Units	Line rate
Downstream	Gbit/s	49.7664
Upstream	Gbit/s	49.7664
	Gbit/s	24.8832
	Gbit/s	12.4416

9.2.1.1 Downstream frequency accuracy

When the OLT and its timing source are in their normal operating state, the OLT is typically traceable to a Stratum-1 reference (accuracy of 1×10^{-11}). When the OLT is in its free-running mode, the accuracy of the downstream signal is at least that of a Stratum-4 clock (3.2×10^{-5}). Those OLTs intended for timing-critical applications such as mobile backhaul may require Stratum-3 clock (4.6×10^{-6}) quality in free-running mode.

NOTE – The OLT may derive its timing either from a dedicated timing signal source or from a synchronous data interface (line timing). A packet-based timing source may also be used.

9.2.1.2 Upstream frequency accuracy

When in one of its operating states and granted an allocation, the ONU shall transmit its signal with frequency accuracy equal to that of the received downstream signal, with jitter limited to the values defined in clause 9.2.9.7.

9.2.2 Forward error correction (FEC) code selection for 50G-PON

The forward error correction (FEC) codes used for 50G-PON are indicated in Table 9-3a and Table 9-3b for the default and optional FEC codes, respectively.

Table 9-3a – Default FEC code (FEC code 0) used for 50G-PON

Direction	Line rate	Type	Notation	FEC code [ITU-T G.9804.2]
Downstream	49.7664 Gbit/s	LDPC	LDPC (17280, 14592)	Annex B
Upstream	49.7664 Gbit/s	LDPC	LDPC (17280, 14592)	Annex B
	24.8832 Gbit/s	LDPC	LDPC (17280, 14592)	Annex B
	12.4416 Gbit/s	LDPC	LDPC (17280, 14592)	Annex B

Table 9-3b – Optional FEC codes used for 50G-PON upstream

Upstream Line Rate	FEC Code Identifier	Notation	FEC code [ITU-T G.9804.2]
12.4416 Gbit/s	FEC code 1	LDPC (15872, 14592)	Annex B
	FEC code 2	LDPC (HM1, HM2)	Annex B
24.8832 Gbit/s	FEC code 1	LDPC (15872, 14592)	Annex B
	FEC code 2	LDPC (HM1, HM2)	Annex B
49.7664 Gbit/s	FEC code 1	LDPC (15872, 14592)	Annex B
	FEC code 2	LDPC (HM1, HM2)	Annex B

The values of HM1 and HM2 are specified in [ITU-T G.9804.2].

9.2.3 Physical media and transmission method

9.2.3.1 Transmission medium

This Recommendation is based on the fibre described in [ITU-T G.652]. Other fibre types may be compatible with this Recommendation, e.g., [ITU-T G.657] fibre used, for example, for in-building cabling, drop section.

9.2.3.2 Transmission direction

The signal is transmitted both upstream and downstream through the transmission medium.

9.2.3.3 Transmission methodology

Bidirectional transmission is accomplished by the use of WDM technique on a single fibre.

9.2.4 Line code and interleaving

The scrambling method and any interleaving method (if applicable) are defined in [ITU-T G.9804.2].

The convention used for optical logic levels is:

- High level of light emission for a binary ONE;

- Low level of light emission for a binary ZERO.

9.2.4.1 Downstream

Downstream line coding for 50G-PON: Scrambled NRZ with optional interleaving.

The scrambling method is defined in clause 10.4.1 of [ITU-T G.9804.2].

The interleaving method is defined in clause 10.5 of [ITU-T G.9804.2]:

- Interleaving is optionally on – at the discretion of the OLT.
- Interleaving Depth $D = 4$.

9.2.4.2 Upstream

Upstream line coding for 50G-PON:

12.4416 Gbit/s: Scrambled NRZ,

24.8832 Gbit/s: Scrambled NRZ,

49.7664 Gbit/s: Scrambled NRZ.

The scrambling method is defined in clause 10.4.2 of [ITU-T G.9804.2].

NOTE – Interleaving in the upstream direction for 12.4416 Gbit/s, 24.8832 Gbit/s and 49.7664 Gbit/s upstream line rates is not used.

9.2.5 Operating wavelength

9.2.5.1 Downstream wavelength allocation

The operating wavelength range for 50G-PON for the downstream direction is defined in Table 9-5.

9.2.5.2 Upstream wavelength allocation

The operating wavelength range for 50G-PON for the upstream direction is defined in Tables 9-6 to 9-8.

9.2.6 50G-PON PMD parameters

9.2.6.1 50G-PON compatible ODN

50G-PON shall operate over an ODN whose parameters are described by Table 9-4a. Table 9-4a shows the physical parameters of the optical distribution segment (ODS). Table 9-4b shows the 3 bits ODN class encoding in PON-ID (PIT) for 50G-PON; for more details see clause 10.1.1.3 in [ITU-T G.9804.2].

Table 9-4a – Physical parameters of a simple ODN (ODS)

Item	Unit	Specification
Fibre type (Note)	–	[ITU-T G.652] or compatible
Attenuation range (as defined in clause 6.1)	MPM-based coexistence	dB Class N1: 14–29 Class C+: 17–32
	Non-MPM use cases using external CEx or direct ODN connection methods	dB Class N1: 14–29 Class N2: 16–31 Class E1: 18–33 Class E2: 20–35
Maximum fibre distance between S/R (or S/Rm) and R/S points	km	DD20: 20 DD40: 40

Table 9-4a – Physical parameters of a simple ODN (ODS)

Item	Unit	Specification
Minimum fibre distance between S/R (or S/Rm) and R/S points	km	0
Bidirectional transmission	–	1-fibre WDM
Maintenance wavelength	nm	[ITU-T L.313]
NOTE – See clause 9.2.3.1		

Table 9-4b – ODN optical path loss (OPL) class encoding

Code value	ODN OPL class
000	N1
001	N2
010	E1
011	E2
100	C+
101-111	Reserved

9.2.6.2 Optical interface parameters of 49.7664 Gbit/s downstream direction

Table 9-5 – Optical interface parameters of 49.7664 Gbit/s downstream direction

Item	Unit	Value	
OLT transmitter (optical interface S/Rm)			
Nominal line rate	Gbit/s	49.7664	
Operating wavelength	nm	1340–1344	
Line code	–	NRZ	
Mask of the transmitter eye diagram	–	See clause 9.2.7.6.1	
Maximum reflectance at S/Rm, measured at transmitter wavelength	dB	NA	
Minimum ORL of ODN (Note 1)	dB	32	
ODN Class		N1	C+
Mean launch power minimum (Note 2)	dBm	+5.5 (Note 3)	+8.5 (Note 4)
Mean launch power maximum	dBm	+11	+14
Launch power in OMA minus TDEC (min) (Note 5)	dBm	+4.75	+7.75
Maximum transmitter and dispersion eye closure (TDEC) (Note 5)	dB	5	
Launch optical power without input to the transmitter	dBm	NA	
Minimum extinction ratio (Note 6)	dB	7	
Transmitter tolerance to reflected optical power (Note 7)	dB	More than –15	

Table 9-5 – Optical interface parameters of 49.7664 Gbit/s downstream direction

Item	Unit	Value	
Dispersion range (DD20)	ps/nm	0~77.1	
Minimum side mode suppression ratio	dB	30	
Maximum differential optical path loss	dB	15	
Jitter generation	–	See clause 9.2.9.7.3	
ONU receiver (optical interface R/S)			
Maximum optical path penalty (DD20) (Note 8)	dB	3.5	
Maximum reflectance at R/S, measured at receiver wavelength	dB	–20	
Bit error ratio reference level (Notes 9, 10)	–	1.0E-2	
ODN class		N1	C+
Sensitivity at BER reference level (Note 11)	dBm	–24.0	–24.0
OMA Sensitivity at BER reference level	dBm	–22.75	–22.75
Overload at BER reference level (Note 12)	dBm	–3	–3
Consecutive identical digit immunity	bit	72	
Jitter tolerance	–	See clause 9.2.9.7.2	
Receiver tolerance to reflected optical power	dB	Less than 10	
<p>NOTE 1 – There are optional cases where the "minimum ORL of ODN at S/Rm and R/S" can be as low as 20 dB. (See Appendix I of [ITU-T G.983.1]).</p> <p>NOTE 2 – A lower "mean launch power minimum" is allowed but will be compensated by a higher extinction ratio, within the limits of the "Launch power in OMA minus TDEC (min)" value. If the actual TDEC is worse than 2.0 dB, it will be compensated by increasing the transmitter mean launch power minimum specification by X dB for each X dB of extra TDEC allowance, where $X \leq 3.0$ dB, while meeting all other Tx specifications.</p> <p>NOTE 3 – The mean launch power minimum value is consistent with a minimum "OMA minus TDEC" of +4.75 dBm when ER = 7 dB and TDEC = 2.0 dB. Even if the TDEC is lower than 2.0 dB, the mean launch power minimum should still exceed this value at 7 dB ER.</p> <p>NOTE 4 – The mean launch power minimum value is consistent with a minimum "OMA minus TDEC" of +7.75 dBm when ER = 7 dB and TDEC = 2.0 dB. Even if the TDEC is lower than 2.0 dB, the mean launch power minimum should still exceed this value at 7 dB ER.</p> <p>NOTE 5 – TDEC is measured, following the method in clause 9.2.7.8, using an appropriate fibre length to ensure the worst-case eye closure penalty over the full dispersion range.</p> <p>NOTE 6 – This "minimum extinction ratio" is the minimum value required to meet the "mean launch power minimum" value in this table. A lower extinction ratio is allowed if compensated by a larger transmitter launch power within the limits of the "mean launch power maximum" value. In no case should the ER be lower than 5 dB. A lower "mean launch power minimum" is allowed if compensated by a higher extinction ratio. For quantitative treatment examples of these tradeoffs, see Appendix I.</p> <p>NOTE 7 – Parameter known in [ITU-T G.984.2] as "tolerance to the transmitter incident light power".</p> <p>NOTE 8 – Optical path penalty is informative.</p> <p>NOTE 9 – See clause 9.4.1 of [b-ITU-T G.Sup39] for additional details on BER in FEC enabled applications.</p>			

Table 9-5 – Optical interface parameters of 49.7664 Gbit/s downstream direction

Item	Unit	Value
NOTE 10 – This BER reference level assumes hard-decision FEC decoding with interleaving defined in [ITU-T G.9804.2]. Without interleaving, this BER reference level may not achieve the target FEC output BER of 1e-12. When soft-decision FEC decoding is used, this value is higher.		
NOTE 11 – This Rx sensitivity is based on a transmitter with a transmitter eye closure (TEC) = 1.5 dB at 7 dB extinction ratio in back to back; it is equivalent to –22.75 dBm sensitivity in OMA. In addition, the Rx sensitivity in OMA with fibre, R(TDEC), should also comply with $R(TDEC) \leq \text{maximum} (-22.25, TDEC - 24.25)$ dBm using an appropriate fibre length to ensure the worst-case eye closure within the dispersion range. (For $TDEC \leq 5.0$ dB), see Figure 9-1.		
NOTE 12 – Overload is based on a received signal with worst-case TDEC.		

For the C+ OPL class, Figure 9-1 illustrates the relationship between TDEC and both the OLT transmitter power and the ONU receiver sensitivity specifications. Moreover, Appendix IV provides additional information on the relationship among between optical interface parameters specified in Table 9-5 for 49.7664 Gbit/s downstream.

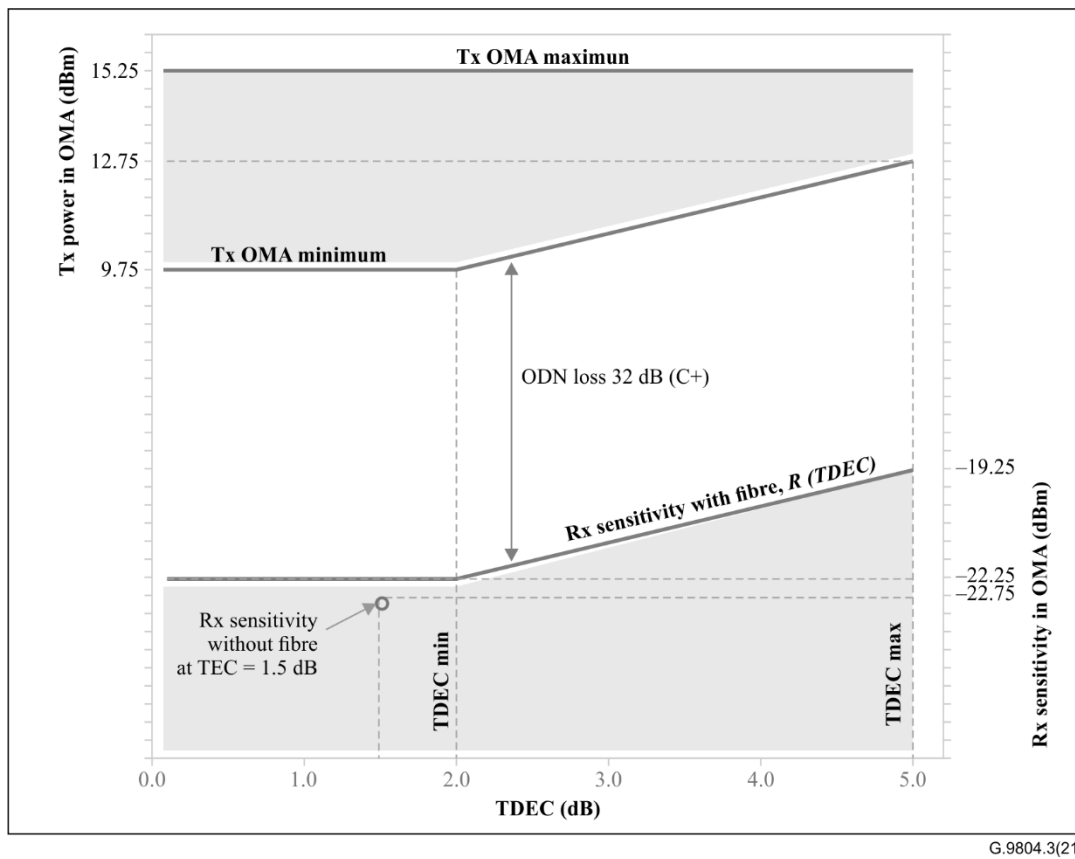

Figure 9-1 – Illustration of the relationship between transmitter power, receiver sensitivity and TDEC for 49.7664 Gbit/s downstream (C+ OPL class)

9.2.6.3 Optical interface parameters of upstream direction

Table 9-6 – Optical interface parameters of 12.4416 Gbit/s upstream direction

Item	Unit	Value
ONU transmitter (optical interface R/S)		
Nominal line rate	Gbit/s	12.4416

Table 9-6 – Optical interface parameters of 12.4416 Gbit/s upstream direction

Operating wavelength	nm	Option 1	Option 2	Option 3
		1260~1280	1290~1310	1284~1288
Line code	–	NRZ		
Mask of the transmitter eye diagram	–	See clause 9.2.7.6.2		
Maximum reflectance of equipment at R/S, measured at transmitter wavelength	dB	–10		
Minimum ORL of ODN (Note 1)	dB	32		
ODN Class		N1	C+	
Mean launch power minimum (Note 2)	dBm	+4.0	+4.0	
Mean launch power maximum	dBm	+9.0	+9.0	
Launch optical power without input to the transmitter	dBm	Less than –45		
Maximum Tx enable time (Note 3)	bits (ns)	1600 (~128.6)		
Maximum Tx disable time (Note 3)	bits (ns)	1600 (~128.6)		
Minimum extinction ratio (Note 2)	dB	6		
Transmitter tolerance to reflected optical power (Note 4)	dB	More than –15		
Dispersion range (DD20)	ps/nm	0 to –127.0 (option 1) –65.1 to 18.2 (option 2) 0 to –77.1 (option 3)		
Minimum side mode suppression ratio (Note 8)	dB	30		
Jitter transfer	–	See clause 9.2.9.7.1		
Jitter generation	–	See clause 9.2.9.7.3		
OLT receiver (optical interface S/Rm)				
ODN Class		N1	C+	
Maximum optical path penalty (DD20)	dB	1.0	1.0	
Maximum reflectance at S/Rm, measured at receiver wavelength	dB	–12		
Bit error ratio reference level (Note 5) (Note 6)	–	1.0E-2		
ODN class		N1	C+	
Sensitivity at BER reference level (Note 7)	dBm	–26.0	–29.0	
Overload at BER reference level	dBm	–5.0	–8.0	
Consecutive identical digit immunity	bit	72		
Jitter tolerance	–	See clause 9.2.9.7.2		
NOTE 1 – There are optional cases where the "minimum ORL of ODN at S/Rm and R/S" can be as low as 20 dB. (See Appendix I of [ITU-T G.983.1]).				
NOTE 2 – The minimum average launch power and the minimum ER are consistent with a minimum OMA of 4.78 dBm. (For further details, see Figure I.1.1 of Appendix I in [ITU-T G.9807.1]).				
NOTE 3 – As defined in clause 9.2.7.3.1. The values in nanoseconds are informative.				
NOTE 4 – Parameter known in [ITU-T G.984.2] as "tolerance to the transmitter incident light power".				

Table 9-6 – Optical interface parameters of 12.4416 Gbit/s upstream direction

NOTE 5 – See clause 9.4.1 of [b-ITU-T G.Sup39] for additional details on BER in FEC enabled applications.
NOTE 6 – This BER reference level assumes hard-decision FEC decoding with the default code. When soft-decision FEC decoding is used, this value is higher.
NOTE 7 – The sensitivity is based on ER = 6.0 dB received signal.
NOTE 8 – See clause 9.2.7.2.1 for additional requirements on ONU out-of-band power spectral density.

Table 9-7 – Optical interface parameters of 24.8832 Gbit/s upstream direction

Item	Unit	Value		
ONU transmitter (optical interface R/S)				
Nominal line rate	Gbit/s	24.8832		
Operating wavelength	nm	Option 1	Option 2	Option 3
		1260~1280	1290~1310 (wideband)	1284~1288
1298~1302 (narrowband)				
Line code	–	NRZ		
Mask of the transmitter eye diagram	–	See clause 9.2.7.6.2		
Maximum reflectance at R/S, measured at transmitter wavelength	dB	–10		
Minimum ORL of ODN (Note 1)	dB	32		
ODN Class		N1	C+	
Mean launch power minimum (Note 2)	dBm	+5	+5	
Mean launch power maximum	dBm	+9	+9	
Launch power in OMA minus OPP (min)				
– When ER < 6 dB	dBm	4.7	4.7	
– When ER ≥ 6 dB		4.5	4.5	
Launch optical power without input to the transmitter	dBm	Less than –45		
Maximum Tx enable time (Note 3)	Bits (ns)	3200 (~128.6)		
Maximum Tx disable time (Note 3)	Bits (ns)	3200 (~128.6)		
Minimum extinction ratio (Note 4)	dB	5		
Transmitter tolerance to reflected optical power (Note 5)	dB	More than –15		
Dispersion range (DD20)	ps/nm	0 to –127.0 (option 1) –65.1 to 18.2 (option 2 wide) –49.3 to 3.7 (option 2 narrow) 0 to –77.1 (option 3)		
Minimum side mode suppression ratio (Note 9)	dB	30		

Table 9-7 – Optical interface parameters of 24.8832 Gbit/s upstream direction

Item	Unit	Value	
Jitter transfer	–	See clause 9.2.9.7.1	
Jitter generation	–	See clause 9.2.9.7.3	
OLT receiver (optical interface S/Rm)			
Maximum optical path penalty (DD20)	dB	1.5	
Maximum reflectance at S/Rm, measured at receiver wavelength	dB	–12	
Bit error ratio reference level (Notes 6, 7)	–	1.0E-2	
ODN class		N1	C+
Sensitivity at BER reference level (Note 8)	dBm	–24.5	–27.5
Overload at BER reference level	dBm	–5	–8
Consecutive identical digit immunity	bit	72	
Jitter tolerance	–	See clause 9.2.9.7.2	
<p>NOTE 1 – There are optional cases where the "minimum ORL of ODN at S/Rm and R/S" can be as low as 20 dB. (See Appendix I of [ITU-T G.983.1].)</p> <p>NOTE 2 – The mean launch power minimum value is consistent with a minimum "OMA minus OPP" of 4.7 dBm when ER = 5 dB and OPP = 0.5 dB. A lower "mean launch power minimum" is allowed but will be compensated by a higher extinction ratio, within the limits of the "launch power in OMA minus OPP (min)" value. If the actual OPP is worse than 0.5 dB, it will be compensated by increasing the transmitter mean launch power minimum specification by X dB for each X dB of extra OPP allowance, where X < 1.0 dB while meeting all other Tx specifications. For a quantitative treatment of these tradeoffs, see Appendix I.</p> <p>NOTE 3 – As defined in clause 9.2.7.3.1. The values in nanoseconds are informative.</p> <p>NOTE 4 – A lower extinction ratio is allowed but will be compensated by a larger transmitter launch power within the limits of the "mean launch power maximum" value. A lower "mean launch power minimum" is allowed but will be compensated by a higher extinction ratio. For quantitative treatment of these trade-offs, see Appendix I.</p> <p>NOTE 5 – Parameter known in [ITU-T G.984.2] as "tolerance to the transmitter incident light power".</p> <p>NOTE 6 – See clause 9.4.1 of [b-ITU-T G.Sup39] for additional details on BER in FEC enabled applications.</p> <p>NOTE 7 – This BER reference level assumes hard-decision FEC decoding with the default code. When soft-decision FEC decoding is used, this value is higher.</p> <p>NOTE 8 – The sensitivity is based on ER = 5.0 dB received signal.</p> <p>NOTE 9 – See clause 9.2.7.2.1 for additional requirements on ONU out-of-band power spectral density.</p>			

Table 9-8 – Optical interface parameters of 49.7664 Gbit/s upstream direction

Item	Unit	Value			
ONU transmitter (optical interface R/S)					
Nominal line rate	Gbit/s	49.7664			
Operating wavelength	nm	Option 1	Option 2	Option 3	
		1260~1280	1290~1310	1284~1288	
Line code	–	NRZ			
Mask of the transmitter eye diagram	–	See clause 9.2.7.6.2			
Maximum reflectance at R/S, measured at transmitter wavelength	dB	–10			
Minimum ORL of ODN (Note 1)	dB	32			
ODN Class		N1		C+	
		<u>N1</u>	<u>N1b</u>	<u>C+</u>	<u>C+b</u>
<u>Transceiver option</u>					
Mean launch power minimum (Note 2, Note 3)	dBm	+6.8 (<u>Note 3</u>)	+76.8 <u>+A</u> (<u>Note 14</u> , <u>146</u>)	+6.8 (<u>Note 3</u>) S	+76.8 <u>+A</u> (<u>Note 14</u> , <u>146</u>)
Mean launch power maximum	dBm	+11.8	+11.8 <u>+M</u> (<u>Note 15</u>)	+11.8 <u>FFS</u>	+11.8 <u>+M</u> (<u>Note 15</u>)
Launch power in OMA minus TDEC (min)	dBm	+4.47	+54.4 <u>7+A</u> (<u>Note 14</u>)	+4.47 <u>FFS</u>	+54.4 <u>7+A</u> (<u>Note 14</u>)
Maximum transmitter and dispersion eye closure (TDEC) (Note 4)	dB	5			
Launch optical power without input to the transmitter	dBm	Less than -45			
Maximum Tx enable time (Note 5)	Bits (ns)	6400 (~128.6)			
Maximum Tx disable time (Note 5)	Bits (ns)	6400 (~128.6)			
Minimum extinction ratio (Note 6)	dB	5			
Transmitter tolerance to reflected optical power (Note 7)	dB	More than –15			
Dispersion range (DD20)	ps/nm	0 to –127.0 (option 1) –65.1 to 18.2 (option 2) 0 to –77.1 (option 3)			
Minimum side mode suppression ratio (Note 8)	dB	30			
Jitter transfer	–	See clause 9.2.9.7.1			
Jitter generation	–	See clause 9.2.9.7.3			
OLT receiver (optical interface S/Rm)					
Maximum optical path penalty (DD20)	dB	3.0			

Table 9-8 – Optical interface parameters of 49.7664 Gbit/s upstream direction

Item	Unit	Value			
(Note 9)					
Maximum reflectance at S/Rm, measured at receiver wavelength	dB	-12			
Bit error ratio reference level (Note 10, Note 11)	–	1.0E-2			
ODN class		N1		C+	
		<u>N1</u>	<u>N1b</u>	<u>C+</u>	<u>C+b</u>
Sensitivity at BER reference level (Note 12)	dBm	-22.7 (Note 12)	212.7 +A (Note 14, 168)	-25.7 (Note 157) FS	245.7 +A (Note 14, 197)
OMA Sensitivity at BER reference level	dBm	-22.53	212.5 3+A (Note 14)	25.53 FFS	245.5 3+A (Note 14)
Overload at BER reference level (Note 13)	dBm	-2.2	-2.2+ M (Note 15)	5.2 FFS S	-5.2+ M (Note 15)
Consecutive identical digit immunity	bit	72			
Jitter tolerance	–	See clause 9.2.9.7.2			
<p>NOTE 1 – There are optional cases where the "minimum ORL of ODN at S/Rm and R/S" can be as low as 20 dB. (See Appendix I of [ITU-T G.983.1].)</p> <p>NOTE 2 – A lower "mean launch power minimum" is allowed but will be compensated by a higher extinction ratio, within the limits of the "Launch power in OMA minus TDEC (min)" value. If the actual TDEC is worse than 2.5 dB, it will be compensated by increasing the transmitter mean launch power minimum specification by X dB for each X dB of extra TDEC allowance, where X ≤ 2.5 dB, while meeting all other Tx specifications.</p> <p>NOTE 3 – The mean launch power minimum value is consistent with a minimum "OMA minus TDEC" of 4.47dBm when ER = 5 dB and TDEC = 2.5dB. Even if the TDEC is lower than 2.5 dB, the mean launch power minimum should still exceed this value at 5 dB ER.</p> <p>NOTE 4 – TDEC is measured, following the method in clause 9.2.7.8, using an appropriate fibre length to ensure the worst-case eye closure penalty over the full dispersion range.</p> <p>NOTE 5 – As defined in clause 9.2.7.3.1. The values in nanoseconds are informative.</p> <p>NOTE 6 – This "minimum extinction ratio" is the minimum value required to meet the "mean launch power minimum" value in this table. A lower extinction ratio is allowed if compensated by a larger transmitter launch power within the limits of the "mean launch power maximum" value. A lower "mean launch power minimum" is allowed if compensated by a higher extinction ratio.</p> <p>NOTE 7 – Parameter known in [ITU-T G.984.2] as "tolerance to the transmitter incident light power".</p> <p>NOTE 8 – See clause 9.2.7.2.1 for additional requirements on ONU out-of-band power spectral density.</p> <p>NOTE 9 – Optical path penalty is informative.</p> <p>NOTE 10 – See clause 9.4.1 of [b-ITU-T G.Sup39] for additional details on BER in FEC enabled applications.</p> <p>NOTE 11 – This BER reference level assumes hard-decision FEC decoding with the default code and uncorrelated errors. When soft-decision FEC decoding is used, this value could be higher, while when</p>					

Table 9-8 – Optical interface parameters of 49.7664 Gbit/s upstream direction

Item	Unit	Value
<p>correlated errors are present, this value could be lower. The BER reference level should be correctable to 1E-12 BER or lower after FEC decoding.</p> <p>NOTE 12 – This Rx sensitivity is based on a transmitter with a transmitter eye closure (TEC) = 2.0 dB at 5 dB extinction ratio in back to back; it is equivalent to –22.53 dBm sensitivity in OMA. In addition, the Rx sensitivity in OMA with fibre, R(TDEC), should also comply with $R(TDEC) \leq \text{maximum} (-22.03, TDEC-24.53)$ dBm using an appropriate fibre length to ensure the worst-case eye closure within the dispersion range (for $TDEC \leq 5.0$ dB).</p> <p>NOTE 13 – Overload is based on a received signal with worst-case TDEC.</p> <p>NOTE 14 – A is FFS within the range 0.7 to 2 dB.</p> <p>NOTE 15 – M is FFS within the range 0 to 2 dB.</p> <p>NOTE 146 – The mean launch power minimum value is consistent with a minimum "OMA minus TDEC" of $54.47 + A$ dBm when ER = 5 dB and TDEC = 2.5 dB. Even if the TDEC is lower than 2.5 dB, the mean launch power minimum should still exceed this value at 5 dB ER.</p> <p>NOTE 157 – This Rx sensitivity is based on a transmitter with a transmitter eye closure (TEC) = 2.0 dB at 5 dB extinction ratio in back to back; it is equivalent to –25.53 dBm sensitivity in OMA. In addition, the Rx sensitivity in OMA with fibre, R(TDEC), should also comply with $R(TDEC) \leq \text{maximum} (-25.03, TDEC-27.53)$ dBm using an appropriate fibre length to ensure the worst-case eye closure within the dispersion range (for $TDEC \leq 5.0$ dB).</p> <p>NOTE 168 – This Rx sensitivity is based on a transmitter with a transmitter eye closure (TEC) = 2.0 dB at 5 dB extinction ratio in back to back; it is equivalent to $-212.53 + A$ dBm sensitivity in OMA. In addition, the Rx sensitivity in OMA with fibre, R(TDEC), should also comply with $R(TDEC) \leq \text{maximum} (-212.03 + A, TDEC-234.53 + A)$ dBm using an appropriate fibre length to ensure the worst-case eye closure within the dispersion range (for $TDEC \leq 5.0$ dB).</p> <p>NOTE 179 – This Rx sensitivity is based on a transmitter with a transmitter eye closure (TEC) = 2.0 dB at 5 dB extinction ratio in back to back; it is equivalent to $-245.53 + A$ dBm sensitivity in OMA. In addition, the Rx sensitivity in OMA with fibre, R(TDEC), should also comply with $R(TDEC) \leq \text{maximum} (-245.03 + A, TDEC-267.53 + A)$ dBm using an appropriate fibre length to ensure the worst-case eye closure within the dispersion range (for $TDEC \leq 5.0$ dB).</p>		

9.2.6.4 Optical interface parameters for non-MPM use cases

The key optical power parameters at the S/R reference point for non-MPM use cases using external CEx or direct ODN connection methods are shown in Table 9-8a.

Table 9-8a – Key optical power parameters at the S/R reference point for non-MPM use cases using external CEx or direct ODN connection methods

Source	Item	Unit	Value			
			N1	N2	E1	E2
	ODN class		N1	N2	E1	E2
49.7664Gbit/s Downstream OLT Transmitter	Mean launch power minimum (Note 1)	dBm	+5.5	+7.5	FFS	FFS
	Mean launch power maximum	dBm	+11	+13	FFS	FFS
	Launch power in OMA minus TDEC (min) (Note 2)	dBm	+4.75	+6.75	FFS	FFS
12.4416Gbit/s Upstream OLT Receiver	Sensitivity at BER reference level (Note 3)	dBm	-26.0	-28.0	FFS	FFS
	Overload at BER reference level	dBm	-5.0	-7.0	FFS	FFS
	Bit error ratio reference level	–	1.0E-2			FFS

Table 9-8a – Key optical power parameters at the S/R reference point for non-MPM use cases using external CEx or direct ODN connection methods

Source	Item	Unit	Value			
24.8832Gbit/s Upstream OLT Receiver	Sensitivity at BER reference level (Note 4)	dBm	-24.5	-26.5	FFS	FFS
	Overload at BER reference level	dBm	-5	-7	FFS	FFS
	Bit error ratio reference level	-	1.0E-2			FFS
49.7664Gbit/s Upstream OLT Receiver	Sensitivity at BER reference level (Note 5)	dBm	-22.7	FFS	FFS	FFS
	Overload at BER reference level	dBm	-2.2	FFS	FFS	FFS
	Bit error ratio reference level (Note 6)	-	1E-2	FFS	FFS	FFS

NOTE 1 – The mean launch power minimum value is consistent with the minimum "OMA minus TDEC" when ER = 7 dB and TDEC = 2.0 dB. Even if the TDEC is lower than 2.0 dB, the mean launch power minimum should still exceed this value at 7 dB ER.
A lower "mean launch power minimum" is allowed but will be compensated by a higher extinction ratio, within the limits of the "Launch power in OMA minus TDEC (min)" value. If the actual TDEC is worse than 2.0 dB, it will be compensated by increasing the transmitter mean launch power minimum specification by X dB for each X dB of extra TDEC allowance, where $X \leq 3.0$ dB, while meeting all other Tx specifications.

NOTE 2 – TDEC is measured, following the method in clause 9.2.7.8, using an appropriate fibre length to ensure the worst-case eye closure penalty over the full dispersion range.

NOTE 3 – The sensitivity is based on ER = 6.0 dB received signal.

NOTE 4 – The sensitivity is based on ER = 5.0 dB received signal.

NOTE 5 – This Rx sensitivity is based on a transmitter with a transmitter eye closure (TEC) = 2.0 dB at 5 dB extinction ratio in back to back; it is equivalent to -22.53 dBm sensitivity in OMA. In addition, the Rx sensitivity in OMA with fibre, R(TDEC), should also comply with $R(TDEC) \leq \text{maximum} (-22.03, TDEC-24.53)$ dBm using an appropriate fibre length to ensure the worst-case eye closure within the dispersion range (for $TDEC \leq 5.0$ dB).

NOTE 6 – This BER reference level assumes hard-decision FEC decoding with the default code and uncorrelated errors. When soft-decision FEC decoding is used, this value could be higher, while when correlated errors are present, this value could be lower. The BER reference level should be correctable to 1E-12 BER or lower after FEC decoding.

All the other PMD parameters for N1, N2, E1 classes for non-MPM use cases using external CEx or direct ODN connection methods are same as those for the OLT MPM method defined in Table 9-5 to Table 9-8.

9.2.7 Transmitter at S/R (or S/Rm) and R/S

All parameters are specified as follows, and are in accordance with Tables 9-5 to 9-8.

9.2.7.1 Source type

Considering the attenuation/dispersion characteristics of the target fibre channel, feasible transmitter devices include only single longitudinal mode (SLM) lasers. The indication of a nominal source type in this Recommendation is not a requirement, though it is also expected that only SLM lasers will meet all the distance and line rate requirements of the 50G-PON systems both for the downstream and upstream links.

The use of multilongitudinal mode (MLM) lasers is not contemplated in this Recommendation due to their practical distance/line-rate limitations.

9.2.7.2 Spectral characteristics

For SLM lasers, the laser is specified as its fibre dispersion range, the range over which the laser characteristics and fibre dispersion result in a defined penalty at a specified fibre distance, under standard operating conditions. Additionally, for control of mode partition noise in SLM systems, a minimum value for the laser side mode suppression ratio is specified. The actual spectral characteristics are limited by the maximum TDEC or amount of optical path penalty (OPP) produced with the worst-case optical dispersion in the data channel.

9.2.7.2.1 ONU out-of-band power spectral density

Co-existence with other PON systems (e.g., ITU-T G.984.x Series, ITU-T G.987.x Series, ITU-T G.9807.1, etc.) on the same ODN is a frequent requirement for PON system deployments. In such cases, light from ONU transmitters of one PON type may fall into the upstream operating wavelength band of a co-existing system. If the optical power of this out-of-band light (OOB) is too high, then this may cause harmful crosstalk penalties on the upstream transmissions of the co-existing PON systems. Such problems are exacerbated in PON ODNs where the differential loss is high such that the victim ONU is on a higher optical loss path and the interfering ONU is on a lower loss path.

To ensure successful operation in PON co-existence use cases, the out-of-band power spectral density (OOB-PSD) must be below a certain level. The OOB-PSD mask requirements for the ONU transmitter at the R/S interface are shown in Figure 9-1a and the required PSD mask values are given in Table 9-8b and Table 9-8c.

To meet with the mask requirement, the ONU PSD remains below the dashed mask line under all operating conditions. The in-band power limit (Y) is the maximum ONU launch power and the points at the ONU operating band edge (Y-SMSR) represent the power limit given by the ONU transmitter side-mode-suppression ratio (SMSR). The out-of-band PSD (X) is the power outside of the ONU operating wavelength band that may fall into co-existing PON upstream operating wavelength bands. The OOB-PSD spectral interval is 0.1 nm according to the industry convention for optical signal to noise measurement.

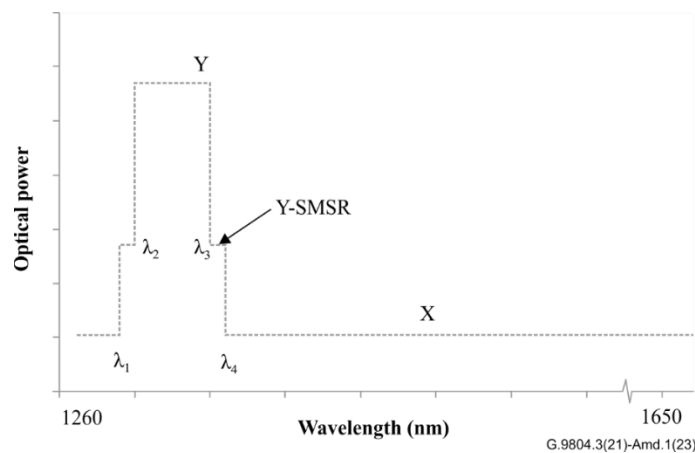

Figure 9-1a – ONU transmitter OOB-PSD mask definition

Table 9-8b – ONU OOB-PSD mask wavelengths

Wavelength	Option 1 Wavelength Set (nm)	Option 2 (Wideband) Wavelength Set (nm)	Option 2 (Narrowband) Wavelength Set (nm)	Option 3 Wavelength Set (nm)
λ_1	Not applicable	FFS	1288	1280
λ_2	1260	1290	1298	1284
λ_3	1280	1310	1302	1288
λ_4	FFS	1320	1312	1290

Table 9-8c – ONU OOB-PSD mask values

Mask range	Option 1	Option 2 (Wideband)	Option 2 (Narrowband)	Option 3
$1260\text{nm} \leq \lambda < \lambda_1$	–	X= –41.5 dBm	X= –41.5 dBm	X= –41.5 dBm
$\lambda_1 \leq \lambda < \lambda_2$	–	Y-SMSR	Y-SMSR	Y-SMSR
$\lambda_2 \leq \lambda \leq \lambda_3$	Y	Y	Y	Y
$\lambda_3 < \lambda \leq \lambda_4$	Y-SMSR	Y-SMSR	Y-SMSR	Y-SMSR
$\lambda_4 < \lambda \leq 1650 \text{ nm}$	X= –41.5 dBm	X= –41.5 dBm	X= –41.5 dBm	X= –41.5 dBm

Y= Mean launch power maximum as given in the ONU PMD parameter tables
SMSR= Minimum side mode suppression ratio as given in the ONU PMD parameter tables
NOTE –The OOB-PSD mask specification must be met under the full range of ODN conditions including reflections, as specified elsewhere in this Recommendation.
The mask wavelengths define the boundaries of measurement ranges. The entire 0.1nm measurement interval should lie inside a single range.

9.2.7.3 Mean launch power

The mean launch power at the optical interfaces S/R (or S/Rm) and R/S is the average power of a pseudo-random data sequence coupled into the fibre by the transmitter. It is given as a range to allow for some cost optimization and to cover all allowances for operation under standard operating conditions, transmitter connector degradation, measurement tolerances and ageing effects.

In the operating state, the lower figure is the minimum power to be provided and the higher one is the power that should not be exceeded.

NOTE – Measurement of the launch power at the R/S optical interface must take into account the bursty nature of the upstream traffic transmitted by the ONUs.

9.2.7.3.1 Launch optical power without input to the transmitter

In the upstream direction, the ONU transmitter should ideally launch no power into the fibre in all the bursts that are not assigned to that ONU. However, an optical power level less than or equal to the launch power without input to the transmitter is allowed during bursts that are not assigned to that ONU.

During the Tx enable bit period the transmit levels are not specified, provided they comply with the PMD tables 9-6 to 9-8. During the Tx disable bit period immediately following the assigned burst, the maximum launch power level allowed is the zero-level corresponding to the minimum extinction ratio specified in Tables 9-6 to 9-8.

The specification of the maximum number of Tx enable and Tx disable bit periods is provided in Tables 9-6 to 9-8.

The relationship between ONU power levels and burst times is shown in Figure 9-2.

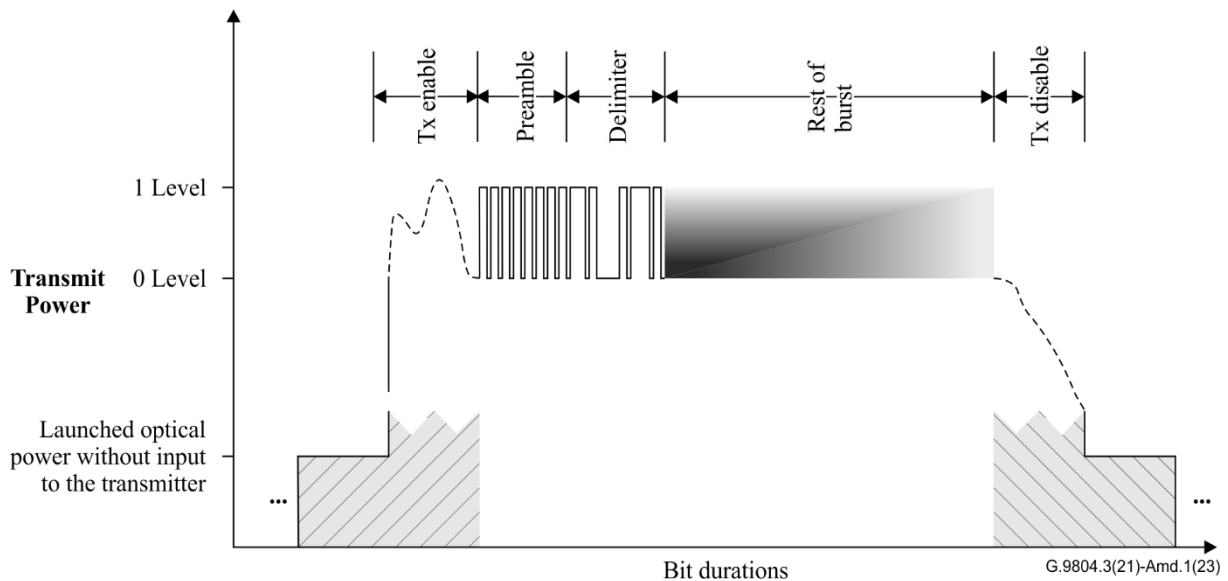

Figure 9-2 – Relationship between ONU power levels and burst times

9.2.7.4 Minimum extinction ratio

The ER is defined for 12.4416 Gbit/s and 24.8832 Gbit/s ONU transmitters as:

$$ER = 10 \log_{10} (A/B) \quad (9-1)$$

where A is the average optical power level at the centre of the binary 1 and B is the average optical power level at the centre of the binary 0.

The extinction ratio for the upstream direction burst mode signal is applied from the first bit of the preamble to the last bit of the burst signal inclusively.

NOTE – In the context of this PMD Recommendation, the generic term "preamble" refers to the portion of the upstream physical synchronization block (PSBu), without the delimiter delineating the burst payload. The PSBu is described in clause 10.2.1, Figure 10-6 in [ITU-T G.9804.2].

For 49.7664 Gbit/s OLT and ONU transmitters that pass the eye mask in clause 9.2.7.6.1 using an equalizer, the extinction ratio is defined as follows:

$$ER = 10 \log_{10} (P1/P0) \quad (9-2)$$

where:

- $P1$ is the average optical power over the middle 50 bits of the 72-bit sequence of one bits (see Figure 9-8) in a Short Stressed Pattern Random (SSPR) [b-OIF]
- $P0$ is the average optical power over the middle 50 bits of the 72-bit sequence of zero bits (see Figure 9-8) in an SSPR [b-OIF].

9.2.7.5 Maximum reflectance of equipment measured at transmitter wavelength

Reflections from equipment (ONU/OLT) back to the cable plant are specified by the maximum permissible reflectance of equipment measured at S/R, S/Rm or R/S, in accordance with Tables 9-4 to 9-8.

9.2.7.6 Mask of transmitter eye diagram

In this Recommendation, general transmitter pulse shape characteristics including rise time, fall time, pulse overshoot, pulse undershoot and ringing, all of which should be controlled to prevent excessive degradation of the receiver sensitivity, are specified in the form of a mask of the transmitter eye diagram at S/R, S/Rm or R/S. For the purpose of assessing the transmit signal, it is important to consider not only the eye opening but also the overshoot and undershoot limitations.

9.2.7.6.1 OLT transmitter

The parameters specifying the mask of the eye diagram (see Figure 9-3) for the OLT transmitter are shown in Table 9-9. The test set-up for the measurement of the mask of the eye diagram is shown in Figure 9-4. The waveform monitoring instrument includes a virtual feed forward equalizer (FFE) using 13 taps (symbol spaced) with coefficients optimized to minimize the eye closure of the measured waveform. The clock recovery unit (CRU) has a corner frequency of 4 MHz and a slope of 20 dB/decade. The CRU can be implemented in hardware or software depending on oscilloscope technology.

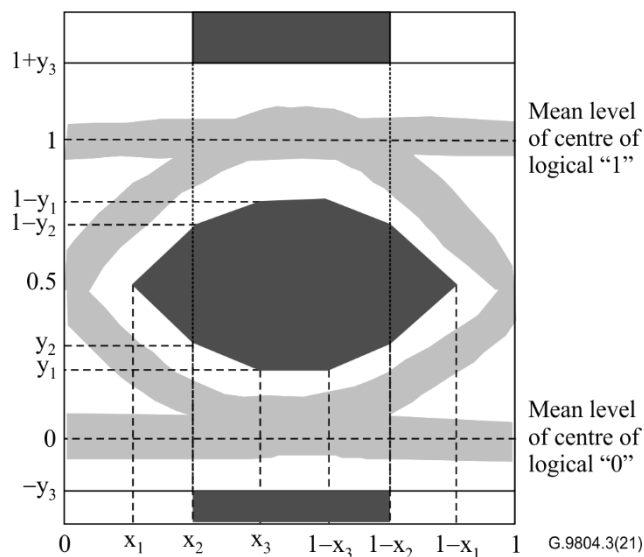

Figure 9-3 – Mask of the eye diagram for OLT transmitter

Table 9-9 – Mask of the eye diagram for OLT transmitter – Numeric values

	49.7664 Gbit/s
x1	0.25
x2	0.425
x3	0.45
y1	0.25
y2	0.28
y3	0.4
Maximum hit ratio	5×10^{-5}

NOTE – The values are taken from clause 7.2.2.14 of [ITU-T G.959.1], "NRZ 10G Ratio small". The "hit ratio" is the acceptable ratio of samples inside to outside the shaded area.

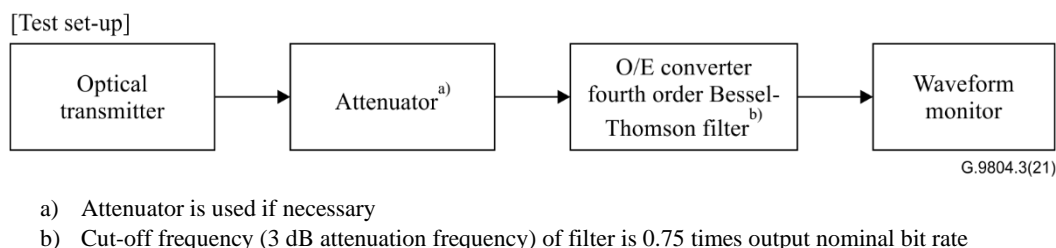

Figure 9-4 – Test set-up for mask of the eye diagram for OLT transmitter

For 49.7664 Gbit/s downstream, the fourth order Bessel-Thomson filter cut-off frequency is equal to 37.3 GHz.

9.2.7.6.2 ONU transmitter

The parameters specifying the mask of the eye diagram (see Figure 9-5) for the ONU transmitter are shown in Table 9-10. The test set-up for the measurement of the mask of the eye diagram is shown in Figure 9-6. The CRU has a corner frequency of 4 MHz and a slope of 20 dB/decade. The CRU can be implemented in hardware or software depending on oscilloscope technology.

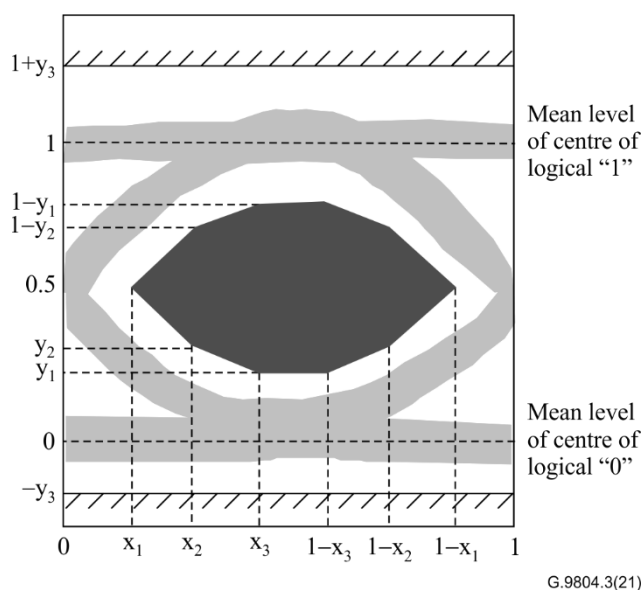

Figure 9-5 – Mask of the eye diagram for ONU transmitter

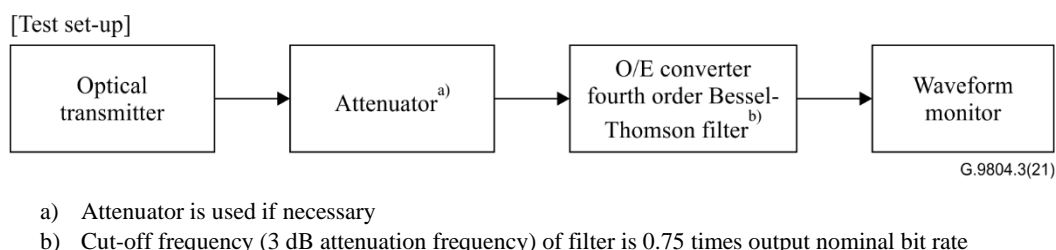

Figure 9-6 – Test set-up for mask of the eye diagram for ONU transmitter

Table 9-10 – Mask of the eye diagram for ONU transmitter – Numeric values

	12.4416 Gbit/s	24.8832 Gbit/s	49.7664 Gbit/s (Note 2, Note 3)
x1	0.25	0.31	0.36

Table 9-10 – Mask of the eye diagram for ONU transmitter – Numeric values

x2	0.40	0.40	0.425
x3	0.45	0.45	0.45
y1	0.25	0.34	0.40
y2	0.28	0.38	0.42
y3	0.40	0.40	0.40
Maximum hit ratio	5×10^{-5}	5×10^{-5}	5×10^{-5}
NOTE 1 – The "hit ratio" is the acceptable ratio of samples inside to outside the hatched/shaded area. NOTE 2 – The waveform monitoring instrument includes a virtual feed forward equalizer (FFE) using 7 taps (symbol spaced) with coefficients optimized to minimize the eye closure of the measured waveform. NOTE 3 – The temporal extent of the upper and lower mask regions are limited to the range between 0.425 and 0.575 in the case of the 49.7664 Gbit/s ONU.			

The mask of the eye diagram for the upstream direction burst mode signal is applied from the first bit of the preamble to the last bit of the burst signal inclusively.

9.2.7.7 Transmitter tolerance to reflected optical power

The specified transmitter performance must be met in the presence of the optical reflection level at reference point S specified in Tables 9-5 to 9-8.

9.2.7.8 Transmitter and dispersion eye closure

Transmitter and dispersion eye closure (TDEC) is a parameter used to characterize the quality of an optical transmitter. It measures vertical eye closure based on histogram data from eye diagrams captured in an oscilloscope with an optical-to-electrical converter. Within the test instrument, filtering is implemented to limit the bandwidth to that defined by a reference receiver. Furthermore, equalization of the captured (and filtered) waveform is performed inside the instrument using a virtual reference equalizer. The final TDEC value is determined by both the closure of the tested eye diagram after equalization and the noise enhancement factor of the equalizer. For background relating to the TDEC method described here, consult clauses 95.8.5 and 121.8.5.3 of [IEEE 802.3].

The TDEC method defined in this Recommendation is not exactly the same as that given clause 95.8.5 of [IEEE 802.3]. The key differences are that noise enhancement from the reference equalizer (similar to clause 121.8.5.3 of [IEEE 802.3]) and the noise properties of avalanche photodiode (APD) based receivers, as typically used in PON, are accounted for in the TDEC calculation in clause 9.2.7.8.1.

The general test set-up used for the measurement of TDEC is shown in Figure 9-7.

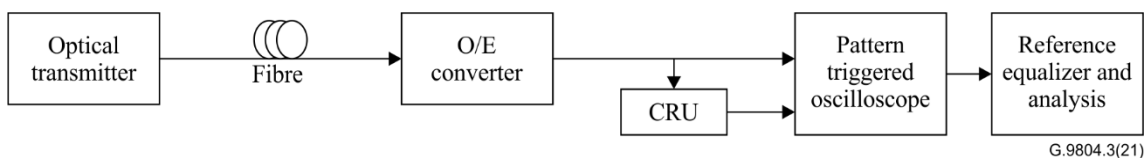

Figure 9-7 – Test set-up for TDEC measurement of an optical transmitter

The CRU has a corner frequency of 4 MHz and a slope of 20 dB/decade. The CRU can be implemented in hardware or software depending on oscilloscope technology.

9.2.7.8.1 OLT and ONU TDEC test method

For the 50G-PON OLT transmitter and 49.7664 Gbit/s ONU transmitter, the test set-up in Figure 9-7 is used with the following configuration:

- The test pattern applied to the optical transmitter is a SSPR pattern as defined in Annex 2.D.2 of OIF-CEI-04.0 [b-OIF].
- Optical-to-electrical (O/E) converters are assumed to be PIN photodiode.
- The overall response of the O/E converter and subsequent filtering matches a reference receiver with a fourth order Bessel-Thomson response with a 3 dB bandwidth of 18.75 GHz.
- A reference equalizer is applied to the waveform after filtering with the following characteristics: FFE with 13 symbol spaced taps for an OLT transmitter and FFE with 7 symbol spaced taps for a 49.7664 Gbit/s ONU transmitter. The tap weights of the reference equalizer are optimized to give a minimum mean-squared error for the eye closure.
- The fibre link for the test should be set up to emulate the worst-case link parameters, such as reflections, as specified in this Recommendation.
- For burst mode transmission, the O/E converter should have a minimized preamble overhead time. Following the transmitter enable transient time, a burst is further composed of a preamble to accommodate the O/E converter overhead time (if any), followed by the SSPR pattern. The bursts are spaced to approximate a 50% duty cycle. Only the SSPR pattern is processed to calculate the TDEC.

The test instrument monitoring the waveforms should be configured to capture the complete SSPR pattern for processing. The dispersion of the fibre should be representative of the worst-case dispersion range given in the relevant PMD table in clause 9.2.6. The launch power at the fibre input should be kept low enough to ensure operation in the linear regime, but high enough to ensure that noise from the O/E converter does not significantly impact measurement accuracy.

For the TDEC measurement, the optical modulation amplitude (OMA_{TDEC}) of the signal should be determined from the regions of the optical signal where long sequences of identical symbols are present. For the SSPR pattern there are sequences consisting of both 72 bit zero and one sequences. An average power level from the middle 50 bits of such a sequence is taken and the OMA_{TDEC} is calculated as the linear power difference between the mean 1 and 0 (see Figure 9-8).

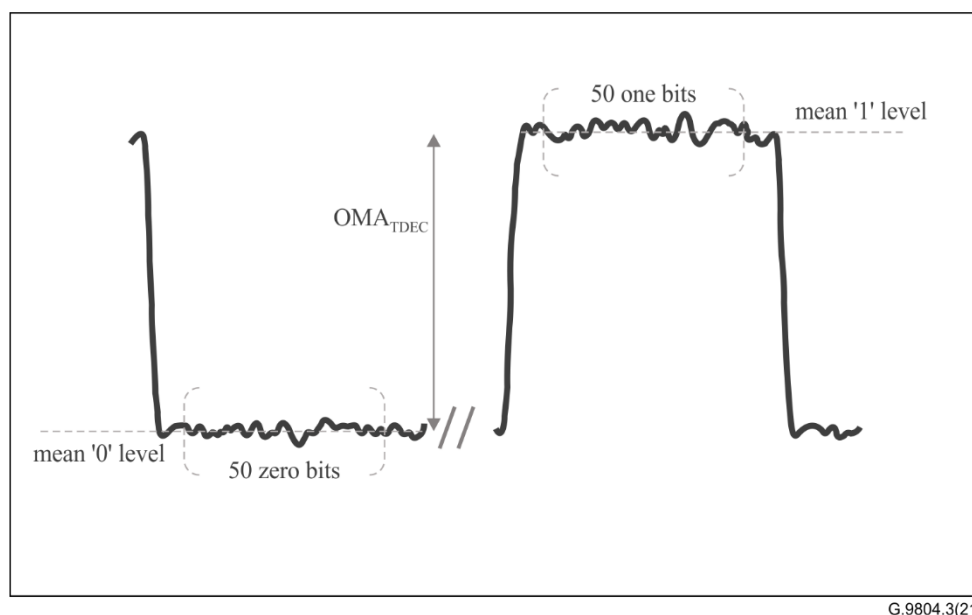

Figure 9-8 – Illustration of the OMA measurement

The waveform monitoring instrument should be calibrated appropriately to determine the noise level with no optical signal applied. The idea behind TDEC is to estimate how much noise can be added

mathematically to the captured waveform before reaching the reference BER. The instrument noise is effectively removed mathematically using the noise calibration step above.

Figure 9-9 illustrates the construction of the TDEC measurement. Four vertical histograms are measured through the eye diagram, centred at 0.425 UI and 0.575 UI, and above and below P_{th} (the average level). Each histogram's temporal sampling width is 0.04 UI. The vertical histogram sampling limit inside the eye is set by a level close to P_{th} such that no further samples would be captured by moving this level closer to P_{th} . Similarly, the vertical histogram sampling limit at the high and low levels are set outside the eye diagram such that no further samples would be captured by increasing the outer boundary of the histogram sampling window.

The distributions of the two histograms on the left are each multiplied by Q functions, which represent an estimate of the probability of errors caused by each part of the distribution for the greatest tolerable noise that could be added by an optical channel and a receiver. The resulting distributions are integrated, and each integral is divided by the integral of the distribution it was derived from, giving two-bit error probabilities. The Q function uses a standard deviation, σ_L , chosen so that the average of these two-bit error probabilities is the reference BER. Similarly, for the two histograms on the right, a standard deviation, σ_R , is found.

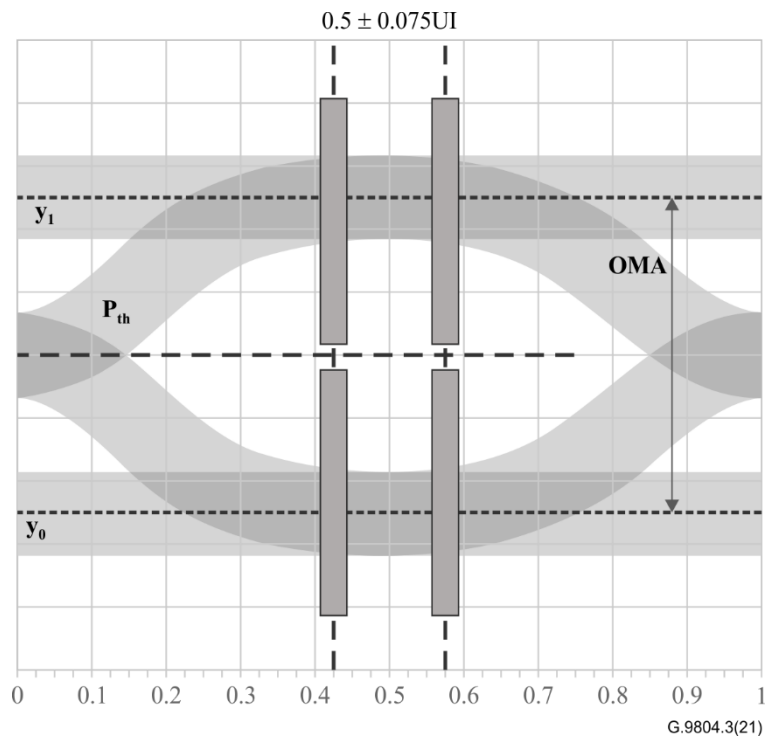

Figure 9-9 – Illustration of the TDEC measurement

The TDEC method finds a value of σ_G such that the following equation is satisfied:

$$\frac{1}{2} \left(\frac{\int f_u(y) Q\left(\frac{y-P_{th}}{c_{eq} \cdot \sigma_G(y)}\right) dy}{\int f_u(y) dy} \right) + \frac{1}{2} \left(\frac{\int f_l(y) Q\left(\frac{P_{th}-y}{c_{eq} \cdot \sigma_G(y)}\right) dy}{\int f_l(y) dy} \right) = BER_{target} \quad (9-3)$$

where

$f_u(y)$ and $f_l(y)$ are the upper and lower distributions of the samples in the eye
 BER_{target} is 1E-2

$Q(x)$ is the area under a normal curve larger than x , in this way, $Q\left(\frac{y-P_{th}}{\sigma_G}\right)$ can be regarded as the error probability when adding noise to samples with y amplitude level

σ_G is the left or right standard deviation, σ_L or σ_R , given by

$$\sigma_G(y) = \sqrt{(M^2(y)(\sigma_{0,G}^2 + S^2) - S^2)} \quad (9-4)$$

$$M(y) = \begin{cases} \frac{m(y-y_0)+(y_1-y)}{(y_1-y_0)}, & \text{for } y \geq y_0 \\ 1 & \text{for } y < y_0 \end{cases} \quad (9-5)$$

$m = \frac{\sigma_1}{\sigma_0}$, where σ_0 and σ_1 are the noise for input levels y_0 and y_1 respectively. m must be set appropriately for APD receivers to $m = 1.5$

C_{eq} is the noise enhancement factor caused by the reference equalizer, and is expressed as

$$C_{eq} = \sqrt{\int_f \Phi(f) \times |H_{eq}(f)|^2 df} \quad (9-6)$$

where $\Phi(f)$ is the normalized noise spectrum obtained by filtering white noise with the reference filter. $H_{eq}(f)$ is the frequency response of the reference equalizer.

$$\int_f \Phi(f) df = 1 \quad (9-7)$$

$$H_{eq}(f) = 1, \quad f = 0$$

The T-spaced FFE filter taps should be optimized for minimum TDEC while fixing the main FFE tap location in the middle allowing for the same amount of pre- and post-cursors.

Once the optimal T-spaced FFE filter tap response is found, it should be up-sampled by inserting a zero tap between each of the tap values to extend the frequency up to the baud rate. The reference noise and filter response integration for C_{eq} should be computed from DC to 50 GHz.

Accordingly, the noise $\sigma_{estimated_DUT}$ that could be added by a receiver is given by,

$$\sigma_{estimated_DUT} = \sqrt{N^2 + S^2} \quad (9-8)$$

where

$$N = \min(\sigma_{0,L}, \sigma_{0,R})$$

S is the standard deviation of the scope noise with no input signal.

The ideal transmitter is calculated to have a noise standard deviation $\sigma_{0,ideal}$ which can be calculated using the equation:

$$2BER_{target} = Q\left(\frac{OMA}{2\sigma_{0,ideal}}\right) + Q\left(\frac{OMA}{2m\sigma_{0,ideal}}\right) \quad (9-9)$$

While there is no closed form solution to this equation, a simple numerical search can be used to estimate $\sigma_{0,ideal}$. Finally, TDEC is calculated as:

$$TDEC = 10 \cdot \log_{10}\left(\frac{\sigma_{0,ideal}}{\sigma_{estimated_DUT}}\right) \quad (9-10)$$

Care should be taken to ensure measurement instruments follow the method described in clause 9.2.7.8.1 when measuring 50G-PON OLT transmitters and 49.7664 Gbit/s ONU transmitters, the noise enhancement factor of the equalizer (C_{eq}) should be added into the final TDEC value

together with eye closure of the test eye diagram after equalization, if the test equipment does not implement such summation function. In this case TDEC is calculated as:

$$TDEC = 10 \cdot \log_{10} \left(C_{eq} \frac{\sigma_{0,ideal}}{\sigma_{eq}} \right) \quad (9-11)$$

Where σ_{eq} is the maximum noise that could be added to a receiver without taking C_{eq} into account.

The TDEC requirement in the burst mode signal qualitatively applies from the first bit of the preamble to the last bit of the burst signal inclusively.

9.2.7.8.2 TDEC test method in non-linear fibre regime

The TDEC test in the non-linear regime is shown in Figure 9-9a. This test follows the same procedure as outlined in clause 9.2.7.8.1 with the main exception that the optical transmitter power into the test fibre is at its maximum operating level.

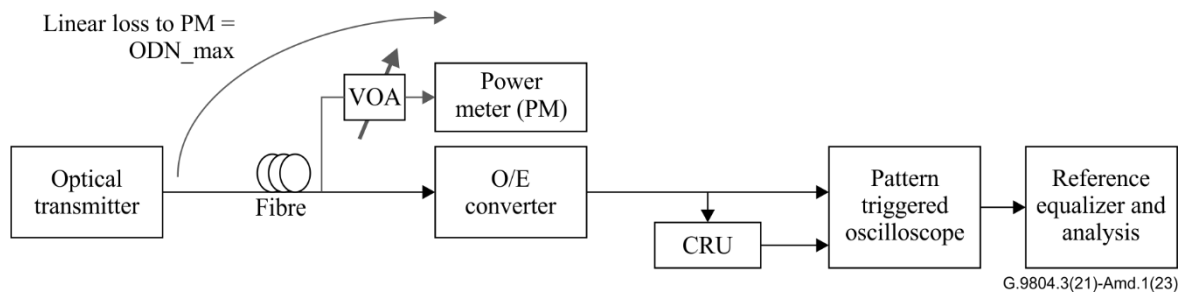

Figure 9-9a – Illustration of the TDEC measurement in the non-linear fibre regime

In addition to measuring the TDEC, it is necessary to determine if the optical power reaching the end of the test fibre is sufficient. This may be done using a power meter (PM) as shown in Figure 9-9a where the PM is connected to the end of the fibre link using a tap coupler. The loss in the linear regime of the path from the input to the test fibre to the PM is set to the maximum for the relevant OPL class of the optical transmitter. The power recorded on the PM when operating the transmitter under test must be greater than or equal to the sensitivity (R(TDEC) in Figure 9-1) as given by the TDEC measured in this test configuration.

9.2.8 Optical path between S/R (or S/Rm) and R/S

9.2.8.1 Attenuation range

Six classes of attenuation range are specified in clause 6.1.

Attenuation specifications are assumed to be worst-case values at all wavelengths specified in Table 9-4a, including losses due to splices, connectors, optical attenuators (if used) or other passive optical devices, and any additional cable margin to cover allowances for:

- 1) Future modifications to the cable configuration (additional splices, increased cable lengths, etc.);
- 2) Fibre cable performance variations due to environmental factors; and
- 3) Degradation of any connector, optical attenuators (if used) or other passive optical devices between points S and R, when provided.

9.2.8.2 Minimum optical return loss of the cable plant at point R/S including any connectors

Overall minimum optical return loss (ORL) specification at point R/S in the ODN is specified in Tables 9-5 to 9-8.

Optionally, the minimum ORL specification at point R/S in the ODN is specified in Tables 9-5 to 9-8.

NOTE – The overall reflectance at the S/R (or S/Rm) point for an ODN model is dominated by the optical connectors at the optical distribution frame (ODF). The maximum reflectance of a single discrete element within [ITU-T G.982] is –35 dB. The reflectance from the two ODF connectors leads to a figure of –32 dB. However, based on another network model, the overall reflectance may become worse than –20 dB.

9.2.8.3 Maximum discrete reflectance between points S and R

All discrete reflectances in the ODN shall be better than –35 dB as defined in [ITU-T G.982].

9.2.8.4 Dispersion

Systems considered limited by dispersion have the maximum values of dispersion (ps/nm) specified in Tables 9-5 to 9-8. These values are consistent with the maximum TDEC and optical path penalties specified. They take into account the specified transmitter type and the fibre dispersion coefficient over the operating wavelength range.

9.2.9 Receiver at S/R (or S/Rm) and R/S

All parameters are specified as follows, in accordance with Tables 9-5 to 9-8.

9.2.9.1 Receiver sensitivity

The values are specified in Tables 9-5 to 9-8. Receiver sensitivity takes into account power penalties caused by the use of a transmitter under standard operating conditions with specified values of extinction ratio and worst-case values of pulse rise and fall times, ORL at point R/S, receiver connector degradation and measurement tolerances. The receiver sensitivity does not include power penalties associated with dispersion, jitter or reflections from the optical path; these effects are specified separately in the allocation of maximum optical path penalty.

9.2.9.2 Receiver overload

The values are specified in Tables 9-5 to 9-8, accordingly. The receiver should have a certain robustness against increased optical power level due to start-up or potential collisions during ranging, for which the BER, specified in Tables 9-5 to 9-8, is not guaranteed.

9.2.9.3 Maximum optical path penalty

The receiver is required to tolerate an optical path penalty not exceeding the value.

9.2.9.4 Maximum reflectance at R/S measured at receiver wavelength

Reflections from equipment (ONU/OLT) back to the cable plant are specified by the maximum permissible reflectance of equipment measured at optical interfaces S/R (or S/Rm) and R/S. It shall be in accordance with Tables 9-5 to 9-8.

9.2.9.5 Differential optical path loss

Differential OPL means the OPL difference between the highest and lowest OPL in the same ODN. The maximum differential OPL is defined in Tables 9-5 to 9-8.

9.2.9.6 Clock extraction capability

NOTE – The clock of the upstream transmission signal is extracted rapidly from several alternating bits in the preamble. The clock extracted from the preamble is maintained at least during the reception of the signal from the delimiter to the end of the upstream assigned burst, or is continuously extracted from the signal after the preamble during the reception of the assigned burst.

9.2.9.7 Jitter performance

This clause defines jitter requirements for optical interfaces of 50G-PON.

9.2.9.7.1 Jitter transfer

The jitter transfer specification applies only to the ONU.

The jitter transfer function is defined as:

$$jitter\ transfer = 20\log_{10} \left[\frac{jitter\ on\ upstream\ signal\ UI}{jitter\ on\ downstream\ signal\ UI} \times \frac{down\ stream\ bit\ rate}{upstream\ bit\ rate} \right]$$

The jitter transfer function of an ONU shall be under the curve given in Figure 9-10, when input sinusoidal jitter up to the mask level in Figure 9-11 is applied, with the parameters specified in Figure 9-10 for each line rate.

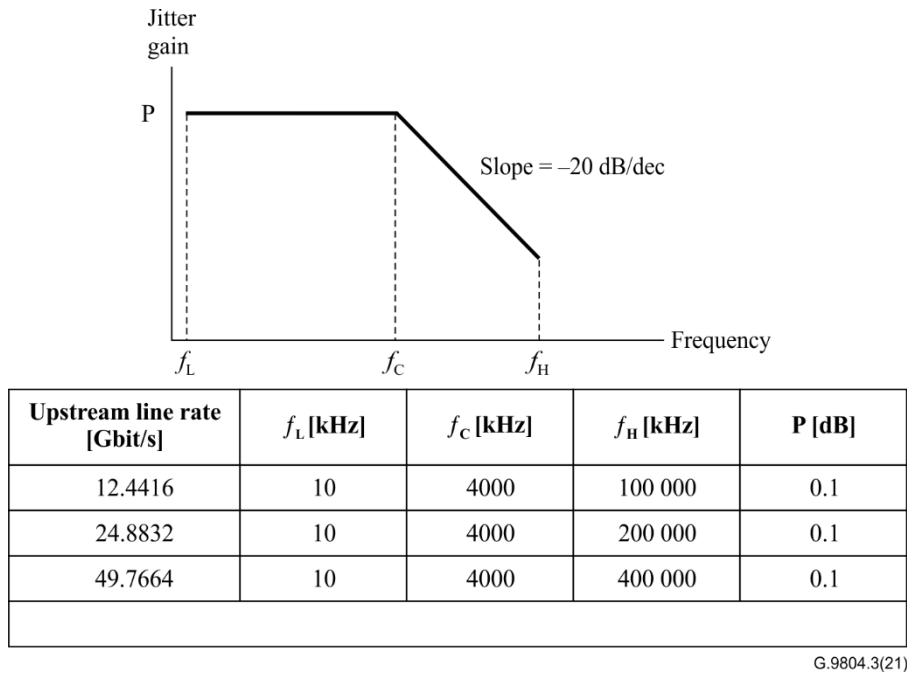

Figure 9-10 – Jitter transfer mask for ONU

NOTE – The jitter gain mask in Figure 9-10 defines the value of transferred jitter that on frequencies above 100, 200 or 400 MHz is negligible relative to the expected generation jitter (see Table 9-11) and therefore may be completely masked by the generation jitter in the measurement set-up.

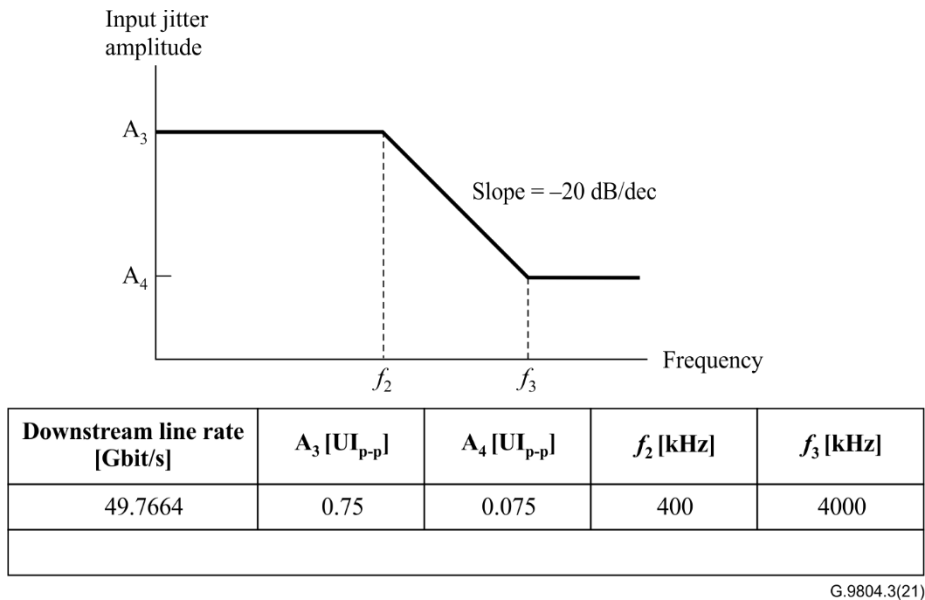

Figure 9-11 – Sinusoidal jitter mask for jitter transfer evaluation

9.2.9.7.2 Jitter tolerance

Jitter tolerance is defined as the peak-to-peak amplitude of sinusoidal jitter applied on the input of 50G-PON signal that causes a 1 dB optical power penalty at the optical equipment. Note that it is a stress test to ensure that no additional penalty is incurred under typical operating conditions.

The ONU shall tolerate, as a minimum, the input jitter applied according to the mask in Figure 9-12, with the parameters specified in that figure for the downstream line rate. The OLT should tolerate, as a minimum, the input jitter applied according to the mask in Figure 9-12, with the parameters specified in that figure for the upstream line rate. The jitter tolerance specification for the OLT is informative as it can only be measured in a setting that permits continuous operation of the upstream.

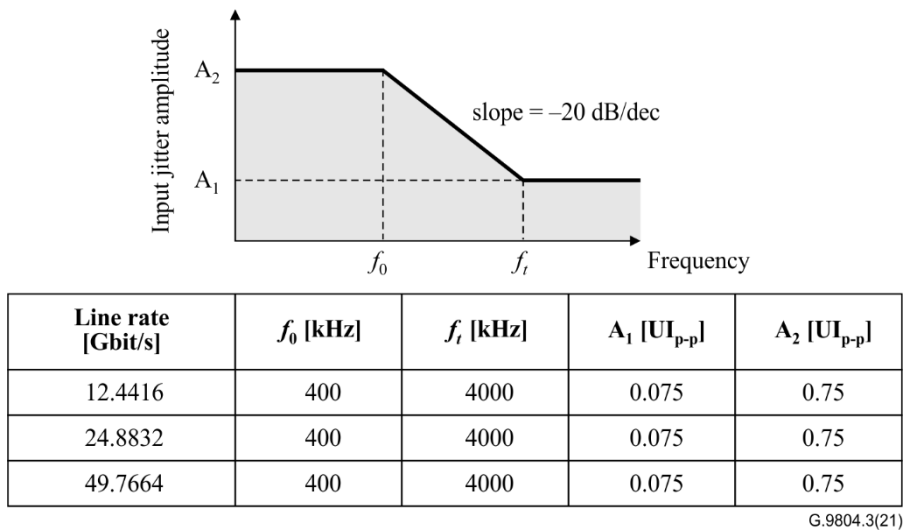

Figure 9-12 – Jitter tolerance mask

NOTE – The values of A_1 and A_2 in Figure 9-12 assume that the generated jitter (see Table 9-11) is not dominated by a single or a few strong sinusoidal components.

9.2.9.7.3 Jitter generation

An ONU shall not generate a peak-to-peak jitter amplitude more than that shown in Table 9-11 at line rates of 12.4416 Gbit/s, 24.8832 Gbit/s, and 49.7664 Gbit/s, with no jitter applied to the downstream input and with a measurement bandwidth as specified in Table 9-11. An OLT shall not generate a

peak-to-peak jitter amplitude more than that shown in Table 9-11 at a line rate of 49.7664 Gbit/s, with no jitter applied to its timing reference input and with a measurement bandwidth as specified in Table 9-11.

Table 9-11 – Jitter generation requirements

Line rate (Gbit/s)	Measurement band (-3 dB frequencies) (Note 1)		Peak-to-peak amplitude (UI) (Note 2)
	High-pass (kHz)	Low-pass (MHz) -60 dB/dec	
12.4416	10	100	0.5
	25	100	0.3
	4000	100	0.1
24.8832	10	200	0.7
	50	200	0.3
	4000	200	0.1
49.7664	10	400	1.0
	100	400	0.3
	4000	400	0.15

NOTE 1 – The high-pass and low-pass measurement filter transfer functions are defined in clause 5 of [b-ITU-T G.825].

NOTE 2 – The measurement time and pass/fail criteria are defined in clause 5 of [b-ITU-T G.825].

9.2.9.8 Consecutive identical digit (CID) immunity

The OLT and the ONU shall have a consecutive identical digit (CID) immunity as specified in Tables 9-5 to 9-8.

9.2.9.9 Receiver tolerance to reflected power

The receiver tolerance to reflected power is the allowable ratio of optical input average power of S/R (or S/R_m) and R/S to reflected optical average power when multiple reflections are regarded as a noise light at the optical interfaces S/R (or S/R_m) and R/S, respectively.

The receiver tolerance to reflected power is defined at minimum receiver sensitivity.

9.2.9.10 Transmission quality and error performance

To avoid system down time or failures, the frame structure should be robust in the presence of transmission BER up to the values defined in Tables 9-5 to 9-8.

The average BER on individual links across the entire PON system will typically be lower than the values defined in Tables 9-5 to 9-8. Optical components should provide BER better than the values defined in Tables 9-5 to 9-8 when conditions allow.

10 X/S tolerance of 50G-PON ONU and OLT

The minimum optical sensitivity of a 50G-PON ONU must be met in the presence of interference signals. Interference signals are caused by other services such as legacy PON and/or video signals specified in clause 6.3 of [ITU-T G.9804.1]. To minimize the effect of interference signals, 50G-PON ONUs need to isolate them using an appropriate wavelength blocking filter (WBF) and WDM filter. This Recommendation does not specify the isolation characteristics of the WBF and WDM filters directly, but specifies the X/S tolerance of the 50G-PON ONU. Here, S is the optical power of the

50G-PON signal, and X is that of the interference signal(s). Both are measured at the ONU reference point R/S, corresponding to the ONU reference point IF_{50GTDM} specified in clause 6.3 in [ITU-T G.9804.1].

The interference signal format for measuring X/S tolerance is a NRZ pseudo-random code with the same line rate as the 50G-PON downstream signal or a lower line rate within the bandwidth of the 50G-PON receiver.

10.1 Versatile WDM configuration

This clause describes the X/S tolerance of 50G-PON ONUs and OLT. This tolerance can be used to design a variety of WDM configurations at the ONU. This clause specifies the X/S tolerance mask that should not cause the 50G-PON receiver to fail to meet its sensitivity requirements. Implementers need to specify the isolation characteristics of the WBF and WDM filters to obtain enough isolation of the interference signal(s). This allows the 50G-PON sensitivity requirement to be met in the presence of this level of interference.

For the basic wavelength set, the wavelengths and total optical launch power of additional services must fall beneath the mask of Figure 10-1 to allow coexistence with 50G-PON.

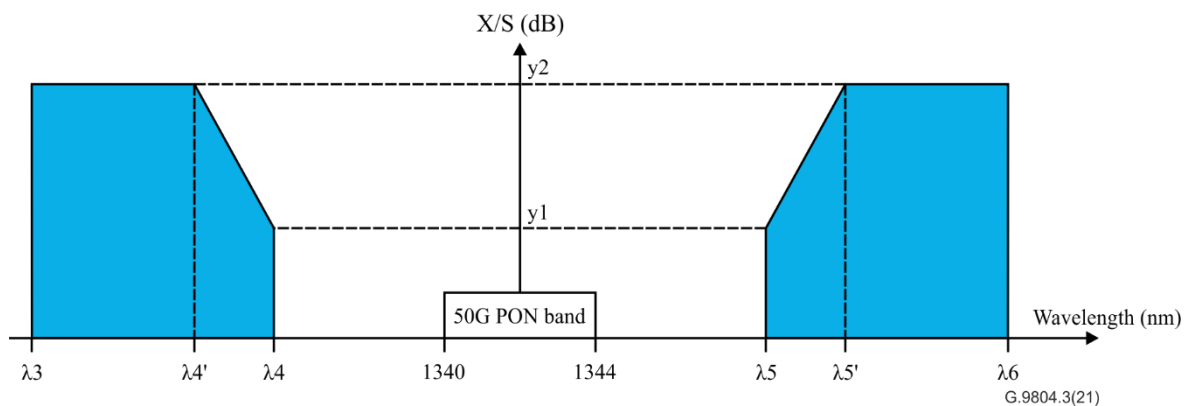

Class	y1 (dB)	y2 (dB)
N1, C+	3	18.5

Wavelength (nm)	λ3	λ4'	λ4	λ5	λ5'	λ6'
	1260	1290	1330	1356	1400	1675

S: Received power of 50G-PON band.

X: Maximum total power of additional services received in the blocking wavelength range.

X/S: The mask (hatched area) should not cause the 50G-PON receiver to fail to meet its sensitivity requirements.

Figure 10-1 – X/S tolerance mask for 50G-PON ONU (Versatile WDM configuration)

X/S tolerance of 50G-PON OLT can be used to design a variety of WDM configurations at the OLT (see Figures 10-2 to 10-4). This clause specifies the X/S tolerance mask that should not cause the 50G-PON OLT receiver to fail to meet its sensitivity requirements. Implementers need to specify the isolation characteristics of the WBF and WDM filters to obtain sufficient isolation of the interference signal(s) in the implementation. This allows the 50G-PON OLT sensitivity requirement to be met in the presence of this level of interference.

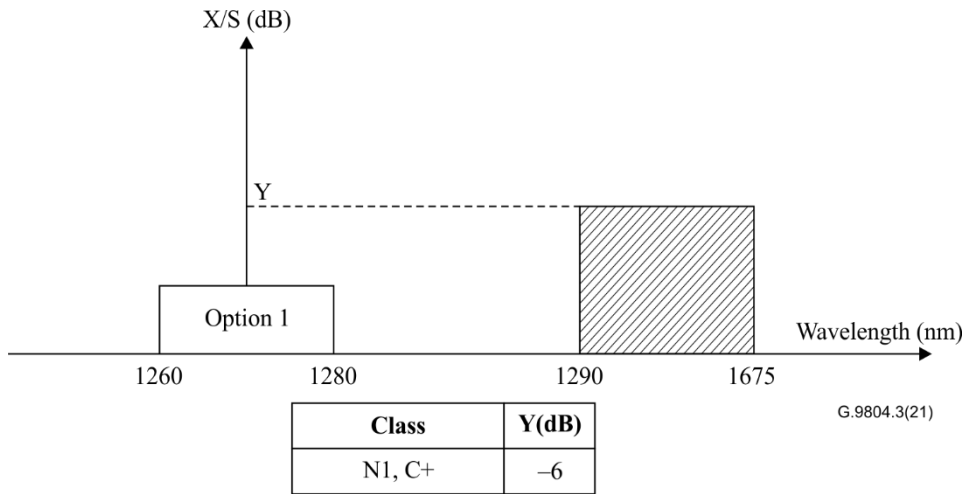

- S: Received power of basic band.
- X: Maximum total power of additional services received in the blocking wavelength range.
- X/S: The mask (hatched area) should not cause the 50G-PON receiver to fail to meet its sensitivity requirements.

Figure 10-2 – X/S tolerance mask for upstream wavelength option 1 50G-PON OLT

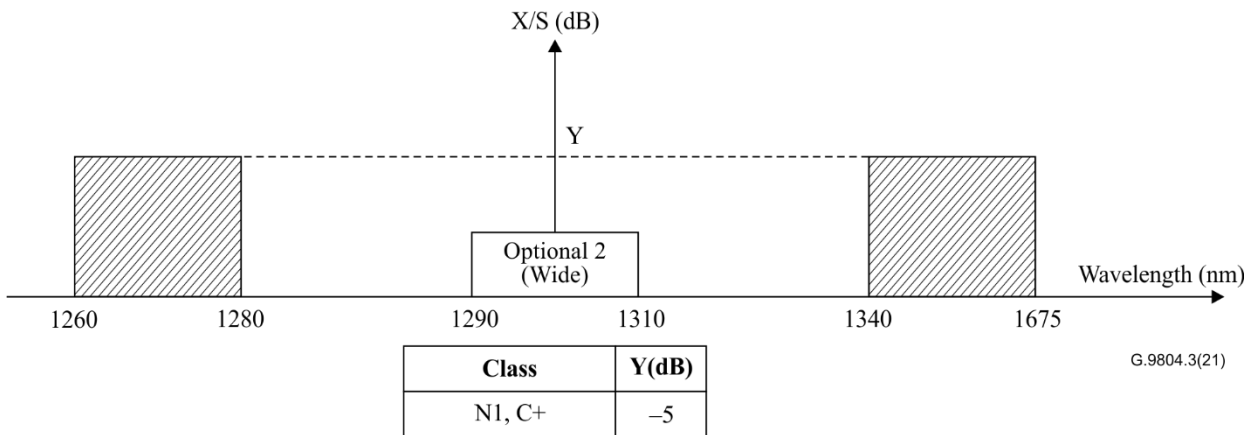

- S: Received power of basic band.
- X: Maximum total power of additional services received in the blocking wavelength range.
- X/S: The mask (hatched area) should not cause the 50G-PON receiver to fail to meet its sensitivity requirements.

Figure 10-3 – X/S tolerance mask for upstream wavelength option 2 (Wideband) 50G-PON OLT

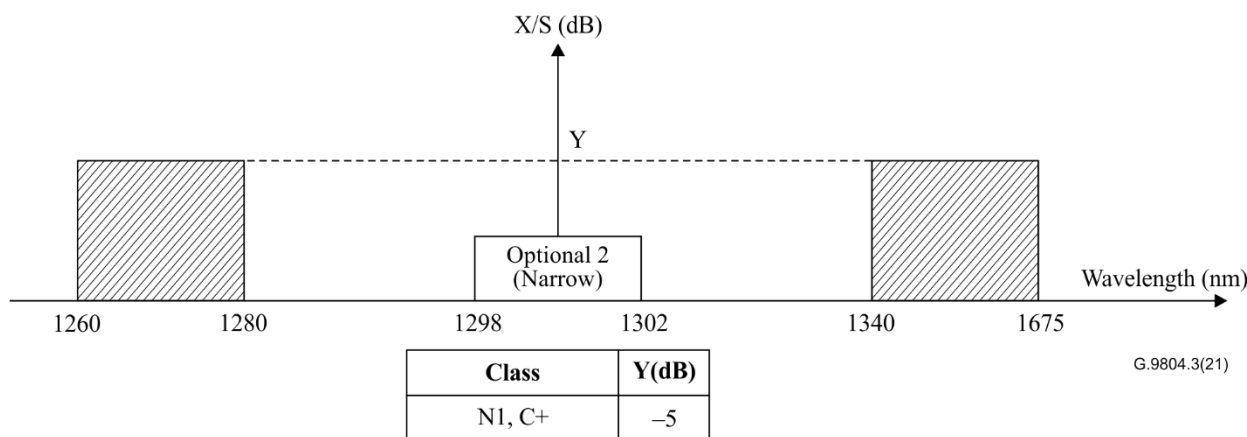

- S: Received power of basic band.
- X: Maximum total power of additional services received in the blocking wavelength range.
- X/S: The mask (hatched area) should not cause the 50G-PON receiver to fail to meet its sensitivity requirements.

Figure 10-4 – X/S tolerance mask for upstream wavelength option 2 (Narrowband) 50G-PON OLT

The OLT X/S tolerance mask for upstream wavelength option 3 is for future study.

11 Upstream physical layer overhead

The 50G-PON frame structure is described in [ITU-T G.9804.2], which is devoted to the specification of the TC layer. However, upstream burst transmissions must be preceded by suitable physical layer overhead time (T_{plo}), which is used to accommodate several physical processes. Table 11-1 shows the length of the physical layer overhead for the upstream line rate specified in this Recommendation. The OLT takes its actual overhead time requirements into account when computing the BWmap.

Table 11-1 – Objective 50G-PON upstream physical layer overhead

Upstream line rate	Overhead bits
12.4416 Gbit/s	2560
24.8832 Gbit/s	5120
49.7664 Gbit/s	10240

Moreover, Appendix III provides information on the physical processes that have to be performed during the T_{plo} , and some guidelines for allocation of T_{plo} . Appendix III also indicates the potential worst-case T_{plo} values.

Appendix I

Relationship between OMA, penalty, extinction ratio and average power

(This appendix does not form an integral part of this Recommendation.)

The transmitter characteristics are measured by the transmitter extinction ratio, its average power and the penalty after fibre transmission. In this Recommendation, OPP is used as the ONU transmitter penalty parameter for 12.4416 Gbit/s and 24.8832 Gbit/s upstream, and TDEC is used as the transmitter penalty parameter for both the OLT and the 49.7764 Gbit/s ONU. This appendix is intended to describe how optical modulation amplitude (OMA), ER, (OPP or TDEC) penalty and average power (P_{mean}) are related to one other.

Clause 58.7.6 of [IEEE 802.3] defines the transmitter parameter, OMA, whose relationship with averaged launch power and extinction ratio is as follows:

$$OMA = P_1 - P_0 \quad (\text{I.1})$$

$$ER = \frac{P_1}{P_0} \quad (\text{I.2})$$

$$P_{\text{mean}} \approx \frac{P_1 + P_0}{2} \quad (\text{I.3})$$

$$OMA \approx 2 \times P_{\text{mean}} \times \frac{ER-1}{ER+1} \quad (\text{I.4})$$

Where P_1 and P_0 are the mean one and zero level powers of the NRZ signal, respectively.

NOTE – The P_{mean} and ER are all in linear units in the above equations. OMA and launch power should be expressed in watt.

For a compliant transmitter, the relationship between OMA, ER and average power can be derived based on equations (I.1) to (I.4).

If the 49.7664 Gbit/s downstream transmitter specification defined in Table 9-5 is taken as an example, the minimum "Launch power in OMA minus TDEC" is 4.75 dBm and 7.75 dBm for N1 and C+, respectively.

ODN Class		N1	C1+
Mean launch power minimum (Note 2)	dBm	+5.5 (Note 3)	+8.5 (Note 4)
Mean launch power maximum	dBm	+11	+14
Launch power in OMA minus TDEC (min) (Note 5)	dBm	+4.75	+7.75
Maximum transmitter and dispersion eye closure (TDEC) (Note 5)	dB	5	

When the TDEC of the transmitter is 2.0 dB, this will require 6.75 dBm minimum launch OMA for N1 class, and 9.75 dBm minimal launch OMA for C+ class. Based on the above equations (I.1) to (I.4), the following example with lower boundaries of mean launch power and ER pairs can be derived for C+ OPL class as shown in Table I.1:

Table I.1 – Lower boundary mean launch power and ER pairs of the 49.7664 Gbit/s downstream OLT transmitter admissible region for C+ OPL class

Parameters	Unit	(\bar{P}_1, ER_1)	(\bar{P}_2, ER_2)	(\bar{P}_3, ER_3)	(\bar{P}_4, ER_4)	(\bar{P}_5, ER_5)
Mean launch optical power	dBm	9.6	9.0	8.5	8.1	7.8
ER	dB	5	6	7	8	9
OMA	dBm	9.75				
TDEC	dB	2.0				

The parameters of the transmitter jointly specified by \bar{P} and ER shall lie within an admissible region (shown as a hatched area in Figure I.1).

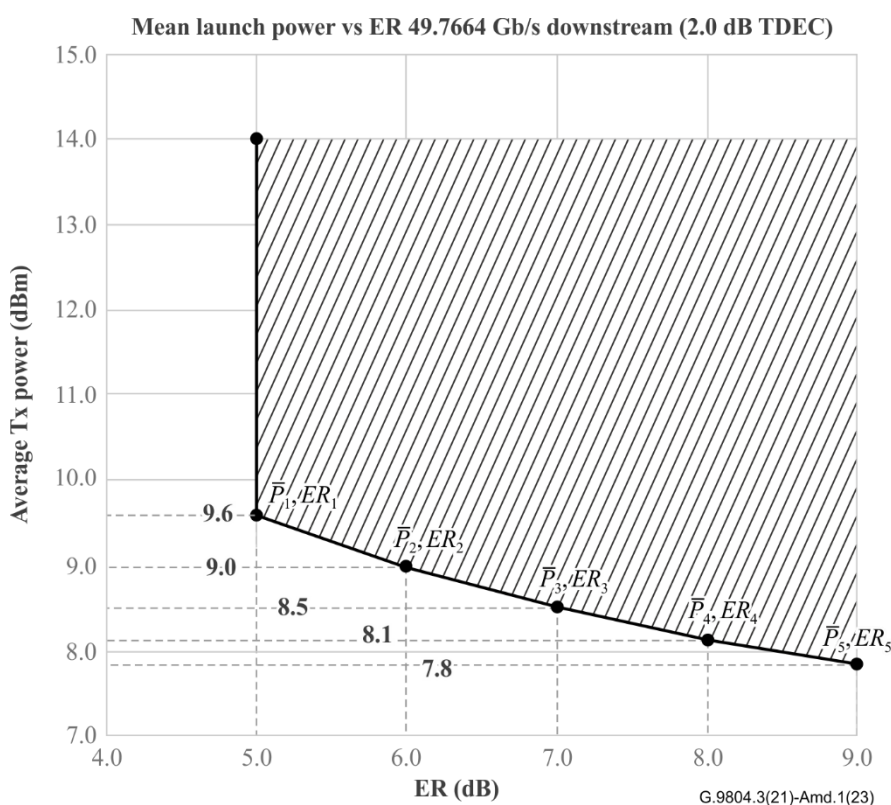

Figure I.1 –Transmitter power and ER admissible region (hatched) for 49.7664 Gbit/s upstream when TDEC = 2.0dB

When the TDEC is more than 2.0 dB, the minimal launch power requirement should be increased accordingly to meet the "OMA minus penalty" requirement.

If the 24.8832 Gbit/s upstream ONU transmitter specification defined in Table 9-7 is taken as an example, the minimum "OMA minus OPP" is 4.7 dBm and 4.5 dBm for ER < 6 dB and ER ≥ 6 dB, respectively. The minimum extinction ratio is 5 dB.

ODN class		N1	C+
Launch power in OMA minus OPP (min)			
– When ER < 6 dB	dBm	4.7	4.7
– When ER ≥ 6 dB		4.5	4.5
Minimum extinction ratio	dB	5	

When the OPP is 0.5 dB, this will require 5.2 dBm minimum launch OMA for $ER < 6$ dB, and require 5 dBm minimal launch OMA for $ER \geq 6$ dB. Based on the above equations (I.1) to (I.4), the following example with lower boundaries of mean launch power and ER pairs can be derived as shown in Table I.1:

Table I.2 – Lower boundary mean launch power and ER pairs of the 24.8832 Gbit/s upstream ONU transmitter admissible region

Parameters	Unit	(\bar{P}_1, ER_1)	(\bar{P}'_2, ER'_2)	(\bar{P}_2, ER_2)	(\bar{P}_3, ER_3)	(\bar{P}_5, ER_5)
Mean launch optical power	dBm	5.0	4.4	4.2	3.7	3.4
ER	dB	5	5.999	6	7	8
OMA	dBm	5.2		5.0		
OPP	dB	0.5				

The parameters of the transmitter jointly specified by \bar{P} and ER shall lie within an admissible region (shown as a hatched area in Figure I.2).

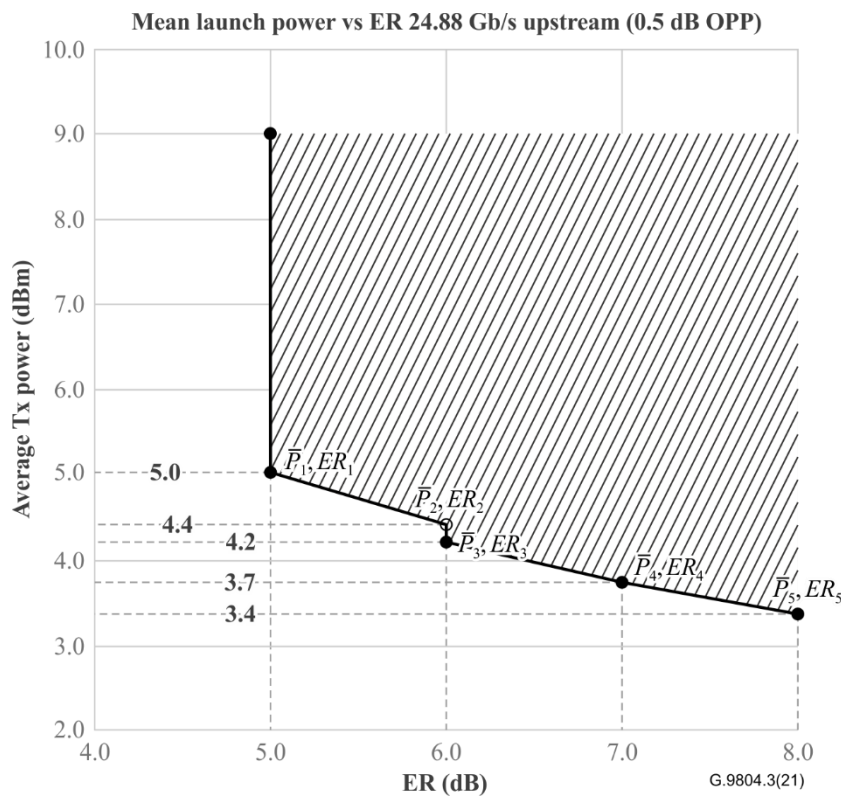

Figure I.2 –Transmitter power and ER admissible region (hatched) for 24.8832 Gbit/s upstream when OPP = 0.5dB

Arbitrary mean launch power and ER pairs may be generated based on equations (I.1) to (I.4).

When the OPP is more than 0.5 dB, the minimal launch power requirement should be increased accordingly to maintain the same "OMA minus penalty" requirement.

Appendix II

Physical layer measurements required to support optical layer supervision

(This appendix does not form an integral part of this Recommendation.)

See Appendix II of [ITU-T G.989.2].

Appendix III

Allocation of the physical layer overhead time

(This appendix does not form an integral part of this Recommendation.)

The physical layer overhead time (T_{plo}) is used to accommodate five physical processes in the PON. These are: laser on/off time, timing drift tolerance, level recovery, clock recovery and start of burst delineation. The exact division of the physical layer time to all these functions is determined partly by constraint equations and partly by implementation choices. This appendix reviews the constraints that the OLT must comply with, and suggests values for the discretionary values.

T_{plo} includes three sections with respect to what ONU data pattern is transmitted. For simplicity, these sections can be referred to as the guard time (T_g), the preamble time (T_p) and the delimiter time (T_d). It thus follows that $T_{plo} \geq T_g + T_p + T_d$. During T_g , the ONU transmit levels are not specified, provided they comply with the PMD Tables 9-6 to 9-8 for the Tx enable bit period while during the Tx disable bit period the maximum launch power level allowed is the zero-level corresponding to the minimum extinction ratio specified in Tables 9-6 to 9-8. During T_p , the ONU will transmit a preamble pattern that provides the desired transition density and signal pattern for fast level adjustment, clock recovery and optional equalization functions. Lastly, during T_d , the ONU will transmit a special data pattern, a delimiter, with optimal autocorrelation properties that enable the OLT to find the beginning of the burst payload. Table III.2 gives recommended values for T_g , T_p , T_d and T_{plo} . Figure III.1 shows the timing relationship between the various physical layer overhead times.

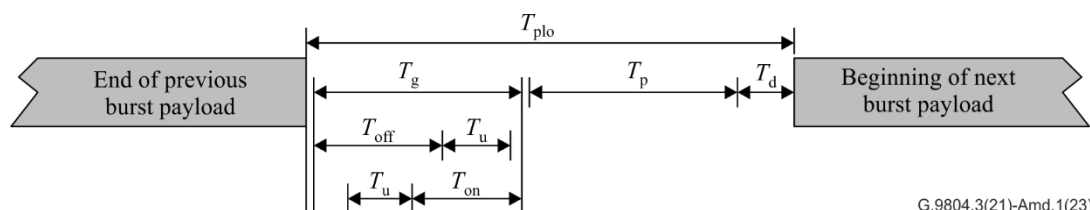

G.9804.3(21)-Amd.1(23)

Figure III.1 – Timing relationship between the various physical layer overhead times

An additional parameter of the control logic on the PON is the total peak-to-peak timing uncertainty (T_u). This uncertainty arises from variations of the time of flight caused by the fibre and component variations with temperature and other environmental factors.

The constraint conditions with which the OLT must comply are then:

$$\begin{aligned}
 T_g &> T_{on} + T_u, \text{ and} \\
 T_g &> T_{off} + T_u \\
 \underline{T_g > T_{on} + T_u, \text{ and}} \\
 \underline{T_g > T_{off} + T_u}
 \end{aligned}$$

These conditions can be explained as follows. The first condition makes sure that the following burst's laser on ramp-up does not fall on top of the last burst's data. The second condition makes sure that the last burst's laser off tail-off does not fall on top of the following burst's preamble.

T_p must be sufficient for the physical layer to recover the signal level (essentially, setting the decision threshold) and the signal clock phase and allow for equalizer convergence, should equalization be necessary. There are many diverse design approaches to the first two problems, each with its own benefits and costs. Some designs are very fast, but require an external trigger signal and produce sub-optimal error performance. Other designs are slower, but do not require a reset signal and produce bit

errors that are normally distributed. In addition, each of these designs may have special requirements on the data pattern used for the preamble. Some designs prefer a maximum transition density pattern, while others prefer a pattern with a balance of transitions and controlled runs of identical digits.

Since the design is up to the OLT implementer, the OLT configures the details of the preamble that is transmitted by the ONU. This is part of the burst profile discussion below.

T_d must be long enough to provide a robust delimiter function in the face of bit errors. The error resistance of the delimiter depends on the exact implementation of the pattern correlator, but a simple approximate relationship between the number of bits in the delimiter (N) and the number of bit errors tolerated (E) is as expressed in equation (III.1):

$$E = \lfloor N/4 \rfloor - 1, \quad (III.1)$$

where $\lfloor \cdot \rfloor$ denotes a floor function. Equation (III.1) has been empirically verified by a numerical search of all delimiters of sizes with 32 and 64 bits. This search was performed under the assumption that the preamble pattern was a '1010' repeating pattern, and that the delimiter had an equal number of zeroes and ones. The Hamming distance (D) of the best delimiter from all shifted patterns of itself and the preamble was found to be $D = \lfloor N/2 \rfloor - 1$, yielding the error tolerance shown.

Given a certain bit error ratio (BER), the probability of a severely errored burst ($Pseb$) is given by:

$$Pseb = \binom{N}{E+1} BER^{E+1} \quad (III.2)$$

Substituting equation (III.1) into equation (III.2), the resultant $Pseb$ is given by equation (III.3):

$$Pseb = \binom{N}{\lfloor N/4 \rfloor} BER^{\lfloor N/4 \rfloor} \quad (III.3)$$

Values of $Pseb$ for various bit error ratios and delimiter lengths are given in Table III.1. The choice of delimiter length and pattern is made by the OLT as part of the burst profile.

Table III.1 – Probability of a severely errored burst as a function of bit error ratio and delimiter length

Delimiter length (N)	Probability of a severely errored burst ($Pseb$)		
	$BER = 2.0 \times 10^{-2}$	$BER = 1.0 \times 10^{-2}$	$BER = 5.0 \times 10^{-3}$
32	2.7×10^{-7}	1.1×10^{-9}	4.1×10^{-12}
64	3.2×10^{-13}	4.9×10^{-18}	7.5×10^{-23}

With these considerations taken into account, the worst-case and objective allocations of the physical layer overhead are given in Table III.2. This table also lists the values for the ONU transmitter enable time and transmitter disable time, and the total physical layer overhead time for reference. The worst-case values are intended to provide a reasonable bound for easy implementation, and the objective values are intended to be the design target for more efficient implementation with optimized components. These values are for a simple ODN without reach extenders. Reach extenders may require their own guard and preamble time allowances, making the total overhead larger. The values in nanoseconds are for information only.

**Table III.2 – Recommended allocation
of burst mode overhead time for 50G-PON OLT functions**

	Transmitter enable time	Transmitter disable time	Total time, T_{plo}	Guard time, T_g	Preamble time, T_p	Delimiter time, T_d
12.4416 Gbit/s Worst case in bits (ns)	1600 (128.6)	1600 (128.6)	10 240 (823.1)	2560 (205.8)	7600 (610.9)	64 (5.14)
12.4416 Gbit/s Objective in bits (ns)	320 (25.7)	320 (25.7)	2560 (205.8)	640 (51.4)	1856 (149.2)	64 (5.14)
24.8832 Gbit/s Worst case in bits (ns)	3200 (128.6)	3200 (128.6)	20 480 (823.1)	5120 (205.8)	15 200 (610.9)	64 (2.57)
24.8832 Gbit/s Objective in bits (ns)	640 (25.7)	640 (25.7)	5120 (205.8)	1280 (51.4)	3776 (151.75)	64 (2.57)
49.7664 Gbit/s Worst case in bits (ns)	6400 (128.6)	6400 (128.6)	40 960 (823.1)	10240 (205.8)	30400 (610.9)	64 (1.28)
49.7664 Gbit/s Objective in bits (ns)	1280 (25.7)	1280 (25.7)	10240 (205.8)	2560 (51.4)	7616 (153.0)	64 (1.28)

In addition to the design dependent aspects of the burst overhead, there can be operationally dependent factors. For example, detecting an ONU's ranging burst is a more difficult problem than receiving an ONU's regular transmission. As another example, the received power for some ONUs may be higher and therefore easier to detect, eliminating the need for FEC. For these reasons, the OLT may request different burst profiles depending on the context.

The concept of a burst profile captures all the aspects of burst overhead control. A burst profile specifies the preamble pattern and length, the delimiter pattern and length, and whether FEC parity should be sent. The OLT establishes one or more burst profiles, and then requests a particular burst profile for each burst transmission.

The OLT has considerable latitude in setting up the profiles, because the OLT's burst receiver is sensitive to the profile parameters. Therefore, the OLT should use profiles that ensure adequate response in its burst mode receiver. However, some basic requirements from the ONU side must be met. Namely, the preamble and delimiter patterns should be balanced, and they should have a reasonable transition density. If not, the ONU transmitter driver circuitry may be adversely affected. Also note that the preamble and delimiter patterns could differ in each profile, and this difference could be used by the OLT receiver as an in-band indication of the format of each burst (e.g., FEC active or not).

The details of distributing the burst profiles and signalling their use are described in [ITU-T G.9804.2] Common Transmission Convergence Layer Specification.

Appendix IV

Relationship among optical interface parameters for 49.7664 Gbit/s downstream

(This appendix does not form an integral part of this Recommendation.)

The relationship between certain optical interface parameters for 49.7664 Gbit/s downstream is described below. We use the following notations:

- $P_{\text{OMA-TDEC}}$ is the 'minimum launch power in OMA minus TDEC' in dBm specified in Table 9-5.
- S_{OMA} is the 'OMA sensitivity at BER reference level' in dBm specified in Table 9-5. It is based on a transmitter with a $\text{TEC}_{\text{ref}} = 1.5$ dB.
- $R(\text{TDEC})_{\text{OMA}}$ is the OMA sensitivity at BER reference level in dBm when receiving a signal with a given TDEC. This parameter is expressed as an equation in Table 9-5; it is related to S_{OMA} as explained below (also see Note 9 of Table 9-5 and Figure 9-1).
- OPL_{max} is the maximum optical path loss in dB for the specified ODN class (see Table 6-1 and Table 6-2).
- TEC_{ref} is the transmitter eye closure of the transmitter used to determine the ONU Rx sensitivity in back to back (S_{OMA}). It is 1.5 dB.
- $P(\text{TDEC})_{\text{OMA}}$ is the minimum required launch OMA from an OLT Tx with a certain TDEC.
- TDEC is a value in dB used to determine $P(\text{TDEC})_{\text{OMA}}$ and $R(\text{TDEC})_{\text{OMA}}$.
- TDEC_{DUT} is the actual TDEC value in dB of a particular OLT transmitter.
- TDEC_0 is the lowest TDEC considered for an OLT transmitter. A value of $\text{TDEC}_0 = 2.0$ dB is used for the specifications in Table 9-5 (see Note below).
- TDEC_{max} is the highest TDEC for an OLT transmitter. A value of $\text{TDEC}_{\text{max}} = 5.0$ dB is used for the specifications in Table 9-5.

TDEC is given by,

$$\text{TDEC} = \max(\text{TDEC}_0, \text{TDEC}_{\text{DUT}}) \text{ for } \text{TDEC}_{\text{DUT}} \leq \text{TDEC}_{\text{max}}$$

$$P(\text{TDEC})_{\text{OMA}} \text{ is given by } P(\text{TDEC})_{\text{OMA}} = P_{\text{OMA-TDEC}} + \text{TDEC}$$

From Note 11 in Table 9-5,

$$R(\text{TDEC})_{\text{OMA}} \leq \max(S_{\text{OMA}} - \text{TEC}_{\text{ref}} + \text{TDEC}_0, S_{\text{OMA}} - \text{TEC}_{\text{ref}} + \text{TDEC})$$

In the worst case for $R(\text{TDEC})_{\text{OMA}}$ (i.e., when equality is achieved in the above relation),

$$P(\text{TDEC})_{\text{OMA}} = R(\text{TDEC})_{\text{OMA}} + \text{OPL}_{\text{max}}$$

Mean power values for the OLT transmitter and ONU receiver specifications are derived from the OMA values assuming $ER = 7$ dB. They are indicated in Table 9-5 to aid in-service troubleshooting operations with optical power meters.

NOTE – The derivation of the value of $\text{TDEC}_0 = 2.0$ dB was from an assumption of a hypothetical full bandwidth OLT transmitter with a $\text{TEC} = 1.5$ dB and allowing for 0.5 dB when adding fibre impairments.

Bibliography

- [b-ITU-T G.810] Recommendation ITU-T G.810 (1996), *Definitions and terminology for synchronization networks*.
- [b-ITU T G.825] Recommendation ITU-T G.825 (2000), *The control of jitter and wander within digital networks which are based on the synchronous digital hierarchy (SDH)*.
- [b-ITU-T G.987.2] Recommendation ITU-T G.987.2 (2023), *10-Gigabit-capable passive optical networks (XG-PON): Physical media dependent (PMD) layer specification*.
- [b-ITU-T G.Sup39] Recommendation ITU-T G.Sup39 (2016), *Optical system design and engineering considerations*.
- [b-OIF] Optical Internetworking Forum (2017), *Common Electrical I/O (CEI) – Electrical and Jitter Interoperability agreements for 6G+ bps, 11G+ bps, 25G+ bps I/O and 56G+ bps, IA # OIF-CEI-04.0*. <<https://www.oiforum.com/wp-content/uploads/2019/01/OIF-CEI-04.0.pdf>>

SERIES OF ITU-T RECOMMENDATIONS

Series A	Organization of the work of ITU-T
Series D	Tariff and accounting principles and international telecommunication/ICT economic and policy issues
Series E	Overall network operation, telephone service, service operation and human factors
Series F	Non-telephone telecommunication services
Series G	Transmission systems and media, digital systems and networks
Series H	Audiovisual and multimedia systems
Series I	Integrated services digital network
Series J	Cable networks and transmission of television, sound programme and other multimedia signals
Series K	Protection against interference
Series L	Environment and ICTs, climate change, e-waste, energy efficiency; construction, installation and protection of cables and other elements of outside plant
Series M	Telecommunication management, including TMN and network maintenance
Series N	Maintenance: international sound programme and television transmission circuits
Series O	Specifications of measuring equipment
Series P	Telephone transmission quality, telephone installations, local line networks
Series Q	Switching and signalling, and associated measurements and tests
Series R	Telegraph transmission
Series S	Telegraph services terminal equipment
Series T	Terminals for telematic services
Series U	Telegraph switching
Series V	Data communication over the telephone network
Series X	Data networks, open system communications and security
Series Y	Global information infrastructure, Internet protocol aspects, next-generation networks, Internet of Things and smart cities
Series Z	Languages and general software aspects for telecommunication systems