

I n t e r n a t i o n a l T e l e c o m m u n i c a t i o n U n i o n

ITU-T

TELECOMMUNICATION
STANDARDIZATION SECTOR
OF ITU

G.9806
Amendment 2
(05/2021)

SERIES G: TRANSMISSION SYSTEMS AND MEDIA,
DIGITAL SYSTEMS AND NETWORKS

Access networks – Optical line systems for local and
access networks

Higher speed bidirectional, single fibre,
point-to-point optical access system (HS-PtP)

Amendment 2

Recommendation ITU-T G.9806 (2020) – Amendment 2

ITU-T



ITU-T G-SERIES RECOMMENDATIONS

TRANSMISSION SYSTEMS AND MEDIA, DIGITAL SYSTEMS AND NETWORKS

INTERNATIONAL TELEPHONE CONNECTIONS AND CIRCUITS	G.100–G.199
GENERAL CHARACTERISTICS COMMON TO ALL ANALOGUE CARRIER-TRANSMISSION SYSTEMS	G.200–G.299
INDIVIDUAL CHARACTERISTICS OF INTERNATIONAL CARRIER TELEPHONE SYSTEMS ON METALLIC LINES	G.300–G.399
GENERAL CHARACTERISTICS OF INTERNATIONAL CARRIER TELEPHONE SYSTEMS ON RADIO-RELAY OR SATELLITE LINKS AND INTERCONNECTION WITH METALLIC LINES	G.400–G.449
COORDINATION OF RADIOTELEPHONY AND LINE TELEPHONY	G.450–G.499
TRANSMISSION MEDIA AND OPTICAL SYSTEMS CHARACTERISTICS	G.600–G.699
DIGITAL TERMINAL EQUIPMENTS	G.700–G.799
DIGITAL NETWORKS	G.800–G.899
DIGITAL SECTIONS AND DIGITAL LINE SYSTEM	G.900–G.999
MULTIMEDIA QUALITY OF SERVICE AND PERFORMANCE – GENERIC AND USER-RELATED ASPECTS	G.1000–G.1999
TRANSMISSION MEDIA CHARACTERISTICS	G.6000–G.6999
DATA OVER TRANSPORT – GENERIC ASPECTS	G.7000–G.7999
PACKET OVER TRANSPORT ASPECTS	G.8000–G.8999
ACCESS NETWORKS	G.9000–G.9999
Metallic access networks	G.9700–G.9799
Optical line systems for local and access networks	G.9800–G.9899
In premises networks	G.9900–G.9999

For further details, please refer to the list of ITU-T Recommendations.

Recommendation ITU-T G.9806

Higher speed bidirectional, single fibre, point-to-point optical access system (HS-PtP)

Amendment 2

Summary

Recommendation ITU-T G.9806 describes a higher speed bidirectional single fibre point-to-point optical access system than the data rate in existing ITU-T point-to-point access systems. It supports 10 Gbit/s for the optical access services including the optical distribution network (ODN) specification, the physical layer specification, services requirements and the operation, administration and maintenance (OAM) specification.

Amendment 1 added support for 25 Gbit/s.

Amendment 2 adds support for 50 Gbit/s.

History

Edition	Recommendation	Approval	Study Group	Unique ID*
1.0	ITU-T G.9806	2020-06-06	15	11.1002/1000/14196
1.1	ITU-T G.9806 (2020) Amd. 1	2020-10-29	15	11.1002/1000/14494
1.2	ITU-T G.9806 (2020) Amd. 2	2021-05-29	15	11.1002/1000/14629

Keywords

Optical access network, point to point optical transmission, single fibre (aka BiDi), 10 Gbit/s, 25 Gbit/s, 50 Gbit/s, single fibre bidirectional transmission.

* To access the Recommendation, type the URL <http://handle.itu.int/> in the address field of your web browser, followed by the Recommendation's unique ID. For example, <http://handle.itu.int/11.1002/1000/11830-en>.

FOREWORD

The International Telecommunication Union (ITU) is the United Nations specialized agency in the field of telecommunications, information and communication technologies (ICTs). The ITU Telecommunication Standardization Sector (ITU-T) is a permanent organ of ITU. ITU-T is responsible for studying technical, operating and tariff questions and issuing Recommendations on them with a view to standardizing telecommunications on a worldwide basis.

The World Telecommunication Standardization Assembly (WTSA), which meets every four years, establishes the topics for study by the ITU-T study groups which, in turn, produce Recommendations on these topics.

The approval of ITU-T Recommendations is covered by the procedure laid down in WTSA Resolution 1.

In some areas of information technology which fall within ITU-T's purview, the necessary standards are prepared on a collaborative basis with ISO and IEC.

NOTE

In this Recommendation, the expression "Administration" is used for conciseness to indicate both a telecommunication administration and a recognized operating agency.

Compliance with this Recommendation is voluntary. However, the Recommendation may contain certain mandatory provisions (to ensure, e.g., interoperability or applicability) and compliance with the Recommendation is achieved when all of these mandatory provisions are met. The words "shall" or some other obligatory language such as "must" and the negative equivalents are used to express requirements. The use of such words does not suggest that compliance with the Recommendation is required of any party.

INTELLECTUAL PROPERTY RIGHTS

ITU draws attention to the possibility that the practice or implementation of this Recommendation may involve the use of a claimed Intellectual Property Right. ITU takes no position concerning the evidence, validity or applicability of claimed Intellectual Property Rights, whether asserted by ITU members or others outside of the Recommendation development process.

As of the date of approval of this Recommendation, ITU had not received notice of intellectual property, protected by patents/software copyrights, which may be required to implement this Recommendation. However, implementers are cautioned that this may not represent the latest information and are therefore strongly urged to consult the appropriate ITU-T databases available via the ITU-T website at <http://www.itu.int/ITU-T/ipr/>.

© ITU 2021

All rights reserved. No part of this publication may be reproduced, by any means whatsoever, without the prior written permission of ITU.

Table of Contents

	Page
Amendment 2.....	i
1 Scope.....	1
2 References.....	1
3 Definitions	2
3.1 Terms defined elsewhere.....	2
3.2 Terms defined in this Recommendation.....	2
4 Abbreviations and acronyms	2
5 Conventions	4
6 Configuration of an OAN	4
6.1 System configuration.....	4
6.2 Fibre type.....	4
6.3 Transmission methodology	4
6.4 Transmission distances	5
6.5 Wavelength allocation	5
6.6 ODN model	5
6.7 Line rates	6
6.8 Classes for optical path loss	6
6.9 Reflectance in ODN	6
6.10 Module naming convention.....	6
7 Physical layer specification	7
7.1 Transmit wavelength/Receive wavelength.....	13
7.2 Bit rate and line coding.....	13
7.3 Spectral characteristics	14
7.4 Mean launched power.....	14
7.5 Receiver characteristics	14
7.6 Extinction ratio	14
7.7 Pulse mask	15
7.8 S/X.....	15
7.9 Optical return loss of the interface	16
7.10 Test pattern	16
7.11 Signal detect	16
8 Transmission convergence layer and ONU management.....	16
8.1 OAM structure.....	16
8.2 OMCI Ethernet frame.....	17
8.3 Activation process	18
8.4 ONU with multiple UNI ports.....	22
8.5 Managed entities.....	22

8.6	Managed entity relation diagram.....	23
8.7	MIB description.....	23
8.8	Dual managed ONU	23
8.9	Encapsulation method for transparent payload	23
8.10	Link pass through capability	23
9	Service requirements and service enabling features.....	23
9.1	Service requirements	23
9.2	Hitless line rate switching	23
9.3	Round trip delay knowledge.....	26
9.4	Port identification	26
9.5	Synchronization features and quality	27
10	Other requirements	27
10.1	Silent start function of ONU.....	27
10.2	Provisioning/authentication method.....	27
10.3	Power saving and energy efficiency.....	27
10.4	Environmental requirements	28
10.5	E-OTDR support	28
10.6	Encryption/Data privacy.....	28
10.7	Eye safety concerns	29
	Appendix I – Link pass through.....	30
	Appendix II – Methodology for translating the [IEEE 802.3] BiDi PtP specifications to ITU T G.9806 specifications for 10 Gbit/s and 25 Gbit/s	33
	Appendix III – Methodology for translating the [IEEE 802.3] BiDi PtP specifications to ITU-T G.9806 specifications for 50 Gbit/s.....	35
	Bibliography.....	38

Recommendation ITU-T G.9806

Higher speed bidirectional, single fibre, point-to-point optical access system (HS-PtP)

Amendment 2

Editorial note – This is a complete-text publication. Modifications introduced by this amendment are shown in revision marks relative to Recommendation ITU-T G.9806 (2020) and its Amendment 1 (2020).

1 Scope

This Recommendation describes a higher speed bidirectional point-to-point (HS-PtP) Ethernet-based optical access system for the optical access services including the optical distribution network (ODN) specification, the physical layer specification, services requirements and the operation, administration and maintenance (OAM) specification.

For an effective use of optical fibres cited in [ITU-T G.986], this Recommendation specifies only a single fibre bidirectional transmission system, also known as duplex working as defined in [ITU-T G.982]. Dual-fibre systems are out of the scope of this Recommendation. This Recommendation also specifies systems with line rate at 10 Gbit/s. Amendment 1 adds the 25 Gbit/s specification. ~~Line rates higher than 25 Gbit/s are for future~~Specifications for and Amendment 2 adds the 50 Gbit/s specification are for further study.

In addition, this Recommendation describes the case of a single domain managed optical network unit (ONU) and related optical line termination (OLT) requirements. The case of a dual domain managed ONU and related OLT requirements are for future study.

2 References

The following ITU-T Recommendations and other references contain provisions which, through reference in this text, constitute provisions of this Recommendation. At the time of publication, the editions indicated were valid. All Recommendations and other references are subject to revision; users of this Recommendation are therefore encouraged to investigate the possibility of applying the most recent edition of the Recommendations and other references listed below. A list of the currently valid ITU-T Recommendations is regularly published. The reference to a document within this Recommendation does not give it, as a stand-alone document, the status of a Recommendation.

[\[ITU-T G.652\]](#) [Recommendation ITU-T G.652 \(2016\), Characteristics of a single-mode optical fibre and cable.](#)

[\[ITU-T G.657\]](#) [Recommendation ITU-T G.657 \(2016\), Characteristics of a bending-loss insensitive single-mode optical fibre and cable.](#)

[ITU-T G.982] Recommendation ITU-T G.982 (1996), *Optical access networks to support services up to the ISDN primary rate or equivalent bit rates.*

[ITU-T G.985] Recommendation ITU-T G.985 (2003), *100 Mbit/s point-to-point Ethernet based optical access system.*

[ITU-T G.986] Recommendation ITU-T G.986 (2010), *1 Gbit/s point-to-point Ethernet-based optical access system.*

[ITU-T G.988] Recommendation ITU-T G.988 (2017), *ONU management and control interface (OMCI) specification.*

[ITU-T G.9807.1] Recommendation ITU-T G.9807.1 (2016), *10-Gigabit-capable symmetric passive optical network (XGS-PON).*

- [IEC 60825-2] [IEC 60825-2:2021, Safety of laser products – Part 2: Safety of optical fibre communication systems \(OFCSs\).](#)
- [IEEE 802] IEEE Standard 802 (2014), *IEEE Standard for Local and Metropolitan Area Networks: Overview and Architecture.*
- [IEEE 802.3] IEEE Standard 802.3 (2015), *IEEE Standard for Information technology – Telecommunications and information exchange between systems – Local and metropolitan area networks – Specific requirements Part 3: Carrier Sense Multiple Access with Collision Detection (CSMA/CD) Access Method and Physical Layer Specifications.*
- [BBF TR-156] Broadband Forum Technical Report 156 (2017), *Using GPONN Access in the context of TR-101.*

3 Definitions

3.1 Terms defined elsewhere

This Recommendation uses the following terms defined elsewhere:

3.1.1 optical access network (OAN) [ITU-T G.985]: The set of access links sharing the same network-side interfaces and supported by optical access transmission systems.

3.1.2 optical distribution network (ODN) [ITU-T G.985]: An ODN provides the optical transmission means from the OLT towards the users, and vice versa. It utilizes passive optical components.

3.1.3 optical line termination (OLT) [ITU-T G.985]: An OLT provides the network-side interface of the OAN, and is connected to the ODN.

3.1.4 optical network unit (ONU) [ITU-T G.982]: An ONU provides (directly or remotely) the user-side interface of the OAN, and is connected to the ODN.

3.1.5 duplex working [ITU-T G.982]: Bidirectional communication using a different wavelength for each direction of transmission over a single fibre.

3.1.6 TDECQ [IEEE 802.3]: [Transmitter dispersion and eye closure for PAM4 \(TDECQ\) is a measure of each optical transmitter's vertical eye closure when transmitted through a worst case optical channel, as measured through an optical to electrical converter \(O/E\) with a bandwidth equivalent to a reference receiver, and equalized with the reference equalizer. The reference receiver and equalizer may be implemented in software or may be part of the oscilloscope.](#)

3.1.7 TECQ [IEEE 802.3]: [Transmitter eye closure for PAM4 \(TECQ\) is a measure of the optical transmitter's eye closure using the methods specified for TDECQ except that the test fibre is not used.](#)

3.2 Terms defined in this Recommendation

None.

4 Abbreviations and acronyms

This Recommendation uses the following abbreviations and acronyms:

ANI	Access Node Interface
BER	Bit Error Ratio
Bm	Class B- stands for B minus
CPRI	Common Public Radio Interface

CRC	Cyclic Redundancy Check
DWLCH	Downstream Wavelength Channel
EMS	Element Management System
<u>ER</u>	<u>Extinction Ratio</u>
FEC	Forward Error Correction
FER	Frame Error Rate
FCS	Frame Check Sequence
GEM	GPON Encapsulation Method
HS-PtP	Higher Speed Point to Point
ID	Identifier
LPT	Link Pass Through
LRS	Line Rate Switching
MAC	Media Access Control
MC	Media Converter
MIB	Management Information Base
<u>MPI</u>	<u>Multi-Path Interference</u>
OAM	Operation, Administration and Maintenance
OAN	Optical Access Network
OC	Operation Control
ODN	Optical Distribution Network
OLT	Optical Line Termination
OMCC	ONU Management and Control Channel
OMCI	ONU Management and Control Interface
OPL	Optical Path Loss
ONU	Optical Network Unit
OSS	Operation Support System
OUI	Organizationally Unique Identifier
<u>PAM4</u>	<u>Pulse Amplitude Modulation 4-level</u>
PLOAM	Physical Layer Operations, Administration and Maintenance
PON	Passive Optical Network
QoS	Quality of Service
RE	Reach Extender
R/S	Receive/Send reference point at the interface of the ONU to the ODN
SNI	Service Node Interface
S/R	Send/Receive reference point at the OLT side
<u>TDECQ</u>	<u>Transmitter Dispersion and Eye Closure for PAM4</u>
<u>TECQ</u>	<u>Transmitter Eye Closure for PAM4</u>

TOL Transmit Optical Level

UNI User Network Interface

WDM Wavelength Division Multiplexing

5 Conventions

None.

6 Configuration of an OAN

6.1 System configuration

Figure 6-1 shows the system configuration of the BiDi PtP optical access system.

The two directions for optical transmission in the ODN are identified as follows:

- downstream direction for signals travelling from the OLT to the ONU;
- upstream direction for signals travelling from the ONU to the OLT.

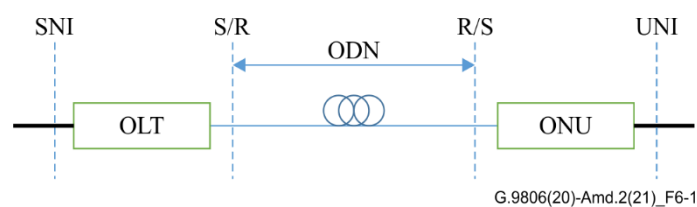

Figure 6-1 – System configuration

The reference points in Figure 6-1 are defined below:

- S: The sending interface to the network
- R: The receiving interface from the network
- S/R, R/S: Combination of points S and R existing simultaneously in a single fibre, when operating in bidirectional mode. The S/R point is referenced to the OLT side, the R/S point is referenced to the ONU side
- SNI: service node interface
- UNI: user network interface

~~See clause 5.1 of [ITU-T G.985].~~

6.2 Fibre type

Single-mode fibre should be used in accordance with [ITU-T G.652] and [ITU-T G.657].

~~See clause 5.2 of [ITU-T G.985].~~

6.3 Transmission methodology

Bidirectional transmission is accomplished by the duplex technique using two wavelength bands in each transmission direction over a single fibre.

Former point to point duplex systems defined in ITU-T make use of the 1310 nm and 1550 nm windows operating at line rates of 1 Gbit/s and below.

For duplex mode to accommodate line rates higher than 1 Gbit/s over longer distances, HS-PtP would benefit from the progress of the optical filtering and active devices technology developed for the bulk market.

Going fully O band can minimize chromatic dispersion effects and offer the capacity to benefit from the building blocks designed for larger markets. Having both upstream and downstream channels in the same wavelength window in the low dispersion area also enables the use of the lowest cost coding.

To enable energy efficiency in low payload or idle periods, it is required that the system be line rate versatile with agility between the line rates of interest and sub-rates (e.g., 50 Gbit/s / 25 Gbit/s / 10 Gbit/s / 1 Gbit/s / 100 Mbit/s) with a dynamic auto-negotiation capability.

6.4 Transmission distances

Transmission distances of 10 km, 20 km, and 40 km are within the scope of this Recommendation.

Transmission distances longer than 40 km are for further study.

6.5 Wavelength allocation

To match the full range of distance and line rates, the following wavelength plan is specified.

Table 6-1 – Wavelength plan

Wavelength pair against nominal line rate	10 Gbit/s	25 Gbit/s	50 Gbit/s
Downstream direction	1330 ± 10 nm	1314 ± 8 nm	1314 ± 8 nm
Upstream direction	1270 ± 10 nm	1289 ± 8 nm	1289 ± 8 nm

Clear visual recognition of the pluggable optical modules at both the transmit and receive sides, shall be provided. Colour coding must enable quick identification of which side of the point-to-point link the optical module is intended. If different modules are necessary to cover the full extent of line rates and distances, the colour code must also enable easy identification to avoid errors in complex inventory situations.

6.6 ODN model

The ODN provides the optical transmission medium for the physical connection between ONT and OLT.

The ODN for the point-to-point configuration consists of passive optical elements as follows:

- single-mode optical fibres and cables;
- optical fibre ribbons and ribbon cables;
- optical connectors;
- passive optical attenuators;
- splices.

The ODN is defined between the reference points S and R. In analogy with the definitions provided in [b-ITU-T G.955], S and R are defined as follows:

- S: Point on the optical fibre just after the OLT/ONU optical connection point (i.e., optical connector or optical splice).
- R: Point on the optical fibre just before the OLT/ONU optical connection point (i.e., optical connector or optical splice).

Because of the one-fibre bidirectional transmission, the point S and R at each end of the ODN are located on the same fibre.

The optical properties of the ODN shall enable the provision of any presently foreseeable service without the need of extensive modifications to the ODN itself. A set of essential items, which have a direct influence on the optical properties of the ODN, are identified as follows:

- Optical wavelength transparency: Devices, which are not intended to perform any wavelength-selective function, shall be able to support transmission of signals at any wavelength in the 1310 nm and 1550 nm regions.
- Reciprocity: Reversal of input and output ports shall not cause significant change of the optical loss through the device.

If additional connectors or other passive devices are needed for ODN rearrangement, they shall be located between the reference points S and R and their losses shall be taken into account in any optical loss calculation.

~~See clause 5.5 of [ITU-T G.985].~~

6.7 Line rates

Line rates at 10 Gbit/s, 25 Gbit/s and 50 Gbit/s ~~are~~ within the scope of this Recommendation.

~~Higher line rates, such as 25 Gbit/s and 50 Gbit/s, are for further study.~~

6.8 Classes for optical path loss

Recommended classes for optical path loss are shown in Table 6-2.

Table 6-2 – Classes for optical path loss

	Class S	Class A	Class B-	Class B
Minimum loss	0 dB	5 dB	10 dB	10 dB
Maximum loss	15 dB	20 dB	23 dB	25 dB

6.9 Reflectance in ODN

The reflectance of an ODN depends on the return loss characteristics of the individual components along the optical path and on any reflection points existing in the ODN. A reflection model is described in clause 7.8.

~~See clause 5.7 of [ITU-T G.985].~~

6.10 Module naming convention

The structure of an optical module naming convention is given in Table 6-3.

The names are composed of 3 letters appended to the "line rate GBase" main body. They represent:

- First letter "B" stands for single fibre bi-directional as in IEEE naming
- Second field stands for the optical budget class (S, A or Bm)
- Third letter stands for the direction (Downstream or Upstream)

Table 6-3 – Optical module naming convention

Optical budget class	Nominal line rate	Downstream	Upstream
S	10 Gbit/s	10GBase-B-S-D	10GBase-B-S-U
	25 Gbit/s	25GBase-B-S-D	25GBase-B-S-U
	50 Gbit/s	50GBase-B-S-D	50GBase-B-S-U
A	10 Gbit/s	10GBase-B-A-D	10GBase-B-A-U
	25 Gbit/s	25GBase-B-A-D	25GBase-B-A-U
	50 Gbit/s	50GBase-B-A-D	50GBase-B-A-U
B- (Bm)	10 Gbit/s	10GBase-B-Bm-D	10GBase-B-Bm-U
	25 Gbit/s	25GBase-B-Bm-D	25GBase-B-Bm-U
	50 Gbit/s	50GBase-B-Bm-D	50GBase-B-Bm-U

7 Physical layer specification

The operation of the optical interface shall be full-duplex. Physical layer parameters are specified for each of the following applicable areas:

- Class S: Optical path loss 0-15 dB is intended to cover distances from 0 to 20 km.
- Class A: Optical path loss 5-20 dB.
- Class B: 10-23 dB: Introduced to relax the transceiver performances to cover distance up to 40 km.
- Class B: Optical path loss 10-25 dB is intended to cover distances from 20 to 40 km.

NOTE – The 5 dB overlap between class S and class B enables to avoid gaps due to ODN designs and wavelength choices.

All parameters are specified as follows and should be in accordance with Tables 7-1 and 7-2 for ONU and OLT for different wavelength and line rate options.

Commonalities across the OLT and ONU physical layer specifications should be maximized: transmit wavelength, receive wavelength, line code, maximum laser width, pulse mask and bit error ratio.

Specifications for 10 Gbit/s are in Tables 7-1.1 and 7-2.1.

Specifications for 25 Gbit/s are in Tables 7-1.2 and 7-2.2.

[Specifications for 50 Gbit/s are in Tables 7-1.3 and 7-2.3.](#)

The methodology used to convert the [IEEE 802.3] style to the ITU-T style specifications [for 10 Gbit/s and 25 Gbit/s](#) is described in Appendix II.

[The methodology used to convert the \[IEEE 802.3\] style to the ITU-T style specifications for 50 Gbit/s is described in Appendix III.](#)

Table 7-1.1 – Physical layer specification for 10 Gbit/s ONU

Items	Unit	Specification	
		Class S	Class B-
Nominal bit rate	Gbit/s	10.3125	
Transmit wavelength	nm	1260-1280	
Receive wavelength	nm	1320-1340	
Line code	–	64B66B	
Spectral characteristic Maximum –20 dB width	nm	Less than 1	
Spectral characteristic Minimum side mode suppression ratio	dB	More than 30	
Mean launch power MAX	dBm	–5.6	+4.0
Mean launch power MIN (Note)	dBm	–9.0	–0.4
Overload	dBm	–5.6	–6.0
Sensitivity	dBm	–25	–25.0
Damage threshold MAX	dBm	–4.6	–5.0
Optical path penalty MAX	dB	1	1.6
Transmitter Penalty MAX	dB	1	1
Extinction ratio Nominal	dB	6.5	6.5
Extinction ratio MIN	dB	5	5
Pulse mask {X1,X2,X3,Y1,Y2,Y3}	UI	{0.235, 0.395, 0.45, 0.235, 0.265, 0.4}	
S/X			
Optical return loss condition	dB	More than 14	
Bit error ratio	–	Less than 5×10^{-5}	
Optical return loss of the interface	dB	More than 14	
NOTE – This value is calculated using extinction ratio Nominal. The value is increased by 0.8 dB in case of the extinction ratio MIN.			

Table 7-1.2 – Physical layer specification for 25 Gbit/s ONU

Items	Unit	Specification	
		Class S	Class B-
ODN class			
Nominal bit rate	Gbit/s	25.78125	
Transmit wavelength	nm	1281-1297 nm	
Receive wavelength	nm	1306-1322 nm	
Line code	–	64B66B	
Spectral characteristic Maximum –20 dB width	nm	Less than 1	
Spectral characteristic Minimum side mode suppression ratio	dB	More than 30	
Mean launch power MAX	dBm	0.0	8.0
Mean launch power MIN (Note)	dBm	–3.3	4.7
Overload	dBm	0.0	–2.0
Sensitivity	dBm	–20.0	–20.0
Damage threshold MAX	dBm	1.0	–1.0
Optical path penalty MAX	dB	1.7	1.7
Transmitter Penalty MAX	dB	1.0	1.0
Extinction ratio Nominal	dB	5.5	5.5
Extinction ratio MIN	dB	4	4
Pulse mask {X1,X2,X3,Y1,Y2,Y3}	UI	{0.25, 0.4, 0.45, 0.25, 0.24, 0.4}	
S/X			
Optical return loss condition	dB	More than 14	
Bit error ratio	–	Less than 5×10^{-5}	
Optical return loss of the interface	dB	More than 14	

NOTE – This value is calculated using extinction ratio Nominal. The value is increased by 1.2 dB in case of the extinction ratio MIN.

Table 7-1.3 – Physical layer specification for 50 Gbit/s ONU

<u>Items</u>	<u>Unit</u>	<u>Specification</u>	
		<u>Class S</u>	<u>Class B-</u>
<u>Modulation format</u>		<u>PAM4</u>	
<u>Nominal modulation rate</u>	<u>Gbit/s</u>	<u>25.78125</u>	
<u>Transmit wavelength</u>	<u>nm</u>	<u>1281-1297 nm</u>	
<u>Receive wavelength</u>	<u>nm</u>	<u>1306-1322 nm</u>	
<u>Line code</u>	<u>=</u>	<u>64B66B</u>	
<u>Spectral characteristic</u> <u>Maximum –20 dB width</u>	<u>nm</u>	<u>Less than 1</u>	
<u>Spectral characteristic</u> <u>Minimum side mode suppression ratio</u>	<u>dB</u>	<u>More than 30</u>	
<u>Mean launch power MAX</u>	<u>dBm</u>	<u>3.6</u>	<u>11.6</u>
<u>Mean launch power MIN (Note1) (Note 2)</u> • <u>for TDECQ < 1.4 dB</u> • <u>for 1.4 dB ≤ TDECQ < 3.2 dB</u>	<u>dBm</u>	<u>-0.4</u> <u>-0.4 +TDECQ</u>	<u>7.6</u> <u>7.6 +TDECQ</u>
<u>Launch power in OMAouter minus TDECQ (min)</u>		<u>-1</u>	<u>+7</u>
<u>Overload</u>	<u>dBm</u>	<u>3.6</u>	<u>1.6</u>
<u>Average launch power of OFF transmitter (max)</u>		<u>-20.0</u>	<u>-20.0</u>
<u>Receiver Sensitivity, (Note 2)</u> • <u>for TECQ < 1.4 dB</u> • <u>for 1.4 dB ≤ TECQ < 3.2 dB</u>	<u>dBm</u>	<u>-15.9</u> <u>-15.9 +TECQ</u>	<u>-15.9</u> <u>-15.9 +TECQ</u>
<u>Damage threshold MAX</u>	<u>dBm</u>	<u>4.6</u>	<u>2.6</u>
<u>Transmitter and dispersion eye closure for PAM4 (TDECQ) MAX</u>	<u>dB</u>	<u>3.2</u>	<u>3.2</u>
<u>Optical path penalty MAX, (Informative)</u>	<u>dB</u>	<u>2.5</u>	<u>2.5</u>
<u>Extinction ratio MIN (Note 3)</u>	<u>dB</u>	<u>6.0</u>	<u>6.0</u>
<u>Bit error ratio</u>		<u>Less than 2.4×10⁻⁴</u>	
<u>Optical return loss of the interface</u>	<u>dB</u>	<u>More than 14</u>	
<u>Transmitter reflectance</u>	<u>dB</u>	<u>-26</u>	
<p><u>NOTE 1 – A lower "Mean launch power minimum" is allowed but will be compensated by higher extinction ratio, within the limits of the "Launch power in OMAouter minus TDECQ (min)" value.</u></p> <p><u>NOTE 2 – The transmitter-receiver power budget takes into account 0.5 dB margin for MPI penalty in the link.</u></p> <p><u>NOTE 3 – Extinction ratio of a PAM4 signal is the ratio of the average launch power at the highest level and the average launch power at the lowest level. See IEEE 802.3 Standard clause 139.7.6.</u></p>			

Table 7-2.1 – Physical layer specification for 10 Gbit/s OLT

Items	Unit	Specification	
		Class S	Class B-
ODN class			
Nominal bit rate	Gbit/s	10.3125	
Transmit wavelength	nm	1320-1340	
Receive wavelength	nm	1260-1280	
Line code	–	64B66B	
Spectral characteristic Maximum –20 dB width	nm	Less than 1	
Spectral characteristic Minimum side mode suppression ratio	dB	More than 30	
Mean launch power MAX	dBm	+5.6	+4.0
Mean launch power MIN (Note)	dBm	–9.0	–0.4
Overload	dBm	–5.6	–6.0
Sensitivity	dBm	–25	–25.0
Damage threshold MAX	dBm	–4.6	–5.0
Optical path penalty MAX	dB	1	1.6
Transmitter Penalty MAX	dB	1	1
Extinction ratio nominal	dB	6.5	6.5
Extinction ratio MIN	dB	5	5
Pulse mask {X1,X2,X3,-Y1,Y2,Y3}	UI	{0.235, 0.395, 0.45, 0.235, 0.265, 0.4} For further study	
S/X			
Optical return loss condition	dB	More than 14	
Bit error ratio	–	Less than 5×10^{-5}	
Optical return loss of the interface	dB	More than 14	

Table 7-2.2 – Physical layer specification for 25 Gbit/s OLT

Items	Unit	Specification	
		Class S	Class B-
ODN class			
Nominal bit rate	Gbit/s	25.78125	
Transmit wavelength	nm	1306-1322 nm	
Receive wavelength	nm	1281-1297 nm	
Line code	–	64B66B	
Spectral characteristic Maximum –20 dB width	nm	Less than 1	
Spectral characteristic Minimum side mode suppression ratio	dB	More than 30	
Mean launch power MAX	dBm	0.0	8.0
Mean launch power MIN (Note)	dBm	–3.3	4.7
Overload	dBm	0.0	–2.0
Sensitivity	dBm	–20.0	–20.0
Damage threshold MAX	dBm	1.0	–1.0
Optical path penalty MAX	dB	1.7	1.7
Transmitter Penalty MAX	dB	1.0	1.0
Extinction ratio Nominal	dB	5.5	5.5
Extinction ratio MIN	dB	4	4
Pulse mask {X1,X2,X3,Y1,Y2,Y3}	UI	{0.25, 0.4, 0.45, 0.25, 0.24, 0.4}	
S/X			
Optical return loss condition	dB	More than 14	
Bit error ratio	–	Less than 5×10^{-5}	
Optical return loss of the interface	dB	More than 14	
NOTE – This value is calculated using extinction ratio Nominal. The value is increased by 1.2 dB in case of the extinction ratio MIN.			

Table 7-2.3 – Physical layer specification for 50 Gbit/s OLT

<u>Items</u>	<u>Unit</u>	<u>Specification</u>	
		<u>Class S</u>	<u>Class B-</u>
<u>ODN class</u>			
<u>Modulation format</u>		<u>PAM4</u>	
<u>Nominal modulation rate</u>	<u>Gbit/s</u>	<u>25.78125</u>	
<u>Transmit wavelength</u>	<u>nm</u>	<u>1306 – 1322 nm</u>	
<u>Receive wavelength</u>	<u>nm</u>	<u>1281 – 1297 nm</u>	
<u>Line code</u>	<u>=</u>	<u>64B66B</u>	
<u>Spectral characteristic</u> <u>Maximum –20 dB width</u>	<u>nm</u>	<u>Less than 1</u>	
<u>Spectral characteristic</u> <u>Minimum side mode suppression ratio</u>	<u>dB</u>	<u>More than 30</u>	
<u>Mean launch power MAX</u>	<u>dBm</u>	<u>3.6</u>	<u>11.6</u>
<u>Mean launch power (min), (Note1) (Note 2)</u> • <u>for TDECQ < 1.4 dB</u> • <u>for 1.4 dB ≤ TDECQ < 3.2 dB</u>	<u>dBm</u>	<u>-0.4</u> <u>-0.4 +TDECQ</u>	<u>7.6</u> <u>7.6 +TDECQ</u>
<u>Launch power in OMAouter minus TDECQ (min)</u>	<u>dBm</u>	<u>-1</u>	<u>+7</u>
<u>Overload</u>	<u>dBm</u>	<u>3.6</u>	<u>1.6</u>
<u>Average launch power of OFF transmitter (max)</u>		<u>-20.0</u>	<u>-20.0</u>
<u>Receiver sSensitivity, (Note 2)</u> • <u>for TECQ < 1.4 dB</u> • <u>for 1.4 dB ≤ TECQ < 3.2 dB</u>	<u>dBm</u>	<u>-15.9</u> <u>-15.9 +TECQ</u>	<u>-15.9</u> <u>-15.9 +TECQ</u>
<u>Damage threshold MAX</u>	<u>dBm</u>	<u>4.6</u>	<u>2.6</u>
<u>Transmitter and dispersion eye closure for PAM4 (TDECQ) MAX</u>	<u>dB</u>	<u>3.2</u>	<u>3.2</u>
<u>Optical path penalty MAX (Informative)</u>	<u>dB</u>	<u>2.5</u>	<u>2.5</u>
<u>Extinction ratio MIN (Note 3)</u>	<u>dB</u>	<u>6.0</u>	<u>6.0</u>
<u>Bit error ratio</u>		<u>Less than 2.4×10⁻⁴</u>	
<u>Optical return loss of the interface</u>	<u>dB</u>	<u>More than 14</u>	
<u>Transmitter reflectance</u>	<u>dB</u>	<u>-26</u>	
<p><u>NOTE 1 – A lower "Mean launch power minimum" is allowed but will be compensated by higher extinction ratio, within the limits of the "Launch power in OMAouter minus TDECQ (min)" value.</u></p> <p><u>NOTE 2 – The transmitter-receiver power budget takes into account 0.5 dB margin for MPI penalty in the link.</u></p> <p><u>NOTE 3 – Extinction ratio of a PAM4 signal is the ratio of the average launch power at the highest level and the average launch power at the lowest level. See clause 139.7.6 of [IEEE 802.3].</u></p>			

7.1 Transmit wavelength/Receive wavelength

The transmit and receive wavelengths are described in clause 6.5.

7.2 Bit rate and line coding

HS-PtP systems must provide a suite of line rates, preferably integer multiples of line rates in legacy systems, adjusting to the actual traffic load to be conveyed.

Bit rate of both upstream and downstream must be versatile to enable energy efficiency with dynamic line rate switching, without causing any downstream clock disruption.

Table 7-3 captures the modulation, coding and protection choices made to meet the expected transmission performances while maximizing the commonalities with IEEE for the line rates considered.

Table 7-3 – Modulation, line code and FEC at different line rates

Line rate (Gbit/s)	Modulation	Coding	FEC	Input BER	Reference
10	NRZ	64B66B	RS(528, 514)	5×10^{-5}	Clause 108 of [IEEE 802.3]
25	NRZ	64B66B	RS(528, 514)	5×10^{-5}	Clause 108 of [IEEE 802.3]
50	<u>PAM4</u> FFS	<u>64B66B</u> FFS	<u>RS(528, 514)</u> FFS	<u>2.4×10^{-4}</u> FFS	<u>Clauses 133, 134, 135 of [IEEE 802.3]</u> FFS

7.3 Spectral characteristics

The maximum spectral width is specified by the maximum full width measured at the point of 20 dB lower than the maximum amplitude of the central wavelength under standard operating conditions. Additionally, for control of mode partition noise in single longitudinal mode systems, a minimum value for the laser side-mode suppression ratio is specified.

7.4 Mean launched power

Mean launched power at reference point is the average optical power of a pseudo-random data sequence coupled into the fibre by the transmitter.

~~See clause 6.4 of [ITU-T G.985].~~

7.5 Receiver characteristics

Receiver characteristics are described as overload and sensitivity as the average optical power against pseudo-random data sequence. Sensitivity includes power penalty.

~~See clause 6.5 of [ITU-T G.985].~~

7.6 Extinction ratio

For 10 Gbit/s and 25 Gbit/s, the convention adopted for optical logic level is:

- P_1 : Emission light for a logical "1";
- P_0 : No emission light for a logical "0".

The extinction ratio (ER) is defined as: $ER = 10 \log_{10}(P_1/P_0)$, where P_1 is the average optical power level for a logical "1" and P_0 is the average optical power level for a logical "0".

For 50 Gbit/s, the extinction ratio of a PAM4 optical signal is defined as the ratio of the average optical launch power level P_3 , measured over the central 2 UI of a run of 7 threes, and the average optical launch power level P_0 , measured over the central 2 UI of a run of 6 zeros, as shown in Figure 7–1 that is reproduced from clause 121.8.4 (Figure 121–3) of [IEEE 802.3].

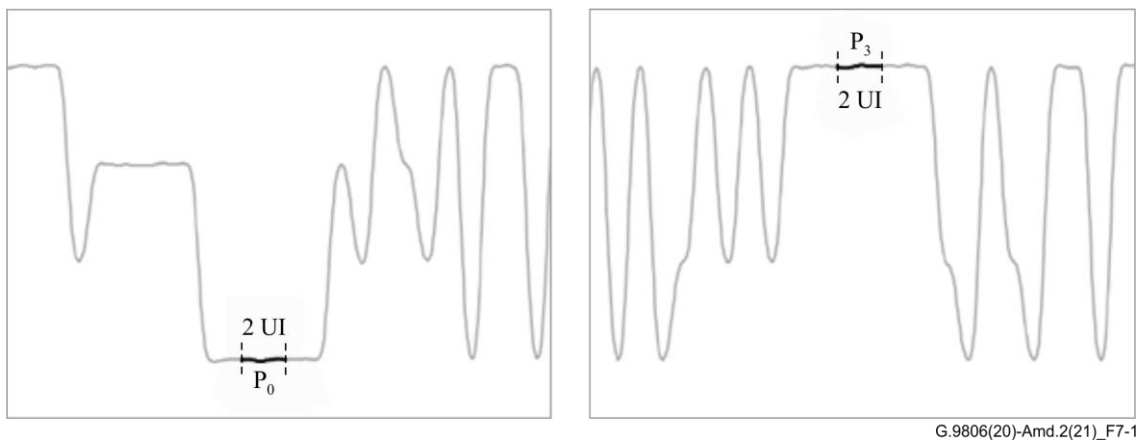

Figure 7-1 – Example power levels P_0 and P_3 from PRBS13Q test pattern (Reproduced from clause 121.8.4 (Figure 121–3) of [IEEE 802.3])

See clause 6.6 of [ITU-T G.985].

7.7 Pulse mask

Pulse mask at reference points is in conformance with the mask of the transmitter eye diagram for 10GBASE-E specified in clause 52.7.1 (Table 52-16) of [IEEE 802.3] and 25GBASE-ER in clause 114.6.1 (Table 114-6) of [IEEE 802.3].

Pulse mask does not apply to 50 Gbit/s.

7.8 S/X

For 10 Gbit/s and 25 Gbit/s.

The OLT (or ONU) shall receive both signal and cross-talk light from the ONU (or OLT) because of multiple reflections incurred by discontinuity of reflective index on the optical path. The OLT or ONU must have applicable S/X against reflection from the optical path which satisfies the specification of optical return loss.

The reflection model is assumed to have such a structure that it is connected to two connectors at near end, with optical return loss of 35 dB for one connector and 32 dB for two connectors.

If the total optical return loss of optical signals transmitted from the OLT (or ONU), which reflects on the optical path and/or at the opposite ONU (or OLT), falls on the value described in Tables 7–1.x and 7–2.x, the bit error ratio in Tables 7-1.x and 7-2.x can be satisfied within the range of receiver characteristics in this Recommendation.

For 10 Gbit/s and 25 Gbit/s, in Tables 7-1.1, 7-1.2, 7-2.1 and 7-2.2, minimum optical return loss of the optical path is assumed to be 14 dB because the reflection from two connectors (32 dB) is small enough compared with that from the ONU or OLT (14 dB).

For 50 Gbit/s, in Tables 7-1.3 and 7-2.3, optical return loss tolerance is specified at 15 dB and maximum transmitter reflectance is –26 dB. Transmitter reflectance is defined looking into the transmitter.

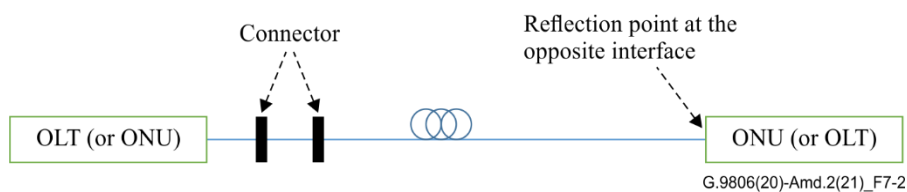

Figure 7-2 – Reflection model

~~See clause 6.8 of [ITU-T G.985].~~

7.9 Optical return loss of the interface

The optical return loss of the interface means the ODN reflection of its received light. Therefore, the optical return loss of the interface is defined by the wavelength allocation in Table 6-1 [in clause 6.5](#).

7.10 Test pattern

The data pattern to be used in measuring wavelength or spectral characteristics is not specified in this Recommendation, but the test patterns defined in clause 52.9.1 of [IEEE 802.3] may be used as a reference [for 10 Gbit/s and 25 Gbit/s, and in clause 139.7.1 of \[IEEE 802.3\] for 50 Gbit/s](#).

7.11 Signal detect

[Interruption of communication such as release of optical connector or ONU Tx outage shall be detected to avoid incorrect link up between OLT and ONU.](#)

[Loss of power of the ONU side generates a dying gasp prior to end of transmission.](#)

~~See clause 6.12 of [ITU-T G.985].~~

8 Transmission convergence layer and ONU management

8.1 OAM structure

The following combined OAM structure is applied to HS-PtP transmission. ONU management and control interface (OMCI) specifications are optimized for single domain ONU management, of which the managed entities are specified in [ITU-T G.988].

- OAM for link operation: The OAM functions specified in clause 57 of [IEEE 802.3] are applied.
- OAM for ONU equipment and service management: The OMCI specifications optimized for this clause are applied.

Table 8-1 summarizes the OAM functions and indicates whether the OAM specifications from clause 57 of [IEEE 802.3], or the OMCI specifications optimized for this clause, are applicable to each of them.

Table 8-1 – OAM functions and applicable specifications

OAM functions		Applicable specifications
ONU status notification	ANI status	Clause 57 (OAM) of [IEEE 802.3]
	ONU vendor code and ONU model number	OMCI for this clause ONU-E defined in clause 9.1.13 of [ITU-T G.988]
	UNI status	OMCI for this clause Physical path termination point of Ethernet UNI defined in clause 9.5.1 of [ITU-T G.988]

Table 8-1 – OAM functions and applicable specifications

OAM functions		Applicable specifications
ONU remote setting	UNI status	OMCI for this clause Physical path termination point of Ethernet UNI defined in clause 9.5.1 of [ITU-T G.988]
Fault management	Power supply	Clause 57 (OAM) of [IEEE 802.3]
	ONU failure	Clause 57 (OAM) of [IEEE 802.3] and/or OMCI for this clause ONU-E defined in clause 9.1.13 [ITU-T G.988]
	Received signal	Clause 57 (OAM) of [IEEE 802.3]
	UNI status	OMCI for this clause Physical path termination point of Ethernet UNI defined in clause 9.5.1 of [ITU-T G.988]
Loop-back test	ONU loop-back status	OMCI for this clause Physical path termination point of Ethernet UNI defined in clause 9.5.1 of [ITU-T G.988]

8.2 OMCI Ethernet frame

8.2.1 Frame structure

For OAM used for ONU equipment and service management, each ONU management and control protocol packet is encapsulated into the protocol data field as the OMCI message field in a media access control (MAC) frame with the organizationally unique identifier (OUI) extended Ethertype in the Length/Type field defined in clause 9.2.4 of [IEEE 802]. The frame is called the OMCI Ethernet frame in this Recommendation. Figure 8-1 shows the OMCI Ethernet frame structure where the ONU management and control protocol packet is assumed to be taken from a G-PON encapsulation method (GEM) packet.

The OMCI Ethernet frame contains a single 40-byte long OMCI message field.

Methods for extended OMCI messages are in conformance with clause 11 of [ITU-T G.988].

ONT management and control protocol packet in a GEM packet

GEM header (5 bytes)	Transaction correlation identifier (2 bytes)	Message type (1 byte)	Device identifier (1 byte)	Message identifier (4 bytes)	Message contents (32 bytes)	OMCI trailer (8 bytes)
----------------------	--	-----------------------	----------------------------	------------------------------	-----------------------------	------------------------

OMCI Ethernet frame

Destination MAC address (6 bytes)	Source MAC address (6 bytes)	OUI Extended Ethertype (2 bytes)	Protocol Identifier (5 bytes)	Length of next OMCI message (2 bytes)	OMCI message (40 bytes)	End of OMCI (2 bytes)	Frame check sequence (4 bytes)
-----------------------------------	------------------------------	----------------------------------	-------------------------------	---------------------------------------	-------------------------	-----------------------	--------------------------------

G.9806(20)_F8-1

Figure 8-1 – OMCI Ethernet frame structure

8.2.2 Frame format and messages

The OMCI Ethernet frame format and messages are defined in Table 8-2.

Table 8-2 – OMCI Ethernet frame format and messages

Field	Length	Definition	Value
Destination MAC address	6 bytes	Destination MAC address	See clause 7.2.2.1
Source MAC address	6 bytes	Source MAC address	See clause 7.2.2.1
OUI extended Ethertype	2 bytes	OUI extended Ethertype defined in [IEEE 802]	0x88-B7
Protocol identifier	5 bytes	Protocol ID defined in [IEEE 802]	
OUI	3 bytes	ITU-T OUI	0x00-19-A7
ITU-T Subtype	2 bytes	ITU-T Subtype reserved by Q.2/15 for OMCI	0x00-02
Length of next OMCI message	2 bytes	Indication of the length of a following OMCI message field	0x00-28
OMCI message	40 bytes		For further study, to accept flexible length messages.
Transaction correlation identifier	2 bytes	Defined in [ITU-T G.988]	
Message type	1 byte	Defined in [ITU-T G.988]	
Device identifier	1 byte	Defined in [ITU-T G.988]	0x0A
Message identifier	4 bytes	Defined in [ITU-T G.988]	
Message contents	32 bytes	Defined in [ITU-T G.988]	
End of OMCI	2 bytes	Indication of no OMCI message following	0x00-00
Frame check sequence	4 bytes	FCS defined in [IEEE 802.3]	

8.2.2.1 Destination MAC address and source MAC address

In the OMCI Ethernet frame format shown in Table 8-2, the destination MAC address shall be the broadcast address or the unicast MAC address of the far end equipment, which is not defined in this Recommendation. Source MAC address shall be the source equipment MAC address.

8.2.3 Frame termination rule

The following frame termination rule shall be applied to the OMCI Ethernet frame.

- 1) Frame termination rule at access node interface (ANI):

When a frame with destination MAC address, OUI extended Ethertype and protocol identifier, all of which satisfy the values defined in Table 8-2, is received,

 - the received frame shall not be transferred to UNI nor to service node interface (SNI).
- 2) Frame termination rule at UNI or SNI:

When a frame with OUI extended Ethertype and protocol identifier, both of which satisfy the values defined in Table 8-2, is received,

 - the received frame shall not be transferred to ANI;
 - messages contained in the received frame shall be ignored.

8.3 Activation process

Figure 8-2 shows the activation process. As described in clause 10.1, the ONU shall follow the silent start function first.

After recognizing the OLT initial operation control (OC) message, the ONU answers through its OC message answer.

This message exchange also allows distance estimation with the procedure outlined below. It is optional to implement the distance estimation function in OLT/ONU.

The OLT then transmits the estimation of the OLT to ONU distance in its OC message. After the ONU acknowledges receiving the distance estimation OC message, both the OLT and ONU will enter full speed mode, with the necessary digital compensation processing as appropriate. Clause 8.3.1 describes the message format.

The full content of the OC adapted from the one defined for PON in clause 10.1.1 of [ITU-T G.9807.1] and the ONU answer details are described in clauses 8.3.2 and 8.3.3, respectively.

Upon the start of link up, the ONU reflects in the upstream OAM the OLT identifier and transmits information enabling the round trip delay estimation to recover the delay for phase knowledge necessary for some mobile applications.

Then, the ONU management and control channel (OMCC) handshaking process begins.

During the process, the OLT shall check if the OMCI and which managed entities are supported by the ONU: The OLT performs a Get action on the ONU data managed entity. When the OLT receives a proper Get response from the ONU, the OLT recognizes that the ONU supports a proper OMCI. It is outside the scope of this Recommendation if the OLT should perform Get actions on other entities.

When the OMCC handshaking is done, the OMCC is established. Before, during, or after the OMCC handshaking process, the OAM discovery process for link operation begins. The OAM discovery process is specified in clause 57 of [IEEE 802.3].

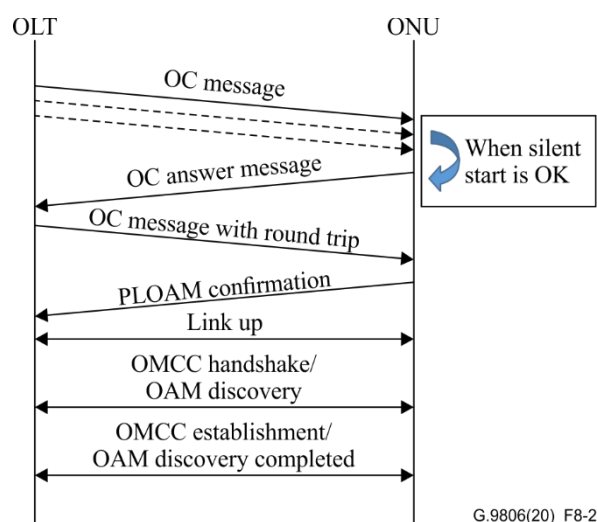

Figure 8-2 – Activation process

8.3.1 Activation initial messaging

The initial activation will be based on generic PtP OC messages. These messages are to be used by the OLT CT and ONU as long as ONU valid answer has not been received and estimation of the round trip delay has not been completed.

This messaging will also be resumed upon loss of connectivity between OLT and ONU, corresponding then to a possible trouble shooting situation.

The message structure consists of a preamble, a PtP OC body and a CRC protection enabling its quick recovery as shown in Figure 8-3.

- The preamble is 4 bytes long (suggested pattern 0x AA AA AA AF)
- The PtP OC body is 8 bytes long
- The CRC is 1 byte long



Figure 8-3 – OC message structure

For the sake of low power consumption and low cost, the OLT CT and ONU adopt an NRZ modulation at 1 Gbit/s [for 10 Gbit/s. Application to 25 and 50 Gbit/s is for further study.](#)

The OLT cyclically transmits this PtP OC message once in a second.

The ONU transmits its answer upon OLT implicit prompting.

Upon detection of a valid ONU OC answer message, the OLT performs an estimation of the round-trip delay and transmits it to the ONU that will acknowledge it.

Upon reception of the ONU acknowledgment of the round-trip delay, both ends enter the "link up" state of the activation process.

8.3.2 OC message

The PtP OC body content is meant to report to field engineers and ONUs, the nature and the capabilities of the OLT, in order for the engineers to check the status of the ODN. It also enables a generic answer to start the "link up" stage of the activation process across future options of this Recommendation.

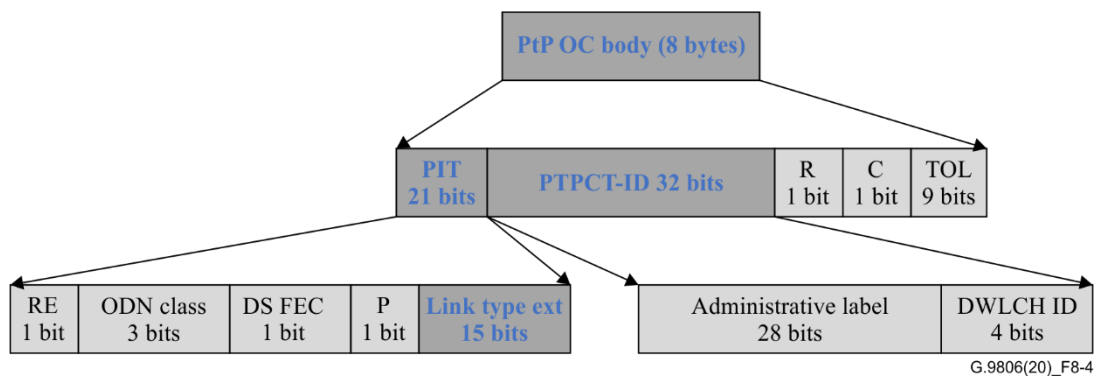

Figure 8-4 – Operation control structure

The OC structure is shown in Figure 8-4 and the content of the PtP OC body as follows:

PIT, or **PTPCT-ID type** (8 bits, static, provisioned by the operator): an indication of the ODN architecture, the source of the reported launch power and the ODN class. The PTPCT-ID type (PIT) field is further partitioned as follows:

- **RE flag** (1 bit): indicates whether the transmit optical level (TOL) field contains the launch power of the OLT (RE = 0) or of a reach extender (RE = 1).

- **ODN class** (3 bits): identifies the nominal optical parameters of the transceiver according to ODN optical path loss (OPL) class as defined in Table 8-3, reusing [ITU-T G.985] and [ITU-T G.989] code values.

Table 8-3 – ODN optical path loss (OPL) class encoding

Code value	ODN OPL class
000	S
001	A
010	B
011	L1
100	L2
101	B-
110	Reserved
111	Reserved

- **DS FEC flag** (1 bit): Indicates whether FEC is enabled in the downstream direction. When this bit is set to 1, the FEC of the carried downstream channel is enabled. When this bit is set to 0, the FEC of the carried downstream channel is disabled.
- **P flag** (1 bit): Initially set to zero, the P flag is set when an ONU has been detected and round-trip delay confirmation is expected from the ONU.
- **Link type ext** (15 bits): The link type "extended" is segmented in two sections.
 - **Distance estimation** (13 bits): Set to zero by default, it contains upon reception of a valid answer from an ONU the estimated distance between the OLT and ONU in multiple of 10 m. 13 bits enable to cover up to 80 km.
 - **Link type legacy** (2 bits): reserved

NOTE – This two-bit field inherited from PON OC could be used to indicate the ITU-T G.9806 mode (transparent or transcoded, or data rate or else ...) and the type of application/terminal supported by the OLT. This application remains for further study ~~FFS~~.

PTPCT-ID (32 bits, static, provisioned by the operator): Identifies the OLT CT within a certain domain. PTPCT-ID consists of two fields:

- **Administrative label**: 28-bit field, supplied by an element management system ([EMS](#)) or operation support system ([OSS](#)) to the OLT in accordance with certain physical or logical numbering plan. The administrative label is treated transparently by the OLT.
- **DWLCH ID**: 4-bit field, can take on any value for future wavelength division multiplexing ([WDM](#)) context. It also enables to cover the case of several wavelength options for a single channel co-existing on the market. This application remains for further study.
 - **R** (1 bit): Reserved.
 - **C** (1 bit): Transmit optical level reference point indicator. This must be set to 0 for single channel systems.
 - **C = 0**: The TOL value below refers to the S/R reference point.

TOL (9 bits, dynamic, maintained by the system): Transmit optical level. An indication of the current OLT transceiver channel launch power into the ODN (at the S/R reference point), if RE = 0, or reach extender transceiver launch power, if RE = 1. Its value is an integer representing a logarithmic power measure having 0.1 dB granularity with respect to –30 dBm (i.e., the value zero represents –30 dBm, 0x12C represents 0 dBm, and 0x1FE represents 21 dBm). The 0x1FF default value indicates that TOL is not supported on the given PtP interface.

8.3.3 OC answer message

In order to simplify the messaging mechanism, symmetrical OC message structure is used. Hence the OC answer body is 8 byte long. The OC answer message structure is shown in Figure 8-5.

The OC answer message shall be used twice in the activation process.

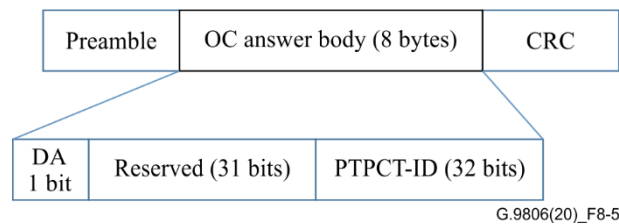

Figure 8-5 – OC answer message structure

Detail of the OC answer body is given below:

- Byte 0:
 - Bit 7 DA (Distance Acknowledge): set to zero by default, will carry the acknowledgement of the distance information, when the P flag of the OC downstream message has been found set to "1".
 - Bit 0-6 are reserved.
- Bytes 1 to 3 are reserved.
- Bytes 4 to 7 carry the downstream PTPCT-ID.

[Additional content of OC field for PAM4 is for further study.](#)

8.4 ONU with multiple UNI ports

The specification of the ONU having multiple user network interface (UNI) ports shall be specified in this Recommendation as optional. Figure 8-6 shows an image of the ONU having multiple UNI ports. The physical path termination point Ethernet UNI managed entity defined in clause 8.7.3 is specified to support multiple UNI ports also.

NOTE – Data forwarding permission rule between UNI ports is for further study.

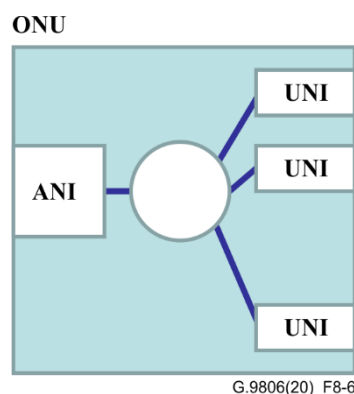

Figure 8-6 – ONU with multiple UNI ports

8.5 Managed entities

The possible managed entities are listed in Table 8-4.

Table 8-4 – Managed entities of the OMCI for this Recommendation

Managed entity	Required/ Optional	Description
ONU-E	R	Used for ONU point to point equipment management
ONU data	R	Used for OMCI MIB management
Physical path termination point Ethernet UNI	R	Used for physical path termination point at the Ethernet UNI

8.6 Managed entity relation diagram

See clause 8.2 [ITU-T G.988].

8.7 MIB description

8.7.1 ONU-E

See clause 9.1.13 in [ITU-T G.988].

8.7.2 ONU data

See clause 9.1.3 in [ITU-T G.988].

8.7.3 Physical path termination point Ethernet UNI

See clause 9.5.1 in [ITU-T G.988].

8.8 Dual managed ONU

The OAM structure for dual domain managed HS-PtP ONU elaborates on [ITU-T G.988] Appendix II.2 mechanisms.

8.9 Encapsulation method for transparent payload

Within this described transmission system's capabilities, it is of major interest to encode transparently some legacy tributary units, with smallest possible delay. It will be enforced by the OLT depending on the ONU capabilities, for operators/use cases requiring it so as not to induce extra costs for regular ONU.

Such a feature will in any case remain optional to use.

Possibly a switch over after the regular activation process, at the initiative of the OLT, can switch to such an encapsulation method over a general purpose Ethernet point to point link, while maintaining the necessary performances.

Details of such ~~an XBytes, (X+N)Bytes encoding~~ [xByB coding](#) methods are for further study.

8.10 Link pass through capability

The option to implement link pass through is described in Appendix I.

9 Service requirements and service enabling features

9.1 Service requirements

Service requirements will be fully in line with those described in clause A.7 of [ITU-T G.9807.1].

9.2 Hitless line rate switching

In order to provide the most efficient transmission for variable traffic loads, HS-PtP must have the ability to adapt to it. This is especially required for IMT-2020 because of its ambitious power consumption objectives.

HS-PtP must provide a dynamic auto-neg of the line rate between OLT and ONU, which should be provided among the plurality of line rates supported according to the actual payload.

Because of the high clock quality requirements, and long recovery time of clock recovery circuitry, no phase drift will be permitted in the downstream direction when switching. Also, such switching will have to be without any loss.

9.2.1 Hitless line rate switching principles

Among the current requirements, disturbance to the end users should be kept minimal and preferably remain fully unnoticed. The delay to resume full speed operation must not become incompatible with the applications running.

Line rate switching conditions must therefore maintain quality of service (QoS) of connections running by monitoring of the queuing at both sides of the link. Unlike the DBA, the local (OLT) and remote (ONU) memory queues status may initiate line rates switching, with regard to the gross link rate, while maintaining the required delay performances attached to the QoS level.

In order not to cause any glitch in clock phase recovery of the ONT upon line rates switching, for timing sensitive applications, it is required that clock alignment is provided across the line rates, so that phase stability is secured for clock recovery circuits at the remote end.

9.2.2 Switching messaging sequence

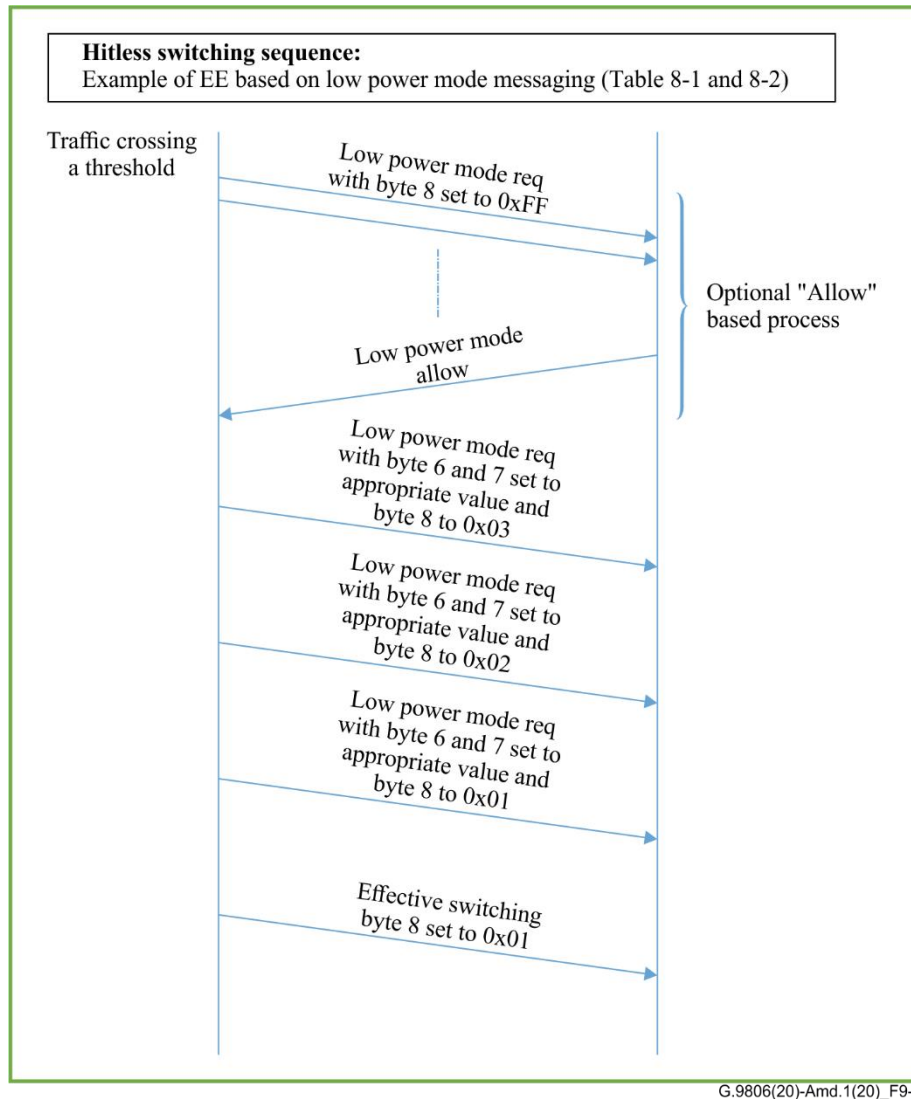

Figure 9-1 – Hitless switching protocol

Although the link is likely to be symmetrical in line rates, the clock quality maintaining and the watchful sleep protocol enabling will remain under control of the OLT.

9.2.3 Switching messages for line rate switching addition to the legacy "watchful sleep"

Ideally the switching does not require any bi-directional messaging exchange; on point to point switching can rely on simple preliminary redundant and protected announcements by the transmitter. Nevertheless, to secure switching, it is preferred to get acknowledgement of the process from the remote end.

In specific case of low power modes in passive optical networks (PONs), operations are handled in a single PLOAM message per direction. For point to point and here the addition of line rate switching (LSR) to the existing sleep mode (watchful sleep), this messaging needs to extend the [ITU-T G.9807.1] PLOAM legacy (dedicated to watchful sleep) and has been therefore re-branded as "Low power mode" with two messages, one for upstream and the other one for downstream.

In order to avoid multiple mapping of messages, it is proposed to shorten the related PLOAM messages to 40 bytes for point to point to adopt the mapping used for OMCI described in clause 8.2.1.

Table 9-1 – Low_power_mode_Allow message

Octet	Content	Description
1-2	0x03FF	As a broadcast message, ONU-ID = 0x03FF
3	Message type ID	0x12, "Low power mode allow"
4	SeqNo	Eight-bit unicast or broadcast PLOAM sequence number, as appropriate
5	Control flag	0000 000A, where: A = 0: Sleep allowed OFF A = 1: Sleep allowed ON Other values reserved
6	Current line rate	0xLR where LR represents an integer in the variety of possible values in Gbit/s (e.g., 0x01 for 1_Gbit/s 0x0A for 10 Gbit/s 0x32 for 50 Gbit/s ...)
7	Line rate switching status	0000 000S, where: S = 0: Line rate switching not ready S = 1: Line rate switching authorized Other values reserved
8	Nature of transition	0000 00CD, where C stands for the direction, D for a single or the max step CD = 00: Transition to next lower speed CD = 01: Transition to lowest speed CD = 10: Transition to next higher speed CD = 11: Transition to highest speed Other values reserved
9-32	Padding	Set to 0x00 by the transmitter; treated as "don't care" by the receiver
33-40	MIC	Message integrity check, computed using the default PLOAM_IK in case of broadcast message, and using the ONU-specific derived shared PLOAM_IK in case of directed message

Table 9-2 – Low_power_mode_Request message

Octet	Content	Description
1-2	ONU-ID	ONU-ID of the message sender if such an ID remains used for PLOAM, else set to 0x0000 and ignored by the receiver
3	Message type ID	0x10, "Low power mode_Request"
4	SeqNo	Always 0x00
5	Activity_level	Activity Level: 0x00: Sleep_Request (Awake) 0x03: Sleep_Request (WSleep) Watchful sleep mode request: when in a LowPower state, the ONU periodically checks the downstream traffic for wake-up indications from the OLT Other values are reserved
6	Current line rate	0xLR where LR represents an integer in the variety of possible values in Gbit/s (e.g., 0x01 for 1_Gbit/s 0x0A for 10 Gbit/s 0x32 for 50 Gbit/s...)
7	Nature of transition	0000 00CD, where C stands for the direction, D for a single or the max step CD = 00: Transition to next lower speed CD = 01: Transition to lowest speed CD = 10: Transition to next higher speed CD = 11: Transition to highest speed Other values reserved
8	Switching count down	Set to 0x00 by default Set to 0xFF to request the other end to send a "low power mode allow" message Counter is set to 0x03 and decremented upon each "Low power mode_Request" PLOAM message transmission, either upon reception of an allow message or freely if no acknowledgement is needed Switching effective with 0x00
9-32	Padding	Set to 0x00 by the transmitter and treated as "don't care" by the receiver
33-40	MIC	Message integrity check, computed using the ONU-specific derived shared PLOAM integrity key

9.3 Round trip delay knowledge

So far in ITU-T the optical access point to point recommendations did not focus so much on the system aspects. Nevertheless, when used for mobile and wireless applications, phase compensation requires some knowledge of the OLT to ONU distance which is a new feature long known in PONs.

9.4 Port identification

For field operation purposes, the inheritance of capabilities of the OC structure, previously named PON-ID will have to be translated into the HS-PtP world.

9.5 Synchronization features and quality

Synchronizing features and performance requirements will be fully in line with those described in clause A.7 of [ITU-T G.9807.1]

10 Other requirements

10.1 Silent start function of ONU

The transmitter in the ONU must be initially disabled in order to avoid disturbing other access systems in case of misconnection. The ONU shall enable the transmitter to enter a handshaking process with OLT only after confirming that the frame structure and/or the line coding of the received downstream signal match those the ONU complies with. This confirmation shall be done with both OLT and ONU being set to the auto-negotiation function defined in clause 37 of [IEEE 802.3] disabled.

When the connection between ONU and OLT is disabled, the ONU shall return to the initial state in which the transmitter is disabled, after waiting for at least 20 ms from the moment the disconnection is detected, so that the ONU can send notification signals to the OLT.

This is a unique function for the single fibre optical-access systems hence working in duplex mode, such as in [IEEE 802.3] the 10GBASE-LR (clause 52 of [IEEE 802.3]).

10.2 Provisioning/authentication method

Provisioning and authentication methods will be replicated from [BBF TR-156].

10.3 Power saving and energy efficiency

HS-PtP will provide the best user and network energy efficiency experience combining sleep periods behaviours when the link is idle (derived from the ITU-T PON watchful sleep and [b-IEEE 802.3az]), plus line rates switching during low duty periods according to the actual payload to be conveyed, enabling the logic at its ends to adapt the clock rate to the necessary throughput.

10.3.1 Sleep mode

During sleep modes bi-directional connectivity between both ends of the link will be temporarily lost.

This clause is for further study.

10.3.2 Line rate switching

LRS is optional, since not all of the payload to be conveyed can support LRS when no similar hierarchy of line rates are applicable (e.g., lowest rate only ONUs) or when the interfaces cannot support any variation in payload (e.g., incompatibility with CPRI based fronthaul).

Only a hierarchy with integer multiplication factors will be considered. Ideally factors in the form of 2^n are preferred by electronic industry engineers, but because of the IEEE suite of legacy, 1 Gbit/s, 10 Gbit/s and 50 Gbit/s are suggested as primary line rates for this energy saving scheme. Integration of 25 Gbit/s in the hierarchy is for further study because of the fractional ratio with 10 Gbit/s.

LRS protocol is required to support unidirectional switching, to also provide the best efficiency for asymmetric traffic.

A classical figure of merit widely used in network planning to start upgrading any link was 85% of the capacity. Therefore, the following thresholds over an observing period (OP) are considered:

- Switching from low speed to its next step will occur when the effective payload crosses the threshold of 85% of its capacity.

- Reversely the switching down will occur when the effective payload (EP) is lower than 85% of this lower speed link capacity.

The LRS state machine is shown in Figure 10-1 using the 85% capacity threshold as an example.

NOTE – The ~~that the~~ term "effective capacity payload" is used to avoid confusing excludes idle patterns with from actual payload.

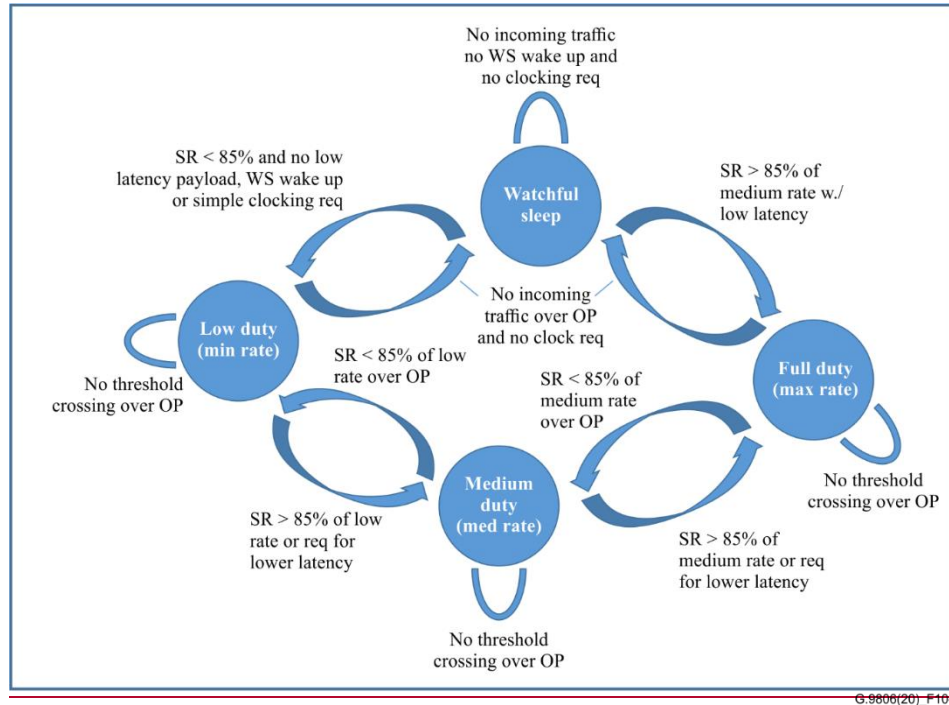

G.9806(20)_F10-1

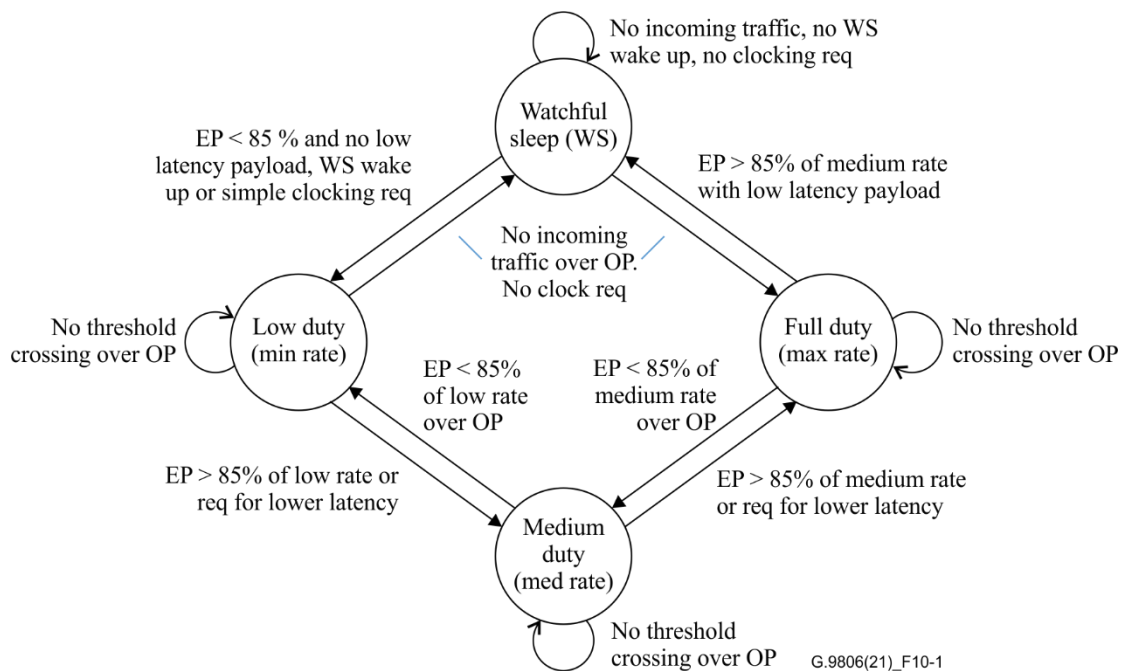

G.9806(21)_F10-1

Figure 10-1 – LRS state machine

10.4 Environmental requirements

Outdoor operation may be needed in many of the envisaged applications for HS-PtP systems; thus, ONUs shall operate over outdoor temperature ranges. The following are informative examples of environmental requirements:

- ATIS-0600010.01.2008: (Class 4 unprotected environment) –40°C to either +46°C ambient plus solar loading, or +70°C ambient.
- Telcordia GR-487: –40°C to either +46°C ambient plus solar loading, or +70°C ambient.
- ETSI ETS 300 019-1-4: (Class 4.1E: Non-weather protected locations – extended) –45°C to +45°C ambient plus solar loading.
- IEC 61753-1 cat OP^{HD}: –25°C to +85°C for Outdoor Protected (OD) environment with additional Heat Dissipation (HD).

Optionally, the OLT should also be able to operate over the extended outside temperature range.

10.5 E-OTDR support

For further study.

10.6 Encryption/Data privacy

For further study.

10.7 Eye safety concerns

All necessary mechanisms must be provided to ensure that no eye damage can be caused to end users and field operations crews unaware of the risks associated with access to fibre, including labelling and safety locking mechanisms if necessary.

The system must meet all applicable requirements for the classification, service group designation, and accessibility to ensure the safe operation and servicing of the optical fibre communication system at each node.

The total optical power resulting from one CT at S/R and R/S on the fibre must be within the safe operation range.

The BiDi point-to-point OLT and ONU need to conform to the following specific classes defined in [IEC 60825-2], respectively:

- Class 1M for OLT,
- Class 1 for ONU,

~~For further study.~~

Appendix I

Link pass through

(This appendix does not form an integral part of this Recommendation.)

Link pass through (LPT) is an optional function in media converters (MCs) to be inherited in the context of this Recommendation in which MC takes the name of optical line termination (OLT) or optical network unit (ONU). To obtain interoperability, the function will be fully described in this clause.

The purpose of LPT is quick detection of link-down on an end-to-end link between two devices connected to OLT or ONU.

The LPT is restricted to the OLT that does not perform any concentration or multiplexing. Each optical interface (ANI or S/R) of the OLT corresponds to one service node interface (SNI). LPT is not applicable for multi-port ONUs.

Layer 2 switches connected to an OLT or ONU generally have difficulties to rapidly detect the link-down, which results in problems for services with stringent requirements. Therefore, LPT is a useful function to mitigate these problems.

The expected LPT behaviours of OLT and ONU are as follows:

- 1) if the ONU detects the link-down on the user network interface UNI, the OLT reflects the link-down on the related service node interface (SNI) port;
- 2) if an OLT detects the link-down on the SNI, the ONU reflects the link-down on the related UNI port;
- 3) if the OLT detects link-down on the transmission link (ANI or at S/R), the OLT reflects the link-down on the related SNI;
- 4) if an ONU detects link-down on the transmission link (ANI or at R/S), the ONU reflects the link-down on its UNI.

Figure I.1 a) to d) show several failure cases supported by LPT. First, if link-down on the SNI side of an OLT occurs, the LPT function in the ONU will set the UNI to link-down as described in Figure I.1 a) and vice versa as in Figure I.1 b). Next, if the link-down on the ODN between an OLT and an ONU happensoccurs, the link-down both on the SNI and the UNI sides will be forced by LPT as shown in Figure I.1 c). Finally, if the electrical power failure to an ONU occurs, the link-down ~~both~~ on the SNI is forced by LPT as depicted in Figure I.1 d). Regarding the setting of "enabled" or "disabled" for LPT, the OLT and the ONU should be independently controlled according to the operator's choice.

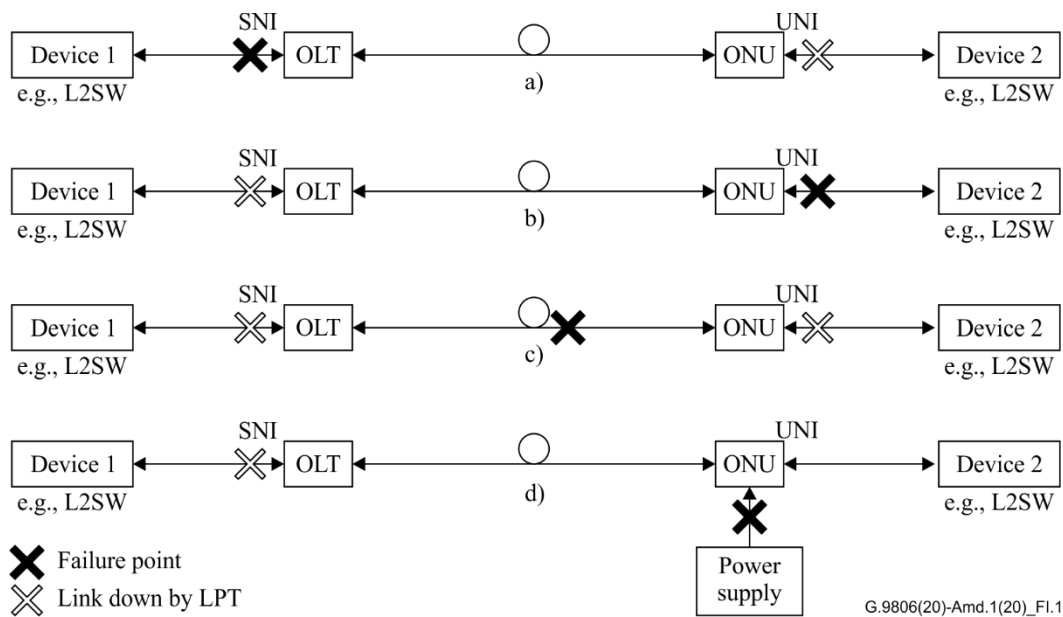

Figure I.1 – Failure cases supported by LPT: a) link-down on SNI side, b) link-down on UNI side, c) link-down between OLT and ONU, and d) power supply failure at ONU

Table I.1 shows various kinds of failure events and examples of the corresponding operations at OLT and ONU for both "enabled" and "disabled" modes of the LPT function. The operations in this table are based on the existing OAM functions in [ITU-T G.986].

Table I.1 – Failure events and the corresponding operations at OLT and ONU

Events		Operations	
		LPT enabled	LPT disabled
OLT	ANI gets down	SNI gets administrative down	Do nothing
	SNI gets down	OLT sends administrative UNI down OMCI	Do nothing
	OLT receives UNI down notification	SNI gets administrative down	Do nothing
	OLT receives dying gasp	OLT changes ANI status to down, and SNI gets administrative down	OLT changes ANI status to down
ONU	ANI gets down	UNI gets administrative down	Do nothing
	UNI gets down	ONU sends UNI link down notification	ONU sends UNI link down notification
	ONU receives administrative UNI link down OMCI	UNI gets administrative UNI down	UNI gets administrative UNI down
	ONU detects power down	ONU sends dying gasp	ONU sends dying gasp

Table I.2 shows various kinds of recovery events after failure and examples of the corresponding operations at OLT and ONU for both "enabled" and "disabled" mode of the LPT function. The operations in this table are based on the existing OAM functions in [ITU-T G.986].

Table I.2 – Recovery events and the corresponding operations at OLT and ONU

Events		Operations	
		LPT enabled	LPT disabled
OLT	ANI gets up	SNI gets administrative up	Do nothing
	SNI gets up	OLT sends administrative UNI up OMCI	Do nothing
	OLT receives UNI up notification	SNI gets administrative up	Do nothing
	ONU is activated	OLT changes ANI status to up, and SNI gets administrative up	OLT changes ANI status to up
ONU	ANI gets up	UNI gets administrative up	Do nothing
	UNI gets up	ONU sends UNI link up notification	ONU sends UNI link up notification
	ONU receives administrative UNI link up OMCI	UNI gets administrative UNI up	UNI gets administrative UNI up
	ONU gets power up	ONU starts activation process	ONU starts activation process

In addition, 1:1 link protection for external devices can be performed as an application of the LPT function. Figure I.2 shows an example of 1:1 link protection. If link-down occurs on the active line between two devices, the path of the data transmission will be switched to the protection line.

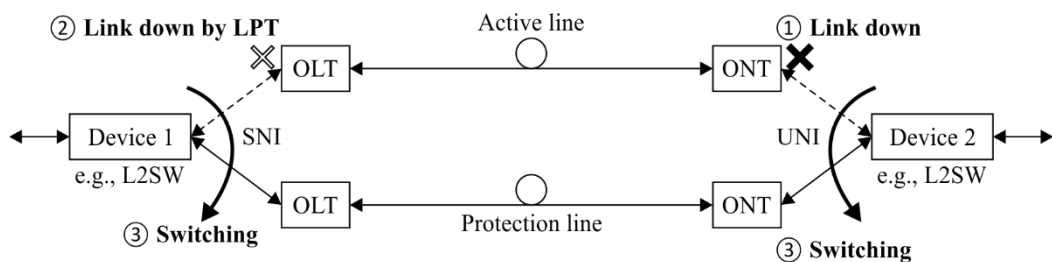

G.9806(20)_Fl.2

Figure I.2 – An example of 1+1 link protection by LPT

Appendix II

Methodology for translating the [IEEE 802.3] BiDi PtP specifications to ITU T G.9806 specifications for 10 Gbit/s and 25 Gbit/s

(This appendix does not form an integral part of this Recommendation.)

Summary

Receiver sensitivity can be specified in terms of optical modulation amplitude (OMA) or average power. To maximize commonality between optical components designed to meet [IEEE 802.3] and this Recommendation, receiver sensitivity has been translated from OMA to average power form using the method described below. The practical implications are as follows:

- 1) An extinction ratio (ER) value is assumed. Components should be labelled with their extinction ratio to ensure that OMA and average power measurements are equivalent.
- 2) The receiver sensitivity in this Recommendation accounts for the transmitter penalty that the [IEEE 802.3] specification lists separately.

Translation method

The methodology for translating the [IEEE 802.3] 10 Gbit/s and 25 Gbit/s bidirectional point-to-point (BiDi PtP) specifications to the ITU-T G.9806 style is described below.

In the ITU-T G.9806 specification scheme, the specified Rx sensitivity is based on the worst compliant transmitter at back-to-back. Note that the ITU related terminologies used in this appendix only apply to ITU-T G.9806.

$$- \quad ITU_TxPower - (PathLoss + PathPenalty) = ITU_RxSensitivity \quad (II.1)$$

PathLoss is the link budget and *PathPenalty* is the OPP (optical path penalty). The sum of the two is the transceiver power budget.

In the IEEE 802.3 BiDi PtP specification scheme, the Rx sensitivity is measured with a reference transmitter (which is close to an ideal Tx signal). Note that the IEEE related terminologies used in this appendix only apply to IEEE 802.3 BiDi PtP specifications.

$$- \quad (IEEE_TxPower - TxPenalty - PathPenalty) - PathLoss = IEEE_RxSensitivity \quad (II.2)$$

The IEEE 802.3 BiDi PtP specifies the *Tx&DispersionPenalty (TDP)* that includes both *TxPenalty* and *PathPenalty* due to dispersion in the transmission fibre.

$$- \quad TxPenalty + PathPenalty = Tx\&DispersionPenalty (TDP) \quad (II.3)$$

The Rx sensitivity in the two standards are related by Eq. (II.4):

$$- \quad ITU_RxSensitivity = IEEE_RxSensitivity + TxPenalty \quad (II.4)$$

The steps of the translation are as follows:

- 1) Start with *IEEE_RxSensitivity* in OMA.
- 2) Add *TxPenalty* to get *ITU_RxSensitivity* in OMA according to Eq. (II.4).
- 3) Calculate *ITU_RxSensitivity* in average power (AVP) based on nominal ER.
- 4) Calculate *ITU_TxPower MIN* according to Eq. (II.1).
- 5) Confirm the *ITU_TxPower MAX* is the same as the *IEEE_TxPower in AVP (max)*.
- 6) Confirm the *ITU_TxPower MIN* guarantees a good Tx dynamic range (3 dB is preferred).

As an aside:

- a) For 10 Gbit/s and 25 Gbit/s, the value of *TxPenalty* is obtained from vendors' survey. *PathPenalty* (OPP) is then calculated using Eq. (II.3).

- b) Nominal ER is the minimum ER plus 1.5 dB.
- c) Receiver overload is the same value as the Max Tx launch power in AVP.
- d) Damage threshold is the overload power plus 1 dB margin.

Appendix III

Methodology for translating the [IEEE 802.3] BiDi PtP specifications to ITU-T G.9806 specifications for 50 Gbit/s

(This appendix does not form an integral part of this Recommendation.)

In the IEEE PAM4 specification, two parameters are introduced.

1. TECQ specifies the back-to-back (without fibre) TDECQ, which is equivalent to the Tx penalty (TP) in the IEEE terminology. Both TECQ max and TDECQ max are 3.2 dB.
2. [TDECQ – TECQ] specifies the optical path dispersion penalty, which is equivalent to the OPP in the ITU-T terminology. [TDECQ – TECQ] max is 2.5 dB and is informative in the [IEEE 802.3] BiDi PtP specification.

The Tx OMA and Rx OMA specifications are dependent on the value of TDECQ and TECQ, respectively. In this appendix, all OMA considered are meant to be the PAM4 outer levels, which is denoted as OMA_{outer} in the [IEEE 802.3] specification.

When TDECQ (or TECQ) is lower than 1.4 dB, the Tx (or Rx) OMA (min) is a fixed value. When TDECQ (or TECQ) is between 1.4 dB and 3.2 dB, the Tx (or Rx) OMA (min) follows this formula: $-1+TDECQ$ ($-15.9+TECQ$).

The steps to translate the [IEEE 802.3] BiDi PtP Tx and Rx specification to the ITU-T G.9806 specifications are described below:-

G.9806 Class S

Figure III.1 illustrates the steps to derive the 50 Gbit/s specification for G.9806 Class S.

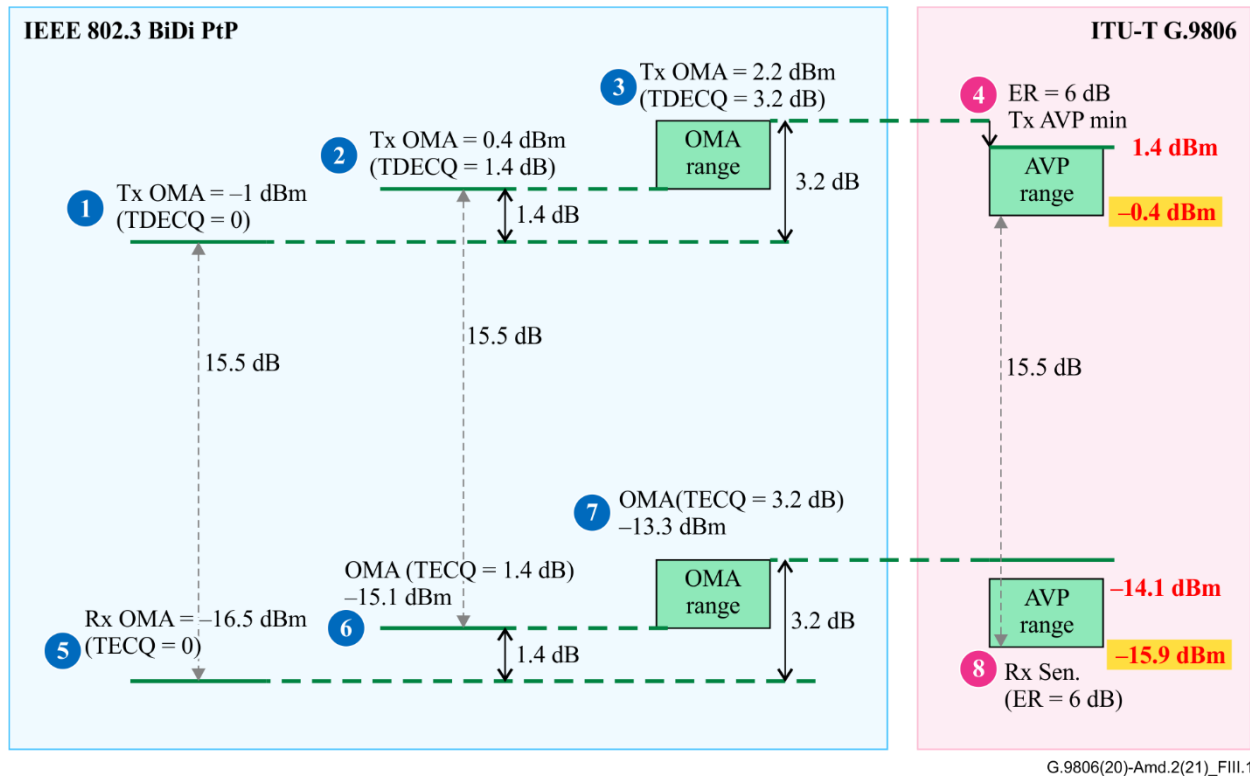

Figure III.1 – Link budget analysis for 50 Gbit/s PMD 20 km ([IEEE 802.3] BiDi PtP BR-20 and ITU-T G.9806 Class S)

On the transmit side of the [IEEE 802.3] BiDi PtP BR-20:

1. Start with an ideal Tx (TDECQ = 0 dB) with an output OMA of -1 dBm
2. The Tx OMA min is +0.4 dBm when TDECQ is in the range of (0 dB, 1.4 dB)
3. Tx OMA max is 2.2 dBm when TDECQ is at the max (3.2 dB)
4. Using the min ER value of 6 dB, the Tx average power (AVP) can be obtained: (-0.4 dBm, 1.4 dBm).

Continuing the investigation for the receive side:

1. Start with an ideal Tx (TECQ = 0 dB), the Rx OMA required sensitivity is -16.5 dBm
2. As TECQ specification is the same as TDECQ, which means when TECQ is in the range of (0 dB, 1.4 dB), the Rx OMA required sensitivity remains a fixed value of -15.1 dBm
3. The worst case Rx OMA sensitivity could be -13.3 dBm when TECQ is at its maximum (3.2 dB)
4. Using the ER of 6 dB (min ER of the testing Tx), the Rx sensitivity AVP range can be obtained: (-15.9 dBm, -14.4 dBm).

The above analysis means the following power budget specification:

Power Budget

$$\text{= Tx min} - \text{Rx sens.} = -0.4 - (-15.9) = 15.5 \text{ dB}$$

$$\text{= Link budget for Class S (15 dB) + MPI (0.5 dB)}$$

G.9806 Class B-

For G.9806 Class B-, there is no equivalent [IEEE 802.3] BiDi PtP specification to be based upon. Therefore, the Class S analysis is used as the baseline. The same Rx sensitivity value is kept for Class S and Class B-, as we have done for 10 Gbit/s and 25 Gbit/s. The Tx min is obtained by adding 8 dB to the Tx min value of Class S (see step 1 in Figure III.2) to satisfy the link budget requirement (23 dB +0.5 dB MPI margin) for Class B-.

The Tx max is then 12.4 dBm to allow for a 3 dB dynamic range, the same as in the case for Class S.

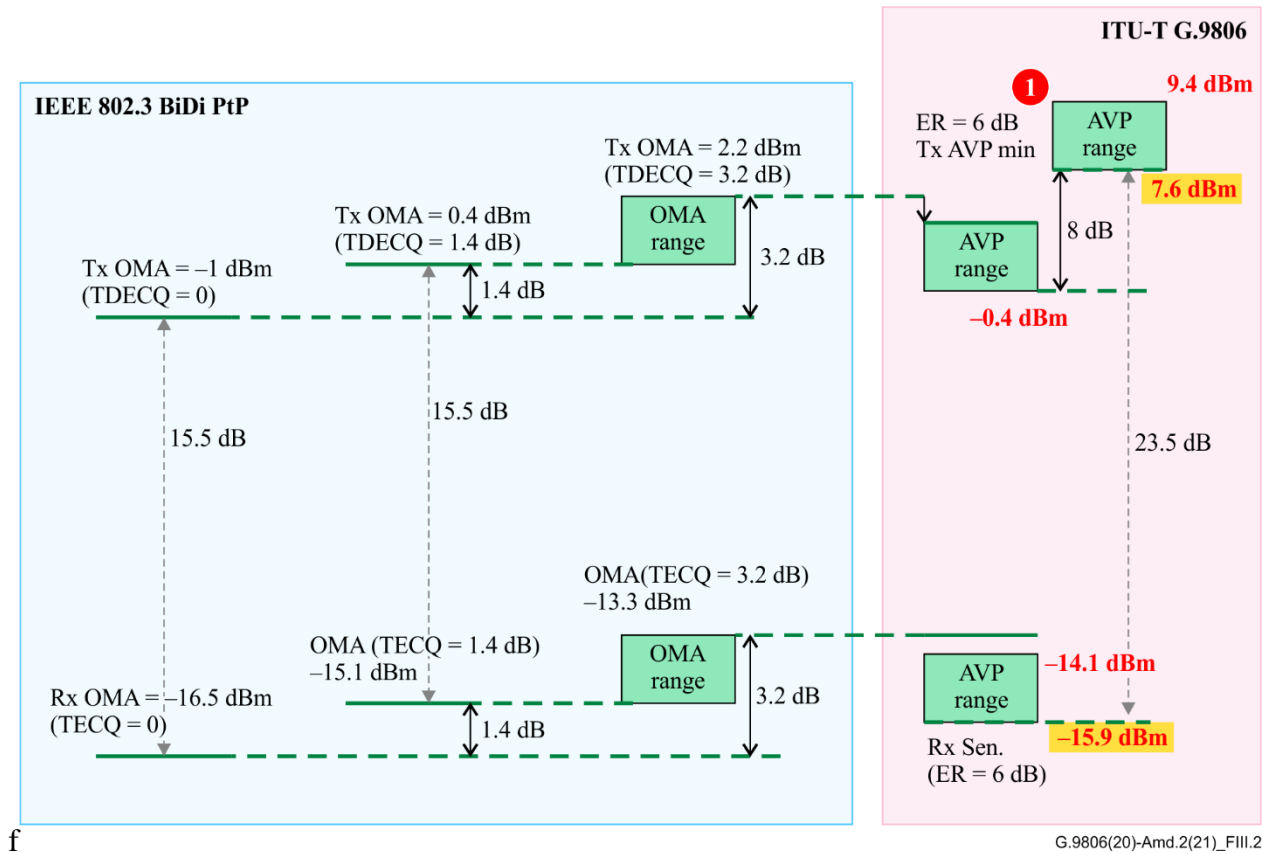

Figure III.2 – Link budget analysis for 50 Gbit/s PMD 40+km (G.9806 Class B-)

Bibliography

- [\[b-ITU-T G.955\]](#) [Recommendation ITU-T G.955 \(1996\), *Digital line systems based on the 1544 kbit/s and the 2048 kbit/s hierarchy on optical fibre cables.*](#)
- [b-IEEE 802.3az] IEEE Standard 802.3az (2010), IEEE Standard for *Information technology – Telecommunications and information exchange between systems – Local and metropolitan area networks – Specific requirements Part 3: Carrier Sense Multiple Access with Collision Detection (CSMA/CD) Access Method and Physical Layer Specifications Amendment 5: Media Access Control Parameters, Physical Layers, and Management Parameters for Energy-Efficient Ethernet.*

SERIES OF ITU-T RECOMMENDATIONS

Series A	Organization of the work of ITU-T
Series D	Tariff and accounting principles and international telecommunication/ICT economic and policy issues
Series E	Overall network operation, telephone service, service operation and human factors
Series F	Non-telephone telecommunication services
Series G	Transmission systems and media, digital systems and networks
Series H	Audiovisual and multimedia systems
Series I	Integrated services digital network
Series J	Cable networks and transmission of television, sound programme and other multimedia signals
Series K	Protection against interference
Series L	Environment and ICTs, climate change, e-waste, energy efficiency; construction, installation and protection of cables and other elements of outside plant
Series M	Telecommunication management, including TMN and network maintenance
Series N	Maintenance: international sound programme and television transmission circuits
Series O	Specifications of measuring equipment
Series P	Telephone transmission quality, telephone installations, local line networks
Series Q	Switching and signalling, and associated measurements and tests
Series R	Telegraph transmission
Series S	Telegraph services terminal equipment
Series T	Terminals for telematic services
Series U	Telegraph switching
Series V	Data communication over the telephone network
Series X	Data networks, open system communications and security
Series Y	Global information infrastructure, Internet protocol aspects, next-generation networks, Internet of Things and smart cities
Series Z	Languages and general software aspects for telecommunication systems