

International Telecommunication Union

ITU-T

TELECOMMUNICATION
STANDARDIZATION SECTOR
OF ITU

G.984.1
Amendment 2
(04/2012)

SERIES G: TRANSMISSION SYSTEMS AND MEDIA,
DIGITAL SYSTEMS AND NETWORKS

Digital sections and digital line system – Optical line
systems for local and access networks

Gigabit-capable passive optical networks (GPON):
General characteristics

Amendment 2

Recommendation ITU-T G.984.1 (2008) –
Amendment 2



ITU-T G-SERIES RECOMMENDATIONS

TRANSMISSION SYSTEMS AND MEDIA, DIGITAL SYSTEMS AND NETWORKS

INTERNATIONAL TELEPHONE CONNECTIONS AND CIRCUITS	G.100–G.199
GENERAL CHARACTERISTICS COMMON TO ALL ANALOGUE CARRIER-TRANSMISSION SYSTEMS	G.200–G.299
INDIVIDUAL CHARACTERISTICS OF INTERNATIONAL CARRIER TELEPHONE SYSTEMS ON METALLIC LINES	G.300–G.399
GENERAL CHARACTERISTICS OF INTERNATIONAL CARRIER TELEPHONE SYSTEMS ON RADIO-RELAY OR SATELLITE LINKS AND INTERCONNECTION WITH METALLIC LINES	G.400–G.449
COORDINATION OF RADIOTELEPHONY AND LINE TELEPHONY	G.450–G.499
TRANSMISSION MEDIA AND OPTICAL SYSTEMS CHARACTERISTICS	G.600–G.699
DIGITAL TERMINAL EQUIPMENTS	G.700–G.799
DIGITAL NETWORKS	G.800–G.899
DIGITAL SECTIONS AND DIGITAL LINE SYSTEM	G.900–G.999
General	G.900–G.909
Parameters for optical fibre cable systems	G.910–G.919
Digital sections at hierarchical bit rates based on a bit rate of 2048 kbit/s	G.920–G.929
Digital line transmission systems on cable at non-hierarchical bit rates	G.930–G.939
Digital line systems provided by FDM transmission bearers	G.940–G.949
Digital line systems	G.950–G.959
Digital section and digital transmission systems for customer access to ISDN	G.960–G.969
Optical fibre submarine cable systems	G.970–G.979
Optical line systems for local and access networks	G.980–G.989
Access networks	G.990–G.999
MULTIMEDIA QUALITY OF SERVICE AND PERFORMANCE – GENERIC AND USER-RELATED ASPECTS	G.1000–G.1999
TRANSMISSION MEDIA CHARACTERISTICS	G.6000–G.6999
DATA OVER TRANSPORT – GENERIC ASPECTS	G.7000–G.7999
PACKET OVER TRANSPORT ASPECTS	G.8000–G.8999
ACCESS NETWORKS	G.9000–G.9999

For further details, please refer to the list of ITU-T Recommendations.

Recommendation ITU-T G.984.1

Gigabit-capable passive optical networks (GPON): General characteristics

Amendment 2

Summary

Amendment 2 to Recommendation ITU-T G.984.1 (2008) includes:

- 1) text describing operation of GPON with IEEE 1588;
- 2) use cases for GPON frequency and time of day synchronization; and
- 3) Transport of ESMC SSM over PON.

History

Edition	Recommendation	Approval	Study Group
1.0	ITU-T G.984.1	2003-03-16	15
2.0	ITU-T G.984.1	2008-03-29	15
2.1	ITU-T G.984.1 (2008) Amd.1	2009-10-09	15
2.2	ITU-T G.984.1 (2008) Amd.2	2012-04-22	15

FOREWORD

The International Telecommunication Union (ITU) is the United Nations specialized agency in the field of telecommunications, information and communication technologies (ICTs). The ITU Telecommunication Standardization Sector (ITU-T) is a permanent organ of ITU. ITU-T is responsible for studying technical, operating and tariff questions and issuing Recommendations on them with a view to standardizing telecommunications on a worldwide basis.

The World Telecommunication Standardization Assembly (WTSA), which meets every four years, establishes the topics for study by the ITU-T study groups which, in turn, produce Recommendations on these topics.

The approval of ITU-T Recommendations is covered by the procedure laid down in WTSA Resolution 1.

In some areas of information technology which fall within ITU-T's purview, the necessary standards are prepared on a collaborative basis with ISO and IEC.

NOTE

In this Recommendation, the expression "Administration" is used for conciseness to indicate both a telecommunication administration and a recognized operating agency.

Compliance with this Recommendation is voluntary. However, the Recommendation may contain certain mandatory provisions (to ensure, e.g., interoperability or applicability) and compliance with the Recommendation is achieved when all of these mandatory provisions are met. The words "shall" or some other obligatory language such as "must" and the negative equivalents are used to express requirements. The use of such words does not suggest that compliance with the Recommendation is required of any party.

INTELLECTUAL PROPERTY RIGHTS

ITU draws attention to the possibility that the practice or implementation of this Recommendation may involve the use of a claimed Intellectual Property Right. ITU takes no position concerning the evidence, validity or applicability of claimed Intellectual Property Rights, whether asserted by ITU members or others outside of the Recommendation development process.

As of the date of approval of this Recommendation, ITU had received notice of intellectual property, protected by patents, which may be required to implement this Recommendation. However, implementers are cautioned that this may not represent the latest information and are therefore strongly urged to consult the TSB patent database at <http://www.itu.int/ITU-T/ipr/>.

© ITU 2012

All rights reserved. No part of this publication may be reproduced, by any means whatsoever, without the prior written permission of ITU.

Table of Contents

	Page
1 Scope	1
2 Changes to clause 4 "Abbreviations and acronyms"	1
3 Appendices IV, V and VI	1
Appendix IV – Operation with IEEE 1588	1
Appendix V – Use cases for frequency and time of day synchronization	2
Appendix VI – Transport of ESMC messages over PON.....	6
4 Add the following to the bibliography.....	7

Recommendation ITU-T G.984.1

Gigabit-capable passive optical networks (GPON): General characteristics

Amendment 2

1 Scope

This amendment to Recommendation ITU-T G.984.1 includes text describing the operation of GPON with IEEE 1588; use cases for GPON frequency and time of day synchronization; and the transport of ESMC messages over PON.

2 Changes to clause 4 "Abbreviations and acronyms"

Add the following abbreviations to the list in clause 4:

ESMC Ethernet Synchronization Messaging Channel

OSSP Organizational Specific Slow Protocol

PRC Primary Reference Clock

PTP Precision Timing Protocol

RNC Radio Network Controller

ToD Time of Day

3 Appendices IV, V and VI

Add Appendices IV, V and VI as follows:

Appendix IV

Operation with IEEE 1588

(This appendix does not form an integral part of this Recommendation.)

IEEE 1588 describes a protocol for transferring time and/or frequency through a packet network. The protocol is explained in [b-1588 Tutorial].

G-PON distributes the IEEE 1588 master and slave functionality between the OLT and the ONU. The OLT will perform the slave port function (or in the case of a shelf, the OLT will receive the frequency and time from the function in the shelf which performs the slave port function). The OLT synchronizes the PON line rate to the network clock frequency and transfers the time of day information to the ONU using the method in Amendment 2 to [ITU-T G.984.3], clause 10.4.6. The ONU uses the methods specified in [ITU-T G.984.2] to recover frequency and [ITU-T G.984.3] to recover time. The ONU will then either function as a master port to subsequent nodes or output the time and frequency through another interface.

Appendix V

Use cases for frequency and time of day synchronization

(This appendix does not form an integral part of this Recommendation.)

There are many applications where precise time and/or frequency must be transferred through a packet network from a source to a destination. In this appendix several use cases are described in terms of the methods used to deliver frequency and/or time. Since most of the use cases mentioned are related to mobile backhauling applications, examples will use the RNC and NodeB network elements, though these use cases are not intended to be exhaustive.

Frequency and/or time of day synchronization is provided to the OLT via either:

- 1) a physical timing interface (e.g., synchronous Ethernet) (frequency only)
- 2) IEEE 1588 + synchronous Ethernet
- 3) IEEE 1588 + non-synchronous Ethernet
- 4) Physical ToD interface + synchronous Ethernet.

Frequency and/or time of day (ToD) synchronization is supplied from the ONU via either:

- 1) a physical timing interface (e.g., synchronous Ethernet) (frequency only)
- 2) IEEE 1588 + synchronous Ethernet
- 3) IEEE 1588 + non-synchronous Ethernet
- 4) a physical ToD interface + synchronous Ethernet.

The use cases are described in terms of various combinations of these synchronization inputs and outputs as shown in Table V.1.

Table V.1 – G-PON synchronization use

Use case	Network synchronization to OLT	UNI synchronization from ONU
1	SyncE (frequency only)	SyncE (frequency only)
2	IEEE 1588 and SyncE	IEEE 1588 and SyncE
3	IEEE 1588	IEEE 1588
4	IEEE 1588	IEEE 1588 and SyncE
5	IEEE 1588 and SyncE	ToD interface and SyncE
6	IEEE 1588	ToD interface and SyncE
7	ToD interface and SyncE	ToD interface and SyncE

Figure V.1 depicts use case 1 where frequency only is transferred through the G-PON network. The clock interface at the OLT input and the ONU output is a physical timing interface such as synchronous Ethernet (SyncE), defined in [b-ITU-T G.8262]. The OLT synchronizes the PON line rate to this physical interface. The ONU outputs a physical timing interface such as synchronous Ethernet which is synchronous to the PON line rate.

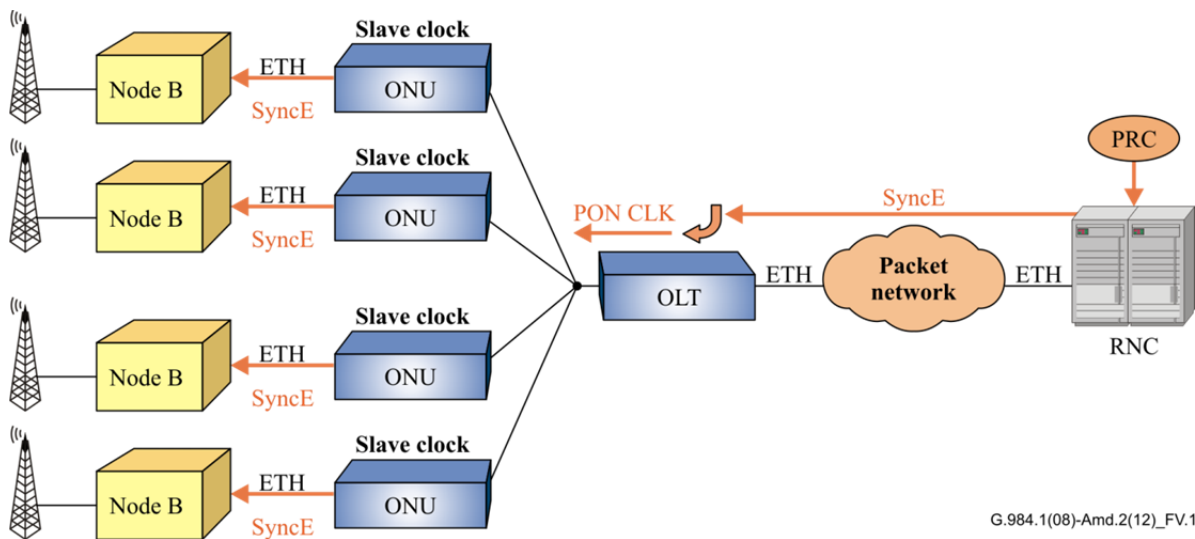

Figure V.1 – Using synchronous Ethernet in G-PON (use case 1)

There are several use cases of interest which use IEEE 1588 (use cases 2 to 6), with the following assumptions. The PRC provides a frequency reference. The OLT network interface is Ethernet, with the Ethernet line rate either synchronous to a network frequency reference (synchronous Ethernet) or not synchronous to a network frequency reference. The OLT obtains time of day using IEEE 1588, usually through intervening nodes between the OLT and the PRC. The OLT synchronizes to the network frequency reference either using synchronous Ethernet, IEEE 1588, or some other physical layer synchronous interface. The OLT transfers the time of day to the ONU using the method specified in clause 10.4.6 of Amendment 2 to [ITU-T G.984.3]. The OLT transfers the network frequency reference to the ONU via its downstream line rate, which is synchronous to the network frequency reference. The ONU user interface is Ethernet, with the Ethernet line rate either synchronous to a network frequency reference (synchronous Ethernet) or not synchronous to a network frequency reference. The ONU may also have a physical time interface (e.g., 1 pps).

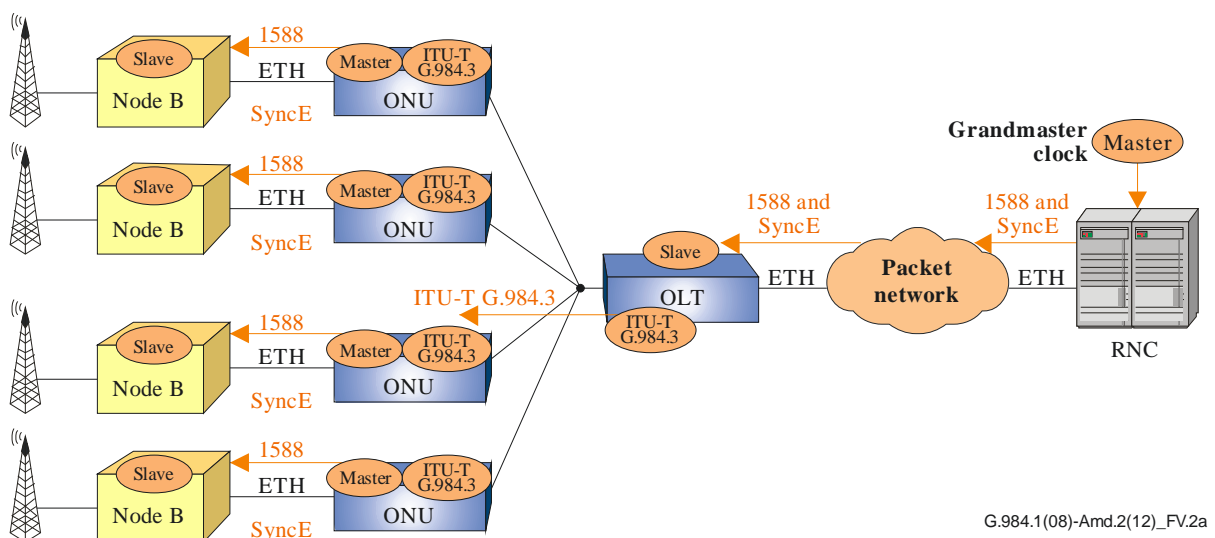

Figure V.2a – PTP use case 2: ONU as IEEE 1588 master, OLT as IEEE 1588 slave, with SyncE at both SNI and UNI

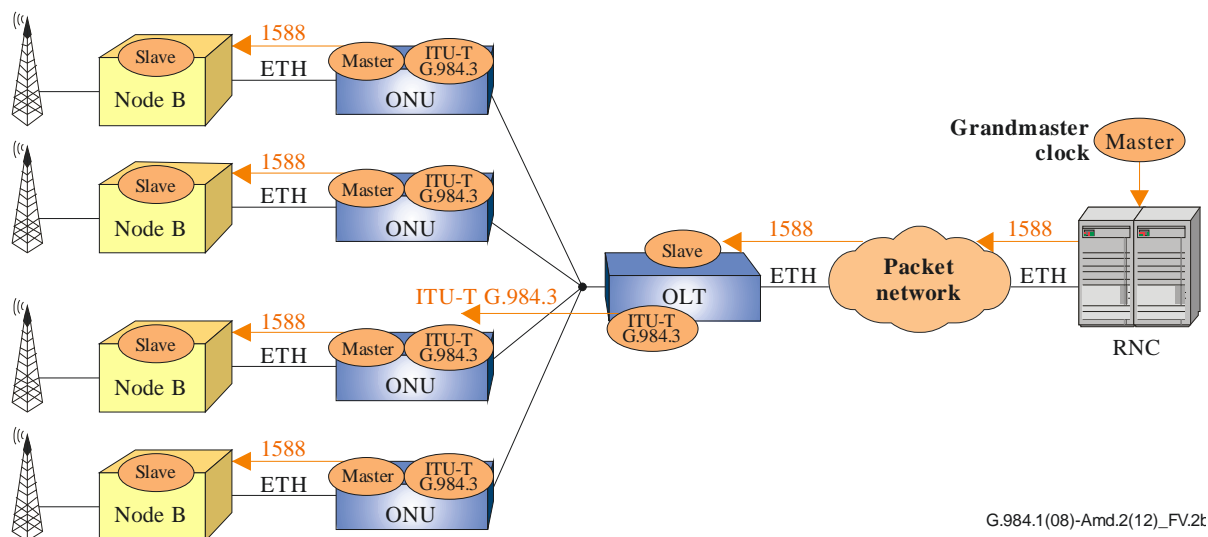

Figure V.2b – PTP use case 3: ONU as IEEE 1588 master, OLT as IEEE 1588 slave, without SyncE

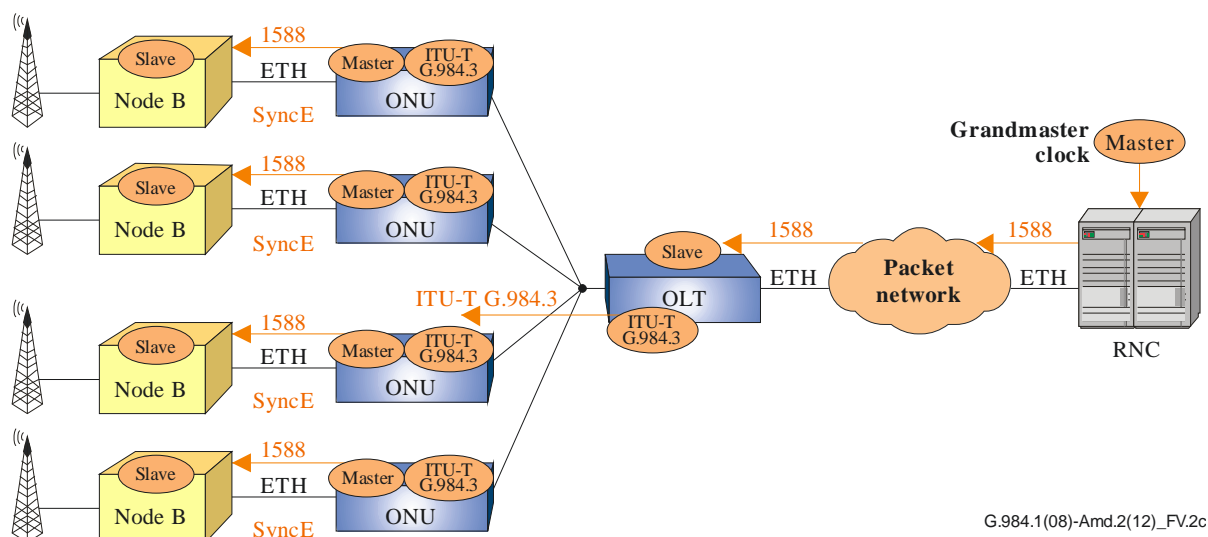

Figure V.2c – PTP use case 4: ONU as IEEE 1588 master, OLT as IEEE 1588 slave, with SyncE at UNI

Figures V.2a and V.2b show use cases 2 and 3 for wireless backhaul, respectively. The OLT has an IEEE 1588 slave port at the SNI, which obtains the time of day from the network. This time of day is passed to the ONU as described above, and the ONU passes the time of day from an IEEE 1588 master port to node B. If the OLT network feed is synchronous Ethernet (use case 2), then the OLT will synchronize its downstream PON line rate to the synchronous Ethernet line rate; otherwise the OLT will synchronize its downstream PON line rate to the IEEE 1588 time of day (use cases 3). If the link between the ONU and node B is synchronous Ethernet (use cases 2), then the synchronous Ethernet line rate will be synchronized to the downstream PON line rate. Synchronous Ethernet ESMC messages would be used in conjunction with the synchronous Ethernet to indicate clock quality.

Figure V.2c illustrates use case 4 where the OLT does not receive synchronous Ethernet and derives the downstream PON line rate from 1588. In this case the ESMC messages would correspond to the 1588 clock quality and not a clock quality received via ESMC at the OLT.

Figures V.3a and V.3b show use cases 5 and 6 for wireless backhaul, respectively. The only difference between Figure V.2 and Figure V.3 is that the ONU has a physical interface for transferring time to node B, such as a ToD interface. If the OLT network feed is synchronous Ethernet (use case 5), then the OLT will synchronize its downstream PON line rate to the synchronous Ethernet line rate; otherwise the OLT will synchronize its downstream PON line rate to the IEEE 1588 time of day (use cases 6).

NOTE – The details of the physical ToD interface are FFS.

Figure V.4 shows use case 7, where a physical ToD interface is provided as an input to the OLT. The OLT processes the ToD information and sends timing information to the ONU according to the description provided in clause 10.4.6 of Amendment 2 to [ITU-T G.984.3]. The ONU processes the received timing information and outputs the timing information using a physical ToD interface.

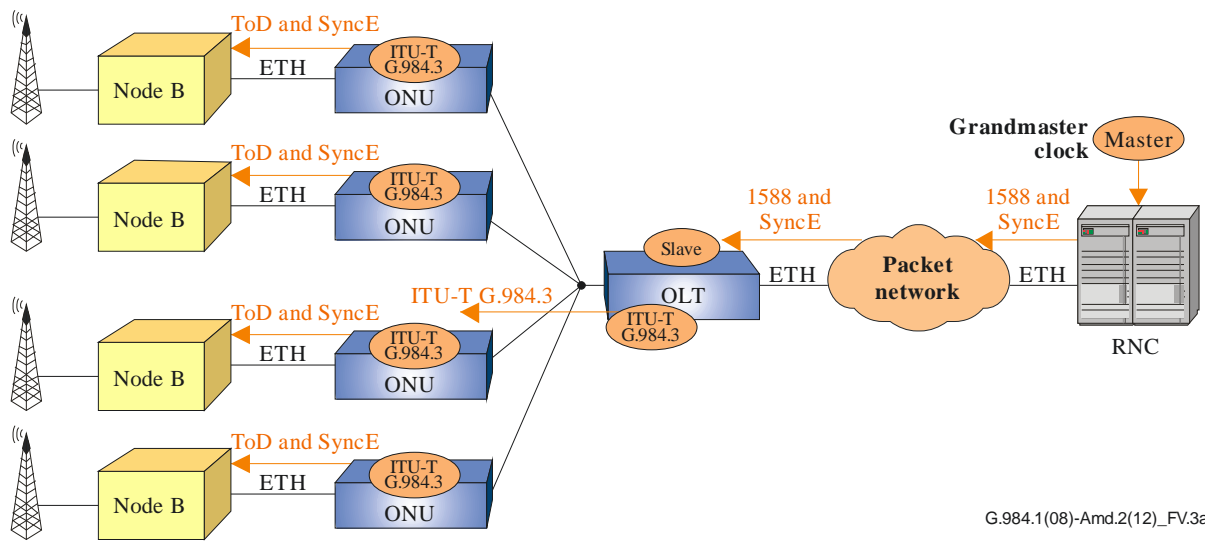

G.984.1(08)-Amd.2(12)_FV.3e

Figure V.3a – PTP use case 5: ONU with a physical time interface, OLT as IEEE 1588 slave, with SyncE at both SNI and UNI

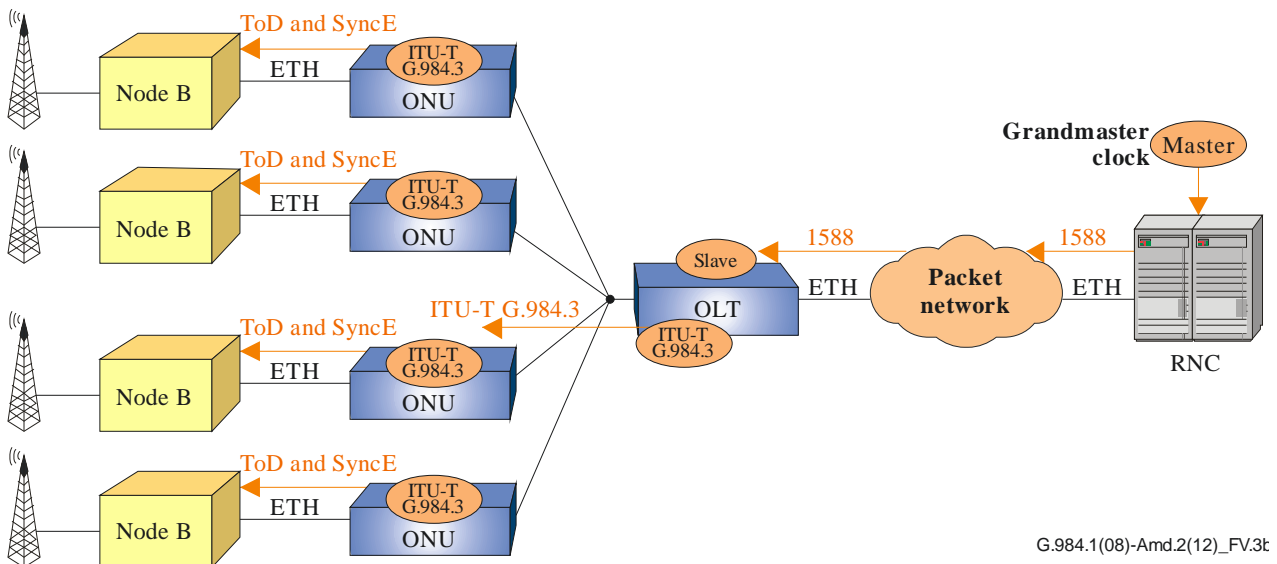

G.984.1(08)-Amd.2(12)_FV.3f

Figure V.3b – PTP use case 6: ONU with a physical time interface, OLT as IEEE 1588 slave, with SyncE at UNI

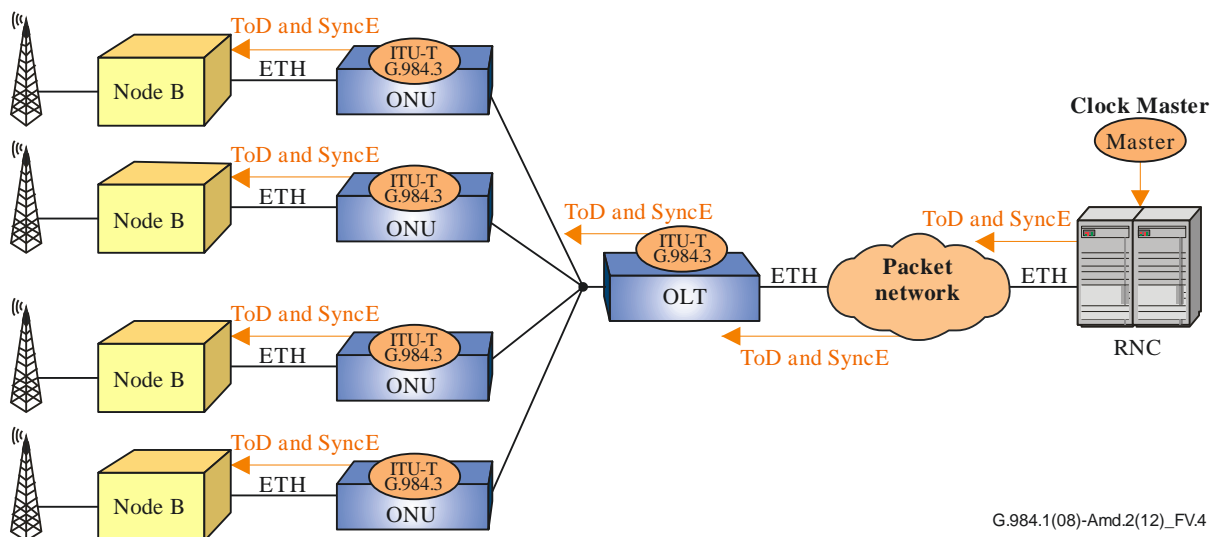

G.984.1(08)-Amd.2(12)_FV.4

Figure V.4 – Use case 7, ONU and OLT with a physical time interface

Appendix VI

Transport of ESMC messages over PON

(This appendix does not form an integral part of this Recommendation.)

In Appendix V, the use case of synchronous Ethernet over the PON was described and the ESMC was introduced. This appendix addresses frequency synchronization over G-PON but focuses on a recommended method to transfer the SSM carried in the ESMC (as defined in [b-ITU-T G.8264]) that are used to send the synchronous Ethernet clock quality in a one-way fashion from the clock master to a base station or other end device. Refer to Figure V.1 in Appendix V, "Using synchronous Ethernet in G-PON" for this appendix.

Within the physical layer, synchronous Ethernet is transferred over the OLT/ODN/ONU in the following way. A synchronous Ethernet-capable OLT will lock the G-PON clock to the received Ethernet clock at the OLT SNI, and a synchronous Ethernet-capable ONU will in turn lock the Ethernet clock of one or more provisioned Ethernet port UNIs ([b-ITU-T G.8262] defines the types of UNIs capable of synchronous Ethernet) to the G-PON clock.

Characteristics of the ESMC:

- Simple, stateless unidirectional protocol for communicating the current reference clock quality between nodes.
- Uses the IEEE 802.3 organization specific slow protocol (OSSP).
- Destination address is the IEEE defined slow protocol multicast address.
- One message type, the synchronization status message.
- Sent at approximately one message per second containing the clock quality level (QL).

ESMC messages over G-PON

ESMC messaging must be handled by the OLT/ONU as a system.

The main difference in how a PON must handle ESMC messages versus an Ethernet switch is that the OLT to ONU link is not a point-to-point Ethernet link but rather uses the G-PON point to multipoint protocol, with the ESMC messages sent via GEM encapsulation. While different in this respect, in all functional aspects the OLT and the ONU may handle ESMC messages largely as defined in [b-ITU-T G.8264].

Method for sending synchronization status messages over G-PON

An OLT that is synchronous Ethernet-capable should provisionally process and act upon ESMC messages that are received on synchronous Ethernet provisioned SNI ports.

If there are multiple provisioned synchronous Ethernet-capable ports then the OLT should synchronize to and obtain the clock quality (QL value) from the best port using the synchronization selection methods defined in [b-ITU-T G.8264] and [b-ITU-T G.781].

The OLT should then send OSSP ESMC messages of equal clock quality. The OLT should not send ESMC messages unless it has been provisioned to do so.

ONUs may be provisioned to recognize ESMC through the normal process of configuring an incidental broadcast GEM port, the appropriate VLAN, and a bridge to the desired Ethernet UNIs. After intercept, the ONU will have obtained the clock quality which will be equal to that of the ESMC received at the OLT. The ONU should then send ESMC messages that are compliant to [b-ITU-T G.8264], only from UNIs that are members of the ESMC VLAN bridge.

4 Add the following to the bibliography

- [b-ITU-T G.781] Recommendation ITU-T G.781 (in force), *Synchronization layer functions*.
- [b-ITU-T G.8264] Recommendation ITU-T G.8264 (in force), *Distribution of timing information through packet networks*.
- [b-IEEE 1588] IEEE 1588-2008, *IEEE Standard for a Precision Clock Synchronization Protocol for Networked Measurement and Control Systems*.
- [b-1588 Tutorial] Garner, G. (2008), *Tutorial on IEEE 1588 Version 2*, International IEEE Symposium on Precision Clock Synchronization for Measurement, Control and Communication, IEEE 802 LAN/MAN Standards Committee.
<<http://www.ieee802.org/1/files/public/docs2008/as-garner-1588v2-summary-0908.pdf>- 3538.2KB - [IEEE SA](#)>

SERIES OF ITU-T RECOMMENDATIONS

Series A	Organization of the work of ITU-T
Series D	General tariff principles
Series E	Overall network operation, telephone service, service operation and human factors
Series F	Non-telephone telecommunication services
Series G	Transmission systems and media, digital systems and networks
Series H	Audiovisual and multimedia systems
Series I	Integrated services digital network
Series J	Cable networks and transmission of television, sound programme and other multimedia signals
Series K	Protection against interference
Series L	Construction, installation and protection of cables and other elements of outside plant
Series M	Telecommunication management, including TMN and network maintenance
Series N	Maintenance: international sound programme and television transmission circuits
Series O	Specifications of measuring equipment
Series P	Terminals and subjective and objective assessment methods
Series Q	Switching and signalling
Series R	Telegraph transmission
Series S	Telegraph services terminal equipment
Series T	Terminals for telematic services
Series U	Telegraph switching
Series V	Data communication over the telephone network
Series X	Data networks, open system communications and security
Series Y	Global information infrastructure, Internet protocol aspects and next-generation networks
Series Z	Languages and general software aspects for telecommunication systems