

ITU-T

TELECOMMUNICATION
STANDARDIZATION SECTOR
OF ITU

G.988

Amendment 5

(06/2022)

SERIES G: TRANSMISSION SYSTEMS AND MEDIA,
DIGITAL SYSTEMS AND NETWORKS

Digital sections and digital line system – Optical line
systems for local and access networks

ONU management and control interface (OMCI)
specification

Amendment 5

Recommendation ITU-T G.988 (2017) – Amendment 5

ITU-T G-SERIES RECOMMENDATIONS
TRANSMISSION SYSTEMS AND MEDIA, DIGITAL SYSTEMS AND NETWORKS

INTERNATIONAL TELEPHONE CONNECTIONS AND CIRCUITS	G.100–G.199
GENERAL CHARACTERISTICS COMMON TO ALL ANALOGUE CARRIER-TRANSMISSION SYSTEMS	G.200–G.299
INDIVIDUAL CHARACTERISTICS OF INTERNATIONAL CARRIER TELEPHONE SYSTEMS ON METALLIC LINES	G.300–G.399
GENERAL CHARACTERISTICS OF INTERNATIONAL CARRIER TELEPHONE SYSTEMS ON RADIO-RELAY OR SATELLITE LINKS AND INTERCONNECTION WITH METALLIC LINES	G.400–G.449
COORDINATION OF RADIOTELEPHONY AND LINE TELEPHONY	G.450–G.499
TRANSMISSION MEDIA AND OPTICAL SYSTEMS CHARACTERISTICS	G.600–G.699
DIGITAL TERMINAL EQUIPMENTS	G.700–G.799
DIGITAL NETWORKS	G.800–G.899
DIGITAL SECTIONS AND DIGITAL LINE SYSTEM	G.900–G.999
General	G.900–G.909
Parameters for optical fibre cable systems	G.910–G.919
Digital sections at hierarchical bit rates based on a bit rate of 2048 kbit/s	G.920–G.929
Digital line transmission systems on cable at non-hierarchical bit rates	G.930–G.939
Digital line systems provided by FDM transmission bearers	G.940–G.949
Digital line systems	G.950–G.959
Digital section and digital transmission systems for customer access to ISDN	G.960–G.969
Optical fibre submarine cable systems	G.970–G.979
Optical line systems for local and access networks	G.980–G.989
Metallic access networks	G.990–G.999
MULTIMEDIA QUALITY OF SERVICE AND PERFORMANCE – GENERIC AND USER-RELATED ASPECTS	G.1000–G.1999
TRANSMISSION MEDIA CHARACTERISTICS	G.6000–G.6999
DATA OVER TRANSPORT – GENERIC ASPECTS	G.7000–G.7999
PACKET OVER TRANSPORT ASPECTS	G.8000–G.8999
ACCESS NETWORKS	G.9000–G.9999

For further details, please refer to the list of ITU-T Recommendations.

Recommendation ITU-T G.988

ONU management and control interface (OMCI) specification

Amendment 5

Summary

Recommendation ITU-T G.988 specifies the optical network unit (ONU) management and control interface (OMCI) for optical access networks.

Recommendation ITU-T G.988 specifies the managed entities (MEs) of a protocol-independent management information base (MIB) that models the exchange of information between an optical line termination (OLT) and an ONU. In addition, it covers the ONU management and control channel, protocol and detailed messages.

Amendment 1 contains various updates to ITU-T G.988 (2017). This amendment contains editorial corrections and clarifications along with the following substantive changes and extensions to PON OMCI related to bonded ONUs, filtering on DHCP for admission control purposes, synchronization alarm support, ONU timezone offset and ONU manufacturing data.

Amendment 2 adds support for DC voltage-based visual message indicators in ITU-T G.988 voice over IP (VOIP) application service profile ME.

Amendment 3 makes editorial changes on extended virtual local area network (VLAN) and adds:

- Support for the discovery of Extended VLAN tagging operation configuration data ME enhanced mode through the ONU3-G ME.
- Support for Extended VLAN ME tagging operation configuration data ME enhanced mode.
- Corrections to Table 9.1.5-1 "Plug-in unit types".

Amendment 4 makes editorial changes to TWDM channel tuning performance history data part 1, TWDM channel managed entity and clause 9.2.21. Amendment 4 also adds:

- Support of RFC 2543 call hold (with connection address 0.0.0.0).
- Support of dial plan alarms.
- Support of DHCP performance monitoring.
- Support of ONU operational performance monitoring.
- Supports additional VCD voice alarms.
- Adds clarifications to FEC seconds definition.

This amendment adds:

- Support of High Speed PON (HSP).
- Support of User Services Platform (USP).

History

Edition	Recommendation	Approval	Study Group	Unique ID*
1.0	ITU-T G.988	2010-10-07	15	11.1002/1000/10891
1.1	ITU-T G.988 (2010) Amd. 1	2011-04-13	15	11.1002/1000/11126
1.2	ITU-T G.988 (2010) Amd. 2	2012-04-22	15	11.1002/1000/11501
1.3	ITU-T G.988 (2010) Cor. 1	2012-06-13	15	11.1002/1000/11641
2.0	ITU-T G.988	2012-10-29	15	11.1002/1000/11784
2.1	ITU-T G.988 (2012) Amd. 1	2014-05-14	15	11.1002/1000/12185
2.2	ITU-T G.988 (2012) Amd. 2	2016-06-22	15	11.1002/1000/12795
3.0	ITU-T G.988	2017-11-06	15	11.1002/1000/13291
3.1	ITU-T G.988 (2017) Amd. 1	2018-11-29	15	11.1002/1000/13744
3.2	ITU-T G.988 (2017) Amd. 2	2019-08-29	15	11.1002/1000/14001
3.3	ITU-T G.988 (2017) Amd. 3	2020-03-15	15	11.1002/1000/14192
3.4	ITU-T G.988 (2017) Amd. 4	2021-09-06	15	11.1002/1000/14623
3.5	ITU-T G.988 (2017) Amd. 5	2022-06-06	15	11.1002/1000/14886

Keywords

E-PON, G-PON, HS-PON, NG-PON2, OMCI, PON, XG-PON, XGS-PON.

* To access the Recommendation, type the URL <http://handle.itu.int/> in the address field of your web browser, followed by the Recommendation's unique ID. For example, <http://handle.itu.int/11.1002/1000/11830-en>.

FOREWORD

The International Telecommunication Union (ITU) is the United Nations specialized agency in the field of telecommunications, information and communication technologies (ICTs). The ITU Telecommunication Standardization Sector (ITU-T) is a permanent organ of ITU. ITU-T is responsible for studying technical, operating and tariff questions and issuing Recommendations on them with a view to standardizing telecommunications on a worldwide basis.

The World Telecommunication Standardization Assembly (WTSA), which meets every four years, establishes the topics for study by the ITU-T study groups which, in turn, produce Recommendations on these topics.

The approval of ITU-T Recommendations is covered by the procedure laid down in WTSA Resolution 1.

In some areas of information technology which fall within ITU-T's purview, the necessary standards are prepared on a collaborative basis with ISO and IEC.

NOTE

In this Recommendation, the expression "Administration" is used for conciseness to indicate both a telecommunication administration and a recognized operating agency.

Compliance with this Recommendation is voluntary. However, the Recommendation may contain certain mandatory provisions (to ensure, e.g., interoperability or applicability) and compliance with the Recommendation is achieved when all of these mandatory provisions are met. The words "shall" or some other obligatory language such as "must" and the negative equivalents are used to express requirements. The use of such words does not suggest that compliance with the Recommendation is required of any party.

INTELLECTUAL PROPERTY RIGHTS

ITU draws attention to the possibility that the practice or implementation of this Recommendation may involve the use of a claimed Intellectual Property Right. ITU takes no position concerning the evidence, validity or applicability of claimed Intellectual Property Rights, whether asserted by ITU members or others outside of the Recommendation development process.

As of the date of approval of this Recommendation, ITU had received notice of intellectual property, protected by patents/software copyrights, which may be required to implement this Recommendation. However, implementers are cautioned that this may not represent the latest information and are therefore strongly urged to consult the appropriate ITU-T databases available via the ITU-T website at <http://www.itu.int/ITU-T/ipr/>.

© ITU 2022

All rights reserved. No part of this publication may be reproduced, by any means whatsoever, without the prior written permission of ITU.

Table of Contents

Page

1	Scope.....	1
2	References.....	1
3	Definitions	6
	3.1 Terms defined elsewhere	6
	3.2 Terms defined in this Recommendation	6
4	Abbreviations and acronyms	6
5	Conventions	15
6	Reference model and terms	15
	6.1 OMCI in the access network	15
	6.2 ONU functions.....	16
	6.3 Support of multicast connection	16
	6.4 Voice over Internet protocol management	16
7	Requirements of the management interface specification	17
	7.1 Configuration management	17
	7.2 Fault management	18
	7.3 Performance management	18
	7.4 Security management	19
8	Protocol-independent MIB for the OMCI	19
	8.1 Managed entities.....	19
	8.2 Managed entity relation diagrams	30
9	MIB description	52
	9.1 Equipment management	56
	9.2 ANI management, traffic management	99
	9.3 Layer 2 data services	136
	9.4 Layer 3 data services	217
	9.5 Ethernet services.....	228
	9.6 This clause is intentionally left blank	240
	9.7 xDSL services.....	240
	9.8 Time division multiplex services.....	347
	9.9 Voice services.....	374
	9.10 Premises networks	409
	9.11 This clause is intentionally left blank	414
	9.12 General purpose managed entities	414
	9.13 Miscellaneous services	436
	9.14 Mid-span passive optical network reach extender.....	453
	9.15 RS232/RS485 interface service	468
	9.16 ITU-T G.989.3 TWDM and ITU-T G.9804.2 TWDM/TDM PON	471

	Page
10 This clause is intentionally left blank	487
11 ONU management and control protocol.....	487
11.1 Baseline and extended messages	487
11.2 Common message characteristics.....	488
Annex A – OMCI message syntax and common features	504
A.1 General	504
A.2 Extended message set.....	513
A.3 Baseline message set	555
Annex B – OMCI in ITU-T PON systems.....	597
B.1 Establishing the ONU management and control channel (OMCC)	597
B.2 OMCI handling within the ONU	598
Annex C – OMCI in Ethernet PON systems	603
C.1 Establishing the ONU management and control channel (OMCC)	603
C.2 Encapsulating OMCI messages in Ethernet frames	604
C.3 Relationship between the OMCI and OAM defined in clause 57 of [IEEE 802.3].....	605
C.4 Adaptation of the G-PON information model to EPON	605
Appendix I – OMCI common services	610
I.1 ONU MIB management	610
I.2 Equipment management	617
I.3 Software upgrade.....	628
I.4 Performance monitoring.....	635
Appendix II – G-PON mechanisms and services.....	641
II.1 Layer 2 data service according to [b-BBF TR-156].....	641
II.2 Dual-managed ONUs	653
II.3 Traffic management.....	655
II.4 Voice services.....	670
II.5 Extended layer 2 data service model	676
Appendix III – <i>This appendix is intentionally left blank</i>	679
Bibliography.....	681

Recommendation ITU-T G.988

ONU management and control interface (OMCI) specification

Amendment 5

Editorial note: This is a complete-text publication. Modifications introduced by this amendment are shown in revision marks relative to Recommendation ITU-T G.988 (2017) plus its Amendments 1, 2, 3 and 4.

1 Scope

This Recommendation specifies the optical network unit (ONU) management and control interface (OMCI) for optical access networks.

The OMCI specification addresses ONU configuration, fault management and performance management for optical access system operation, and for several services including:

- gigabit-capable passive optical network encapsulation method (GEM) adaptation layers;
- Ethernet services, including media access control (MAC) bridged local area networks (LANs);
- circuit emulation service (CES);
- voice services.

This Recommendation defines a protocol necessary to support the capabilities identified for these ONUs. It also allows optional components and future extensions.

Amendment 5 continues the maintenance and evolution of OMCI as defined in Recommendation ITU-T G.988 (2017) as amended.

2 References

The following ITU-T Recommendations and other references contain provisions which, through reference in this text, constitute provisions of this Recommendation. At the time of publication, the editions indicated were valid. All Recommendations and other references are subject to revision; users of this Recommendation are therefore encouraged to investigate the possibility of applying the most recent edition of the Recommendations and other references listed below. A list of the currently valid ITU-T Recommendations is regularly published. The reference to a document within this Recommendation does not give it, as a stand-alone document, the status of a Recommendation.

- | | |
|-----------------|------------------------------------------------------------------------------------------------------------------------------------------------|
| [ITU-T E.164] | Recommendation ITU-T E.164 (2005), <i>The international public telecommunication numbering plan.</i> |
| [ITU-T G.704] | Recommendation ITU-T G.704 (1998), <i>Synchronous frame structures used at 1544, 6312, 2048, 8448 and 44 736 kbit/s hierarchical levels.</i> |
| [ITU-T G.722.1] | Recommendation ITU-T G.722.1 (2005), <i>Low-complexity coding at 24 and 32 kbit/s for hands-free operation in systems with low frame loss.</i> |
| [ITU-T G.722.2] | Recommendation ITU-T G.722.2 (2003), <i>Wideband coding of speech at around 16 kbit/s using Adaptive Multi-Rate Wideband (AMR-WB).</i> |
| [ITU-T G.723.1] | Recommendation ITU-T G.723.1 (2006), <i>Dual rate speech coder for multimedia communications transmitting at 5.3 and 6.3 kbit/s.</i> |
| [ITU-T G.728] | Recommendation ITU-T G.728 (1992), <i>Coding of speech at 16 kbit/s using low-delay code excited linear prediction.</i> |

- [ITU-T G.729] Recommendation ITU-T G.729 (2007), *Coding of speech at 8 kbit/s using conjugate-structure algebraic-code-excited linear prediction (CS-ACELP)*.
- [ITU-T G.784] Recommendation ITU-T G.784 (2008), *Management aspects of synchronous digital hierarchy (SDH) transport network elements*.
- [ITU-T G.826] Recommendation ITU-T G.826 (2002), *End-to-end error performance parameters and objectives for international, constant bit-rate digital paths and connections*.
- [ITU-T G.983.2] Recommendation ITU-T G.983.2 (2005), *ONT management and control interface specification for B-PON*.
- [ITU-T G.984.x] Recommendation ITU-T G.984.x-series, *Gigabit-capable passive optical networks (G-PON)*.
- [ITU-T G.984.3] Recommendation ITU-T G.984.3 (2008), *Gigabit-capable passive optical networks (G-PON): Transmission convergence layer specification*.
- [ITU-T G.984.4] Recommendation ITU-T G.984.4 (2008), *Gigabit-capable passive optical networks (G-PON): ONT management and control interface specification*.
- [ITU-T G.984.6] Recommendation ITU-T G.984.6 (2008), *Gigabit-capable passive optical networks (GPON): Reach extension*.
- [ITU-T G.986] Recommendation ITU-T G.986 (2010), *1 Gbit/s point-to-point Ethernet-based optical access system*.
- [ITU-T G.987.x] ITU-T G.987.x-series of Recommendations, *10 Gigabit-capable passive optical network (XG-PON) systems*.
- [ITU-T G.987] Recommendation ITU-T G.987 (10/2010), *10-Gigabit-capable passive optical network (XG-PON) systems: Definitions, abbreviations, and acronyms*.
- [ITU-T G.987.1] Recommendation ITU-T G.987.1 (2010), *10-Gigabit-capable passive optical networks (XG-PON): General requirements*.
- [ITU-T G.987.3] Recommendation ITU-T G.987.3 (2010), *10-Gigabit-capable passive optical networks (XG-PON): Transmission convergence (TC) layer specification*.
- [ITU-T G.989.3] Recommendation ITU-T G.989.3 (2015), *40-Gigabit-capable passive optical networks (NG-PON2): Transmission convergence layer specification*.
- [ITU-T G.992.x] ITU-T G.992.x series of Recommendations.
- [ITU-T G.992.1] Recommendation ITU-T G.992.1 (1999), *Asymmetric digital subscriber line (ADSL) transceivers*.
- [ITU-T G.992.2] Recommendation ITU-T G.992.2 (1999), *Splitterless asymmetric digital subscriber line (ADSL) transceivers*.
- [ITU-T G.992.3] Recommendation ITU-T G.992.3 (2009), *Asymmetric digital subscriber line transceivers 2 (ADSL2)*.
- [ITU-T G.992.4] Recommendation ITU-T G.992.4 (2002), *Splitterless asymmetric digital subscriber line transceivers 2 (splitterless ADSL2)*.
- [ITU-T G.992.5] Recommendation ITU-T G.992.5 (2009), *Asymmetric digital subscriber line 2 transceivers (ADSL2) – Extended bandwidth ADSL2 (ADSL2plus)*.
- [ITU-T G.993.1] Recommendation ITU-T G.993.1 (2004), *Very high speed digital subscriber line transceivers (VDSL)*.

- [ITU-T G.993.2] Recommendation ITU-T G.993.2 (in force), *Very high speed digital subscriber line transceivers 2 (VDSL2)*.
- [ITU-T G.993.5] Recommendation ITU-T G.993.5 (2010), *Self-FEXT cancellation (vectoring) for use with VDSL2 transceivers*.
- [ITU-T G.994.1] Recommendation ITU-T G.994.1 (in force), *Handshake procedures for digital subscriber line transceivers*.
- [ITU-T G.997.1] Recommendation ITU-T G.997.1 (2012), *Physical layer management for digital subscriber line transceivers*.
- [ITU-T G.997.2] Recommendation ITU-T G.997.2 (2015), *Physical layer management for G.fast transceivers*.
- [ITU-T G.998.4] Recommendation ITU-T G.998.4 (2010), *Improved impulse noise protection for digital subscriber line (DSL) transceivers*.
- [ITU-T G.9700] Recommendation ITU-T G.9700 (2014), *Fast access to subscriber terminals (G.fast) – Power spectral density specification*.
- [ITU-T G.9701] Recommendation ITU-T G.9701 (2014), *Fast access to subscriber terminals (G.fast) – Physical layer specification*.
- [\[ITU T G.9804.2\]](#) [Recommendation ITU-T G.9804.2 \(2021\), Higher speed passive optical networks: Common transmission convergence layer specification.](#)
- [\[ITU T G.9804.3\]](#) [Recommendation ITU-T G.9804.3 \(2021\), 50-Gigabit-capable passive optical networks \(50G-PON\): Physical media dependent \(PMD\) layer specification.](#)
- [ITU-T G.9807.1] Recommendation ITU-T G.9807.1 (2016), *10-Gigabit-capable symmetric passive optical network (XGS-PON)*.
- [ITU-T H.248.x] Recommendations ITU-T H.248.x-series, *Gateway control protocol*.
- [ITU-T H.341] Recommendation ITU-T H.341 (1999), *Multimedia management information base*.
- [ITU-T I.112] Recommendation ITU-T I.112 (1993), *Vocabulary of terms for ISDNs*.
- [ITU-T I.363.5] Recommendation ITU-T I.363.5 (1996), *B-ISDN ATM Adaptation Layer specification: Type 5 AAL*.
- [ITU-T M.3100] Recommendation ITU-T M.3100 (2005), *Generic network information model*.
- [ITU-T T.35] Recommendation ITU-T T.35 (2000), *Procedure for the allocation of ITU-T defined codes for non-standard facilities*.
- [ITU-T T.38] Recommendation ITU-T T.38 (2007), *Procedures for real-time Group 3 facsimile communication over IP networks*.
- [ITU-T X.690] Recommendation ITU-T X.690 (2008) | ISO/IEC 8825-1:2008, *Information technology – ASN.1 encoding rules: Specification of Basic Encoding Rules (BER), Canonical Encoding Rules (CER) and Distinguished Encoding Rules (DER)*.
- [ITU-T X.731] Recommendation ITU-T X.731 (1992) | ISO/IEC 10164-2:1993, *Information technology – Open Systems Interconnection – Systems Management: State management function*.

- [ITU T X.733] Recommendation ITU T X.733 (1992) | ISO/IEC 10164-4:1992, *Information technology – Open Systems Interconnection – Systems Management: Alarm reporting function.*
- [ITU-T Y.1731] Recommendation ITU-T Y.1731 (2008), *OAM functions and mechanisms for Ethernet based networks.*
- [ATIS-0300220] ATIS-0300220.2011, *Representation of the communications industry manufacturers, suppliers, and related service companies for information exchange.*
- [BBF TR-069] Broadband Forum TR-069 Amendment 2 (2007), *CPE WAN management protocol v1.1.*
- [\[BBF TR-369\]](#) [Broadband Forum TR-369 Issue 1, Amendment 1 \(2019\), User Services Platform \(USP\).](#)
- [ETSI TS 101 270-1] ETSI TS 101 270-1 V1.4.1 (2005), *Transmission and multiplexing (TM); Access transmission systems on metallic access cables; Very high speed digital subscriber line (VDSL); Part 1: Functional requirements.*
- [ETSI TS 101 388] ETSI TS 101 388 V1.4.1 (2007), *Access terminals transmission and multiplexing (ATTM); Access transmission systems on metallic access cables; Asymmetric digital subscriber line (ADSL) – European specific requirements [ITU-T Recommendation G.992.1 modified].*
- [IEEE 802] IEEE 802-2001 (R2007), *IEEE Standard for local and metropolitan area networks – Overview and architecture.*
- [IEEE 802.1AB] IEEE 802.1AB-2009, *IEEE Standard for local and metropolitan area networks – Station and media access control connectivity discovery.*
- [IEEE 802.1ad] IEEE 802.1ad-2005, *IEEE Standard for local and metropolitan area networks – Virtual bridged local area networks, Amendment 4: Provider bridges.*
- [IEEE 802.1ag] ANSI/IEEE 802.1ag-2007, *IEEE Standard for local and metropolitan area networks – Amendment 5: Connectivity fault management.*
- [IEEE 802.1D] ANSI/IEEE 802.1D-2004, *IEEE Standard for local and metropolitan area networks – Media access control (MAC) bridges.*
- [IEEE 802.1Q] IEEE 802.1Q-2005, *IEEE Standard for local and metropolitan area networks – Virtual Bridged Local Area networks.*
- [IEEE 802.1X] IEEE 802.1X-2004, *IEEE Standard for local and metropolitan area networks – Port-based network access control.*
- [IEEE 802.3] IEEE 802.3-2008, *IEEE Standard for information technology – Telecommunications and information exchange between systems – Local and metropolitan area networks – Specific requirements – Part 3: Carrier sense multiple access with collision detection (CSMA/CD) access method and physical layer specifications.*
- [IEEE 802.11] IEEE 802.11-2007, *IEEE Standard for information technology – Telecommunications and information exchange between systems – Local and metropolitan area networks – Specific requirements – Part 11: Wireless LAN medium access control (MAC) and physical layer (PHY) specifications.*

- [IEEE 1588] IEEE 1588-2008, *IEEE Standard for a precision clock synchronization protocol for networked measurement and control systems*.
- [IEEE P1904.1] IEEE P1904.1, *Standard for service interoperability in Ethernet passive optical networks (SIEPON)*.
- [IETF RFC 1213] IETF RFC 1213 (1991), *Management information base for network management of TCP/IP-based internets: MIB-II*.
- [IETF RFC 2236] IETF RFC 2236 (1997), *Internet group management protocol, version 2*.
- [IETF RFC 2464] IETF RFC 2464 (1998), *Transmission of IPv6 packets over Ethernet networks*.
- [IETF RFC 2474] IETF RFC 2474 (1998), *Definition of the differentiated services field (DS field) in the IPv4 and IPv6 headers*.
- [IETF RFC 2579] IETF RFC 2579 (1999), *Textual conventions for SMIPv2*.
- [IETF RFC 2597] IETF RFC 2597 (1999), *Assured forwarding PHB group*.
- [IETF RFC 2617] IETF RFC 2617 (1999), *HTTP authentication: Basic and digest access authentication*.
- [IETF RFC 2684] IETF RFC 2684 (1999), *Multiprotocol encapsulation over ATM adaptation layer 5*.
- [IETF RFC 2685] IETF RFC 2685 (1999), *Virtual private networks identifier*.
- [IETF RFC 2819] IETF RFC 2819 (2000), *Remote network monitoring management information base*.
- [IETF RFC 2863] IETF RFC 2863 (2000), *The interfaces group MIB*.
- [IETF RFC 3246] IETF RFC 3246 (2002), *An expedited forwarding PHB (per-hop behavior)*.
- [IETF RFC 3376] IETF RFC 3376 (2002), *Internet group management protocol, version 3*.
- [IETF RFC 3417] IETF RFC 3417 (2002), *Transport mappings for the simple network management protocol (SNMP)*.
- [IETF RFC 3551] IETF RFC 3551 (2003), *RTP profile for audio and video conferences with minimal control*.
- [IETF RFC 3810] IETF RFC 3810 (2004), *Multicast listener discovery version 2 (MLDv2) for IPv6*.
- [IETF RFC 4133] IETF RFC 4133 (2005), *Entity MIB (version 3)*.
- [IETF RFC 4446] IETF RFC 4446 (2006), *IANA allocations for pseudowire edge to edge emulation (PWE3)*.
- [IETF RFC 4733] IETF RFC 4733 (2006), *RTP payload for DTMF digits, telephony tones, and telephony signals*.
- [IETF RFC 4734] IETF RFC 4734 (2006), *Definition of events for modem, fax, and text telephony signals*.
- [IETF RFC 4789] IETF RFC 4789 (2006), *Simple network management protocol (SNMP) over IEEE 802 networks*.
- [IETF RFC 5519] IETF RFC 5519 (2009), *Multicast group membership discovery MIB*.
- [IETF RFC 5605] IETF RFC 5605 (2009), *Managed objects for ATM over packet switched networks (PSNs)*.

- [ISO/IEC 9798-4] ISO/IEC 9798-4:1999, *Information technology – Security techniques – Entity authentication – Part 4: Mechanisms using a cryptographic check function.*
- [MEF 8] Metro Ethernet Forum MEF 8 (2004), *Implementation agreement for the emulation of PDH circuits over Metro Ethernet networks.*

3 Definitions

3.1 Terms defined elsewhere

NOTE – This Recommendation uses the term G-PON to refer generically to PON systems. When a distinction is needed, this Recommendation qualifies the usage with an explicit reference to the appropriate series.

This Recommendation uses the following terms defined elsewhere:

- 3.1.1 **10-gigabit-capable passive optical network (XG-PON):** [ITU-T G.987] (See Note to 3.1.)
- 3.1.2 **dynamic bandwidth assignment (DBA):** [ITU-T G.987]
- 3.1.3 **gigabit-capable passive optical network (G-PON):** [ITU-T G.987] (See Note to 3.1.)
- 3.1.4 **mean optical launch power:** [ITU-T G.987]
- 3.1.5 **ONU management and control interface (OMCI):** [ITU-T G.987]
- 3.1.6 **optical line termination (OLT):** [ITU-T G.987]
- 3.1.7 **optical network unit (ONU):** [ITU-T G.987]
- 3.1.8 **passive optical network (PON) system:** [ITU-T G.987]
- 3.1.9 **physical layer OAM (PLOAM):** [ITU-T G.987]
- 3.1.10 **ranging:** [ITU-T G.987]
- 3.1.11 **transmission container (T-CONT):** [ITU-T G.987]
- 3.1.12 **user-network interface (UNI):** [ITU-T I.112].

3.2 Terms defined in this Recommendation

This Recommendation defines the following terms:

- 3.2.1 **downstream:** The direction of traffic flow from an optical line termination (OLT) to the optical network unit (ONU).
- 3.2.2 **policing:** A process that causes a flow of input packets to conform to a given peak information rate (PIR)/peak burst size (PBS) by immediately dropping packets that exceed PIR/PBS. This typically results in packet loss; packets may be further marked as drop eligible if they exceed the committed information rate (CIR)/committed burst size (CBS).
- 3.2.3 **shaping:** A process that causes a flow of input packets to conform to a given peak information rate (PIR)/peak burst size (PBS) by controlling the release rate/burst size of output packets. This typically results in a queueing delay; packets may be dropped if there is a queue overflow because the input rate or burst size is too great.
- 3.2.4 **upstream:** The direction of traffic flow from an optical line termination (ONU) to the optical network unit (OLT).

4 Abbreviations and acronyms

This Recommendation uses the following abbreviations and acronyms:

AAL Asynchronous transfer mode Adaptation Layer

ACK	Acknowledgement
ACS	Autoconfiguration Server
ADSL	Asymmetric Digital Subscriber Line
AES	Advanced Encryption Standard
AF	Assured Forwarding
AIS	Alarm Indication Signal
AK	Acknowledgement
AMCC	Auxiliary Management and Control Channel
ANI	Access Node Interface
ANI-E	Access Network Interface supported by an EPON ONU
ANI-G	Access Network Interface supported by a G-PON ONU
AR	Acknowledge Request
ARC	Alarm-Reporting Control
ARP	Address Resolution Protocol
ASCII	American Standard Code for Information Interchange
ATA	Analogue Telephony Adaptor
ATM	Asynchronous Transfer Mode
ATU-C	Asymmetric digital subscriber line Transceiver Unit, Central office (ONU) end
ATU-R	Asymmetric digital subscriber line Transceiver Unit, Remote terminal end
AVC	Attribute Value Change
BE	Best Effort
BER	Bit Error Rate
BES	Burst Errored Second
BIP	Bit-Interleaved Parity
BNG	Broadband Network Gateway
B-PON	Broadband Passive Optical Network
CAS	Channel Associated Signalling
CBS	Committed Burst Size
CCM	Continuity Check Message
CES	Circuit Emulation Service
CFI	Canonical Format Indicator
CFM	Configuration Fault Management
CIR	Committed Information Rate
CLEI	Common Language Equipment Identification
CLP	Cell Loss Priority
CMAC	Cipher-based Message Authentication Code
CoS	Class of Service

CPCS-SDU	Common Part Convergence Sublayer Service Data Unit
CPCS-UU	Common Part Convergence Sublayer User-to-User indication
CPE	Customer Premises Equipment
CPI	Common Part Indicator
CRC	Cyclic Redundancy Check
CS	Convergence Sublayer
CSS	Controlled Slip Seconds
CTP	Connection Termination Point
DA	Destination Address
DAD	Duplicate Address Detection
DBA	Dynamic Bandwidth Assignment
DBDT	Draw-Break Dial Tone
DEI	Discard Eligibility Indicator (bit)
DHCP	Dynamic Host Configuration Protocol
DMT	Discrete Multi-Tone, xDSL
DNS	Domain Name Server
DRT	Data Rate Threshold
DS	Downstream
DSCP	Differentiated Services Code Point
DSL	Digital Subscriber Line
DSLAM	Digital Subscriber Line Access Multiplexer
DUID	DHCP Unique Identifier
DWLCH	Downstream Wavelength Channel
ECB	Electronic Codebook
ECID	Emulated Circuit ID
EF	Expedited Forwarding
EFM	Ethernet in the First Mile
EIR	Excess Information Rate
EMS	Element Management System
eoc	embedded operations channel
EPON	Ethernet Passive Optical Network
ES	Errored Second
ESMC	Ethernet Synchronization Message Channel
ES-L	Errored Second-Line
ES-LFE	Errored Second-Line Far End
ES-NP	Errored Second-Network Performance
ES-NPFE	Errored Second-Network Performance Far End

ES-P	Errored Second-Path
ES-PFE	Errored Second-Path Far End
EVC	Ethernet Virtual Connection
EVS	Ethernet Virtual Service
FCS	Frame Check Sequence
FDL	Facility Data Link
FE	Far End
FEBE	Far End Block Error
FEC	Forward Error Correction
FRU	Field-Replaceable Unit
FTTx	Fibre to the x (B – building, business; H – home; C – cabinet, curb)
FS	Framing Sublayer
GAL	GEM Adaptation Layer
GARP	Generic Attribute Registration Protocol
GEM	Gigabit-capable passive optical network Encapsulation Method NOTE – See [ITU-T G.984.x]. Unless explicitly stated otherwise, this term also refers generically to XGEM encapsulation.
G-PON	Gigabit-capable Passive Optical Network NOTE – See [ITU-T G.984.x]. Unless explicitly stated otherwise, this term also refers generically to [ITU-T G.987] XG-PON.
GSP	Generic Status Portal
GTC	Gigabit-capable passive optical network Transmission Convergence layer [ITU-T G.984.x] NOTE – Unless explicitly stated otherwise, this term also refers generically to XGTC.
HEC	Header Error Check
HSP	High Speed PON
IA_NA	Identity Association for Non-temporary Addresses NOTE – See [b-IETF RFC 3315].
IAT	Inter-Arrival Time, xDSL
ICMP	Internet Control Message Protocol
ID	Identifier
IF	Interface
IGMP	Internet Group Management Protocol NOTE – IGMP may also refer generically to IPv6 MLD.
INM	Impulse Noise Monitoring
INP	Impulse Noise Protection
IP	Internet Protocol
IPHC	IP Host Config
IW	Interworking

KEK	Key Encryption Key
L2-OCM	Layer 2 OMCI Common Model
LAN	Local Area Network
LASP	Link Aggregation Service Profile
LBM	Loopback Message
LBO	Line Build-Out
LBR	Loopback Reply
LCD	Loss of Cell Delineation
LCT	Local Craft Terminal
LIM	Line Interface Module
INIT	Line Initialization failure
LL	Limited Link
LLC	Link Layer Control
LLID	Logical Link ID
LMIG	Layer Management Indication Generation
LMIR	Layer Management Indication Receiving
LODS	Loss Of Downstream Synchronization
LOF	Loss Of Frame
LOID	Logical ONU ID
LOL	Loss Of Link
LOM	Loss-Of-Margin
LOR	Loss Of RMC
LOS	Loss Of Signal
LPR	Loss of Power
LSB	Least Significant Bit
LTM	Linktrace Message
LTR	Linktrace Reply
MA	Maintenance Association
MAC	Medium Access Control
MD	Maintenance Domain
MDU	Multiple Dwelling Unit
ME	Managed Entity
MEG	Maintenance Entity Group
MEP	Maintenance association End Point
MGC	Media Gateway Controller
MHF	Maintenance domain intermediate point Half Function
MIB	Management Information Base

MIC	Message Integrity Check
MIP	Maintenance domain Intermediate Point
MLD	Multicast Listener Discovery
NOTE	– MLD is sometimes included generically in the acronym IGMP.
MLT	Mechanized Loop Test(ing)
MoCA	Multimedia Over Coax Alliance
MP	Maintenance Point
MPCPDU	Multi-Point Control Protocol Data Unit
MSB	Most Significant Bit
MT	Message Type
MTU	Maximum Transmission Unit
NACK	Negative Acknowledgement
NCD	No Cell Delineation
NE	Near End
NSCds	Number of xDSL Subcarriers, downstream
NSCus	Number of xDSL Subcarriers, upstream
OA	Optical Amplifier/Amplification
OAM	Operations, Administration and Maintenance
OEO	Optical-Electrical-Optical
OID	Object Identifier
OLR	On-Line Reconfiguration
OLT	Optical Line Termination
OMCC	Optical network unit Management and Control Channel
OMCI	Optical network unit Management and Control Interface
OMI	Optical Modulation Index
ONT	Optical Network Termination
ONU	Optical Network Unit
OOF	Out Of Frame
OOS	Out Of Sync
OS	Operations System
OTL	Optical Trunk Line
OUI	Organizationally Unique Identifier
PBS	Peak Burst Size
PCP	Priority Code Point
PD	Powered Device
PDU	Protocol Data Unit
PHY	Physical interface

PIR	Peak Information Rate
PLOAM	Physical Layer Operations, Administration and Maintenance
PM	Performance Monitoring
PME	Physical Medium Entity
PoE	Power over Ethernet
PON	Passive Optical Network
POTS	Plain Old Telephone Service
PPPoE	Point-to-Point Protocol over Ethernet
PPTP	Physical Path Termination Point
PSBd	Physical Sync Block-downstream
PSD	Power Spectral Density
PSE	Power-Sourcing Equipment
PSK	Pre-shared Secret Key
PSN	Packet-Switched Network
QLN	Quiet Line Noise
QoS	Quality of Service
RA	Router Advertisement
RAB	Rate Adaptation Buffer
RAD	Rate Adaptation - Downshift
RAU	Rate Adaptation - Upshift
RDI	Remote Defect Indication
RE	Reach Extender
REN	Ringer Equivalent Number
REIN	Repetitive Electrical Impulse Noise
RF	Radio Frequency
RFI	Radio Frequency Interference
RG	Residential Gateway
RMC	Robust Management Channel
RO	Read Only
ROC	Robust Operations Channel
ROH	Receiver Off Hook
RS	Router Solicitation
RTCP	Real-time Transport Control Protocol
RTP	Real-Time Protocol
RW	Read, Write
RWSC	Read, Write, Set-by-Create
SAR	Segmentation And Reassembly

SD	Signal Degrade
SDH	Synchronous Digital Hierarchy
SDU	Service Data Unit
SES	Severely Errored Second
SES-L	Severely Errored Second-Line
SES-LFE	Severely Errored Second-Line Far End
SES-NP	Severely Errored Second-Network Performance
SES-NPFE	Severely Errored Second-Network Performance, Far End
SES-P	Severely Errored Second-Path
SES-PFE	Severely Errored Second-Path Far End
SF	Signal Fail
SHINE	Single High Impulse Noise Event
SIP	Session Initiation Protocol
SLA	Service Level Agreement
SLAAC	Stateless Address Autoconfiguration
SNMP	Simple Network Management Protocol
SNR	Signal-to-Noise Ratio
SOS	Save Our Showtime
SPR	Snooping with Proxy Reporting
SRA	Seamless Rate Adaptation
SSCOP	Service Specific Connection Oriented Protocol
SSCS	Service Specific Convergence Sublayer
TC	Transmission Convergence
TCA	Threshold Crossing Alert
TCI	Tag Control Information
T-CONT	Transmission Container
TCP	Transmission Control Protocol
TDM	Time Division Multiplex
TLP	Transmission Level Point
TLV	Type-Length-Value
TP	Termination Point
TQ	Time Quantum
trTCM	two-rate Three Colour Marker
TTL	Time To Live
TWDM	Time and Wavelength Division Multiplexing
UA	User Agent
UAS	Unavailable Second

UAS-NP	Unavailable Second-Network Performance
UAS-NPFE	Unavailable Second-Network Performance Far End
UAS-P	Unavailable Second (-L: -line, -P: -path, -FE: -far-end)
UDP	User Datagram Protocol
UNI	User Network Interface
UNI-G	User Network Interface supported by Gigabit-capable passive optical network encapsulation method
UPBO	Upstream Power Back-Off
US	Upstream
VBES	VLANs for Business Ethernet Services
VC	Virtual Circuit
VCC	Virtual Circuit Connection
VCI	Virtual Circuit Identifier
VDSL	Very high speed Digital Subscriber Line NOTE – ITU-T G.993.2 VDSL2 is managed under the xDSL family of MEs.
VEIP	Virtual Ethernet Interface Point
VID	Virtual local area network Identifier
VLAN	Virtual Local Area Network
VoIP	Voice Over Internet Protocol
VP	Virtual Path
VPI	Virtual Path Identifier
VPN	Virtual Private Network
VRP	Video Return Path
VTU	VDSL2 Transceiver Unit
VTU-O	Very high-speed digital subscriber line Transceiver Unit, Operator end
VTU-R	Very high-speed digital subscriber line Transceiver Unit, Remote end
WFQ	Weighted Fair Queueing
WLCP	Wavelength Channel Protection
WRR	Weighted Round Robin
xDSL	x Digital Subscriber Line NOTE – This is an inclusive term for any of the DSL Recommendations, excluding [ITU-T G.993.1].
XGEM	XG-PON Encapsulation Method NOTE – See [ITU-T G.987]. Sometimes this abbreviation is included generically under the acronym GEM.
XG-PON	10 Gigabit-capable Passive Optical Network
XML	extensible Markup Language
xTU-C	x digital subscriber line Transceiver Unit at the Central office end

NOTE – This is used as a generic term referring to both the asymmetric digital subscriber line transceiver unit, central office (ONU) end (ATU-C of the ITU-T G.992.x series and the very high-speed digital subscriber line transceiver unit, operator end (VTU-O) of [ITU-T G.993.2].

xTU-R x digital subscriber line Transceiver Unit at the Remote end

NOTE – This is used as a generic term referring to both the asymmetric digital subscriber line transceiver unit, remote terminal end (ATU-R of the ITU-T G.992.x series and the VTU-R of [ITU-T G.993.2].

5 Conventions

In bit vectors indicated in this Recommendation, the rightmost bit is bit 1. This represents the least significant bit (LSB), while bit 8 represents the most significant bit (MSB) within a byte. If the bit vector is made up of more than one byte, then bit numbering starts from the least significant byte onwards.

In attribute descriptions that refer to the Boolean values *true* and *false*, true is coded as 0x01 in hexadecimal and false is coded as 0x00. A Boolean attribute is always one byte.

In attribute descriptions that refer to spaces, the American standard code for information interchange (ASCII) space character (value 0x20) must be used for the entire size of the attribute.

An *ASCII string* is a sequence of ASCII encoded characters, terminated by the null character (0x00). If a string occupies the entire allocated size of an attribute, the terminating null is not required.

This Recommendation frequently states that the OLT makes certain decisions or takes certain actions. While the OMCI commands may emanate from the OLT, there is no implication that the actual decision or action impetus comes from logic internal to the OLT, rather than from a separate management system or a human operator.

When [ITU-T G.987] is referenced in this Recommendation, it applies generically to [ITU-T G.9807.1] XGS-PON, [ITU-T G.989.3] NG-PON2, and [ITU-T G.9804.2] ComTC, unless otherwise specified. When a particular clause of [ITU-T G.987.3] is referenced in this Recommendation, it applies generically to the analogous clause of [ITU-T G.9807.1], [ITU-T G.989.3], and [ITU-T G.9804.2], unless otherwise specified.

6 Reference model and terms

6.1 OMCI in the access network

The network architecture reference model for PON is described in the applicable ITU-T GTC based PON system specification. An access system according to [ITU-T G.986] has a single ONU on each fibre subtended from the OLT.

The OMCI fits into the overall model for an access network system as illustrated in Figure 6.1-1. The dotted line shows a path for OMCI signals between an OLT and ONU.

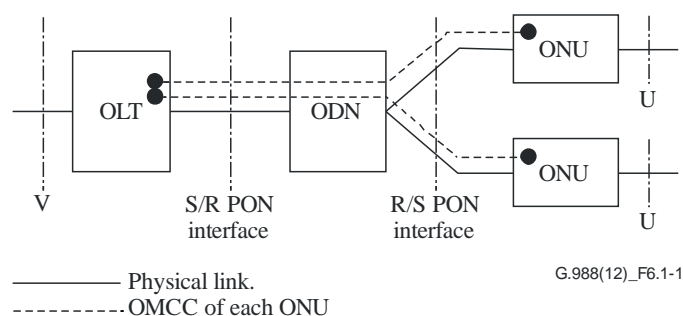

Figure 6.1-1 – Reference model, OMCI

6.2 ONU functions

As shown in Figure 6.2-1, the functions of the ONU are:

- a) access network line termination;
- b) user network interface (UNI) line termination, noting that in the fibre to the business case, the UNIs from one ONU may belong to different users;
- c) service multiplexing and de-multiplexing.

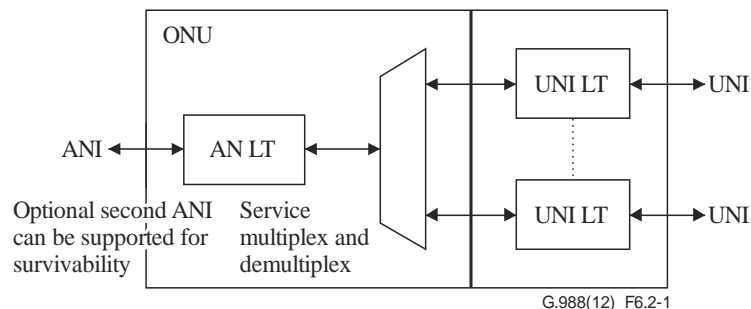

Figure 6.2-1 – ONU functional block diagram

6.3 Support of multicast connection

Multicast traffic can be supported in an optical access network. While a GEM port-ID is assigned to a single UNI in a unicast connection, a GEM port-ID is shared by multiple UNIs in multiple ONUs in a multicast connection. The multicast connection set-up process is the same as the unicast connection set-up process. It is the responsibility of the OLT to manage the members of a multicast group and control the multicast connection in ONUs.

In the downstream direction of G-PON, a multicast connection is useful for bandwidth savings. On the other hand, in the upstream direction, it is impossible to support a multicast connection with a shared port-ID because the OLT could not reassemble segmented GEM packets correctly if it received several GEM packets with the same port-ID from different ONUs. Therefore, upstream traffic associated with a multicast service must be sent to the OLT over a separate unicast connection.

6.4 Voice over Internet protocol management

While the OMCI is always used to manage PON services and ONU equipment, a voice Over Internet protocol (VoIP) service may optionally be managed by means external to the OMCI. This allows operators more flexibility in choosing how to manage their overall VoIP service, regardless of the access technology involved. A VoIP service on an ONU may be managed via one of two paths:

- 1) OMCI path – OMCI has full view and control of all VoIP service attributes;
- 2) Internet protocol (IP) path – OMCI is only used to configure attributes that allow non-OMCI based control of VoIP service attributes.

Specifically, if the OMCI path is used to manage a VoIP service, all of the managed entities (MEs) defined here may be read or written.

If the IP path is used to manage an session initiation protocol (SIP) VoIP service, only the following SIP-related MEs may be read or written (all other MEs are unaffected):

- IP host config data;
- IP host performance monitoring (PM) history data;
- VoIP config data;
- physical path termination point (PPTP) plain old telephone service (POTS) UNI;
- call control PM history data;

- real-time protocol (RTP) PM history data;
- SIP call initiation PM history data;
- SIP agent PM history data;
- SIP config portal;
- VoIP line status.

If the IP path is used to manage an ITU-T H.248 VoIP service, only the following ITU-T H.248-related MEs may be read or written (all other MEs are unaffected):

- IP host config data;
- IP host PM history data;
- VoIP config data;
- PPTP POTS UNI;
- Call control PM history data;
- RTP PM history data;
- MGC PM history data;
- ITU-T H.248 config portal;
- VoIP line status.

7 Requirements of the management interface specification

The ONU management and control interface defined by this Recommendation is used by the OLT to manage the ONU in the following areas:

- a) configuration management
- b) fault management
- c) performance management
- d) security management.

This interface allows the OLT to:

- a) establish and release connections across the ONU;
- b) manage the UNIs at the ONU;
- c) request configuration information and performance statistics.

The OMCI also allows the ONU to inform the OLT autonomously of alarms, performance threshold crossings and changes to the values of many of the MIB attributes.

The OMCI protocol is asymmetric: the controller in the OLT is the master, while the ONU is the slave. A single OLT controller using multiple instances of the protocol over separate control channels typically controls multiple ONUs.

In G-PON, the OMCI protocol runs across a GEM connection between the OLT controller and the ONU controller. The GEM connection is established at ONU initialization. OMCI transport in ITU-T G.986 applications is defined in [ITU-T G.986].

7.1 Configuration management

Configuration management provides functions to identify the ONU's capabilities and to exercise control over the ONU. Areas of management include configuration of:

- a) equipment;
- b) PON and reach extender (RE) protection;

- c) the UNIs;
- d) GEM port network CTPs in G-PON applications;
- e) interworking termination points (TPs);
- f) operations, administration and maintenance (OAM) flows;
- g) physical ports;
- h) GEM adaptation layer (GAL) profiles in G-PON applications;
- i) service profiles;
- j) traffic descriptors;
- k) asynchronous transfer mode adaptation layer (AAL) profiles, when needed for asymmetric digital subscriber line (ADSL) UNIs.

All G-PON ONUs support GEM transport of user traffic. There is only one connection model for GEM transport, which is the simple point-to-point transfer of user data via a GEM connection across the PON, and with downstream multicast capability. GEM interworking (IW) always occurs in the OLT and the ONU, and GEM never extends beyond the PON link.

When the ONU supports an asynchronous transfer mode (ATM) UNI (ADSL), the ATM connection from the subscriber terminates at the ONU. The OMCI supports the required configuration methods to manage this function.

7.2 Fault management

As modelled by the OMCI, the ONU detects and reports equipment, software and interface failures and declares the corresponding alarms. The OMCI supports failure reporting on many MEs as described in clause 9. An alarm table is defined for each of these entities.

To avoid erratic floods of alarm messages, it is common to filter, or soak, defects such as facility impairments before declaring them as alarms, and to soak defect clearing before retiring the alarm. The declaration soak time is typically 2.5 ± 0.5 s, while the retirement soak time is typically 10.5 ± 0.5 s. Which alarms are to be soaked, and what the soak intervals should be, are regarded as vendor-specific choices. Interoperability considerations, however, require that alarms be soaked exactly once, either at the OLT or at the ONU. This Recommendation specifies that they be soaked at the ONU.

In addition to failure reporting, the OMCI supports test, measurement and in-service monitoring, including:

- a) metallic tests of copper drops (voice or x digital subscriber line (xDSL));
- b) optical and other parameters of the optical distribution network;
- c) [IEEE 802.1ag] connectivity fault management;
- d) directed loopback, e.g., of DS1/E1 services.

The OMCI also provides for the reporting of protection switch events.

7.3 Performance management

The ONU has only limited PM. The OMCI supports PM using a number of MEs that are described throughout clause 9. These MEs can be identified by the words "performance monitoring history data" or "extended PM" in their names.

All PM-related MEs are created at the request of the OLT.

All history data are maintained in the OLT. The ONU maintains only a current counter and one 15 min previous-interval counter.

Clause I.4 describes PM in detail.

7.4 Security management

Different access technologies specify differing degrees of security capability. The OMCI supports a mechanism to allow mutual authentication of the OLT and ONU and subsequent secure communication of encryption keys.

8 Protocol-independent MIB for the OMCI

The OMCI is defined such that vendors can offer modular, incremental capabilities to meet different levels of customer needs. This Recommendation defines a protocol necessary to support capabilities specified in the relevant PON specifications, as well as a variety of services and features. The OMCI supports interoperability, yet it allows for optional components and future extensions.

A protocol-independent MIB describes the exchange of information across the OMCI. Clause 8.1 lists the MEs and illustrates key relationships between them to implement some of the important features that may be offered by ONUs. Clause 9 defines each ME in detail.

8.1 Managed entities

The protocol-independent MIB presented in this Recommendation is defined in terms of MEs. MEs are abstract representations of resources and services in an ONU. Only a small subset of the list of MEs is mandatory. The existence of other MEs depends on the architecture and feature set supported by the vendor.

Table 8-1 lists all the MEs. The designation M in a column indicates that the specified ME is mandatory for systems complying with the corresponding Recommendation. The designation M/E in a column indicates that the corresponding ME is mandatory and that its definition is adapted to [IEEE 802.3] applications in accordance with Annex C. N/A indicates that the specified ME is not applicable. Other MEs are present according to the architecture and the feature set offered by a given ONU.

Table 8-1 – Managed entities of the OMCI

Clause	Managed entity	ITU-T G.984, ITU-T G.987, ITU-T G.9807.1	ITU-T G.989	ITU-T G.986	IEEE 802.3, IEEE 802.3av	<u>ITU-T G.9804</u>
9.13.6	AAL5 performance monitoring history data				N/A	
9.13.5	AAL5 profile				N/A	
9.2.19	ANI-E				M	
9.2.1	ANI-G	M	M		M	<u>M</u>
9.12.10	Attribute					
9.12.4	Authentication security method					
9.12.16	BBF TR-069 management server					
9.9.12	Call control performance monitoring history data					
9.1.5	Cardholder	M	M		M	<u>M</u>
9.8.4	CES physical interface performance monitoring history data					

Table 8-1 – Managed entities of the OMCI

Clause	Managed entity	ITU-T G.984, ITU-T G.987, ITU-T G.9807.1	ITU-T G.989	ITU-T G.986	IEEE 802.3, IEEE 802.3av	<u>ITU-T G.9804</u>
9.8.12	CES physical interface performance monitoring history data 2					
9.8.13	CES physical interface performance monitoring history data 3					
9.8.3	CES service profile					
9.1.6	Circuit pack					
9.7.40	Data gathering line test, diagnostic and status					
9.3.18	Dot1 rate limiter					
9.3.25	Dot1ag CFM stack					
9.3.26	Dot1ag chassis-management info					
9.3.21	Dot1ag default MD level					
9.3.20	Dot1ag maintenance association					
9.3.19	Dot1ag maintenance domain					
9.3.22	Dot1ag MEP					
9.3.24	Dot1ag MEP CCM database					
9.3.23	Dot1ag MEP status					
9.3.15	Dot1X configuration profile					
9.3.16	Dot1X performance monitoring history data					
9.3.14	Dot1X port extension package					
9.7.41	EFM bonding group					
9.7.43	EFM bonding group performance monitoring history data					
9.7.44	EFM bonding group performance monitoring history data part 2					
9.7.42	EFM bonding link					
9.7.45	EFM bonding link performance monitoring history data					

Table 8-1 – Managed entities of the OMCI

Clause	Managed entity	ITU-T G.984, ITU-T G.987, ITU-T G.9807.1	ITU-T G.989	ITU-T G.986	IEEE 802.3, IEEE 802.3av	<u>ITU-T G.9804</u>
9.7.46	EFM bonding port performance monitoring history data					
9.7.47	EFM bonding port performance monitoring history data part 2					
9.2.14	Energy consumption performance monitoring history data					
9.2.22	Enhanced FEC performance monitoring history data					
9.13.11	Enhanced security control					
9.2.23	Enhanced TC performance monitoring history data					
9.2.20	EPON downstream performance monitoring configuration					
9.1.9	Equipment extension package					
9.1.11	Equipment protection profile					
9.8.9	Ethernet flow termination point					
9.3.32	Ethernet frame extended PM					
9.3.34	Ethernet frame extended PM 64 Bit					
9.3.31	Ethernet frame performance monitoring history data downstream					
9.3.30	Ethernet frame performance monitoring history data upstream					
9.5.2	Ethernet performance monitoring history data					
9.5.3	Ethernet performance monitoring history data 2					
9.5.4	Ethernet performance monitoring history data 3					
9.8.18	Ethernet pseudowire parameters					
9.3.13	Extended VLAN tagging operation configuration data					
9.7.49	FAST line configuration profile part 1					

Table 8-1 – Managed entities of the OMCI

Clause	Managed entity	ITU-T G.984, ITU-T G.987, ITU-T G.9807.1	ITU-T G.989	ITU-T G.986	IEEE 802.3, IEEE 802.3av	<u>ITU-T G.9804</u>
9.7.50	FAST line configuration profile part 2					
9.7.51	FAST line configuration profile part 3					
9.7.52	FAST line configuration profile part 4					
9.7.53	FAST channel configuration profile					
9.7.54	FAST data path configuration profile					
9.7.55	FAST vectoring line configuration extensions					
9.7.56	FAST line inventory and status data					
9.7.57	FAST line inventory and status data part 2					
9.7.58	FAST xTU-C performance monitoring history data					
9.7.59	FAST xTU-R performance monitoring history data					
9.2.9	FEC performance monitoring history data					
9.12.13	File transfer controller					
9.2.8	GAL Ethernet performance monitoring history data				N/A	
9.2.7	GAL Ethernet profile				N/A	
9.2.4	GEM interworking termination point	M	M		M/E	<u>M</u>
9.2.3	GEM port network CTP	M	M		M/E	<u>M</u>
9.2.13	GEM port network CTP performance monitoring history data				N/A	
9.12.12	General purpose buffer					
9.12.14	Generic status portal					
9.3.10	IEEE 802.1p mapper service profile					
9.13.4	Interworking VCC termination point					
9.4.1	IP host config data					
9.4.2	IP host performance monitoring history data					

Table 8-1 – Managed entities of the OMCI

Clause	Managed entity	ITU-T G.984, ITU-T G.987, ITU-T G.9807.1	ITU-T G.989	ITU-T G.986	IEEE 802.3, IEEE 802.3av	<u>ITU-T G.9804</u>
9.4.5	IPv6 host config data					
9.2.18	L2 multicast GEM interworking termination point					
9.12.5	Large string					
9.3.35	Link aggregation service profile					
9.8.2	Logical $N \times 64$ kbit/s sub-port connection termination point (CTP)					
9.3.2	MAC bridge configuration data					
9.3.3	MAC bridge performance monitoring history data					
9.3.8	MAC bridge port bridge table data					
9.3.4	MAC bridge port configuration data					
9.3.5	MAC bridge port designation data					
9.3.7	MAC bridge port filter pre-assign table					
9.3.6	MAC bridge port filter table data					
9.3.33	MAC bridge port ICMPv6 process pre-assign table					
9.3.9	MAC bridge port performance monitoring history data					
9.3.1	MAC bridge service profile					
9.12.9	Managed entity					
9.9.16	MGC config data					
9.9.20	MGC config portal					
9.9.17	MGC performance monitoring history data					
9.10.2	Multimedia over coax alliance (MoCA) Ethernet performance monitoring history data					

Table 8-1 – Managed entities of the OMCI

Clause	Managed entity	ITU-T G.984, ITU-T G.987, ITU-T G.9807.1	ITU-T G.989	ITU-T G.986	IEEE 802.3, IEEE 802.3av	<u>ITU-T G.9804</u>
9.10.3	MoCA interface performance monitoring history data					
9.8.14	MPLS pseudowire termination point					
9.2.5	Multicast GEM interworking termination point					
9.3.27	Multicast operations profile					
9.3.28	Multicast subscriber config info					
9.3.29	Multicast subscriber monitor					
9.12.3	Network address					
9.9.10	Network dial plan table					
9.12.11	Octet string					
9.12.2	OLT-G					
9.12.8	OMCI					
9.1.3	ONU data	M	M	M	M	<u>M</u>
9.1.14	ONU dynamic power management control					
9.1.16	ONU manufacturing data					
9.1.7	ONU power shedding					
9.1.12	ONU remote debug					
9.1.17	ONU time configuration					
9.1.2	ONU2-G	M	M		M	<u>M</u>
9.1.15	ONU3-G		M			<u>M</u>
9.1.13	ONU-E			M	N/A	
9.1.1	ONU-G	M	M		M	<u>M</u>
<u>9.1.19</u>	<u>ONU4-G</u>					<u>M</u>
9.12.18	OpenFlow config data					
9.8.1	Physical path termination point CES UNI					
9.5.1	Physical path termination point Ethernet UNI			M		
9.13.3	Physical path termination point LCT UNI					
9.10.1	Physical path termination point MoCA UNI					

Table 8-1 – Managed entities of the OMCI

Clause	Managed entity	ITU-T G.984, ITU-T G.987, ITU-T G.9807.1	ITU-T G.989	ITU-T G.986	IEEE 802.3, IEEE 802.3av	<u>ITU-T G.9804</u>
9.9.1	Physical path termination point POTS UNI					
9.14.2	Physical path termination point RE UNI					
9.15.1	Physical path termination point RS232/RS485 UNI					
9.13.2	Physical path termination point video ANI					
9.13.1	Physical path termination point video UNI					
9.7.1	Physical path termination point xDSL UNI part 1					
9.7.2	Physical path termination point xDSL UNI part 2					
9.7.48	Physical path termination point xDSL UNI part 3					
9.5.6	Power over Ethernet (PoE) control					
9.1.8	Port-mapping package					
9.2.10	Priority queue					
9.1.10	Protection data					
9.8.7	Pseudowire maintenance profile					
9.8.8	Pseudowire performance monitoring history data					
9.8.5	Pseudowire termination point					
9.7.32	PTM performance monitoring history data xDSL					
9.8.15	PW ATM configuration data					
9.8.16	PW ATM performance monitoring history data					
9.8.17	PW Ethernet configuration data					
9.3.17	Radius performance monitoring history data					
9.14.1	RE ANI-G					
9.14.6	RE common amplifier parameters					
9.14.5	RE config portal					

Table 8-1 – Managed entities of the OMCI

Clause	Managed entity	ITU-T G.984, ITU-T G.987, ITU-T G.9807.1	ITU-T G.989	ITU-T G.986	IEEE 802.3, IEEE 802.3av	<u>ITU-T G.9804</u>
9.14.4	RE downstream amplifier					
9.14.3	RE upstream amplifier					
9.15.2	RS232/RS485 performance monitoring history data					
9.15.3	RS232/RS485 Port Operation Configuration data					
9.9.13	RTP performance monitoring history data					
9.9.7	RTP profile data					
9.8.6	RTP pseudowire parameters					
9.9.3	SIP agent config data					
9.9.21	SIP agent config data 2					
9.9.14	SIP agent performance monitoring history data					
9.9.15	SIP call initiation performance monitoring history data					
9.9.19	SIP config portal					
9.9.2	SIP user data					
9.12.15	Simple network management protocol (SNMP) configuration data					
9.1.4	Software image	M	M		M	<u>M</u>
9.7.25	TC adaptor performance monitoring history data xDSL					
9.2.2	T-CONT	M	M		M	<u>M</u>
9.4.3	TCP/UDP config data					
9.4.4	TCP/UDP performance monitoring history data					
9.12.6	Threshold data 1					
9.12.7	Threshold data 2					
9.12.17	Threshold data 64 Bit					
9.12.19	Time status message					
9.2.12	Traffic descriptor					
9.2.11	Traffic scheduler					

Table 8-1 – Managed entities of the OMCI

Clause	Managed entity	ITU-T G.984, ITU-T G.987, ITU-T G.9807.1	ITU-T G.989	ITU-T G.986	IEEE 802.3, IEEE 802.3av	<u>ITU-T G.9804</u>
9.16.1	TWDM/ <u>TDM</u> System Profile managed entity		M			<u>M</u>
9.16.2	TWDM/ <u>TDM</u> channel managed entity		M			<u>M</u>
9.16.3	TWDM channel PHY/LODS performance monitoring history data					
9.16.4	TWDM channel XGEM performance monitoring history data					
9.16.5	TWDM channel PLOAM performance monitoring history data part 1					
9.16.6	TWDM channel PLOAM performance monitoring history data part 2					
9.16.7	TWDM channel PLOAM performance monitoring history data part 3					
9.16.8	TWDM channel tuning performance monitoring history data part 1					
9.16.9	TWDM channel tuning performance monitoring history data part 2					
9.16.10	TWDM channel tuning performance monitoring history data part 3					
9.16.11	TWDM channel OMCI performance monitoring history data					
9.12.1	UNI-G					
9.7.6	VDSL2 line configuration extensions					
9.7.26	VDSL2 line configuration extensions 2					
9.7.33	VDSL2 line configuration extensions 3					
9.7.16	VDSL2 line inventory and status data part 1					
9.7.17	VDSL2 line inventory and status data part 2					
9.7.18	VDSL2 line inventory and status data part 3					

Table 8-1 – Managed entities of the OMCI

Clause	Managed entity	ITU-T G.984, ITU-T G.987, ITU-T G.9807.1	ITU-T G.989	ITU-T G.986	IEEE 802.3, IEEE 802.3av	<u>ITU-T G.9804</u>
9.7.38	VDSL2 line inventory and status data part 4					
9.7.34	Vectoring line configuration extensions					
9.7.39	Vectoring line inventory and status data					
9.5.5	Virtual Ethernet interface point					
9.3.11	VLAN tagging filter data					
9.3.12	VLAN tagging operation configuration data					
9.9.6	Voice service profile					
9.9.8	VoIP application service profile					
9.9.18	VoIP config data					
9.9.9	VoIP feature access codes					
9.9.11	VoIP line status					
9.9.5	VoIP media profile					
9.9.4	VoIP voice CTP					
9.13.9	VP network CTP					
9.13.10	VP performance monitoring history data					
9.7.7	xDSL channel configuration profile					
9.7.35	xDSL channel configuration profile part 2					
9.7.19	xDSL channel downstream status data					
9.7.20	xDSL channel upstream status data					
9.7.11	xDSL downstream radio frequency interference (RFI) bands profile					
9.7.27	xDSL impulse noise monitor performance monitoring history data					
9.7.3	xDSL line configuration profile part 1					
9.7.4	xDSL line configuration profile part 2					

Table 8-1 – Managed entities of the OMCI

Clause	Managed entity	ITU-T G.984, ITU-T G.987, ITU-T G.9807.1	ITU-T G.989	ITU-T G.986	IEEE 802.3, IEEE 802.3av	<u>ITU-T G.9804</u>
9.7.5	xDSL line configuration profile part 3					
9.7.12	xDSL line inventory and status data part 1					
9.7.13	xDSL line inventory and status data part 2					
9.7.14	xDSL line inventory and status data part 3					
9.7.15	xDSL line inventory and status data part 4					
9.7.28	xDSL line inventory and status data part 5					
9.7.29	xDSL line inventory and status data part 6					
9.7.30	xDSL line inventory and status data part 7					
9.7.37	xDSL line inventory and status data part 8					
9.7.10	xDSL PSD mask profile					
9.7.8	xDSL subcarrier masking downstream profile					
9.7.9	xDSL subcarrier masking upstream profile					
9.7.23	xDSL xTU-C channel performance monitoring history data					
9.7.31	xDSL xTU-C performance monitoring history data part 2					
9.7.21	xDSL xTU-C performance monitoring history data					
9.7.24	xDSL xTU-R channel performance monitoring history data					
9.7.22	xDSL xTU-R performance monitoring history data					
9.2.16	XG-PON downstream management performance monitoring history data					
9.2.15	XG-PON TC performance monitoring history data					

Table 8-1 – Managed entities of the OMCI

Clause	Managed entity	ITU-T G.984, ITU-T G.987, ITU-T G.9807.1	ITU-T G.989	ITU-T G.986	IEEE 802.3, IEEE 802.3av	<u>ITU-T G.9804</u>
9.2.17	XG-PON upstream management performance monitoring history data					
9.7.36	xTU data gathering configuration					
9.4.6	IP host performance monitoring history data part 2					
9.1.18	ONU operational performance monitoring history data					
<u>9.12.20</u>	<u>BBF TR-369 USP agent</u>					

8.2 Managed entity relation diagrams

This clause shows the relationships between MEs. Unless indicated otherwise, Figures 8.2.1-1 to 8.2.1-3 illustrate G-PON access according to [ITU-T G.984.x] and [ITU-T G.987.x]. With suitable modifications, part or all of the same models may be used by other access technologies.

Although Figures 8.2.1-1 to 8.2.1-3 bear some resemblance to signal flows, it is important to recognize that they in fact illustrate the relationships among the entities of the management model.

Figure 8.2-1 gives the legend of symbols used in these diagrams. The name of the managed entity, sometimes abbreviated for ease of documentation, appears in each box, with the clause in which it is defined shown in the lower right corner.

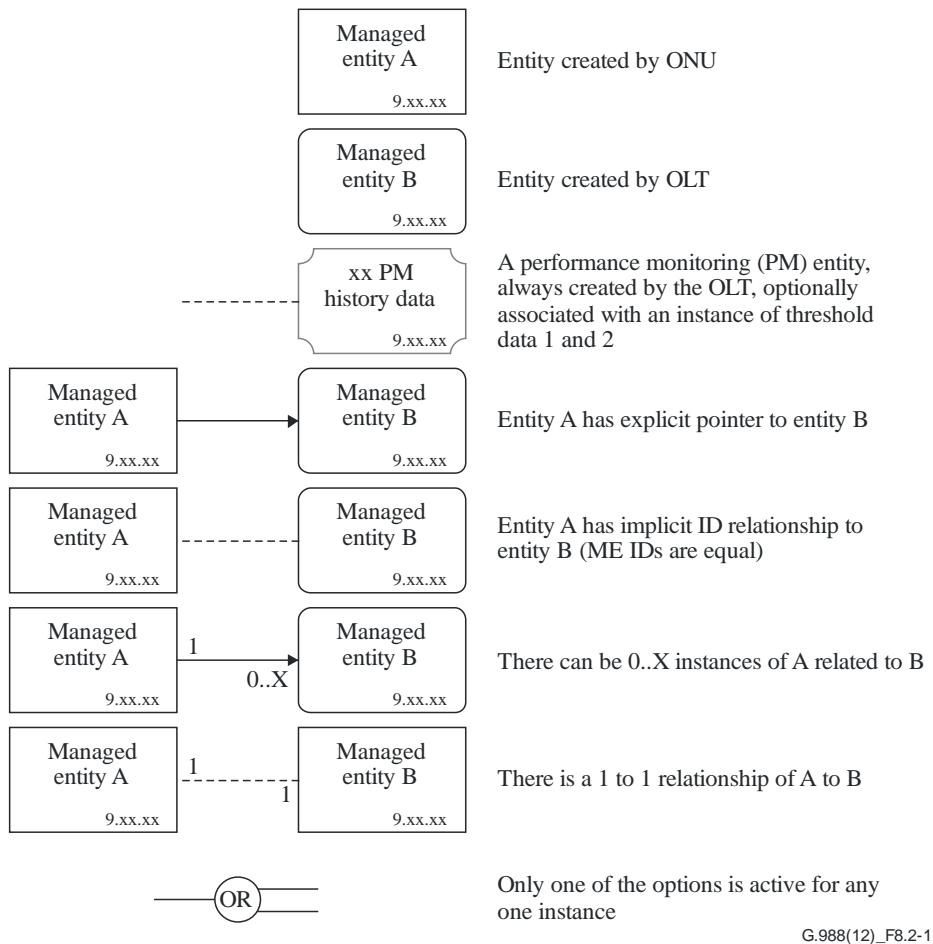

Figure 8.2-1 – Legend for managed entity relation diagrams

8.2.1 G-PON ONU common functions

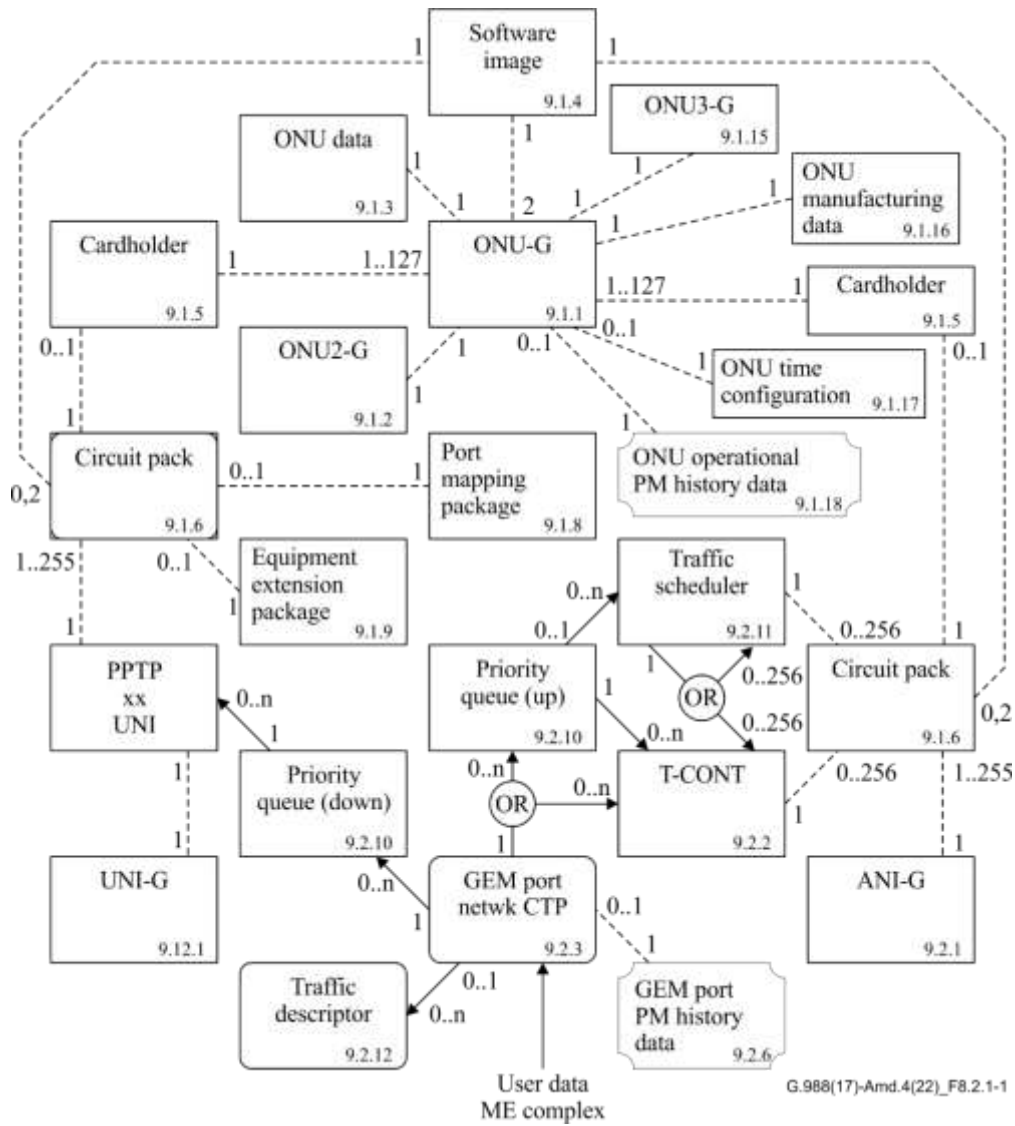

Figure 8.2.1-1 – G-PON ONU core

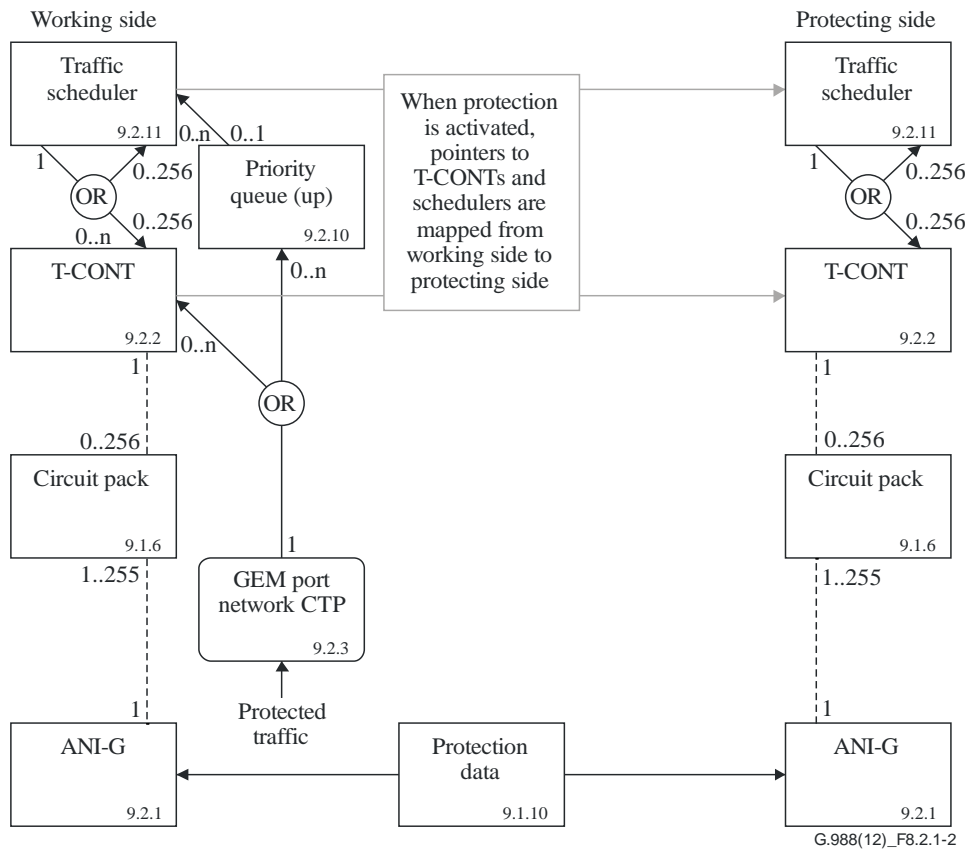

Figure 8.2.1-2 – 1+1 PON protection (G-PON)

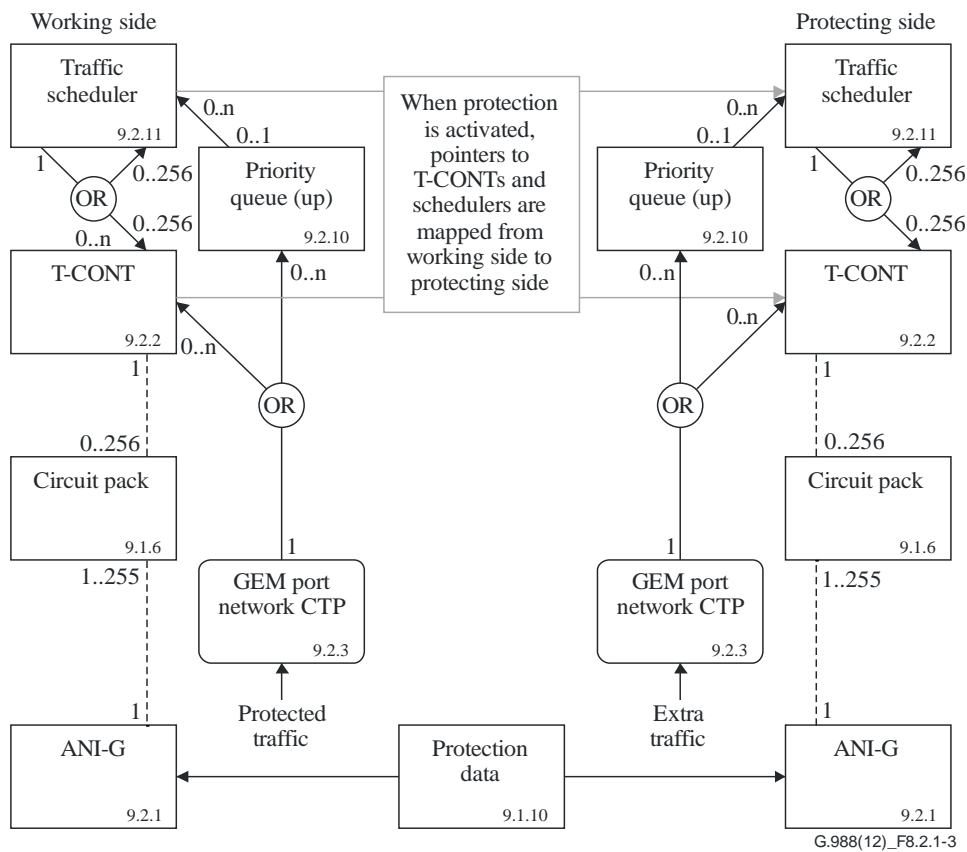

Figure 8.2.1-3 – 1:1 PON protection (G-PON)

8.2.2 Layer 2 functions

The OMCI supports two major layer 2 traffic mapping models: "MAC bridging and IEEE 802.1p mapping". MAC bridging is described in [IEEE 802.1D] and [IEEE 802.1Q]. The bridge illustrated in Figure 8.2.2-1 has many features, and can be used to direct traffic based on a MAC address (i.e., true bridging) or on virtual local area network (VLAN) characteristics (using the VLAN filter feature). The mapping function describes the steering of traffic from one UNI-side entity to 1-8 ANI-side ports, as shown in Figure 8.2.2-2. The mapper is equivalent to a MAC bridge with VLAN filters that only operate on the priority bits of the VLAN tags.

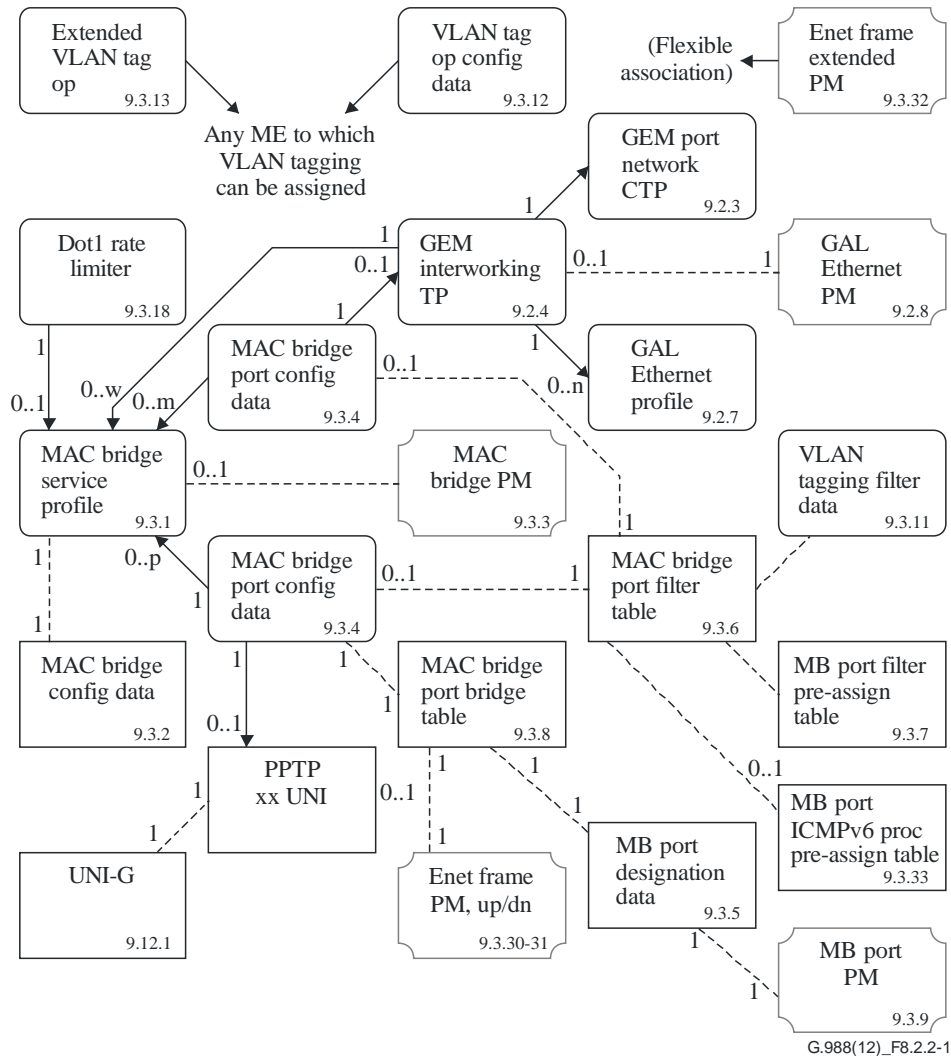

Figure 8.2.2-1 – MAC bridged LAN

NOTE – A bridge port may be associated with any IEEE 802.3 UNI, such as Ethernet or xDSL, or another IEEE 802.3 function such as an IP host config data ME.

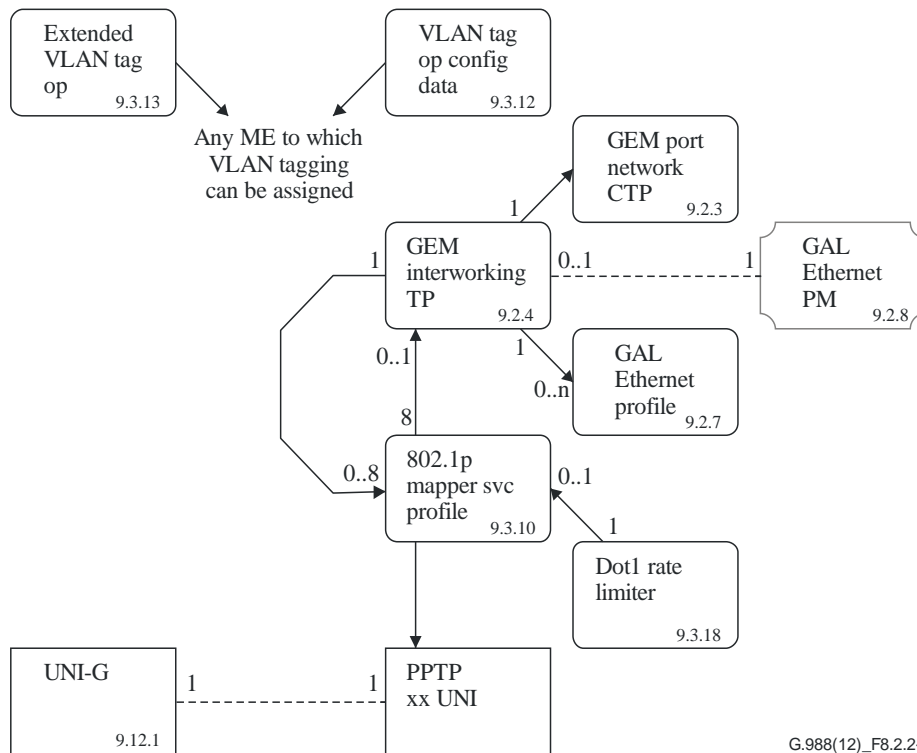

Figure 8.2.2-2 – MAC bridged LAN

NOTE – A mapper service profile may be associated with any IEEE 802.3 UNI, such as Ethernet or xDSL, or another IEEE 802.3 function such as an IP host config data ME.

The two basic layer 2 services can be used in various combinations to achieve different overall connectivities. There are three major functional styles of layer 2 connectivity, illustrated in Figures 8.2.2-3 to 8.2.2-5:

- N:1 bridging, where a bridge is used to serve multiple UNI ports from a single access network interface (ANI) service;
- 1:M mapping, where a mapper is used to serve a single UNI with multiple ANI connections, based on IEEE 802.1p priorities;
- 1:P filtering, where a bridge with filters is used to serve a single UNI with multiple ANI connections, based on some VLAN information other than IEEE 802.1p priorities.

Given these three basic possibilities, there are also four more complex combinations as well, illustrated in Figures 8.2.2-6 to 8.2.2-9. It is strongly encouraged that these applications be utilized before other, more exotic styles of usage.

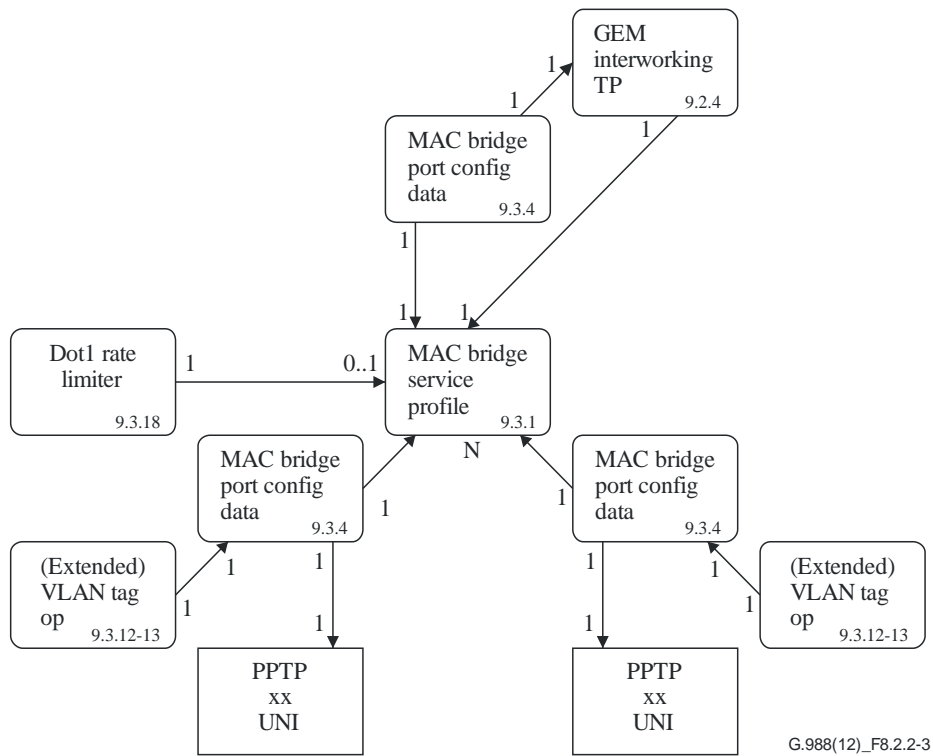

Figure 8.2.2-3 – Illustration of N:1 bridging

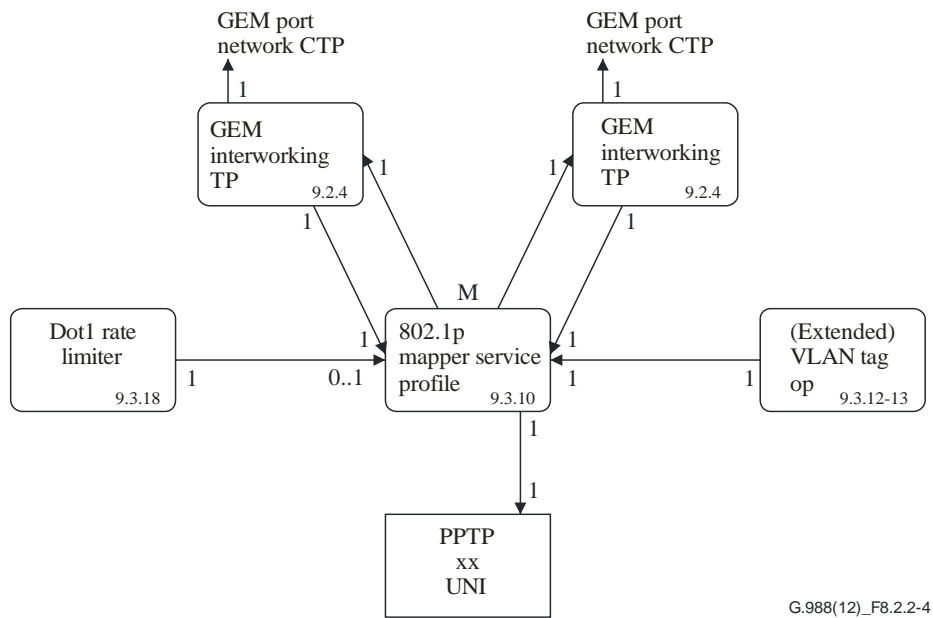

Figure 8.2.2-4 – Illustration of 1:M mapping

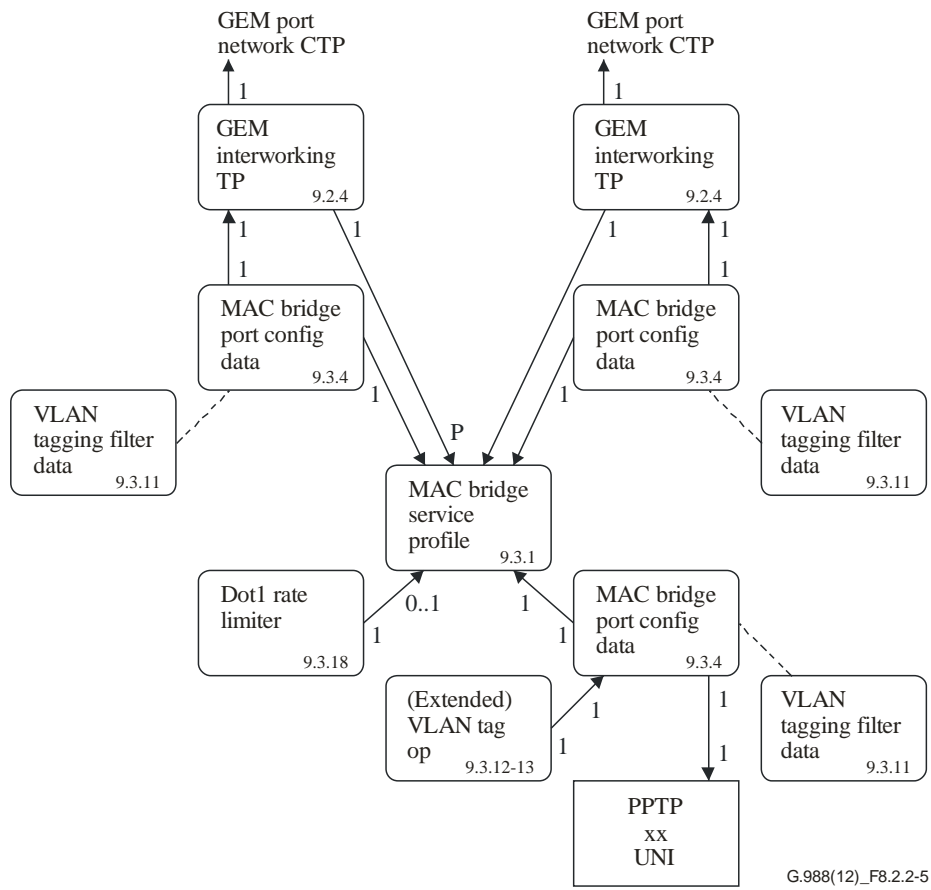
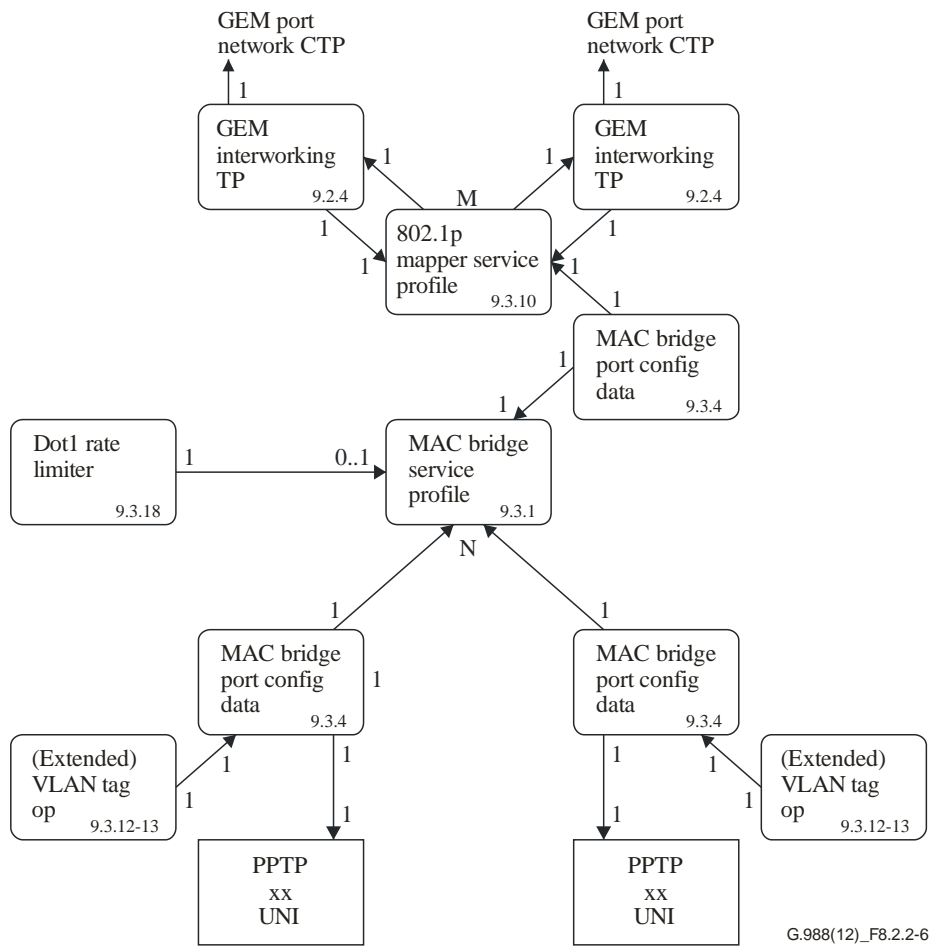

Figure 8.2.2-5 – Illustration of 1:P filtering



G.988(12)_F8.2.2-6

Figure 8.2.2-6 – Illustration of N:M bridge-mapping

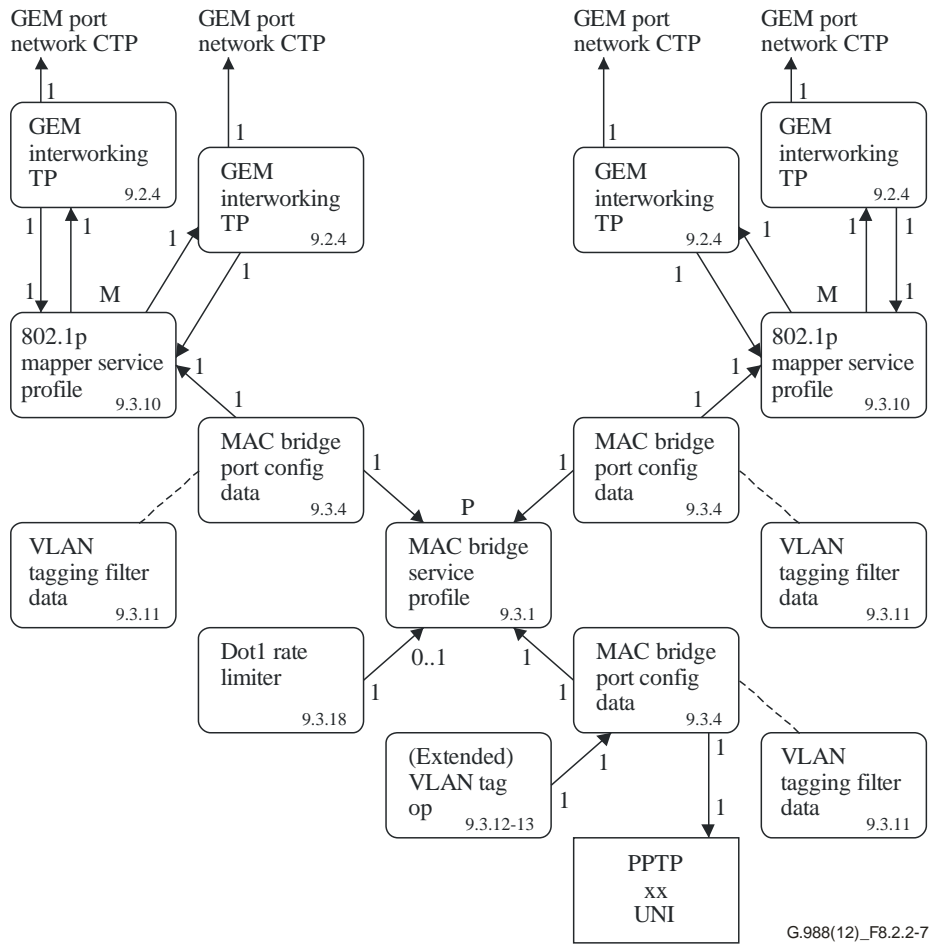

Figure 8.2.2-7 – Illustration of 1:MP map-filtering

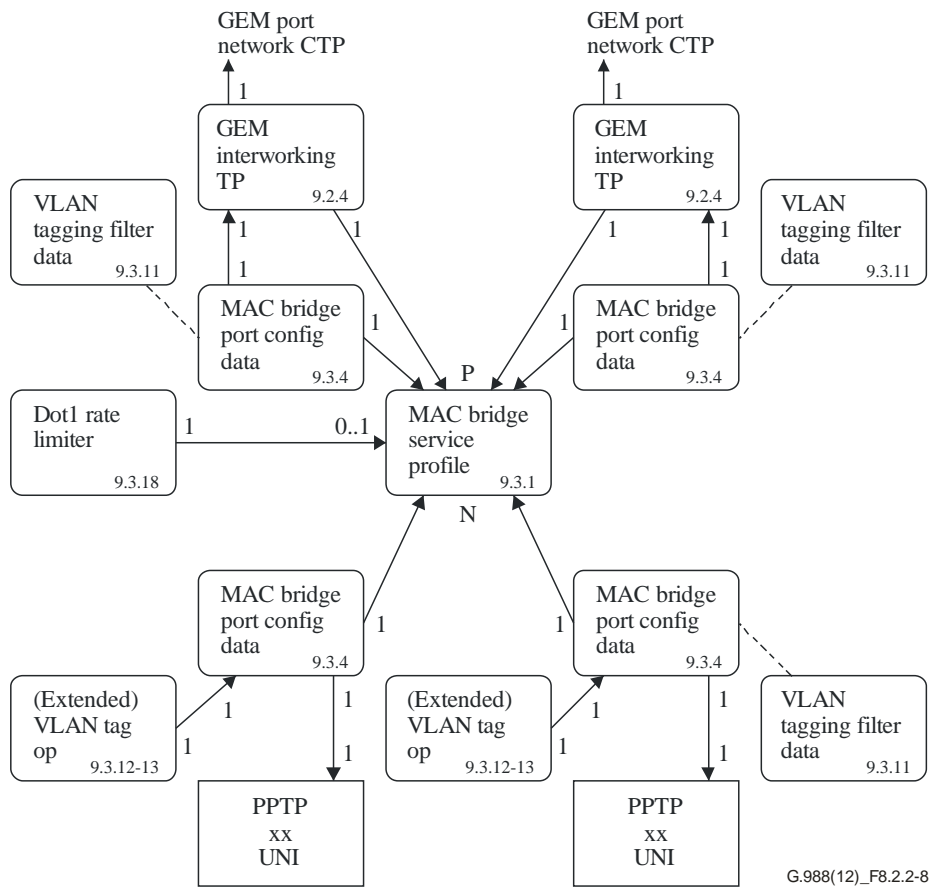

Figure 8.2.2-8 – Illustration of N:P bridge-filtering

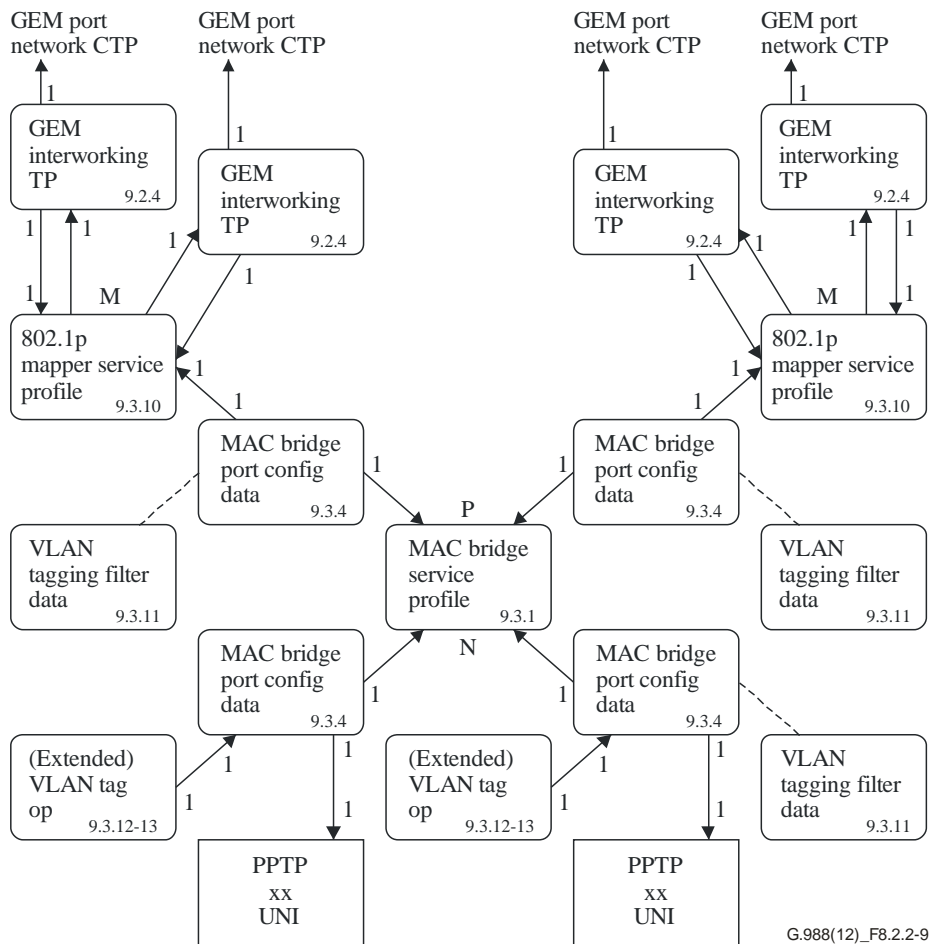

Figure 8.2.2-9 – Illustration of N:MP bridge-map-filtering

Figure 8.2.2-10 illustrates the use of the multicast IW TP. A bridge is used to multiplex the multiple ANI-side ports into the single (in this case) UNI-side port. It is essential to have a unicast path in parallel to the multicast path because the unicast path carries the upstream signalling that is required for control of multicast transmissions. In most scenarios, a unicast path already exists for other user communications.

Figure 8.2.2-11 illustrates the downstream broadcast configuration. Figure 8.2.2-12 illustrates [IEEE 802.1ag] in a MAC bridge model. Figure 8.2.2-13 illustrates [IEEE 802.1ag] in an IEEE 802.1p mapper model.

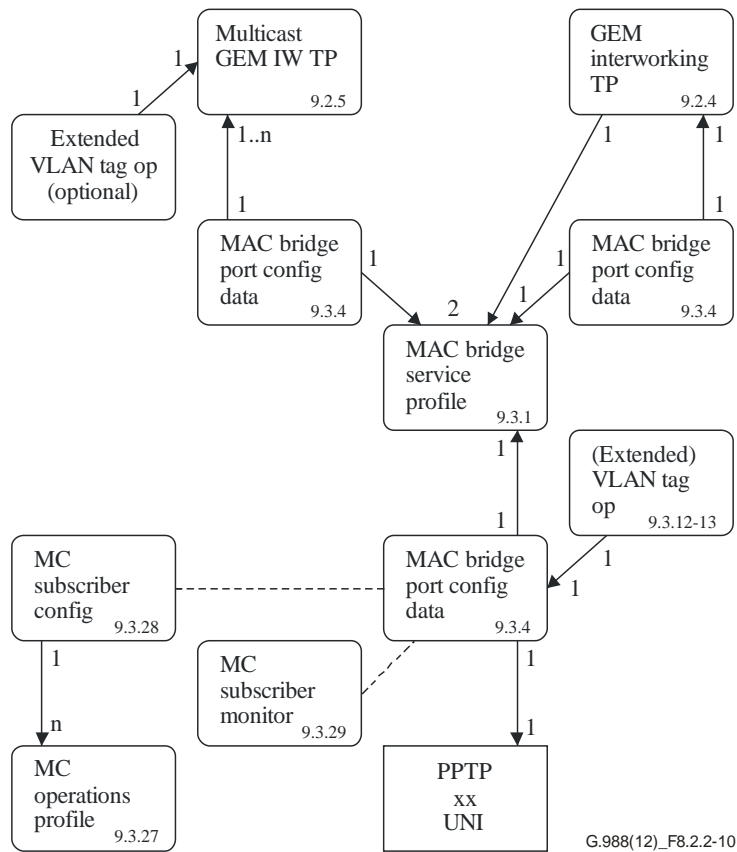
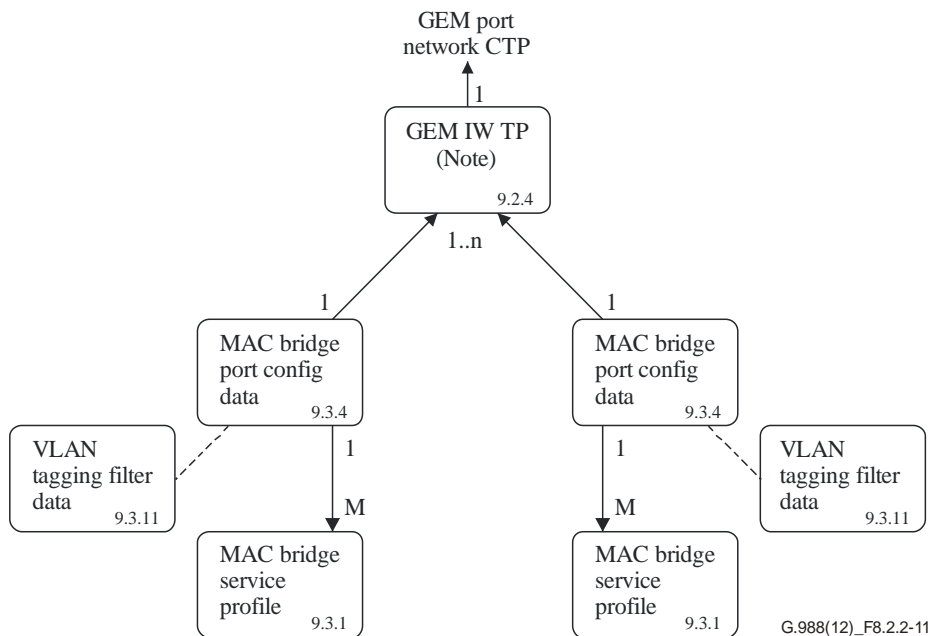

Figure 8.2.2-10 – Illustration of a multicast service



NOTE – IW option set to downstream broadcast.

Figure 8.2.2-11 – Illustration of the downstream broadcast configuration

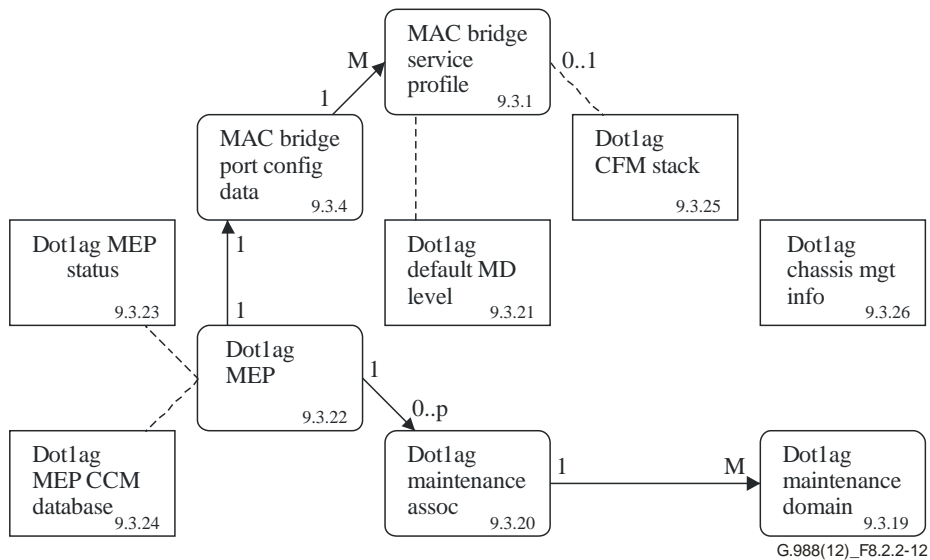
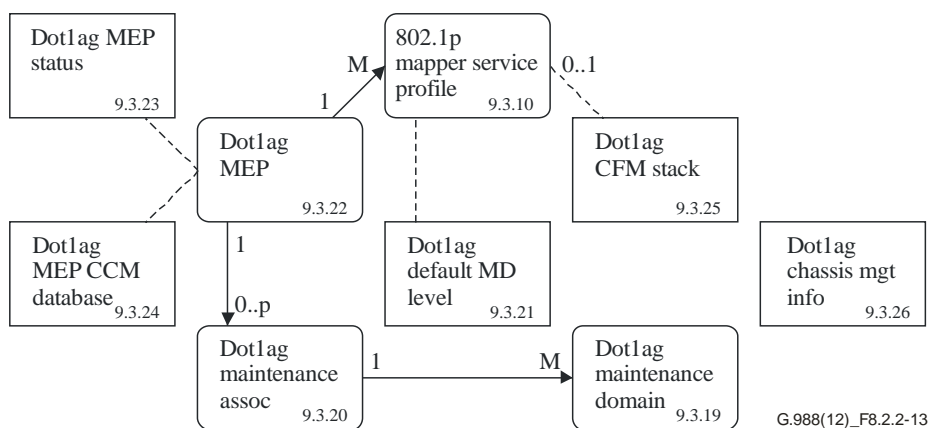

Figure 8.2.2-12 – Illustration of [IEEE 802.1ag] in a MAC bridge model



NOTE – If a mapper is associated with the ports of a bridge, the 802.1ag entities should be associated with the bridge and its ports, rather than with the mapper.

Figure 8.2.2-13 – Illustration of [IEEE 802.1ag] in an IEEE 802.1p mapper model

8.2.3 This clause is intentionally left blank

8.2.4 xDSL service

See Figures 8.2.4-1 and Figure 8.2.4-2.

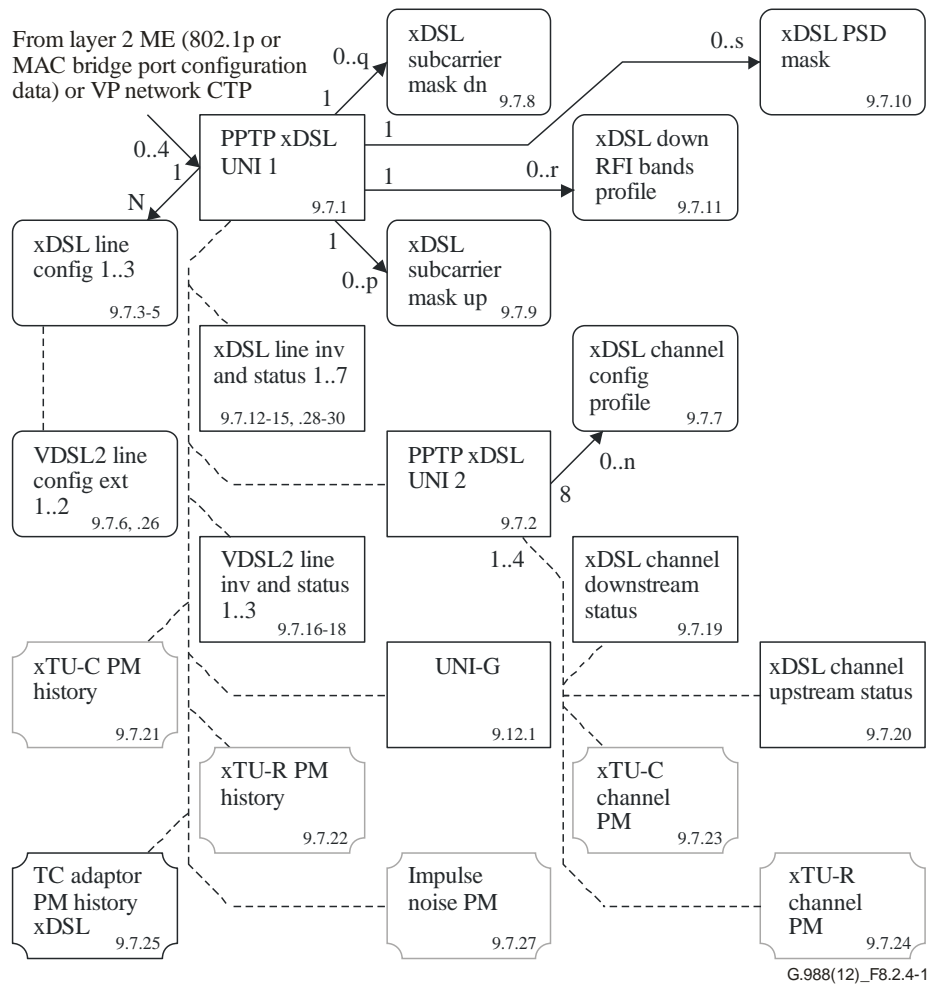
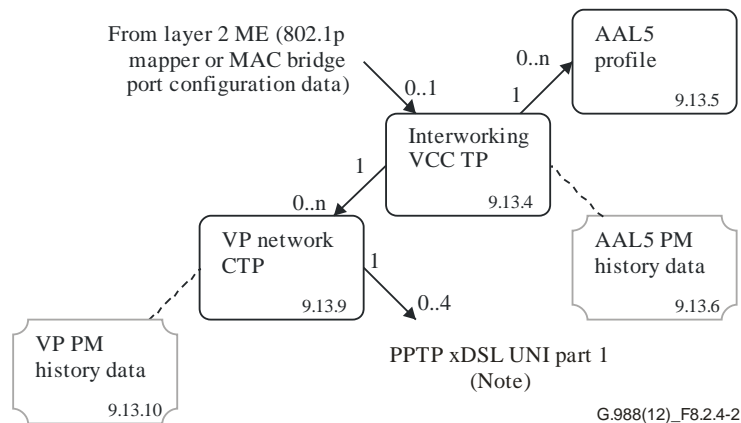

Figure 8.2.4-1 – xDSL



NOTE – Individual bearer channels accessible via two MSBs of PPTP ME ID.

Figure 8.2.4-2 – ATM interworking for xDSL

8.2.5 This clause is intentionally left blank

8.2.6 MoCA service

See Figure 8.2.6-1.

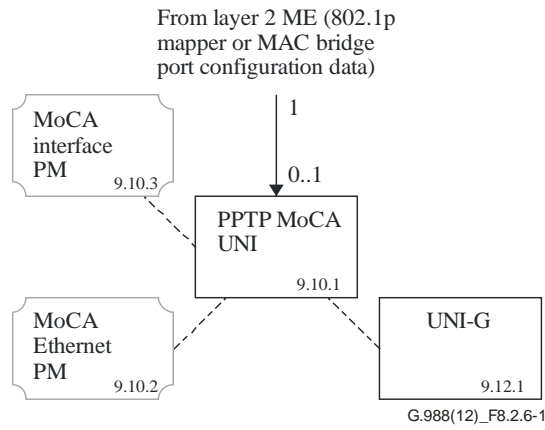
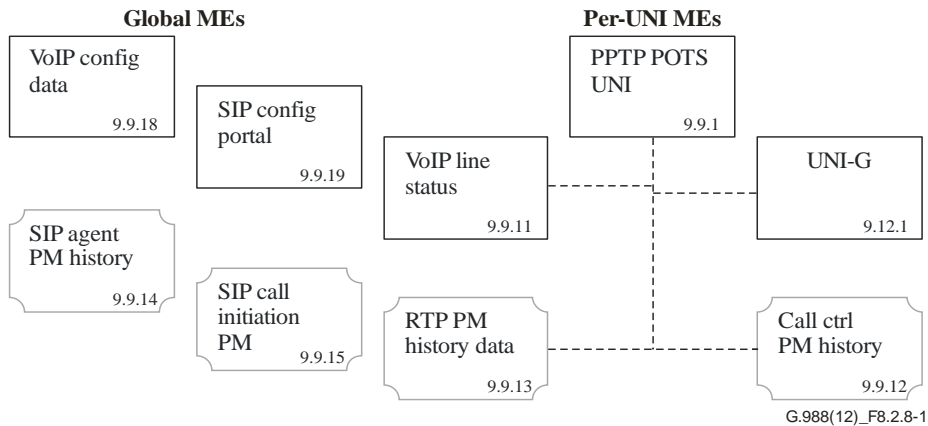

Figure 8.2.6-1 – Multimedia over Coax Alliance

8.2.7 This clause is intentionally left blank

8.2.8 VoIP service

See Figures 8.2.8-1 to 8.2.8-6.



NOTE – MEs that require long character strings point to large string MEs. MEs that require a network address point to network address MEs.

Figure 8.2.8-1 – IP-path managed SIP VoIP

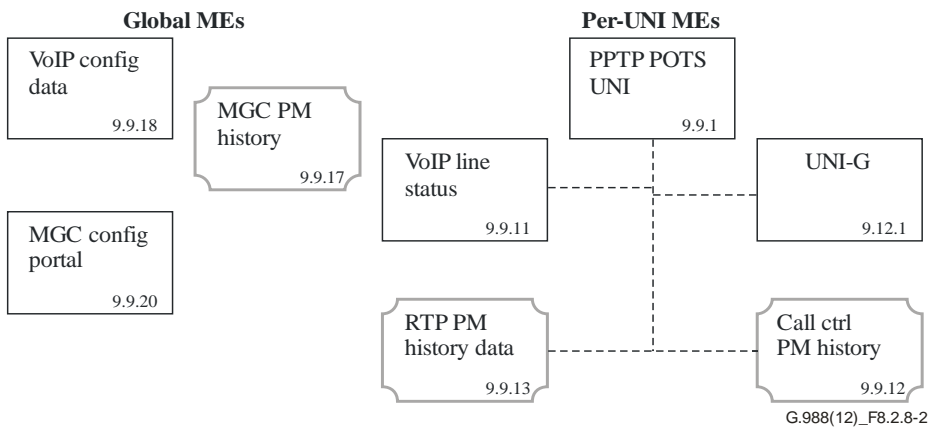

NOTE – MEs that require long character strings point to large string MEs. MEs that require a network address point to network address MEs.

Figure 8.2.8-2 – IP path managed ITU-T H.248 VoIP

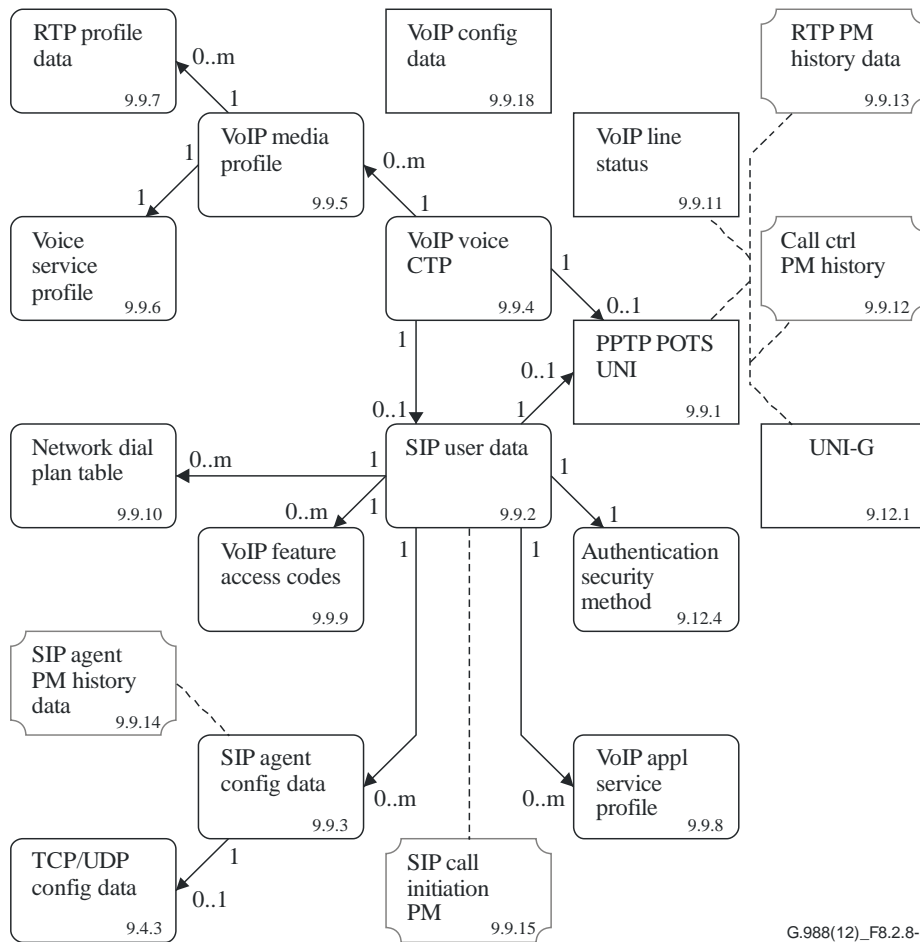

G.988(12)_F8.2.8-3

NOTE – MEs that require long character strings point to large string MEs. MEs that require a network address point to network address MEs.

Figure 8.2.8-3 – OMCI managed SIP VoIP

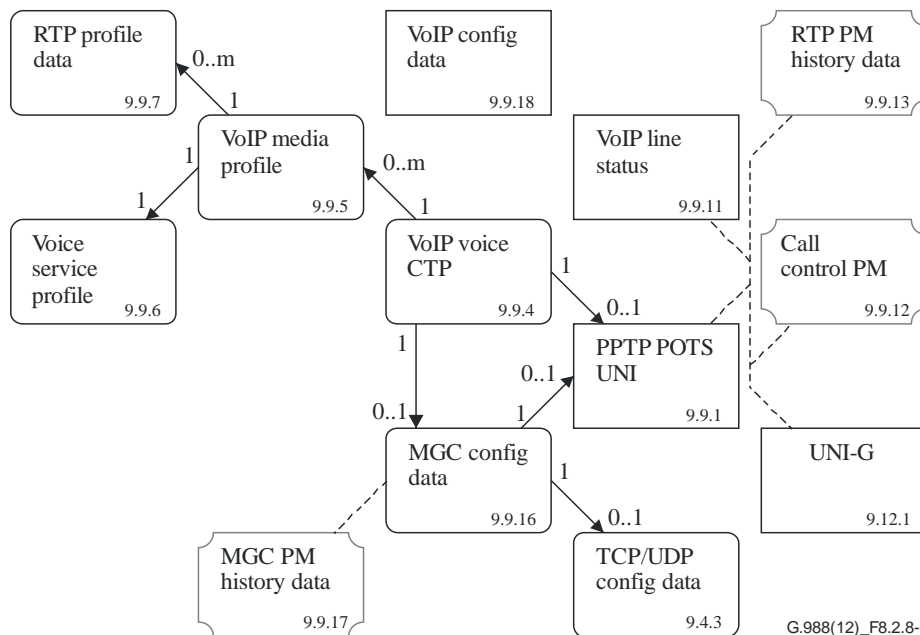

G.988(12)_F8.2.8-4

NOTE – MEs that require long character strings point to large string MEs. MEs that require a network address point to network address MEs.

Figure 8.2.8-4 – OMCI managed ITU-T H.248 VoIP

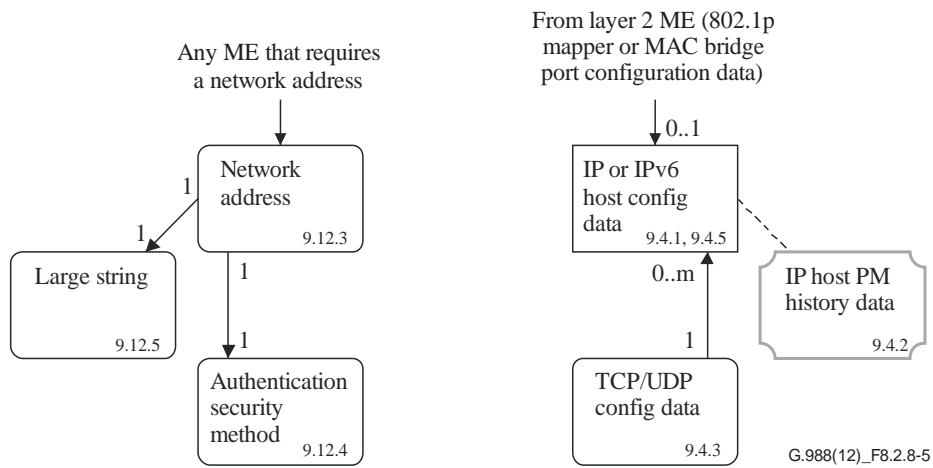
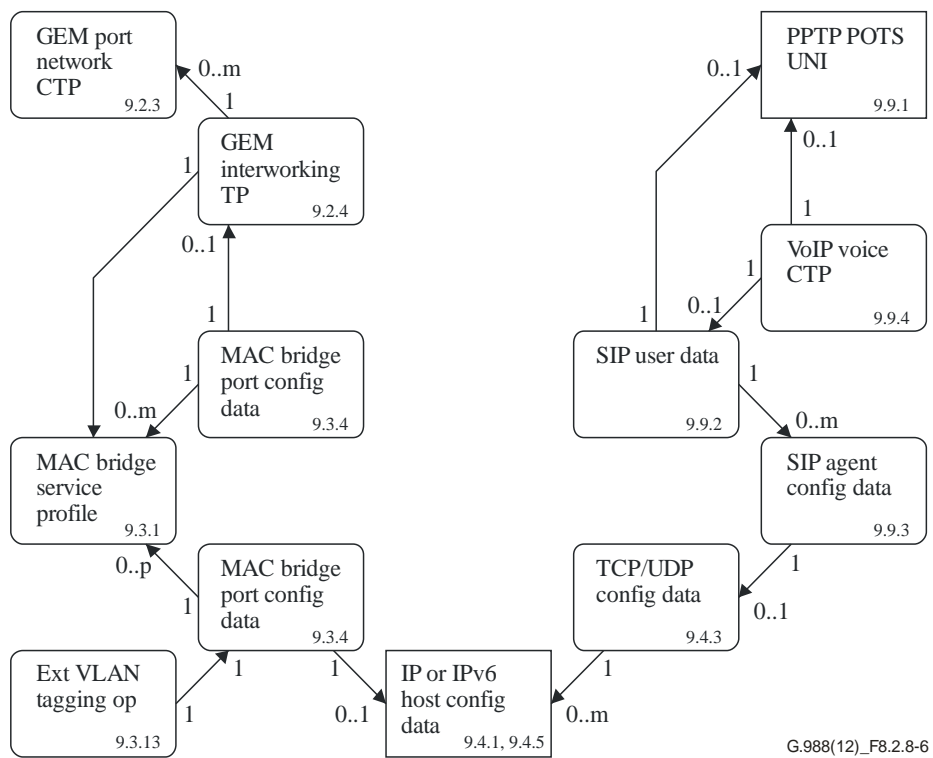

Figure 8.2.8-5 – Common IP services



NOTE – ITU-T H.248 connectivity is very similar to this SIP example.

Figure 8.2.8-6 – VoIP connectivity

8.2.9 Pseudowire service

See Figures 8.2.9-1 to 8.2.9-3.

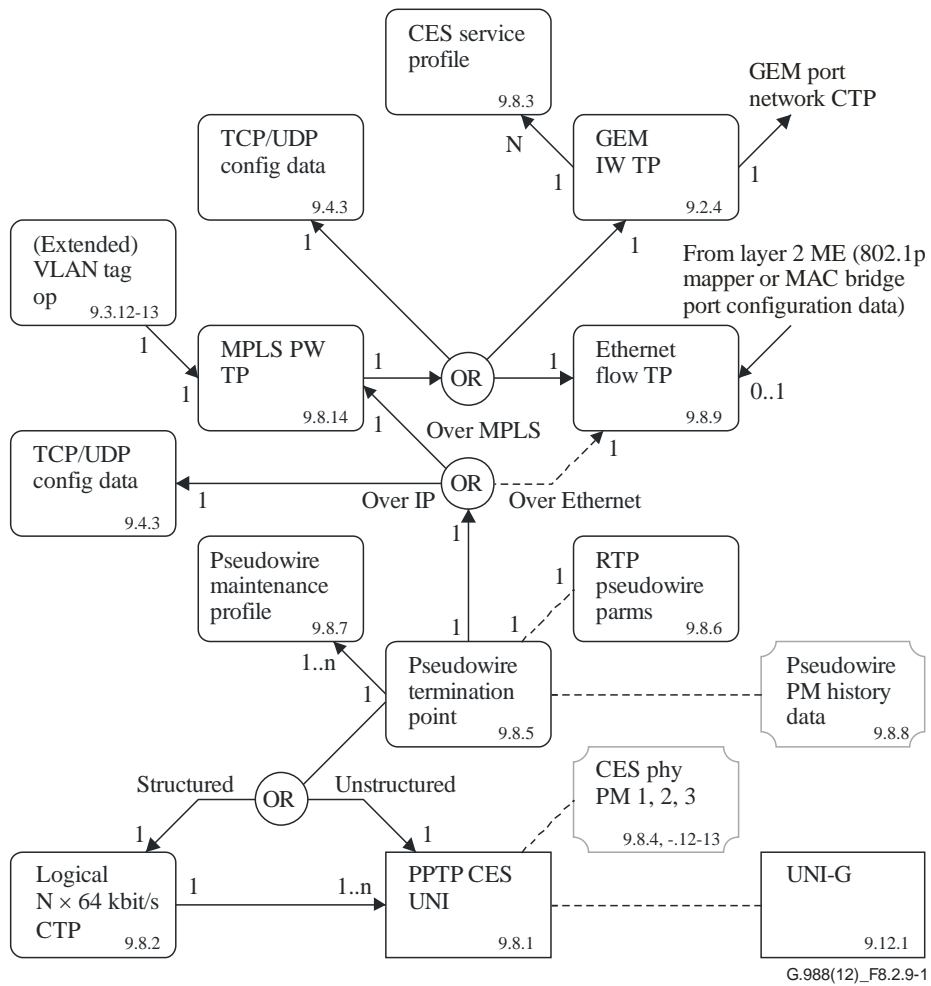

Figure 8.2.9-1 – Time division multiplex pseudowire

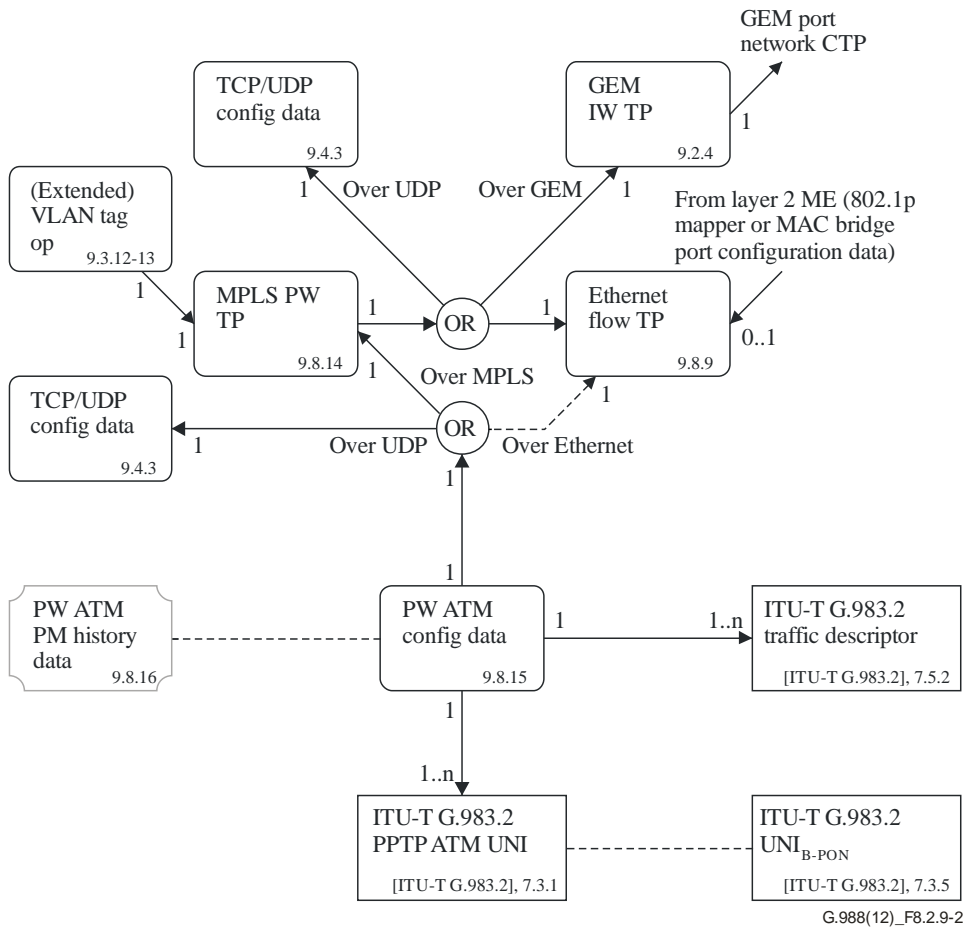

Figure 8.2.9-2 – ATM pseudowire

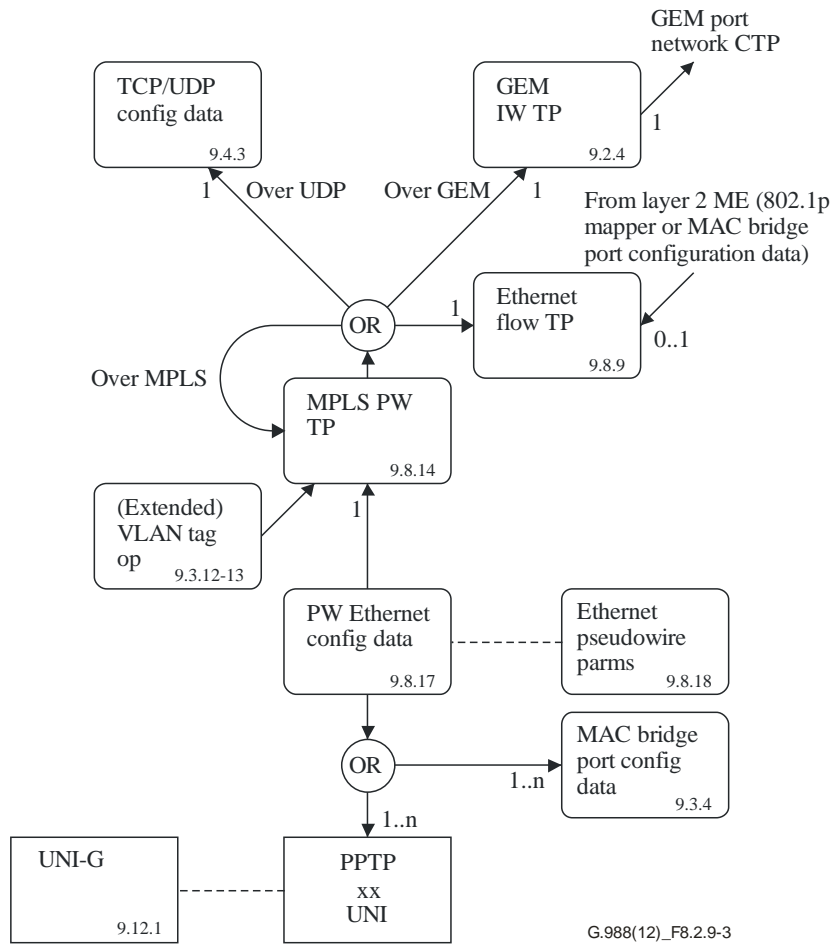
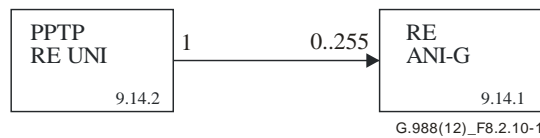

Figure 8.2.9-3 – Ethernet pseudowire

8.2.10 Mid-span PON reach extenders

The PON RE is modelled as an ONU (the management entity) containing cardholders and circuit packs whose functions are to extend the reach of one or more PONs. The management ONU of the PON RE is understood to exist as a member of one of the extended PONs. See Figures 8.2.10-1 to 8.2.10-5.



NOTE – In many cases, the RE ANI-G and PPTP RE UNI are implemented on the same circuit pack. If so, the port-mapping package can be used to create the hybrid line card.

Figure 8.2.10-1 – Mid-span PON reach extender core (repeater)

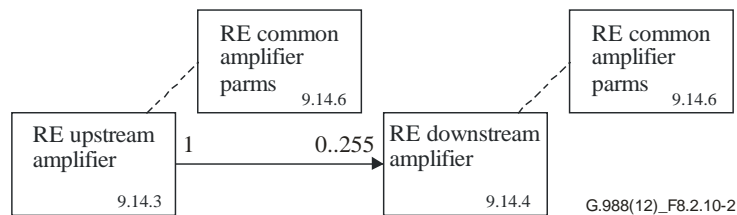

NOTE – In many cases, the RE upstream amplifier and RE downstream amplifier are implemented on the same circuit pack. If so, the port-mapping package can be used to create the hybrid line card.

Figure 8.2.10-2 – Mid-span PON reach extender core (optical amplifier)

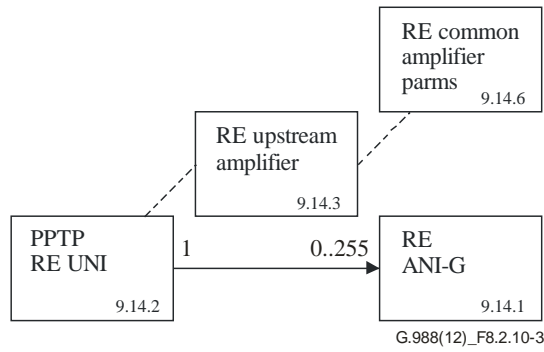

Figure 8.2.10-3 – Mid-span upstream PON reach extender core (hybrid)

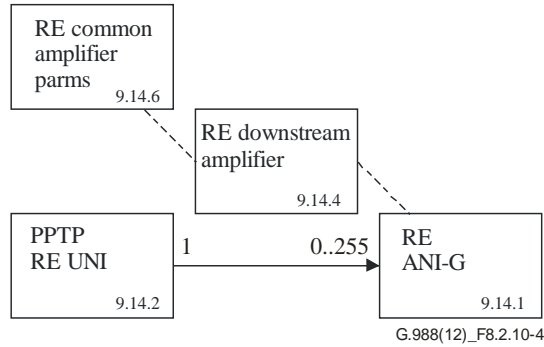

Figure 8.2.10-4 – Mid-span downstream PON reach extender core (hybrid)

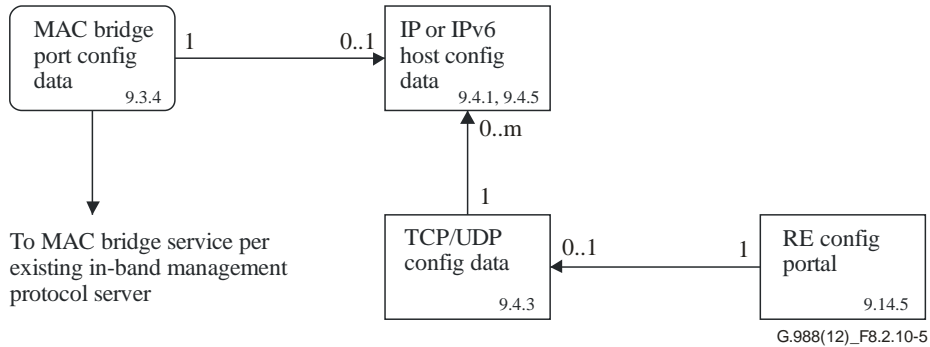

Figure 8.2.10-5 – In-band management for the mid-span PON reach extender

8.2.11 Point-to-point gigabit Ethernet fed ONU

See Figure 8.2.11-1.

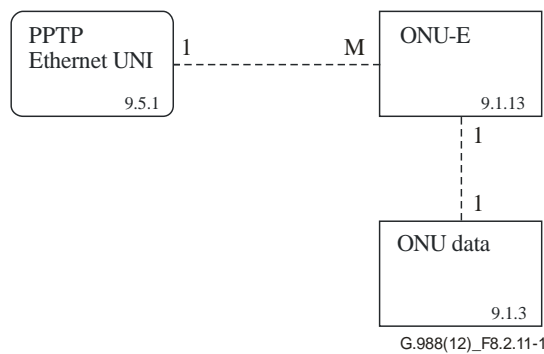
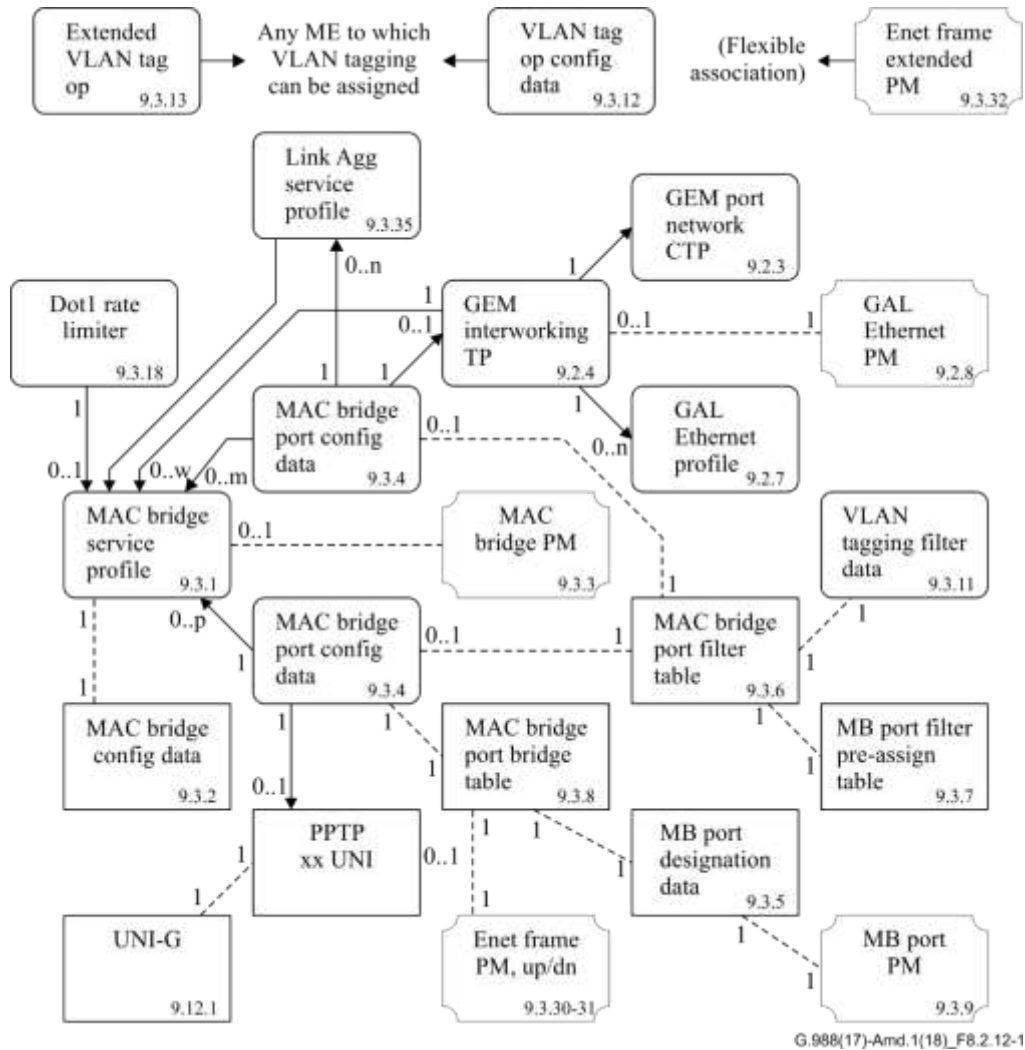

Figure 8.2.11-1 – P2P GbE-fed ONU

8.2.12 Link aggregation service profile

In the LAG-based channel bonding, traffic to a LAG group goes to multiple GEM ports and multiple ANI-G interfaces. When the LAG-based channel bonding is employed, multiple MAC bridge port configuration data MEs point to a link aggregation service profile (LASP) ME.

See Figure 8.2.12-1.



G.988(17)-Amd.1(18)_F8.2.12-1

Figure 8.2.12-1 – Link aggregation

9 MIB description

This clause defines all ONU MEs of interest to the Recommendations that subscribe to it. Recognizing the heritage of the OMCI through [ITU-T G.983.2], code points for a number of MEs are permanently reserved for legacy implementations. In a few cases, MEs defined in earlier Recommendations have proven to be of little interest. As reserved code points, such MEs remain available for use in new applications, if needed, but their definitions appear only in the original Recommendations.

ME descriptions include:

- The purpose of the entity.
- The relationships of the ME with other MEs.
- The attributes of the entity, an ordered list that specifies both syntax and semantics.

- d) The management operations (actions) that may be performed on the entity. Generic actions such as create, delete, get, get next, set and get current data are merely listed in the description of a given ME; details appear in Annex A. Specialized actions are described in more detail in the ME description itself.
- e) The notifications generated by the ME. These may be attribute value changes (AVCs), alarms or performance monitoring threshold crossing alerts (TCAs). Tables define each of these three classes as needed for each ME type.

These clauses are organized as follows.

- 9.1 Equipment management
- 9.2 ANI management, traffic management
- 9.3 Layer 2 data services
- 9.4 Layer 3 data services
- 9.5 Ethernet services
- 9.6 This clause is intentionally left blank
- 9.7 xDSL services
- 9.8 Time division multiplex services
- 9.9 Voice services
- 9.10 Premises networks
- 9.11 This clause is intentionally left blank
- 9.12 General purpose managed entities
- 9.13 Miscellaneous services
- 9.14 Mid-span passive optical network reach extender

Attribute access

Some MEs are instantiated by the ONU autonomously. Others are instantiated on explicit request of the OLT via a create command, and a few ME types may be instantiated in either way, depending on the ONU architecture or circumstances.

Attributes of an ME that is auto-instantiated by the ONU can be read (R), write (W), or read, write (R, W).

On the other hand, attributes of a ME that is instantiated by the OLT can be either (R), (W), (R, W), (R, set-by-create) or (R, W, set-by-create). Where appropriate, this Recommendation specifies a default value, to be assigned to the attribute on instantiation of the ME.

The following explains each case in more detail:

- (R): At instantiation or initialization, the ONU sets the attribute to a default value or to a value that reflects a current state or measurement. During continued operation, the ONU may update the value of the attribute to reflect state or measurement changes. The OLT can only read the value of the attribute. In the case of an autonomous AVC, the ONU may send an AVC notification to the OLT.
- (W): The OLT can only write the value of this attribute type. An attribute of this type is typically used to trigger an action in the ONU. Such an attribute never triggers an AVC notification to the OLT.

- (R, W): On instantiation of the ME, either autonomously or on request of the OLT via a create action, the ONU sets the attribute to a default value. The OLT can both read and write the value of the attribute. In the case of an autonomous AVC, the ONU may send an AVC notification to the OLT.
- (R, set-by-create): On instantiation of the ME, by necessity on request of the OLT via a create action, the ONU sets the attribute to the value specified in the create command. Subsequently, the OLT cannot change the value of the attribute. This combination is used mostly for ME IDs, but occasionally for other attributes that cannot meaningfully change after ME creation.
- (RW, set-by-create): On instantiation of the ME, by necessity on request of the OLT via a create action, the ONU sets the attribute to the value specified in the create command. Subsequently, the OLT can both read and write the value of the attribute. In the case of an autonomous AVC, the ONU may send an AVC notification to the OLT. In a number of cases, it is logically impossible to change (write) the value of an attribute after the ME has been created. However, chicken and egg issues can arise when several such MEs point to each other. Allowing such attributes to be set after creation is intended to avoid these issues.

Managed entity identifiers

The identifier (ID) of an ME may be a fixed value, stated in its definition. The ME ID may be specified as 0 when the ME is instantiated automatically and there is only one. The ONU-G ME is a good example of this class. In other cases, the definition of an ME specifies a rule for the assignment of an ME ID, such as a slot-port model.

When an ME is created by the OLT, and its ME ID is unconstrained by the ME definition in clause 9, it is preferred to avoid ME IDs 0 and 0xFFFF, which create ambiguity in pointers that may need to refer to the ME.

Likewise, when an ME is created by the ONU, and its ME ID is free for the ONU to choose, the ONU should avoid ME IDs 0 and 0xFFFF.

Optional pointers

In many cases, populating a pointer attribute may be optional (a prime example being the threshold data 1/2 ID attribute). When this happens, it is useful to be able to specify a null pointer in the OMCI. Because the OLT defines the pointers and the MEs to which they point, if the OLT has the intention to not populate the optional pointer, it can do so by filling in any value that does not correspond to an ME that exists. The ONU can determine that the pointer points to nothing, and is therefore null. Both 0 and 0xFFFF are often used by convention to designate a null pointer, but especially the value 0 can sometimes be a valid ME ID, so this convention should be used judiciously.

Interdependent attribute handling

Some attributes within an ME are interdependent. For example, attribute B may be used to enable/disable the use of attribute A. In these cases, it is recommended that the OLT provision the dependent attribute (A) first or in the same set message. If the attributes are provisioned in an order that causes the use of an unprovisioned attribute with no well-defined default, the OLT cannot necessarily expect an error indication from the ONU and the correct operation of the ONU cannot be guaranteed. In most cases, default values are defined in clause 9 to minimize the risk of this event.

Notifications

The notifications generated by a ME stem from the following events: alarms, AVCs, TCAs and test results.

Alarms, TCAs and failures of autonomous self-tests are all reported via alarm messages. The alarm-reporting message contains a field of 224 bits, which is mapped to as many as 208 specific alarms by the definition of each ME. The last 16 bits are reserved for vendor-specific alarms and are not to be standardized. Alarm bits are numbered from 0 upwards. The general schema is illustrated in the following table, where each ME definition may specify some of the 208 reserved points for its own alarms. Different ME types can reuse the same code points because the alarm report message includes the ME type (and instance).

Generic alarm bit assignment

Alarm number	Alarm	Description
0..207	Reserved	
208..223	Vendor-specific alarms	Not to be standardized

AVCs are reported via AVC messages. An ME cannot encompass more than 16 attributes, in addition to its ME ID, and the AVC message contains a bit map of 16 bits that match the attributes in order, starting with 1. If an ME can generate AVCs, its definition includes an AVC table that matches attributes with their corresponding bit numbers for easy reference. Attributes that do not trigger AVC notifications are shown as N/A, while bit positions for non-existent attributes are shown as reserved.

Test results are reported:

- a) via an expected test result message if the test is invoked by a test command from the OLT;
or
- b) via an autonomous test result message if a test failure is detected autonomously by the ONU;
or
- c) via an alarm message in the case of autonomous self-test failure in the start-up phase.

Details of these messages and their coding appear in Annex A.

IPv6 address representation

The OMCI management information model was developed in the context of IPv4, which uses 4 byte addresses. IPv6 requires 16 bytes to fully represent an address. It is undesirable to define completely new MEs for IPv6, and both versions are likely to coexist for some time.

It is observed that 0.0.x.y is not a valid IPv4 address, although 0.0.0.0 may appear occasionally, for example in Internet group management protocol (IGMP) messages.

This Recommendation specifies that, for any 4 byte attribute defined as an IP address, mask or gateway, if the value is 0.0.x.y, where x and y are not both 0, then x.y is to be interpreted as a pointer to a large string ME that represents an IPv6 address. The syntax of the representation is described in [b-IETF RFC 4291]. When explicitly allowed for an individual attribute, the large string may also contain a URI.

Usually, large strings are created and deleted by the OLT. For IPv6 address representation, the ONU may also need to create and delete a large string. To avoid numbering conflicts, it is recommended that the OLT number large strings from 1 upwards, while the ONU number auto-created large strings from 65 534 downwards.

MEs whose IP addresses are treated in accordance with this clause include:

- Dot 1X configuration profile;
- Multicast operations profile, querier IP address attribute. In this attribute, 0.0.0.0 is legal in IPv4;
- SIP agent config data, SIP domain name server (DNS) address attributes;
- SNMP configuration data.

The mechanism described in this clause is suitable for individual IPv6 address attributes, but it does not scale well for MEs that contain tables of IP addresses. Each of these MEs has its own definition of IPv6 treatment. In the future, any new MEs are to be defined with inbuilt IPv6 support.

9.1 Equipment management

An ONU may be physically implemented as a single module (integrated ONU) or as a shelf containing plug-in field-replaceable units (FRUs). An ONU containing FRUs always instantiates a cardholder ME for each of its physical slots; a cardholder can then be populated with a circuit pack. It is recommended that physical slots be numbered from left to right, then from bottom to top.

Because the cardholder ID (slot number) is used in the ME ID of many MEs, an integrated ONU may also be conveniently modelled with virtual cardholders and virtual circuit (VC) packs. When an ONU is modelled with virtual cardholders and circuit packs, it makes sense that all ports of a given VC pack have the same type, e.g., IEEE 802.3 Ethernet.

However, a physical circuit pack may have several port types, e.g., a PON ANI, a video UNI and a craft port. The port-mapping package provides a flexible way to associate port numbers with a heterogeneous assortment of ports.

In the same way, the port-mapping package supports an integrated ONU that is modelled without virtual cardholders. In such an ONU, ME IDs are assigned with the understanding that all MEs exist in cardholder 0.

9.1.1 ONU-G

This ME represents the ONU as equipment. The ONU automatically creates an instance of this ME. It assigns values to read-only attributes according to data within the ONU itself.

This ME has evolved from the ONT-G of [ITU-T G.984.4].

Relationships

In ITU-T GTC based PON applications, all other MEs in this Recommendation are related directly or indirectly to the ONU-G entity.

Attributes

Managed entity ID: This attribute uniquely identifies each instance of this ME. There is only one instance, number 0. (R) (mandatory) (2 bytes)

Vendor ID: This attribute identifies the vendor of the ONU. It is the same as the four most significant bytes of the ONU serial number as specified in the respective transmission convergence (TC) layer specification. (R) (mandatory) (4 bytes)

Version: This attribute identifies the version of the ONU as defined by the vendor. The character value 0 indicates that version information is not available or applicable. (R) (mandatory) (14 bytes)

Serial number: The serial number is unique for each ONU. It is defined in the respective TC layer specification and contains the vendor ID and version number. The first four bytes are an ASCII-encoded four-letter vendor ID. The second four bytes are a binary encoded serial number, under the control of the ONU vendor. (R) (mandatory) (8 bytes)

Traffic management option: This attribute identifies the upstream traffic management function implemented in the ONU. There are three options:

- 0 Priority controlled and flexibly scheduled upstream traffic. The traffic scheduler and priority queue mechanism are used for upstream traffic.
- 1 Rate controlled upstream traffic. The maximum upstream traffic of each individual connection is guaranteed by shaping.
- 2 Priority and rate controlled. The traffic scheduler and priority queue mechanism are used for upstream traffic. The maximum upstream traffic of each individual connection is guaranteed by shaping.

For a further explanation, see Appendix II.

Downstream priority queues are managed via the GEM port network CTP ME.

Upon ME instantiation, the ONU sets this attribute to the value that describes its implementation. The OLT must adapt its model to conform to the ONU's selection. (R) (mandatory) (1 byte)

Deprecated: This attribute is not used. If it is present, it should be set to 0. (R) (optional) (1 byte)

Battery backup: This Boolean attribute controls whether the ONU performs backup battery monitoring (assuming it is capable of doing so). *False* disables battery alarm monitoring; *true* enables battery alarm monitoring. (R, W) (mandatory) (1 byte)

Administrative state: This attribute locks (1) and unlocks (0) the functions performed by the ONU as an entirety. Administrative state is further described in clause A.1.6. (R, W) (mandatory) (1 byte)

Operational state: This attribute reports whether the ME is currently capable of performing its function. Valid values are enabled (0) and disabled (1). (R) (optional) (1 byte)

ONU survival time: This attribute indicates the minimum guaranteed time in milliseconds between the loss of external power and the silence of the ONU. This does not include survival time attributable to a backup battery. The value zero implies that the actual time is not known. (R) (optional) (1 byte)

Logical ONU ID: This attribute provides a way for the ONU to identify itself. It is a text string, null terminated if it is shorter than 24 bytes, with a null default value. The mechanism for creation or modification of this information is beyond the scope of this Recommendation, but might include, for example, a web page displayed to a user. (R) (optional) (24 bytes)

Logical password: This attribute provides a way for the ONU to submit authentication credentials. It is a text string, null terminated if it is shorter than 12 bytes, with a null default value. The mechanism for creation or modification of this information is beyond the scope of this Recommendation. (R) (optional) (12 bytes)

Credentials status: This attribute permits the OLT to signal to the ONU whether its credentials are valid or not. The behaviour of the ONU is not specified, but might, for example, include displaying an error screen to the user. (R, W) (optional) (1 byte)

Values include:

- 0 Initial state, status indeterminate
- 1 Successful authentication

- 2 Logical ONU ID (LOID) error
 - 3 Password error
 - 4 Duplicate LOID
- Other values are reserved.

Extended TC-layer options: This attribute is meaningful in ITU-T G.984 systems only. It is a bit map that defines whether the ONU supports (1) or does not support (0) various optional TC-layer capabilities of [ITU-T G.984.3]. Bits are assigned as follows.

Bit	Meaning
1 (LSB)	Annex C of [ITU-T G.984.3], PON-ID maintenance.
2	Annex D of [ITU-T G.984.3], PLOAM channel enhancements: swift_POPUP and Ranging_adjustment messages.
3..16	Reserved

(R) (optional) (2 bytes)

Actions

Get, set

Reboot: Reboot the ONU.

Test: Test the ONU. The test action can be used either to perform equipment diagnostics or to measure parameters such as received optical power, video output level, battery voltage, etc. Test and test result messages are defined in Annex A.

Synchronize time: This action synchronizes the start time of all PM MEs of the ONU with the reference time of the OLT. All counters of all PM MEs are cleared to 0 and restarted. Also, the value of the interval end time attribute of the PM MEs is set to 0 and restarted. See clause I.4 for further discussion of PM.

NOTE – This function is intended only to establish rough 15 min boundaries for PM collection. High precision time of day synchronization is a separate function, supported by the OLT-G ME.

Notifications

Test result: Test results are reported via a test result message if the test is invoked by a test command from the OLT.

Attribute value change

Number	Attribute value change	Description
1..7	N/A	
8	Op state	Operational state change
9	N/A	
10	LOID	Logical ONU ID
11	Lpw	Logical password
12..16	Reserved	

Alarm

Alarm number	Alarm	Description
0	Equipment alarm	Functional failure on an internal interface
1	Powering alarm	Loss of external power to battery backup unit. This alarm is typically derived through an external interface to a battery backup unit, and indicates that AC is no longer available to maintain battery charge.
2	Battery missing	Battery is provisioned but missing
3	Battery failure	Battery is provisioned and present but cannot recharge
4	Battery low	Battery is provisioned and present but its voltage is too low
5	Physical intrusion	Applies if the ONU supports detection such as door or box open
6	ONU self-test failure	ONU has failed autonomous self-test
7	Dying gasp	ONU is powering off imminently due to loss of power to the ONU itself. This alarm may be sent in conjunction with the powering alarm if the backup unit cannot supply power and the ONU is shutting down.
8	Temperature yellow	No service shutdown at present, but the circuit pack is operating beyond its recommended range.
9	Temperature red	Some services have been shut down to avoid equipment damage. The operational state of the affected PPTPs indicates the affected services.
10	Voltage yellow	No service shutdown at present, but the line power voltage is below its recommended minimum. Service restrictions may be in effect, such as permitting no more than <i>N</i> lines off-hook or ringing at one time.
11	Voltage red	Some services have been shut down to avoid power collapse. The operational state of the affected PPTPs indicates the affected services.
12	ONU manual power off	The ONU is shutting down because the subscriber has turned off its power switch.
13	Inv-Image	Software image is invalid (Note)
14	PSE overload yellow	Indicates that the ONU is nearing its maximum ability to supply the known PoE demand of the attached PDs. The thresholds for declaring and clearing this alarm are vendor-specific.

Alarm

Alarm number	Alarm	Description
15	PSE overload red	Indicates that the ONU is unable to supply all of the PoE demand of the attached PDs and has removed or reduced power to at least one PD.
16..207	Reserved	
208..223	Vendor-specific alarms	Not to be standardized
NOTE – The ONU should declare this alarm only outside the software download process.		

9.1.2 ONU2-G

This ME contains additional attributes associated with a PON ONU. The ONU automatically creates an instance of this ME. Its attributes are populated according to data within the ONU itself.

This ME is the same as the ONT2-G of [ITU-T G.984.4], with extensions.

Relationships

This ME is paired with the ONU-G entity.

Attributes

Managed entity ID: This attribute uniquely identifies each instance of this ME. There is only one instance, number 0. (R) (mandatory) (2 bytes)

Equipment ID: This attribute may be used to identify the specific type of ONU. In some environments, this attribute may include the common language equipment identification (CLEI) code. (R) (optional) (20 bytes)

Optical network unit management and control channel (OMCC) version: This attribute identifies the version of the OMCC protocol being used by the ONU. This allows the OLT to manage a network with ONUs that support different OMCC versions. Release levels of [ITU-T G.984.4] are supported with code points of the form 0x8y and 0x9y, where y is a hexadecimal digit in the range 0..F. Support for continuing revisions of this Recommendation is defined in the 0xAy and 0xBy range.

NOTE 1 – The complete list of managed entities supported by an ONU cannot be derived from the OMCC version attribute. Refer to other ITU-T G.988 OMCI mechanisms for deriving this information (clause I.1.1.1 which describes the use of clauses 9.12.9 Managed entity and 9.12.10 Attribute ME for retrieval of ITU-T G.988 supported ME, and clause I.1.2 for discovering the ONU hardware and service configuration of the ONU through MIB uploads.)

NOTE 2 – 0xBz values greater than B5 are reserved to report new ITU-T G.988 Annex A message versions (relative to ITU-T G.988 (2014) Amd1).

0x80 ITU-T G.984.4 (06/04)

NOTE – For historical reasons, this code point may also appear in ONUs that support later versions of [ITU-T G.984.4].

0x81 ITU-T G.984.4 2004 Amd.1 (06/05)

0x82 ITU-T G.984.4 2004 Amd.2 (03/06)

0x83 ITU-T G.984.4 2004 Amd.3 (12/06)

0x84	ITU-T G.984.4 2008 (02/08)
0x85	ITU-T G.984.4 2008 Amd.1 (06/09)
0x86	ITU-T G.984.4 2008 Amd.2 (2009). Baseline message set only, without the extended message set option
0x96	ITU-T G.984.4 2008 Amd.2 (2009). Extended message set option, in addition to the baseline message set.
0xA0	ITU-T G.988 (2010). Baseline message set only, without the extended message set option
0xA1	ITU-T G.988 Amd.1 (2011). Baseline message set only
0xA2	ITU-T G.988 Amd.2 (2012). Baseline message set only
0xA3	ITU-T G.988 (2012). Baseline message set only
<u>0xA4</u>	<u>ITU-T G.988 Amd. 1 (2014). Baseline message set only</u>
0xB0	ITU-T G.988 (2010). Baseline and extended message set
0xB1	ITU-T G.988 Amd.1 (2011). Baseline and extended message set
0xB2	ITU-T G.988 Amd.2 (2012). Baseline and extended message set
0xB3	ITU-T G.988 (2012). Baseline and extended message set
0xB4	ITU-T G.988 Amd1 (2014) Baseline and extended message set
0xB5	Do not use

(R) (mandatory) (1 byte)

Vendor product code: This attribute contains a vendor-specific product code for the ONU.

(R) (optional) (2 bytes)

Security capability: This attribute advertises the security capabilities of the ONU. The following code points are defined:

0	Reserved
1	Advanced encryption standard-128 (AES-128) payload encryption supported
2	<u>Reserved</u>
3	<u>AES-128 and AES-256 payload encryption supported</u>
4...6	<u>Reserved</u>
7	<u>AES-128, AES-256, and Camellia-128 payload encryption supported</u>
8...10	<u>Reserved</u>
11	<u>AES-128, AES-256, and Camellia-256 payload encryption supported</u>
12...14	<u>Reserved</u>
15	<u>AES-128, AES-256, Camellia-128 and Camellia-256 payload encryption supported</u>
16-18	<u>Reserved</u>
19	<u>AES-128, AES-256, and SM4(-128) payload encryption supported</u>
20...22	<u>Reserved</u>
23	<u>AES-128, AES-256, SM4(-128), and Camellia-128 payload encryption supported</u>
24...26	<u>Reserved</u>
27	<u>AES-128, AES-256, SM4(-128), and Camellia-256 payload encryption supported</u>
28...30	<u>Reserved</u>
31	<u>AES-128, AES-256, SM4(-128), Camellia-128, and Camellia-256 payload encryption supported</u>
32..255	<u>Reserved</u>

(R) (mandatory) (1 byte)

NOTE – Reporting of value 1 is not valid for ITU-T G.9804 ONU.

Security mode: This attribute specifies the current security mode of the ONU. All secure (X)GEM ports in an ONU must use the same security mode at any given time. The following code points are defined:

0	Reserved
1	AES-128 algorithm
2	<u>AES-256 algorithm</u>
3	<u>Camellia-128 algorithm</u>
4	<u>Camellia-256 algorithm</u>
5	<u>SM4(-128) algorithm</u>
6..255	Reserved

Upon ME instantiation, the ONU sets this attribute to 1, AES-128. Attribute After initiation, on request from the OLT, this attribute may be set to one of the algorithms supported by the ONU (as indicated in Security Capability attribute). Setting this attribute to any value +supported by the ONU does not imply that any channel of the (X)GEM ports are encrypted; that process is negotiated at the PLOAM layer. It only signifies that the advanced indicated encryption standard (AES) with 128 bit keys is algorithm set by the OLT is the security mode to be used on any channel of the (X)GEM ports that the OLT may choose to encrypt. (R, W) (mandatory) (1 byte)

NOTE – Values other than 1 are only valid for ITU-T G.9804 ONUs.

Total priority queue number: This attribute reports the total number of upstream priority queues that are not associated with a circuit pack, but with the ONU in its entirety. Upon ME instantiation, the ONU sets this attribute to the value that represents its capabilities. (R) (mandatory) (2 bytes)

Total traffic scheduler number: This attribute reports the total number of traffic schedulers that are not associated with a circuit pack, but with the ONU in its entirety. The ONU supports null function, strict priority scheduling and weighted round robin (WRR) from the priority control and guarantee of minimum rate control points of view, respectively. If the ONU has no global traffic schedulers, this attribute is 0. (R) (mandatory) (1 byte)

Deprecated: This attribute should always be set to 1 by the ONU and ignored by the OLT. (R) (mandatory) (1 byte)

Total GEM port-ID number: This attribute reports the total number of GEM port-IDs supported by the ONU. The maximum value is specified in the corresponding TC recommendations. Upon ME instantiation, the ONU sets this attribute to the value that represents its capabilities. (R) (optional) (2 bytes)

SysUpTime: This attribute counts 10 ms intervals since the ONU was last initialized. It rolls over to 0 when full (see [IETF RFC 1213]). (R) (optional) (4 bytes)

Connectivity capability: This attribute indicates the Ethernet connectivity models that the ONU can support. The value 0 indicates that the capability is not supported; 1 signifies support. The following code points are defined.

Bit	Model
1 (LSB)	N:1 bridging, Figure 8.2.2-3
2	1:M mapping, Figure 8.2.2-4
3	1:P filtering, Figure 8.2.2-5
4	N:M bridge-mapping, Figure 8.2.2-6
5	1:MP map-filtering, Figure 8.2.2-7
6	N:P bridge-filtering, Figure 8.2.2-8
7	N:MP bridge-map-filtering, Figure 8.2.2-9
8...16	Reserved

NOTE 1 – It is not implied that an ONU may not support other connectivity models.
(R) (optional) (2 bytes)

Current connectivity mode: This attribute specifies the Ethernet connectivity model that the OLT wishes to use. The following code points are defined.

Value	Connectivity model
0	No selection (default)
1	N:1 bridging
2	1:M mapping
3	1:P filtering

Value	Connectivity model
4	N:M bridge-mapping
5	1:MP map-filtering
6	N:P bridge-filtering
7	N:MP bridge-map-filtering
8...255	Reserved

NOTE 2 – It is not implied that an ONU supports a given connectivity model only when that model is explicitly selected by this attribute. The ONU is free to support additional models at any and all times.

(R, W) (optional) (1 byte)

Quality of service (QoS) configuration flexibility: This attribute reports whether various MEs in the ONU are fixed by the ONU's architecture or whether they are configurable. For backward compatibility, and if the ONU does not support this attribute, all such attributes are understood to be hard-wired. (R) (optional) (2 bytes)

Bit	Interpretation when bit value = 1
1 (LSB)	Priority queue ME: Port field of related port attribute is RW and can point to any T-CONT or UNI port in the same slot
2	Priority queue ME: The traffic scheduler pointer is permitted to refer to any other traffic scheduler in the same slot
3	Traffic scheduler ME: T-CONT pointer is RW
4	Traffic scheduler ME: Policy attribute is RW
5	T-CONT ME: Policy attribute is RW
6	Priority queue ME: Priority field of related port attribute is RW
7..16	Reserved

Discussion:

To allow for the possibility that the OLT does not support flexible configuration, the ONU vendor must assure that the priority queues and traffic schedulers are configured in a meaningful and useful way by factory default, and that this default configuration is restored upon ONU initialization and MIB reset. The specifics of such a configuration are beyond the scope of this Recommendation.

The ME ID of both the T-CONT and traffic scheduler contains a slot number. Even when attributes in the above list are RW, it is never permitted to change the slot number in a reference. That is, configuration flexibility never extends across slots. It is also not permitted to change the directionality of an upstream queue to downstream or *vice versa*.

Priority queue scale factor: If this optional attribute is implemented, it specifies the scale factor of several attributes of the priority queue ME of clause 9.2.10. The default value of this attribute is 1. (R, W) (optional) (2 bytes)

NOTE 3 – Some legacy implementations may take the queue scale factor from the GEM block length attribute of the ANI-G ME. That option is discouraged in new implementations.

Actions

Get, set

Notifications

Attribute value change

Number	Attribute value change	Description
1	N/A	
2	OMCC version	OMCC version supported in the ONU
3..11	N/A	
12..16	Reserved	

9.1.3 ONU data

This ME models the MIB itself. Clause I.1.3 explains the use of this ME with respect to MIB synchronization.

The ONU automatically creates an instance of this ME, and updates the associated attributes according to data within the ONU itself.

Relationships

One instance of this ME is contained in an ONU.

Attributes

Managed entity ID: This attribute uniquely identifies each instance of this ME. There is only one instance, number 0. (R) (mandatory) (2 bytes)

MIB data sync: This attribute is used to check the alignment of the MIB of the ONU with the corresponding MIB in the OLT. MIB data sync relies on this attribute, which is a sequence number that can be checked by the OLT to see if the MIB snapshots for the OLT and ONU match. Refer to clause I.1.2.1 for a detailed description of this attribute. Upon ME instantiation, the ONU sets this attribute to 0. (R, W) (mandatory) (1 byte)

Actions

Get, set

Get all alarms: Latch a snapshot of the current alarm statuses of all MEs and reset the alarm message counter.

Get all alarms next: Get the latched alarm status of the next ME(s) within the current snapshot.

MIB reset: Reset the MIB data sync attribute to 0 and reset the MIB of the ONU to its default. The default MIB comprises those MEs that are designated mandatory in the corresponding Recommendation, along with other auto-created MEs whose existence is implicit in the architecture or physical configuration of the ONU.

For G-PON applications, the minimum default MIB comprises one instance of the ONU-G ME pair, one instance of the ONU data ME, and two instances of the software image ME.

MIB upload: Latch a snapshot (i.e., copy) of the current MIB. Not every ME or every attribute is included in an MIB upload. Table attributes are excluded. Only the control block attributes of PM MEs are uploaded. Other MEs and attributes,

such as the PPTP for the local craft terminal (LCT), are excluded as documented in their specific definitions.

MIB upload next: Get the latched attribute values of the next ME(s) within the current snapshot.

Notifications

None.

9.1.4 Software image

This ME models an executable software image stored in the ONU (documented here as its fundamental usage). It may also be used to represent an opaque vendor-specific file (vendor-specific usage).

Fundamental usage

The ONU automatically creates two instances of this ME upon the creation of each ME that contains independently manageable software, either the ONU itself or an individual circuit pack. It populates ME attributes according to data within the ONU or the circuit pack.

Some pluggable equipment may not contain software. Others may contain software that is intrinsically bound to the ONU's own software image. No software image ME need exist for such equipment, though it may be convenient for the ONU to create them to support software version audit from the OLT. In this case, the dependent MEs would support only the get action.

A slot may contain various equipment over its lifetime, and if software image MEs exist, the ONU must automatically create and delete them as the equipped configuration changes. The identity of the software image is tied to the cardholder.

When an ONU controller packs are duplicated, each can be expected to contain two software image MEs, managed through reference to the individual controller packs themselves. When this occurs, the ONU should not have a global pair of software images MEs (instance 0), since an action (download, activate, commit) directed to instance 0 would be ambiguous.

Relationships

Two instances of the software image ME are associated with each instance of the ONU or cardholder whose software is independently managed.

Attributes

Managed entity ID: This attribute uniquely identifies each instance of this ME. The first byte indicates the physical location of the equipment hosting the software image, either the ONU (0) or a cardholder (1..254). The second byte distinguishes between the two software image ME instances (0..1). (R) (mandatory) (2 bytes)

Version: This string attribute identifies the version of the software. (R) (mandatory) (14 bytes)

Is committed: This attribute indicates whether the associated software image is committed (1) or uncommitted (0). By definition, the committed software image is loaded and executed upon reboot of the ONU or circuit pack. During normal operation, one software image is always committed, while the other is uncommitted. Under no circumstances are both software images allowed to be committed at the same time. On the other hand, both software images could be uncommitted at the same time if both were invalid. Upon ME instantiation, instance 0 is initialized to committed, while instance 1 is initialized to

uncommitted (i.e., the ONU ships from the factory with image 0 committed). (R) (mandatory) (1 byte)

Is active: This attribute indicates whether the associated software image is active (1) or inactive (0). By definition, the active software image is one that is currently loaded and executing in the ONU or circuit pack. Under normal operation, one software image is always active while the other is inactive. Under no circumstances are both software images allowed to be active at the same time. On the other hand, both software images could be inactive at the same time if both were invalid. (R) (mandatory) (1 byte)

Is valid: This attribute indicates whether the associated software image is valid (1) or invalid (0). By definition, a software image is valid if it has been verified to be an executable code image. The verification mechanism is not subject to standardization; however, it should include at least a data integrity check [e.g., a cyclic redundancy check (CRC)] of the entire code image. Upon ME instantiation or software download completion, the ONU validates the associated code image and sets this attribute according to the result. (R) (mandatory) (1 byte)

Product code: This attribute provides a way for a vendor to indicate product code information on a file. It is a character string, padded with trailing nulls if it is shorter than 25 bytes. (R) (optional) (25 bytes)

Image hash: This attribute is an MD5 hash of the software image. It is computed at completion of the end download action. (R) (optional) (16 bytes)

Actions

Get

Software upgrade is described in clause I.3. All of the following actions are mandatory for ONUs with remotely manageable software.

Start download: Initiate a software download sequence. This action is valid only for a software image instance that is neither active nor committed.

Download section: Download a section of a software image. This action is valid only for a software image instance that is currently being downloaded (image 1 in state S2, image 0 in state S2').

End download: Signal the completion of a download image sequence, providing both CRC and version information for final verification. This action is valid only for a software image instance that is currently being downloaded (image 1 in state S2, image 0 in state S2').

Activate image: Load/execute a software image. When this action is applied to a software image that is currently inactive, execution of the current code image is suspended, the associated software image is loaded from non-volatile memory, and execution of this new code image is initiated (i.e., the associated entity reboots on the previously inactive image). When this action is applied to a software image that is already active, a soft restart is performed. The software image is not reloaded from non-volatile memory; the current volatile code image is simply restarted. This action is only valid for a valid software image.

Commit image: Set the *is committed* attribute value to 1 for the target software image ME and set the *is committed* attribute value to 0 for the other software image. This causes the committed software image to be loaded and executed by the boot

code upon subsequent start-ups. This action is only applicable when the target software image is valid.

Notifications

Attribute value change

Number	Attribute value change	Description
1	Version	
2	Is committed	
3	Is active	If an autonomous change to this attribute is associated with an ONU re-boot, the ONU should send the AVC (one for each primary software image instance) after the re-boot.
4	Is valid	
5	Product code	
6	Image hash	
7..16	Reserved	
NOTE – Older implementations of the OMCI may not support these notifications, which have been introduced in this version of this Recommendation.		

Vendor-specific usage

In this application, the software image ME is flexible, in keeping with the needs of particular vendors and applications. The distinction between fundamental and vendor-specific usage is that the ME ID must not be a value that could be used in the fundamental usage application. That is, the second byte of the ME ID must be neither 0x00 nor 0x01.

The ONU automatically instantiates as many instances as it is prepared to support.

- In its vendor-specific usage, the attributes of the software image ME are optional.
- The actions are optional.
- Files may or may not exist in versioned pairs (previous revision, next revision).

Relationships

A vendor-specific instance of the software image ME represents an externally visible file on the ONU. The content and use of the file are not specified.

Attributes

Managed entity ID: This attribute uniquely identifies each instance of this ME. The first byte indicates the physical location of the equipment hosting the software image, either the ONU (0) or a cardholder (1..254). The second byte distinguishes between software image ME instances, and in vendor-specific usage is required to have neither the value 0x00 nor the value 0x01. To facilitate discovery by the OLT, it is suggested that the first byte of the ME ID be 0, and that the second byte be numbered consecutively from 2. (R) (mandatory) (2 bytes)

Version: If this attribute is supported, its meaning is the same as that of the fundamental usage application. (R) (optional) (14 bytes)

Is committed: This attribute indicates whether the associated file is committed (1) or uncommitted (0). Vendor-specific instances may or may not exist in pairs, and may or may not support the concept of a commit. (R) (optional) (1 byte)

- Is active:** This attribute indicates whether the associated file is active (1) or inactive (0). Vendor-specific instances may or may not support the concept of an active state. (R) (optional) (1 byte)
- Is valid:** This attribute indicates whether the associated file is valid (1) or invalid (0). Vendor-specific instances may or may not include a way to determine their validity. (R) (optional) (1 byte)
- Product code:** This attribute provides a way for a vendor to indicate product code information on a file. It is a character string, padded with trailing nulls if it is shorter than 25 bytes. (R) (optional) (25 bytes)
- Image hash:** This attribute is an MD5 hash of the software image. It is computed at completion of the end download action. (R) (optional) (16 bytes)

Actions

Get

The following actions are available for vendor-specific use, but optional. If the ONU does not support a given action, it should respond with a command not supported result and reason code.

Start download: Initiate a software download sequence.

Download section: Download a section of a file.

End download: Signal the completion of a file download, providing CRC and version information for final verification, if supported. This action causes the file to be stored in the ONU's non-volatile memory.

NOTE – There is no explicit way to delete a file. It is suggested that the ONU recognize downloading a file of size zero as a delete operation, i.e., a start download command specifying zero image size, followed by an immediate end download, with a zero CRC and also specifying zero image size.

Activate image: Effectuate the file, e.g., by loading its contents into ONU hardware. If appropriate, the hardware or application may be reinitialized.

Commit image: Set the *is committed* attribute value to 1 for the target file ME, if supported. The semantics of this operation are vendor-specific; there is no de-commit action.

Notifications

Attribute value change

Number	Attribute value change	Description
1	Version	
2	Is committed	
3	Is active	If an autonomous change to this attribute is associated with an ONU re-boot, the ONU should send the AVC (one for each primary software image instance) after the re-boot.
4	Is valid	
5	Product code	
6	Image hash	
7..16	Reserved	

NOTE – Older implementations of the OMCI may not support these notifications, which have been introduced in this version of this Recommendation.

9.1.5 Cardholder

The cardholder represents the fixed equipment slot configuration of the ONU. Each cardholder can contain 0 or 1 circuit packs; the circuit pack models equipment information that can change over the lifetime of the ONU, e.g., through replacement.

One instance of this ME exists for each physical slot in an ONU that has pluggable circuit packs. One or more instances of this ME may also exist in an integrated ONU, to represent virtual slots. Instances of this ME are created automatically by the ONU, and the status attributes are populated according to data within the ONU itself.

Slot 0 is intended to be used only in an integrated ONU. If an integrated ONU is modelled with a universal slot 0, it is recommended that it does not contain additional (non-zero) virtual slots. A cardholder for virtual slot 0 is recommended.

There is potential for conflict in the semantics of the expected plug-in unit type, the expected port count and the expected equipment ID, both when the slot is not populated and when a new circuit pack is inserted. The expected plug-in unit type and the plug-in type mismatch alarm are mandatory, although *plug-and-play/unknown* (circuit pack type 255) may be used as a way to minimize their significance. It is recommended that an ONU deny the provisioning of inconsistent combinations of expected equipment attributes.

When a circuit pack is plugged into a cardholder or when a cardholder is pre-provisioned to expect a circuit pack of a given type, it may trigger the ONU to instantiate a number of MEs and update the values of others, depending on the circuit pack type. The ONU may also delete a variety of other MEs when a circuit pack is reprovisioned to not expect a circuit pack or to expect a circuit pack of a different type. These actions are described in the definitions of the various MEs.

Expected equipment ID and expected port count are alternate ways to trigger the same pre-provisioning effects. These tools may be useful if an ONU is prepared to accept more than one circuit pack of a given type but with different port counts, or if a circuit pack is a hybrid that matches none of the types in Table 9.1.5-1, but whose identification (e.g., part number) is known.

Relationships

An ONU may contain zero or more instances of the cardholder, each of which may contain an instance of the circuit pack ME. The slot ID, real or virtual, is a fundamental identification mechanism for MEs that bear some relationship to a physical location.

Attributes

Managed entity ID: This attribute uniquely identifies each instance of this ME. The ONU sets the first byte of this 2 byte identifier to:

- 0 if the ONU contains pluggable equipment modules
- 1 if the ONU is a single piece of integrated equipment.

The second byte of this identifier is the slot number. In integrated ONUs, this byte may be used as a virtual slot or set to 0 to indicate a universal pseudo-slot.

Slot numbering schemes differ among vendors. It is only required that slot numbers be unique across the ONU. Up to 254 equipment slots are supported in the range 1..254 (Note 1). The value 0 is reserved for possible use in an integrated ONU to indicate a universal pseudo-slot. The value 255 is also reserved. (R) (mandatory) (2 bytes)

NOTE 1 – Some xDSL MEs use the two MSBs of the slot number for other purposes. An ONU that supports these services may have slot limitations or restrictions.

Actual plug-in unit type: This attribute is equal to the type of the circuit pack in the cardholder, or 0 if the cardholder is empty. When the cardholder is populated,

this attribute is the same as the type attribute of the corresponding circuit pack ME. Circuit pack types are defined in Table 9.1.5-1. (R) (mandatory) (1 byte)

The three following attributes permit the OLT to specify its intentions for any future equipped configuration of a slot. Once some or all of these are set, the ONU can proceed to instantiate circuit pack and PPTP MEs, along with other predeterminable MEs, and allow the OLT to create related discretionary MEs, thereby supporting service pre-provisioning.

Expected plug-in unit type: This attribute provisions the type of circuit pack for the slot. For type coding, see Table 9.1.5-1. The value 0 means that the cardholder is not provisioned to contain a circuit pack. The value 255 means that the cardholder is configured for plug-and-play. Upon ME instantiation, the ONU sets this attribute to 0. For integrated interfaces, this attribute may be used to represent the type of interface. (R, W) (mandatory) (1 byte)

Expected port count: This attribute permits the OLT to specify the number of ports it expects in a circuit pack. Prior to provisioning by the OLT, the ONU initializes this attribute to 0. (R, W) (optional) (1 byte)

Expected equipment ID: This attribute provisions the specific type of expected circuit pack. This attribute applies only to ONUs that do not have integrated interfaces. In some environments, this may contain the expected CLEI code. Upon ME instantiation, the ONU sets this attribute to all spaces. (R, W) (optional) (20 bytes)

Actual equipment ID: This attribute identifies the specific type of circuit pack, once it is installed. This attribute applies only to ONUs that do not have integrated interfaces. In some environments, this may include the CLEI code. When the slot is empty or the equipment ID is not known, this attribute should be set to all spaces. (R) (optional) (20 bytes)

Protection profile pointer: This attribute specifies an equipment protection profile that may be associated with the cardholder. Its value is the least significant byte of the ME ID of the equipment protection profile with which it is associated, or 0 if equipment protection is not used. (R) (optional) (1 byte)

Invoke protection switch: The OLT may use this attribute to control equipment protection switching. Code points have the following meaning when set by the OLT:

- | | |
|---|-----------------------------------------------------------|
| 0 | Release protection switch |
| 1 | Operate protection switch, protect cardholder unspecified |
| 2 | Operate protection switch, use first protect cardholder |
| 3 | Operate protection switch, use second protect cardholder |

The ONU should deny attempts to switch to an unequipped, defective or already active protection cardholder.

Upon the get action from the OLT, this attribute should return the current value of the actual protection configuration. Code points are as defined above; the value 1 is never returned.

When circuit packs that support a PON interface (IF) function are switched, the response should be returned on the same PON that received the command. However, the OLT should also be prepared to accept a response on the redundant PON. (R, W) (optional) (1 byte)

Alarm-reporting control (ARC): See clause A.1.4.3. (R, W) (optional) (1 byte)

ARC interval: See clause A.1.4.3. (R, W) (optional) (1 byte)

Actions

Get, set

Notifications

Attribute value change

Number	Attribute value change	Description
1	Actual type	Actual type of circuit pack in cardholder
2..4	N/A	
5	Actual equipment id	Actual equipment ID of circuit pack in cardholder
6..7	N/A	
8	ARC	ARC timer expiration
9	N/A	
10..16	Reserved	

Alarm (Note 2)

Alarm number	Alarm	Description
0	Plug-in circuit pack missing	Configured circuit pack is not present. If this alarm is active, none of the mismatch alarms are declared.
1	Plug-in type mismatch alarm	Inserted circuit pack is wrong type
2	Improper card removal	Circuit pack has been removed without being de-provisioned or administratively locked. This is a redundant alarm that helps the OLT distinguish between transitions from state S2 to state S1 (Figure 9.1.5-1) and transitions from state S4 to state S1. This alarm is sent only when a transition occurs from state S2 to state S1.
3	Plug-in equipment ID mismatch alarm	Inserted circuit pack has the wrong equipment ID
4	Protection switch	An autonomous equipment protection switch has occurred. This notification is reported by the protected cardholder.
5..207	Reserved	
208..223	Vendor-specific	Not to be standardized

NOTE 2 – If no circuit pack is configured or if the cardholder is configured for plug-and-play with no expected equipment ID, no alarms are raised. No cardholder alarms are defined for ONUs with integrated interfaces.

Figure 9.1.5-1 is a state diagram that describes insertion and removal of a particular circuit pack into/from a cardholder that is provisioned to a specific type or to plug-and-play.

NOTE 3 – The state diagram is not applicable for ONUs with integrated interfaces.

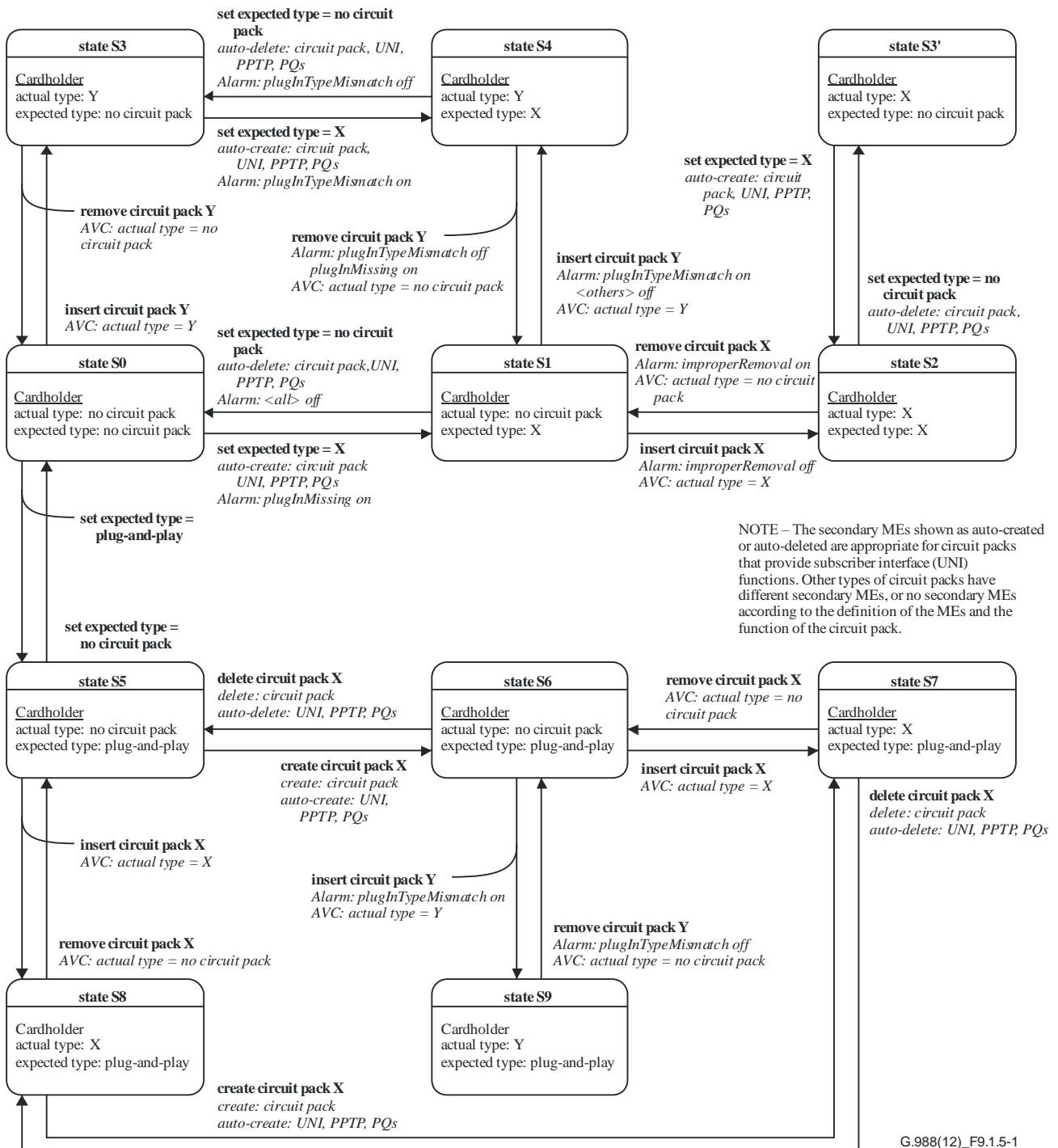

Figure 9.1.5-1 – Cardholder state diagram

Some of the following circuit pack types are obsolete in current applications. Their code points and definitions are reserved for backward compatibility, but in the interest of brevity, they are not listed.

Table 9.1.5-1 – Plug-in unit types

Coding	Content	Description
0	No LIM	Default value
1..12	<i>See [ITU-T G.983.2]</i>	<i>Various ATM based UNIs</i>
13	C1.5 (DS1)	1.544 Mbit/s local (T-interface) module
14	C2.0 (E1)	2.048 Mbit/s local (T-interface) module
15	C6.3 (J2)	6.312 Mbit/s local (T-interface) module
16	C-DS1/E1	Configurable DS1/E1 module
17	C-DS1/E1/J1	Configurable DS1/E1/J1 module
18..21	<i>See [ITU-T G.984.4]</i>	<i>Various CES services</i>
22	10BASE-T	IEEE 802.3 10BASE-T Ethernet LAN IF
23	100BASE-T	IEEE 802.3 100BASE-T Ethernet LAN IF
24	10/100 BASE-T	IEEE 802.3 10/100 BASE-T Ethernet LAN IF (Note)
25..27	<i>See [ITU-T G.983.2]</i>	<i>Various non-Ethernet LAN technologies</i>
28	C1.5 (J1)	1.544 Mbit/s local (T-interface) module
29..31	<i>See [ITU-T G.984.4]</i>	<i>Various ATM interfaces</i>
32	POTS	Plain old telephony service
33	ISDN-BRI	ISDN basic rate interface (deprecated)
34	Gigabit optical Ethernet	Any IEEE 802.3 Gigabit Ethernet optical IF (Note)
35	xDSL	xDSL IF
36	SHDSL	SHDSL IF
37	VDSL	VDSL IF [ITU-T G.993.1]
38	Video service	Video module
39	LCT	Local craft terminal interface
40	802.11	Wireless interface [IEEE 802.11]
41	xDSL/POTS	Combination xDSL and POTS interfaces
42	VDSL/POTS	Combination VDSL [ITU-T G.993.1] and POTS interfaces
43	Common equipment	Circuit packs such as removable power supply modules or ONU controllers
44	Combined video UNI and PON interface	Circuit pack that combines both functions
45	Mixed services equipment	Circuit pack with several types of ANI or UNI. Suggested for use with the port-mapping package managed entity.
46	MoCA	MoCA
47	10/100/1000BASE-T	IEEE 802.3 10/100/1000 BASE-T LAN Ethernet LAN interface
48	VEIP	Virtual Ethernet interface point
49	10G GBASE-T Ethernet	IEEE 802.3 10G BASE-T Ethernet LAN interface
50	2.5GBASE-T Ethernet	IEEE 802.3 2.5GBASE-T Ethernet LAN interface
51	5GBASE-T Ethernet	IEEE 802.3 5GBASE-T Ethernet LAN interface
52	25GBASE-T Ethernet	IEEE 802.3 25GBASE-T Ethernet LAN interface
53	40GBASE-T Ethernet	IEEE 802.3 40GBASE-T Ethernet LAN interface

Table 9.1.5-1 – Plug-in unit types

Coding	Content	Description
54	1000BASE-LX	IEEE 802.3 1000BASE-LX Ethernet optical onterface
55	1000BASE-SX	IEEE 802.3 1000BASE-SX Ethernet optical interface
56	10GBASE-SR	IEEE 802.3 10GBASE-SR optical interface
57	10GBASE-LX4	IEEE 802.3 10GBASE-LX4 optical interface
58	10GBASE-LRM	IEEE 802.3 10GBASE-LRM optical interface
59	10GBASE-LR	IEEE 802.3 10GBASE-LR optical nterface
60	10GBASE-ER	IEEE 802.3 10GBASE-ER optical interface
61	10GBASE-SW	IEEE 802.3 10GBASE-SW optical interface
62	10GBASE-LW	IEEE 802.3 10GBASE-LW optical Interface
63	10GBASE-EW	IEEE 802.3 10GBASE-EW optical interface
64	25GBASE-SR	IEEE 802.3 25GBASE-SR optical interface
65	40GBASE-SR4	IEEE 802.3 40GBASE-SR optical interface
66	40GBASE-LR4	IEEE 802.3 40GBASE-LR optical interface
67	40GBASE-ER4	IEEE 802.3 40GBASE-ER4 optical interface
68	Multi-Rate-10GBASE-T	Any IEEE 802.3 10GBASE-T with XGMII and GMII interface
69	10G Optical Interface	Any IEEE 802.3 10G optical interface
70	40G Optical Interface	Any IEEE 802.3 40G optical interface
71	G.fast	ITU-T G.9701 G.fast
72..191	Reserved	
192..223	Vendor-specific	Reserved for vendor use, not to be standardized
224.. 229 <u>26</u>	Reserved	
<u>227</u>	<u>HSP50G50</u>	<u>HSP interface with 49.7664 Gbit/s downstream, 49.7664 Gbit/s upstream</u>
<u>228</u>	<u>HSP50G25</u>	<u>HSP interface with 49.7664 Gbit/s downstream, 24.8832 Gbit/s upstream</u>
<u>229</u>	<u>HSP50G12</u>	<u>HSP interface with 49.7664 Gbit/s downstream, 12.4416 Gbit/s upstream</u>
230	Multi-PON	Any ITU-T PON type. -This codepoint is applicable to circuit pack and cardholder ME
231	PtP WDM PON line rate class 1	PtP WDM PON interface, the relative nominal line rates see Table A.1in Amd.1 to [ITU-T G.989.2]
232	PtP WDM PON line rate class 2	PtP WDM PON interface, the relative nominal line rates see Table A.1 in Amd.1 to [ITU-T G.989.2]
233	PtP WDM PON line rate class 3	PtP WDM PON interface, the relative nominal line rates see Table A.1in Amd.1 to [ITU-T G.989.2]
234	TWDM10G2	ITU-T G.989 TWDM-PON interface, 9.95328 G downstream/2.48832 upstream
235	TWDM10G10	ITU-T G.989 TWDM-PON interface, 9.95328 G downstream/9.95328 upstream

Table 9.1.5-1 – Plug-in unit types

Coding	Content	Description
236	TWDM2G2	ITU-T G.989 TWDM-PON interface, 2.48832 G downstream/2.48832 G upstream
237	XG-PON10G2488	XG-PON interface, 10G downstream and 2.488G upstream
238	XG-PON10G10	XG-PON interface, 10G downstream and 10G upstream
239	Mid-span PON reach extender UNI	The UNI of a mid-span PON reach extender
240	Mid-span PON reach extender ANI	The ANI of a mid-span PON reach extender
241	Mid-span PON reach extender upstream optical amplifier	Upstream optical amplifier 1 270 nm or 1 310 nm
242	Mid-span PON 2488/1244 reach extender downstream optical amplifier	2488/1244 1 490 nm downstream optical amplifier with no corresponding RE ANI-G
243..247	<i>See [ITU-T G.984.4]</i>	<i>G-PON interfaces of diverse rates</i>
248	GPON24881244	GPON interface, 2 488 Mbit/s downstream and 1 244 Mbit/s upstream
249..254	<i>See [ITU-T G.983.2] and [ITU-T G.984.4]</i>	<i>G-PON and B-PON (broadband passive optical network) interfaces of diverse rates</i>
255	Plug-and-play/Unknown	Plug-and-play (for the cardholder managed entity only). Unrecognized module (for the circuit pack managed entity only)

9.1.6 Circuit pack

This ME models a real or virtual circuit pack that is equipped in a real or virtual ONU slot. For ONUs with integrated interfaces, this ME may be used to distinguish available types of interfaces (the port-mapping package is another way).

For ONUs with integrated interfaces, the ONU automatically creates an instance of this ME for each instance of the virtual cardholder ME. The ONU also creates an instance of this ME when the OLT provisions the cardholder to expect a circuit pack, i.e., when the OLT sets the expected plug-in unit type or equipment ID of the cardholder to a circuit pack type, as defined in Table 9.1.5-1. The ONU also creates an instance of this ME when a circuit pack is installed in a cardholder whose expected plug-in unit type is 255 = plug-and-play, and whose equipment ID is not provisioned. Finally, when the cardholder is provisioned for plug-and-play, an instance of this ME can be created at the request of the OLT.

The ONU deletes an instance of this ME when the OLT de-provisions the circuit pack (i.e., when the OLT sets the expected plug-in unit type or equipment ID of the cardholder to 0 = no LIM). The ONU also deletes an instance of this ME on request of the OLT if the expected plug-in unit type attribute of the corresponding cardholder is equal to 255, plug-and-play, and the expected equipment ID is blank (a string of all spaces). ONUs with integrated interfaces do not delete circuit pack instances.

NOTE – Creation and deletion by the OLT is retained for backward compatibility.

Relationships

An instance of this ME is contained by an instance of the cardholder ME.

Attributes

- Managed entity ID:** This attribute uniquely identifies each instance of this ME. Its value is the same as that of the cardholder ME containing this circuit pack instance. (R, set-by-create if applicable) (mandatory) (2 bytes)
- Type:** This attribute identifies the circuit pack type. This attribute is a code as defined in Table 9.1.5-1. The value 255 means unknown or undefined, i.e., the inserted circuit pack is not recognized by the ONU or is not mapped to an entry in Table 9.1.5-1. In the latter case, the equipment ID attribute may contain inventory information. Upon autonomous ME instantiation, the ONU sets this attribute to 0 or to the type of the circuit pack that is physically present. (R, set-by-create if applicable) (mandatory) (1 byte)
- Number of ports:** This attribute is the number of access ports on the circuit pack. If the port-mapping package is supported for this circuit pack, this attribute should be set to the total number of ports of all types. (R) (optional) (1 byte)
- Serial number:** The serial number is expected to be unique for each circuit pack, at least within the scope of the given vendor. Note that the serial number may contain the vendor ID or version number. For integrated ONUs, this value is identical to the value of the serial number attribute of the ONU-G ME. Upon creation in the absence of a physical circuit pack, this attribute comprises all spaces. (R) (mandatory) (8 bytes)
- Version:** This attribute is a string that identifies the version of the circuit pack as defined by the vendor. The value 0 indicates that version information is not available or applicable. For integrated ONUs, this value is identical to the value of the version attribute of the ONU-G ME. Upon creation in the absence of a physical circuit pack, this attribute comprises all spaces. (R) (mandatory) (14 bytes)
- Vendor ID:** This attribute identifies the vendor of the circuit pack. For ONUs with integrated interfaces, this value is identical to the value of the vendor ID attribute of the ONU-G ME. Upon creation in the absence of a physical circuit pack, this attribute comprises all spaces. (R) (optional) (4 bytes)
- Administrative state:** This attribute locks (1) and unlocks (0) the functions performed by this ME. Administrative state is further described in clause A.1.6. (R, W) (mandatory) (1 byte)
- Operational state:** This attribute indicates whether the circuit pack is capable of performing its function. Valid values are enabled (0), disabled (1) and unknown (2). Pending completion of initialization and self-test on an installed circuit pack, the ONU sets this attribute to 2. (R) (optional) (1 byte)
- Bridged or IP ind:** This attribute specifies whether an Ethernet interface is bridged or derived from an IP router function.
- 0 Bridged
 - 1 IP router
 - 2 Both bridged and IP router functions
- (R, W) (optional, only applicable for circuit packs with Ethernet interfaces) (1 byte)
- Equipment ID:** This attribute may be used to identify the vendor's specific type of circuit pack. In some environments, this attribute may include the CLEI code. Upon ME instantiation, the ONU sets this attribute to all spaces or to the equipment ID of the circuit pack that is physically present. (R) (optional) (20 bytes)

Card configuration: This attribute selects the appropriate configuration of configurable circuit packs. Table 9.1.5-1 specifies two configurable card types: C-DS1/E1 (code 16), and C-DS1/E1/J1 (code 17). Values are indicated below for the allowed card types and configurations.

Card Type	Configuration	Value
C-DS1/E1	DS1	0
	E1	1
C-DS1/E1/J1	DS1	0
	E1	1
	J1	2

Upon autonomous instantiation, this attribute is set to 0. (R, W, set-by-create if applicable) (mandatory for configurable circuit packs) (1 byte)

Total T-CONT buffer number: This attribute reports the total number of T-CONT buffers associated with the circuit pack. Upon ME instantiation, the ONU sets this attribute to 0 or to the value supported by the physical circuit pack. (R) (mandatory for circuit packs that provide a traffic scheduler function) (1 byte)

Total priority queue number: This value reports the total number of priority queues associated with the circuit pack. Upon ME instantiation, the ONU sets the attribute to 0 or to the value supported by the physical circuit pack. (R) (mandatory for circuit packs that provide a traffic scheduler function) (1 byte)

Total traffic scheduler number: This value reports the total number of traffic schedulers associated with the circuit pack. The ONU supports null function, strict priority scheduling and WRR from the priority control, and guarantee of minimum rate control points of view. If the circuit pack has no traffic scheduler, this attribute should be absent or have the value 0. Upon ME instantiation, the ONU sets the attribute to 0 or to the value supported by the physical circuit pack. (R) (mandatory for circuit packs that provide a traffic scheduler function) (1 byte)

Power shed override: This attribute allows ports to be excluded from the power shed control defined in clause 9.1.7. It is a bit mask that takes port 1 as the MSB; a bit value of 1 marks the corresponding port to override the power shed timer. For hardware that cannot shed power per port, this attribute is a slot override rather than a port override, with any non-zero port value causing the entire circuit pack to override power shedding. (R, W) (optional) (4 bytes)

Actions

Get, set

Create, delete: Optional, only when plug-and-play is supported.

Reboot: Reboot the circuit pack.

Test: Test the circuit pack (optional). The test action may be used either to perform equipment diagnostics or to measure parameters, such as received optical power, video output level and battery voltage. Test and test result messages are defined in Annex A.

Notifications

Attribute value change

Number	Attribute value change	Description
1..6	N/A	
7	Op state	Operational state change
8..14	N/A	
15..16	Reserved	

Alarm

Alarm number	Alarm	Description
0	Equipment alarm	A failure on an internal interface or failed self-test
1	Powering alarm	Fuse failure or failure of DC/DC converter
2	Self-test failure	Failure of circuit pack autonomous self-test
3	Laser end of life	Failure of transmit laser imminent
4	Temperature yellow	No service shutdown at present, but the circuit pack is operating beyond its recommended range.
5	Temperature red	Service has been shut down to avoid equipment damage. The operational state of the affected PPTPs indicates the affected services.
6..207	Reserved	
208..223	Vendor-specific alarms	Not to be standardized

9.1.7 ONU power shedding

This ME models the ONU's ability to shed services when the ONU goes into battery operation mode after AC power failure. Shedding classes are defined in the following table, which may span multiple circuit pack types. This feature works in conjunction with the power shed override attribute of the circuit pack ME, which can selectively prevent power shedding of priority ports.

An ONU that supports power shedding automatically creates an instance of this ME.

The following table defines the binding of shedding class and PPTP type. The coding is taken from Table 9.1.5-1. In the case of hybrid circuit pack types, multiple shedding classes may affect a circuit pack if the hardware is capable of partial power shedding.

An ONU may choose to model its ports with the port-mapping package of clause 9.1.8, rather than with real or virtual circuit packs. In this case, power shedding pertains to individual PPTPs (listed in column 2 of the table).

Shedding class	PPTP type	Coding	Content
ATM	ATM PPTP	1..12	Various ATM UNIs
CES	CES PPTP	13	C1.5 (DS1)
		14	C2.0 (E1)
		15	C6.3 (J2)
		16	C-DS1/E1
		17	C-DS1/E1/J1
Data	Ethernet PPTP	22	10BASE-T
		23	100BASE-T
		24	10/100 BASE-T
Frame	Unspecified	25..27	Non-Ethernet LANs
CES	CES PPTP	28	C1.5 (J1)
Sdh-sonet	Sdh-sonet	29..31	ATM sdh-sonet interfaces
Voice	POTS PPTP	32	POTS
	ISDN PPTP	33	ISDN BRI (deprecated)
Data	Ethernet PPTP	34	Gigabit optical Ethernet
DSL	xDSL PPTP	35	xDSL
	SHDSL	36	SHDSL
	VDSL PPTP	37	ITU-T G.993.1 VDSL
N/A	Video UNI	38	Radio frequency (RF) video service
N/A	LCT PPTP	39	Local craft terminal
Data	IEEE 802.11 PPTP	40	Wireless
Voice (DSL may also apply)	xDSL + POTS	41	xDSL/POTS
	VDSL + POTS	42	ITU-T G.993.1 VDSL/POTS
N/A	Unspecified	43	Common equipment
	Unspecified	44	Combined video, PON
	Unspecified	45	Mixed services (Power shedding based on port type)
Data	MoCA PPTP	46	MoCA
Data	Ethernet PPTP	47	10/100/1000 BASE-T
		49	10G Ethernet
N/A	PON PPTP	237..238	XG-PON ANIs
Video overlay	Video ANI PPTP		
Video return	Video RPD		

Relationships

One instance of this ME is associated with the ONU ME.

Attributes

Managed entity ID: This attribute uniquely identifies each instance of this ME. There is only one instance, number 0. (R) (mandatory) (2 bytes)

Restore power timer reset interval: The time delay, in seconds, before resetting the power-shedding timers after full power restoration. Upon ME instantiation, the ONU sets this attribute to 0. (R, W) (mandatory) (2 bytes)

For each class of service (CoS), an interval attribute is defined below. The value 0 disables power shedding, while the value 1 enables immediate power shedding, i.e., as soon as AC power fails. Other values specify the time, in seconds, to keep the service active after AC failure before shutting them down and shedding power. Upon ME instantiation, the ONU sets each of the interval attributes to 0.

Data class shedding interval: (R, W) (mandatory) (2 bytes)

Voice class shedding interval: This attribute only pertains to voice services that terminate on the ONU and are under the management control of the OMCI. (R, W) (mandatory) (2 bytes)

Video overlay class shedding interval: (R, W) (mandatory) (2 bytes)

Video return class shedding interval: (R, W) (mandatory) (2 bytes)

Digital subscriber line (DSL) class shedding interval: (R, W) (mandatory) (2 bytes)

ATM class shedding interval: (R, W) (mandatory) (2 bytes)

CES class shedding interval: (R, W) (mandatory) (2 bytes)

Frame class shedding interval: (R, W) (mandatory) (2 bytes)

Sdh-sonet class shedding interval: (R, W) (mandatory) (2 bytes)

Shedding status: Binary indication of power-shedding status for each shedding class. If this 2 byte field is depicted 0b ABCD EFGH IJKL MNOP, its bits are assigned as follows-

- A Data class
- B Voice class
- C Video overlay class
- D Video return class
- E DSL class
- F ATM class
- G CES class
- H Frame class
- I Sdh-sonet class
- J..P Reserved and set to 0

The ONU sets each bit to 1 when power shedding is active, and clears it to 0 when the service is restored. (R) (optional) (2 bytes)

Actions

Get, set

Notifications

Attribute value change

Number	Attribute value change	Description
1..10	N/A	
11	Shedding status	State change of a shedding function
12..16	Reserved	

9.1.8 Port-mapping package

NOTE – In [ITU-T G.984.4], this ME is called a port-mapping package-G.

This ME provides a way to map a heterogeneous set of PPTPs (ports) to a parent equipment, which may be a cardholder or the ONU itself. It could be useful, for example, if a single plug-in circuit pack contained a PON ANI as port 1, a video UNI as port 2, and a craft UNI as port 3. Another application of the port-mapping package is the case where more than one UNI or ANI ME is associated with a single physical port, for example, the RE ANI and downstream amplifier. This ME also provides an option for an integrated ONU to represent its ports without the use of virtual cardholders and VC packs.

If the port-mapping package is supported for the ONU as a whole, it is automatically created by the ONU. If the port-mapping package is supported for plug-in circuit packs, it is created and destroyed by the ONU when the corresponding circuit pack is installed or pre-provisioned in a cardholder.

The port list attributes specify ports 1..64 sequentially. Each port list is a sequence of ME types, as defined in Table 11.2.4-1. These ME type codes define what kind of PPTP or ANI corresponds to the specific port number. For example, for a circuit pack with 4 POTS ports, 2 xDSL ports, and 1 video UNI port, numbered sequentially in that order, the attributes would be coded:

Max ports: 7
Port list 1 53, 53, 53, 53, 98, 98, 82, 0
Port list 2..8 All zero

Relationships

A port-mapping package may be contained by an ONU-G or a cardholder.

Attributes

Managed entity ID: This attribute uniquely identifies each instance of this ME. Through an identical ID, this ME is implicitly linked to an instance of the ONU-G or cardholder. (R) (mandatory) (2 bytes)

Max ports: This attribute indicates the largest port number contained in the port list attributes. Ports are numbered from 1 to this maximum, possibly with embedded 0 entries, but no port may exist beyond the maximum. (R) (mandatory) (1 byte)

Each of the following attributes is a list of 8 ports, in increasing port number sequence. Each list entry is a 2 byte field containing the ME type of the UNI or ANI corresponding to the port number. ME types are defined in Table 11.2.4-1. Placeholders for non-existent port numbers are indicated with the value 0.

Port list 1: (R) (mandatory) (16 bytes)
Port list 2: (R) (optional) (16 bytes)
Port list 3: (R) (optional) (16 bytes)
Port list 4: (R) (optional) (16 bytes)
Port list 5: (R) (optional) (16 bytes)
Port list 6: (R) (optional) (16 bytes)
Port list 7: (R) (optional) (16 bytes)
Port list 8: (R) (optional) (16 bytes)

Combined port table: This attribute permits the implicit linking of multiple port-level MEs to a single physical port. For example, a single physical port may be linked to both an RE ANI-G and an RE downstream amplifier, as illustrated in Figure 8.2.10-4. The combination of RE ANI-G and RE downstream amplifier cannot be directly represented in the port list attributes.

Each row of the combined port table comprises the following fields.

Field name	Size, bytes	Description
Physical port	1	Duplicates are allowed. The corresponding physical port in the port list attribute should be 0.
Equipment type 1	2	ME type 1, from Table 11.2.4-1. The first equipment type in the list is understood to be the master (in the first row of the table, in the case of duplicate physical ports). The administrative state, operational state and ARC attributes of the master override the corresponding attributes of secondary MEs.
...	2	... secondary MEs that share the physical port
Equipment type 12	2	Secondary ME type 12

As many as 12 ME types can be associated with a given physical port, and even more by duplicating the physical port field. (R) (optional) (N rows * 25 bytes)

Actions

Get, get next

Notifications

None.

9.1.9 Equipment extension package

This ME supports optional extensions to circuit pack MEs. If the circuit pack supports these features, the ONU creates and deletes this ME along with its associated real or virtual circuit pack.

Relationships

An equipment extension package may be contained by an ONU-G or cardholder.

Attributes

Managed entity ID: This attribute uniquely identifies each instance of this ME. Through an identical ID, this ME is implicitly linked to an instance of the ONU-G or cardholder. (R) (mandatory) (2 bytes)

Environmental sense: This attribute provisions an ONU that supports external sense points, e.g., physical security detectors at an enclosure. Each pair of bits is defined as follows.

- 00 Sense point disabled (default)
- 01 Report contact closure
- 10 Report contact open
- 11 Sense point disabled (same as 00)

If the byte is represented in binary as 0B hhgg ffee ddcc bbaa, bits hh correspond to sense point 1, while bits aa correspond to sense point 8. (R, W) (optional) (2 bytes)

NOTE – Some specific sense point applications are already defined on the ONU-G ME. It is the vendor's choice how to configure and report sense points that appear both generically and specifically.

Contact closure output: This attribute provisions an ONU that supports external contact closure outputs, e.g., sump pump or air conditioner activation at an ONU enclosure. A contact point is said to be released when it is not energized. Whether this corresponds to an open or a closed electrical circuit depends on the ONU's wiring options. Upon ONU initialization, all contact points should go to the released state.

If the byte is represented in binary as 0B hhgg ffee ddcc bbaa, bits hh correspond to contact output point 1, while bits aa correspond to contact output point 8.

On write, the bits of this attribute have the following meaning.

- 0x No change to contact output point state
- 10 Release contact output point
- 11 Operate contact output point

On read, the left bit in each pair should be set to 0 at the ONU and ignored at the OLT. The right bit indicates a released output point with 0 and an operated contact point with 1. (R, W) (optional) (2 bytes)

Actions

Get, set

Notifications

Alarm

Alarm number	Alarm	Description
0	Reserved	
1	Sense point 1	Environmental sense point 1 active
2	Sense point 2	Environmental sense point 2 active
3	Sense point 3	Environmental sense point 3 active
4	Sense point 4	Environmental sense point 4 active
5	Sense point 5	Environmental sense point 5 active
6	Sense point 6	Environmental sense point 6 active
7	Sense point 7	Environmental sense point 7 active
8	Sense point 8	Environmental sense point 8 active
9..207	Reserved	
208..223	Vendor-specific alarms	Not to be standardized

9.1.10 Protection data

This ME models the capability and parameters of PON protection. An ONU that supports PON protection automatically creates one instance of this ME. A chassis-based RE could have the capability of protecting a number of PONs, possibly by way of circuit packs configured in arbitrary (rather than predefined) slots. Protection data MEs in a multi-PON RE may therefore be auto-created or created by the OLT, depending on the RE's architecture, and the ANI-G pointers may be either

populated by the ONU itself (read-only) or configured by the OLT (RWSC). Likewise, the nature of protection may be set read-only by the ONU's architecture or may be settable by the OLT.

NOTE 1 – Equipment protection is modelled with the equipment protection profile and cardholder MEs.

NOTE 2 – For ONUs that implement RE functions, this ME can be used to describe OMCI protection, RE interface R/S' protection, or both. For R/S' protection, the protection type must be 1:1 without extra traffic, because the switching is done on a link-by-link basis, and the protection link is in cold standby mode. The instance that pertains to OMCI protection has ME ID = 0.

Relationships

One instance of this ME is associated with two instances of the ANI-G, RE ANI-G or RE upstream amplifier. One of the ANI MEs represents the working side; the other represents the protection side.

Attributes

Managed entity ID: This attribute uniquely identifies each instance of this ME. If there is more than one protection data ME, they are numbered in ascending order from 0. (R, set-by-create if applicable) (mandatory) (2 bytes)

Working ANI-G pointer: This attribute points to the ANI-G, RE ANI-G or RE upstream amplifier ME that represents the working side of a protected PON. (R, W if applicable, set-by-create if applicable) (mandatory) (2 bytes)

NOTE 3 – It is possible, and indeed likely, that an ANI-G will have the same ME ID as the RE ANI-G or even the RE upstream amplifier that supports its physical PON interface. The ANI-G represents the embedded ONU that terminates the OMCC. Since it is not expected that protection of management communications will be implemented independently from protection of the optical layer, the ambiguity is not expected to cause a problem.

Protection ANI-G pointer: This attribute points to the ANI-G, RE ANI-G or RE upstream amplifier ME that represents the protection side of a protected PON. (R, W if applicable, set-by-create if applicable) (mandatory) (2 bytes)

Protection type: This attribute indicates the type of PON protection. Valid values are:

- 0 1+1 protection
- 1 1:1 protection without extra traffic
- 2 1:1 protection with ability to support extra traffic

(R, W if applicable, set-by-create if applicable) (mandatory) (1 byte)

Revertive ind: This attribute indicates whether protection is revertive (1) or non-revertive (0). (R, W if applicable, set-by-create if applicable) (mandatory) (1 byte)

Wait to restore time: This attribute specifies the time, in seconds, to wait after a fault clears before switching back to the working path. Upon ME instantiation, the ONU sets this attribute to 3 s. (RWSC if applicable) (mandatory) (2 bytes)

Switching guard time: This attribute specifies the time, in milliseconds, to wait after the detection of a fault before performing a protection switch. Specification of a default value for this attribute is outside the scope of this Recommendation, as it is normally handled through supplier-operator negotiations. (RWSC if applicable) (optional) (2 bytes)

Actions

Get, set

If applicable: create, delete

Notifications

None.

9.1.11 Equipment protection profile

This ME supports equipment protection. There can be as many as two protection slots protecting as many as eight working slots. Each of the working and protect cardholder MEs should refer to the equipment protection profile that defines its protection group. Instances of this ME are created and deleted by the OLT.

An ONU should deny pre-provisioning that would create impossible protection groupings because of slot or equipment incompatibilities. In the same way, the ONU should deny creation or addition to protection groups that cannot be supported by the current equipped configuration. Even so, an inconsistent card type alarm is defined, for example, to cover the case of a plug-and-play circuit pack installed in a protection group cardholder that cannot support it.

Relationships

An instance of this object points to the working and protect cardholders, which in turn point back to this ME.

Attributes

Managed entity ID: This attribute uniquely identifies each instance of this ME. The first byte is 0. The second byte is assigned by the OLT, and must be unique and non-zero. (R, set-by-create) (mandatory) (2 bytes)

Protect slot 1, Protect slot 2: This pair of attributes describes the protecting cardholder entities in an equipment protection group. There can be one or two protecting entities.

- 0 Undefined entry (default), a place-holder if there are fewer than two protecting entities in the protection group.
- 1..254 Slot number of the protecting circuit pack.

(RWSC) (protect slot 1 mandatory, protect slot 2 optional) (1 byte * 2 attributes)

Working slot 1, Working slot 2, Working slot 3, Working slot 4, Working slot 5, Working slot 6, Working slot 7, Working slot 8: This group of attributes describes the working cardholder entities in an equipment protection group. There can be up to eight working entities.

- 0 Undefined entry (default), a place-holder if there are fewer than eight working entities in the protection group.
- 1..254 Slot number of the working circuit pack.

(RWSC) (working slot 1 mandatory, other working slots optional) (1 byte * 8 attributes)

Protect status 1, Protect status 2: This pair of attributes indicates whether each protection cardholder is currently protecting another cardholder, and if so, which one.

- 0 Not protecting any other cardholder.
- 1..254 Slot number of the working cardholder currently being protected by this ME.

(R) (mandatory) (1 byte * 2 attributes)

Revertive ind: This attribute specifies whether equipment protection is revertive. The default value 0 indicates revertive switching; any other value indicates non-revertive switching. (RWSC) (optional) (1 byte)

Wait to restore time: This attribute specifies the time, in minutes, during which a working equipment must be free of error before a revertive switch occurs. It defaults to 0. (RWSC) (optional) (1 byte)

Actions

Create, delete, get, set

Notifications

Alarm

Alarm number	Alarm	Description
0	Inconsistent card type	The expected or actual circuit pack type in a slot is incapable of participating in the equipment protection group, either because it is not subject to equipment protection or because its type or equipment ID differs from that previously defined for the other cardholders of the group. When possible, the ONU should deny provisioning attempts that would create incompatibilities, for example, in the case of plug-and-play, it may not be possible to forestall the inconsistency.
1..207	Reserved	
208..223	Vendor-specific alarms	Not to be standardized

9.1.12 ONU remote debug

This ME is used to send vendor-specific debug commands to the ONU and receive vendor-specific replies back for processing on the OLT. This allows for the remote debugging of an ONU that may not be accessible by other means. The command format may have two modes, one being text and the other free format. In text format, both the command and reply are ASCII strings, but are otherwise unconstrained. In free format, the content and format of command and reply are vendor-specific.

An ONU that supports remote debugging automatically creates an instance of this ME. It is not reported during an MIB upload.

Relationships

One instance of this ME is associated with the ONU ME.

Attributes

Managed entity ID: This attribute uniquely identifies each instance of this ME. There is only one instance, number 0. (R) (mandatory) (2 bytes)

Command format: This attribute defines the format of the command and reply attributes. The value 0 defines ASCII string format, while 1 specifies free format. (R) (mandatory) (1 byte)

Command: This attribute is used to send a command to the ONU. The format of the command is defined by the command format. If the format is ASCII string, the command should be null terminated unless the string is exactly 25 bytes long. The action of setting this attribute should trigger the ONU to discard any previous command reply information and execute the current debugging command. (W) (mandatory) (25 bytes)

Reply table: This attribute is used to pass reply information back to the OLT. Its format is defined by the command format attribute. The get, get next action sequence must be used with this attribute, since its size is unspecified. (R) (mandatory) (N bytes)

Actions

Get, get next, set

Notifications

None.

9.1.13 ONU-E

This ME represents a point-to-point gigabit Ethernet-fed ONU as equipment, as defined in [ITU-T G.986]. The ONU automatically creates an instance of this ME. It assigns values to read-only attributes according to data within the ONU itself.

Relationships

In ITU-T G.986 applications, all other MEs in this Recommendation are related directly or indirectly to the ONU-E entity.

Attributes

Managed entity ID: This attribute uniquely identifies each instance of this ME. There is only one instance, number 0. (R) (mandatory) (R) (mandatory) (2 bytes)

Vendor ID: This attribute identifies the vendor of the ONU. Both the code set for the vendor_ID specified in [ATIS-0300220] and organizationally unique identifier (OUI) specified in clause 9 of [IEEE 802] may be applied to this attribute.

When the code set for the vendor_ID specified in [ATIS-0300220] is applied to this attribute, the four characters are mapped into the 4 byte field by concatenating the ASCII/ANSI character codes.

When the OUI is applied to this attribute, the three characters are mapped into the 4 byte field with 0xFF assigned to the first octet.

(R) (mandatory) (4 bytes)

Octet	Content	
	Vendor_ID in [ATIS-0300220]	OUI in [IEEE 802]
1	First byte of Vendor_ID	0xFF
2	Second byte of Vendor_ID	First byte of OUI
3	Third byte of Vendor_ID	Second byte of OUI
4	Fourth byte of Vendor_ID	Third byte of OUI

Version: This attribute identifies the version of the ONU as defined by the vendor. The character value "0" indicates that version information is not available or applicable. (R) (mandatory) (14 bytes)

Serial number: The serial number is unique for each ONU. It is defined by the vendor. The character value "0" indicates that serial number information is not available or applicable. (R) (mandatory) (8 bytes)

Actions

Get

Reboot: Reboot the ONU

Notifications

Alarm

Alarm number	Alarm	Description
0	Equipment alarm	Functional failure on an internal interface
1..207	Reserved	
208..223	Vendor-specific alarms	Not to be standardized

9.1.14 ONU dynamic power management control

This ME models the ONU's ability to enter power conservation modes in cooperation with the OLT in an ITU-T G.987 system. [ITU-T G.987.3] originally specified two alternative modes, doze and cyclic sleep. The subsequent revision of [ITU-T G.987.3] simplified the specification providing a single power conservation mode, watchful sleep.

An ONU that supports power conservation modes automatically creates an instance of this ME.

Relationships

One instance of this ME is associated with the ONU ME.

Attributes

Managed entity ID: This attribute uniquely identifies each instance of this ME. There is only one instance, number 0. (R) (mandatory) (2 bytes)

Power reduction management capability: This attribute declares the ONU's support for managed power conservation modes, as defined in [ITU-T G.987.3]. It is a bit map in which the bit value 0 indicates no support for the specified mode, while the bit value 1 indicates that the ONU does support the specified mode. (R) (mandatory) (1 byte)

Codepoints are assigned as follows:

Value	Meaning
0	No support for power reduction
1	Doze mode supported
2	Cyclic sleep mode supported
3	Both doze and cyclic sleep modes supported
4	Watchful sleep mode supported
5..255	Reserved

Power reduction management mode: This attribute enables one or more of the ONU's managed power conservation modes. It is a bit map in which the bit value 0 disables the mode, while the value 1 enables the mode. Bit assignments are the same as those of the power reduction management capability attribute. The default value of each bit is 0. (R, W) (mandatory) (1 byte)

Itransinit: This attribute is the ONU vendor's statement of the complete transceiver initialization time: the worst-case time required for the ONU to regain full functionality when leaving the asleep state in cyclic sleep mode or low-power state in watchful sleep mode (i.e., turning on both the receiver and the transmitter and acquiring synchronization to the downstream flow), measured in units of 125 μ s frames. The value zero indicates that the sleeping ONU can respond to a bandwidth grant without delay. (R) (mandatory) (2 bytes)

Itxinit: This attribute is the ONU vendor's statement of the transmitter initialization time: the time required for the ONU to regain full functionality when leaving the listen state (i.e., turning on the transmitter), measured in units of 125 μ s frames. The value zero indicates that the dozing ONU can respond to a bandwidth grant without delay. If watchful sleep is enabled, the ONU ignores this attribute. (R) (mandatory) (2 bytes)

Maximum sleep interval: The Isleep/Ilowpower attribute specifies the maximum time the ONU spends in its asleep, listen, or low-power states, as a count of 125 μ s frames. Local or remote events may truncate the ONU's sojourn in these states. The default value of this attribute is 0. (R, W) (mandatory) (4 bytes)

Maximum receiver-off interval: The Irxoff attribute specifies the maximum time the OLT can afford to wait from the moment it decides to wake up an ONU in the low-power state of the watchful sleep mode until the ONU is fully operational, specified as a count of 125 μ s frames. (R, W) (mandatory) (4 bytes)

Minimum aware interval: The Iaware attribute specifies the time the ONU spends in its aware state, as a count of 125 μ s frames, before it re-enters asleep or listen states. Local or remote events may independently cause the ONU to enter an active state rather than returning to a sleep state. The default value of this attribute is 0. (R, W) (mandatory) (4 bytes)

Minimum active held interval: The Ihold attribute specifies the minimum time during which the ONU remains in the active held state, as a count of 125 μ s frames. Its initial value is zero. (R, W) (mandatory) (2 bytes)

Maximum sleep interval extension: This attribute designates maximum sleep interval values for doze mode and cyclic sleep mode separately. When it supports this attribute, the ONU ignores the value of the maximum sleep interval attribute.

Maximum sleep interval for doze mode 4 bytes

Maximum sleep interval for cyclic sleep mode 4 bytes

Maximum sleep interval for doze mode specifies the maximum time the ONU spends in its listen state, as a count of 125 μ s frames. Local or remote events may truncate the ONU's sojourn in these states. The default value is 0.

Maximum sleep interval for cyclic sleep mode specifies the maximum time the ONU spends in its asleep state, as a count of 125 μ s frames. Local or remote events may truncate the ONU's sojourn in these states. The default value is 0. If watchful sleep is enabled, the ONU ignores this attribute.

(R, W) (optional) (8 bytes)

Ethernet passive optical network (EPON) capability extension: This attribute declares EPON-specific capabilities for the dynamic power management control.

Bits are assigned as follows.

Bit	Name	Setting
1 (LSB)	AckCapable	0: not supported 1: supported
2	Sleep indication capability	0: not supported 1: supported
3	Early wake-up capability	0: not supported 1: supported
4	Sleep mode selection at ONU's discretion	0: not supported 1: supported

AckCapable has the value of supported if the ONU is capable of sending a SLEEP_ACK message, which is defined in [IEEE P1904.1], in response to the SLEEP_ALLOW message from the OLT. The ONU may select the appropriate power conservation method by itself if AckCapable is supported.

Sleep indication capability represents ability to send a SLEEP_INDICATION message, defined in [IEEE P1904.1], to initiate the power saving cycle from the ONU.

Early wake-up capability shows whether the ONU has a function in which the ONU can awaken from the sleep mode based on local conditions such as off-hook condition on SIP ports and power down.

ONU self-sleep mode selection indicates whether the ONU has a function to choose the appropriate power conservation method by itself if the SLEEP_ALLOW message, defined in [ITU-T G.epon], designates the ONU to enter low-power sleep mode with a Tx or TRx SleepMode option. (Tx mode which is defined in [IEEE P1904.1] is equivalent to doze mode, and TRx mode which is also defined in [IEEE P1904.1] is equivalent to cyclic sleep mode.)

(R) (optional) (1 byte)

NOTE – The dynamic power management control in EPON is basically the same as the function in [ITU-T G.987.3]. That is EPON has two types of power-down modes which are equivalent to doze mode and cyclic sleep mode, where the former is defined as Tx mode and the latter is defined as TRx mode in [IEEE P1904.1].

However EPON has some differences from [ITU-T G.987.3] equivalent Tx mode or TRx mode:

- EPON may be operated without the SLEEP_ACK message (which is equivalent to Sleep_Request message in [ITU-T G.987.3])
- An EPON ONU may initiate the dynamic power management control sequence by an EPON-specific SLEEP_INDICATION message.
- EPON may be operated without the early wake-up sequence, which is equivalent to the transition to a full power state by local wake-up indications (LWI) of ONU in [ITU-T G.987.3].
- An EPON ONU may have no capability to choose Tx or TRx mode by itself. Therefore, the OLT can designate the ONU to enter a specific power-down mode in either explicit or implicit ways.

To negotiate the power management mode, the ONU indicates its capabilities by this attribute and then the OLT configures the ONU with the EPON setup extension attribute. In case of the following capabilities and configurations, an EPON system performs the same power-saving function as [ITU-T G.987.3].

- Capabilities:
 - AckCapable = supported,
 - Sleep indication capability = N/A,
 - Early wake-up capability = supported,
 - ONU self-sleep mode selection = supported
- Configurations:
 - ackEnable configuration = enable,

Sleep indication configuration = disable,
Early wake-up configuration = enable

EPON setup extension: This attribute specifies EPON specific configurations for the dynamic power management control.

The bits are assigned as follows.

Bit	Name	Setting
1 (LSB)	ackEnable configuration	0: disable 1: enable
2	Sleep indication configuration	0: disable 1: enable
3	Early wake-up configuration	0: disable 1: enable
4..8	Reserved	0

Each bit corresponds to bit 1-3 of the EPON capability extension and the OLT may enable each bit if the capability is supported or true. If the capability is not supported, the bit has no effect.

If the OLT does not designate configurations by the EPON setup extension, the ONU uses the following default values unless they are not supported.

ackEnable configuration = enable,
Sleep indication configuration = disable,
Early wake-up configuration = enable

(R, W) (optional) (1 byte)

Missing consecutive bursts threshold: The $Clob_i$ attribute specifies the maximum number of missing consecutive scheduled bursts from the ONU that the OLT is willing to tolerate without raising an alarm. The value of this attribute defaults to 4.
(R, W) (mandatory) (4 bytes)

Actions

Get, set

Notifications

None.

9.1.15 ONU3-G

This ME contains additional attributes and alarms associated with a PON ONU. The ONU automatically creates an instance of this ME. Its attributes are populated according to data within the ONU itself.

Upon instantiation of this ME, the Total number of status snapshots S , the Number of valid status snapshots M , and Next status snapshot index K are populated from the non-volatile memory. If the non-volatile memory values are not available (e.g., at the initialization of an off-the-shelf ONU), the Total number of status snapshots attribute is set to the maximum size of the status snapshot record table the ONU can maintain, which is a static capability parameter, while both the Number of valid status snapshots and the Next status snapshot index attributes are set to zero.

The Status snapshot record table is implemented as a circular buffer containing up to S records of size N . The size and format of the snapshot record are vendor-specific. Each time the ONU takes and stores a status snapshot, it increments the Number of valid status snapshots M , saturating at S , and increments Next status snapshot index K in modulo S :

$$K := (K + 1) \bmod S.$$

By writing into the Snap action attribute, the OLT instructs the ONU to immediately take a status snapshot and to store it in the Status snapshot table. By writing into Reset action attribute, the OLT instructs the ONU to erase the Status snapshot record table. The OLT uses the AVC indication of the Next status snapshot index and Number of valid status snapshots attributes to confirm that its instructions have been executed by the ONU. If the OLT has issued no Snap action instructions, a change in the value of Next status snapshot index attributes between two consecutive reads indicates that a condition has arisen that has caused the ONU to record a status snapshot.

Two table attributes, the Status snapshot record table, and the Most recent status snapshot, provide the OLT access to the status snapshot records. The former allows the entire Status snapshot record table to be retrieved, the latter provides quick access to the latest snapshot record.

By performing the Get operation on the Most recent status snapshot, the OLT can obtain the vendor-specific size of an individual snapshot record. The OLT is expected to pass the status snapshot records transparently, without parsing or interpreting them.

Relationships

This ME is associated with the ONU-G ME.

Attributes

Managed entity ID: This attribute uniquely identifies each instance of this ME. There is only one instance, number 0. (R) (mandatory) (2 bytes)

Flash memory performance value: A number in the range from 0 to 100 that characterizes the condition of the flash memory, with 0 representing factory fresh device, 100 representing end of life. This attribute is vendor-specific and should be calculated at the discretion of the vendor. (R) (optional) (1 byte)

Latest restart reason: The following code points are defined:

0x00 – Unspecified other;

0x01 – OLT initiated software restart remotely by OMCI/PLOAM;

0x02 – User initiated hardware restart;

0x03 – Self-monitor timer expiration;

0x04 – Hardware error (bus time-out, misaligned memory access, etc.);

0x05 – Hardware auto-restart (on-board voltage monitor auto-restart, etc.);

0x06 – Over temperature;

0x07 – Software out of memory;

0x08 – Software auto-restart (unresolvable references, critical internal inconsistency);

0x09 - User initiated software restart locally by CLI/WEB;

0x0A..0xDC – Reserved for future use;

0xDD..0xFF – Reserved for the ONU vendor use.

Other codepoints reserved. (R) (mandatory) (1 byte)

Total number of status snapshots: The maximum size S of the status snapshot record table. (R) (mandatory) (2 bytes)

Number of valid status snapshots: The number M of valid status snapshot records. (R) (mandatory) (2 bytes)

Next status snapshot index: This attribute identifies the index (ranging from 0 to $S - 1$) of the next snapshot record to be taken in the snapshot record table. (R,) (mandatory) (2 bytes)

Status snapshot record table: The table of M status snapshot records. The size N and format of the snapshot record is vendor dependent. (R) (mandatory) ($M \times N$ bytes)

Snap action: Once the OLT writes this attribute, the ONU takes and records an urgent snapshot without shutting down the transceiver. (W) (mandatory) (1 byte)

Most recent status snapshot: This attribute provides access to the most recently taken status snapshot record. (R) (mandatory) (N bytes)

Reset action: Once the OLT writes this attribute, the ONU sets the Number of valid status snapshots and Next status snapshot index attributes to zero. (W) (mandatory) (1 byte)

Enhanced mode: The Boolean value true specifies the Enhanced received frame classification and processing table is supported by the Extended VLAN tagging operation configuration ME. The value false indicates the Enhanced received frame classification and processing table is not supported. (R) (optional) (1 byte)

Actions

Get, get-next, set

Notifications

Attribute value change

Number	Attribute value change	Description
1	Flash mem perf	Flash memory performance value change
2	N/A	
3	N/A	
4	No of valid snapshots	A new snapshot has been recorded
5	N/A	
6	N/A	
7	N/A	
8..16	Reserved	

Alarm

Alarm number	Alarm	Description
0	Flash memory performance yellow	
1	Flash memory performance red	
2	Loss of redundant power supply	In an ONU with redundant power supplies, an indication of the loss of one of the two redundant power supplies.
3	Loss of redundant power feed	In an ONU with dual -48DC power feeds, an indication of the loss of one of the two power feeds.

Alarm

Alarm number	Alarm	Description
4	Ground Fault	Ground fault; ONU has detected a loss of grounding or a degradation in the ground connection.

9.1.16 ONU manufacturing data

This ME contains additional manufacturing attributes associated with a PON ONU. The manufacturing data is expected to match the content of an ONU label. The ONU automatically creates an instance of this ME. Its attributes are populated according to data within the ONU itself.

Relationships

This ME is paired with the ONU-G entity.

Attributes

Managed entity ID: This attribute uniquely identifies each instance of this ME. There is only one instance, number 0. (R) (mandatory) (2 bytes)

Manufacturer name: This attribute contains the manufacturer name of this physical ONU. The preferred value is the manufacturer name string printed on the ONU itself (if present). (R) (optional) (25 bytes)

Serial number part 1, serial number part 2: These two attributes may be regarded as an ASCII string of up to 32 bytes whose length is a left justified manufacturer's serial number for this physical ONU. The preferred value is the manufacturer serial number string printed on the ONU itself (if present). (R) (optional) (25 bytes*2 attributes)

Model name: This attribute contains the vendor specific model name identifier string. The preferred value is the customer-visible part number which may be printed on the component itself. (R) (optional) (25 bytes)

Manufacturing date: This attribute contains the date of manufacturer of this physical ONU. The preferred value is the date of the manufacturer printed on the ONU itself (if present). (R) (optional) (25 bytes)

Hardware-revision: This attribute contains the hardware revision of this physical ONU. The preferred value is the hardware revision printed on the ONU itself (if present). (R) (optional) (25 bytes)

Firmware-revision: This attribute contains the vendor specific firmware revision of this physical ONU. (R) (optional) (25 bytes)

Actions

Get

Notifications

None

9.1.17 ONU time configuration

This ME provides characterization and manipulation of OLT timestamp information. An ONU that uses OLT-based time synchronization methods automatically creates an instance of this ME. There is no intention that this ME be used to establish a precise time of day reference.

Relationships

The single instance of this ME is associated with the ONU ME.

Attributes

Managed entity ID: This attribute uniquely identifies each instance of this ME. There is only one instance, number 0. (R) (mandatory) (2 bytes)

Current local ONU time: If the ONU has a real-time clock, it returns the local ONU time. This attribute returns the current ONU time. The local ONU time and synchronize time time-format is the same. (R) (mandatory) (7 bytes)

Byte	Description
1-2	Year, e.g., 2009
3	Month, range 1..12
4	Day of month, range 1..31
5	Hour of day, range 0..23
6	Minute of hour, range 0..59
7	Second of minute, range 0..59

Time qualification block: This attribute describes the time-qualification to be applied to the ONU RTC local time. The following fields are supported:

Bits															
16	15	14	13	12	11	10	9	8	7	6	5	4	3	2	1
Time qualification	Timezone offset	Reserved	RFC 3339 time offset sign	RFC 3339 minutes offset (from UTC time)											

where

Time qualification (1-bit)	This attribution qualifies the OLT time. Valid values are: 0 The OLT is locally timed 1 The OLT timestamps are UTC timestamped
Timezone information (1-bit)	This attribute governs the time offset behaviour of the ONU RTC: 0 No timezone offset information 1 Timezone offset provided in the RFC 3339 time offset

RFC 3339 Time offset sign (from UTC time) (1-bit)	RFC 3339 Timesone offset sign. A value of 0 indicates a positive offset and a 1 indicates a negative offset
RFC 3339 minutes offset (from UTC time) (11-bits)	Describes the RFC 3339 minutes offset

(R, W) (mandatory) (2 bytes)

Actions

Get, set

Notifications

None.

9.1.18 ONU operational performance monitoring history data

This managed entity collects performance monitoring data associated with the ONU instances of this managed entity are created and deleted by the OLT.

For a complete discussion of generic PM architecture, refer to clause I.4.

Relationships

An instance of this ME is associated with the ONU-G managed entity.

Attributes

Managed entity ID: This attribute uniquely identifies each instance of this ME. There is only one instance, number 0. (R) (mandatory) (2 bytes)

Interval end time: This attribute identifies the most recently finished 15 min interval. (R) (mandatory) (1 byte)

Threshold data 1/2 ID: This attribute points to an instance of the threshold data 1 managed entity that contains PM threshold values. Since no threshold value attribute number exceeds 7, a threshold data 2 ME is optional. (R, W, Set by create) (mandatory) (2 bytes)

Temperature sensor value: A table of one-byte temperature sensor values, each being represented by a 2s complement integer that specifies the average temperature of the ONU temperature sensor(s) during the measurement interval. Valid values are -40 to $+127$ °C in 1 °C increments. The special values: 0x80 indicates that the temperature sensor is not available; 0x81, that the sensor has malfunctioned. (R) (mandatory) (N byte)

NOTE – Sampling rates of temperature are outside the scope of this specification).

Temperature sensor description: A table of 25-byte long temperature sensor descriptions, each represented by a character string that includes the physical location on the ONU or the component being measured. Strings shorter than 25 bytes are padded with null characters. (R) (mandatory) (25N bytes).

BEST PRACTICE NOTE: The order of the temperature sensor description and temperature sensor values should match and be maintained. Care should be taken that the temperature sensor names do not change across measurement intervals nor ONU reboots. A temperature sensor name may change as a result of a ONU software upgrade (when a new sensor is reported upon).

CPU percent utilization: The maximum system CPU utilization (high water mark) during the measurement interval. For multi-processor systems, the CPU utilization values are global maximum across all processors (e.g., if one core is 50% CPU utilization, 3 other cores are 10% CPU utilization, the global CPU utilization is 50%). This attribute is an integer ranging from 0 to 100. A value of 100 indicates that at least one CPU was fully utilized, and a value of 0 indicates all

the CPUs were idle during the measurement interval. The value of 0xFF indicates that no reliable measurement is available. (R) (mandatory) (1 byte)

RAM size available ~~amount~~: The minimum RAM size (in Megabytes) available during the measurement interval. This attribute is an integer from 1 to $2^{32} - 2$. The value of 0xFFFFFFFF indicates that RAM size report is not reliable. (R) (mandatory) (4 bytes)

RAM utilization: The maximum RAM size (in Megabytes) utilized during the measurement interval. This attribute is an integer from 0 to $2^{32} - 2$. The value of 0xFFFFFFFF indicates that no reliable measurement is available. (R) (mandatory) (4 bytes)

FLASH size available: The minimum FLASH size (in Megabytes) available during the measurement interval. This attribute is an integer from 1 to $2^{32} - 2$. The value of 0xFFFFFFFF indicates that FLASH size report is not reliable. (R) (mandatory) (4 bytes)

FLASH utilization: The maximum FLASH size (in Megabytes) utilized during the measurement interval. This attribute is an integer from 0 to $2^{32} - 2$. The value of 0xFFFFFFFF indicates that no reliable measurement is available. (R) (mandatory) (4 bytes)

Software errors: A count of the number of software errors detected. A software error is an error, flaw, failure or fault in a computer program that causes it to produce an incorrect or unexpected result, or to behave in unintended ways. Examples include internal logical inconsistencies, division by zero, referencing to non-existent memory, writing to read-only-memory and "exceptions" in certain programming languages (such as C++ and Java) (R) (mandatory) (4 bytes)

Errors in operations: A count of the number of detected errors in operations, not due to a software error. Examples include reading MEs that do not exist, provisioning services on entities that do not exist, deleting entities that do not exist. (R) (mandatory) (4 bytes)

Actions

Create, delete, get, get next, set

Notifications

Threshold crossing alert

Alarm number	Threshold crossing alert	Threshold value attribute No. (Note)
0	CPU utilization	1
1	RAM utilization	2
2	FLASH utilization	3
3	Software errors	4
4	Errors in operations	5
NOTE – This number associates the TCA with the specified threshold value attribute of the threshold data 1 managed entity.		

9.1.19 ONU4-G

The ONU4-G describes the ONU's ANI line rate buffering capabilities, in both upstream and downstream direction. It defines the sustained MAC client interface rate and the rate adaptation buffer (RAB) size that the ONU supports as shown in Figure 9.1.19-1. If the OLT does not take these factors into account in its downstream shaping or upstream BWmap generation, then that may result in packet drop in the downstream direction and waste of bandwidth in the upstream direction.

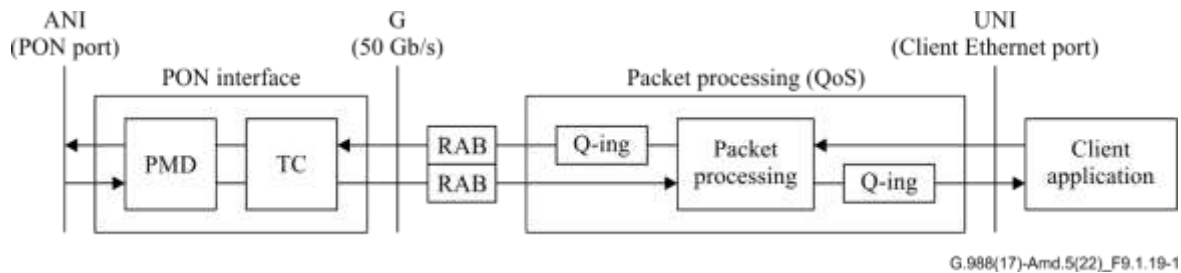

Figure 9.1.19-1 – ONU rate adaptation buffer model

This ME is autonomously created by the ONU.

Relationships

This ME is associated with an ONU-G ME.

Attributes

Managed entity ID: This attribute uniquely identifies each instance of this ME. There is only one instance, number 0. (R) (mandatory) (2 bytes)

Sustained downstream MAC client rate: This attribute specifies the sustained downstream MAC client rate this ONU is capable to receive, in 10 Mbit/s units. (R) (mandatory) (2 bytes)

Downstream RAB size: Indicates the size of the downstream rate adaptation buffer, expressed in 1024-byte blocks. A minimum size of 128 blocks is recommended. (R) (mandatory) (2 bytes)

Sustained upstream MAC client rate: This attribute specifies the sustained upstream MAC client rate this ONU is capable to transmit, in 10 Mbit/s units. (R) (mandatory) (2 bytes)

Upstream RAB size: Indicates the size of the upstream rate adaptation buffer, expressed in 1024-byte blocks. A minimum size of 128 blocks is recommended. (R) (mandatory) (2 bytes)

Actions

Get

Notifications

None

9.2 ANI management, traffic management

9.2.1 ANI-G

This ME organizes data associated with each access network interface supported by a G-PON ONU. The ONU automatically creates one instance of this ME for each PON physical port.

Relationships

An instance of this ME is associated with each instance of a physical PON interface.

Attributes

Managed entity ID: This attribute uniquely identifies each instance of this ME. Its value indicates the physical position of the PON interface. The first byte is the slot ID, defined in clause 9.1.5. The second byte is the port ID. (R) (mandatory) (2 bytes)

SR indication: This Boolean attribute indicates the ONU's capability to report queue status for DBA. The value true means that status reporting is available for all T-CONTs that are associated with the ANI. (R) (mandatory) (1 byte)

Total T-CONT number: This attribute indicates the total number of T-CONTs that can be supported on this ANI. (R) (mandatory) (2 bytes)

GEM block length: This attribute specifies the queue occupancy reporting granularity for DBA, expressed in bytes. This attribute is meaningful only in ITU-T G.984.x systems. (R, W) (mandatory) (2 bytes)

In ITU-T G.984 systems, the value set by the OLT is used by all T-CONTs on this ANI. Upon ME instantiation, the ONU sets this attribute to 48. See [ITU-T G.984.3] for further details.

In all other ITU-T PON systems, the unit for queue occupancy reporting is fixed in at 4 bytes by the respective TC layer specification.

Piggyback DBA reporting: This attribute indicates the ONU's piggyback DBA reporting format capabilities. [ITU-T G.984.3] defines two possible piggyback reporting modes. For reporting mode 0, the single field is the entire report. For reporting mode 1, the DBA report is two fields long. Mode 0 is mandatory for ITU-T G.984 ONUs that support piggyback DBA reporting; mode 1 is optional. Subsequent PON specifications allows only one mode, which should be reported in this attribute as code point 0.

The following coding indicates the ONU's piggyback DBA reporting mode capabilities:

- 0 Mode 0 only
- 1 Modes 0 and 1
- 2 Deprecated
- 3 Deprecated
- 4 Piggyback DBA reporting not supported

(R) (mandatory) (1 byte)

Deprecated: This attribute should be set to 0 by the ONU and ignored by the OLT. (R) (mandatory) (1 byte)

Signal fail (SF) threshold: This attribute specifies the downstream bit error rate (BER) threshold to detect the SF alarm. When this value is y , the BER threshold is 10^{-y} . Valid values are 3..8. Upon ME instantiation, the ONU sets this attribute to 5. (R, W) (mandatory) (1 byte)

Signal degrade (SD) threshold: This attribute specifies the downstream BER threshold to detect the SD alarm. When this value is x , the BER threshold for SD is 10^{-x} . Valid values are 4..10. The SD threshold must be lower than the SF threshold; i.e., $x > y$. Upon ME instantiation, the ONU sets this attribute to 9. (R, W) (mandatory) (1 byte)

ARC: See clause A.1.4.3. (R, W) (optional) (1 byte)

ARC interval: See clause A.1.4.3. (R, W) (optional) (1 byte)

Optical signal level: This attribute reports the current measurement of the total downstream optical signal level. Its value is a 2s complement integer referred to 1 mW (i.e., 1 dBm), with 0.002 dB granularity. (R) (optional) (2 bytes)

Lower optical threshold: This attribute specifies the optical level the ONU uses to declare the downstream low received optical power alarm. Valid values are –127 dBm (coded as 254) to 0 dBm (coded as 0) in 0.5 dB increments. The default value 0xFF selects the ONU's internal policy. (R, W) (optional) (1 byte)

Upper optical threshold: This attribute specifies the optical level the ONU uses to declare the downstream high received optical power alarm. Valid values are –127 dBm (coded as 254) to 0 dBm (coded as 0) in 0.5 dB increments. The default value 0xFF selects the ONU's internal policy. (R, W) (optional) (1 byte)

ONU response time: This attribute indicates the ONU's actual response time. This attribute is in the range 34..36 μs. Although this attribute is expressed in nanoseconds, its accuracy is likely to be more coarse. Furthermore, the value may change from one activation cycle to the next. Valid values are:

- 0 (Null, function not supported)
- 34000 to 36000 (response time in nanoseconds)
- All other values reserved

(R) (optional) (2 bytes)

Transmit optical level: This attribute reports the current measurement of mean optical launch power. Its value is a 2s complement integer referred to 1 mW (i.e., 1 dBm), with 0.002 dB granularity. (R) (optional) (2 bytes)

Lower transmit power threshold: This attribute specifies the minimum mean optical launch power that the ONU uses to declare the low transmit optical power alarm. Its value is a 2s complement integer referred to 1 mW (i.e., dBm), with 0.5 dB granularity. The default value –63.5 (0x81) selects the ONU's internal policy. (R, W) (optional) (1 byte)

Upper transmit power threshold: This attribute specifies the maximum mean optical launch power that the ONU uses to declare the high transmit optical power alarm. Its value is a 2s complement integer referred to 1 mW (i.e., dBm), with 0.5 dB granularity. The default value –63.5 (0x81) selects the ONU's internal policy. (R, W) (optional) (1 byte)

Actions

Get, set

Test: Test the ANI-G. The test action can be used to perform optical line supervision tests; refer to Annex A.

Notifications

Attribute value change

Number	Attribute value change	Description
1..7	N/A	
8	ARC	Alarm-reporting control cancellation
9..16	N/A	

Alarm

Alarm number	Alarm	Description
0	Low received optical power	Received downstream optical power below threshold.
1	High received optical power	Received downstream optical power above threshold.
2	SF	Bit error-based signal fail. Industry practice normally expects the BER to improve by at least an order of magnitude before clearing the alarm.
3	SD	Bit error-based signal degrade. Industry practice normally expects the BER to improve by at least an order of magnitude before clearing the alarm.
4	Low transmit optical power	Transmit optical power below lower threshold
5	High transmit optical power	Transmit optical power above upper threshold
6	Laser bias current	Laser bias current above threshold determined by vendor; laser end of life pending
7..207	Reserved	
208..223	Vendor-specific alarms	Not to be standardized

Test result: The ONU may report a test result autonomously if it performs self-test functions autonomously.

9.2.2 T-CONT

An instance of the traffic container ME T-CONT represents a logical connection group associated with a G-PON PLOAM layer alloc-ID. A T-CONT can accommodate GEM packets in priority queues or traffic schedulers that exist in the GEM layer.

The ONU autonomously creates instances of this ME. The OLT can discover the number of T-CONT instances via the ANI-G ME. When the ONU's MIB is reset or created for the first time, all supported T-CONTs are created. The OLT provisions alloc-IDs to the ONU via the PLOAM channel. Via the OMCI, the OLT must then set the alloc-ID attributes in the T-CONTs that it wants to activate for user traffic, to create the appropriate association with the allocation ID in the PLOAM channel. There should be a one-to-one relationship between allocation IDs and T-CONT MEs; the connection of multiple T-CONTs to a single allocation ID is undefined.

The allocation ID that matches the ONU-ID itself is defined to be the default alloc-ID. This alloc-ID is used to carry the OMCC. The default alloc-ID can also be used to carry user traffic, and hence can be assigned to one of the T-CONT MEs. However, this OMCI relationship only pertains to user traffic, and the OMCC relationship is unaffected. It can also be true that the OMCC is not contained in any T-CONT ME construct; rather, that the OMCC remains outside of the OMCI, and that the OMCI is not used to manage the OMCC in any way. Multiplexing of the OMCC and user data in G-PON systems is discussed in clause B.2.4.

Relationships

One or more instances of this ME are associated with an instance of a circuit pack that supports a PON interface function, or with the ONU-G itself.

Attributes

Managed entity ID: This attribute uniquely identifies each instance of this ME. This 2 byte number indicates the physical capability that realizes the T-CONT. It may be represented as 0xSSBB, where SS indicates the slot ID that contains this T-CONT (0 for the ONU as a whole), and BB is the T-CONT ID, numbered by the ONU itself. T-CONTs are numbered in ascending order, with the range 0..255 in each slot. (R) (mandatory) (2 bytes)

Alloc-ID: This attribute links the T-CONT with the alloc-ID assigned by the OLT in the assign_alloc-ID PLOAM message. The respective TC layer specification should be referenced for the legal values for that system. Prior to the setting of this attribute by the OLT, this attribute has an unambiguously unusable initial value, namely the value 0x00FF or 0xFFFF for ITU-T G.984 systems, and the value 0xFFFF for all other ITU-T GTC based PON systems. (R, W) (mandatory) (2 bytes)

Deprecated: The ONU should set this attribute to the value 1, and the OLT should ignore it. (R) (mandatory) (1 byte)

Policy: This attribute indicates the T-CONT's traffic scheduling policy. Valid values:

- 0 Null
- 1 Strict priority
- 2 WRR – Weighted round robin

(R, W) (mandatory) (1 byte)

NOTE – This attribute is read-only, unless otherwise specified by the QoS configuration flexibility attribute of the ONU2-G ME. If flexible configuration is not supported, the ONU should reject an attempt to set it with a parameter error result-reason code.

Actions

Get, set

Notifications

None.

9.2.3 GEM port network CTP

This ME represents the termination of a GEM port on an ONU. This ME aggregates connectivity functionality from the network view and alarms from the network element view as well as artefacts from trails.

Instances of the GEM port network CTP ME are created and deleted by the OLT. An instance of GEM port network CTP can be deleted only when no GEM IW TP or GEM port network CTP PM history data are associated with it. It is the responsibility of the OLT to make sure that the ONU configuration meets this condition.

In ITU-T G.984 systems, when a GEM port network CTP is created, its encryption state is by default not encrypted. If the OLT wishes to configure the GEM port to use encryption, it must send the appropriate PLOAM message. This applies equally to new CTPs and to CTPs that are re-created after an MIB reset.

In ITU-T G.987 systems, GEM ports are dynamically encrypted. If it is intended to encrypt the GEM port, the OLT must configure a key ring to be used, and the key must be known to the ONU at run time.

Relationships

An instance of the GEM port network CTP ME may be associated with an instance of the T-CONT and GEM IW TP MEs.

Attributes

Managed entity ID: This attribute uniquely identifies each instance of this ME. (R, set-by-create) (mandatory) (2 bytes)

Port-ID: This attribute is the port-ID of the GEM port associated with this CTP. (RWSC) (mandatory) (2 bytes)

NOTE 1 – While nothing forbids the existence of several GEM port network CTPs with the same port-ID value, downstream traffic is modelled as being delivered to all such GEM port network CTPs. Be aware of potential difficulties associated with defining downstream flows and aggregating PM statistics.

T-CONT pointer: This attribute points to a T-CONT instance. (R, W, set-by-create) (mandatory) (2 bytes)

Direction: This attribute specifies whether the GEM port is used for UNI-to-ANI (1), ANI-to-UNI (2), or bidirectional (3) connection. (R, W, set-by-create) (mandatory) (1 byte)

Traffic management pointer for upstream: If the traffic management option attribute in the ONU-G ME is 0 (priority controlled) or 2 (priority and rate controlled), this pointer specifies the priority queue ME serving this GEM port network CTP. If the traffic management option attribute is 1 (rate controlled), this attribute redundantly points to the T-CONT serving this GEM port network CTP. (R, W, set-by-create) (mandatory) (2 bytes)

Traffic descriptor profile pointer for upstream: This attribute points to the instance of the traffic descriptor ME that contains the upstream traffic parameters for this GEM port network CTP. This attribute is used when the traffic management option attribute in the ONU-G ME is 1 (rate controlled), specifying the PIR/PBS to which the upstream traffic is shaped. This attribute is also used when the traffic management option attribute in the ONU-G ME is 2 (priority and rate controlled), specifying the CIR/CBS/PIR/PBS to which the upstream traffic is policed. (R, W, set-by-create) (optional) (2 bytes)

See also Appendix II.

UNI counter: This attribute reports the number of instances of UNI-G ME associated with this GEM port network CTP. (R) (optional) (1 byte)

Priority queue pointer for downstream: This attribute points to the instance of the priority queue used for this GEM port network CTP in the downstream direction. It is the responsibility of the OLT to provision the downstream pointer in a way that is consistent with the bridge and mapper connectivity. If the pointer is null, downstream queueing is determined by other mechanisms in the ONU. (R, W, set-by-create) (mandatory) (2 bytes)

NOTE 2 – If the GEM port network CTP is associated with more than one UNI (downstream multicast), the downstream priority queue pointer defines a pattern (e.g., queue number 3 for a given UNI) to be replicated (i.e., to queue number 3) at the other affected UNIs.

Encryption state: This attribute indicates the current state of the GEM port network CTP's encryption. Legal values are defined to be the same as those of the security

mode attribute of the ONU2-G, with the exception that attribute value 0 indicates an unencrypted GEM port. (R) (optional) (1 byte)

Traffic descriptor profile pointer for downstream: This attribute points to the instance of the traffic descriptor ME that contains the downstream traffic parameters for this GEM port network CTP. This attribute is used when the traffic management option attribute in the ONU-G ME is 1 (rate controlled), specifying the PIR/PBS to which the downstream traffic is shaped. This attribute is also used when the traffic management option attribute in the ONU-G ME is 2 (priority and rate controlled), specifying the CIR/CBS/PIR/PBS to which the downstream traffic is policed. (R, W, set-by-create) (optional) (2 bytes)

See also Appendix II.

Encryption key ring: This attribute is defined in ITU-T G.987 systems only. It specifies whether the associated GEM port is encrypted, and if so, which key ring it uses. (R, W, set-by-create) (optional) (1 byte)

- 0 (default) No encryption. The downstream key index is ignored, and upstream traffic is transmitted with key index 0.
- 1 Unicast payload encryption in both directions. Keys are generated by the ONU and transmitted to the OLT via the PLOAM channel.
- 2 Broadcast (multicast) encryption. Keys are generated by the OLT and distributed via the OMCI.
- 3 Unicast encryption, downstream only. Keys are generated by the ONU and transmitted to the OLT via the PLOAM channel.

Other values are reserved.

Actions

Create, delete, get, set

Notifications

Alarm

Alarm number	Alarm	Description
0..4	Reserved	
5	End-to-end loss of continuity	Loss of continuity can be detected when the GEM port network CTP supports a GEM interworking termination point (optional).
6..207	Reserved	
208..223	Vendor-specific alarms	Not to be standardized

9.2.4 GEM interworking termination point

An instance of this ME represents a point in the ONU where the IW of a bearer service (usually Ethernet) to the GEM layer takes place. At this point, GEM packets are generated from the bearer bit stream (e.g., Ethernet) or the bearer bit stream is reconstructed from GEM packets.

Instances of this ME are created and deleted by the OLT.

Relationships

One instance of this ME exists for each transformation of a data stream into GEM frames and *vice versa*.

Attributes

Managed entity ID: This attribute uniquely identifies each instance of this ME. (R, set-by-create) (mandatory) (2 bytes)

GEM port network CTP connectivity pointer: This attribute points to an instance of the GEM port network CTP. (R, W, set-by-create) (mandatory) (2 bytes)

Interworking option: This attribute identifies the type of non-GEM function that is being interworked. The options are as follows.

- 0 Circuit-emulated TDM
- 1 MAC bridged LAN
- 2 Reserved
- 3 Reserved
- 4 Video return path
- 5 IEEE 802.1p mapper
- 6 Downstream broadcast
- 7 MPLS PW TDM service

(R, W, set-by-create) (mandatory) (1 byte)

Service profile pointer: This attribute points to an instance of a service profile:

- CES service profile if IW option = 0
- MAC bridge service profile if IW option = 1
- Video return path service profile if IW option = 4
- IEEE 802.1p mapper service profile if IW option = 5
- Null pointer if IW option = 6
- CES service profile if IW option = 7

(R, W, set-by-create) (mandatory) (2 bytes)

NOTE – The video return path (VRP) service profile is defined in [ITU-T G.984.4].

Interworking termination point pointer: This attribute is used for the CES and IEEE 802.1p mapper service without a MAC bridge. Depending on the service provided, it points to the associated instance of the following MEs:

- PPTP CES UNI
- Logical $N \times 64$ kbit/s sub-port CTP
- PPTP Ethernet UNI

In all other GEM services, the relationship between the related service TP and this GEM IW TP is derived from other ME relations; this attribute is set to a null pointer and not used. (R, W, set-by-create) (mandatory) (2 bytes)

PPTP counter: This value reports the number of PPTP ME instances associated with this GEM IW TP. (R) (optional) (1 byte)

Operational state: This attribute indicates whether the ME is capable of performing its function. Valid values are enabled (0) and disabled (1). (R) (optional) (1 byte)

GAL profile pointer: This attribute points to an instance of the GAL profile. The relationship between the IW option and the related GAL profile is as follows.

- | Interworking option | GAL profile type |
|---------------------|---------------------------------------------|
| 0 | Null pointer |
| 1 | GAL Ethernet profile |
| 3 | GAL Ethernet profile for data service |
| 4 | GAL Ethernet profile for video return path |
| 5 | GAL Ethernet profile for IEEE 802.1p mapper |
| 6 | Null pointer |

(R, W, set-by-create) (mandatory) (2 bytes)

GAL loopback configuration: This attribute sets the loopback configuration when using GEM mode:

- 0 No loopback
- 1 Loopback of downstream traffic after GAL

The default value of this attribute is 0. When the IW option is 6 (downstream broadcast), this attribute is not used. (R, W) (mandatory) (1 byte)

Actions

Create, delete, get, set

Notifications

Attribute value change

Number	Attribute value change	Description
1..5	N/A	
6	Op state	Operational state change
7..8	N/A	
9..16	Reserved	

Alarm

Alarm number	Alarm	Description
0	Deprecated	
1..207	Reserved	
208..223	Vendor-specific alarms	Not to be standardized

9.2.5 Multicast GEM interworking termination point

An instance of this ME represents a point in a G-PON ONU where a multicast service interworks with the GEM layer. At this point, a multicast bit stream is reconstructed from GEM packets.

Instances of this ME are created and deleted by the OLT.

Multicast interworking GEM modes of operation

The default multicast operation of the PON is where all the multicast content streams are carried in one PON layer connection (GEM port). This connection is then specified in the first entry of the IPv4 or IPv6 multicast address table, as the case may be. This single entry also specifies an all-inclusive IP multicast destination address (DA) range (e.g., 224.0.0.0 to 239.255.255.255 in the case of IPv4). The ONU then filters the traffic based on either Ethernet MAC addresses or IP addresses. The associated GEM port network CTP ME specifies the GEM port-ID that supports all multicast connections.

In the default multicast operation, all multicast content streams are placed in one PON layer connection (GEM port). The OLT sets up a completely conventional model, a pointer from the multicast GEM IW termination to a GEM port network CTP. The OLT configures the GEM port-ID of the GEM port network CTP into the appropriate multicast address table attribute(s), along with the other table fields that specify the range of IP multicast DAs. The ONU accepts the entire multicast stream through the designated GEM port, then filters the traffic based on either the Ethernet MAC

address or IP DA.

An optional multicast configuration supports separate multicast streams carried over separate PON layer connections, i.e., on separate GEM ports. This permits the ONU to filter multicast streams at the GEM level, which is efficient in hardware, while ignoring other multicast streams that may be of interest to other ONUs on the PON.

After configuring the explicit model for the first multicast GEM port, the OLT supports multiple multicast GEM ports by then configuring additional entries into the multicast address table(s), entries with different GEM port-IDs. The OMCI model is defined such that these ports are implicitly grouped together and served by the single explicit GEM port network CTP. No additional GEM network CTPs need be created or linked for the additional GEM ports.

Several multicast GEM IW TPs can exist, each linked to separate bridge ports or mappers to serve different communities of interest in a complex ONU.

Discovery of multicast support

The OLT uses the multicast GEM IW TP entity as the means to discover the ONU's multicast capability. This entity is mandatory if multicast is supported by the ONU. If the OLT attempts to create this entity on an ONU that does not support multicast, the create command fails. The create or set command also fails if the OLT attempts to exploit optional features that the ONU does not support, e.g., in attempting to write a multicast address table with more than a single entry or to create multiple multicast GEM IW TPs.

This ME is defined by a similarity to the unicast GEM IW TP, and a number of its attributes are not meaningful in a multicast context. These attributes are set to 0 and not used, as indicated in the following.

Relationships

An instance of this ME exists for each occurrence of transformation of GEM packets into a multicast data stream.

Attributes

Managed entity ID: This attribute uniquely identifies each instance of this ME. The value 0xFFFF is reserved. (R, set-by-create) (mandatory) (2 bytes)

GEM port network CTP connectivity pointer: This attribute points to an instance of the GEM port network CTP that is associated with this multicast GEM IW TP. (R, W, set-by-create) (mandatory) (2 bytes)

Interworking option: This attribute identifies the type of non-GEM function that is being interworked. The option can be as follows.

- 0 This value is a "no-op" or "don't care". It should be used when the multicast GEM IW TP is associated with several functions of different types. It can optionally be used in all cases, since the necessary information is available elsewhere. The previous code points are retained for backward compatibility:
- 1 MAC bridged LAN
- 3 Reserved
- 5 IEEE 802.1p mapper

(R, W, set-by-create) (mandatory) (1 byte)

Service profile pointer: This attribute is set to 0 and not used. For backward compatibility, it may also be set to point to a MAC bridge service profile or IEEE 802.1p mapper service profile. (R, W, set-by-create) (mandatory) (2 bytes)

Not used 1: This attribute is set to 0 and not used. (R, W, set-by-create) (mandatory) (2 bytes)

PPTP counter: This attribute represents the number of instances of PPTP MEs associated with this instance of the multicast GEM IW TP. This attribute conveys no information that is not available elsewhere; it may be set to 0xFF and not used. (R) (optional) (1 byte)

Operational state: This attribute indicates whether the ME is capable of performing its function. Valid values are enabled (0) and disabled (1). (R) (optional) (1 byte)

GAL profile pointer: This attribute is set to 0 and not used. For backward compatibility, it may also be set to point to a GAL Ethernet profile. (R, W, set-by-create) (mandatory) (2 bytes)

Not used 2: This attribute is set to 0 and not used. (R, W, set-by-create) (mandatory) (1 byte)

IPv4 multicast address table: This attribute maps IP multicast addresses to PON layer addresses. Each entry contains the following.

GEM port-ID	2 bytes
Secondary key	2 bytes
IP multicast DA range start	4 bytes
IP multicast DA range stop	4 bytes

The first four bytes of each entry are treated as a key into the list. The secondary key allows the table to contain more than a single range for a given GEM port.

A set action to a particular value overwrites any existing entry with the same first four bytes. If the last eight bytes of a set command are all zero, that entry is deleted from the list, as the IP address 0.0.0.0 is not valid.

(R, W) (mandatory) (12*N* bytes, where *N* is the number of entries in the list.)

IPv6 multicast address table: This attribute maps IPv6 multicast DAs to PON layer addresses. Each entry contains:

GEM port-ID	2 bytes
Secondary key	2 bytes
Least significant bytes, IP multicast DA range start	4 bytes
Least significant bytes, IP multicast DA range stop	4 bytes
Most significant bytes, IP DA	12 bytes

The first four bytes of each entry are treated as a key into the list. The secondary key allows the table to contain more than a single range for a given GEM port.

A set action to a particular value overwrites any existing entry with the same first four bytes. If the last 20 bytes of a set command are all zero, that entry is deleted from the list.

(R, W) (optional) (24*N* bytes, where *N* is the number of entries in the list.)

Actions

Create, delete, get, get next, set

Set table (optional)

Notifications

Attribute value change

Number	Attribute value change	Description
1..5	N/A	
6	Op state	Operational state change
7..9	N/A	
10..16	Reserved	

Alarm

Alarm number	Alarm	Description
0	Deprecated	
1..207	Reserved	
208..223	Vendor-specific alarms	Not to be standardized

9.2.6 This clause is intentionally left blank

9.2.7 GAL Ethernet profile

This ME organizes data that describe the gigabit-capable passive optical network transmission convergence layer (GTC) adaptation layer processing functions of the ONU for Ethernet services. It is used with the GEM IW TP ME.

Instances of this ME are created and deleted on request of the OLT.

Relationships

An instance of this ME may be associated with zero or more instances of the GEM IW TP ME.

Attributes

Managed entity ID: This attribute uniquely identifies each instance of this ME. (R, set-by-create) (mandatory) (2 bytes)

Maximum GEM payload size: This attribute defines the maximum payload size generated in the associated GEM IW TP ME. (R, W, set-by-create) (mandatory) (2 bytes)

Actions

Create, delete, get, set

Notifications

None.

9.2.8 GAL Ethernet performance monitoring history data

This ME collects PM data associated with a GEM IW TP when the GEM layer supports an Ethernet service. Instances of this ME are created and deleted by the OLT.

For a complete discussion of generic PM architecture, refer to clause I.4.

Relationships

An instance of this ME is associated with an instance of the GEM IW TP ME.

Attributes

Managed entity ID: This attribute uniquely identifies each instance of this ME. Through an identical ID, this ME is implicitly linked to an instance of the GEM IW TP. (R, set-by-create) (mandatory) (2 bytes)

Interval end time: This attribute identifies the most recently finished 15 min interval. (R) (mandatory) (1 byte)

Threshold data 1/2 ID: This attribute points to an instance of the threshold data 1 ME that contains PM threshold values. Since no threshold value attribute number exceeds 7, a threshold data 2 ME is optional. (R, W, set-by-create) (mandatory) (2 bytes)

Discarded downstream frames: This attribute counts the number of downstream GEM frames discarded for any reason [erroneous frame check sequence (FCS), too long length, buffer overflow, etc.]. (R) (mandatory) (4 bytes)

Discarded upstream frames: This attribute counts the number of upstream frames discarded prior to GEM encapsulation (due to congestion). (R) (optional) (4 bytes)

Actions

Create, delete, get, set

Get current data (optional)

Notifications

Threshold crossing alert

Alarm number	Threshold crossing alert	Threshold value attribute No. (Note)
0	Discarded downstream frames	1
1	Discarded upstream frames	2

NOTE – This number associates the TCA with the specified threshold value attribute of the threshold data 1 managed entity.

9.2.9 Forward error correction performance monitoring history data

This ME collects PM data associated with PON downstream forward error correction (FEC) counters. Instances of this ME are created and deleted by the OLT.

For a complete discussion of generic PM architecture, refer to clause I.4.

Relationships

An instance of this ME is associated with an instance of the ANI-G ME or an instance of the time and wavelength division multiplexing (TWDM) channel ME.

Attributes

Managed entity ID: This attribute uniquely identifies each instance of this ME. Through an identical ID, this ME is implicitly linked to an instance of the ANI-G or a TWDM channel. (R, set-by-create) (mandatory) (2 bytes)

Interval end time: This attribute identifies the most recently finished 15 min interval. (R) (mandatory) (1 byte)

Threshold data 1/2 ID: This attribute points to an instance of the threshold data 1 ME that contains PM threshold values. Since no threshold value attribute number

exceeds 7, a threshold data 2 ME is optional. (R, W, set-by-create) (mandatory) (2 bytes)

Corrected bytes: This attribute counts the number of bytes that were corrected by the FEC function. (R) (mandatory) (4 bytes)

Corrected code words: This attribute counts the code words that were corrected by the FEC function. (R) (mandatory) (4 bytes)

Uncorrectable code words: This attribute counts errored code words that could not be corrected by the FEC function. (R) (mandatory) (4 bytes)

Total code words: This attribute counts the total received code words. (R) (mandatory) (4 bytes)

FEC seconds: This attribute counts seconds during which at least one uncorrectable FEC codeword was received. (R) (mandatory) (2 bytes)

Actions

Create, delete, get, set

Get current data (optional)

Notifications

Threshold crossing alert

Alarm number	Threshold crossing alert	Threshold value attribute No. (Note)
0	Corrected bytes	1
1	Corrected code words	2
2	Uncorrectable code words	3
4	FEC seconds	4
NOTE – This number associates the TCA with the specified threshold value attribute of the threshold data 1 managed entity.		

9.2.10 Priority queue

NOTE 1 – In [ITU-T G.984.4], this is called a priority queue-G.

This ME specifies the priority queue used by a GEM port network CTP in the upstream direction. The upstream priority queue ME is also related to a T-CONT ME. By default, this relationship is fixed by the ONU hardware architecture, but some ONUs may also permit the relationship to be configured through the OMCI, as indicated by the QoS configuration flexibility attribute of the ONU2-G ME.

In the downstream direction, priority queues are associated with UNIs. Again, the association is fixed by default, but some ONUs may permit the association to be configured through the OMCI.

If an ONU as a whole contains priority queues, it instantiates these queues autonomously. Priority queues may also be localized to pluggable circuit packs, in which case the ONU creates and deletes them in accordance with circuit pack pre-provisioning and the equipped configuration.

The OLT can find all the queues by reading the priority queue ME instances. If the OLT tries to retrieve a non-existent priority queue, the ONU denies the get action with an error indication.

See also Appendix II.

Priority queues can exist in the ONU core and circuit packs serving both UNI and ANI functions. Therefore, they can be indirectly created and destroyed through cardholder provisioning actions.

In the upstream direction, the weight attribute permits the configuring of an optional traffic scheduler. Several attributes support back pressure operation, whereby a back-pressure signal is sent backwards and causes the attached terminal to temporarily suspend sending data.

In the downstream direction, strict priority discipline among the queues serving a given UNI is the default, with priorities established through the related port attribute. If two or more non-empty queues have the same priority, capacity is allocated among them in proportion to their weights. Note that the details of the downstream model differ from those of the upstream model.

The yellow packet drop thresholds specify the drop probability for a packet that has been marked yellow (drop eligible) by a traffic descriptor or by external equipment such as a residential gateway (RG). If the current average queue occupancy is less than the minimum threshold, the yellow packet drop probability is zero. If the current average queue occupancy is greater than or equal to the maximum threshold, the yellow packet drop probability is one. The yellow drop probability increases linearly between 0 and max_p as the current average queue occupancy increases from the minimum to the maximum threshold.

The same model can be configured for green packets, those regarded as being within the traffic contract.

Drop precedence colour marking indicates the method by which a packet is marked as drop eligible (yellow). For discard eligibility indicator (DEI) and priority code point (PCP) marking, a drop eligible indicator is equivalent to yellow colour; otherwise, the colour is green. For differentiated services code point (DSCP) assured forwarding (AF) marking, the lowest drop precedence is equivalent to green; otherwise, the colour is yellow.

Relationships

One or more instances of this ME are associated with the ONU-G ME to model upstream priority queues if the traffic management option attribute in the ONU-G ME is 0 or 2.

One or more instances of this ME are associated with a PPTP UNI ME as downstream priority queues. Downstream priority queues may or may not be provided for a virtual Ethernet interface point (VEIP).

Attributes

Managed entity ID: This attribute uniquely identifies each instance of this ME. The MSB represents the direction (1: upstream, 0: downstream). The 15 LSBs represent a queue ID. The queue ID is numbered in ascending order by the ONU itself. It is strongly encouraged that the queue ID be formulated to simplify finding related queues. One way to do this is to number the queues such that the related port attributes are in ascending order (for the downstream and upstream queues separately). The range of downstream queue ids is 0 to 0x7FFF and the range of upstream queue ids is 0x8000 to 0xFFFF. (R) (mandatory) (2 bytes)

Queue configuration option: This attribute identifies the buffer partitioning policy. The value 1 means that several queues share one buffer of maximum queue size, while the value 0 means that each queue has an individual buffer of maximum queue size. (R) (mandatory) (1 byte)

Maximum queue size: This attribute specifies the maximum size of the queue, in bytes, scaled by the priority queue scale factor attribute of the ONU2-G. (R) (mandatory) (2 bytes)

NOTE 2 – In this and the other similar attributes of the priority queue ME, some legacy implementations may take the queue scale factor from the GEM block length attribute of the ANI-G ME. This option is discouraged in new implementations.

Allocated queue size: This attribute identifies the allocated size of this queue, in bytes, scaled by the priority queue scale factor attribute of the ONU2-G. (R, W) (mandatory) (2 bytes)

Discard-block counter reset interval: This attribute represents the interval in milliseconds at which the counter resets itself. (R, W) (optional) (2 bytes)

Threshold value for discarded blocks due to buffer overflow: This attribute specifies the threshold for the number of bytes (scaled by the priority queue scale factor attribute of the ONU2-G) discarded on this queue due to buffer overflow. Its value controls the declaration of the block loss alarm. (R, W) (optional) (2 bytes)

Related port: This attribute represents the slot, port/T-CONT and priority information associated with the instance of priority queue ME. This attribute comprises 4 bytes.

In the upstream direction, the first 2 bytes are the ME ID of the associated T-CONT, the first byte of which is a slot number, the second byte a T-CONT number. In the downstream direction, the first byte is the slot number and the second byte is the port number of the queue's destination port.

The last 2 bytes represent the priority of this queue. The range of priority is 0 to 0x0FFF. The value 0 indicates the highest priority and 0x0FFF indicates the lowest priority. The priority field is meaningful if multiple priority queues are associated with a T-CONT or traffic scheduler whose scheduling discipline is strict priority.

(R, W) (mandatory) (4 bytes)

NOTE 3 – If flexible port configuration is supported, the related port attribute is meaningful only if the traffic scheduler pointer attribute value is null. Otherwise, the related port attribute is ignored.

NOTE 4 – The related port attribute is read-only, unless otherwise specified by the QoS configuration flexibility attribute of the ONU2-G ME. If port flexibility is supported, the second byte, the port or T-CONT number, may be changed. If priority flexibility is supported, the third and fourth bytes may be changed. The OMCI set command must contain 4 bytes to match the attribute size, but the ONU must ignore all bytes that are not specified to be flexible.

If flexible configuration is not supported, the ONU should reject an attempt to set the related port with a parameter error result-reason code.

Traffic scheduler pointer: This attribute points to the traffic scheduler ME instance that is associated with this priority queue. This pointer is used when this priority queue is connected with a traffic scheduler. The default value is a null pointer (0). (R, W) (mandatory) (2 bytes)

NOTE 5 – When the QoS configuration flexibility attribute of the ONU2-G ME allows flexible assignment of the traffic scheduler, the OLT may configure the traffic scheduler pointer to refer to any traffic scheduler in the same slot.

If traffic scheduler flexibility is not permitted by the QoS configuration flexibility attribute, the OLT may use the traffic scheduler pointer attribute only by pointing to another traffic scheduler ME that is associated with the same T-CONT as the priority queue itself.

The ONU should reject an attempt to violate these conditions with a parameter error result-reason code.

- Weight:** This attribute represents weight for WRR scheduling. At a given priority level, capacity is distributed to non-empty queues in proportion to their weights. In the upstream direction, this weight is meaningful if several priority queues are associated with a traffic scheduler or T-CONT whose policy is WRR. In the downstream direction, this weight is used by a UNI in a WRR fashion. Upon ME instantiation, the ONU sets this attribute to 1. (R, W) (mandatory) (1 byte)
- Back pressure operation:** This attribute enables (0) or disables (1) back pressure operation. Its default value is 0. (R, W) (mandatory) (2 bytes)
- Back pressure time:** This attribute specifies the duration in microseconds of the back-pressure signal. It can be used as a pause time for an Ethernet UNI. Upon ME instantiation, the ONU sets this attribute to 0. (R, W) (mandatory) (4 bytes)
- Back pressure occur queue threshold:** This attribute identifies the threshold queue occupancy, in bytes, scaled by the priority queue scale factor attribute of the ONU2-G, to start sending a back-pressure signal. (R, W) (mandatory) (2 bytes)
- Back pressure clear queue threshold:** This attribute identifies the threshold queue occupancy, in bytes, scaled by the priority queue scale factor attribute of the ONU2-G, to stop sending a back-pressure signal. (R, W) (mandatory) (2 bytes)
- Packet drop queue thresholds:** This attribute is a composite of four 2 byte values, a minimum and a maximum threshold, measured in bytes, scaled by the priority queue scale factor attribute of the ONU2-G, for green and yellow packets. The first value is the minimum green threshold, the queue occupancy below which all green packets are admitted to the queue. The second value is the maximum green threshold, the queue occupancy at or above which all green packets are discarded. The third value is the minimum yellow threshold, the queue occupancy below which all yellow packets are admitted to the queue. The fourth value is the maximum yellow threshold, the queue occupancy at or above which all yellow packets are discarded. The default is that all thresholds take the value of the maximum queue size. (R, W) (optional) (8 bytes)
- Packet drop max_p:** This attribute is a composite of two 1 byte values, the probability of dropping a coloured packet when the queue occupancy lies just below the maximum threshold for packets of that colour. The first value is the green packet max_p, and the second value is the yellow packet max_p. The probability, max_p, is determined by adding one to the unsigned value (0..255) of this attribute and dividing the result by 256. The default for each value is 255. (R, W) (optional) (2 bytes)
- Queue drop w_q:** This attribute determines the averaging coefficient, w_q, as described in [b-Floyd]. The averaging coefficient, w_q, is equal to $2^{-\text{Queue_drop_w_q}}$. For example, when queue drop_w_q has the value 9, the averaging coefficient, w_q, is $1/512 = 0.0019$. The default value is 9. (R, W) (optional) (1 byte)

Drop precedence colour marking: This attribute specifies how drop precedence is marked on ingress packets to the priority queue. The default value is 0.

- 0 No marking (treat all packets as green)
- 1 Internal marking (from traffic descriptor ME)
- 2 DEI [IEEE 802.1ad]
- 3 PCP 8P0D [IEEE 802.1ad]
- 4 PCP 7P1D [IEEE 802.1ad]
- 5 PCP 6P2D [IEEE 802.1ad]
- 6 PCP 5P3D [IEEE 802.1ad]
- 7 DSCP AF class [IETF RFC 2597]

(R, W) (optional) (1 byte)

Actions

Get, set

Notifications

Alarm

Alarm number	Alarm	Description
0	Block loss	Content loss in excess of threshold. The alarm is cleared when the discard block counter reset interval next expires.
1..207	Reserved	
208..223	Vendor-specific alarms	Not to be standardized

9.2.11 Traffic scheduler

NOTE 1 – In [ITU-T G.984.4], this ME is called a traffic scheduler-G.

An instance of this ME represents a logical object that can control upstream GEM packets. A traffic scheduler can accommodate GEM packets after a priority queue or other traffic scheduler and transfer them towards the next traffic scheduler or T-CONT. Because T-CONTs and traffic schedulers are created autonomously by the ONU, the ONU vendor predetermines the most complex traffic handling model it is prepared to support; the OLT may use less than the ONU's full capabilities, but cannot ask for more. See Appendix II for more details.

After the ONU creates instances of the T-CONT ME, it then autonomously creates instances of the traffic scheduler ME.

Relationships

The traffic scheduler ME may be related to a T-CONT or other traffic schedulers through pointer attributes.

Attributes

Managed entity ID: This attribute uniquely identifies each instance of this ME. This 2 byte number indicates the physical capability that realizes the traffic scheduler. The first byte is the slot ID of the circuit pack with which this traffic scheduler is associated. For a traffic scheduler that is not associated with a circuit pack, the first byte is 0xFF. The second byte is the traffic scheduler id, assigned by the ONU itself. Traffic schedulers are numbered in ascending order with the range 0..0xFF in each circuit pack or in the ONU core. (R) (mandatory) (2 bytes)

T-CONT pointer: This attribute points to the T-CONT ME instance associated with this traffic scheduler. This pointer is used when this traffic scheduler is connected to the T-CONT directly; It is null (0) otherwise. (R, W) (mandatory) (2 bytes)

NOTE 2 – This attribute is read-only unless otherwise specified by the QoS configuration flexibility attribute of the ONU2-G ME. If flexible configuration is not supported, the ONU should reject an attempt to set the T-CONT pointer attribute with a parameter error result-reason code.

Traffic scheduler pointer: This attribute points to another traffic scheduler ME instance that may serve this traffic scheduler. This pointer is used when this traffic scheduler is connected to another traffic scheduler; it is null (0) otherwise. (R) (mandatory) (2 bytes)

Policy: This attribute represents scheduling policy. Valid values include:

- 0 Null
- 1 Strict priority
- 2 WRR (weighted round robin)

The traffic scheduler derives priority or weight values for its tributary traffic schedulers or priority queues from the tributary MEs themselves.

(R, W) (mandatory) (1 byte)

NOTE 3 – This attribute is read-only unless otherwise specified by the QoS configuration flexibility attribute of the ONU2-G ME. If flexible configuration is not supported, the ONU should reject an attempt to set the policy attribute with a parameter error result-reason code.

Priority/weight: This attribute represents the priority for strict priority scheduling or the weight for WRR scheduling. This value is used by the next upstream ME, as indicated by the T-CONT pointer attribute or traffic scheduler pointer attribute.

If the indicated pointer has policy = strict priority, this value is interpreted as a priority (0 is the highest priority, 255 the lowest).

If the indicated pointer has policy = WRR, this value is interpreted as a weight. Higher values receive more bandwidth.

Upon ME instantiation, the ONU sets this attribute to 0. (R, W) (mandatory) (1 byte)

Actions

Get, set

Notifications

None.

9.2.12 Traffic descriptor

The traffic descriptor is a profile that allows for traffic management. A priority controlled ONU can point from a MAC bridge port configuration data ME to a traffic descriptor in order to implement traffic management (marking, policing). A rate controlled ONU can point to a traffic descriptor from either a MAC bridge port configuration data ME or a GEM port network CTP to implement traffic management (marking, shaping).

Packets are determined to be green, yellow or red as a function of the ingress packet rate and the settings in this ME. The colour indicates drop precedence (eligibility), subsequently used by the priority queue ME to drop packets conditionally during congestion conditions. Packet colour is also used by the optional mode 1 DBA status reporting function described in [ITU-T G.984.3]. Red packets are dropped immediately. Yellow packets are marked as drop eligible, and green packets are marked as not drop eligible, according to the egress colour marking attribute.

The algorithm used to determine the colour marking is specified by the meter type attribute. If [b-IETF RFC 4115] is used, then:

$$\text{CIR}_{4115} = \text{CIR}$$

$$\text{EIR}_{4115} = \text{PIR} - \text{CIR} \text{ (EIR: excess information rate)}$$

$$\text{CBS}_{4115} = \text{CBS}$$

$$\text{EBS}_{4115} = \text{PBS} - \text{CBS}.$$

Relationships

This ME is associated with a GEM port network CTP or a MAC bridge port configuration data ME.

Attributes

Managed entity ID: This attribute uniquely identifies each instance of this ME. (R, set-by-create) (mandatory) (2 bytes)

CIR: This attribute specifies the committed information rate, in bytes per second. The default is 0. (R, W, set-by-create) (optional) (4 bytes)

PIR: This attribute specifies the peak information rate, in bytes per second. The default value 0 accepts the ONU's factory policy. (R, W, set-by-create) (optional) (4 bytes)

CBS: This attribute specifies the committed burst size, in bytes. The default is 0. (R, W, set-by-create) (optional) (4 bytes)

PBS: This attribute specifies the peak burst size, in bytes. The default value 0 accepts the ONU's factory policy. (R, W, set-by-create) (optional) (4 bytes)

Colour mode: This attribute specifies whether the colour marking algorithm considers pre-existing marking on ingress packets (colour-aware) or ignores it (colour-blind). In colour-aware mode, packets can only be demoted (from green to yellow or red, or from yellow to red). The default value is 0.

- 0 Colour-blind
- 1 Colour-aware

(R, W, set-by-create) (optional) (1 byte)

Ingress colour marking: This attribute is meaningful in colour-aware mode. It identifies how pre-existing drop precedence is marked on ingress packets. For DEI and PCP marking, a drop eligible indicator is equivalent to yellow; otherwise, the colour is green. For DSCP AF marking, the lowest drop precedence is equivalent to green; otherwise, the colour is yellow. The default value is 0.

- 0 No marking (ignore ingress marking)
- 2 DEI [IEEE 802.1ad]
- 3 PCP 8P0D [IEEE 802.1ad]
- 4 PCP 7P1D [IEEE 802.1ad]
- 5 PCP 6P2D [IEEE 802.1ad]
- 6 PCP 5P3D [IEEE 802.1ad]
- 7 DSCP AF class [IETF RFC 2597]

(R, W, set-by-create) (optional) (1 byte)

Egress colour marking: This attribute specifies how drop precedence is to be marked by the ONU on egress packets. If set to internal marking only, the externally visible packet contents are not modified, but the packet is identified in a vendor-specific local way that indicates its colour to the priority queue ME. It is

possible for the egress marking to differ from the ingress marking; for example, ingress PCP marking could be translated to DEI egress marking. The default value is 0.

- 0 No marking
- 1 Internal marking only
- 2 DEI [IEEE 802.1ad]
- 3 PCP 8P0D [IEEE 802.1ad]
- 4 PCP 7P1D [IEEE 802.1ad]
- 5 PCP 6P2D [IEEE 802.1ad]
- 6 PCP 5P3D [IEEE 802.1ad]
- 7 DSCP AF class [IETF RFC 2597]

(R, W, set-by-create) (optional) (1 byte)

Meter type: This attribute specifies the algorithm used to determine the colour of the packet. The default value is 0.

- 0 Not specified
- 1 [b-IETF RFC 4115]
- 2 [b-IETF RFC 2698]

(R, set-by-create) (optional) (1 byte)

Actions

Create, delete, get, set

Notifications

None.

9.2.13 GEM port network CTP performance monitoring history data

This ME collects GEM frame PM data associated with a GEM port network CTP. Instances of this ME are created and deleted by the OLT.

NOTE 1 – One might expect to find some form of impaired or discarded frame count associated with a GEM port. However, the only impairment that might be detected at the GEM frame level would be a corrupted GEM frame header. In this case, no part of the header could be considered reliable including the port ID. For this reason, there is no impaired or discarded frame count in this ME.

NOTE 2 – This ME replaces the GEM port performance history data ME and is preferred for new implementations.

For a complete discussion of generic PM architecture, refer to clause I.4.

Relationships

An instance of this ME is associated with an instance of the GEM port network CTP ME.

Attributes

Managed entity ID: This attribute uniquely identifies each instance of this ME. Through an identical ID, this ME is implicitly linked to an instance of the GEM port network CTP. (R, set-by-create) (mandatory) (2 bytes)

Interval end time: This attribute identifies the most recently finished 15 min interval. (R) (mandatory) (1 byte)

Threshold data 1/2 ID: This attribute points to an instance of the threshold data 1 ME that contains PM threshold values. Since no threshold value attribute number exceeds 7, a threshold data 2 ME is optional. (R, W, set-by-create) (mandatory) (2 bytes)

Transmitted GEM frames: This attribute counts GEM frames transmitted on the monitored GEM port. (R) (mandatory) (4 bytes)

Received GEM frames: This attribute counts GEM frames received correctly on the monitored GEM port. A correctly received GEM frame is one that does not contain uncorrectable errors and has a valid header error check (HEC). (R) (mandatory) (4 bytes)

Received payload bytes: This attribute counts user payload bytes received on the monitored GEM port. (R) (mandatory) (8 bytes)

Transmitted payload bytes: This attribute counts user payload bytes transmitted on the monitored GEM port. (R) (mandatory) (8 bytes)

Encryption key errors: This attribute is defined in ITU-T G.987 systems only. It counts GEM frames with erroneous encryption key indexes. If the GEM port is not encrypted, this attribute counts any frame with a key index not equal to 0. If the GEM port is encrypted, this attribute counts any frame whose key index specifies a key that is not known to the ONU. (R) (optional) (4 bytes)

NOTE 3 – GEM PM ignores idle GEM frames.

NOTE 4 – GEM PM counts each non-idle GEM frame, whether it contains an entire user frame or only a fragment of a user frame.

Actions

Create, delete, get, set

Get current data (optional)

Notifications

Threshold crossing alert

Alarm number	Threshold crossing alert	Threshold value attribute No. (Note)
1	Encryption key errors	1
NOTE – This number associates the TCA with the specified threshold value attribute of the threshold data 1 managed entity.		

9.2.14 Energy consumption performance monitoring history data

This ME collects PM data associated with the ONU's energy consumption. The time spent in various low-power states is recorded as a measure of their utility. Furthermore, the ONU may also include the equivalent of a watt-hour meter, which can be sampled from time to time to measure actual power consumed.

For a complete discussion of generic PM architecture, refer to clause I.4.

Relationships

An instance of this ME is associated with the ONU in its entirety.

Attributes

Managed entity ID: This attribute uniquely identifies each instance of this ME. The ME ID must be 0. (R, set-by-create) (mandatory) (2 bytes)

Interval end time: This attribute identifies the most recently finished 15 min interval. (R) (mandatory) (1 byte)

Threshold data 1/2 ID: No thresholds are defined for this ME. For uniformity with other PMs, the attribute is retained and shown as mandatory, but it should be set to a null pointer. (R, W, set-by-create) (mandatory) (2 bytes)

Doze time: This attribute records the time during which the ONU was in doze energy conservation mode, measured in microseconds. If watchful sleep is enabled in the ONU dynamic power management control ME, the ONU ignores this attribute. (R) (mandatory) (4 bytes)

Cyclic sleep time: This attribute records the time during which the ONU was in cyclic sleep energy conservation mode, measured in microseconds. If watchful sleep is enabled in the ONU dynamic power management control ME, the ONU ignores this attribute. (R) (mandatory) (4 bytes)

Watchful sleep time: This attribute records the time during which the ONU was in watchful sleep energy conservation mode, measured in microseconds. (R) (mandatory) (4 bytes)

Energy consumed: This attribute records the energy consumed by the ONU, measured in millijoules. (R) (optional) (4 bytes)

Actions

Create, delete, get, set

Get current data (optional)

Notifications

None.

9.2.15 XG-PON TC performance monitoring history data

This ME collects PM data associated with the XG-PON TC layer.

For a complete discussion of generic PM architecture, refer to clause I.4.

Relationships

An instance of this ME is associated with an ANI-G.

Attributes

Managed entity ID: This attribute uniquely identifies each instance of this ME. Through an identical ID, this ME is implicitly linked to an instance of the ANI-G. (R, set-by-create) (mandatory) (2 bytes)

Interval end time: This attribute identifies the most recently finished 15 min interval. (R) (mandatory) (1 byte)

Threshold data 1/2 ID: This attribute points to an instance of the threshold data 1 ME that contains PM threshold values. (R, W, set-by-create) (mandatory) (2 bytes)

PSBd HEC error count: This attribute counts HEC errors in any of the fields of the downstream physical sync block. (R) (optional) (4 bytes)

XGTC HEC error count: This attribute counts HEC errors detected in the XGTC header. In [ITU-T G.9807.1], this attribute is used for framing sublayer (FS) HEC error count management. (R) (optional) (4 bytes)

Unknown profile count: This attribute counts the number of grants received whose specified profile was not known to the ONU. (R) (optional) (4 bytes)

Transmitted XG-PON encapsulation method (XGEM) frames: This attribute counts the number of non-idle XGEM frames transmitted. If a service data unit (SDU) is fragmented, each fragment is an XGEM frame and is counted as such. (R) (mandatory) (4 bytes)

Fragment XGEM frames: This attribute counts the number of XGEM frames that represent fragmented SDUs, as indicated by the LF bit = 0. (R) (optional) (4 bytes)

XGEM HEC lost words count: This attribute counts the number of 4 byte words lost because of an XGEM frame HEC error. In general, all XGTC payload following the error is lost, until the next PSBd event. (R) (optional) (4 bytes)

XGEM key errors: This attribute counts the number of downstream XGEM frames received with an invalid key specification. The key may be invalid for several reasons, among which are:

- a) GEM port provisioned for clear text and key index not equal to 00;
- b) no multicast key of the specified key index has been provided via the OMCI for a multicast GEM port;
- c) no unicast key of the specified key index has been successfully negotiated (see clause 15.5 of [ITU-T G.987.3] or clause C.15.5 of [ITU-T G.9807.1] for key negotiation state machine);
- d) GEM port specified to be encrypted and key index = 00;
- e) key index = 11, a reserved value.

(R) (mandatory) (4 bytes)

XGEM HEC error count: This attribute counts the number of instances of an XGEM frame HEC error. (R) (mandatory) (4 bytes)

Transmitted bytes in non-idle XGEM frames: This attribute counts the number of transmitted bytes in non-idle XGEM frames. (R) (mandatory) (8 bytes)

Received bytes in non-idle XGEM frames: This attribute counts the number of received bytes in non-idle XGEM frames. (R) (optional) (8 bytes)

Loss of downstream synchronization (LODS) event count: This attribute counts the number of state transitions from O5.1 to O6. (R) (optional) (4 bytes)

LODS event restored count: This attribute counts the number of LODS cleared events. (R) (optional) (4 bytes)

ONU reactivation by LODS events: This attribute counts the number of LODS events resulting in ONU reactivation without synchronization being reacquired. (R) (optional) (4 bytes)

Actions

Create, delete, get, set

Get current data (optional)

Notifications

Threshold crossing alert

Alarm number	Threshold crossing alert	Threshold value attribute No. (Note)
1	PSBd HEC error count	1
2	XGTC HEC error count	2
3	Unknown profile count	3
4	XGEM HEC loss count	4
5	XGEM key errors	5
6	XGEM HEC error count	6

NOTE – This number associates the TCA with the specified threshold value attribute of the threshold data 1 managed entity.

9.2.16 XG-PON downstream management performance monitoring history data

This ME collects PM data associated with the XG-PON TC layer. It collects counters associated with downstream PLOAM and OMCI messages.

For a complete discussion of generic PM architecture, refer to clause I.4.

Relationships

An instance of this ME is associated with an ANI-G.

Attributes

Managed entity ID: This attribute uniquely identifies each instance of this ME. Through an identical ID, this ME is implicitly linked to an instance of the ANI-G. (R, set-by-create) (mandatory) (2 bytes)

Interval end time: This attribute identifies the most recently finished 15 min interval. (R) (mandatory) (1 byte)

Threshold data 1/2 ID: This attribute points to an instance of the threshold data 1 ME that contains PM threshold values. Since no threshold value attribute number exceeds 7, a threshold data 2 ME is optional. (R, W, set-by-create) (mandatory) (2 bytes)

PLOAM message integrity check (MIC) error count: This attribute counts MIC errors detected in downstream PLOAM messages, either directed to this ONU or broadcast to all ONUs. (R) (optional) (4 bytes)

Downstream PLOAM messages count: This attribute counts PLOAM messages received, either directed to this ONU or broadcast to all ONUs. (R) (optional) (4 bytes)

Profile messages received: This attribute counts the number of profile messages received, either directed to this ONU or broadcast to all ONUs. In [ITU-T G.9807.1], this attribute is used for received burst_profile message count. (R) (optional) (4 bytes)

Ranging_time messages received: This attribute counts the number of ranging_time messages received, either directed to this ONU or broadcast to all ONUs. (R) (mandatory) (4 bytes)

Deactivate_ONU-ID messages received: This attribute counts the number of deactivate_ONU-ID messages received, either directed to this ONU or

broadcast to all ONUs. Deactivate_ONU-ID messages do not reset this counter. (R) (optional) (4 bytes)

Disable_serial_number messages received: This attribute counts the number of disable_serial_number messages received, whose serial number specified this ONU. (R) (optional) (4 bytes)

Request_registration messages received: This attribute counts the number of request_registration messages received. (R) (optional) (4 bytes)

Assign_alloc-ID messages received: This attribute counts the number of assign_alloc-ID messages received. (R) (optional) (4 bytes)

Key_control messages received: This attribute counts the number of key_control messages received, either directed to this ONU or broadcast to all ONUs. (R) (optional) (4 bytes)

Sleep_allow messages received: This attribute counts the number of sleep_allow messages received, either directed to this ONU or broadcast to all ONUs. (R) (optional) (4 bytes)

Baseline OMCI messages received count: This attribute counts the number of OMCI messages received in the baseline message format. (R) (optional) (4 bytes)

Extended OMCI messages received count: This attribute counts the number of OMCI messages received in the extended message format. (R) (optional) (4 bytes)

Assign_ONU-ID messages received: This attribute counts the number of assign_ONU-ID messages received since the last re-boot. (R) (optional) (4 bytes)

OMCI MIC error count: This attribute counts MIC errors detected in OMCI messages directed to this ONU. (R) (optional) (4 bytes)

Actions

Create, delete, get, set

Get current data (optional)

Notifications

Threshold crossing alert

Alarm number	Threshold crossing alert	Threshold value attribute No. (Note)
1	PLOAM MIC error count	1
2	OMCI MIC error count	2
NOTE – This number associates the TCA with the specified threshold value attribute of the threshold data 1 managed entity.		

9.2.17 XG-PON upstream management performance monitoring history data

This ME collects PM data associated with the XG-PON TC layer. It counts upstream PLOAM messages transmitted by the ONU.

For a complete discussion of generic PM architecture, refer to clause I.4.

Relationships

An instance of this ME is associated with an ANI-G.

Attributes

- Managed entity ID:** This attribute uniquely identifies each instance of this ME. Through an identical ID, this ME is implicitly linked to an instance of the ANI-G. (R, set-by-create) (mandatory) (2 bytes)
- Interval end time:** This attribute identifies the most recently finished 15 min interval. (R) (mandatory) (1 byte)
- Threshold data 1/2 ID:** No thresholds are defined for this ME. For uniformity with other PM, the attribute is retained and shown as mandatory, but it should be set to a null pointer. (R, W, set-by-create) (mandatory) (2 bytes)
- Upstream PLOAM message count:** This attribute counts PLOAM messages transmitted upstream, excluding acknowledge messages. (R) (optional) (4 bytes)
- Serial_number_ONU message count:** This attribute counts Serial_number_ONU PLOAM messages transmitted. (R) (optional) (4 bytes)
- Registration message count:** This attribute counts Registration PLOAM messages transmitted. (R) (optional) (4 bytes)
- Key_report message count:** This attribute counts key_report PLOAM messages transmitted. (R) (optional) (4 bytes)
- Acknowledge message count:** This attribute counts acknowledge PLOAM messages transmitted. It includes all forms of acknowledgement (AK), including those transmitted in response to a PLOAM grant when the ONU has nothing to send. (R) (optional) (4 bytes)
- Sleep_request message count:** This attribute counts sleep_request PLOAM messages transmitted. (R) (optional) (4 bytes)

Actions

- Create, delete, get, set
- Get current data (optional)

Notifications

- None.

9.2.18 L2 multicast GEM interworking termination point

An instance of this ME represents a point in an EPON ONU where a multicast service interworks with the GEM layer. At this point, a multicast bit stream is forwarded.

Instances of this ME are created and deleted by the OLT.

Multicast interworking GEM modes of operation

The default multicast operation of the EPON is one in which all the multicast content streams are carried in one PON layer connection (GEM port). This connection is then specified by the multicast MAC address filtering table. According to this table, the ONU filters the traffic based on Ethernet MAC addresses. The associated GEM port network CTP ME specifies the GEM port-ID that supports all multicast connections.

In the default multicast operation, all multicast content streams are placed in one PON layer connection (GEM port). The OLT sets up a completely conventional model, a pointer from the L2 multicast GEM IW TP to a GEM port network CTP. The OLT configures the GEM port-ID of the GEM port network CTP into the multicast MAC address filtering table attribute, along with the other table fields that specify multicast destination MAC addresses for filtering. The ONU accepts the entire

multicast stream through the designated GEM port and then filters the traffic based on Ethernet MAC address.

An optional multicast configuration supports separate multicast streams carried over separate PON layer connections, i.e., on separate GEM ports. This permits the ONU to filter multicast streams at the GEM level, which is hardware efficient, while ignoring other multicast streams that may be of interest to other ONUs on the PON.

After configuring the explicit model for the first multicast GEM port, the OLT supports multiple multicast GEM ports by configuring additional entries into the multicast MAC address filtering table, entries with different GEM port-IDs. The OMCI model is defined such that these ports are implicitly grouped together and served by the single explicit GEM port network CTP. No additional GEM network CTPs need be created or linked for the additional GEM ports.

Several L2 multicast GEM IW TPs can exist, each linked to separate bridge ports or mappers, to serve different communities of interest in a complex ONU.

Discovery of multicast support

The OLT uses the L2 multicast GEM IW TP entity as the means to discover the ONU's multicast capability. This entity is mandatory if multicast is supported by an EPON ONU. If the OLT attempts to create this entity on an ONU that does not support multicast, the create command fails. The create command also fails if the OLT attempts to exploit optional features that the ONU does not support, e.g., in attempting to create multiple L2 multicast GEM IW TPs.

This ME is defined by similarity to the unicast GEM IW TP, and a number of its attributes are not meaningful in a multicast context. These attributes are set to 0 and not used, as indicated in the following.

Relationships

An instance of this ME exists for each layer 2 multicast community of interest.

Attributes

Managed entity ID: This attribute uniquely identifies each instance of this ME. The value 0xFFFF is reserved. (R, set-by-create) (mandatory) (2 bytes)

GEM port network CTP connectivity pointer: This attribute points to an instance of the GEM port network CTP that is associated with this L2 multicast GEM IW TP. (R, W, set-by-create) (mandatory) (2 bytes)

Interworking option: This attribute identifies the type of non-GEM function that is being interworked. The option can be:

- 0 This value is a "no-op" or "don't care". It should be used when the L2 multicast GEM IW TP is associated with several functions of different types. It can optionally be used in all cases, since the necessary information is available elsewhere. The previous code points are retained for backward compatibility:
- 1 MAC bridged LAN
- 3 Reserved
- 5 IEEE 802.1p mapper

(R, W, set-by-create) (mandatory) (1 byte)

Service profile pointer: This attribute is set to 0 and not used. For backward compatibility, it may also be set to point to a MAC bridge service profile or IEEE 802.1p mapper service profile. (R, W, set-by-create) (mandatory) (2 bytes)

Not used 1: This attribute is set to 0 and not used. (R, W, set-by-create) (mandatory) (2 bytes)

PPTP counter: This attribute represents the number of instances of PPTP MEs associated with this instance of the L2 multicast GEM IW TP. This attribute conveys no information that is not available elsewhere; it may be set to 0xFF and not used. (R) (optional) (1 byte)

Operational state: This attribute indicates whether the ME is capable of performing its function. Valid values are enabled (0) and disabled (1). (R) (optional) (1 byte)

GAL profile pointer: This attribute is set to 0 and not used. For backward compatibility, it may also be set to point to a GAL Ethernet profile. (R, W, set-by-create) (mandatory) (2 bytes)

Not used 2: This attribute is set to 0 and not used. (R, W, set-by-create) (mandatory) (1 byte)

Multicast MAC address filtering capability: With this attribute, the ONU reports to the OLT its supported multicast MAC address registration methods and the maximum number of filtering table entries at the ONU.

Multicast MAC address registration method	1 byte
Maximum number of static registration entries	2 bytes
Maximum number of dynamic registration entries	2 bytes

The bits of the multicast MAC address registration method field are assigned as follows:

Bit	Name	Setting
1 (LSB)	Static MAC address registration	0: not supported 1: supported
2	Dynamic MAC address registration	0: not supported 1: supported
3..8	Reserved	0

(R) (mandatory) (5 bytes)

Multicast MAC address registration mode: This attribute allows the OLT to specify the multicast MAC address registration method.

- 0 Disable multicast MAC address filtering
- 1 Static MAC address registration
- 2 Dynamic MAC address registration

In L2-based multicast operation, the OLT handles the Internet group management protocol/multicast listener discovery (IGMP/MLD) protocol of the network and the ONU filters the multicast data stream as instructed by the OLT. ONU may support the static MAC address registration method or the dynamic MAC address registration method according to its filter implementation.

In the static MAC address registration method, the OLT provisions all available multicast addresses at the ONU. For each of the available addresses, the OLT also provides a status flag, which designates either pass or drop.

In the dynamic MAC address registration method, the OLT provisions multicast addresses allowed at the ONU. A frame whose DA matches the provisioned MAC destination group address is forwarded to the output port. Frames whose DA is a MAC group address (except for the broadcast address) and does not match any of the provisioned allowed MAC group addresses are discarded. The target range of MAC address that is handled in this filtering mode is 0x01-00-5E-00-00-00 through 0x01-00-5E-7F-FF-FF for IPv4

multicast traffic and 0x33-33-00-01-00-00 through 33-33-FF-FF-FF-FF for IPv6 multicast traffic.

(R, W) (mandatory) (1 byte)

Aging timer: This attribute sets the aging timer value in seconds that is called the multicast address listener interval in IGMP/MLD specifications. The ONU starts or restarts the timer when an entry is added or overwritten in the multicast MAC address filtering table. If the timer expires, the ONU changes the corresponding pass/drop flag to drop in case of static MAC address registration, or removes the corresponding Multicast destination MAC address entry in case of dynamic MAC address registration. The configurable value is 0 to 0x0F-FF-EF seconds and is common for all MAC address entries. The aging timer can be separately enabled or disabled in each multicast MAC address filtering table entry.

(R, W) (optional) (3 bytes)

Multicast MAC address filtering table: This attribute is a list that specifies multicast MAC address filtering configurations. Each entry contains the following.

GEM port-ID	2 bytes
Secondary key	2 bytes
Filter	1 byte
Multicast destination MAC address	6 bytes

The first 4 bytes of each entry are treated as a key into the list. The secondary key shows the entry number for a given GEM port.

The bits of the filter byte are assigned as follows.

Bit	Name	Setting
1 (LSB)	Pass/drop	0: drop 1: pass
2	Aging	0: disabled 1: enabled
3..6	Reserved	0
7..8	Add/remove	10: Clear entire table (set operation) 00: Remove this entry (set operation) 01: Add/overwrite this entry (set operation)

Upon ME instantiation, the ONU sets this attribute to an empty table.

(R, W) (mandatory) (11N bytes, where N is the number of entries in the list.)

Actions

Create, delete, get, get next, set

Set table (optional)

Notifications

Attribute value change

Number	Attribute value change	Description
1..5	N/A	
6	Op state	Operational state change
7..12	N/A	
13..16	Reserved	

9.2.19 ANI-E

This ME organizes data associated with each access network interface supported by an EPON ONU. The ONU automatically creates one instance of this ME for each PON physical port.

Relationships

An instance of this ME is associated with each instance of a physical PON interface.

Attributes

Managed entity ID: This attribute uniquely identifies each instance of this ME. Its value indicates the physical position of the PON interface. The first byte is the slot ID, defined in clause 9.1.5. The second byte is the port ID. (R) (mandatory) (2 bytes)

Encryption and FEC capability: This attribute is used by the OLT to read the encryption and FEC capabilities. The most significant 4 bits denote the encryption capability and the least significant 4 bits denote the FEC capability. It is noted that downstream encryption is mandatory.

The coding for the most significant field is specified as follows:

- 0x0: upstream encryption is not supported (1G-EPON ONU)
- 0x1: upstream encryption is supported (1G-EPON ONU)
- 0x2: encryption is activated as part of [IEEE 802.1X] authentication/key establishment (10G/10G-EPON ONU or 10G/1G-EPON ONU)

The coding for the least significant field is specified as follows:

- 0x0: FEC is not supported for 1G link (1G-EPON ONU or 10G/1G-EPON ONU)
- 0x1: FEC is supported for 1G link (1G-EPON ONU or 10G/1G-EPON ONU)
- 0x2: mandatory FEC capability (10G/10G-EPON ONU)

(R) (optional) (1 byte)

Encryption and FEC configuration: This attribute specifies the encryption and FEC operations. The most significant 4 bits designate the upstream encryption and the least significant 4 bits designate the FEC operation.

The coding for the most significant field is specified as follows:

- 0x0: disable upstream encryption for 1G-EPON ONU
- 0x1: enable upstream encryption for 1G-EPON ONU

The coding for the least significant field is specified as follows:

- 0x0: disable FEC for 1G link
- 0x1: enable FEC for 1G link

A 10G/10G-EPON ONU and a 10G/1G-EPON ONU ignores the most significant field. A 10G/10G-EPON ONU also ignores the least significant field.

(R, W) (optional) (1 byte)

ONU capability to configure number of queue sets: This attribute specifies the ONU's capability to configure the number of queue sets. The ONU reports the highest value that it supports for the minimum number of queue sets, and the OLT can configure the minimum number of queue sets to a number that is equal to or less than the reported number.

The coding is specified as follows:

- 0: reserved
- 1: not supported
- 2: supported: the highest value for minimum number of queue sets is 2
- 3: supported: the highest value for minimum number of queue sets is 3
- 4: supported: the highest value for minimum number of queue sets is 4

(R) (mandatory) (1 byte)

NOTE – The queue set is one of fields in the REPORT MPCPDU (multi-point control protocol data unit) and consists of eight queue reports, as defined in clauses 64.3.6.2 and 77.3.6.2 of [IEEE 802.3].

Number of queue sets: This attribute specifies the maximum number of queue sets and the minimum number of queue sets to be used by the given ONU to generate the REPORT MPCPDU. The most significant 4 bits denote the maximum number of queue sets and the least significant 4 bits denote the minimum number of queue sets. The admissible values for each field are 0x01, 0x02, 0x03 and 0x04 if they do not exceed the ONU capability. (R, W) (mandatory) (1 byte)

NOTE – This attribute is read-only, if the ONU capability to configure the number of queue sets attribute indicates code point 1. If flexible configuration is not supported, the ONU should reject an attempt to set it with a parameter error result-reason code.

Threshold configuration: This attribute specifies the threshold type and the threshold ordering to be used by the given ONU to generate the REPORT MPCPDU. The most significant 4 bits denote the threshold type and the least significant 4 bits denote the threshold ordering.

The coding for the most significant field is specified as follows. Code 0 is valid in the get operation.

- 0x0: not configurable (ONU supports aggregated threshold type only)
- 0x1: aggregated threshold
- 0x2: dedicated threshold

The coding for the least significant field is specified as follows. Code 0 is valid in the get operation.

- 0x0: not configurable (ONU supports descending order only)
- 0x1: descending order
- 0x2: ascending order

(R, W) (mandatory) (1 byte)

ONU capability to configure threshold starting point: This attribute specifies the ONU capability to configure the threshold starting point.

The coding is specified as follows.

- 0: supported
- 1: not supported

(R) (mandatory) (1 byte)

Threshold starting point: This attribute specifies the threshold starting point to be used by the given ONU to generate the REPORT MPCPDU.

The coding is specified as follows.

- 0: end of granted packet
- 1: buffer head

(R, W) (mandatory) (1 byte)

Number of queue threshold sets: This attribute specifies the number of queue threshold sets to be used by the given ONU to generate the REPORT MPCPDU. This number covers the queue set used to report the total queue length. The admissible values for this field are 1, 2, 3 and 4. (R, W) (mandatory) (1 byte)

Aggregated threshold table: This attribute is a list that specifies the value of aggregated threshold, in time quanta (TQs), associated with the queues that are to be present in the REPORT MPCPDU generated by the ONU if the threshold type is aggregated threshold. The queue occupancy included in the queue No. n report field in the REPORT MPCPDU is always less than or equal to the provisioned value of the No. n threshold, while observing the frame boundaries.

Each list entry is as follows:

- threshold index number: 0-3 (1 byte)
- aggregated threshold value (2 bytes)

A set action to a particular value overwrites any existing entry with the same first 1 byte. If the last 2 bytes of a set command are all zero, that entry is cleared from the list. Moreover, if the first 1 byte of a set is 0xFF, the entire table is cleared.

(R, W) (mandatory) ($3N$ bytes, where N is the number of entries in the table)

Dedicated threshold table: This attribute is a list that specifies the value of dedicated threshold, in TQs, to be associated with the given queue within the particular queue threshold set if the threshold type is dedicated threshold.

Each list entry is as follows:

- index number (1 byte)
 - bits 7-4: queue set index number 0-3
 - bits 3-0: threshold index number 0-7
- dedicated threshold value (2 bytes)

A set action to a particular value overwrites any existing entry with the same first 1 byte. If the last 2 bytes of a set command are all zero, that entry is cleared from the list. Moreover, if the first 1 byte of a set is 0xFF, the entire table is cleared.

(R, W) (mandatory) ($3N$ bytes, where N is the number of entries in the table)

ONU capability to configure queue service procedure: This attribute specifies the ONU capability to configure queue service procedure.

The coding is specified as follows:

- 0: supported
- 1: not supported

(R) (mandatory) (1 byte)

Ability to set queue service procedure: This attribute specifies which type(s) of procedure are supported by the ONU.

The bit map is specified as follows:

- | | |
|------------------------------|------------------|
| bit 1 (LSB): Threshold-first | 0: supported |
| | 1: not supported |
| bit 2: Priority-first | 0: supported |
| | 1: not supported |

bit 3: Strict priority 0: supported
 1: not supported

(R) (mandatory) (1 bytes)

Queue service procedure: This attribute specifies the threshold starting point to be used by the given ONU to generate the REPORT MPCPDU.

The coding is specified as follows:

0: Threshold-first

1: Priority-first

2: Strict priority

(R, W) (mandatory) (1 byte)

Holdover time out: This attribute is used by the OLT to configure the holdover timer in the ONU. The value is expressed in milliseconds. The default value is 200 ms.

(R, W) (optional) (4 bytes)

TLoS_optical: This attribute is used by the OLT to configure the TLoS_optical (time threshold of optical signal loss) value, which is the period of time that has to elapse before the ONU moves to the holdover state if no optical signal is detected. The value is expressed in milliseconds. The default value is 200 ms.

(R, W) (optional) (2 bytes)

TLoS_MAC: This attribute is used by the OLT to configure the TLoS_MAC (time threshold of GATE MPCPDU loss) value, which is the period of time that has to elapse before the ONU moves to the holdover state if no GATE MPCPDU is received. This parameter corresponds to the gate_timeout as specified in clauses 64.3.5.1 and 77.3.5.1 of [IEEE 802.3]. The value is expressed in milliseconds. The default value is 50 ms.

(R, W) (optional) (2 bytes)

Actions

Get, set, get-next

Set table (optional)

Test: Test the ANI-E (optional). The test action can be used to collect some of the PM data for a small form factor (SFF)-8472 compliant transceiver on the ANI side, such as optical transceiver unit temperature, optical transceiver unit supply voltage, optical transmitter unit bias current, optical transceiver unit output power and optical transceiver unit input power. Test and test result messages are defined in Annex A.

Notifications

Test result: Test results are reported via a test message if the test is invoked by a test command from the OLT.

9.2.20 EPON downstream performance monitoring configuration

This ME represents window sizes and threshold values for EPON downstream PM operations which are defined in [IEEE 802.3] as: errored symbol period, errored frame, errored frame period and errored frame seconds summary.

The EPON ONU automatically instantiates an instance of this ME for each ANI-E.

Relationships

An instance of this ME is associated with an ANI-E.

Attributes

Managed entity ID: This attribute uniquely identifies each instance of this ME. Through an identical ID, this ME is implicitly linked to an instance of the ANI-E. (R, set-by-create) (mandatory) (2 bytes)

Errored symbol period window: This attribute specifies the number of symbols in the measurement period, as defined in clause 57.5.3.1 of [IEEE 802.3]. (R, W) (optional) (8 bytes)

Errored symbol period threshold: This attribute specifies the threshold of errored symbols for generating an event report, as defined in clause 57.5.3.1 of [IEEE 802.3]. (R, W) (optional) (8 bytes)

Errored frame window: This attribute specifies the duration in units of 100 ms of the measurement period, as defined in clause 57.5.3.2 of [IEEE 802.3]. (R, W) (optional) (2 bytes)

Errored frame threshold: This attribute specifies the threshold of errored frames for generating an event report, as defined in clause 57.5.3.2 of [IEEE 802.3]. (R, W) (optional) (4 bytes)

Errored frame period window: This attribute specifies the duration in terms of frames of the measurement period, as defined in clause 57.5.3.3 of [IEEE 802.3]. (R, W) (optional) (4 bytes)

Errored frame period threshold: This attribute specifies the threshold of errored frames for generating an event report, as defined in clause 57.5.3.3 of [IEEE 802.3]. (R, W) (optional) (4 bytes)

Errored frame seconds summary window: This attribute specifies the duration in units of 100 ms of the measurement period, as defined in clause 57.5.3.4 of [IEEE 802.3]. (R, W) (optional) (2 bytes)

Errored frame seconds summary threshold: This attribute specifies the threshold of errored frame seconds for generating an event report, as defined in clause 57.5.3.4 of [IEEE 802.3]. (R, W) (optional) (2 bytes)

Actions

Get, set

Notifications

None.

9.2.21 This clause is intentionally left blank

9.2.22 Enhanced FEC performance monitoring history data

This ME collects PM data associated with PON downstream FEC counters for XGS-PON and subsequent ITU-T PON systems. Instances of this ME are created and deleted by the OLT.

For a complete discussion of generic PM architecture, refer to clause I.4.

Relationships

An instance of this ME is associated with an instance of the ANI-G ME or an instance of the TWDM channel ME.

Attributes

Managed entity ID: This attribute uniquely identifies each instance of this ME. Through an identical ID, this ME is implicitly linked to an instance of the ANI-G or a TWDM channel. (R, set-by-create) (mandatory) (2 bytes)

Interval end time: This attribute identifies the most recently finished 15 min interval. (R) (mandatory) (1 byte)

Threshold data 64 bit ID: This attribute points to an instance of the threshold data 64 bit ME that contains PM threshold values. (R, W, set-by-create) (mandatory) (2 bytes)

Corrected bytes: This attribute counts the number of bytes that were corrected by the FEC function. (R) (mandatory) (8 bytes)

Corrected code words: This attribute counts the code words that were corrected by the FEC function. (R) (mandatory) (8 bytes)

Uncorrectable code words: This attribute counts errored code words that could not be corrected by the FEC function. (R) (mandatory) (8 bytes)

Total code words: This attribute counts the total received code words. (R) (mandatory) (8 bytes)

FEC errored seconds: This attribute counts seconds during which at least one uncorrectable FEC codeword was received. (R) (mandatory) (2 bytes)

Actions

Create, delete, get, set

Get current data (optional)

Notifications

Threshold crossing alert

Alarm number	Threshold crossing alert	Threshold value attribute No. (Note)
0	Corrected bytes	1
1	Corrected code words	2
2	Uncorrectable code words	3
4	FEC seconds	4

NOTE – This number associates the TCA with the specified threshold value attribute of the threshold data 64 bit managed entity.

9.2.23 Enhanced TC performance monitoring history data

This ME collects PM data associated with the XGS-PON and subsequent ITU-T PON systems' TC layer.

For a complete discussion of generic PM architecture, refer to clause I.4.

Relationships

An instance of this ME is associated with an ANI-G.

Attributes

Managed entity ID: This attribute uniquely identifies each instance of this ME. Through an identical ID, this ME is implicitly linked to an instance of the ANI-G. (R, set-by-create) (mandatory) (2 bytes)

- Interval end time:** This attribute identifies the most recently finished 15 min interval. (R) (mandatory) (1 byte)
- Threshold data 64 bit ID:** This attribute points to an instance of the threshold data 64 bit ME that contains PM threshold values. (R, W, set-by-create) (mandatory) (2 bytes)
- PSBd HEC error count:** This attribute counts HEC errors in any of the fields of the downstream physical sync block. (R) (optional) (4 bytes)
- XGTC HEC error count:** This attribute counts HEC errors detected in the XGTC header. In [ITU-T G.9807.1], this attribute is used for FS HEC error count management. (R) (optional) (4 bytes)
- Unknown profile count:** This attribute counts the number of grants received whose specified profile was not known to the ONU. (R) (optional) (4 bytes)
- Transmitted XGEM frames:** This attribute counts the number of non-idle XGEM frames transmitted. If an SDU is fragmented, each fragment is an XGEM frame and is counted as such. (R) (mandatory) (8 bytes)
- Fragment XGEM frames:** This attribute counts the number of XGEM frames that represent fragmented SDUs, as indicated by the LF bit = 0. (R) (optional) (8 bytes)
- XGEM HEC lost words count:** This attribute counts the number of 4 byte words lost because of an XGEM frame HEC error. In general, all XGTC payload following the error is lost, until the next PSBd event. (R) (optional) (8 bytes)
- XGEM key errors:** This attribute counts the number of downstream XGEM frames received with an invalid key specification. The key may be invalid for several reasons, among which are:
- a) GEM port provisioned for clear text and key index not equal to 00;
 - b) no multicast key of the specified key index has been provided via the OMCI for a multicast GEM port;
 - c) no unicast key of the specified key index has been successfully negotiated (see clause 15.5 of [ITU-T G.987.3] or clause C.15.5 of [ITU-T G.9807.1] for key negotiation state machine);
 - d) GEM port specified to be encrypted and key index = 00;
 - e) key index = 11, a reserved value.
- (R) (mandatory) (8 bytes)
- XGEM HEC error count:** This attribute counts the number of instances of an XGEM frame HEC error. (R) (mandatory) (8 bytes)
- Transmitted bytes in non-idle XGEM frames:** This attribute counts the number of transmitted bytes in non-idle XGEM frames. (R) (mandatory) (8 bytes)
- Received bytes in non-idle XGEM frames:** This attribute counts the number of received bytes in non-idle XGEM frames. (R) (optional) (8 bytes)
- LODS event count:** This attribute counts the number of state transitions from O5.1 to O6. (R) (optional) (4 bytes)
- LODS event restored count:** This attribute counts the number of LODS cleared events. (R) (optional) (4 bytes)
- ONU reactivation by LODS events:** This attribute counts the number of LODS events resulting in ONU reactivation without synchronization being reacquired. (R) (optional) (4 bytes)

Actions

Create, delete, get, set

Get current data (optional)

Notifications

Threshold crossing alert

Alarm number	Threshold crossing alert	Threshold value attribute No. (Note)
1	PSBd HEC error count	1
2	XGTC HEC error count	2
3	Unknown profile count	3
4	XGEM HEC loss count	4
5	XGEM key errors	5
6	XGEM HEC error count	6

NOTE – This number associates the TCA with the specified threshold value attribute of the threshold data 64 bit managed entity.

9.3 Layer 2 data services

As outlined in Figure 9.3-1, this clause describes MEs that support layer 2 services, independent of the exact nature of the UNI (Ethernet, MoCA, xDSL). Possible UNIs are described in their own clauses.

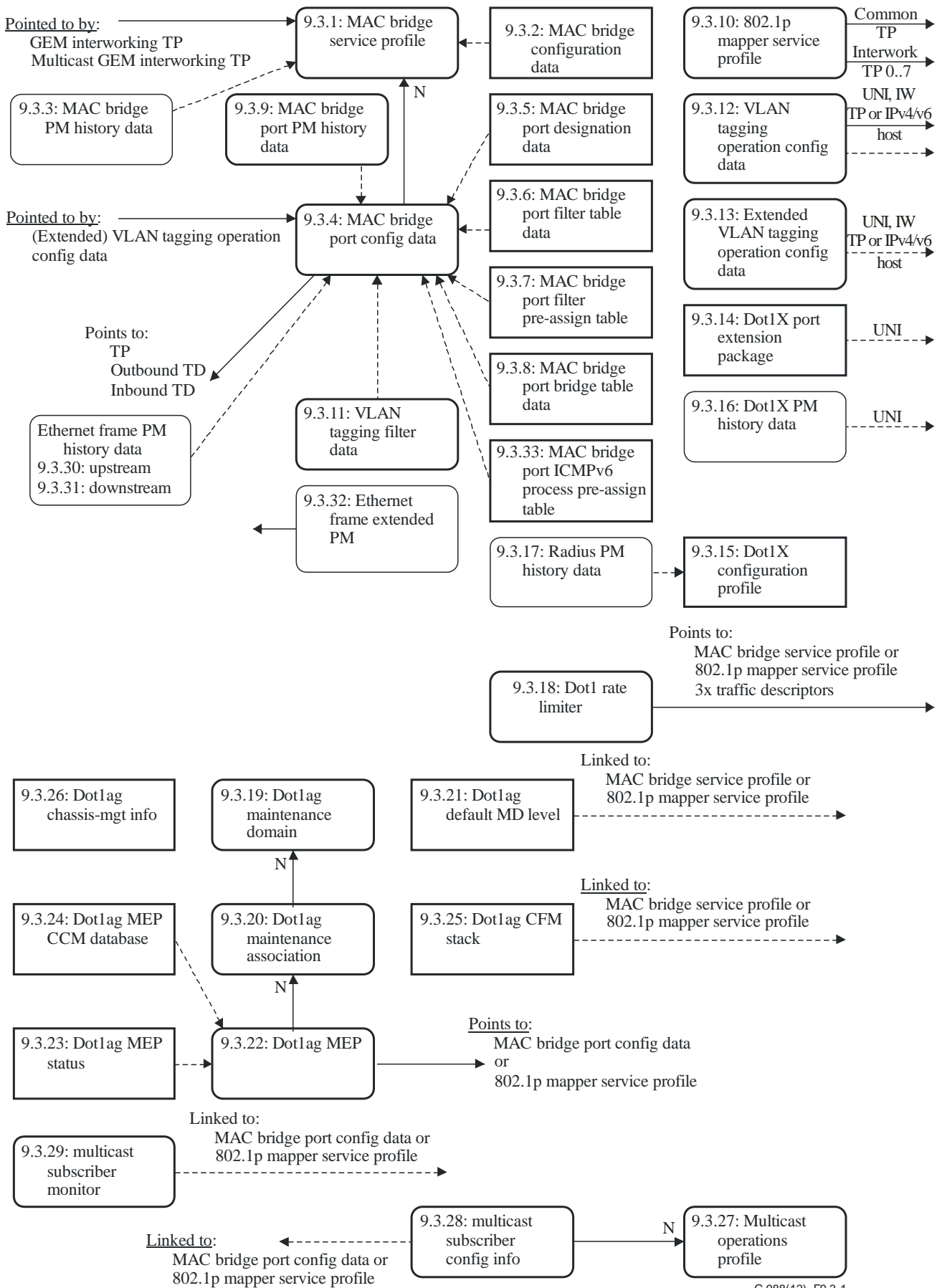

G.988(12)_F9.3-1

Figure 9.3-1 – Managed entities that support layer 2

9.3.1 MAC bridge service profile

This ME models a MAC bridge in its entirety; any number of ports may be associated with the bridge through pointers to the MAC bridge service profile ME. Instances of this ME are created and deleted by the OLT.

Relationships

Bridge ports are modelled by MAC bridge port configuration data MEs, any number of which can point to a MAC bridge service profile. The real-time status of the bridge is available from an implicitly linked MAC bridge configuration data ME.

Attributes

Managed entity ID: This attribute uniquely identifies each instance of this ME. The first byte is the slot ID. In an integrated ONU, this value is 0. The second byte is the bridge group ID. (R, set-by-create) (mandatory) (2 bytes)

Spanning tree ind: The Boolean value true specifies that a spanning tree algorithm is enabled. The value false disables (rapid) spanning tree. (R, W, set-by-create) (mandatory) (1 byte)

Learning ind: The Boolean value true specifies that bridge learning functions are enabled. The value false disables bridge learning. (R, W, set-by-create) (mandatory) (1 byte)

Port bridging ind: The Boolean value true specifies that bridging between UNI ports is enabled. The value false disables local bridging. (R, W, set-by-create) (mandatory) (1 byte)

Priority: This attribute specifies the bridge priority in the range 0..65535. The value of this attribute is copied to the bridge priority attribute of the associated MAC bridge configuration data ME. (R, W, set-by-create) (mandatory) (2 bytes)

Max age: This attribute specifies the maximum age (in 256ths of a second) of received protocol information before its entry in the spanning tree listing is discarded. The range is 0x0600 to 0x2800 (6..40 s) in accordance with [IEEE 802.1D]. (R, W, set-by-create) (mandatory) (2 bytes)

Hello time: This attribute specifies how often (in 256ths of a second) the bridge advertises its presence via hello packets, while acting as a root or attempting to become a root. The range is 0x0100 to 0x0A00 (1..10 s). (R, W, set-by-create) (mandatory) (2 bytes)

NOTE – [IEEE 802.1D] specifies the compatibility range for hello time to be 1..2 s.

Forward delay: This attribute specifies the forwarding delay (in 256ths of a second) when the bridge acts as the root. The range is 0x0400 to 0x1E00 (4..30 s) in accordance with [IEEE 802.1D]. (R, W, set-by-create) (mandatory) (2 bytes)

Unknown MAC address discard: The Boolean value true specifies that MAC frames with unknown DAs be discarded. The value false specifies that such frames be forwarded to all allowed ports. (R, W, set-by-create) (mandatory) (1 byte)

MAC learning depth: This attribute specifies the maximum number of UNI MAC addresses to be learned by the bridge. The default value 0 specifies that there is no administratively imposed limit. (R, W, set-by-create) (optional) (1 byte)

Dynamic filtering ageing time: This attribute specifies the age of dynamic filtering entries in the bridge database, after which unrefreshed entries are discarded. In accordance with clause 7.9.2 of [IEEE 802.1D] and clause 8.8.3 of [IEEE

802.1Q], the range is 10..1 000 000 s, with a resolution of 1 s and a default of 300 s. The value 0 specifies that the ONU uses its internal default. (R, W, set-by-create) (optional) (4 bytes)

Actions

Create, delete, get, set

Notifications

None.

9.3.2 MAC bridge configuration data

This ME organizes status data associated with a MAC bridge. The ONU automatically creates or deletes an instance of this ME upon the creation or deletion of a MAC bridge service profile.

Relationships

This ME is associated with one instance of a MAC bridge service profile.

Attributes

Managed entity ID: This attribute uniquely identifies each instance of this ME. Through an identical ID, this ME is implicitly linked to an instance of the MAC bridge service profile. (R) (mandatory) (2 bytes)

Bridge MAC address: This attribute indicates the MAC address used by the bridge. The ONU sets this attribute to a value based on criteria beyond the scope of this Recommendation, e.g., factory settings. (R) (mandatory) (6 bytes)

Bridge priority: This attribute reports the priority of the bridge. The ONU copies this attribute from the priority attribute of the associated MAC bridge service profile. The value of this attribute changes with updates to the MAC bridge service profile priority attribute. (R) (mandatory) (2 bytes)

Designated root: This attribute identifies the bridge at the root of the spanning tree. It comprises bridge priority (2 bytes) and MAC address (6 bytes). (R) (mandatory) (8 bytes)

Root path cost: This attribute reports the cost of the best path to the root as seen from this bridge. Upon ME instantiation, the ONU sets this attribute to 0. (R) (mandatory) (4 bytes)

Bridge port count: This attribute records the number of ports linked to this bridge. (R) (mandatory) (1 byte)

Root port num: This attribute contains the port number that has the lowest cost from the bridge to the root bridge. The value 0 means that this bridge is itself the root. Upon ME instantiation, the ONU sets this attribute to 0. (R) (mandatory) (2 bytes)

Hello time: This attribute is the hello time received from the designated root, the interval (in 256ths of a second) between HELLO packets. Its range is 0x0100 to 0x0A00 (1..10 s). (R) (optional) (2 bytes)

NOTE – [IEEE 802.1D] specifies the compatibility range for hello time to be 1..2 s.

Forward delay: This attribute is the forwarding delay time received from the designated root (in 256ths of a second). Its range is 0x0400 to 0x1E00 (4..30 s) in accordance with [IEEE 802.1D]. (R) (optional) (2 bytes)

Actions

Get

Notifications

None.

9.3.3 MAC bridge performance monitoring history data

This ME collects PM data associated with a MAC bridge. Instances of this ME are created and deleted by the OLT.

For a complete discussion of generic PM architecture, refer to clause I.4.

Relationships

This ME is associated with an instance of a MAC bridge service profile.

Attributes

Managed entity ID: This attribute uniquely identifies each instance of this ME. Through an identical ID, this ME is implicitly linked to an instance of the MAC bridge service profile. (R, set-by-create) (mandatory) (2 bytes)

Interval end time: This attribute identifies the most recently finished 15 min interval. (R) (mandatory) (1 byte)

Threshold data 1/2 ID: This attribute points to an instance of the threshold data 1 ME that contains PM threshold values. Since no threshold value attribute number exceeds 7, a threshold data 2 ME is optional. Since no threshold value attribute number exceeds 7, a threshold data 2 ME is optional. (R, W, set-by-create) (mandatory) (2 bytes)

Bridge learning entry discard count: This attribute counts forwarding database entries that have been or would have been learned, but were discarded or replaced due to a lack of space in the database table. When used with the MAC learning depth attribute of the MAC bridge service profile, the bridge learning entry discard count may be particularly useful in detecting MAC spoofing attempts. (R) (mandatory) (4 bytes)

Actions

Create, delete, get, set

Get current data (optional)

Notifications

Threshold crossing alert

Alarm number	Threshold crossing alert	Threshold value attribute No. (Note)
0	Bridge learning entry discard	1
NOTE – This number associates the TCA with the specified threshold value attribute of the threshold data 1 managed entity.		

9.3.4 MAC bridge port configuration data

This ME models a port on a MAC bridge. Instances of this ME are created and deleted by the OLT.

Relationships

An instance of this ME is linked to an instance of the MAC bridge service profile. Additional bridge port control capabilities are provided by implicitly linked instances of some or all of:

- MAC bridge port filter table data;
- MAC bridge port filter pre-assign table;
- VLAN tagging filter data;
- Dot1 rate limiter.

Real-time status of the bridge port is provided by implicitly linked instances of:

- MAC bridge port designation data;
- MAC bridge port bridge table data;
- Multicast subscriber monitor.

Bridge port PM collection is provided by implicitly linked instances of:

- MAC bridge port PM history data;
- Ethernet frame PM history data upstream and downstream;
- Ethernet frame extended PM (preferred).

Attributes

Managed entity ID: This attribute uniquely identifies each instance of this ME. (R, set-by-create) (mandatory) (2 bytes)

Bridge ID pointer: This attribute points to an instance of the MAC bridge service profile. (R, W, set-by-create) (mandatory) (2 bytes)

Port num: This attribute is the bridge port number. It must be unique among all ports associated with a particular MAC bridge service profile. (R, W, set-by-create) (mandatory) (1 byte)

TP type: This attribute identifies the type of TP associated with this MAC bridge port. Valid values are as follows.

- 1 Physical path termination point Ethernet UNI
- 2 Interworking virtual circuit connection (VCC) termination point
- 3 IEEE 802.1p mapper service profile
- 4 IP host config data or IPv6 host config data
- 5 GEM interworking termination point
- 6 Multicast GEM interworking termination point
- 7 Physical path termination point xDSL UNI part 1
- 8 Physical path termination point VDSL UNI
- 9 Ethernet flow termination point
- 10 Reserved
- 11 Virtual Ethernet interface point
- 12 Physical path termination point MoCA UNI
- 13 Ethernet in the first mile (EFM) bonding group

(R, W, set-by-create) (mandatory) (1 byte)

TP pointer: This attribute points to the TP associated with this MAC bridge port. The TP type attribute indicates the type of the TP; this attribute contains its instance identifier (ME ID). (R, W, set-by-create) (mandatory) (2 bytes)

NOTE 1 – When the TP type is very high-speed digital subscriber line (VDSL) or xDSL, the two MSBs may be used to indicate a bearer channel.

Port priority: This attribute denotes the priority of the port for use in (rapid) spanning tree algorithms. The range is 0..255. (R, W, set-by-create) (optional) (2 bytes)

Port path cost: This attribute specifies the contribution of the port to the path cost towards the spanning tree root bridge. The range is 1..65535. (R, W, set-by-create) (mandatory) (2 bytes)

Port spanning tree ind: The Boolean value true enables (R)STP LAN topology change detection at this port. The value false disables topology change detection. (R, W, set-by-create) (mandatory) (1 byte)

Deprecated 1: This attribute is not used. If present, it should be ignored by both the ONU and the OLT, except as necessary to comply with OMCI message definitions. (R, W, set-by-create) (optional) (1 byte)

Deprecated 2: This attribute is not used. If present, it should be ignored by both the ONU and the OLT, except as necessary to comply with OMCI message definitions. (R, W, set-by-create) (1 byte) (optional)

Port MAC address: If the TP associated with this port has a MAC address, this attribute specifies it. (R) (optional) (6 bytes)

Outbound TD pointer: This attribute points to a traffic descriptor that limits the traffic rate leaving the MAC bridge. (R, W) (optional) (2 byte)

Inbound TD pointer: This attribute points to a traffic descriptor that limits the traffic rate entering the MAC bridge. (R, W) (optional) (2 byte)

MAC learning depth: This attribute specifies the maximum number of MAC addresses to be learned by this MAC bridge port. The default value 0 specifies that there is no administratively imposed limit. (R, W, set-by-create) (optional) (1 byte)

NOTE 2 – If this attribute is not zero, its value overrides the value set in the MAC learning depth attribute of the MAC bridge service profile.

LASP ID pointer: This attribute points to an instance of the LASP ME. (R,W, set-by-create) (optional) (2 bytes)

Actions

Create, delete, get, set

Notifications

Alarm

Alarm number	Alarm	Description
0	Port blocking	This port has been blocked due to loop detection in accordance with [IEEE 802.1D] (Note).
1..207	Reserved	
208..223	Vendor-specific alarms	Not to be standardized
NOTE – To determine the state of a MAC bridge port, the OLT can read the port state attribute of the MAC bridge port designation data.		

9.3.5 MAC bridge port designation data

This ME records data associated with a bridge port. The ONU automatically creates or deletes an instance of this managed entity upon the creation or deletion of a MAC bridge port configuration data ME.

Relationships

An instance of this managed entity is associated with one MAC bridge port configuration data ME.

Attributes

Managed entity ID: This attribute uniquely identifies each instance of this ME. Through an identical ID, this ME is implicitly linked to an instance of the MAC bridge port configuration data. (R) (mandatory) (2 bytes)

Designated bridge root cost port: This attribute contains the designated root, designated cost, designated bridge and designated port, which are some of the outputs of the *read port parameters* operation defined in clause 14.8.2.1 of [IEEE 802.1D]:

- identifier of the designated bridge for the port's segment (8 bytes);
- bridge identifier of the root transmitted by the designated bridge for the segment (8 bytes);
- port number of the designated port on the designated bridge considered to be part of this port's segment (4 bytes);
- path cost contribution of the designated port to this port's segment (4 bytes).

Upon ME instantiation, the ONU sets this attribute to 0. (R) (mandatory) (24 bytes)

Port state: This attribute provides status information on the port. Valid values include the following.

- 0 Disabled
- 1 Listening
- 2 Learning
- 3 Forwarding
- 4 Blocking
- 5 Linkdown
- 6 (R)Stp_off

in accordance with [IEEE 802.1D]. (R) (mandatory) (1 byte)

NOTE – The value *linkdown* is introduced to denote the port status when the Ethernet link state is down. This value distinguishes the case where Ethernet is physically down from the case where Ethernet is administratively locked, the latter being denoted by *disabled*. Be aware that this terminology violates the ITU-T convention that *disabled* is an operational state, not administrative.

The value (R)stp_off is introduced to denote the port status where the (rapid) spanning tree protocol has been disabled by setting the port spanning tree ind attribute of the MAC bridge port configuration data to false, and the Ethernet link state is up. This value distinguishes whether frame forwarding is under the control of (R)STP.

Actions

Get

Notifications

None.

9.3.6 MAC bridge port filter table data

This ME organizes data associated with a bridge port. The ONU automatically creates or deletes an instance of this ME upon the creation or deletion of a MAC bridge port configuration data ME.

NOTE – The OLT should disable the learning mode in the MAC bridge service profile before writing to the MAC filter table.

Relationships

An instance of this ME is associated with an instance of a MAC bridge port configuration data ME.

Attributes

Managed entity ID: This attribute uniquely identifies each instance of this ME. Through an identical ID, this ME is implicitly linked to an instance of the MAC bridge port configuration data ME. (R) (mandatory) (2 bytes)

MAC filter table: This attribute lists MAC addresses associated with the bridge port, each with an allow/disallow forwarding indicator for traffic flowing out of the bridge port. Additionally, the forwarding action may be based on a MAC source or DA. In this way, upstream traffic is filtered on ANI-side bridge ports, and downstream traffic is filtered on UNI-side bridge ports. The setting of an entry with a forward action implies that all other addresses are filtered. Conversely, the setting of an entry with a filter action implies that all other addresses are forwarded. The behaviour is unspecified if forward and filter actions are mixed.

Each entry contains:

- the entry number, an index into this attribute list (1 byte);
- filter byte (1 byte);
- MAC address (6 bytes).

The bits of the filter byte are assigned as follows.

Bit	Name	Setting
1 (LSB)	Filter/forward	0: forward 1: filter
2		0: MAC DAs 1: MAC source addresses
3..6	Reserved	0
7..8	Add/remove	10: Clear entire table (set operation) 00: Remove this entry (set operation) 01: Add this entry

Upon ME instantiation, the ONU sets this attribute to an empty table.

(R, W) (Mandatory) (8*N* bytes, where *N* is the number of entries in the list)

Actions

Get, get next, set

Set table (optional)

Notifications

None.

9.3.7 MAC bridge port filter pre-assign table

This ME provides an alternate approach to DA filtering from that supported through the MAC bridge port filter table data ME. This alternate approach is useful when all groups of addresses are stored beforehand in the ONU, and the MAC bridge port filter pre-assign table ME designates which groups are valid or invalid for filtering. On a circuit pack in which all groups of addresses are pre-assigned and stored locally, the ONU creates or deletes an instance of this ME automatically upon creation or deletion of a MAC bridge port configuration data ME.

Relationships

An instance of this ME is associated with an instance of a MAC bridge port configuration data ME.

Attributes

Managed entity ID: This attribute uniquely identifies each instance of this ME. Through an identical ID, this ME is implicitly linked to an instance of the MAC bridge port configuration data ME. (R) (mandatory) (2 bytes)

The following 10 attributes have similar definitions. Each permits the OLT to specify whether MAC DAs or Ethertypes of the named type are forwarded (0) or filtered (1). In each case, the initial value of the attribute is 0.

No.	Protocol	MAC address	Ethertype	Standard
1	IPv4 multicast	01.00.5E.00.00.00 – 01.00.5E.7F.FF.FF	–	[b-IETF RFC 3232]
2	IPv6 multicast (Note)	33.33.00.00.00.00 – 33.33.FF.FF.FF.FF	–	[IETF RFC 2464]
3	IPv4 broadcast	FF.FF.FF.FF.FF.FF	0x0800	[b-IETF RFC 3232]
4	RARP	FF.FF.FF.FF.FF.FF	0x8035	[b-IETF RFC 3232]
5	IPX	FF.FF.FF.FF.FF.FF	0x8137	[b-IETF RFC 3232]
		09.00.1B.FF.FF.FF, 09.00.4E.00.00.02	–	
6	NetBEUI	03.00.00.00.00.01	–	
7	AppleTalk	FF.FF.FF.FF.FF.FF	0x809B, 0x80F3	[b-IETF RFC 3232]
		09.00.07.00.00.00 – 09.00.07.00.00.FC, 09.00.07.FF.FF.FF	–	
8	Bridge management information	01.80.C2.00.00.00 – 01.80.C2.00.00.FF	–	[IEEE 802.1D]
9	Address resolution protocol (ARP)	FF.FF.FF.FF.FF.FF	0x0806	[b-IETF RFC 3232]
10	PPPoE broadcast	FF.FF.FF.FF.FF.FF	0x8863	[b-IETF RFC 2516]

NOTE – The specified MAC address range does not distinguish network control traffic from user traffic. The dot1 rate limiter may be a preferable way to limit the flow of IPv6 multicast traffic.

IPv4 multicast filtering:

(R, W) (mandatory) (1 byte)

IPv6 multicast filtering:	(R, W) (mandatory) (1 byte)
IPv4 broadcast filtering:	(R, W) (mandatory) (1 byte)
RARP filtering:	(R, W) (mandatory) (1 byte)
IPX filtering:	(R, W) (mandatory) (1 byte)
NetBEUI filtering:	(R, W) (mandatory) (1 byte)
AppleTalk filtering:	(R, W) (mandatory) (1 byte)
Bridge management information filtering:	(R, W) (mandatory) (1 byte)

Note that some destination MAC addresses should never be forwarded, considering the following rules of [IEEE 802.1D].

- 1 Addresses from 01.80.C2.00.00.00 to 01.80.C2.00.00.0F are reserved.
- 2 Addresses from 01.80.C2.00.00.20 to 01.80.C2.00.00.2F are used for generic attribute registration protocol (GARP) applications.

ARP filtering:	(R, W) (mandatory) (1 byte)
Point-to-point protocol over Ethernet (PPPoE) broadcast filtering:	(R, W) (mandatory) (1 byte)

Actions

Get, set

Notifications

None.

9.3.8 MAC bridge port bridge table data

This ME reports status data associated with a bridge port. The ONU automatically creates or deletes an instance of this ME upon the creation or deletion of a MAC bridge port configuration data.

Relationships

An instance of this ME is associated with an instance of a MAC bridge port configuration data ME.

Attributes

Managed entity ID: This attribute uniquely identifies each instance of this ME. Through an identical ID, this ME is implicitly linked to an instance of the MAC bridge port configuration data ME. (R) (mandatory) (2 bytes)

Bridge table: This attribute lists known MAC DAs, whether they are learned or statically assigned, whether packets that have them as DAs are filtered or forwarded, and their ages. Each entry contains:

- Information (2 bytes);
- MAC address (6 bytes).

The information bits are assigned as described as follows.

Bit	Name	Setting
1 (LSB)	Filter/forward	0: forward 1: filter
2	Reserved	0
3	Dynamic/static	0: this entry is statically assigned 1: this entry is dynamically learned
4	Reserved	0

16..5 Age Age in seconds (1..4095)

Upon ME instantiation, this attribute is an empty list. (R) (mandatory)
(8 * M bytes, where M is the number of entries in the list.)

Actions

Get, get next

Notifications

None.

9.3.9 MAC bridge port performance monitoring history data

This ME collects PM data associated with a MAC bridge port. Instances of this ME are created and deleted by the OLT.

For a complete discussion of generic PM architecture, refer to clause I.4.

Relationships

An instance of this ME is associated with an instance of a MAC bridge port configuration data ME.

Attributes

Managed entity ID: This attribute uniquely identifies each instance of this ME. Through an identical ID, this ME is implicitly linked to an instance of the MAC bridge port configuration data ME. (R, set-by-create) (mandatory) (2 bytes)

Interval end time: This attribute identifies the most recently finished 15 min interval. (R) (mandatory) (1 byte)

Threshold data 1/2 ID: This attribute points to an instance of the threshold data 1 ME that contains PM threshold values. Since no threshold value attribute number exceeds 7, a threshold data 2 ME is optional. (R, W, set-by-create) (mandatory) (2 bytes)

Forwarded frame counter: This attribute counts frames transmitted successfully on this port. (R) (mandatory) (4 bytes)

Delay exceeded discard counter: This attribute counts frames discarded on this port because transmission was delayed. (R) (mandatory) (4 bytes)

Maximum transmission unit (MTU) exceeded discard counter: This attribute counts frames discarded on this port because the MTU was exceeded. (R) (mandatory) (4 bytes)

Received frame counter: This attribute counts frames received on this port. (R) (mandatory) (4 bytes)

Received and discarded counter: This attribute counts frames received on this port that were discarded due to errors. (R) (mandatory) (4 bytes)

Actions

Create, delete, get, set

Get current data (optional)

Threshold crossing alert

Alarm number	Threshold crossing alert	Threshold value attribute No. (Note)
1	Delay exceeded discard	1
2	MTU exceeded discard	2
4	Received and discarded	3

NOTE – This number associates the TCA with the specified threshold value attribute of the threshold data 1 managed entity.

9.3.10 IEEE 802.1p mapper service profile

This ME associates the priorities of IEEE 802.1p [IEEE 802.1D] priority tagged frames with specific connections. This ME directs upstream traffic to the designated GEM ports. Downstream traffic arriving on any of the IEEE 802.1p mapper's GEM ports is directed to the mapper's root TP. Other mechanisms exist to direct downstream traffic, specifically a direct pointer to a downstream queue from the GEM port network CTP. If such an alternative is used, it should be provisioned to be consistent with the flow model of the mapper.

Instances of this ME are created and deleted by the OLT.

Relationships

At its root, an instance of this ME may be associated with zero or one instance of a PPTP UNI, MAC bridge port configuration data, or any type of IW TP ME that carries IEEE 802 traffic. Each of its eight branches is associated with zero or one GEM IW TP.

Attributes

Managed entity ID: This attribute uniquely identifies each instance of this ME. (R, set-by-create) (mandatory) (2 bytes)

TP pointer: This attribute points to an instance of the associated TP.

If the optional TP type attribute is not supported, the TP pointer indicates bridging mapping with the value 0xFFFF; the TP pointer may also point to a PPTP Ethernet UNI.

The TP type value 0 also indicates bridging mapping, and the TP pointer should be set to 0xFFFF.

In all other cases, the TP type is determined by the TP type attribute.

(R, W, set-by-create) (mandatory) (2 bytes)

Each of the following eight attributes points to the GEM IW TP associated with the stated P-bit value. The null pointer 0xFFFF specifies that frames with the associated priority are to be discarded.

Interwork TP pointer for P-bit priority 0: (R, W, set-by-create) (mandatory) (2 bytes)

Interwork TP pointer for P-bit priority 1: (R, W, set-by-create) (mandatory) (2 bytes)

Interwork TP pointer for P-bit priority 2: (R, W, set-by-create) (mandatory) (2 bytes)

Interwork TP pointer for P-bit priority 3: (R, W, set-by-create) (mandatory) (2 bytes)

Interwork TP pointer for P-bit priority 4: (R, W, set-by-create) (mandatory) (2 bytes)

Interwork TP pointer for P-bit priority 5: (R, W, set-by-create) (mandatory) (2 bytes)

Interwork TP pointer for P-bit priority 6: (R, W, set-by-create) (mandatory) (2 bytes)

Interwork TP pointer for P-bit priority 7: (R, W, set-by-create) (mandatory) (2 bytes)

Unmarked frame option: This attribute specifies how the ONU should handle untagged Ethernet frames received across the associated interface. Although it does not alter the frame in any way, the ONU routes the frame as if it were tagged with P bits (PCP field) according to the following code points.

- 0 Derive implied PCP field from DSCP bits of received frame
- 1 Set implied PCP field to a fixed value specified by the default P-bit assumption attribute

(R, W, set-by-create) (mandatory) (1 byte)

Untagged downstream frames are passed through the mapper transparently.

DSCP to P-bit mapping: This attribute is valid when the unmarked frame option attribute is set to 0. The DSCP to P-bit attribute can be considered a bit string sequence of 64 3 bit groupings. The 64 sequence entries represent the possible values of the 6 bit DSCP field. Each 3 bit grouping specifies the P-bit value to which the associated DSCP value should be mapped. The unmarked frame is then directed to the GEM IW TP indicated by the interwork TP pointer mappings. (R, W) (mandatory) (24 bytes)

NOTE – If certain bits in the DSCP field are to be ignored in the mapping process, the attribute should be provisioned such that all possible values of those bits produce the same P-bit mapping. This can be applied to the case where instead of full DSCP, the operator wishes to adopt the priority mechanism based on IP precedence, which needs only the three MSBs of the DSCP field.

Default P-bit assumption: This attribute is valid when the unmarked frame option attribute is set to 1. In its LSBs, the default P-bit assumption attribute contains the default PCP field to be assumed. The unmodified frame is then directed to the GEM IW TP indicated by the interwork TP pointer mappings. (R, W, set-by-create) (mandatory) (1 byte)

TP type: This attribute identifies the type of TP associated with the mapper.

- 0 Mapper used for bridging-mapping
- 1 Mapper directly associated with a PPTP Ethernet UNI
- 2 Mapper directly associated with an IP host config data or IPv6 host config data ME
- 3 Mapper directly associated with an Ethernet flow termination point
- 4 Mapper directly associated with a PPTP xDSL UNI
- 5 Reserved
- 6 Mapper directly associated with a PPTP MoCA UNI
- 7 Mapper directly associated with a virtual Ethernet interface point
- 8 Mapper directly associated with an IW VCC termination point
- 9 Mapper directly associated with an EFM bonding group

(R, W, set-by-create) (optional) (1 byte)

Actions

Create, delete, get, set

Notifications

None.

9.3.11 VLAN tagging filter data

This ME organizes data associated with VLAN tagging. Instances of this ME are created and deleted by the OLT.

Relationships

An instance of this ME is associated with an instance of a MAC bridge port configuration data ME. By definition, tag filtering occurs closer to the MAC bridge than the tagging operation. Schematically, the ordering of the functions is as given in Figure 9.3.11-1:

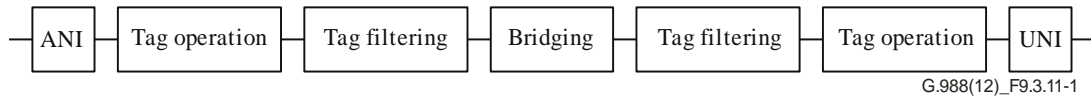

Figure 9.3.11-1

Attributes

Managed entity ID: This attribute uniquely identifies each instance of this ME. Through an identical ID, this ME is implicitly linked to an instance of the MAC bridge port configuration data ME. (R, set-by-create) (mandatory) (2 bytes)

VLAN filter list: This attribute is a list of provisioned tag control information (TCI) values for the bridge port. A TCI, comprising user priority, canonical format indicator (CFI) and virtual local area network identifier (VID), is represented by 2 bytes. This attribute supports up to 12 VLAN entries. The first *N* are valid, where *N* is given by the number of entries attribute. (R, W, set-by-create) (mandatory) (24 bytes)

Forward operation: When a frame passes through the MAC bridge port, it is processed according to the operation specified by this attribute, in accordance with Table 9.3.11-1. Figure 9.3.11-3 illustrates the treatment of frames according to the provisioned action possibilities. Tagged and untagged frames are treated separately, but both in accordance with Figure 9.3.11-3. While all forwarding operations are plausible, only actions 0x10 and 0x12 are necessary to construct a VLAN mapper and an 802.1p mapper, respectively. (R, W, set-by-create) (mandatory) (1 byte)

Table 9.3.11-1 – Forward operation attribute values

Forward operation	Type of received frame	
	Tagged	Untagged
0x00	Bridging (a) (no investigation)	Bridging (a)
0x01	Discarding (c)	Bridging (a)
0x02	Bridging (a) (no investigation)	Discarding (c)
0x03	Action (h) (VID investigation)	Bridging (a)
0x04	Action (h) (VID investigation)	Discarding (c)
0x05	Action (g) (VID investigation)	Bridging (a)
0x06	Action (g) (VID investigation)	Discarding (c)
0x07	Action (h) (user priority investigation)	Bridging (a)
0x08	Action (h) (user priority investigation)	Discarding (c)
0x09	Action (g) (user priority investigation)	Bridging (a)

Table 9.3.11-1 – Forward operation attribute values

Forward operation	Type of received frame	
	Tagged	Untagged
0x0A	Action (g) (user priority investigation)	Discarding (c)
0x0B	Action (h) (TCI investigation)	Bridging (a)
0x0C	Action (h) (TCI investigation)	Discarding (c)
0x0D	Action (g) (TCI investigation)	Bridging (a)
0x0E	Action (g) (TCI investigation)	Discarding (c)
0x0F	Action (h) (VID investigation)	Bridging (a)
0x10	Action (h) (VID investigation)	Discarding (c)
0x11	Action (h) (user priority investigation)	Bridging (a)
0x12	Action (h) (user priority investigation)	Discarding (c)
0x13	Action (h) (TCI investigation)	Bridging (a)
0x14	Action (h) (TCI investigation)	Discarding (c)
0x15	Bridging (a) (no investigation)	Discarding (c)
0x16	Action (j) (VID investigation)	Bridging (a)
0x17	Action (j) (VID investigation)	Discarding (c)
0x18	Action (j) (user priority investigation)	Bridging (a)
0x19	Action (j) (user priority investigation)	Discarding (c)
0x1A	Action (j) (TCI investigation)	Bridging (a)
0x1B	Action (j) (TCI investigation)	Discarding (c)
0x1C	Action (h) (VID investigation)	Bridging (a)
0x1D	Action (h) (VID investigation)	Discarding (c)
0x1E	Action (h) (user priority investigation)	Bridging (a)
0x1F	Action (h) (user priority investigation)	Discarding (c)
0x20	Action (h) (TCI investigation)	Bridging (a)
0x21	Action (h) (TCI investigation)	Discarding (c)

Table 9.3.11-1 contains duplicate entries due to simplification of the original set of actions.

Table 9.3.11-1 and the actions listed are discussed in detail in the following.

Number of entries: This attribute specifies the number of valid entries in the VLAN filter list. (R, W, set-by-create) (mandatory) (1 byte)

Actions

Create, delete, get, set

Notifications

None.

Supplementary explanation

This section explains the actions specified in the forward operation attribute.

The format of an Ethernet frame for VLAN services is described in [IEEE 802.1Q] and [IEEE 802.1ad]. See Figure 9.3.11-2.

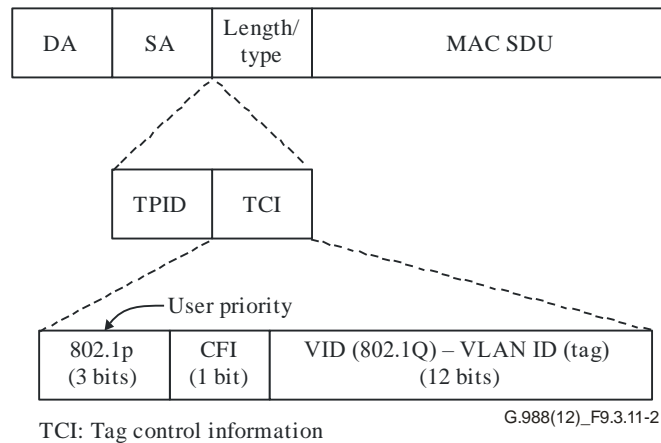

Figure 9.3.11-2 – Format of an Ethernet frame for VLAN services

- a) **Basic MAC bridge operation:** All frames are accepted into the MAC bridging entity. Egress frames are forwarded from this port if either a) the frame's MAC DA is listed in the MAC bridge port bridge table data for this port or b) the frame's DA does not appear in the MAC bridge port bridge table data for any port (flooding). The contents of the VLAN filter list attribute are not meaningful. See Figure 9.3.11-3.

NOTE – Action (a) on a given port may imply egress flooding of a frame from other ports of the bridge. The possible VLAN tagging filter data MEs attached to the other ports override this action however, so the frame is only transmitted from another port if it also satisfies the forward operation attribute value established on that port.

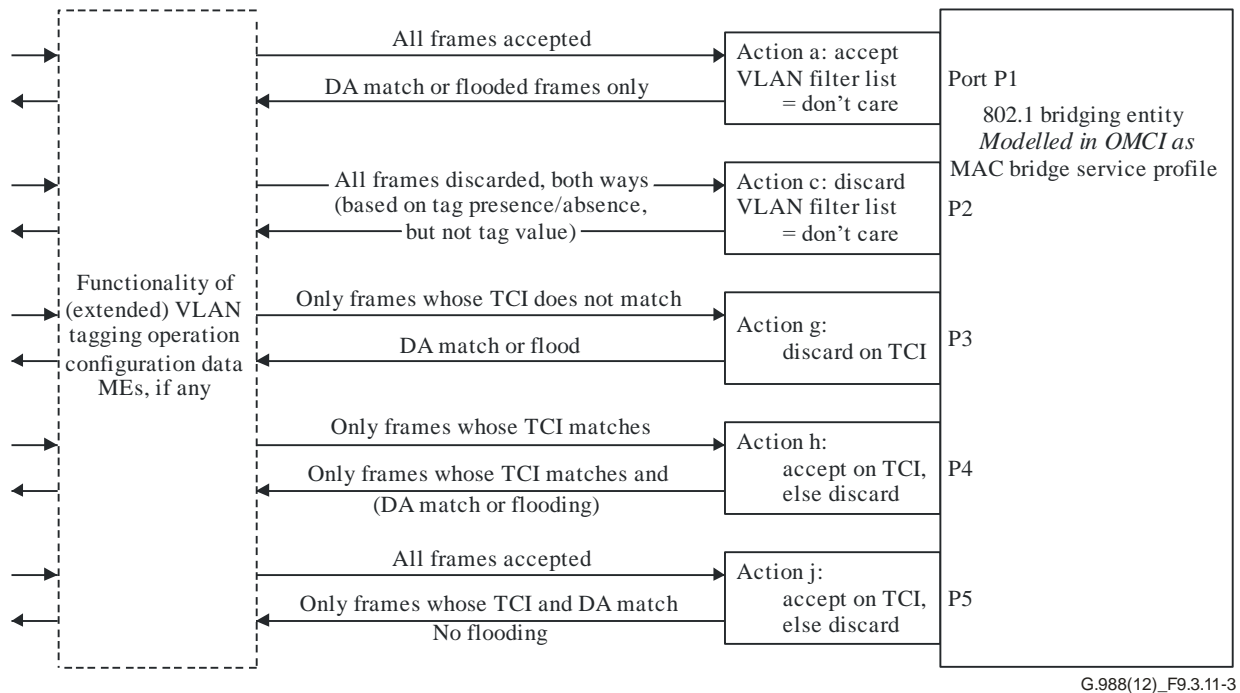

Figure 9.3.11-3 – Forwarding behaviour

Other possible actions are as follows:

- c) **Unconditional discarding:** Frames in both directions are unconditionally discarded without an investigation of TCI or a MAC address. This action can be used to discard all tagged traffic or all untagged traffic at the port of attachment, depending on the forward operation attribute value. The contents of the VLAN filter list attribute are not meaningful.
- g) **Negative filtering by TCI:** All frames are admitted into the bridging entity. If the specified fields in the TCI of a candidate egress frame match any entry in the VLAN filter list, the frame is not forwarded by this port. Otherwise, the frame is forwarded based on the destination MAC address, according to action a).
- h) **Bidirectional positive filtering by TCI:** Both ingress and egress frames are filtered on investigation of the TCI fields. If and only if the specified fields in the TCI of a candidate ingress frame match an entry in the VLAN filter list, the frame is admitted into the bridge. If and only if the specified fields in the TCI of a candidate egress frame match an entry in the VLAN filter list, the frame is forwarded based on the destination MAC address, according to action a).
- j) **Positive filtering by TCI and DA:** All frames are admitted into the bridging entity. If the specified fields in the TCI of a candidate egress frame match any entry in the VLAN filter list, the frame is forwarded based on the destination MAC address. The frame is never flooded to this or other ports. If the specified TCI fields and DA do not both match, the frame is discarded.

Action codes b), d), e) and f) are not used.

9.3.12 VLAN tagging operation configuration data

This ME organizes data associated with VLAN tagging. Instances of this ME are created and deleted by the OLT.

NOTE 1 – The extended VLAN tagging operation configuration data of clause 9.3.13 is preferred for new implementations.

Relationships

Zero or one instance of this ME may exist for an instance of any ME that can terminate or modify an Ethernet stream.

When this ME is associated with a UNI-side TP, it performs its upstream classification and tagging operations before offering the upstream frame to other filtering, bridging or switching functions. In the downstream direction, the defined inverse operation is the last operation performed on the frame before offering it to the UNI-side termination.

When this ME is associated with an ANI-side TP, it performs its upstream classification and tagging operations as the last step before queuing for transmission to the OLT, after having received the upstream frame from other filtering, bridging or switching functions. In the downstream direction, the defined inverse operation is the first operation performed on the frame before offering it to possible filter, bridge or switch functions.

Attributes

Managed entity ID: This attribute uniquely identifies each instance of this ME. When the optional association type attribute is 0 or undefined, this attribute's value is the same as the ID of the ME with which this VLAN tagging operation configuration data instance is associated, which may be either a PPTP Ethernet UNI or an IP host config data or an IPv6 host config data ME. Otherwise, the value of the ME ID is unconstrained except by the need to be unique. (R, set-by-create) (mandatory) (2 bytes)

Upstream VLAN tagging operation mode: This attribute controls upstream VLAN tagging.

Valid values are as follows.

- 0 Upstream frame is sent as is, regardless of tag.
- 1 The upstream frame is tagged, whether or not the received frame was tagged. A tagged frame's TCI is overwritten with the upstream VLAN tag TCI value. An untagged frame is prepended with a tag whose values are taken from the upstream VLAN tag TCI value attribute.
- 2 A tag is prepended to the upstream frame, whether or not the received frame was tagged. If the received frame is tagged, a second tag (Q-in-Q) is added to the frame. If the received frame is not tagged, a tag is attached to the frame. The added tag is defined by the upstream VLAN tag TCI value attribute.

(R, W, set-by-create) (mandatory) (1 byte)

Upstream VLAN tag TCI value: This attribute specifies the TCI for upstream VLAN tagging. It is used when the upstream VLAN tagging operation mode is 1 or 2.

(R, W, set-by-create) (mandatory) (2 bytes)

Downstream VLAN tagging operation mode: This attribute controls downstream VLAN tagging. Valid values are as follows.

- 0 Downstream frame is sent as is, regardless of tag.
- 1 If the received frame is tagged, the outer tag is stripped. An untagged frame is forwarded unchanged.

(R, W, set-by-create) (mandatory) (1 byte)

Association type: This attribute specifies the type of ME that is associated with this VLAN tagging operation configuration data ME. Values are assigned in accordance with the following list.

- 0 (Default) Physical path termination point Ethernet UNI (for backward compatibility, may also be an IP host config data ME; they must not have the same ME ID). The associated ME instance is implicit; its identifier is the same as that of this VLAN tagging operation configuration data.
- 1 IP host config data or IPv6 host config data
- 2 IEEE 802.1p mapper service profile
- 3 MAC bridge port configuration data
- 4 Physical path termination point xDSL UNI
- 5 GEM IW termination point
- 6 Multicast GEM IW termination point
- 7 Physical path termination point MoCA UNI
- 8 Reserved
- 9 Ethernet flow termination point
- 10 Physical path termination point Ethernet UNI
- 11 Virtual Ethernet interface point
- 12 MPLS pseudowire termination point
- 13 EFM bonding group

The associated ME instance is identified by the associated ME pointer. (R, W, set-by-create) (optional) (1 byte)

Associated ME pointer: When the association type attribute is non-zero, this attribute points to the ME with which this VLAN tagging operation configuration data ME is associated. Otherwise, this attribute is undefined, and the association is implicit through the ME ID. (R, W, set-by-create) (optional) (2 bytes)

NOTE 2 – Implicit association is retained for legacy compatibility. Explicit pointers are preferred for new implementations.

NOTE 3 – When the association type is xDSL, the two MSBs may be used to indicate a bearer channel.

Actions

Create, delete, get, set

Notifications

None.

9.3.13 Extended VLAN tagging operation configuration data

This ME organizes data associated with VLAN classification and tagging operations. Regardless of its point of attachment, the specified tagging operations refer to the upstream direction. Instances of this ME are created and deleted by the OLT.

Through separate attributes, this ME supports either a Received frame VLAN tagging operation table attribute in its backward compatible form, or an enhanced frame classification and processing capability. The OLT can determine whether the ONU supports the enhanced capability through the Enhanced mode attribute of the ONU3-G ME.

Relationships

Zero or one instance of this ME may exist for an instance of any ME that can terminate or modify an Ethernet stream.

When this ME is associated with a UNI-side TP, it performs its upstream classification and tagging operations before offering the upstream frame to other filtering, bridging or switching functions. In the downstream direction, the defined inverse operation is the last operation performed on the frame before offering it to the UNI-side termination.

When this ME is associated with an ANI-side TP, it performs its upstream classification and tagging operations as the last step before transmission to the OLT, after having received the upstream frame from other filtering, bridging or switching functions. In the downstream direction, the defined inverse operation is the first operation performed on the frame before offering it to possible filter, bridge or switch functions.

Attributes

Managed entity ID: This attribute provides a unique number for each instance of this ME. (R, set-by-create) (mandatory) (2 bytes)

Association type: This attribute identifies the type of the ME associated with this extended VLAN tagging ME. Values are assigned as follows.

- 0 MAC bridge port configuration data
- 1 IEEE 802.1p mapper service profile
- 2 Physical path termination point Ethernet UNI
- 3 IP host config data or IPv6 host config data
- 4 Physical path termination point xDSL UNI
- 5 GEM IW termination point
- 6 Multicast GEM IW termination point
- 7 Physical path termination point MoCA UNI

- 8 Reserved
- 9 Ethernet flow termination point
- 10 Virtual Ethernet interface point
- 11 MPLS pseudowire termination point
- 12 EFM bonding group

(R, W, set-by-create) (mandatory) (1 byte)

NOTE 1 – If a MAC bridge is configured, code points 1, 5, 6 and 11 are associated with the ANI side of the MAC bridge. Code point 0 is associated with the ANI or UNI side, depending on the location of the MAC bridge port. The other code points are associated with the UNI side.

When the extended VLAN tagging ME is associated with the ANI side, it behaves as an upstream egress rule, and as a downstream ingress rule when the downstream mode attribute is equal to 0. When the extended VLAN tagging ME is associated with the UNI side, the extended VLAN tagging ME behaves as an upstream ingress rule, and as a downstream egress rule when the downstream mode attribute is equal to 0.

Received frame VLAN tagging operation table max size: This attribute indicates the maximum number of entries that can be set in the received frame VLAN tagging operation table. (R) (mandatory) (2 bytes)

Input TPID: This attribute gives the special TPID value for operations on the input (filtering) side of the table. Typical values include 0x88A8 and 0x9100. (R, W) (mandatory) (2 bytes)

Output TPID: This attribute gives the special TPID value for operations on the output (tagging) side of the table. Typical values include 0x88A8 and 0x9100. (R, W) (mandatory) (2 bytes)

Downstream mode: Regardless of its association, the rules of the received frame VLAN tagging operation table attribute pertain to upstream traffic. The downstream mode attribute defines the tagging action to be applied to downstream frames.

The received frame VLAN tagging operation table installs defaults upstream rules. In the downstream direction, the upstream default rules with the default treatment do not apply. It should be noted that downstream frame treatment is defined by the downstream mode attribute and is not affected by the upstream default rules.

The received frame VLAN tagging operation table can result in two types of rule mappings:

- One to one mapping: A table contains one or more rules that result in unique mappings between the ingress and egress flows.
- Many to one mapping: A table contains more than one rule that results in the same ANI-side tag configuration.

For one-to-one mappings, the inverse operation to apply in the downstream direction (in the case of bidirectional flows) is the inverse operation of the upstream rule.

Many-to-one mappings are possible however, and these are treated as follows.

- If an upstream many-to-one mapping results from multiple operation rules producing the same ANI-side tag configuration, then the first matching rule in the list defines the inverse operation. The meaning of match depends on the value of the downstream mode attribute.

- If the many-to-one mapping results from "don't care" fields in the filter being replaced with provisioned fields in the ANI side tags, then the inverse is defined to set the corresponding fields on the ANI side to their lowest legal value.

If the upstream rule merely copies (i.e., no explicit value is specified in the filter field) an inbound tag value to an outbound tag value, the comparison in the downstream direction applies to all tag values. This applies separately to the VID and P-bit fields. For example, with a downstream mode of 2 and an upstream rule that translates the VID while carrying forward the P-bit value, downstream frames that match the specified WAN-side VID will match any P-bit value and will translate the VID.

- 0 The operation performed in the downstream direction is the inverse of that performed in the upstream direction. Which treatment and filter fields are used for downstream filtering and the handling of unmatched frames are left to the implementation of the ONU.
- 1 Regardless of the filter rules, no operation is performed in the downstream direction. All downstream frames are forwarded unmodified.
- 2 Filter on VID and P-bit value. On a match, perform the inverse operation on both the VID and P-bit value. If no match is found, forward the frame unmodified.
- 3 Filter on VID only. On a match, perform the inverse VID operation only; pass the P bits through. If no match is found, forward the frame unmodified.
- 4 Filter on P-bit only. On a match, perform the inverse P-bit operation only; pass the VID through. If no match is found, forward the frame unmodified.
- 5 Filter on VID and P-bit value. On a match, perform the inverse operation on both the VID and P-bit value. If no match is found, discard the frame.
- 6 Filter on VID. On a match, perform the inverse operation on the VID only; pass the P bits through. If no match is found, discard the frame.
- 7 Filter on P-bit only. On a match, perform the inverse P-bit operation only; pass the VID through. If no match is found, discard the frame.
- 8 Regardless of the filter rules, discard all downstream traffic.

Please refer to Table 9.3.13-2 for example downstream mode use cases.

All other values are reserved. (R, W) (mandatory) (1 byte)

Received frame VLAN tagging operation table: This attribute is a table that filters and tags upstream frames. Each entry represents a tagging rule, comprising a filtering part (the first eight fields) and a treatment part (the last seven fields). Each incoming upstream packet is matched against each rule in list order. The first rule that matches the packet is selected as the active rule, and the packet is then treated according to that rule.

There are three categories of rules: zero-tag, single-tag, and double-tag rules. Logically, these categories are separate, and apply to their respective incoming frame types. In other words, a single-tag rule should not apply to a double-tagged frame, even though the single-tag rule might match the outer tag of the double-tagged frame.

Single-tag rules have a filter outer priority field = 15 (indicating no external tag), zero-tag rules have both filter priority fields = 15 (indicating no tags), and

double-tag rules have both filter priority fields set to a value that differs from 15 (indicating two tags).

Each tagging rule is based on a *remove* or an *add* operation, where up to two tags can be removed or added. A modify operation is applied by the combination of *remove* and *add*.

By convention, when a single tag is added, the treatments use the inner tag data fields. This is true even for treatments where a single tag is added to a frame that already has a tag, i.e., added as a second tag. The outer tag data fields are used only when two tags are added by the same rule.

The terms *inner* and *outer* only have meaning with respect to the tags that are being filtered or added.

The first 8 bytes of each entry are guaranteed to be unique, and are used to identify table entries (*list order*, above, refers to a sort on the first 8 bytes). The OLT deletes a table entry by setting all of its last 8 bytes to 0xFF.

When the table is created, the ONU should autonomously predefine three entries that list the default treatment (normal forwarding without filtering or modification) for untagged, single tagged, and double tagged frames. As an exception to the rule on ordered processing, these default rules are always considered as a last resort for frames that do not match any other rule. Best practice dictates that these entries not be deleted by the OLT; however, they can be modified to produce the desired default behaviour.

It should be noted that downstream frame treatment is defined by the downstream mode attribute and is not affected by the upstream default rules.

15, 4096, x, 15, 4096, x, 0, (0, 15, x, x, 15, x, x) – no tags

15, 4096, x, 14, 4096, x, 0, (0, 15, x, x, 15, x, x) – 1 tag

14, 4096, x, 14, 4096, x, 0, (0, 15, x, x, 15, x, x) – 2 tags

NOTE 2 – x is a "don't care" field and should be set to zero.

See Figure 9.3.13-1.

(R, W) (mandatory) (16N bytes, where N is the number of VLAN tagging rules)

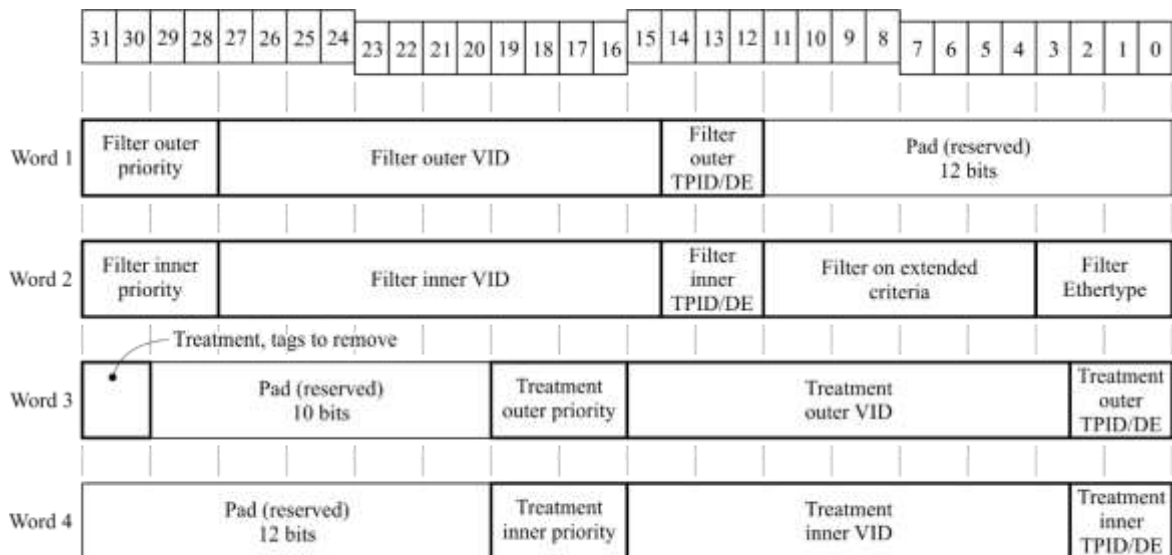

G.988(17)-Amd.2(19)_F9.3.13-1

Figure 9.3.13-1 – Received frame VLAN tagging operation layout

Filter outer priority: (4 bits) Defines the outer VLAN priority filtering operation. The following values are supported:

- 0..7 Filter received frames on this outer priority (P bit) value.
- 8 Do not filter on outer priority.
- 14 This is the default filter when no other two-tag rule applies.
- 15 This entry is not a double-tag rule; ignore all other outer tag filter fields.

Other values: reserved.

Filter outer VID: (13 bits) Defines the outer VLAN VID filtering operation. The following values are supported:

- 0..4094 Filter received frames on this outer VID value.
- 4096 Do not filter on the outer VID.

Other values: reserved.

Filter outer TPID/DEI: (3 bits) Defines the outer VLAN TPID/DEI filtering operation. The following values are supported:

- 000 Do not filter on outer TPID field.
- 100 Outer TPID = 0x8100. Filter on frames with the outer TPID set to 0x8100.
- 101 Outer TPID = input TPID attribute value, don't care about DEI bit. Filter on frames with the outer TPID set to match the Extended VLAN tagging operation configuration data Input TPID attribute value and ignore the DEI bit.
- 110 Outer TPID = input TPID, DEI = 0. Filter on frames with the outer TPID set to match the Extended VLAN tagging operation configuration data Input TPID attribute value and DEI set to the value 0.
- 111 Outer TPID = input TPID, DEI = 1. Filter on frames with the outer TPID set to match the Extended VLAN tagging operation configuration data Input TPID attribute value and DEI set to the value 1

Padding: (12 bits)

Filter inner priority: (4 bits) Defines the inner VLAN priority filtering operation. The following values are supported:

- 0..7 Filter received frames on this inner priority value.
- 8 Do not filter on inner priority.
- 14 This is the default filter when no other one-tag rule applies.
- 15 This entry is a no-tag rule; ignore all other VLAN tag filter fields.

Other values: reserved.

Filter inner VID: (13 bits) Defines the inner VLAN VID filtering operation. The following values are supported:

- 0..4094 Filter received frames on this inner VID value.
- 4096 Do not filter on the inner VID.

Other values: reserved.

Filter inner TPID/DEI: (3 bits) Defines the inner VLAN TPID/DEI filtering operation. The following values are supported:

- 000 Do not filter on inner TPID field.
- 100 Inner TPID = 0x8100. Filter on frames with the inner TPID set to 0x8100.
- 101 Inner TPID = input TPID attribute value, don't care about DEI bit. Filter on frames with the inner TPID set to match the Extended VLAN tagging operation configuration data Input TPID attribute value and ignore the DEI bit.
- 110 Inner TPID = input TPID, DEI = 0. Filter on frames with the inner TPID set to match the Extended VLAN tagging operation configuration data Input TPID attribute value and DEI set to the value 0.
- 111 Inner TPID = input TPID, DEI = 1. Filter on frames with the inner TPID set to match the Extended VLAN tagging operation configuration data Input TPID attribute value and DEI set to the value 1.

Padding: (8 bits)

Filter Ethertype: (4 bits) the Ethertype value on which to filter received frames, as follows.

NOTE 3 – This filter is recommended for use on untagged frames or frames with priority tags only.

- 0 Do not filter on Ethertype.
- 1 Ethertype = 0x0800 (filter IPoE frames)
- 2 Ethertype = 0x8863 or 0x8864 (filter PPPoE frames)
- 3 Ethertype = 0x0806 (filter ARP frames)
- 4 Ethertype = 0x86DD (filter IPv6 IpoE frames)
- 5 Ethertype = 0x888E (filter EAPOL frames)

Other values: reserved.

Filter on extended criteria: (8 bits) filter on key upper level protocols:

- 0 Do not filter on extended criteria
- 1 DHCPv4 – frames matching the well-known DHCPv4 UDP ports (67, 68) will be filtered by this criteria code point.
- 2 DHCPv6 – frames matching the well-known DHCPv6 UDP ports (546, 547) will be filtered by this criteria code point.

NOTE 4 – This filter is recommended for use on untagged frames or priority framed tags only.

Treatment tags to remove: (2 bits) Defines the tag treatment. The following values are supported:

- 0..2 Remove 0, 1 or 2 tags, respectively. If one tag is specified, then the outer tag is stripped from double-tagged frames.
- 3 Discard the frame. No symmetric downstream operation exists; i.e., this rule is ignored in the downstream direction.

Padding: (10 bits)

Treatment outer priority: (4 bits): Defines the outer VLAN priority treatment. The following values are supported:

- 0..7 Add an outer tag, and insert this value as the priority in the outer VLAN tag.
 - 8 Add an outer tag, and copy the outer priority from the inner priority of the received frame.
 - 9 Add an outer tag, and copy the outer priority from the outer priority of the received frame.
 - 10 Add an outer tag, and derive P bits from the DSCP field of the incoming frame according to the Extended VLAN tagging operation configuration data ME DSCP to P-bit mapping attribute.
 - 15 Do not add an outer tag.
- Other values: reserved.

Treatment outer VID: (13 bits). Defines the outer VID treatment. The following values are supported:

- 0..4094 Use this value as the VID in the outer VLAN tag.
 - 4096 Copy the outer VID from the inner VID of the received frame.
 - 4097 Copy the outer VID from the outer VID of the received frame.
- Other values: reserved.

Treatment outer TPID/DEI: (3 bits). Defines the outer VLAN TPID/DEI treatment. The following values are supported:

- 000 Copy TPID (and DEI, if present) from the inner tag of the received frame.
- 001 Copy TPID (and DEI, if present) from the outer tag of the received frame.
- 010 Set TPID = output TPID attribute value of the Extended VLAN tagging operation configuration data ME and copy DEI bit from the inner tag of the received frame
- 011 Set TPID = output TPID attribute value of the Extended VLAN tagging operation configuration data ME and copy DEI from the outer tag of the received frame
- 100 Set TPID = 0x8100
- 101 Reserved
- 110 Set TPID = output TPID attribute value of the Extended VLAN tagging operation configuration data ME and set DEI = 0
- 111 Set TPID = output TPID attribute value of the Extended VLAN tagging operation configuration data ME and set DEI = 1

Padding: (12 bits)

Treatment inner priority: (4 bits). Defines the inner VLAN priority treatment. The following values are supported:

- 0..7 Add an inner tag, and insert this value as the priority to insert in the inner VLAN tag.
- 8 Add an inner tag, and copy the inner priority from the inner priority of the received frame.
- 9 Add an inner tag, and copy the inner priority from the outer priority of the received frame.
- 10 Add an inner tag, and derive P bits from the DSCP field of the incoming frame according to the Extended VLAN tagging operation configuration data ME DSCP to P-bit mapping attribute.
- 15 Do not add an inner tag.

Other values: reserved.

Treatment inner VID: (13 bits): Defines the inner VLAN VID treatment. The following values are supported:

- 0..4094 Use this value as the VID in the inner VLAN tag.
- 4096 Copy the inner VID from the inner VID of the received frame.
- 4097 Copy the inner VID from the outer VID of the received frame.

Other values: reserved.

Treatment inner TPID/DEI: (3 bits). Defines the inner VLAN TPID/DEI treatment. The following values are supported:

- 000 Copy TPID (and DEI, if present) from the inner tag of the received frame.
- 001 Copy TPID (and DEI, if present) from the outer tag of the received frame.
- 010 Set TPID = output TPID attribute value of the Extended VLAN tagging operation configuration data ME and copy the DEI bit from the inner tag of the received frame.
- 011 Set TPID = output TPID attribute value of the Extended VLAN tagging operation configuration data ME and, copy the DEI from the outer tag of the received frame.
- 100 Set TPID = 0x8100
- 101 Reserved
- 110 Set TPID = output TPID attribute value of the Extended VLAN tagging operation configuration data ME and set DEI = 0
- 111 Set TPID = output TPID attribute value of the Extended VLAN tagging operation configuration data ME and set DEI = 1

Associated ME pointer: This attribute points to the ME with which this extended VLAN tagging operation configuration data ME is associated. (R, W, set-by-create) (mandatory) (2 bytes)

NOTE 5 – When the association type is xDSL, the two MSBs may be used to indicate a bearer channel.

DSCP to P-bit mapping: This attribute specifies mapping from DSCP to P bits. The attribute can be considered a bit string sequence of 64 3 bit groups. The 64 sequence entries represent the possible values of the 6 bit DSCP field. Each 3 bit group specifies the P-bit value to which the associated DSCP value should be mapped. (R, W) (optional) (24 bytes)

NOTE 6 – If certain bits in the DSCP field are to be ignored in the mapping process, the attribute should be provisioned such that all possible values of those bits produce the same P-bit mapping. This can be applied to the case where instead of full DSCP, the operator wishes to adopt the priority mechanism based on IP precedence, which needs only the three MSBs of the DSCP field.

Enhanced mode: The Boolean value true specifies that the Enhanced received frame classification and processing table is used, and the Received frame VLAN tagging operation table is ignored. The value false indicates the Enhanced received frame classification and processing table is not used. It is strongly recommended that the OLT uses the same value for all Extended VLAN tagging operation configuration data instances created on an ONU. (R, Set-by-create) (optional) (1 byte)

Enhanced received frame classification and processing table: This attribute is a table that provides enhanced capability for frame classification and processing. It

extends the Received frame VLAN tagging operation table attribute with a set control field, a row key and direction. Each incoming packet is matched against each rule in row key order (smaller value row key has higher precedence) and direction. The first rule that matches the packet is selected as the active rule, and the packet is then treated according to that rule.

When the table is empty, the ONU discards all received frames. The OLT may choose to create three entries that list the default treatment (normal forwarding without filtering or modification) for untagged, single tagged, and double tagged frames, with the direction field set to 0.

NOTE 7 – Where no change is noted, the definitions in the Received frame VLAN tagging operation table attribute remain applicable.

(R, W) (optional) (28N bytes, where N is the number of entries in the table).

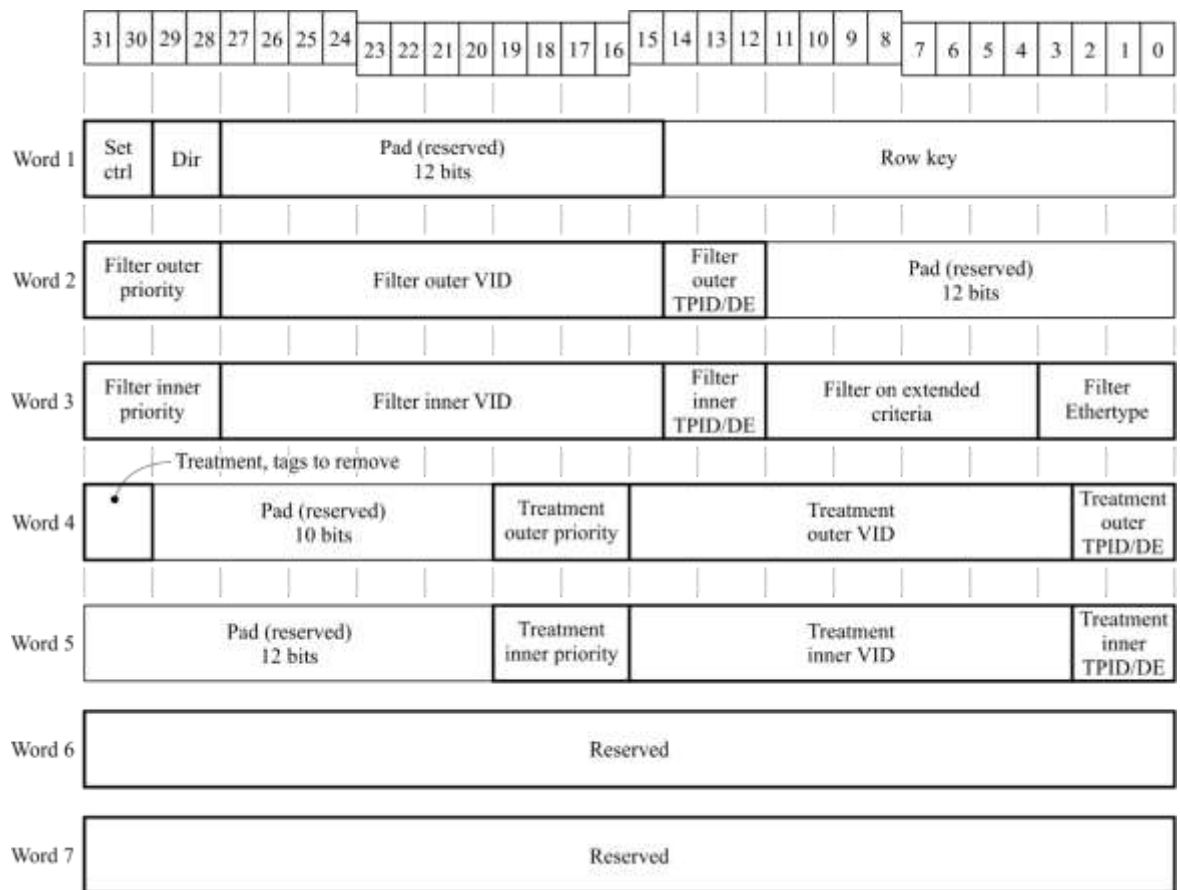

G.988(17)-Amd.3(20)_F9.3.13-2

Figure 9.3.13-2 – Enhanced received frame classification and processing layout

Set ctrl: (2 bits)

This field determines the meaning of a set operation. These bits are returned as 00 during get next operations.

- 1 Write this entry into the table. Overwrite any existing entry with the same row key.
- 2 Delete this entry from the table. The remaining fields are not meaningful.

NOTE 8 – Unlike the delete operation in the Received frame VLAN tagging operation table, the OLT does not need to set all eight bytes in Word 4 and Word 5 to 0xFF.

- 3 Clear all entries from the table. The remaining fields are not meaningful.

Other values: reserved.

Dir: (2 bits)

This field determines the direction of the classification and processing rule.

- 0 This is an upstream rule. In the downstream direction, the inverse classification and operation is defined based on the downstream mode code point. All downstream mode codepoints are considered valid to be used when dir=0 is used (including downstream mode 8).
- 1 This is an upstream-only rule. This rule is ignored in the downstream direction.
- 2 This is a downstream-only rule. This rule is ignored in the upstream direction.

Other values: reserved.

Row key: (16 bits)

The row key distinguishes rows in the table. It is the responsibility of the OLT to assign and track row keys and content, and to ensure the classification rules are not duplicated and in the correct ordering.

For Filter outer priority, Filter outer VID, Filter outer TPID/DEI, Filter inner priority, Filter inner VID, Filter inner TPID/DEI, Filter on Extended Criteria, Filter Ethertype, Treatment outer priority, Treatment outer VID, Treatment outer TPID/DEI, Treatment inner priority, Treatment inner VID, and Treatment inner TPID/DEI values please refer to Received frame VLAN tagging operation table in this ME.

Actions

Create, delete, get, get next, set

Set table (optional)

Notifications

None.

Table 9.3.13-1 illustrates the rule structure for many of the common VLAN tagging operations. For brevity, Table 9.3.13-1 omits columns for TPID/DEI, where the operator customizes the behaviour to a specific service model.

The following abbreviations are used in the "action type" column:

F Refers to an Ethernet Frame II frame

→ Refers to the expected action in the upstream direction. For example F → X-F is an example where an 802.1q header is added with VID value of X.

P<x|y> Refers to the P-bit associated with VID Tag X or Y.

X, Y Refer to VID Tag X or Y

S Refers to S-tag or outermost tag as defined in IEEE 802.1ad and having a typical Ethertype value of 0x88a8.

C Refer to a C-tag or innermost VLAN tag as defined in IEEE 802.1ad and having a typical Ethertype value of 0x8100. Typically, a service VLAN (S-VLAN) delivers a single service to all subscribers, while a customer VLAN (C-VLAN) delivers multiple services to a single subscriber.

These are often combined by using a single S-VLAN to carry specific service traffic to all subscribers, by using dedicated C-VLANs to carry all service traffic to each subscriber.

Table 9.3.13-1 – Common VLAN tagging operations

Action type	Filter					Treatment				
	Outer		Inner			Tags to remove	Outer		Inner	
	Priority	VID	Priority	VID	Ethertype		Priority	VID	Priority	VID
Upstream frame type = Untagged frames										
Insert 1 tag (X): F → X-F	15	4096	15	4096	0	0	15	N/A	Px	X
Default case, do nothing	15	4096	15	4096	0	0	15	N/A	15	N/A
Insert 2 tags (X,Y): F → Y-X-F	15	4096	15	4096	0	0	Py	Y	Px	X
Upstream frame type = Single tagged frames										
Insert 1 tag (X): C-F → X-C-F	15	4096	8	C	0	0	15	N/A	Px	X
Insert 1 tag (X), copy priority: C-F → X-C-F	15	4096	8	C	0	0	15	N/A	8	X
Insert 2 tags (X,Y): C-F → Y-X-C-F	15	4096	8	C	0	0	Py	Y	Px	X
Modify tag: C-F → X-F	15	4096	8	C	0	1	15	N/A	Px	X
Modify tag, keep original priority: C-F → X-F	15	4096	8	C	0	1	15	N/A	8	X
Modify and insert tag: C-F → Y-X-F	15	4096	8	C	0	1	Py	Y	Px	X
Remove tag: C-F → F	15	4096	8	C	0	1	15	N/A	15	N/A
Insert two tags: C-F → Y-X-C-F	15	4096	8	C	0	0	Py	Y	Px	X
Default case, do nothing	15	4096	14	4096	0	0	15	N/A	15	N/A
Upstream frame type = Double tagged frames										
Insert 1 tag (X): S-C-F → X-S-C-F	8	S	8	C	0	0	15	N/A	Px	X
Insert 1 tag (X), copy external priority: S-C-F → X-S-C-F	8	S	8	C	0	0	15	N/A	9	X

Table 9.3.13-1 – Common VLAN tagging operations

Action type	Filter					Treatment				
	Outer		Inner			Tags to remove	Outer		Inner	
	Priority	VID	Priority	VID	Ethertype		Priority	VID	Priority	VID
Insert 2 tags (X,Y): S-C-F → Y-X-S-C-F	8	S	8	C	0	0	Py	Y	Px	X
Insert 2 tags (X,Y), copy external and internal priority: S-C-F → Y-X-S-C-F	8	S	8	C	0	0	9	Y	8	X
Modify outer tag: S-C-F → X-C-F	8	S	8	C	0	1	15	N/A	Px	X
Modify outer tag, keep original priority: S-C-F → X-C-F	8	S	8	C	0	1	15	N/A	9	X
Modify both tags: S-C-F → Y-X-F	8	S	8	C	0	2	Py	Y	Px	X
Modify both tags, keep original priorities: S-C-F → Y-X-F	8	S	8	C	0	2	9	Y	8	X
Swap both tags: S-C-F → C-S-F	8	S	8	C	0	2	8	4096	9	4097
Remove outer tag: S-C-F → C-F	8	S	8	C	0	1	15	N/A	15	N/A
Remove both tags: S-C-F → F	8	S	8	C	0	2	15	N/A	15	N/A
Default case, do nothing S-C-F → S-C-F	14	4096	14	4096	0	0	15	N/A	15	N/A

Table 9.3.13-2 illustrates the downstream behaviour for common deployment scenarios based on the downstream mode code point and the upstream rule. For brevity, Table 9.3.13-2 omits a column for P-bit only, but the downstream action can be inferred from the VID only column.

If the inner packet tag information is not available (i.e., in cases with more than one VID or VID+PBIT value in "VID-only" and "Both P and VID," such as "X and C" and "Px and Py and X and Y"), only outer tag information is used in the downstream filtering rule.

Table 9.3.13-2 uses the same abbreviations used in Table 9.3.13-1.

Table 9.3.13-2 – Downstream mode use case examples

Upstream action type	Filter					Treatment					Downstream action				Notes
	Outer		Inner			Tags to remove	Outer		Inner		Consider only downstream frame type	VID only	Both P and VID	Action	
	Priority	VID	Priority	VID	Ethertype		Priority	VID	Priority	VID					
Upstream frame type= Untagged frames															
Insert 1tag (X): F → X-F	15	4096	15	4096	0	0	15	N/A	Px	X	Single tagged	X	Px and X	Strip tag	
Default case, do nothing	15	4096	15	4096	0	0	15	N/A	15	N/A	Untagged	–	–	Pass unmodified	
Insert 2 tags (X,Y): F → Y-X-F	15	4096	15	4096	0	0	Py	Y	Px	X	Double tagged	X and Y	Px and Py and X and Y	Strip two tags	
Upstream frame type = Single tagged frames															
Insert 1 l tag (X): C-F → X-C-F	15	4096	8	C	0	0	15	N/A	Px	X	Double tagged	X and C	X and Px and C	Strip outer tag (X)	
Insert 1 tag (X), copy priority: C-F → X-C-F	15	4096	8	C	0	0	15	N/A	8	X	Double tagged	X and C	X and C	Strip outer tag (X), copy priority onto remaining tag (C)	
Insert 2 tags (X,Y): C-F → Y-X-C-F	15	4096	8	C	0	0	Py	Y	Px	X	Triple tagged	X and Y and C	Px and Py and X and Y and C	Strip two outer tags (X, Y)	

Table 9.3.13-2 – Downstream mode use case examples

Upstream action type	Filter					Treatment					Downstream action				Notes
	Outer		Inner			Tags to remove	Outer		Inner		Consider only downstream frame type	VID only	Both P and VID	Action	
	Priority	VID	Priority	VID	Ethertype		Priority	VID	Priority	VID					
Modify tag: C-F → X-F	15	4096	8	C	0	1	15	N/A	Px	X	Single tagged	X	Px and X	Replace X with C, retain Px	Use treatment specified in downstream mode definition for the remaining P-bit set {for C VID} if ambiguous
Modify tag, keep original priority: C-F → X-F	15	4096	8	C	0	1	15	N/A	8	X	Single tagged	X	Px and X	Replace X with C, retain Px	Use treatment specified in downstream mode definition for the remaining P-bit set {for C VID} if ambiguous
Modify and insert tag: C-F → Y-X-F	15	4096	8	C	0	1	Py	Y	Px	X	Double tagged	X and Y	X and Px, Y and Py	Strip outer tag (Y)	
Remove tag: C-F → F	15	4096	8	C	0	1	15	N/A	15	N/A	Untagged	-	-	Add tag, VID = C, P = 0	
Insert two tags: C-F → Y-X-C-F	15	4096	8	C	0	0	Py	Y	Px	X	Triple tagged	X and Y and C	Px and Py and X and Y and C	Strip two outer tags (Y, X)	
Default case, do nothing	15	4096	14	4096	0	0	15	N/A	15	N/A	Single tagged	-	-	Pass unmodified	
Upstream frame type = Double tagged frames															
Insert 1 tag (X): S-C-F → X-S-C-F	8	S	8	C	0	0	15	N/A	Px	X	Triple tagged	X and S and C	X and Px and S and C	Strip outer tag (X)	

Table 9.3.13-2 – Downstream mode use case examples

Upstream action type	Filter					Treatment					Downstream action				Notes
	Outer		Inner			Tags to remove	Outer		Inner		Consider only downstream frame type	VID only	Both P and VID	Action	
	Priority	VID	Priority	VID	Ethertype		Priority	VID	Priority	VID					
Insert 1 tag (X), copy outer priority: S-C-F → X-S-C-F	8	S	8	C	0	0	15	N/A	9	X	Triple tagged	X and S and C	X and S and C	Strip outer tag(X) copy priority (Px) onto resulting outer tag (S)	
Insert 2 tags (X,Y): S-C-F → Y-X-S-C-F	8	S	8	C	0	0	Py	Y	Px	X	Quad tagged	X and Y and S and C	Px and Py and X and Y and S and C	Strip two outer tags (Y, X)	
Insert 2 tags (X,Y), copy external and internal priority: S-C-F → Y-X-S-C-F	8	S	8	C	0	0	9	Y	8	X	Quad tagged	X and Y and S and C	X and Y and S and C	Strip two outer tags (Y, X), copy Px, Py onto remaining tags (S,C)	
Modify external tag: S-C-F → X-C-F	8	S	8	C	0	1	15	N/A	Px	X	≥ 2 tags	X and C	Px and X and C	Replace X with S in outer tag	
Modify external tag, keep original priority: S-C-F → X-C-F	8	S	8	C	0	1	15	N/A	9	X	≥ 2 tags	X and C	X and C	Modify outer tag VID = S, retain priority	
Modify both tags: S-C-F → Y-X-F	8	S	8	C	0	2	Py	Y	Px	X	≥ 2 tags	X and Y	Px and Py and X and Y	Modify tags with S, C, retain priority	Use treatment specified in downstream mode definition for the remaining P-bit sets {S} {C} if ambiguous

Table 9.3.13-2 – Downstream mode use case examples

Upstream action type	Filter					Treatment					Downstream action				Notes
	Outer		Inner			Tags to remove	Outer		Inner		Consider only downstream frame type	VID only	Both P and VID	Action	
	Priority	VID	Priority	VID	Ethertype		Priority	VID	Priority	VID					
Modify both tags, keep original priorities: S-C-F → Y-X-F	8	S	8	C	0	2	9	Y	8	X	≥ 2 tags	X and Y	X and Y	Modify tags with S, C, retain priority	Use treatment specified in downstream mode definition for the remaining P-bit sets {S} {C} if ambiguous
Swap both tags: S-C-F → C-S-F	8	S	8	C	0	2	8	4096	9	4097	≥ 2 tags	S and C	S and C	Swap tags (C, S)	
Remove outer tag: S-C-F → C-F	8	S	8	C	0	1	15	N/A	15	N/A	Single tagged	C	C	Add Tag S, p-bit=0	
Remove both tags: S-C-F → F	8	S	8	C	0	2	15	N/A	15	N/A	untagged	–	–	Add Tags S, C, p-bit=0	
Default case, do nothing S-C-F → S-C-F	14	4096	14	4096	0	0	15	N/A	15	N/A	≥ 2 tags	–	–	Pass unmodified	

9.3.14 Dot1X port extension package

An instance of this ME represents a set of attributes that control a port's IEEE 802.1X operation. It is created and deleted autonomously by the ONU upon the creation or deletion of a PPTP that supports [IEEE 802.1X] authentication of customer premises equipment (CPE).

Relationships

An instance of this ME is associated with a PPTP that performs IEEE 802.1X authentication of CPE (e.g., Ethernet or DSL).

Attributes

Managed entity ID: This attribute provides a unique number for each instance of this ME. Its value is the same as that of its associated PPTP (i.e., slot and port number). (R) (mandatory) (2 bytes)

Dot1x enable: If true, this Boolean attribute forces the associated port to authenticate via [IEEE 802.1X] as a precondition of normal service. The default value false does not impose IEEE 802.1X authentication on the associated port. (R, W) (mandatory) (1 byte)

Action register: This attribute defines a set of actions that can be performed on the associated port. The act of writing to the register causes the specified action.

- 1 Force re-authentication – this opcode initiates an IEEE 802.1X re-authentication conversation with the associated port. The port remains in its current authorization state until the conversation concludes.
- 2 Force unauthenticated – this opcode initiates an IEEE 802.1X authentication conversation whose outcome is predestined to fail, thereby disabling normal Ethernet service on the port. The port's provisioning is not changed, such that upon re-initialization, a new IEEE 802.1X conversation may restore service without prejudice.
- 3 Force authenticated – this opcode initiates an IEEE 802.1X authentication conversation whose outcome is predestined to succeed, thereby unconditionally enabling normal Ethernet service on the port. The port's provisioning is not changed, such that upon re-initialization, a new IEEE 802.1X conversation is required.

(W) (mandatory) (1 byte)

Authenticator PAE state: This attribute returns the value of the port's PAE state. States are further described in [IEEE 802.1X]. Values are coded as follows.

- 0 Initialize
- 1 Disconnected
- 2 Connecting
- 3 Authenticating
- 4 Authenticated
- 5 Aborting
- 6 Held
- 7 Force auth
- 8 Force unauth
- 9 Restart

(R) (optional) (1 byte)

Backend authentication state: This attribute returns the value of the port's back-end authentication state. States are further described in [IEEE 802.1X]. Values are coded as follows.

- 0 Request
- 1 Response
- 2 Success
- 3 Fail
- 4 Timeout
- 5 Idle
- 6 Initialize
- 7 Ignore

(R) (optional) (1 byte)

Admin controlled directions: This attribute controls the directionality of the port's authentication requirement. The default value 0 indicates that control is imposed in both directions. The value 1 indicates that control is imposed only on traffic from the subscriber towards the network. (R, W) (optional) (1 byte)

Operational controlled directions: This attribute indicates the directionality of the port's current authentication state. The value 0 indicates that control is imposed in both directions. The value 1 indicates that control is imposed only on traffic from the subscriber towards the network. (R) (optional) (1 byte)

Authenticator controlled port status: This attribute indicates whether the controlled port is currently authorized (1) or unauthorized (2). (R) (optional) (1 byte)

Quiet period: This attribute specifies the interval between EAP request/identity invitations sent to the peer. Other events such as carrier present or EAPOL start frames from the peer may trigger an EAP request/identity frame from the ONU at any time; this attribute controls the ONU's periodic behaviour in the absence of these other inputs. It is expressed in seconds. (R, W) (optional) (2 bytes)

Server timeout period: This attribute specifies the time the ONU will wait for a response from the radius server before timing out. Within this maximum interval, the ONU may initiate several retransmissions with exponentially increasing delay. Upon timeout, the ONU may try another radius server if there is one, or invoke the fallback policy, if no alternate radius servers are available. Server timeout is expressed in seconds, with a default value of 30 and a maximum value of 65535. (R, W) (optional) (2 bytes)

Re-authentication period: This attribute records the re-authentication interval specified by the radius authentication server. It is expressed in seconds. The attribute is only meaningful after a port has been authenticated. (R) (optional) (2 bytes)

Re-authentication enabled: This Boolean attribute records whether the radius authentication server has enabled re-authentication on this service (true) or not (false). The attribute is only meaningful after a port has been authenticated. (R) (optional) (1 byte)

Key transmission enabled: This Boolean attribute indicates whether key transmission is enabled (true) or not (false). This feature is not required; the parameter is listed here for completeness vis-à-vis [IEEE 802.1X]. (R, W) (optional) (1 byte)

Actions

Get, set

Notifications

Alarm

Alarm number	Alarm	Description
0	dot1x local authentication – allowed	No radius authentication server was accessible. In accordance with local policy, the port was allowed access without authentication.
1	dot1x local authentication – denied	No radius authentication server was accessible. In accordance with local policy, the port was denied access.
2..207	Reserved	
208..223	Vendor-specific alarms	Not to be standardized

9.3.15 Dot1X configuration profile

An instance of this ME represents a set of attributes that control an ONU's 802.1X operation with regard to IEEE 802 services. An instance of this ME is created by the ONU if it is capable of supporting [IEEE 802.1X] authentication of CPE.

Relationships

One instance of this ME governs the ONU's 802.1X CPE authentication behaviour.

Attributes

Managed entity ID: This attribute provides a unique number for each instance of this ME. There is at most one instance, number 0. (R) (mandatory) (2 bytes)

Circuit ID prefix: This attribute is a pointer to a large string ME whose content appears as the prefix of the NAS port ID in radius access-request messages. The remainder of the NAS port ID field is local information (for example, slot-port, appended by the ONU itself). The default value of this attribute is the null pointer 0. (R, W) (mandatory) (2 bytes)

Fallback policy: When set to 1 (deny), this attribute causes IEEE 802.1X conversations to fail when no external authentication server is accessible, such that no Ethernet service is provided. The default value 0 causes IEEE 802.1X conversations to succeed when no external authentication server is accessible. (R, W) (mandatory) (1 byte)

Auth server 1: This attribute is a pointer to a large string ME that contains the URI of the first choice radius authentication server. The value 0 indicates that no radius authentication server is specified. (R, W) (mandatory) (2 bytes)

Shared secret auth1: This attribute is the shared secret for the first radius authentication server. It is a null-terminated character string. (R, W) (mandatory) (25 bytes)

The following two pairs of attributes are defined in the same way:

Auth server 2: (R, W) (optional) (2 bytes)

Shared secret auth2: (R, W) (optional) (25 bytes)

Auth server 3: (R, W) (optional) (2 bytes)

Shared secret auth3: (R, W) (optional) (25 bytes)

OLT proxy address: This attribute indicates the IP address of a possible proxy at the OLT for IEEE 802.1X radius messages. The default value 0.0.0.0 indicates that no proxy is required. (R, W) (optional) (4 bytes)

Calling station ID format: Radius messages initiated by the ONU contain a calling-station-ID field that is specified to be the supplicant's MAC address in upper-case ASCII form, with bytes separated by a delimiter. This attribute permits specification of the delimiter. (R, W) (optional) (2 bytes)

Value	Meaning
0	ONU's internal default
1	Hyphen (-) delimiter
2	Colon (:) delimiter
3	No delimiter
0x20 – 0x7E	Use this value as the delimiter
0xF0 – 0xFE	Vendor-specific use
Other values are reserved.	

Actions

Get, set

Notifications

None.

9.3.16 Dot1X performance monitoring history data

This ME collects performance statistics on an ONU's IEEE 802.1X CPE authentication operation. Instances of this ME are created and deleted by the OLT.

For a complete discussion of generic PM architecture, refer to clause I.4.

Relationships

An instance of this ME may be associated with each UNI that can perform IEEE 802.1X authentication of CPE.

Attributes

Managed entity ID: This attribute uniquely identifies each instance of this ME. Through an identical ID, this ME is implicitly linked to an instance of a PPTP. (R, set-by-create) (mandatory) (2 bytes)

Interval end time: This attribute identifies the most recently finished 15 min interval. (R) (mandatory) (1 byte)

Threshold data 1/2 ID: This attribute points to an instance of the threshold data 1 and 2 MEs that contains PM threshold values. (R, W, set-by-create) (mandatory) (2 bytes)

EAPOL frames received: This attribute counts received valid EAPOL frames of any type. (R) (mandatory) (4 bytes)

EAPOL frames transmitted: This attribute counts transmitted EAPOL frames of any type. (R) (mandatory) (4 bytes)

EAPOL start frames received: This attribute counts received EAPOL start frames. (R) (mandatory) (4 bytes)

EAPOL logoff frames received: This attribute counts received EAPOL logoff frames. (R) (mandatory) (4 bytes)

- Invalid EAPOL frames received:** This attribute counts received EAPOL frames in which the frame type was not recognized. (R) (mandatory) (4 bytes)
- EAP resp/id frames received:** This attribute counts received EAP response frames containing an identifier type field. (R) (mandatory) (4 bytes)
- EAP response frames received:** This attribute counts received EAP response frames, other than resp/id frames. (R) (mandatory) (4 bytes)
- EAP initial request frames transmitted:** This attribute counts transmitted request frames containing an identifier type field. In [IEEE 802.1X], this is also called ReqId. (R) (mandatory) (4 bytes)
- EAP request frames transmitted:** This attribute counts transmitted request frames, other than request/id frames. (R) (mandatory) (4 bytes)
- EAP length error frames received:** This attribute counts received EAPOL frames whose packet body length field was invalid. (R) (mandatory) (4 bytes)
- EAP success frames generated autonomously:** This attribute counts EAPOL success frames generated according to the local fallback policy because no radius server was available. (R) (mandatory) (4 bytes)
- EAP failure frames generated autonomously:** This attribute counts EAPOL failure frames generated according to the local fallback policy because no radius server was available. (R) (mandatory) (4 bytes)

Actions

Create, delete, get, set

Get current data (optional)

Notifications

Threshold crossing alert

Alarm number	Threshold crossing alert	Threshold value attribute No. (Note)
4	Invalid EAPOL frames received	5
9	EAP length error frames received	10
NOTE – This number associates the TCA with the specified threshold value attribute of the threshold data 1/2 managed entities.		

9.3.17 Radius performance monitoring history data

This ME collects performance statistics on an ONU's radius client, particularly as related to its IEEE 802.1X operation.

Instances of this ME are created and deleted by the OLT.

For a complete discussion of generic PM architecture, refer to clause I.4.

Relationships

An instance of this ME is associated with an ONU.

Attributes

Managed entity ID: This attribute uniquely identifies each instance of this ME. Through an identical ID (namely 0), this ME is implicitly linked to an instance of a dot1X configuration profile. (R, set-by-create) (mandatory) (2 bytes)

- Interval end time:** This attribute identifies the most recently finished 15 min interval. (R) (mandatory) (1 byte)
- Threshold data 1/2 ID:** This attribute points to an instance of the threshold data 1 ME that contains PM threshold values. Since no threshold value attribute number exceeds 7, a threshold data 2 ME is optional. (R, W, set-by-create) (mandatory) (2 bytes)
- Access-request packets transmitted:** This attribute counts transmitted radius access-request messages, including retransmissions. (R) (mandatory) (4 bytes)
- Access-request retransmission count:** This attribute counts radius access-request retransmissions. (R) (mandatory) (4 bytes)
- Access-challenge packets received:** This attribute counts received radius access-challenge messages. (R) (mandatory) (4 bytes)
- Access-accept packets received:** This attribute counts received radius access-accept messages. (R) (mandatory) (4 bytes)
- Access-reject packets received:** This attribute counts received radius access-reject messages. (R) (mandatory) (4 bytes)
- Invalid radius packets received:** This attribute counts received invalid radius messages. (R) (mandatory) (4 bytes)

Actions

- Create, delete, get, set
- Get current data (optional)

Notifications

Threshold crossing alert

Alarm number	Threshold crossing alert	Threshold value attribute No. (Note)
1	Retransmission count	2
5	Invalid radius packets received	6
NOTE – This number associates the TCA with the specified threshold value attribute of the threshold data 1 managed entity.		

9.3.18 Dot1 rate limiter

This ME allows rate limits to be defined for various types of upstream traffic that are processed by IEEE 802.1 bridges or related structures.

Relationships

An instance of this ME may be linked to an instance of a MAC bridge service profile or an IEEE 802.1p mapper.

Attributes

- Managed entity ID:** This attribute uniquely identifies each instance of this ME. (R, set-by-create) (mandatory) (2 bytes)
- Parent ME pointer:** This attribute points to an instance of a ME. The type of ME is determined by the TP type attribute. (R, W, set-by-create) (mandatory) (2 bytes)

TP type: This attribute identifies the type of TP associated with this dot1 rate limiter. Valid values are:

- 1 MAC bridge service profile
- 2 IEEE 802.1p mapper service profile

(R, W, set-by-create) (mandatory) (1 byte)

Upstream unicast flood rate pointer: This attribute points to an instance of the traffic descriptor that governs the rate of upstream unicast packets whose DA is unknown to the bridge. A null pointer specifies that no administrative limit is to be imposed. (R, W, set-by-create) (optional) (2 bytes)

Upstream broadcast rate pointer: This attribute points to an instance of the traffic descriptor that governs the rate of upstream broadcast packets. A null pointer specifies that no administrative limit is to be imposed. (R, W, set-by-create) (optional) (2 bytes)

Upstream multicast payload rate pointer: This attribute points to an instance of the traffic descriptor that governs the rate of upstream multicast payload packets. A null pointer specifies that no administrative limit is to be imposed. (R, W, set-by-create) (optional) (2 bytes)

Actions

Create, delete, get, set

Notifications

None.

9.3.19 Dot1ag maintenance domain

In [IEEE 802.1ag], a maintenance domain (MD) is a context within which configuration fault management (CFM) connectivity verification can occur. Individual services (maintenance associations, MAs) exist within an MD. An MD is created and deleted by the OLT. The MD ME is specified by [IEEE 802.1ag] in such a way that the same provisioning can be used for all associated systems in a network; the OMCI definition accordingly avoids ONU-specific information such as pointers.

Relationships

Several MDs may be associated with a given bridge, at various MD levels, and a given MD may be associated with any number of bridges.

Attributes

Managed entity ID: This attribute uniquely identifies an instance of this ME. The values 0 and 0xFFFF are reserved. (R, set-by-create) (mandatory) (2 bytes)

MD level: This attribute ranges from 0..7 and specifies the maintenance level of this MD. Higher numbers have wider geographic scope. (R, W, set-by-create) (mandatory) (1 byte)

MD name format: This attribute specifies one of several possible formats for the MD name attribute. (R, W, set-by-create) (mandatory) (1 byte)

Value	MD name format	MD name attribute	Defined in
1	None	No MD name present	[IEEE 802.1ag]

Value	MD name format	MD name attribute	Defined in
2	DNS-like name	Globally unique text string derived from a DNS name	"
3	MAC addr and UINT	MAC address, followed by a 2-octet unsigned integer, total length 8 bytes	"
4	Character string	String of printable characters. This is recommended to be the default value.	"
32	ICC-based	ITU carrier code followed by locally assigned UMC code, 13 bytes with trailing nulls as needed	Annex A of [ITU-T Y.1731]
Others	Reserved		

MD name 1, MD name 2: These two attributes may be regarded as a 50 byte octet string whose value is the left-justified maintenance domain name. The MD name may or may not be a printable character string, so an octet string is the appropriate representation. If the MD name format specifies a DNS-like name or a character string, the string is null-terminated; otherwise, its length is determined by the MD name format. If the MD has no name (MD name format = 0), this attribute is undefined. Note that binary comparisons of the MD name are made in other CFM state machines, so blanks, alphabetic case, etc., are significant. Also, note that the MD name and the MA name must be packed (with additional bytes) into 48 byte CFM message headers. (R, W) (mandatory if MD name format is not 1) (25 bytes * 2 attributes)

Maintenance domain intermediate point half function (MHF) creation: This attribute determines whether an associated bridge creates an MHF for this MD, under circumstances defined in clause 22.2.3 of [IEEE 802.1ag]. This attribute is an enumeration with the following values.

- 1 None
- 2 Default (IEEE 802.1ag term). The bridge can create MHFs on an associated VID on any port through which the VID can pass, where: i) there are no lower active MD levels or ii) there is a maintenance association end point (MEP) at the next lower active MD level on the port.
- 3 Explicit. The bridge can create MHFs on an associated VID on any port through which the VID can pass, but only if an MEP exists at some lower maintenance level.

(R, W, set-by-create) (mandatory) (1 byte)

Sender ID permission: This attribute determines the contents of the sender ID type-length-value (TLV) included in CFM messages transmitted by maintenance points (MPs) controlled by this MD. Chassis ID and management address information is available from the dot1ag chassis-management info ME. The attribute is an enumeration with the following values.

- 1 None: the sender ID TLV is not to be sent.
- 2 Chassis: the chassis ID length, chassis ID subtype, and chassis ID fields of the sender ID TLV are to be sent, but not the management address fields.
- 3 Manage: the management address fields of the sender ID TLV are to be sent, but the chassis ID length is to be transmitted with the value 0, and the chassis ID subtype, and chassis ID fields are not to be sent.

- 4 ChassisManage: all chassis ID and management address fields are to be sent.

(R, W, set-by-create) (mandatory) (1 byte)

Actions

Create, delete, get, set

Notifications

None.

9.3.20 Dot1ag maintenance association

This ME models an [IEEE 802.1ag] service defined on a bridge port. An MA is a set of endpoints on opposite sides of a network, all existing at a defined maintenance level. One of the endpoints resides on the local ONU; the others are understood to be configured in a consistent way on external equipment. [ITU-T Y.1731] refers to the MA as a maintenance entity group (MEG).

An MA is created and deleted by the OLT.

Relationships

Any number of MAs may be associated with a given MD, or may stand on their own without an MD. One or more MAs may be associated with a MAC bridge or an IEEE 802.1p mapper. An MA exists at one of eight possible maintenance levels.

Attributes

Managed entity ID: This attribute uniquely identifies an instance of this ME. The values 0 and 0xFFFF are reserved. (R, set-by-create) (mandatory) (2 bytes)

MD pointer: This pointer specifies the dot1ag maintenance domain with which this MA is associated. A null pointer specifies that the MA is not associated with an MD. (R, W, set-by-create) (mandatory) (2 bytes)

Short MA name format: This attribute specifies one of several possible formats for the short MA name attribute. Value 1, the primary VLAN ID, is recommended to be the default. (R, W, set-by-create) (mandatory) (1 byte)

Value	Short MA name format	Short MA name attribute
1	Primary VID	2 octets, 12 LSBs specify primary VID, 0 if none
2	Character string	String of up to 45 printable characters
3	2-octet integer	2 octet unsigned integer
4	Virtual private network (VPN) ID	7 octets, as defined in [IETF RFC 2685]
32	ICC-based	ITU carrier code followed by locally assigned UMC code, 13 bytes with trailing nulls as needed. Defined in Annex A of [ITU-T Y.1731]
Other	Reserved	

Short MA name 1, Short MA name 2: These two attributes may be regarded as an octet string whose value is the left-justified MA name. Because the MA name may or may not be a printable character string, an octet string is the appropriate representation. If the short MA name format specifies a character string, the

string is null-terminated; otherwise, its length is determined by the short MA name format. Note that binary comparisons of the short MA name are made in other CFM state machines, so blanks, alphabetic case, etc., are significant. Also, note that the MD name and the MA short name must be packed (with additional bytes) into 48 byte CFM message headers. (R, W) (mandatory) (25 bytes * 2 attributes)

Continuity check message (CCM) interval: If CCMs are enabled on an MEP, the CCM interval attribute specifies the rate at which they are generated. The MEP also expects to receive CCMs from each of the other MEPs in its CC database at this rate.

- 0: CCM transmission disabled
- 1: 3.33 ms
- 2: 10 ms
- 3: 100 ms
- 4: 1 s
- 5: 10 s
- 6: 1 min
- 7: 10 min

Short intervals should be used judiciously, as they can interfere with the network's ability to handle subscriber traffic. The recommended value is 1 s. (R, W, set-by-create) (mandatory) (1 byte)

Associated VLANs: This attribute is a list of up to 12 VLAN IDs with which this MA is associated. Once a set of VLANs is defined, the ONU should deny operations to other dot1ag MAs or dot1ag default MD level entries that conflict with the set membership. The all-zeros value indicates that this MA is not associated with any VLANs. Assuming that the attribute is not 0, the first entry is understood to be the primary VLAN. Except forwarded linktrace messages (LTMs), CFM messages emitted by MPs in this MA are tagged with the primary VLAN ID. (R, W) (mandatory) (2 bytes/entry * 12 entries = 24 bytes)

MHF creation: This attribute determines whether the bridge creates an MHF, under circumstances defined in clause 22.2.3 of [IEEE 802.1ag]. This attribute is an enumeration with the following values:

- 1 None. No MHFs are created on this bridge for this MA.
- 2 Default (IEEE 802.1ag term). The bridge can create MHFs on this VID on any port through which the VID can pass.
- 3 Explicit. The bridge can create MHFs on this VID on any port through which the VID can pass, but only if an MEP exists at some lower maintenance level.
- 4 Defer. This value causes the ONU to use the setting of the parent MD. This is recommended to be the default value.

(R, W, set-by-create) (mandatory) (1 byte)

Sender ID permission: This attribute determines the contents of the sender ID TLV included in CFM messages transmitted by MPs controlled by this MA. This attribute is the same as that defined in the description of the dot1ag MD ME, with the addition of code point 5.

- 1 None: the sender ID TLV is not to be sent.
- 2 Chassis: the chassis ID length, chassis ID subtype, and chassis ID fields of the sender ID TLV are to be sent, but not the management address fields.

- 3 Manage: the management address fields of the sender ID TLV are to be sent, but the chassis ID length is to be transmitted with a 0 value, and the chassis ID subtype, and chassis ID fields are not to be sent.
- 4 ChassisManage: all chassis ID and management address fields are to be sent.
- 5 Defer: the contents of the sender ID TLV are determined by the corresponding MD attribute. This is recommended to be the default value.

(R, W, set-by-create) (mandatory) (1 byte)

Actions

Create, delete, get, set

Notifications

None.

9.3.21 Dot1ag default MD level

The collection of the functionality called a maintenance half-function (MHF) is not explicitly modelled as a ME by either [IEEE 802.1ag] or the OMCI. The ONU automatically creates MHFs according to parameters specified in a dot1ag MD or a dot1ag MA ME; the dot1ag default MD level ME catches the corner cases not covered by other MEs, specifically VLANs not included by any defined MA.

The dot1ag default MD level comprises a configurable table, each entry of which specifies default MHF functionality for some set of VLANs. Once a set of VLANs is defined, operations to different table entries or to dot1ag MAs that conflict with the set membership should be denied. In addition, catch-all attributes are defined to specify MHF functionality when there is no match to either a table entry or an MA.

Relationships

An ONU that supports [IEEE 802.1ag] automatically creates one instance of this ME for each MAC bridge or IEEE 802.1p mapper, depending on the ONU's provisioning model. It should not create an instance for an IEEE 802.1p mapper that is associated with a MAC bridge.

Attributes

Managed entity ID: This attribute uniquely identifies an instance of this ME. Through an identical ID, this ME is implicitly linked to an instance of the MAC bridge service profile ME or an IEEE 802.1p mapper ME. It is expected that an ONU will implement CFM on bridges or on IEEE 802.1p mappers, but not both, depending on its provisioning model. For precision, the reference is disambiguated by the value of the layer 2 type pointer attribute. (R) (mandatory) (2 bytes)

Layer 2 type: This attribute specifies whether the dot1ag default MD level ME is associated with a MAC bridge service profile (value 0) or an IEEE 802.1p mapper (value 1). (R) (mandatory) (1 byte)

Catchall level: This attribute ranges from 0..7 and specifies the MD level of MHFs created when no specific match is found. (R, W) (mandatory) (1 byte)

Catchall MHF creation: This attribute determines whether, when no more specific match is found, the bridge creates an MHF or not. This attribute is an enumeration with the following values:

- 1 None. The bridge does not create any MHFs. This is the default value.

- 2 Default. The bridge can create MHFs on this VID on any port through which the VID can pass.
- 3 Explicit. The bridge can create MHFs on this VID on any port through which the VID can pass, but only if an MEP exists at some lower maintenance level.

(R, W) (mandatory) (1 byte)

Catchall sender ID permission: This attribute determines the contents of the sender ID TLV included in CFM messages transmitted by MPs when no more specific match is found. This attribute is identical to that defined in the description of the dot1ag MD ME (i.e., excluding code point 5, defer). (R, W) (mandatory) (1 byte)

Default MD level table: Each entry is a vector of fields, indexed by primary VLAN ID.

Primary VLAN ID (2 bytes)

Table control: This field controls the meaning of a set operation. The 1 byte size of this field is included in get/get-next operations, but its value is undefined under get-next and should be ignored by the OLT. (1 byte)

- 1 Add record to table; overwrite existing record, if any.
 - 2 Delete record from table.
 - 3 Clear all entries from table. This action may affect service and should be used judiciously.
- Other values are reserved.

Status: This Boolean field indicates whether this table entry is in effect (true) or whether (false) it has been overridden by the existence of an MA for the same VID and MD level as this table's entry, and on which an up MEP is defined. This attribute is read-only. Space should be allocated for it during set operations, but the value is not used. (1 byte)

Level: This field ranges from 0..7 and specifies the MD level of MHFs under the control of this instance of the dot1ag default MD level. The additional value 0xFF instructs the bridge to use the value in the catch-all level attribute. (1 byte)

MHF creation: This attribute determines whether the bridge creates an MHF or not, under circumstances defined in clause 22.2.3 of [IEEE 802.1ag]. This attribute is an enumeration with the following values. (1 byte)

- 1 None. No MHFs are created on this bridge for this MA.
- 2 Default. The bridge can create MHFs on this VID on any port through which the VID can pass.
- 3 Explicit. The bridge can create MHFs on this VID on any port through which the VID can pass, but only if an MEP exists at some lower maintenance level.
- 4 Defer. This value causes the ONU to use the setting of the catch-all MHF creation attribute. This is recommended to be the default value.

Sender ID permission: This attribute determines the contents of the sender ID TLV included in CFM messages transmitted by MPs controlled by this MA. (1 byte)

- 1 None: the sender ID TLV is not to be sent, default.
- 2 Chassis: the chassis ID length, chassis ID subtype, and chassis ID fields of the sender ID TLV are to be sent, but not the management address fields.

- 3 Manage: the management address fields of the sender ID TLV are to be sent, but the chassis ID length is to be transmitted with a 0 value, and the chassis ID subtype, and chassis ID fields are not to be sent.
- 4 ChassisManage: all chassis ID and management address fields are to be sent.
- 5 Defer: the contents of the sender ID TLV is determined by the catch-all sender ID permission attribute.

Associated VLANs list: This field comprises a list of up to 11 additional VLAN IDs associated with the primary VLAN, 2 bytes each. Unused placeholders, possibly including the entire field, are set to 0. (22 bytes)

(R, W) (mandatory) (29 bytes * *N* entries)

Actions

Get, get next, set
Set table (optional)

Notifications

None.

9.3.22 Dot1ag MEP

This ME models an MEP as defined primarily in [IEEE 802.1ag] and secondarily in [ITU-T Y.1731]. It is created and deleted by the OLT. An MEP exists at one of eight possible maintenance levels, and resides at the boundary of a MD. It inherits a name, and optionally a set of associated VLANs, from its associated MA.

Relationships

One or more MEPs may be associated with a MAC bridge port or an IEEE 802.1p mapper in the absence of a MAC bridge. An MEP is also associated with zero or more VLANs and an MA.

Attributes

Managed entity ID: This attribute uniquely identifies each instance of this ME. (R, set-by-create) (mandatory) (2 bytes)

Layer 2 entity pointer: Depending on the value of the layer 2 type attribute, this pointer specifies the MAC bridge port configuration data ME or the IEEE 802.1p mapper service profile ME with which this MEP is associated. (R, W, set-by-create) (mandatory) (2 bytes)

Layer 2 type: This attribute specifies whether the MA is associated with a MAC bridge port (value 0) or an IEEE 802.1p mapper (value 1). (R, W, set-by-create) (mandatory) (1 byte)

MA pointer: This pointer specifies the maintenance association with which this MEP is associated. (R, W, set-by-create) (mandatory) (2 bytes)

MEP ID: This attribute specifies the MEP's own identity in the MA. For a given MA, the MEP ID must be unique throughout the network defined by the MD. The MEP ID is defined in the range 1..8191. The value 0 indicates that no MEP ID is (yet) configured. (R, W, set-by-create) (mandatory) (2 bytes)

MEP control: This attribute specifies some of the overall behavioural aspects of the MEP. It is interpreted as follows.

Bit	Interpretation when bit value = 1
1 (LSB)	Reserved
2	MEP generates CCMs
3	Enable ITU-T Y.1731 server MEP function
4	Enable generation of Ethernet AIS
5	This is an up MEP, facing toward the core of the bridge. If more than one MEP exists on a given maintenance association and on a given bridge, all such MEPs must face the same direction.
6..8	Reserved

(R, W, set-by-create) (mandatory) (1 byte)

Primary VLAN: This attribute is a 12 bit VLAN ID. The value 0 indicates that the MEP inherits its primary VLAN from its parent MA. CFM messages, except forwarded LTMs, are tagged with the primary VLAN ID. If explicitly specified, the value of this attribute must be one of the VLANs associated with the parent MA. (R, W, set-by-create) (mandatory) (2 bytes)

Administrative state: This attribute locks (1) and unlocks (0) the functions performed by this ME. Administrative state is further described in clause A.1.6. (R, W, set-by-create) (mandatory) (1 byte)

CCM and LTM priority: Ranging from 0..7, this attribute permits CCM and LTM frames to be explicitly prioritized, which may be needed if flows are separated, e.g., by 802.1p priority. The priority specified in this attribute is also used in linktrace reply (LTR) frames originated by this MEP. The value 0xFF selects the IEEE 802.1ag default, whereby CCM and LTM frames are transmitted with the highest Ethernet priority available. (R, W, set-by-create) (mandatory) (1 byte)

Egress identifier: This attribute comprises 8 bytes to be included in LTMs. They allow received LTRs to be directed to the correct originator. The attribute includes the originator MAC address and a locally defined identifier. If this field is 0, the ONU uses the MEP's MAC address, with 0 as the locally defined identifier. (R, W, set-by-create) (mandatory) (8 bytes)

Peer MEP IDs: This attribute lists the expected peer MEPs for CCMs, 2 bytes per MEP ID. [IEEE 802.1ag] allows for multipoint networks, and therefore a list of peer MEPs. This attribute allows for up to 12 peers for a given MEP, though G-PON applications are expected to need only a single peer. Missing or unexpected messages trigger alarm declaration after a soak interval. Unused peer MEP slots should be set to 0. (R, W) (mandatory) (24 bytes)

ETH AIS control: This attribute controls the generation of Ethernet alarm indication signal (AIS) frames when they are enabled through the MEP control attribute. It is interpreted as follows:

Bit	Interpretation
1 (LSB)	Transmission period 0: once per second 1: once per minute
2..4	P-bit priority of transmitted ETH AIS frames
5..7	The maintenance level at which the client MEP exists
8	Reserved

(R, W, set-by-create) (mandatory if ETH AIS is enabled) (1 byte)

Fault alarm threshold: This attribute specifies the lowest priority alarm that is allowed to generate a fault alarm. The value 0 specifies that the ONU uses its internal default. It is defined as follows.

- 1 All defects generate alarms after suitable soaking, including AIS and RDICCM.
- 2 Alarm generated only by one of: MACstatus, RemoteCCM, ErrorCCM, XconCCM. This value is recommended as the default in [IEEE 802.1ag].
- 3 Alarm generated only by one of: RemoteCCM, ErrorCCM, XconCCM.
- 4 Alarm generated only by one of: ErrorCCM, XconCCM.
- 5 Alarm generated only by: XconCCM.
- 6 No alarms are to be reported. This setting may be useful during configuration of services across the network when spurious alarms could otherwise be generated.

(R, W, set-by-create) (optional) (1 byte)

Alarm declaration soak time: This attribute defines the defect soak time that must elapse before the MEP declares an alarm. It is expressed in 10 ms units with a range of 250 to 1000, i.e., 2.5 s to 10 s. The default is recommended to be 2.5 seconds. (R, W) (mandatory) (2 bytes)

Alarm clear soak time: This attribute defines the defect-free soak time that must elapse before the MEP clears an alarm. It is expressed in intervals of 10 ms with a range of 250 to 1 000, i.e., 2.5 s to 10 s. The default is recommended to be 10 s. (R, W) (mandatory) (2 bytes)

Actions

Create, delete, get, set

Test: The test operation causes the MEP to originate one or more loopback messages (LBMs) or an LTM in accordance with the test and test result message formats defined in clauses A.2 and A.3.

The linktrace test returns its results in a general purpose buffer ME, which must have been created in advance by the OLT. (The general purpose buffer is designated by a pointer in the test message itself.) Upon completion of the linktrace operation, the general purpose buffer contains a sequence of LTR entries in the order they were received:

Length field, 2 bytes	Length bytes
Length of LTR1	LTR: linktrace reply 1 (clause 21.9 of [IEEE 802.1ag])
Length of LTR2	LTR: linktrace reply 2
etc.	

[IEEE 802.1ag] defines the data structure for the linktrace database in detail, but the definition is essentially the same as the LTR protocol data unit (PDU) itself. The OMCI simply records the messages for parsing and analysis at the OLT or the element management system (EMS).

If the ONU cannot allocate enough memory for the entire list, it keeps the most recent responses and discards the older LTRs as necessary (first discarding LTR1, then LTR2, etc.).

Notifications

Alarm

Alarm number	Alarm	Description
0	RDI CCM	RDI received in CCM from peer MEP
1	MAC status	Port or interface status failure at peer MEP
2	Remote CCM	Loss of continuity with peer MEP
3	Error CCM	Invalid CCMs received
4	Xcon CCM	CCMs received from other MAs or a lower MD level
5	Unexpected period	Unexpected period
6	AIS	Ethernet AIS received
7..207	Reserved	
208..223	Vendor-specific alarms	Not to be standardized

9.3.23 Dot1ag MEP status

This ME is the read-only twin of the dot1ag MEP. Its purpose is to return information that may help in system- or network-level troubleshooting. It is automatically created and deleted by the ONU at the time its MEP is created or deleted.

As the reporter of ephemeral information, the dot1ag MEP status ME does not retain its attribute values across initializations and is not included in MIB uploads.

Relationships

A dot1ag MEP status ME is associated with a dot1ag MEP ME.

Attributes

Managed entity ID: This attribute uniquely identifies each instance of this ME. Through an identical ID, this ME is implicitly linked to an instance of the dot1ag MEP ME. (R) (mandatory) (2 bytes)

MEP MAC address: This attribute records the MEP's MAC address. (R) (mandatory) (6 bytes)

Fault notification generator state: This attribute records the current state of the MEP's fault notification generator state machine. States are defined in clause 20.35 of [IEEE 802.1ag].

- 1 Reset
- 2 Defect
- 3 Report defect
- 4 Defect reported
- 5 Defect clearing

(R) (mandatory) (1 byte)

Highest priority defect observed: This attribute records the highest priority defect observed since the fault notification state machine was last in reset state. In increasing priority order, possible values are as follows.

- 0 No defect observed
- 1 Received a CCM from a remote MEP in which the remote defect indication (RDI) bit was set
- 2 Received a CCM from a remote MEP in which the port status or interface status TLV reported an error
- 3 No CCMs received for at least $3.5 * \text{CCM interval}$ from at least one remote MEP in the MA
- 4 Received invalid CCMs for at least $3.5 * \text{CCM interval}$
- 5 Received CCMs for at least $3.5 * \text{CCM interval}$ that could be from another MA

(R) (mandatory) (1 byte)

Current defects: This attribute is a bit field that signals several events of interest in real time.

Bit	Meaning when set
1 (LSB)	Another MEP in the same MA is currently transmitting an RDI.
2	A port status or interface status TLV received from another MEP in the MA is currently indicating an error condition.
3	CCMs have not been received for at least $3.5 * \text{CCM interval}$ from at least one of the expected remote MEPs.
4	Erroneous CCMs have been received for at least $3.5 * \text{CCM interval}$ from at least one of the remote MEPs in this MA.
5	CCMs have been received for at least $3.5 * \text{CCM interval}$ from an MEP that is not configured into the current MA.
6..8	Reserved

(R) (mandatory) (1 byte)

Last received errored CCM table: This attribute contains the most recently received CCM that contributed to a defErrorCCM fault. If no such CCM has been received, this attribute is null. The format of the CCM is defined in clause 21.6 of [IEEE 802.1ag]. (R) (mandatory) (*N* bytes, not to exceed 128)

Last received Xcon CCM table: This attribute contains the most recently received CCM that contributed to a defXconCCM fault. If no such CCM has been received, this attribute is null. (R) (mandatory) (*N* bytes, not to exceed 128)

Out of sequence CCMs count: This attribute records the number of out of sequence CCMs received. When the counter is full, it rolls over to 0. (R) (optional) (4 bytes)

CCMs transmitted count: This attribute records the number of CCMs transmitted. It may be used as the sequence number of transmitted CCMs. When the counter is full, it rolls over to 0. (R) (mandatory) (4 bytes)

Unexpected LTRs count: This attribute records the number of unexpected LTRs received. When the counter is full, it rolls over to 0. (R) (mandatory) (4 bytes)

Loopback replies (LBRs) transmitted count: This attribute records the number of LBRs transmitted. When the counter is full, it rolls over to 0. (R) (mandatory) (4 bytes)

Next loopback transaction identifier: This attribute is the value of the transaction number sent in the next LBM to be transmitted. At ONU initialization, it should be initialized to a random value. It increments with each LBM sent, and rolls over when full. (R) (mandatory) (4 bytes)

Next linktrace transaction identifier: This attribute is the value of the transaction number sent in the next LTM to be transmitted. It increments with each LTM sent, and rolls over when full. (R) (mandatory) (4 bytes)

Actions

Get, get next

Notifications

None. This ME does not generate AVCs because its attributes change frequently in real time, but are generally only of interest after the corresponding MEP declares an alarm.

9.3.24 Dot1ag MEP CCM database

This ME records the recent history of remote MEPs, as deduced by the local parent MEP. Because records are of variable length, and are constantly updated, a separate attribute is defined for each remote MEP. The dot1ag MEP CCM database is automatically created or deleted by the ONU at the time an MEP is created or deleted.

As the reporter of ephemeral information, the dot1ag MEP CCM database ME does not retain its attribute values across initializations and is not included in MIB uploads.

Relationships

A dot1ag MEP CCM database ME is associated with a dot1ag MEP ME.

Attributes

Managed entity ID: This attribute uniquely identifies each instance of this ME. Through an identical ID, this ME is implicitly linked to an instance of the dot1ag MEP ME. (R) (mandatory) (2 bytes)

Each of the following RMEP database table attributes records information for one of the possible remote MEPs. It is expected that there will be only one remote MEP per MA in G-PON applications, but the ME is defined in a way that permits several RMEPs. The optional attributes are instantiated by the ONU when additional remote MEPs are provisioned on the local MEP. Remote MEP records appear in no particular order, and the order is not guaranteed to persist across ONU initializations.

NOTE – Although each attribute is shown with a single indeterminate length N , it is understood that the length of each attribute varies in real time, and independently from the length of the other attributes.

RMEP 1 database table: (R) (mandatory) (N bytes)

RMEP 2 database table: (R) (optional) (N bytes)

RMEP 3 database table: (R) (optional) (N bytes)

RMEP 4 database table: (R) (optional) (N bytes)

RMEP 5 database table: (R) (optional) (N bytes)

RMEP 6 database table: (R) (optional) (N bytes)

RMEP 7 database table: (R) (optional) (N bytes)

RMEP 8 database table: (R) (optional) (*N* bytes)
RMEP 9 database table: (R) (optional) (*N* bytes)
RMEP 10 database table: (R) (optional) (*N* bytes)
RMEP 11 database table: (R) (optional) (*N* bytes)
RMEP 12 database table: (R) (optional) (*N* bytes)

Each attribute is a record that comprises the following fields.

RMep identifier: The MEP ID of the remote MEP. (2 bytes)

RMep state: An enumeration with the following meaning (1 byte).

- 1 Idle. Momentary state during reset.
- 2 Start. The timer has not expired since the state machine was reset, but no valid CCM has yet been received.
- 3 Failed. The timer has expired since the state machine was reset and since a valid CCM was received.
- 4 Ok. The timer has not expired since a valid CCM was received.

Failed-ok time: A timestamp, the value of the local ONU's SysUpTime at which the remote MEP state last entered either the failed or ok state. SysUpTime is a count of 10 ms intervals since ONU initialization. The value is 0 if it has not been in either of these states since ONU initialization. (4 bytes)

MAC address: The MAC address of the remote MEP. If no CCM has been received from the remote MEP, this field has the value 0. (6 bytes)

RDI: Boolean indicating whether the RDI bit in the most recently received CCM was set. (1 byte)

Port status: The port status from the most recently received CCM, as defined in clause 21.5.4 of [IEEE 802.1ag]. The absence of a received port status TLV is indicated by the value 0. (1 byte)

Interface status: The interface status from the most recently received CCM, as defined in clause 21.5.5 of [IEEE 802.1ag]. The absence of a received interface status TLV is indicated by the value 0. (1 byte)

Sender ID TLV: This is the actual sender ID TLV from the most recently received CCM, as defined in clause 21.5.3 of [IEEE 802.1ag]. The absence of a received sender ID TLV is indicated by a single byte of value 0. (*M* bytes)

Actions

Get, get next

Notifications

None. The MEP CCM database table attributes do not generate AVCs because they change constantly in real time, usually in ways that are of no immediate interest.

9.3.25 Dot1ag CFM stack

This ME reports the maintenance status of a bridge port at any given time. An ONU that supports [IEEE 802.1ag] functionality automatically creates an instance of the dot1ag CFM stack ME for each MAC bridge or IEEE 802.1p mapper, depending on its provisioning model.

The dot1ag CFM stack also lists any VLANs and bridge ports against which configuration errors are currently identified. The ONU should reject operations that create configuration errors. However, these errors can arise because of operations on other MEs that are not necessarily possible to detect during CFM configuration.

Relationships

An ONU that supports [IEEE 802.1ag] creates one instance of this ME for each MAC bridge or IEEE 802.1p mapper, depending on its provisioning model. It should not create an instance for an IEEE 802.1p mapper that is associated with a MAC bridge.

Attributes

Managed entity ID: This attribute uniquely identifies an instance of this ME. Through an identical ID, this ME is implicitly linked to an instance of the MAC bridge service profile ME or an IEEE 802.1p mapper ME. It is expected that an ONU will implement CFM on bridges or on IEEE 802.1p mappers, but not both. For precision, the reference is disambiguated by the value of the layer 2 type pointer attribute. (R) (mandatory) (2 bytes)

Layer 2 type: This attribute specifies whether the dot1ag CFM stack is associated with a MAC bridge service profile (value 0) or an IEEE 802.1p mapper (value 1). (R) (mandatory) (1 byte)

MP status table: This attribute is a list of entries, each entry reporting one aspect of the maintenance status of one port. If a port is associated with more than one CFM maintenance entity, each is represented as a separate item in this table attribute; a port that has no current maintenance functions is not represented in the table (so the table may be empty). Each entry is defined as follows.

Port ID: The ME ID of the MAC bridge port config data whose information is reported in this entry. If the layer 2 parent is an IEEE 802.1p mapper, a null pointer. (2 bytes)

Level: The level at which the reported maintenance function exists, 0..7. (1 byte)

Direction: The value 1 (down) or 2 (up). (1 byte)

VLAN ID: If this table entry reports a maintenance function associated with a VLAN, this field contains the value of the primary VLAN ID. If no VLAN is associated with this entry, this field contains the value 0. (2 bytes)

MD: A pointer to the associated dot1ag maintenance domain ME. If no MD is associated with this entry, a null pointer. (2 bytes)

MA: A pointer to the associated dot1ag maintenance association ME. If no MA is associated with this entry, a null pointer. (2 bytes)

MEP ID: If this table entry reports an MEP, this field contains the value of its MEP ID (range 1..8191). If this table entry reports an MHF, this field contains the value 0. (2 bytes)

MAC address: The MAC address of the MP. (6 bytes)

(R) (mandatory) (18*N* bytes)

Configuration error list table: This attribute is based on the [IEEE 802.1ag] configuration error list. It is a list of entries, each entry reporting a VLAN and a bridge port against which a configuration error has been detected. The table may be empty at any given time. Entries are defined as follows:

VLAN ID: If this table entry reports a maintenance function associated with a VLAN, this field contains the value of the VLAN ID in error. If no VLAN is associated with this entry, this field contains the value 0. (2 bytes)

Port ID: A pointer to the MAC bridge port config data whose information is reported in this entry. If the layer 2 parent is an IEEE 802.1p mapper, a null pointer. (2 bytes)

Detected configuration error: A bit mask with the following meanings. A list entry exists if and only if at least one of these bits is set. Definitions appear in clause 22.2.4 of [IEEE 802.1ag]: (1 byte)

- 0x01 CFM leak. MA x is associated with a specific VID list, one or more of the VIDs in MA x can pass through the bridge port, no up MEP is configured for MA x on the bridge port, no down MEP is configured on any bridge port for MA x, and another MA y, at a higher MD level than MA x, and associated with at least one of the VID(s) also in MA x, does have an MEP configured on the bridge port.
- 0x02 Conflicting VIDs. MA x is associated with a specific VID list, an up MEP is configured on MA x on the bridge port, and another MA y, associated with at least one of the VID(s) also in MA x, and at the same MD level as MA x, also has an up MEP configured on some bridge port.
- 0x04 Excessive levels. The number of different MD levels at which maintenance domain intermediate points (MIPs) are to be created on this port exceeds the bridge's capabilities.
- 0x08 Overlapped levels. An MEP is created for one VID at one MD level, but an MEP is also configured on another VID at that MD level or higher, exceeding the bridge's capabilities.

(R) (mandatory) (5N bytes)

Actions

Get, get next

Notifications

Attribute value change

Number	Attribute value change	Description
1..2	N/A	
3	Config error list table	This AVC indicates that an entry in the configuration error list table has been added or removed. It may be advisable for the OLT to audit the configuration of related MEs.
4..16	Reserved	

9.3.26 Dot1ag chassis-management info

This ME represents the system-level chassis ID or management address for [IEEE 802.1ag] CFM messages, and potentially for other IEEE 802-based functions. Although [IEEE 802.1AB] allows for several management addresses (synonyms in different formats or with granularity to the component level), [IEEE 802.1ag] does not provide for more than one. Nor is it expected that an ONU would require more than one format. Accordingly, this ME provides for only one.

According to sender ID permission attributes in several dot1ag MEs, transmitted IEEE 802.1ag CFM messages may include either or both of the chassis ID or management address fields. [IEEE 802.1ag] requires that CCMs do not exceed 128 bytes, of which 74 are separately allocated to other purposes; the sender ID TLV, if present, must accommodate this requirement. The chassis info and management

info must fit, with a minimum of 4 additional overhead bytes, into the remaining 54 bytes. This limit is exploited in defining the maximum size of the ME's attributes.

Relationships

If an ONU supports [IEEE 802.1ag] functionality, it automatically creates an instance of this ME.

Attributes

Managed entity ID: This attribute uniquely identifies this ME. There is at most one instance, whose value is 0. (R) (mandatory) (2 bytes)

Chassis ID length: The length of the chassis ID attribute (not including the chassis ID subtype attribute), default value 0. (R, W) (mandatory) (1 byte)

Chassis ID subtype: The format of the chassis ID attribute, default value 7, as defined in [IEEE 802.1AB]:

1	Chassis component	A particular instance of the entPhysicalAlias object (defined in [IETF RFC 4133]) for a chassis component.
2	Interface alias	A particular instance of the ifAlias object (defined in [IETF RFC 2863]) for an interface on the containing chassis.
3	Port component	A particular instance of the entPhysicalAlias object (defined in [IETF RFC 4133]) for a port or backplane component within the containing chassis.
4	Mac address	A particular unicast source address (encoded in network byte order and IEEE 802.3 canonical bit order), of a port on the containing chassis as defined in [IEEE 802].
5	Network address	A particular network address, encoded in network byte order, associated with one or more ports on the containing chassis. The first octet contains the Internet Assigned Numbers Authority [b-IANA] address family numbers enumeration value for the specific address type, and octets 2 to <i>N</i> contain the network address value in network byte order.
6	Interface name	A particular instance of the ifName object (defined in [IETF RFC 2863]) for an interface on the containing chassis.
7	Local	Locally assigned chassis ID

(R, W) (mandatory) (1 byte)

Chassis ID part 1, Chassis ID part 2: These two attributes may be regarded as an octet string of up to 50 bytes whose length is given by the chassis ID length attribute and whose value is the left-justified chassis ID. (R, W) (mandatory) (25 bytes * 2 attributes)

Management address domain length: The length of the management address domain attribute, default value 0. If this attribute has the value 0, all of the other management address attributes are undefined. (R, W) (mandatory) (1 byte)

Management address domain 1, Management address domain 2: These two attributes may be regarded as an octet string of up to 50 bytes whose length is given by the management address domain length attribute and whose value is the left-justified management address domain. The attribute is coded as an object identifier (OID) as per [ITU-T X.690], referring to a TDomain as defined in [IETF RFC 2579]. Typical domain values include snmpUDPDomain (from

SNMPv2-TM [IETF RFC 3417]) and snmpIeee802Domain (from SNMP-IEEE 802-TM-MIB [IETF RFC 4789]). (R, W) (mandatory) (25 bytes * 2 attributes)

Management address length: The length of the management address attribute, default value 0. (R, W) (mandatory) (1 byte)

Management address 1, Management address 2: These two attributes may be regarded as an octet string of up to 50 bytes whose length is given by the management address length attribute and whose value is the left-justified management address. (R, W) (mandatory) (25 bytes * 2 attributes)

Actions

Get, set

Notifications

None.

9.3.27 Multicast operations profile

This ME expresses multicast policy. A multi-dwelling unit ONU may have several such policies, which are linked to subscribers as required. Some of the attributes configure IGMP snooping and proxy parameters if the defaults do not suffice, as described in [IETF RFC 2236], [IETF RFC 3376], [IETF RFC 3810] and [IETF RFC 5519]. Instances of this ME are created and deleted by the OLT.

Relationships

An instance of this ME may be associated with zero or more instances of the multicast subscriber config info ME.

Attributes

Managed entity ID: This attribute uniquely identifies each instance of this ME. The values 0 and 0xFFFF are reserved. (R, set-by-create) (mandatory) (2 bytes)

IGMP version: This attribute specifies the version of IGMP to be supported. Support of a given version implies compatible support of previous versions. If the ONU cannot support the version requested, it should deny an attempt to set the attribute. (R,W, set-by-create) (mandatory) (1 byte)

1 IGMP version 1 (deprecated)

2 IGMP version 2

3 IGMP version 3

16 MLD version 1

17 MLD version 2

Other values are reserved.

IGMP function: This attribute enables an IGMP function. The value 0 specifies transparent IGMP snooping only. The value 1 specifies snooping with proxy reporting (SPR); the value 2 specifies IGMP proxy. The function must be consistent with the capabilities specified by the other IGMP configuration attributes. (R,W, set-by-create) (mandatory) (1 byte)

Immediate leave: This Boolean attribute controls the immediate leave function. The value false disables immediate leave; true enables immediate leave. (R,W, set-by-create) (mandatory) (1 byte)

Upstream IGMP TCI: Under control of the upstream IGMP tag control attribute, the upstream IGMP TCI attribute defines a VLAN ID and P-bits to add to upstream IGMP messages. (R, W, set-by-create) (optional) (2 bytes)

Upstream IGMP tag control: This attribute controls the upstream IGMP TCI attribute. If this attribute is non-zero, a possible extended VLAN tagging operation ME is ignored for upstream frames containing IGMP/MLD packets. (R, W, set-by-create) (optional) (1 byte)

Value Meaning

- 0 Pass upstream IGMP/MLD traffic transparently, neither adding, stripping nor modifying tags that may be present.
- 1 Add a VLAN tag (including P bits) to upstream IGMP/MLD traffic. The tag is specified by the upstream IGMP TCI attribute.
- 2 Replace the entire TCI (VLAN ID plus P bits) on upstream IGMP/MLD traffic. The new tag is specified by the upstream IGMP/MLD TCI attribute. If the received IGMP/MLD traffic is untagged, an add operation is performed.
- 3 Replace only the VLAN ID on upstream IGMP/MLD traffic, retaining the original DEI and P bits. The new VLAN ID is specified by the VLAN ID field of the upstream IGMP TCI attribute. If the received IGMP/MLD traffic is untagged, an add operation is performed, with DEI and P bits also taken from the upstream IGMP TCI attribute.

Other values are reserved.

Upstream IGMP rate: This attribute limits the maximum rate of upstream IGMP traffic. Traffic in excess of this limit is silently discarded. The attribute value is specified in messages/second. The recommended default value 0 imposes no rate limit on this traffic. (R, W, set-by-create) (optional) (4 bytes)

Dynamic access control list table: This attribute is a list that specifies one or more multicast group address ranges. Each row in the list comprises up to three row parts, where each row part is 24 bytes long. Each entry must include row part 0. The ONU may also support row parts 1-2, thus allowing the table to contain logical rows that exceed the 24 byte definition of row part 0.

Table control (2 bytes)

16	15	14	13	12	11	10	9	8	7	6	5	4	3	2	1
Set ctrl		Row part ID			Test	Row key									

The first 2 bytes of each row part is the table control field, which comprises a key into the row, the row part identifier, and fields to define the result of a set operation and to test whether the ONU supports the extended table format.

It is the responsibility of the OLT to assign and track row keys and content. The ONU should deny set operations that create range overlaps.

Set ctrl

The two MSBs of this field determine the meaning of a set operation. These bits are returned as 00 during get next operations.

Bits 16..15	Meaning
00	Reserved
01	Write this entry into the table. Overwrite any existing entry with the same row part ID and row key.
10	Delete this entry from the table, including all row parts. The remaining fields are not meaningful.

Bits 16..15	Meaning
11	Clear all entries from the table. The remaining fields are not meaningful.

Row part ID

The row part ID field distinguishes the row part associated with the current set or get operation.

Row part 0 is backward compatible with earlier versions of this ME definition. Row parts 1-2 are optional on a row by row basis. They can be set by using values 001-010 as the row part ID. Row parts 3-7 are reserved.

Bits 14..12	Meaning
000	The associated row part has format 0.
001	The associated row part has format 1.
010	The associated row part has format 2.
011..111	Reserved

Test

This bit allows the OLT to determine whether an ONU supports the extended format access control list. If the ONU does not support the extended format, it should be possible to set the test bit to 1 and read it back with a get and get next operation. If the ONU does support the extended format, this bit should always return the value 0 under a get next operation.

Row key

The row key distinguishes rows in the table.

Row part definition

Byte	Row part 0	Row part 1	Row part 2
1	Table control (2 bytes)	Table control (2 bytes)	Table control (2 bytes)
2			
3	GEM port ID (2 bytes)	Leading bytes of IPv6 source address (12 bytes)	Leading bytes of IPv6 destination address (12 bytes)
4			
5			
6			
7			
8	Source IP address (4 bytes)		
9			
10			
11	Destination IP address, start of range (4 bytes)		
12			
13			
14			
15		Preview length (2 bytes)	Reserved (10 bytes)
16			

Byte	Row part 0	Row part 1	Row part 2
17	Destination IP address, end of range (4 bytes)	Preview repeat time (2 bytes)	
18			
19	Imputed group bandwidth (4 bytes)	Preview repeat count (2 bytes)	
20			
21		Preview reset time (2 bytes)	
22			
23	Reserved (2 bytes)	Reserved (2 bytes)	
24			

Figure 9.3.27-1 – ACL row part formats

Format of row part 0:

- Table control (2 bytes)
- GEM port-ID (2 bytes)
- VLAN ID (ANI). This field specifies the VLAN carrying the multicast group downstream.

Values:

0 – Designates an untagged downstream flow.

1..4095 – Matched against the VID of the downstream multicast frame.

4096 – Reserved.

4097 – Matches downstream tagged messages only, but ignores the value of the VID.

0xFFFF – Unspecified.

(2 bytes)

- Source IP address. The value 0.0.0.0 specifies that the source IP address is to be ignored. By default, this is an IPv4 address; it may be an IPv6 address if it is associated with a part 1 row. (4 bytes)
- Destination IP address of the start of the multicast range. By default, this is an IPv4 address; it may be an IPv6 address if it is associated with a part 2 row. (4 bytes)
- Destination IP address of the end of the multicast range. By default, this is an IPv4 address; it may be an IPv6 address if it is associated with a part 2 row. (4 bytes)
- Imputed group bandwidth. Expressed in bytes per second, the imputed group bandwidth is used to decide whether or not to honour a join request in the presence of a max multicast bandwidth limit. The recommended default value 0 effectively allows this table entry to avoid max bandwidth limitations (4 bytes)
- Reserved, set to 0. (2 bytes)

A single multicast group may be specified by setting start and end destination IP addresses to the same value.

Format of row part 1:

- Table control (2 bytes)

- The leading bytes of the IPv6 source address (12 bytes). This field is prepended to the 4 byte source IP address field of the corresponding part 0 row. The row part 0 address field is interpreted as an IPv4 address if the first 10 bytes of this row part 1 field are 0 and the last 2 bytes are either 0 or 0xFFFF [b-IETF RFC 4291]. The latter syntax is preferred.
- Preview length. The maximum duration of each preview in seconds. The value 0 designates a group that is fully authorized by subscription and is not subject to preview restrictions. The remaining preview attributes in this row part are ignored. (2 bytes)
- Preview repeat time. The minimum time in seconds between two previews of a given multicast group. (2 bytes)
- Preview repeat count. The maximum number of times a given multicast group may be previewed. A value of zero allows an unlimited number of previews. (2 bytes)
- Preview reset time. The time at which the ONU resets the preview repeat counter. The value assignments are as follows: (2 bytes)
 - 0: Do not reset the preview repeat counter automatically. It is cleared only upon explicit action by the OLT.
 - 1..24: The integer clock time at which the ONU resets the preview repeat counter. For example the value 2 resets the counter at 02:00 AM. If the ONU does not have a time of day clock, the preview repeat counter is reset every 24 h at an indeterminate time selected by the ONU.
 - 25...240: Reserved by ITU
 - 241..254: Reserved for vendor-specific use
 - 255: Used by the OLT to explicitly reset the preview repeat counter. A set action with this value clears the preview repeat count to zero, but does not alter the pre-existing value of the field in the table row part.
- Reserved (2 bytes)

Format of row part 2:

- Table control (2 bytes)
- The leading bytes of the IPv6 DAs (12 bytes). This field is prepended to the 4 byte destination IP address field of the corresponding part 0 row. The row part 0 address field is interpreted as an IPv4 address if the first 10 bytes of this row part 2 field are 0 and the last 2 bytes are either 0 or 0xFFFF [b-IETF RFC 4291]. The latter syntax is preferred.
- Reserved (10 bytes)

(R, W) (mandatory) (each row part: 24 bytes)

Discussion of table size: While theoretically, this table could contain 1024 entries, real-world applications are not expected to require large tables. It is instead anticipated that the table will list a moderate number of contiguous ranges, each of which shares a common GEM port, VLAN, IP source address, imputed bandwidth, and preview characteristics. The ONU maintains preview counters and interval timers on a per-multicast group basis, not collectively for the entire range.

Static access control list table: This attribute is a list that specifies one or more multicast group address ranges. Groups defined in this list are multicast on the associated UNI(s) unconditionally, i.e., without the need for an IGMP join. The

bandwidth of static multicast groups is not included in the current multicast bandwidth measurement maintained by the multicast subscriber monitor ME. If a join message is always expected, this table may be empty. Table entries have the same format as those in the dynamic access control list table. The preview fields are not meaningful. (R, W) (mandatory) (each row part: 24 bytes)

Lost groups list table: This attribute is a list of groups from the dynamic access control list table for which there is an active join, but no downstream flow is present, possibly because of source failure, but also possibly because of misconfiguration somewhere upstream. Be aware of possible ambiguity between overlapping service providers and IPv4/IPv6 addresses. After a join, the ONU should wait a reasonable time for upstream processing before declaring a group to be lost. Each entry is a vector of the following components:

- VLAN ID, 0 if not used (2 bytes)
- Source IP address, 0.0.0.0 if not used. In IPv6, this field captures only the four least significant bytes. (4 bytes)
- Multicast destination IP address. In IPv6, this field captures only the four least significant bytes. (4 bytes)

(R) (optional) (10N bytes)

Robustness: This attribute allows tuning for possible packet loss in the network. The recommended default value 0 causes the ONU to follow [IETF RFC 3376] to copy the robustness value from query messages originating further upstream. (R, W, set-by-create) (optional) (1 byte)

Querier IP address: This attribute specifies the IP address to be used by a proxy querier. Although it is not a legitimate IP address, the recommended default value 0.0.0.0 is legal in this case (see [b-IETF RFC 4541]). (R, W, set-by-create) (optional) (4 bytes)

Query interval: This attribute specifies the interval between general queries in seconds. The value 0 specifies that the ONU uses its own default, which may or may not be the same as the recommended default of 125 s. (R, W, set-by-create) (optional) (4 bytes)

Query max response time: This attribute is the max response time added by the proxy into general query messages directed to UNIs. It is expressed in units of 0.1 s. The value 0 specifies that the ONU uses its own default, which may or may not be the same as the recommended default of 100 (10 s). (R, W, set-by-create) (optional) (4 bytes)

Last member query interval: This attribute specifies the maximum response time inserted into group-specific queries sent to UNIs in response to group leave messages. It is also the repetition rate of [robustness] transmissions of the query. It is specified in units of 0.1 s, with a default of 10 (1 s). (R, W) (optional) (4 bytes)

Unauthorized join request behaviour: This Boolean attribute specifies the ONU's behaviour when it receives an IGMP join request for a group that is not authorized in the dynamic address control list table, or an IGMPv3 membership report for groups, none of which are authorized in the dynamic ACL. The default value false specifies that the ONU silently discard the IGMP request; the value true specifies that the ONU forwards the request upstream. The ONU does not attempt to honour the request for the unauthorized group(s) in either case. (R, W) (optional) (1 byte)

Downstream IGMP and multicast TCI: This attribute controls the downstream tagging of both the IGMP/MLD and multicast frames. If the first byte of this attribute is non-zero, a possible extended VLAN tagging operation ME is ignored for downstream IGMP/MLD and multicast frames. (R, W, set-by-create) (optional) (3 bytes)

The first byte defines the control type:

Value	Meaning
0	Pass the downstream IGMP/MLD and multicast traffic transparently, neither stripping nor modifying tags that may be present.
1	Strip the outer VLAN tag (including P bits) from the downstream IGMP/MLD and multicast traffic.
2	Add a tag on to the downstream IGMP/MLD and multicast traffic. The new tag is specified by the second and third bytes of this attribute.
3	Replace the tag on the downstream IGMP/MLD and multicast traffic. The new tag is specified by the second and third bytes of this attribute.
4	Replace only the VLAN ID on the downstream IGMP/MLD and multicast traffic, retaining the original DEI and P bits. The new VLAN ID is specified by the VLAN ID field of the second and third bytes of this attribute.
5	Add a tag on to the downstream IGMP/MLD and multicast traffic. The new tag is specified by the VID (UNI) field of the multicast service package table row of the multicast subscriber config info ME that is associated with this profile. If the VID (UNI) field is unspecified (0xFFFF) or specifies untagged traffic, the new tag is specified by the second and third bytes of this attribute.
6	Replace the tag on the downstream IGMP/MLD and multicast traffic. The new tag is specified by the VID (UNI) field of the multicast service package table row of the multicast subscriber config info ME that is associated with this profile. If the VID (UNI) field specifies untagged traffic, the outer VLAN tag (including P bits) is stripped from the downstream IGMP/MLD and multicast traffic. If the value of the VID (UNI) is unspecified (0xFFFF), the new tag is specified by the second and third bytes of this attribute.
7	Replace only the VID on the downstream IGMP/MLD and multicast traffic, retaining the original DEI and P bits. The new VLAN ID is specified by the VID (UNI) field of the multicast service package table row of the multicast subscriber config info ME that is associated with this profile. If the VID (UNI) field specifies untagged traffic, the outer VLAN tag (including P bits) is stripped from the downstream IGMP/MLD and multicast traffic. If the value of the VID (UNI) is unspecified (0xFFFF), the new tag is specified by the second and third bytes of this attribute.

Other values are reserved.

The second and third bytes define the TCI (VLAN ID and P bits) to be applied on the downstream IGMP/MLD and multicast streams in case the replace or add option is selected.

Actions

Create, delete, get, get next, set
Set table (optional)

Notifications

Alarm

Alarm number	Alarm	Description
0	Lost multicast group	Indicates that for one or more multicast groups, there is an active join, but no downstream flow is present. This alarm is equivalent to a non-zero number of entries in the lost groups list table attribute. When the alarm is active, the OLT may use the table to retrieve the details of the lost group(s).
1..207	Reserved	
208..223	Vendor-specific alarms	Not to be standardized

9.3.28 Multicast subscriber config info

This ME organizes data associated with multicast management at subscriber ports of IEEE 802.1 bridges, including IEEE 802.1p mappers when the provisioning model is mapper-based rather than bridge-based. Instances of this ME are created and deleted by the OLT. Because of backward compatibility considerations, a subscriber port without an associated multicast subscriber config info ME would be expected to support unrestricted multicast access; this ME may therefore be viewed as restrictive, rather than permissive.

Through separate attributes, this ME supports either a single multicast operations profile in its backward compatible form, or a list of multicast operations profiles instead (the list may of course contain a single entry). The OLT can determine whether the ONU supports the multiple profile capability by performing a get operation on the optional multicast service package table attribute, which exists only on ONUs that are prepared to support the feature.

Relationships

An instance of this ME is associated with one instance of the MAC bridge port configuration data or the IEEE 802.1p mapper service profile.

Attributes

Managed entity ID: This attribute uniquely identifies each instance of this ME. Through an identical ID, this ME is implicitly linked to an instance of the MAC bridge port configuration data or IEEE 802.1p mapper ME. (R, set-by-create) (mandatory) (2 bytes)

ME type: This attribute indicates the type of the ME implicitly linked by the ME ID attribute.

- 0 MAC bridge port config data
- 1 IEEE 802.1p mapper service profile

(R, W, set-by-create) (mandatory) (1 byte)

Multicast operations profile pointer: This attribute points to an instance of the multicast operations profile. This attribute is ignored by the ONU if a non-empty

multicast service package table attribute is present. (R,W, set-by-create) (mandatory) (2 bytes)

Max simultaneous groups: This attribute specifies the maximum number of dynamic multicast groups that may be replicated to the client port at any one time. The recommended default value 0 specifies that no administrative limit is to be imposed. (R, W, set-by-create) (optional) (2 bytes)

Max multicast bandwidth: This attribute specifies the maximum imputed dynamic bandwidth, in bytes per second, that may be delivered to the client port at any one time. The recommended default value 0 specifies that no administrative limit is to be imposed. (R, W, set-by-create) (optional) (4 bytes)

Bandwidth enforcement: The recommended default value of this Boolean attribute is false, and specifies that attempts to exceed the max multicast bandwidth be counted but honoured. The value true specifies that such attempts be counted and denied. The imputed bandwidth value is taken from the dynamic access control list table, both for a new join request and for pre-existing groups. (R, W, set-by-create) (optional) (1 byte)

Multicast service package table: This attribute is a list that specifies one or more multicast service packages. When the ONU receives an IGMP/MLD join request, it searches the multicast service package table in row key order, matching the VID (UNI) field (several rows can share the same VID). For each VID (UNI) match, the multicast operations profile pointer is used to access the ME that contains the attributes associated with the service package. The search stops when all requested multicast groups have been found and dealt with.

Each list entry is a vector of six components as follow.

- **Table control** (2 bytes)

The first 2 bytes of each entry contain a key into the table. It is the responsibility of the OLT to assign and track table keys and content. Since row keys are created by the OLT, they may be densely or sparsely packed.

The two MSBs of this field determine the meaning of a set operation. These bits are returned as 00 during get next operations.

Bits 16..15	Meaning
00	Reserved
01	Write this entry into the table. Overwrite any existing entry with the same row key.
10	Delete this entry from the table. The remaining fields are not meaningful.
11	Clear all entries from the table. The remaining fields are not meaningful.

Bits 14..11 are reserved. Bits 10..1 are the row key itself.

- **VID (UNI).** The value in this field is compared with the VID of upstream IGMP/MLD messages, and is used to decide whether to honour a join request. (2 bytes)

Values:

0..4095 – Matched against the VID of the IGMP/MLD message. 0 indicates a priority-tagged message, whose P bits are ignored.

4096 – Matches untagged IGMP/MLD messages only.

4097 – Matches tagged messages only, but ignores the value of the VID.

0xFFFF – Unspecified.

The VID (UNI) comparison occurs prior to any action defined by the upstream IGMP tag control attribute in an associated multicast operations profile (or alternatively, before any modification by a possible (extended) VLAN tagging operation configuration data ME).

- **Max simultaneous groups.** This field specifies the maximum number of dynamic multicast groups that may be replicated to the client port at any one time, for the multicast service package that is associated with this row. The value 0 specifies that no administrative limit is to be imposed. (2 bytes)
- **Max multicast bandwidth.** This field specifies the maximum imputed dynamic bandwidth, in bytes per second, that may be delivered to the client port at any one time, for the multicast service package that is associated with this row. The value 0 specifies that no administrative limit is to be imposed. (4 bytes)

NOTE – The port is also constrained by the global max simultaneous groups and max multicast bandwidth attributes of the multicast subscriber config info ME.

- **Multicast operations profile pointer.** This field contains the ME ID of the multicast operations profile ME associated with this service package. (2 bytes)
- **Reserved** (8 bytes)

(R, W) (optional) (20N bytes, where N is the number of entries in the table)

Allowed preview groups table: This attribute is a list that specifies the preview groups that are currently allowed for the UNI associated with this ME. It is intended to support paid viewing of a multicast group that may or may not have been previewed.

When an IGMP/MLD join request is received, the order of search precedence is as follows.

1. Multicast operations profile(s), fully authorized groups
2. This attribute, the allowed preview groups table
3. Multicast operations profile(s), preview-only groups

If the first match is a group listed in this attribute, the ONU forwards the group to the UNI until the group is removed from this list or until the subscriber leaves the group.

Each list entry begins with a table control field:

Table control (2 bytes)

16	15	14	13	12	11	10	9	8	7	6	5	4	3	2	1
Set ctrl		Row part			Rsv	Row key									

The first 2 bytes of each entry contain a key into the table, as well as table management fields. It is the responsibility of the OLT to assign and track row keys and content.

Set ctrl

The two MSBs of this field determine the meaning of a set operation. These bits are returned as 00 during get next operations.

Bits 16..15	Meaning
00	Reserved
01	Write this entry into the table. Overwrite any existing entry with the same row part and row key.
10	Delete this entry from the table, including all row parts. The remaining fields are not meaningful.
11	Clear all entries from the table. The remaining fields are not meaningful.

Row part

The row part field allows the table to contain logical rows that exceed the maximum length of a single row. Table entries with the same row key and different row parts are understood to comprise a single extended row. In this ME, an extended row always contains two row parts.

The meaning of extended rows is defined as follows.

Bits 14..12	Meaning
000	The associated row operation is for part 0.
001	The associated row operation is for part 1.
010..111	Reserved

Rsv

This bit is reserved.

Row key

The row key identifies rows in the table. Row keys may be either densely or sparsely populated.

Row part format definition

Byte	Row part 0	Row part 1
1	Table control (2 bytes)	Table control (2 bytes)
2		
3	Source IP address (16 bytes)	Destination IP address (16 bytes)
4		
5		
6		
7		
8		
9		
10		
11		
12		
13	VLAN ID (ANI) (2 bytes)	Duration (2 bytes)
14		
15	VLAN ID (UNI) (2 bytes)	Time left (2 bytes)
16		
17		
18		
19		
20		
21		
22		

Figure 9.3.28-1 – Allowed preview groups row part formats

Row part 0 format:

- Table control (2 bytes)
- Source IP address. This field specifies the source IP address of the allowed preview group. May be either an IPv4 address (first 12 bytes 0) or an IPv6 address. (16 bytes)
- VLAN ID (ANI). This field specifies the VLAN carrying the multicast group downstream. The VLAN ID resides in the 12 LSBs; the remaining bits are set to 0 and not used. The value 0 designates an untagged downstream flow. (2 bytes)
- VLAN ID (UNI). This field specifies the VLAN carrying IGMP/MLD messages upstream across the UNI. The VLAN ID resides in the 12 LSBs; the remaining bits are set to 0 and not used. The value 0 designates an untagged upstream flow. (2 bytes)

Row part 1 format:

- Table control (2 bytes)
- Destination IP address. This field specifies the destination IP address of the allowed preview group. May be either an IPv4 address (first twelve bytes 0) or an IPv6 address. (16 bytes)

- Duration – This field indicates the static length of time in minutes for which the group is authorized. The value 0 designates unlimited authorization. (2 bytes)
- Time left – This field is controlled by the ONU (ignored during a set operation from the OLT). It indicates how much time (measured in minutes) remains in the authorization. The ONU counts down; when this field reaches zero, the ONU deletes the entire entry from the table and stops replicating the group to the UNI. If the duration field specifies unlimited authorization, this field is ignored. The OLT may extend (or even truncate) the authorization by writing a new value into the duration field; the difference between new and old duration values is added to the time left field. (2 bytes)

(R, W) (optional) (Each row part: 22 bytes)

Actions

Create, delete, get, get next, set

Set table (optional)

Notifications

None.

9.3.29 Multicast subscriber monitor

This ME provides the current status of each port with respect to its multicast subscriptions. It may be useful for status monitoring or debugging purposes. The status table includes all dynamic groups currently subscribed by the port.

Relationships

Instances of this ME are created and deleted at the request of the OLT. One instance may exist for each IEEE 802.1 UNI configured to support multicast subscription.

Attributes

Managed entity ID: This attribute uniquely identifies each instance of this ME. Through an identical ID, this ME is implicitly linked to an instance of the MAC bridge port configuration data or IEEE 802.1p mapper ME. (R, set-by-create) (mandatory) (2 bytes)

ME type: This attribute indicates the type of the ME implicitly linked by the ME ID attribute.

0 MAC bridge port config data

1 IEEE 802.1p mapper service profile

(R, W, set-by-create) (mandatory) (1 byte)

Current multicast bandwidth: This attribute is the ONU's (BE) estimate of the actual bandwidth currently being delivered to this particular MAC bridge port over all dynamic multicast groups. (R) (optional) (4 bytes)

Join messages counter: This attribute counts the number of times the corresponding subscriber sent a join message that was accepted. When full, the counter rolls over to 0. (R) (optional) (4 bytes)

Bandwidth exceeded counter: This attribute counts the number of join messages that did exceed, or would have exceeded, the max multicast bandwidth, whether

accepted or denied. When full, the counter rolls over to 0. (R) (optional) (4 bytes)

IPv4 active group list table: This attribute lists the groups from one of the related dynamic access control list tables or the allowed preview groups table that are currently being actively forwarded, along with the actual bandwidth of each. If a join has been recognized from more than one IPv4 source address for a given group on this UNI, there will be one table entry for each. Each table entry has the following form.

- VLAN ID, 0 if not used (2 bytes)
- Source IP address, 0.0.0.0 if not used (4 bytes)
- Multicast destination IP address (4 bytes)
- Best efforts actual bandwidth estimate, bytes per second (4 bytes)
- Client (set-top box) IP address, i.e., the IP address of the device currently joined (4 bytes)
- Time since the most recent join of this client to the IP channel, in seconds (4 bytes)
- Reserved (2 bytes)

(R) (mandatory) (24N bytes)

IPv6 active group list table: This attribute lists the groups from one of the related dynamic access control list tables or the allowed preview groups table that are currently being actively forwarded, along with the actual bandwidth of each. If a join has been recognized from more than one IPv6 source address for a given group on this UNI, there will be one table entry for each. In mixed IPv4-IPv6 scenarios, it is possible that some fields might be IPv4, in which case their 12 most significant bytes of the given field are set to zero. Each table entry has the form:

- VLAN ID, 0 if not used (2 bytes)
- Source IP address, 0 if not used (16 bytes)
- Multicast destination IP address (16 bytes)
- Best efforts actual bandwidth estimate, bytes per second (4 bytes)
- Client (set-top box) IP address, i.e., the IP address of the device currently joined (16 bytes)
- Time since the most recent join of this client to the IP channel, in seconds (4 bytes)

(R) (optional) (58N bytes)

Actions

Create, delete, get, get next, set

Notifications

None.

9.3.30 Ethernet frame performance monitoring history data upstream

This ME collects PM data associated with upstream Ethernet frame delivery. It is based on the Etherstats group of [IETF RFC 2819]. Instances of this ME are created and deleted by the OLT.

For a complete discussion of generic PM architecture, refer to clause I.4.

NOTE 1 – Implementers are encouraged to consider the Ethernet frame extended PM ME defined in clause 9.3.32, which collects the same counters in a more generalized way.

Relationships

An instance of this ME is associated with an instance of a MAC bridge port configuration data.

Attributes

Managed entity ID: This attribute uniquely identifies each instance of this ME. Through an identical ID, this ME is implicitly linked to an instance of a MAC bridge port configuration data. (R, set-by-create) (mandatory) (2 bytes)

Interval end time: This attribute identifies the most recently finished 15 min interval. (R) (mandatory) (1 byte)

Threshold data 1/2 ID: This attribute points to an instance of the threshold data 1 ME that contains PM threshold values. Since no threshold value attribute number exceeds 7, a threshold data 2 ME is optional. (R, W, set-by-create) (mandatory) (2 bytes)

Drop events: The total number of events in which packets were dropped due to a lack of resources. This is not necessarily the number of packets dropped; it is the number of times this event was detected. (R) (mandatory) (4 bytes)

Octets: The total number of upstream octets received, including those in bad packets, excluding framing bits, but including FCS. (R) (mandatory) (4 bytes)

Packets: The total number of upstream packets received, including bad packets, broadcast packets and multicast packets. (R) (mandatory) (4 bytes)

Broadcast packets: The total number of upstream good packets received that were directed to the broadcast address. This does not include multicast packets. (R) (mandatory) (4 bytes)

Multicast packets: The total number of upstream good packets received that were directed to a multicast address. This does not include broadcast packets. (R) (mandatory) (4 bytes)

CRC errored packets: The total number of upstream packets received that had a length (excluding framing bits, but including FCS octets) of between 64 octets and 1518 octets, inclusive, but had either a bad FCS with an integral number of octets (FCS error) or a bad FCS with a non-integral number of octets (alignment error). (R) (mandatory) (4 bytes)

Undersize packets: The total number of upstream packets received that were less than 64 octets long, but were otherwise well formed (excluding framing bits, but including FCS). (R) (mandatory) (4 bytes)

Oversize packets: The total number of upstream packets received that were longer than 1518 octets (excluding framing bits, but including FCS) and were otherwise well formed. (R) (mandatory) (4 bytes)

NOTE 2 – If 2 000 byte Ethernet frames are supported, counts in this performance parameter are not necessarily errors.

Packets 64 octets: The total number of upstream received packets (including bad packets) that were 64 octets long, excluding framing bits but including FCS. (R) (mandatory) (4 bytes)

Packets 65 to 127 octets: The total number of upstream received packets (including bad packets) that were 65..127 octets long, excluding framing bits but including FCS. (R) (mandatory) (4 bytes)

Packets 128 to 255 octets: The total number of upstream packets (including bad packets) received that were 128..255 octets long, excluding framing bits but including FCS. (R) (mandatory) (4 bytes)

Packets 256 to 511 octets: The total number of upstream packets (including bad packets) received that were 256..511 octets long, excluding framing bits but including FCS. (R) (mandatory) (4 bytes)

Packets 512 to 1023 octets: The total number of upstream packets (including bad packets) received that were 512..1 023 octets long, excluding framing bits but including FCS. (R) (mandatory) (4 bytes)

Packets 1024 to 1518 octets: The total number of upstream packets (including bad packets) received that were 1024..1518 octets long, excluding framing bits, but including FCS. (R) (mandatory) (4 bytes)

Actions

Create, delete, get, set

Get current data (optional)

Notifications

Threshold crossing alert

Alarm number	Threshold crossing alert	Threshold data counter No. (Note)
0	Drop events	1
1	CRC errored packets	2
2	Undersize packets	3
3	Oversize packets	4

NOTE – This number associates the TCA with the specified threshold value attribute of the threshold data 1 managed entity.

9.3.31 Ethernet frame performance monitoring history data downstream

This ME is identical to the Ethernet frame PM history data upstream ME, with the exception that it monitors downstream traffic.

9.3.32 Ethernet frame extended PM

This ME collects some of the PM data at a point where an Ethernet flow can be observed. It is based on the Etherstats group of [IETF RFC 2819]. Instances of this ME are created and deleted by the OLT. References to received frames are to be interpreted as the number of frames entering the monitoring point in the direction specified by the control block.

For a complete discussion of generic PM architecture, refer to clause I.4.

Relationships

An instance of this ME may be associated with an instance of an ME at any Ethernet interface within the ONU. The specific ME is identified in the control block attribute.

Attributes

Managed entity ID: This attribute uniquely identifies each instance of this ME. To facilitate discovery, the identification of instances sequentially starting with 1 is encouraged. (R, set-by-create) (mandatory) (2 bytes)

Interval end time: This attribute identifies the most recently finished 15 min interval. If continuous accumulation is enabled in the control block, this attribute is not used and has the fixed value 0. (R) (mandatory) (1 byte)

Control Block: This attribute contains fields defined as follows.+

Threshold data 1/2 ID: (2 bytes) This attribute points to an instance of the threshold data 1 ME that contains PM threshold values. Since no threshold value attribute number exceeds 7, a threshold data 2 ME is optional. When PM is collected on a continuously running basis, rather than in 15 min intervals, counter thresholds should not be established. There is no mechanism to clear a TCA, and any counter parameter may eventually be expected to cross any given threshold value.

Parent ME class: (2 bytes) This field contains the enumerated value of the ME class of the PM ME's parent. Together with the parent ME instance field, this permits a given PM ME to be associated with any OMCI ME. The supported ME classes are as follows.

- 46 MAC bridge configuration data
- 47 MAC bridge port configuration data
- 11 Physical path termination point Ethernet UNI
- 98 Physical path termination point xDSL UNI part 1
- 266 GEM IW termination point
- 281 Multicast GEM IW termination point
- 329 Virtual Ethernet interface point
- 162 Physical path termination point MoCA UNI

Parent ME instance: (2 bytes) This field identifies the specific parent ME instance to which the PM ME is attached.

Accumulation disable: (2 bytes) This bit field allows PM accumulation to be disabled; refer to Table 9.3.32-1. The default value 0 enables PM collection. If bit 15 is set to 1, no PM is collected by this ME instance. If bit 15 = 0 and any of bits 14..1 are set to 1, PM collection is inhibited for the attributes indicated by the 1 bits. Inhibiting PM collection does not change the value of a PM attribute, but if PM is accumulated in 15 min intervals, the value is lost at the next 15 min interval boundary.

Bit 16 is an action bit that always reads back as 0. When written to 1, it resets all PM attributes in the ME, and clears any TCAs that may be outstanding.

Table 9.3.32-1 – Bit assignments in extended PM control block

Bit	16	15	14	13	3	2	1 (LSB)
Accumulation disable	Global clear	Global disable	PM14	PM2	PM1
TCA disable		Global disable	Th14	Th2	Th1

TCA disable: (2 bytes). Also clarified in Table 9.3.32-1, this field permits TCAs to be inhibited, either individually or for the complete ME instance. As with the accumulation disable field, the default value 0 enables TCAs, and setting the global disable bit overrides the settings of the individual thresholds. Unlike the accumulation disable field, the bits are mapped to the thresholds

defined in the associated threshold data 1 and 2 ME instances. When the global or attribute-specific value changes from 0 to 1, outstanding TCAs are cleared, either for the ME instance globally or for the individual disabled threshold. These bits affect only notifications, not the underlying parameter accumulation or storage.

If the threshold data 1/2 ID attribute does not contain a valid pointer, this field is not meaningful.

Thresholds should be used with caution if PM attributes are accumulated continuously.

Control fields: (2 bytes). This field is a bit map whose values govern the behaviour of the PM ME. Bits are assigned as follows.

- Bit 1 (LSB) The value 1 specifies continuous accumulation, regardless of 15 min intervals. There is no concept of current and historical accumulators; get and get current data (if supported) both return current values. The value 0 specifies 15 min accumulators exactly like those of classical PM.
- Bit 2 This bit indicates directionality for the collection of data. The value 0 indicates that data are to be collected for upstream traffic. The value 1 indicates that data are to be collected for downstream traffic.
- Bits 3..14 Reserved, should be set to 0 by the OLT and ignored by the ONU.
- Bit 15 When this bit is 1, the P bits of the TCI field are used to filter the PM data collected. The value 0 indicates that PM is collected without regard to P bits.
- Bit 16 When this bit is 1, the VID bits of the TCI field are used to filter the PM data collected. The value 0 indicates that PM is collected without regard to VID.

TCI: (2 bytes). This field contains the value optionally used as a filter for the PM data collected, under the control of bits 15..16 of the control fields. This value is matched to the outer tag of a frame. Untagged frames are not counted when this field is used.

Reserved: (2 bytes). Not used; should be set to 0 by the OLT and ignored by the ONU.

(R, W, set-by-create) (mandatory) (16 bytes)

Drop events: The total number of events in which frames were dropped due to a lack of resources. This is not necessarily the number of frames dropped; it is the number of times this event was detected. (R) (mandatory) (4 bytes)

Octets: The total number of octets received, including those in bad frames, excluding framing bits, but including FCS. (R) (mandatory) (4 bytes)

Frames: The total number of frames received, including bad frames, broadcast frames and multicast frames. (R) (mandatory) (4 bytes)

Broadcast frames: The total number of received good frames directed to the broadcast address. This does not include multicast frames. (R) (mandatory) (4 bytes)

Multicast frames: The total number of received good frames directed to a multicast address. This does not include broadcast frames. (R) (mandatory) (4 bytes)

CRC errored frames: The total number of frames received that had a length (excluding framing bits, but including FCS octets) of between 64 and 1518 octets, inclusive, but had either a bad FCS with an integral number of octets (FCS error) or a bad FCS with a non-integral number of octets (alignment error). (R) (mandatory) (4 bytes)

Undersize frames: The total number of frames received that were less than 64 octets long but were otherwise well formed (excluding framing bits, but including FCS octets). (R) (mandatory) (4 bytes)

Oversize frames: The total number of frames received that were longer than 1518 octets (excluding framing bits, but including FCS octets) and were otherwise well formed. (R) (mandatory) (4 bytes)

Frames 64 octets: The total number of received frames (including bad frames) that were 64 octets long, excluding framing bits but including FCS. (R) (mandatory) (4 bytes)

Frames 65 to 127 octets: The total number of received frames (including bad frames) that were 65..127 octets long, excluding framing bits but including FCS. (R) (mandatory) (4 bytes)

Frames 128 to 255 octets: The total number of frames (including bad frames) received that were 128..255 octets long, excluding framing bits but including FCS. (R) (mandatory) (4 bytes)

Frames 256 to 511 octets: The total number of frames (including bad frames) received that were 256..511 octets long, excluding framing bits but including FCS. (R) (mandatory) (4 bytes)

Frames 512 to 1 023 octets: The total number of frames (including bad frames) received that were 512..1 023 octets long, excluding framing bits but including FCS. (R) (mandatory) (4 bytes)

Frames 1024 to 1518 octets: The total number of frames (including bad frames) received that were 1024..1518 octets long, excluding framing bits but including FCS. (R) (mandatory) (4 bytes)

Actions

Create, delete, get, set

Get current data (optional)

Notifications

Threshold crossing alert

Alarm number	Threshold crossing alert	Threshold data counter No. (Note)
1	Drop events	1
2	CRC errored frames	2
3	Undersize frames	3
4	Oversize frames	4

NOTE – This number associates the TCA with the specified threshold value attribute of the threshold data 1 managed entity.

9.3.33 MAC bridge port ICMPv6 process pre-assign table

This ME provides an approach to ICMPv6 message processing configuration to those ONUs that support IPv6 awareness. For every message, the MAC bridge port ICMPv6 process pre-assign table can designate a forward, discard or snoop operation. The ONU creates or deletes an instance of this ME automatically upon creation or deletion of a MAC bridge port configuration data ME.

The MAC bridge port ICMPv6 process pre-assign table ME filters layer 2 traffic between the UNI and ANI. The operation of this ME is completely independent of the operation and traffic generated or received by a possible IPv6 host config data ME.

Relationships

An instance of this ME is associated with an instance of a MAC bridge port configuration data ME.

Attributes

Managed entity ID: This attribute uniquely identifies each instance of this ME. Through an identical ID, this ME is implicitly linked to an instance of the MAC bridge port configuration data ME. (R) (mandatory) (2 bytes)

The following nine attributes have similar definitions. Each permits the OLT to specify ICMPv6 as the next header in the IPv6 header and various types in the ICMPv6 header, and whether traffic of the specified type is forwarded, discarded or snooped, in upstream and downstream directions separately. The bits of each attribute are assigned as follows.

Bit	Name	Setting
1..2 (LSB)	Process for upstream	00: forward 01: discard 10: snoop
3..4	Process for downstream	00: forward 01: discard 10: snoop
5..8	Reserved	0

The initial value of each attribute is given in the last column of the table.

No.	Protocol	Next header	type	Standard	Initial value
1	ICMPv6 error messages	58	1-4	[b-IETF RFC 2460] [b-IETF RFC 2463]	0
2	ICMPv6 informational messages	58	128,129	[b-IETF RFC 2460] [b-IETF RFC 2463]	0
3	Neighbour discovery router solicitation	58	133	[b-IETF RFC 2460] [b-IETF RFC 4861]	6
4	Neighbour discovery – router advertisement	58	134	[b-IETF RFC 2460] [b-IETF RFC 4861]	9
5	Neighbour discovery – neighbour solicitation	58	135	[b-IETF RFC 2460] [b-IETF RFC 4861]	0

No.	Protocol	Next header	type	Standard	Initial value
6	Neighbour discovery – neighbour advertisement	58	136	[b-IETF RFC 2460] [b-IETF RFC 4861]	0
7	Neighbour discovery – redirect	58	137	[b-IETF RFC 2460] [b-IETF RFC 4861]	1
8	MLD – Multicast listener query (MLDv1, MLDv2)	58	130	[b-IETF RFC 2710] [IETF RFC 3810]	1
9	Unknown ICMPv6	58	–	–	5

ICMPv6 error messages processing: (R, W) (mandatory) (1 byte)

ICMPv6 informational messages processing: (R, W) (mandatory) (1 byte)

Router solicitation processing: (R, W) (mandatory) (1 byte)

Router advertisement processing: (R, W) (mandatory) (1 byte)

Neighbour solicitation processing: (R, W) (mandatory) (1 byte)

Neighbour advertisement processing: (R, W) (mandatory) (1 byte)

Redirect processing: (R, W) (mandatory) (1 byte)

Multicast listener query processing: (R, W) (mandatory) (1 byte)

NOTE – If the ONU participates in multicast services, MLD queries should be controlled through the multicast operations profile ME. In such a case, it is strongly recommended not to provision the downstream direction of the multicast listener query processing attribute to any value other than forwarding.

Unknown ICMPv6 processing: (R, W) (mandatory) (1 byte)

Actions

Get, set.

9.3.34 Ethernet frame extended PM 64 bit

This ME collects some of the PM data at a point where an Ethernet flow can be observed. It is based on the Etherstats group of [IETF RFC 2819] and [IETF RFC 2863]. Instances of this ME are created and deleted by the OLT. References to received frames are to be interpreted as the number of frames entering the monitoring point in the direction specified by the control block.

For a complete discussion of generic PM architecture, refer to clause I.4.

Relationships

An instance of this ME may be associated with an instance of an ME at any Ethernet interface within the ONU. The specific ME is identified in the control block attribute.

Attributes

Managed entity ID: This attribute uniquely identifies each instance of this ME. To facilitate discovery, it is encouraged to identify instances sequentially starting with 1. (R, set-by-create) (mandatory) (2 bytes)

Interval end time: This attribute identifies the most recently finished 15 min interval. If continuous accumulation is enabled in the control block, this attribute is not used and has the fixed value 0. (R) (mandatory) (1 byte)

Control block: This attribute contains fields defined as follows.

Threshold data 64 bit ID: (2 bytes). This attribute points to an instance of the threshold data 64-bit ME that contains PM threshold values. When PM is collected on a continuously running basis, rather than in 15 min intervals, counter thresholds should not be established. There is no mechanism to clear a TCA, and any counter parameter may eventually be expected to cross any given threshold value.

Parent ME class: (2 bytes). This field contains the enumerated value of the ME class of the PM ME's parent. Together with the parent ME instance field, this permits a given PM ME to be associated with any OMCI ME. The supported ME classes are as follows.

- 46 MAC bridge configuration data
- 47 MAC bridge port configuration data
- 11 Physical path termination point Ethernet UNI
- 98 Physical path termination point xDSL UNI part 1
- 266 GEM IW termination point
- 281 Multicast GEM IW termination point
- 329 Virtual Ethernet interface point
- 162 Physical path termination point MoCA UNI

Parent ME instance: (2 bytes). This field identifies the specific parent ME instance to which the PM ME is attached.

Accumulation disable: (2 bytes). This bit field allows PM accumulation to be disabled; refer to Table 9.3.32-1. The default value 0 enables PM collection. If bit 15 is set to 1, no PM is collected by this ME instance. If bit 15 = 0 and any of bits 14..1 are set to 1, PM collection is inhibited for the attributes indicated by the 1 bits. Inhibiting PM collection does not change the value of a PM attribute, but if PM is accumulated in 15 min intervals, the value is lost at the next 15 min interval boundary.

Bit 16 is an action bit that always reads back as 0. When written to 1, it resets all PM attributes in the ME, and clears any TCAs that may be outstanding.

TCA disable: (2 bytes). Also clarified in Table 9.3.32-1, this field permits TCAs to be inhibited, either individually or for the complete ME instance. As with the accumulation disable field, the default value 0 enables TCAs, and setting the global disable bit overrides the settings of the individual thresholds. Unlike the accumulation disable field, the bits are mapped to the thresholds defined in the associated threshold data 1 and 2 ME instances. When the global or attribute-specific value changes from 0 to 1, outstanding TCAs are cleared, either for the ME instance globally or for the individual disabled threshold. These bits affect only notifications, not the underlying parameter accumulation or storage.

If the threshold data [64 bit+2 ID](#) attribute does not contain a valid pointer, this field is not meaningful.

Thresholds should be used with caution if PM attributes are accumulated continuously.

Control fields: (2 bytes). This field is a bit map whose values govern the behaviour of the PM ME. Bits are assigned as follows:

- Bit 1 (LSB) The value 1 specifies continuous accumulation, regardless of 15 min intervals. There is no concept of current and

historic accumulators; get and get current data (if supported) both return current values. The value 0 specifies 15 min accumulators exactly like those of classical PM.

- Bit 2 This bit indicates directionality for the collection of data. The value 0 indicates that data are to be collected for upstream traffic. The value 1 indicates that data are to be collected for downstream traffic.
- Bits 3..14 Reserved, should be set to 0 by the OLT and ignored by the ONU.
- Bit 15 When this bit is 1, the P bits of the TCI field are used to filter the PM data collected. The value 0 indicates that PM is collected without regard to P bits.
- Bit 16 When this bit is 1, the VID bits of the TCI field are used to filter the PM data collected. The value 0 indicates that PM is collected without regard to VID.

TCI: (2 bytes). This field contains the value optionally used as a filter for the PM data collected, under the control of bits 15..16 of the control fields. This value is matched to the outer tag of a frame. Untagged frames are not counted when this field is used.

Reserved: (2 bytes). Not used; should be set to 0 by the OLT and ignored by the ONU.

(R, W, set-by-create) (mandatory) (16 bytes)

Drop events: The total number of events in which frames were dropped due to lack of resources. This is not necessarily the number of frames dropped; it is the number of times this event was detected. (R) (mandatory) (8 bytes)

Octets: The total number of octets received, including those in bad frames, excluding framing bits, but including FCS. (R) (mandatory) (8 bytes)

Frames: The total number of frames received, including bad frames, broadcast frames and multicast frames. (R) (mandatory) (8 bytes)

Broadcast frames: The total number of received good frames directed to the broadcast address. This does not include multicast frames. (R) (mandatory) (8 bytes)

Multicast frames: The total number of received good frames directed to a multicast address. This does not include broadcast frames. (R) (mandatory) (8 bytes)

CRC errored frames: The total number of frames received that had a length (excluding framing bits, but including FCS octets) of between 64 and 1518 octets, inclusive, but had either a bad FCS with an integral number of octets (FCS error) or a bad FCS with a non-integral number of octets (alignment error). (R) (mandatory) (8 bytes)

Undersize frames: The total number of frames received that were less than 64 octets long, but were otherwise well formed (excluding framing bits, but including FCS octets). (R) (mandatory) (8 bytes)

Oversize frames: The total number of frames received that were longer than 1518 octets (excluding framing bits, but including FCS octets) and were otherwise well formed. (R) (mandatory) (8 bytes)

Frames 64 octets: The total number of received frames (including bad frames) that were 64 octets long, excluding framing bits, but including FCS. (R) (mandatory) (8 bytes)

Frames 65 to 127 octets: The total number of received frames (including bad frames) that were 65..127 octets long, excluding framing bits but including FCS. (R) (mandatory) (8 bytes)

Frames 128 to 255 octets: The total number of frames (including bad frames) received that were 128..255 octets long, excluding framing bits but including FCS. (R) (mandatory) (8 bytes)

Frames 256 to 511 octets: The total number of frames (including bad frames) received that were 256..511 octets long, excluding framing bits but including FCS. (R) (mandatory) (8 bytes)

Frames 512 to 1023 octets: The total number of frames (including bad frames) received that were 512..1023 octets long, excluding framing bits but including FCS. (R) (mandatory) (8 bytes)

Frames 1024 to 1518 octets: The total number of frames (including bad frames) received that were 1024..1518 octets long, excluding framing bits but including FCS. (R) (mandatory) (8 bytes)

Actions

Create, delete, get, set

Get current data (optional)

Notifications

Threshold crossing alert

Alarm number	Threshold crossing alert	Threshold data counter No. (Note)
1	Drop events	1
2	CRC errored frames	2
3	Undersize frames	3
4	Oversize frames	4

NOTE – This number associates the TCA with the specified threshold value attribute of the `"threshold data +64 bit"` managed entity (see clause 9.12.17).

9.3.35 Link aggregation service profile

This ME organizes data associated with a link aggregation group (LAG) in PON channel bonding. The OLT creates one instance of this managed entity for each channel bonding LAG.

Relationships

One instance of this managed entity exists for each LAG. An instance of this managed entity is associated with one or more instances of MAC bridge port configuration data. An instance of this managed entity is associated with one instances of MAC bridge service profile.

Attributes

Managed entity ID: This attribute uniquely identifies each instance of this managed entity. Its value is created by the OLT. (R, set-by-create) (mandatory) (2 bytes)

Frame distribution and collection mode: This attribute indicates the frame distribution and collection mode supported on this LAG. Valid values are:

- 1 Per-service frame distribution. This mode distributes frames to the bonded links according to their service identifier. The algorithm is specified in IEEE 802.1AX clause 8.
- 2 Round-robin frame distribution. This mode distributes frames to the bonded links in circular order.

(R, W, set-by-create) (mandatory) (1 byte)

Type: This attribute indicates the LASP ME type. Valid values are:

- 0 ANI-G interface channel bonding.
- 1 UNI-G interface channel bonding.

(R, W, Set-by-create) (mandatory) (1 byte)

MAC bridge service profile ID pointer: This attribute points to an instance of the MAC bridge service profile ME. (R, W, set-by-create) (mandatory) (2 bytes)

Actions

Create, delete, get, set

Notifications

None.

9.4 Layer 3 data services

9.4.1 IP host config data

The IP host config data configures IPv4 based services offered on the ONU. The ONU automatically creates instances of this ME if IP host services are available. A possible IPv6 stack is supported through the IPv6 host config data ME. In this clause, references to IP addresses are understood to mean IPv4.

Relationships

An instance of this ME is associated with the ONU ME. Any number of TCP/UDP config data MEs can point to the IP host config data, to model any number of ports and protocols. Performance may be monitored through an implicitly linked IP host PM history data ME.

Attributes

Managed entity ID: This attribute uniquely identifies each instance of this ME. The ONU creates as many instances as there are independent IPv4 stacks on the ONU. To facilitate discovery, IP host config data MEs should be numbered from 0 upwards. The ONU should create IP(v4) and IPv6 host config data MEs with separate ME IDs, such that other MEs can use a single TP type attribute to link with either. (R) (mandatory) (2 bytes)

IP options: This attribute is a bit map that enables or disables IP-related options. The value 1 enables the option while 0 disables it. The default value of this attribute is 0.

- | | |
|------------|--------------------------------|
| 0x01 | Enable DHCP |
| 0x02 | Respond to pings |
| 0x04 | Respond to traceroute messages |
| 0x08 | Enable IP stack |
| 0x10..0x80 | Reserved |

(R, W) (mandatory) (1 byte)

MAC address: This attribute indicates the MAC address used by the IP node. (R) (mandatory) (6 bytes)

Onu identifier: A unique ONU identifier string. If set to a non-null value, this string is used instead of the MAC address in retrieving dynamic host configuration protocol (DHCP) parameters. If the string is shorter than 25 characters, it must be null terminated. Its default value is 25 null bytes. (R, W) (mandatory) (25 bytes)

Several attributes of this ME may be paired together into two categories, manual settings and current values.

Manual settings	Current values
IP address	Current address
Mask	Current mask
Gateway	Current gateway
Primary DNS	Current primary DNS
Secondary DNS	Current secondary DNS

While the IP stack is disabled, there is no IP connectivity to the external world from this ME instance.

While DHCP is disabled, the current values are always the same as the manual settings. While DHCP is enabled, the current values are those assigned by DHCP, or undefined (0) if DHCP has never assigned values.

IP address: The address used for IP host services; this attribute has the default value 0. (R, W) (mandatory) (4 bytes)

Mask: The subnet mask for IP host services; this attribute has the default value 0. (R, W) (mandatory) (4 bytes)

Gateway: The default gateway address used for IP host services; this attribute has the default value 0. (R, W) (mandatory) (4 bytes)

Primary DNS: The address of the primary DNS server; this attribute has the default value 0. (R, W) (mandatory) (4 bytes)

Secondary DNS: The address of the secondary DNS server; this attribute has the default value 0. (R, W) (mandatory) (4 bytes)

Current address: Current address of the IP host service. (R) (optional) (4 bytes)

Current mask: Current subnet mask for the IP host service. (R) (optional) (4 bytes)

Current gateway: Current default gateway address for the IP host service. (R) (optional) (4 bytes)

Current primary DNS: Current primary DNS server address. (R) (optional) (4 bytes)

Current secondary DNS: Current secondary DNS server address. (R) (optional) (4 bytes)

Domain name: If DHCP indicates a domain name, it is presented here. If no domain name is indicated, this attribute is set to a null string. If the string is shorter than 25 bytes, it must be null terminated. The default value is 25 null bytes. (R) (mandatory) (25 bytes)

Host name: If DHCP indicates a host name, it is presented here. If no host name is indicated, this attribute is set to a null string. If the string is shorter than 25 bytes, it must be null terminated. The default value is 25 null bytes. (R) (mandatory) (25 bytes)

Relay agent options: This attribute is a pointer to a large string ME whose content specifies one or more DHCP relay agent options. (R, W) (optional) (2 bytes)

The contents of the large string are parsed by the ONU and converted into text strings. Variable substitution is based on defined three-character groups, each of which begins with the '%' character. The string '%%' is an escape mechanism whose output is a single '%' character. When the ONU cannot perform variable substitution on a substring of the large string, it generates the specified option as an exact quotation of the provisioned substring value.

Provisioning of the large string is separate from the operation of setting the pointer in this attribute. It is the responsibility of the OLT to ensure that the large string contents are correct and meaningful.

Three-character variable definitions are as follows. The first variable in the large string must specify one of the option types. Both options for a given IP version may be present if desired, each introduced by its option identifier. Terminology is taken from clause 3.9.3 of [b-BBF TR-101].

%01, %18

Specifies that the following string is for option 82 sub-option 1, agent circuit-ID (IPv4) or option 18, interface-ID (IPv6). The equivalence permits the same large string to be used in both IP environments.

%02, %37

Specifies that the following string is for option 82 sub-option 2, relay agent remote-ID (IPv4) or option 37, relay agent remote-ID (IPv6). The equivalence permits the same large string to be used in both IP environments.

%SL

In [b-BBF TR-101], this is called a slot. In an ONU, this variable refers to a shelf. It would be meaningful if the ONU has multiple shelves internally or is daisy-chained to multiple equipment modules. The range of this variable is "0".. "99"

%SU

In TR-101, this is called a sub-slot. In fact, it represents a cardholder. The range of this variable is "0".. "99"

%PO

UNI port number. The range of this variable is "0".. "999"

%AE

ATM or Ethernet. This variable can take on the values "atm" or "eth".

%SV

S-VID for Ethernet UNI, or ATM virtual path identifier (VPI) for ATM UNI, as it exists on the DHCP request received upstream across the UNI. Range "0".. "4096" for S-VID; range "0".. "255" for VPI. The value "4096" indicates no S-VID tag.

%CV

C-VID (Q-VID) for Ethernet UNI, or ATM virtual circuit identifier (VCI) for ATM UNI, as it exists on the DHCP request received upstream across the UNI. Range "0".. "4096" for C-VID; range "0".. "65535" for VCI. The value "4096" indicates no C-VID tag.

Spaces in the provisioned string are significant.

Example: if the large string were provisioned with the value

%01%SL/%SU/%PO:%AE/%SV.%CV<null>,</p></div>

then the ONU would generate the following DHCP option 82 agent circuit-ID string for an Ethernet UNI that sent a DHCP request with no S tag and C tag = 3210 on shelf 2, slot 3, port 4.

2/3/4:eth/4096.3210

With the same provisioning, the ONU would generate the following DHCP option 82 agent circuit-ID string for an ATM UNI that sent a DHCP request on VPI = 123 and VCI = 4567 on shelf 2, slot 3, port 4.

2/3/4:atm/123.4567

Actions

Get, set

Test: Invoke an Internet control message protocol (ICMP) message from this IP host. The test message can be configured to generate a ping or traceroute. Annex A defines the test, test response and test result messages.

Notifications

Attribute value change

Number	Attribute value change	Description
1..8	N/A	
9	Current address	The new value assigned via DHCP
10	Current mask	The new value assigned via DHCP
11	Current gateway	The new value assigned via DHCP
12	Current primary DNS	The new value assigned via DHCP
13	Current secondary DNS	The new value assigned via DHCP
14	Domain name	The new value assigned via DHCP
15	Host name	The new value assigned via DHCP
16	Reserved	

9.4.2 IP host performance monitoring history data

This ME collects PM data related to an IP host. Instances of this ME are created and deleted by the OLT.

For a complete discussion of generic PM architecture, refer to clause I.4.

Relationships

An instance of this ME is associated with an instance of the IP host config data or IPv6 host config data ME.

Attributes

Managed entity ID: This attribute uniquely identifies each instance of this ME. Through an identical ID, this ME is implicitly linked to an instance of the IP host configuration data or IPv6 host configuration data ME. (R, set-by-create) (mandatory) (2 bytes)

Interval end time: This attribute identifies the most recently finished 15 min interval. (R) (mandatory) (1 byte)

Threshold data 1/2 ID: This attribute points to an instance of the threshold data 1 ME that contains PM threshold values. Since no threshold value attribute number exceeds 7, a threshold data 2 ME is optional. (R, W, set-by-create) (mandatory) (2 bytes)

ICMP errors: This attribute counts ICMP errors received. (R) (mandatory) (4 bytes)

DNS errors: This attribute counts DNS errors received. (R) (mandatory) (4 bytes)

DHCP timeouts: This attribute counts DHCP timeouts. (R) (optional) (2 bytes)

IP address conflict: This attribute is incremented whenever the ONU detects a conflicting IP address on the network. A conflicting IP address is one that has the same value as the one currently assigned to the ONU. (R) (optional) (2 bytes)

Out of memory: This attribute is incremented whenever the ONU encounters an out of memory condition in the IP stack. (R) (optional) (2 bytes)

Internal error: This attribute is incremented whenever the ONU encounters an internal error condition such as a driver interface failure in the IP stack. (R) (optional) (2 bytes)

Actions

Create, delete, get, set

Get current data (optional)

Notifications

Threshold crossing alert

Alarm number	Threshold crossing alert	Threshold value attribute No. (Note)
1	IPNPM ICMP error	1
2	IPNPM DNS error	2
3	DHCP timeout	3
4	IP address conflict	4
5	Out of memory	5
6	Internal error	6

NOTE – This number associates the TCA with the specified threshold value attribute of the threshold data 1 managed entity.

9.4.3 TCP/UDP config data

The TCP/UDP config data ME configures services based on the transmission control protocol (TCP) and user datagram protocol (UDP) that are offered from an IP host. If a non-OMCI interface is used to manage an IP service, this ME is unnecessary; the non-OMCI interface supplies the necessary data.

An instance of this ME is created and deleted on request of the OLT.

Relationships

One or more instances of this ME may be associated with an instance of an IP host config data or IPv6 host config data ME.

Attributes

Managed entity ID: This attribute uniquely identifies each instance of this ME. It is recommended that the ME ID be the same as the port number. (R, set-by-create) (mandatory) (2 bytes)

Port ID: This attribute specifies the port number that offers the TCP/UDP service. (R, W, set-by-create) (mandatory) (2 bytes)

Protocol: This attribute specifies the protocol type as defined by [b-IANA] (protocol numbers), for example UDP (0x11). (R, W, set-by-create) (mandatory) (1 byte)

TOS/diffserv field: This attribute specifies the value of the TOS/diffserv field of the IPv4 header. The contents of this attribute may contain the type of service per [IETF RFC 2474] or a DSCP. Valid values for DSCP are as defined by [b-IANA] (differentiated services field code points). (R, W, set-by-create) (mandatory) (1 byte)

IP host pointer: This attribute points to the IP host config data or IPv6 host config data ME associated with this TCP/UDP data. Any number of ports and protocols may be associated with an IP host. (R, W, set-by-create) (mandatory) (2 bytes)

Actions

Create, delete, get, set

Notifications

None.

9.4.4 TCP/UDP performance monitoring history data

This ME collects PM data related to a TCP or UDP port. Instances of this ME are created and deleted by the OLT.

For a complete discussion of generic PM architecture, refer to clause I.4.

Relationships

An instance of this ME is associated with an instance of the TCP/UDP config data ME.

Attributes

Managed entity ID: This attribute uniquely identifies each instance of this ME. Through an identical ID, this ME is implicitly linked to an instance of the TCP/UDP config data ME. (R, set-by-create) (mandatory) (2 bytes)

Interval end time: This attribute identifies the most recently finished 15 min interval. (R) (mandatory) (1 byte)

Threshold data 1/2 ID: This attribute points to an instance of the threshold data 1 ME that contains PM threshold values. Since no threshold value attribute number exceeds 7, a threshold data 2 ME is optional. (R, W, set-by-create) (mandatory) (2 bytes)

Socket failed: This attribute is incremented when an attempt to create a socket associated with a port fails. (R) (mandatory) (2 bytes)

Listen failed: This attribute is incremented when an attempt by a service to listen for a request on a port fails. (R) (mandatory) (2 bytes)

Bind failed: This attribute is incremented when an attempt by a service to bind to a port fails. (R) (mandatory) (2 bytes)

Accept failed: This attribute is incremented when an attempt to accept a connection on a port fails. (R) (mandatory) (2 bytes)

Select failed: This attribute is incremented when an attempt to perform a *select* on a group of ports fails. (R) (mandatory) (2 bytes)

Actions

Create, delete, get, set

Get current data (optional)

Notifications

Threshold crossing alert

Alarm number	Threshold crossing alert	Threshold value attribute No. (Note)
0	N/A	
1	Socket failed	1
2	Listen failed	2
3	Bind failed	3
4	Accept failed	4
5	Select failed	5

NOTE – This number associates the TCA with the specified threshold value attribute of the threshold data 1 managed entity.

9.4.5 IPv6 host config data

The IPv6 host config data configures IPv6 based services offered on the ONU. The ONU automatically creates instances of this ME if IPv6 host services are available. If an IPv4 stack is present, it is independently supported through the IP host config data ME.

This ME may be statically provisioned or may derive its parameters from router advertisements (RAs) or DHCPv6.

Relationships

One or more instances of this ME are associated with the ONU ME. Any number of TCP/UDP config data MEs can point to the IPv6 host config data, to model any number of ports and protocols. Performance may be monitored through an implicitly linked IP host PM history data ME.

Attributes

Managed entity ID: This attribute uniquely identifies each instance of this ME. The ONU creates as many instances as there are independent IP stacks on the ONU. To facilitate discovery, IP and IPv6 host config data MEs should be numbered from 0 upwards. The ONU must create IP(v4) and IPv6 host config data MEs with separate ME IDs, such that other MEs can use a single TP type attribute to link with either. (R) (mandatory) (2 bytes)

IP options: This attribute is a bit map that enables or disables IPv6 related options. The value 1 enables the option, while 0 disables it. The default value of this attribute is 0. (R, W) (mandatory) (1 byte)

0x01 IPv6 stack administrative unlock.

0x02 Enable router solicitation (RS). The host generates RS messages, if necessary, and responds to RAs. If the RA message has the M flag set to 1, the ONU is expected to request the address and other configuration information via DHCPv6. If the RA message has the O flag set to 1 and M to 0, the ONU is expected to only request additional configuration information via DHCPv6, but not addresses.

0x04 Enable DHCPv6.

0x08 Respond to pings (ICMPv6 echo replies)

0x10..0x80 Reserved

The following IP stack initialization flow is expected.

1. If the IPv6 stack is administratively unlocked (0x01), establish a link-local address [self-assign address, duplicate address detection (DAD) to confirm that address is unique within the local link]. This process is defined in [b-IETF RFC 4862], and is a part of stateless address autoconfiguration (SLAAC). However, no IP options are set to enable or disable this function – it always happens.
2. If RS and DHCPv6 are both disabled, do nothing. Manual settings are to be used and are required for this IPv6 stack to be fully functional.
3. If RS is enabled (0x02) and DHCPv6 is disabled, send RS and listen for an RA. If no RA is received, the ONU never attempts DHCPv6 and cannot complete automated initialization of IPv6. If an RA is received then the following occur.
 - a. The ONU builds its default router table per [b-IETF RFC 4861], reported via the current default router table attribute.
 - b. If the received RA includes information option(s) with an "A" prefix, then ONU assigns itself an address from all such A prefixes, per [b-IETF RFC 4862] (also part of SLAAC) (reported via the current address table attribute).
 - c. If the received RA includes DNS information [b-IETF RFC 6106], the ONU accepts it (reported via the current DNS table attribute). Support for RFC 6106 is strongly recommended.
 - d. If the received RA has $M = 1$, then the ONU requests identity association for non-temporary addresses (IA_NA) and other options (which could include DNS) via DHCPv6. The access network provider is responsible for ensuring that, if it sends DNS information both in the RA and DHCPv6, it sends the same DNS information; it must not rely on the ONU to figure out whether RA DNS is preferred over DHCPv6 DNS or *vice versa*. If different DNS information is received via DHCPv6, it also goes into the current DNS table attribute. If the ONU gets IA_NA via DHCPv6, this goes into the current address table attribute.
 - e. If the received RA has $M = 0$ and $O = 1$, then the ONU requests stateless options (which could include DNS) via DHCPv6.
4. If RS and DHCPv6 are both enabled, the ONU does RS (as described in a-c above, if RA is received) and DHCPv6 (requesting IA_NA and other options, as described in d above) simultaneously, effectively ignoring M and O flags.
5. If RS is disabled and DHCPv6 is enabled, then the ONU does not send RS and it does send DHCPv6 (requesting IA_NA and other options, as described in d above). If an unsolicited RA is received, it is ignored.

MAC address: This attribute indicates the MAC address used by the IP node. (R) (mandatory) (6 bytes)

Onu identifier: A unique ONU identifier string. If set to a non-null value, this string is used instead of the MAC address in retrieving DHCPv6 parameters. If the string is shorter than 25 characters, it must be null terminated. Its default value is 25 null bytes. (R, W) (mandatory) (25 bytes)

Several attributes of this ME may be paired together into two categories, manual settings and current values.

Manual settings	Current values
IPv6 address	Current address table
Default router	Current default router table
Primary DNS	Current DNS table
Secondary DNS	
On-link prefix	Current on-link prefix table

While this ME instance is administratively locked, it provides no IPv6 connectivity to the external world. Especially if manual provisioning is to be used, it is important that the ME remain locked until provisioning is complete.

While autoconfiguration is disabled, the current values are the same as the manual settings. While autoconfiguration is enabled, the current values are those autoconfigured on the basis of RAs, assigned by DHCPv6, or undefined (empty tables) if no values have (yet) been assigned.

IPv6 link local address: The address used for on-link IP host services, such as RS and DHCPv6. [b-IETF RFC 4862] specifies how to automatically establish a link-local address. (R) (mandatory) (16 bytes)

IPv6 address: The manually provisioned IPv6 address used for routed IPv6 host services. The address remains valid until reprovisioned, i.e., the preferred and valid lifetimes of this address are infinite. The default value of this attribute is the undefined address 0. (R, W) (mandatory) (16 bytes)

Default router: The manually provisioned IPv6 address of the default router. The default value of this attribute is the undefined address 0. (R, W) (mandatory) (16 bytes)

Primary DNS: The manually provisioned IPv6 address of the primary DNS server. The default value of this attribute is the undefined address 0. (R, W) (mandatory) (16 bytes)

Secondary DNS: The manually provisioned IPv6 address of the secondary DNS server. The default value of this attribute is the undefined address 0. (R, W) (mandatory) (16 bytes)

Current address table: This attribute is a list of the current IPv6 addresses of the IP host service. The link-local address does not appear in this table. Each row of the table is structured as follows.

IP address (16 bytes)

Preferred lifetime remaining, seconds (4 bytes)

Valid lifetime remaining, seconds (4 bytes)

If the manually provisioned IPv6 address attribute appears as the (only, by necessity) entry of the table, its preferred and valid lifetimes are infinite (0xFFFF FFFF).

(R) (mandatory) (24*N* bytes)

Current default router table: This attribute lists the IPv6 addresses of the current default routers. (R) (mandatory) (16*N* bytes)

Current DNS table: This attribute lists the IPv6 addresses of the current DNS servers. (R) (mandatory) (16*N* bytes)

Dynamic host configuration protocol unique identifier (DUID): This attribute is the DHCPv6 unique identifier. It is an octet string that must be globally unique and must remain stable over the lifetime of the ONU. If the string is shorter than 25 bytes, it must be null terminated. Its derivation is beyond the scope of this Recommendation; see [b-IETF RFC 3315] for further definition. (R) (mandatory) (25 bytes)

On-link prefix: This attribute is the manually provisioned on-link prefix used for destination IPv6 addresses of IPv6 host services. The attribute is structured as follows.

Prefix length, number of leading bits in the prefix that are valid (1 byte)

Prefix (16 bytes)

(R,W) (optional) (17 bytes)

Current on-link prefix table: In IPv6, an address is on a specific link if the address has been assigned to an interface attached to that link. However, in order for a node to know that a destination is on-link, it must obtain configuration information to that effect. A host maintains a prefix list that identifies ranges of addresses that are to be considered on-link ([b-IETF RFC 5942]). This attribute is a list of current on-link prefixes used for destination IPv6 addresses of IPv6 host services. Entries in this table come from RA messages received by the ONU from remote routers or manually provisioned to be on-link. Each row of the table is structured as follows.

Prefix length, number of leading bits in the prefix that are valid (1 byte)

Autonomous address-configuration flag byte. When set to 1, it indicates that this prefix can be used for stateless address configuration as specified in [b-IETF RFC 4862]; otherwise 0. (1 byte)

Prefix (16 bytes)

Preferred lifetime, seconds (4 bytes)

Valid lifetime, seconds (4 bytes)

If the manually provisioned on-link prefix attribute is present in the current on-link prefix table, its preferred and valid lifetimes are infinite (0xFFFF FFFF), and its autonomous address-configuration flag is 0.

(R) (optional) (26*N* bytes)

Relay agent options: This attribute is a pointer to a large string ME whose content specifies one or more DHCP relay agent options. (R, W) (optional) (2 bytes)

The meaning and interpretation of the large string's contents are identical to that described in the IP host config data definition in clause 9.4.1.

Actions

Get, get next, set

Test: Invoke an ICMP message from this IP host. The test message can be configured to generate a ping or traceroute. Annex A defines the test, test response and test result messages.

Notifications

Attribute value change

Number	Attribute value change	Description
1..8	N/A	
9	Current address table	AVC generated when a new address is added to the table, or when an existing address becomes invalid and is removed from the table. Countdown of the lifetime fields does not generate AVCs.
10	Current default router table	
11	Current DNS table	
12..13	N/A	
14	Current on-link prefix table	
15..16	Reserved	

9.4.6 IP host performance monitoring history data part 2

This managed entity collects additional performance monitoring data related to an IP host, related in particular to the DHCP server access errors. Instances of this managed entity are created and deleted by the OLT.

For a complete discussion of generic PM architecture, refer to clause I.4.

Relationships

An instance of this managed entity is associated with an instance of the IP host config data or IPv6 host config data managed entity.

Attributes

Managed entity ID: This attribute uniquely identifies each instance of this managed entity. Through an identical ID, this managed entity is implicitly linked to an instance of the IP host configuration data or IPv6 host configuration data ME, as well as to the corresponding IP host PMHD ME (135). (R, Set-by-create) (mandatory) (2 bytes)

Interval end time: This attribute identifies the most recently finished 15-minute interval. (R) (mandatory) (1 byte)

Threshold data 1/2 ID: This attribute points to an instance of the threshold data 1 managed entity that contains PM threshold values. Since no threshold value attribute number exceeds 7, a threshold data 2 ME is optional. (R, W, Set-by-create) (mandatory) (2 bytes)

DHCP Attempts count: This attribute counts the number of DHCP discover request. (R) (mandatory) (4 bytes)

DHCP Acks received count: This attribute counts the number of successful DHCP attempt (number of times the ONT DHCP client obtained a lease). (R) (mandatory) (4 bytes)

DHCP Nacks count: This attribute counts the number of Negative acknowledgements (NACKS) received for requests. Number of times the ONT's DHCP Client was denied a lease. (R) (mandatory) (4 bytes)

DHCP response error count: This attribute is incremented whenever the ONU receives a malformed/badly formatted response from the DHCP server. (R) (mandatory) (2 bytes)

DHCP response incomplete count: This attribute is incremented whenever the DHCP server response does not contain all the parameters required to successfully set up the IP configuration. (R) (mandatory) (2 bytes)

Actions

Create, delete, get, set

Get current data

Notifications

Threshold crossing alert

Alarm number	Threshold crossing alert	Threshold value attribute No. (Note)
0	DHCP response error	1
1	DHCP response incomplete	2

NOTE – This number associates the TCA with the specified threshold value attribute of the threshold data 1 managed entity.

9.5 Ethernet services

This clause defines the MEs associated with physical and virtual Ethernet UNIs, as shown in Figure 9.5-1.

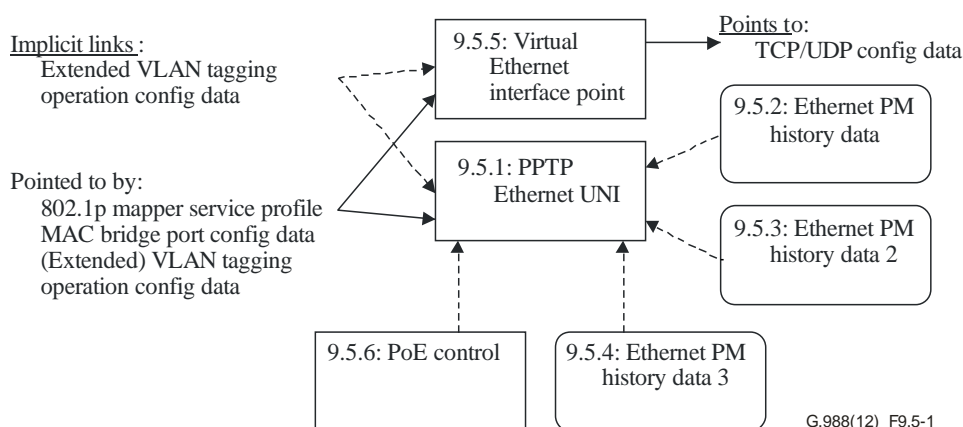

Figure 9.5-1 – Managed entities associated with Ethernet UNIs

9.5.1 Physical path termination point Ethernet UNI

This ME represents the point at an Ethernet UNI where the physical path terminates and Ethernet physical level functions are performed.

The ONU automatically creates an instance of this ME per port:

- when the ONU has Ethernet ports built into its factory configuration;
- when a cardholder is provisioned to expect a circuit pack of the Ethernet type;
- when a cardholder provisioned for plug-and-play is equipped with a circuit pack of the Ethernet type. Note that the installation of a plug-and-play card may indicate the presence of Ethernet ports via equipment ID as well as its type, and indeed may cause the ONU to instantiate a port-mapping package that specifies Ethernet ports.

The ONU automatically deletes instances of this ME when a cardholder is neither provisioned to expect an Ethernet circuit pack, nor is it equipped with an Ethernet circuit pack.

Relationships

An instance of this ME is associated with each instance of a pre-provisioned or real Ethernet port.

Attributes

Managed entity ID: This attribute uniquely identifies each instance of this ME. This 2 byte number indicates the physical position of the UNI. The first byte is the slot ID (defined in clause 9.1.5). The second byte is the port ID, with the range 1..255. (R) (mandatory) (2 bytes)

Expected type: This attribute supports pre-provisioning. It is coded as follows:

- 0 Autosense
- 1 to 254 One of the values from Table 9.1.5-1 that is compatible with an Ethernet circuit pack

Upon ME instantiation, the ONU sets this attribute to 0. (R, W) (mandatory) (1 byte)

Sensed type: When a circuit pack is present, this attribute represents its type as one of the values from Table 9.1.5-1. If the value of the expected type is not 0, then the value of the sensed type should be the same as the value of the expected type. Upon ME instantiation, the ONU sets this attribute to 0. See also the note in the following AVC table.

(R) (mandatory if the ONU supports circuit packs with configurable interface types, e.g., 10/100 BASE-T card) (1 byte)

Auto detection configuration: This attribute sets the following Ethernet port configuration.

Code point	Rate	Duplex
0x00	Auto	Auto
0x01	10 Mbit/s only	Full duplex only
0x02	100 Mbit/s only	Full duplex only
0x03	1000 Mbit/s only	Full duplex only
0x04	Auto	Full duplex only
0x05	10Gb/s only	Full duplex only
0x06	2.5Gb/s only	Full duplex only
0x07	5Gb/s only	Full duplex only
0x08	25Gb/s only	Full duplex only
0x09	40Gb/s only	Full duplex only
0x10	10 Mbit/s only	Auto
0x11	10 Mbit/s only	Half duplex only
0x12	100 Mbit/s only	Half duplex only
0x13	1000 Mbit/s only	Half duplex only
0x14	Auto	Half duplex only

Code point	Rate	Duplex
0x20	1000 Mbit/s only	Auto
0x30	100 Mbit/s only	Auto

Upon ME instantiation, the ONU sets this attribute to 0. (R, W) (mandatory for interfaces with autodetection options) (1 byte)

Ethernet loopback configuration: This attribute sets the following Ethernet loopback configuration.

- 0 No loopback
- 3 Loop 3, loopback of downstream traffic after PHY transceiver. Loop 3 is depicted in Figure 9.5.1-1.

Note that normal bridge behaviour may defeat the loopback signal unless broadcast MAC addresses are used. Although it does not reach the physical interface, [IEEE 802.1ag] loopback is preferred.

Upon ME instantiation, the ONU sets this attribute to 0. (R, W) (mandatory) (1 byte)

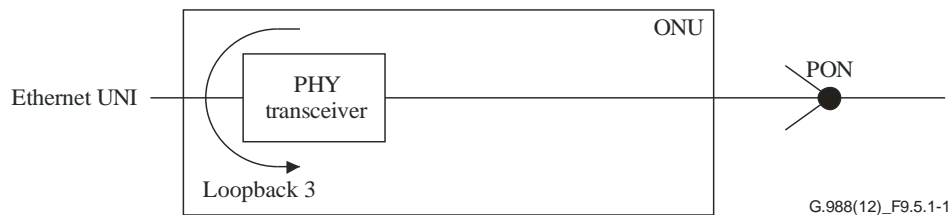

Figure 9.5.1-1 – Ethernet loopback configuration

Administrative state: This attribute locks (1) and unlocks (0) the functions performed by this ME. Administrative state is further described in clause A.1.6. (R, W) (mandatory) (1 byte)

Operational state: This attribute indicates whether the ME is capable of performing its function. Valid values are enabled (0) and disabled (1). (R) (optional) (1 byte)

Configuration ind: This attribute indicates the configuration status of the Ethernet UNI.

- 0x01 10BASE-T full duplex
- 0x02 100BASE-T full duplex
- 0x03 Gigabit Ethernet full duplex
- 0x04 10Gb/s Ethernet full duplex
- 0x05 2.5Gb/s Ethernet full duplex
- 0x06 5Gb/s Ethernet full duplex
- 0x07 25Gb/s Ethernet full duplex
- 0x08 40Gb/s Ethernet full duplex
- 0x11 10BASE-T half duplex
- 0x12 100BASE-T half duplex
- 0x13 Gigabit Ethernet half duplex

The value 0 indicates that the configuration status is unknown (e.g., Ethernet link is not established or the circuit pack is not yet installed). Upon ME instantiation, the ONU sets this attribute to 0. (R) (mandatory) (1 byte)

Max frame size: This attribute denotes the maximum frame size allowed across this interface. Upon ME instantiation, the ONU sets the attribute to 1518. (R, W) (mandatory for G-PON, optional for ITU-T G.986 systems) (2 bytes)

DTE or DCE ind: This attribute specifies the following Ethernet interface wiring.

- 0 DCE or MDI-X (default).
- 1 DTE or MDI.
- 2 Automatic selection

(R, W) (mandatory) (1 byte)

Pause time: This attribute allows the PPTP to ask the subscriber terminal to temporarily suspend sending data. Units are in pause quanta (1 pause quantum is 512 bit times of the particular implementation). Values: 0..0xFFFF. Upon ME instantiation, the ONU sets this attribute to 0. (R, W) (optional) (2 bytes)

Bridged or IP ind: This attribute specifies whether the Ethernet interface is bridged or derived from an IP router function.

- 0 Bridged
- 1 IP router
- 2 Depends on the parent circuit pack. 2 means that the circuit pack's bridged or IP ind attribute is either 0 or 1.

Upon ME instantiation, the ONU sets this attribute to 2. (R, W) (optional) (1 byte)

ARC: See clause A.1.4.3. (R, W) (optional) (1 byte)

ARC interval: See clause A.1.4.3. (R, W) (optional) (1 byte)

PPPoE filter: This attribute controls filtering of PPPoE packets on this Ethernet port. The value 0 allows packets of all types. The value 1 discards everything but PPPoE packets. The default value is 0. (R, W) (optional) (1 byte)

Power control: This attribute controls whether power is provided to an external equipment over the Ethernet PPTP. The value 1 enables power over the Ethernet port. The default value 0 disables power feed. (R, W) (optional) (1 byte)

NOTE – This attribute is the equivalent of the acPSEAdminControl variable defined in clause 30.9.1.2.1 of [IEEE 802.3]. Other variables related to PoE appear in the PoE control ME.

Actions

Get, set

Notifications

Attribute value change

Number	Attribute value change	Description
1	N/A	
2	Sensed type	Sensed type of Ethernet interface. Valid values are as follows. 1 (10BASE-T) 2 (100BASE-T) 3 (Gigabit Ethernet) 4 (10G Ethernet). (Note)
3..5	N/A	
6	Op state	Operational state
7..11	N/A	

12	ARC	ARC timer expiration
13..15	N/A	
16	Reserved	
NOTE – These values violate the rules of the AVC message, which require the changed value of the sensed type (in this case) attribute to be reported. Because of existing implementations, pre-existing documentation is retained; however, implementers should regard this attribute and its AVC with caution.		

Alarm

Alarm number	Alarm	Description
0	LAN-LOS	No carrier at the Ethernet UNI
1..207	Reserved	
208..223	Vendor-specific alarms	Not to be standardized

9.5.2 Ethernet performance monitoring history data

This ME collects some of the PM data for a physical Ethernet interface. Instances of this ME are created and deleted by the OLT.

For a complete discussion of generic PM architecture, refer to clause I.4.

Relationships

An instance of this ME is associated with an instance of the PPTP Ethernet UNI.

Attributes

Managed entity ID: This attribute uniquely identifies each instance of this ME. Through an identical ID, this ME is implicitly linked to an instance of the PPTP Ethernet UNI. (R, set-by-create) (mandatory) (2 bytes)

Interval end time: This attribute identifies the most recently finished 15 min interval. (R) (mandatory) (1 byte)

Threshold data 1/2 ID: This attribute points to an instance of the threshold data 1 and 2 MEs that contains PM threshold values. (R, W, set-by-create) (mandatory) (2 bytes)

FCS errors: This attribute counts frames received on a particular interface that were an integral number of octets in length but failed the FCS check. The count is incremented when the MAC service returns the frameCheckError status to the link layer control (LLC) or other MAC user. Received frames for which multiple error conditions are obtained are counted according to the error status presented to the LLC. (R) (mandatory) (4 bytes)

Excessive collision counter: This attribute counts frames whose transmission failed due to excessive collisions. (R) (mandatory) (4 bytes)

Late collision counter: This attribute counts the number of times that a collision was detected later than 512 bit times into the transmission of a packet. (R) (mandatory) (4 bytes)

Frames too long: This attribute counts received frames that exceeded the maximum permitted frame size. The count is incremented when the MAC service returns the frameTooLong status to the LLC. (R) (mandatory) (4 bytes)

- Buffer overflows on receive:** This attribute counts the number of times that the receive buffer overflowed. (R) (mandatory) (4 bytes)
- Buffer overflows on transmit:** This attribute counts the number of times that the transmit buffer overflowed. (R) (mandatory) (4 bytes)
- Single collision frame counter:** This attribute counts successfully transmitted frames whose transmission was delayed by exactly one collision. (R) (mandatory) (4 bytes)
- Multiple collisions frame counter:** This attribute counts successfully transmitted frames whose transmission was delayed by more than one collision. (R) (mandatory) (4 bytes)
- SQE counter:** This attribute counts the number of times that the SQE test error message was generated by the PLS sublayer. (R) (mandatory) (4 bytes)
- Deferred transmission counter:** This attribute counts frames whose first transmission attempt was delayed because the medium was busy. The count does not include frames involved in collisions. (R) (mandatory) (4 bytes)
- Internal MAC transmit error counter:** This attribute counts frames whose transmission failed due to an internal MAC sublayer transmit error. (R) (mandatory) (4 bytes)
- Carrier sense error counter:** This attribute counts the number of times that carrier sense was lost or never asserted when attempting to transmit a frame. (R) (mandatory) (4 bytes)
- Alignment error counter:** This attribute counts received frames that were not an integral number of octets in length and did not pass the FCS check. (R) (mandatory) (4 bytes)
- Internal MAC receive error counter:** This attribute counts frames whose reception failed due to an internal MAC sublayer receive error. (R) (mandatory) (4 bytes)

Actions

- Create, delete, get, set
- Get current data (optional)

Notifications

Threshold crossing alert

Alarm number	Threshold crossing alert	Threshold value attribute No. (Note)
0	FCS errors	1
1	Excessive collision counter	2
2	Late collision counter	3
3	Frames too long	4
4	Buffer overflows on receive	5
5	Buffer overflows on transmit	6
6	Single collision frame counter	7
7	Multiple collisions frame counter	8
8	SQE counter	9
9	Deferred transmission counter	10
10	Internal MAC transmit error counter	11

Threshold crossing alert

Alarm number	Threshold crossing alert	Threshold value attribute No. (Note)
11	Carrier sense error counter	12
12	Alignment error counter	13
13	Internal MAC receive error counter	14

NOTE – This number associates the TCA with the specified threshold value attribute of the threshold data 1/2 managed entities.

9.5.3 Ethernet performance monitoring history data 2

This ME collects additional PM data for a physical Ethernet interface. Instances of this ME are created and deleted by the OLT.

For a complete discussion of generic PM architecture, refer to clause I.4.

Relationships

An instance of this Ethernet PM history data 2 ME is associated with an instance of the PPTP Ethernet UNI.

Attributes

Managed entity ID: This attribute uniquely identifies each instance of this ME. Through an identical ID, this ME is implicitly linked to an instance of the PPTP Ethernet UNI. (R, set-by-create) (mandatory) (2 bytes)

Interval end time: This attribute identifies the most recently finished 15 min interval. (R) (mandatory) (1 byte)

Threshold data 1/2 ID: This attribute points to an instance of the threshold data 1 ME that contains PM threshold values. Since no threshold value attribute number exceeds 7, a threshold data 2 ME is optional. (R, W, set-by-create) (mandatory) (2 bytes)

PPPoE filtered frame counter: This attribute counts the number of frames discarded due to PPPoE filtering. (R) (mandatory) (4 bytes)

Actions

Create, delete, get, set

Get current data (optional)

Notifications

Threshold crossing alert

Alarm number	Threshold crossing alert	Threshold value attribute No. (Note)
0	PPPoE filtered frame counter	1

NOTE – This number associates the TCA with the specified threshold value attribute of the threshold data 1 managed entity.

9.5.4 Ethernet performance monitoring history data 3

This ME collects PM data associated with an Ethernet interface. It includes parameters defined in the Ethernet statistics group of [IETF RFC 2819] that are not already covered by previously defined Ethernet monitoring MEs. The received direction is from the CPE towards the network (upstream).

NOTE 1 – Several of the same counters are available from the Ethernet frame PM history data MEs, which are associated with MAC bridge ports. MAC bridge port association allows those MEs to be used for any Ethernet flow, in both upstream and downstream directions, while the Ethernet PM history data 3 ME can only be used on a physical IEEE 802.3 port.

Instances of this ME are created and deleted by the OLT.

For a complete discussion of generic PM architecture, refer to clause I.4.

NOTE 2 – Implementers are encouraged to consider the Ethernet frame extended PM ME defined in clause 9.3.32, which collects the same counters in a more generalized way.

Relationships

An instance of this ME is associated with an instance of the PPTP Ethernet UNI.

Attributes

Managed entity ID: This attribute uniquely identifies each instance of this ME. Through an identical ID, this ME is implicitly linked to an instance of the PPTP Ethernet UNI. (R, set-by-create) (mandatory) (2 bytes)

Interval end time: This attribute identifies the most recently finished 15 min interval. (R) (mandatory) (1 byte)

Threshold data 1/2 ID: This attribute points to an instance of the threshold data 1 ME that contains PM threshold values. Since no threshold value attribute number exceeds 7, a threshold data 2 ME is optional. (R, W, set-by-create) (mandatory) (2 bytes)

Drop events: The total number of events in which packets were dropped due to a lack of resources. This is not necessarily the number of packets dropped; it is the number of times this event was detected. (R) (mandatory) (4 bytes)

Octets: The total number of octets received from the CPE, including those in bad packets, excluding framing bytes, but including FCS. (R) (mandatory) (4 bytes)

Packets: The total number of packets received, including bad packets, broadcast packets and multicast packets. (R) (mandatory) (4 bytes)

Broadcast packets: The total number of received good packets directed to the broadcast address. This does not include multicast packets. (R) (mandatory) (4 bytes)

Multicast packets: The total number of received good packets directed to a multicast address. This does not include broadcast packets. (R) (mandatory) (4 bytes)

Undersize packets: The total number of packets received that were less than 64 octets long, but were otherwise well formed (excluding framing bits, but including FCS). (R) (mandatory) (4 bytes)

- Fragments:** The total number of packets received that were less than 64 octets long, excluding framing bits but including FCS octets, and had either a bad FCS with an integral number of octets (FCS error) or a bad FCS with a non-integral number of octets (alignment error). It is entirely normal for this attribute to increment. This is because it counts both runts (which are normal occurrences due to collisions) and noise hits. (R) (mandatory) (4 bytes)
- Jabbers:** The total number of packets received that were longer than 1518 octets, excluding framing bits but including FCS octets, and had either a bad FCS with an integral number of octets (FCS error) or a bad FCS with a non-integral number of octets (alignment error). The range to detect jabber is between 20 ms and 150 ms. (R) (mandatory) (4 bytes)
- Packets 64 octets:** The total number of received packets (including bad packets) that were 64 octets long, excluding framing bits but including FCS. (R) (mandatory) (4 bytes)
- Packets 65 to 127 octets:** The total number of received packets (including bad packets) that were 65..127 octets long, excluding framing bits but including FCS. (R) (mandatory) (4 bytes)
- Packets 128 to 255 octets:** The total number of packets (including bad packets) received that were 128..255 octets long, excluding framing bits but including FCS. (R) (mandatory) (4 bytes)
- Packets 256 to 511 octets:** The total number of packets (including bad packets) received that were 256..511 octets long, excluding framing bits but including FCS. (R) (mandatory) (4 bytes)
- Packets 512 to 1023 octets:** The total number of packets (including bad packets) received that were 512..1023 octets long, excluding framing bits but including FCS. (R) (mandatory) (4 bytes)
- Packets 1024 to 1518 octets:** The total number of packets (including bad packets) received that were 1024..1518 octets long, excluding framing bits but including FCS. (R) (mandatory) (4 bytes)

Actions

Create, delete, get, set

Get current data (optional)

Notifications

Threshold crossing alert		
Alarm number	Threshold crossing alert	Threshold data counter No. (Note)
0	Drop events	1
1	Undersize packets	2
2	Fragments	3
3	Jabbers	4
NOTE – This number associates the TCA with the specified threshold value attribute of the threshold data 1 managed entity.		

9.5.5 Virtual Ethernet interface point

This ME represents the data plane hand-off point in an ONU to a separate (non-OMCI) management

domain. The VEIP is managed by the OMCI, and is potentially known to the non-OMCI management domain. One or more Ethernet traffic flows are present at this boundary.

Instances of this ME are automatically created and deleted by the ONU. This is necessary because the required downstream priority queues are subject to physical implementation constraints. The OLT may use one or more of the VEIPs created by the ONU.

It is expected that the ONU will create one VEIP for each non-OMCI management domain. At the vendor's discretion, a VEIP may be created for each traffic class.

Relationships

An instance of this ME is associated with an instance of a virtual Ethernet interface between OMCI and non-OMCI management domains.

Attributes

Managed entity ID: This attribute uniquely identifies each instance of this ME. When used independently of a cardholder and circuit pack, the ONU should assign IDs in the sequence 1, 2, When used in conjunction with a cardholder and circuit pack, this 2 byte number indicates the physical position of the VEIP. The first byte is the slot ID (defined in clause 9.1.5). The second byte is the port ID, with the range 1..255. The values 0 and 0xFFFF are reserved. (R) (mandatory) (2 bytes)

Administrative state: This attribute locks (1) and unlocks (0) the functions performed by this ME. Administrative state is further described in clause A.1.6. (R, W) (mandatory) (1 byte)

Operational state: This attribute indicates whether the ME is capable of performing its function. Valid values are enabled (0) and disabled (1). (R) (optional) (1 byte)

Interdomain name: This attribute is a character string that provides an optional way to identify the VEIP to a non-OMCI management domain. The interface may also be identified by its ME ID, [b-IANA] assigned port and possibly other ways. If the vendor offers no information in this attribute, it should be set to a sequence of null bytes. (R, W) (optional) (25 bytes)

TCP/UDP pointer: This attribute points to an instance of the TCP/UDP config data ME, which provides for OMCI management of the non-OMCI management domain's IP connectivity. If no OMCI management of the non-OMCI domain's IP connectivity is required, this attribute may be omitted or set to its default, a null pointer. (R, W) (optional) (2 bytes)

IANA assigned port: This attribute contains the TCP or UDP port value as assigned by [b-IANA] for the management protocol associated with this virtual Ethernet interface. This attribute is to be regarded as a hint, not as a requirement that management communications use this port; the actual port and protocol are specified in the associated TCP/UDP config data ME. If no port has been assigned or if the management protocol is free to be chosen at run-time, this attribute should be set to 0xFFFF. (R) (mandatory) (2 bytes)

[NOTE – This attribute does not apply to USP management protocol. For USP MTP discovery, please refer to clause 9.12.19.](#)

Actions

Get, set

Notifications

Attribute value change

Number	Attribute value change	Description
0..1	N/A	
2	Op state	Operational state
3	N/A	
4..16	Reserved	

Alarm

Alarm number	Alarm	Description
0	Connecting function fail	Indicates a failure of the connecting function. May be used to signal faults from the non-OMCI management domain into the OMCI.
1..207	Reserved	
208..223	Vendor-specific alarms	Not to be standardized

9.5.6 Power over Ethernet control

This ME represents the ability to monitor and control the PoE capability of the ONU as power-sourcing equipment (PSE) as defined in clauses 30.9 and 33 of [IEEE 802.3].

An ONU that supports the enhanced PoE control feature automatically creates or deletes an instance of this ME whenever it creates or deletes the corresponding PPTP Ethernet UNI.

Administrative control of the PoE feature resides in the power control attribute of the PPTP Ethernet UNI ME.

Relationships

An instance of this ME is associated with each instance of a PPTP Ethernet UNI.

Attributes

Managed entity ID: This attribute uniquely identifies each instance of this ME. Through an identical ID, this ME is implicitly linked to an instance of the physical path Ethernet UNI ME. (R) (mandatory) (2 bytes)

PoE capabilities: This attribute is a bit map that identifies the PoE capabilities of the port.

Bits are assigned as follows.

Bit	Meaning
-----	---------

1 (LSB)	When this bit is 1, the PSE pinout alternative may be changed through the power pair pinout control attribute. When the bit is 0, the PSE pinout alternative is fixed, and is described by the power pair pinout control attribute.
---------	-------------------------------------------------------------------------------------------------------------------------------------------------------------------------------------------------------------------------------------

2..16	Reserved
-------	----------

(R) (mandatory) (2 bytes)

Power pair pinout control: If the PSE pinout is configurable, according to the PoE capabilities attribute, this attribute is used to configure the pinout. If the PSE pinout is fixed, this attribute is read-only. In either case, the value returned by a get operation indicates the actual configuration. The value 0 configures/indicates pinout alternative A (signal pairs); the value 1

configures/indicates pinout alternative B (spare pairs). Other values are reserved. This attribute corresponds to the aPSEPowerPairs variable defined in [IEEE 802.3]. (R, W) (mandatory) (1 byte)

Operational state: This attribute indicates whether the PPTP is capable of performing its function. Valid values are enabled (0) and disabled (1). (R) (mandatory) (1 byte)

Power detection status: This attribute is an enumeration that returns the current status of the port. It corresponds to the aPSEPowerDetectionStatus variable defined in [IEEE 802.3]. Its values are defined as follows.

- 0 PSE disabled
 - 1 PSE searching
 - 2 PSE delivering power
 - 3 PSE test mode
 - 4 PSE fault detected
 - 5 PSE implementation specific fault detected
- Other values are reserved.

(R) (mandatory) (1 byte)

Power classification status: This attribute is an enumeration that indicates the powered device (PD) class of a detected PD. It is only valid when the power detection status attribute indicates PSE delivering power. The attribute corresponds to the aPSEPowerClassification variable defined in [IEEE 802.3]. Its values are defined as follows.

- 0 Undefined or feature not supported
 - 1 Class 0 PD
 - 2 Class 1 PD
 - 3 Class 2 PD
 - 4 Class 3 PD
 - 5 Class 4 PD
- Other values are reserved.

(R) (optional) (1 byte)

Power priority: This attribute controls the priority of the port from the point of view of a power management algorithm. The priority that is set by this attribute could be used by a control mechanism that prevents overcurrent situations by first disconnecting ports with lower power priority (higher numerical value). The attribute corresponds to the pethPsePortPowerPriority variable defined in [b-IETF RFC 3621]. Valid values are as follows.

- 1 critical
- 2 high
- 3 low

(R, W) (optional) (1 byte)

Invalid signature counter: This attribute increments when the PoE state machine depicted in Figure 33-6 of [IEEE 802.3] enters the signature_invalid state, but not more than twice per second. The counter is never explicitly reset, but its value is not required to persist over ONU initialization. (R) (optional) (2 bytes)

Power denied counter: This attribute increments when the PoE state machine depicted in Figure 33-6 of [IEEE 802.3] enters the power_denied state, but not more than twice per second. The counter is never explicitly reset, but its value is not required to persist over ONU initialization. (R) (optional) (2 bytes)

Overload counter: This attribute increments when the PoE state machine depicted in Figure 33-6 of [IEEE 802.3] enters the error_delay_over state, but not more than twice per second. The counter is never explicitly reset, but its value is not required to persist over ONU initialization. (R) (optional) (2 bytes)

Short counter: This attribute increments when the PoE state machine depicted in Figure 33-6 of [IEEE 802.3] enters the error_delay_short state, but not more than twice per second. The counter is never explicitly reset, but its value is not required to persist over ONU initialization. (R) (optional) (2 bytes)

MPS absent counter: This attribute increments when the PoE state machine depicted in Figure 33-6 of [IEEE 802.3] goes from the state power_on to the idle state, but not more than twice per second. The counter is never explicitly reset, but its value is not required to persist over ONU initialization. (R) (optional) (2 bytes)

PsE class control: This attribute may be used to place specific limits on the class of power supported by this port. Valid code points for this attribute are as follows.

- 0 Power feed enabled at the default level for this port
- 1 Power feed enabled at the class 0 power level
- 2 Power feed enabled at the class 1 power level
- 3 Power feed enabled at the class 2 power level
- 4 Power feed enabled at the class 3 power level
- 5 Power feed enabled at the class 4 power level

Other values are reserved. (R, W) (optional) (1 byte)

Current Power Consumption: This attribute is used to report, in milliwatts, the actual power being provided by this port..

(R) (optional) (4 bytes)

Actions

Get, set

Notifications

Attribute value change

Number	Attribute value change	Description
1..2	N/A	
3	Operational state	
4..12	N/A	
13..16	Reserved	

9.6 This clause is intentionally left blank

9.7 xDSL services

This clause defines MEs associated with physical xDSL UNIs, as shown in Figure 9.7-1.

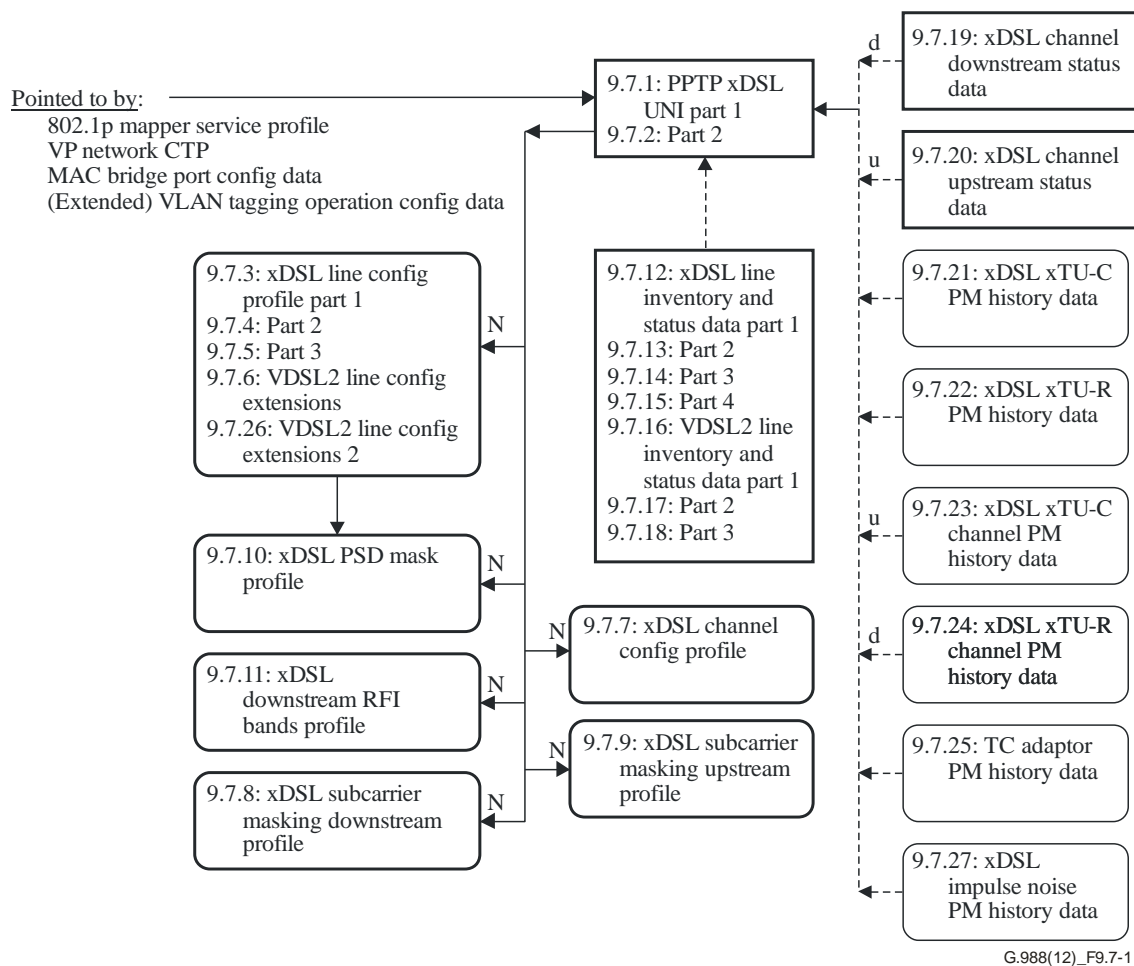

Figure 9.7-1 – Managed entities associated with xDSL services

NOTE – This clause is based on [ITU-T G.997.1]. In comparison to their [ITU-T G.997.1] equivalents, descriptions in this Recommendation frequently appear in condensed or summarized form. To avoid rendering existing implementations non-standard, the OMCI always defines new attributes added to existing MEs to be optional, even though [ITU-T G.997.1] may specify that the new attributes are mandatory. When the OMCI defines a new ME, however, it follows [ITU-T G.997.1]. Furthermore, [ITU-T G.997.1] sometimes calls out different requirements for different xDSL Recommendations, which may or may not be completely captured in clause 9.7. Finally, [ITU-T G.997.1] is itself subject to revision as xDSL standards evolve.

Users of this Recommendation are therefore encouraged to consult the current version of [ITU-T G.997.1] for further details.

9.7.1 Physical path termination point xDSL UNI part 1

This ME represents the point where physical paths terminate on an xDSL CO modem (xTU-C). The xDSL ME family¹ is used for ADSL VDSL2 and FAST services. A legacy family of VDSL MEs remains valid for ITU-T G.993.1 VDSL, if needed. It is documented in [ITU-T G.983.2].

The ONU automatically creates an instance of this ME per port:

- when the ONU has xDSL ports built into its factory configuration;
- when a cardholder is provisioned to expect a circuit pack of the xDSL type;
- when a cardholder provisioned for plug-and-play is equipped with a circuit pack of the xDSL type. Note that the installation of a plug-and-play card may indicate the presence of xDSL

¹ The xDSL MEs include the ITU-T G.992 family as well as ITU-T G.993.2 VDSL2, but not ITU-T G.993.1 VDSL.

ports via equipment ID as well as its type, and indeed may cause the ONU to instantiate a port-mapping package that specifies xDSL ports.

The ONU automatically deletes instances of this ME when a cardholder is neither provisioned to expect an xDSL circuit pack, nor is it equipped with an xDSL circuit pack.

Relationships

An instance of this ME is associated with each instance of a real or pre-provisioned xDSL port.

Attributes

Managed entity ID: This attribute uniquely identifies each instance of this ME. This 2 byte number indicates the physical position of the UNI. The six LSBs of the first byte are the slot ID, defined in clause 9.1.5. The two MSBs indicate the channel number in some of the implicitly linked MEs, and must be 0 in the PPTP itself. This reduces the possible number of physical slots to 64. The second byte is the port ID, with the range 1..255. (R) (mandatory) (2 bytes)

Loopback configuration: This attribute represents the loopback configuration of this physical interface.

0 No loopback

1 Loopback2 – a loopback at the ONU towards the OLT. The OLT can execute a physical level loopback test after loopback2 is set.

Upon ME instantiation, the ONU sets this attribute to 0. (R, W) (mandatory) (1 byte)

Administrative state: This attribute locks (1) and unlocks (0) the functions performed by this ME. Administrative state is further described in clause A.1.6. (R, W) (mandatory) (1 byte)

Operational state: This attribute indicates whether the ME is capable of performing its function. Valid values are enabled (0) and disabled (1). (R) (optional) (1 byte)

xDSL line configuration profile: This attribute points to an instance of the xDSL line configuration profiles (part 1, 2 and 3) MEs, and if necessary, also to VDSL2 line configuration extensions (1 and 2) MEs, also to vectoring line configuration extension MEs. Upon ME instantiation, the ONU sets this attribute to 0, a null pointer. (R, W) (mandatory) (2 bytes)

xDSL subcarrier masking downstream profile: This attribute points to an instance of the xDSL subcarrier masking downstream profile ME. Upon ME instantiation, the ONU sets this attribute to 0, a null pointer. (R, W) (mandatory) (2 bytes)

xDSL subcarrier masking upstream profile: This attribute points to an instance of the xDSL subcarrier masking upstream profile ME. Upon ME instantiation, the ONU sets this attribute to 0, a null pointer. (R, W) (mandatory) (2 bytes)

xDSL downstream power spectral density (PSD) mask profile: This attribute points to an instance of the xDSL PSD mask profile ME that defines downstream parameters. Upon ME instantiation, the ONU sets this attribute to 0, a null pointer. (R, W) (mandatory) (2 bytes)

xDSL downstream RFI bands profile: This attribute points to an instance of the xDSL downstream RFI bands profile ME. Upon ME instantiation, the ONU sets this attribute to 0, a null pointer. (R, W) (mandatory) (2 bytes)

ARC: See clause A.1.4.3. (R, W) (optional) (1 byte)

ARC interval: See clause A.1.4.3. (R, W) (optional) (1 byte)

Modem type: This attribute specifies the modem type. If the hardware cannot support the requested modem type, the ONU should deny the provisioning command. For backward compatibility, the attribute is optional, with a default of ATM.

- 0 undefined
- 1 ATM (default)
- 2 PTM (Ethernet)

(R, W) (optional) (1 byte)

NOTE – Many newer VDSL2 chip sets support only PTM. The ATM default is retained for backward compatibility, but implementers should be aware that the default may need to be overridden by provisioning before the xDSL UNI can be brought into service.

Upstream PSD mask profile: This attribute points to an instance of the xDSL PSD mask profile that defines upstream parameters. Upon ME instantiation, the ONU sets this attribute to 0, a null pointer. (R, W) (optional) (2 bytes)

Network specific extensions pointer: This attribute points to a network address ME that contains the path and name of a file containing network specific parameters for the associated UNI. Upon ME instantiation, the ONU sets this attribute to 0xFFFF, a null pointer. (R, W) (optional) (2 bytes)

Actions

Get, set

Notifications

Attribute value change

Number	Attribute value change	Description
1..2	N/A	
3	Op state	Operational state
4..8	N/A	
9	ARC	ARC timer expiration
10..12	N/A	
13..16	Reserved	

Alarm

Alarm number	Alarm	Description
0	NE LOF	Near-end loss of frame
1	NE LOS	Near-end loss of signal
2	NE LOL	Near-end loss of link
3	NE LPR	Near-end loss of power
4	Card alm	Card in alarm
5	FE LOF	Far-end loss of frame
6	FE LOS	Far-end loss of signal
7	FE LOL	Far-end loss of link
8	FE LPR	Far-end loss of power

Alarm

Alarm number	Alarm	Description
9	DRT up	Data rate threshold upshift (Note 1)
10	DRT down	Data rate threshold downshift (Note 1)
11	LINIT	Line initialization failure
12	LCD	Loss of cell delineation, near end (Note 2)
13	NCD	No cell delineation, near end (Note 2)
14	LCD-FE	Loss of cell delineation, far end (Note 2)
15	NCD-FE	No cell delineation, far end (Note 2)
16	File not found	The PPTP xDSL UNI attempted to access a network specific extensions file that is not available.
17	OOS	PTM near-end out-of-sync failure – see clause 7.1.5.1.1 of [ITU T G.997.1] and clause N.4 of [ITU T G.992.3]
18	OOS-FE	PTM far-end out-of-sync failure - see clause 7.1.5.2.1 of [ITU T G.997.1] and clause N.4 of [ITU T G.992.3]
19	LOR	Loss-of-RMC (LOR) failure – see clause 7.4.1.2 of [ITU-T G.997.2]
20	LOM	Loss-of-margin (LOM) failure – see clause 7.4.1.3 of [ITU-T G.997.2]
21	LOR-FE	Far-end loss-of-RMC (LOR-FE) failure – see clause 7.4.2.2 of [ITU-T G.997.2]
22	LOM-FE	Far-end loss-of-margin (LOM-FE) failure – see clause 7.4.2.3 of [ITU-T G.997.2]
23.207	Reserved	
<p>NOTE 1 – The data rate upshift and downshift alarms are deprecated. They are not defined in [ITU-T G.997.1].</p> <p>NOTE 2 – These alarms are meaningful only for ATM transport. The alarms may be declared against the UNI itself, or against one of the bearer channels. In the latter case, the two MSBs of the instance identifier in the alarm message specify the bearer channel.</p>		

9.7.2 Physical path termination point xDSL UNI part 2

This ME represents the point in the ONU where physical paths terminate on an xDSL CO modem (xTU-C). Standards and chip sets support several forms of DSL, including VDSL2, and the xDSL ME family is used for all of them, with specific extensions for technology variations.

The ONU creates or deletes an instance of this ME at the same time it creates or deletes the corresponding PPTP xDSL UNI part 1.

Relationships

An instance of this ME is associated with each instance of a PPTP xDSL UNI part 1.

Attributes

Managed entity ID: This attribute uniquely identifies each instance of this ME. Through an identical ID, this ME is implicitly linked to an instance of the PPTP xDSL UNI part 1. (R) (mandatory) (2 bytes)

Each of the following eight attributes is a pointer to an xDSL channel configuration profile ME. In each case, the default value 0, set when the ME is auto-created, is a null pointer.

- xDSL channel configuration profile for bearer channel 0 downstream:**
(R, W) (optional) (2 bytes)
- xDSL channel configuration profile for bearer channel 1 downstream:**
(R, W) (optional) (2 bytes)
- xDSL channel configuration profile for bearer channel 2 downstream:**
(R, W) (optional) (2 bytes)
- xDSL channel configuration profile for bearer channel 3 downstream:**
(R, W) (optional) (2 bytes)
- xDSL channel configuration profile for bearer channel 0 upstream:**
(R, W) (optional) (2 bytes)
- xDSL channel configuration profile for bearer channel 1 upstream:**
(R, W) (optional) (2 bytes)
- xDSL channel configuration profile for bearer channel 2 upstream:**
(R, W) (optional) (2 bytes)
- xDSL channel configuration profile for bearer channel 3 upstream:**
(R, W) (optional) (2 bytes)

Actions

Get, set

Notifications

None.

9.7.3 xDSL line configuration profile part 1

The overall xDSL line configuration profile is modelled in several parts, all of which are associated together through a common ME ID (the client PPTP xDSL UNI part 1 has a single pointer, which refers to the entire set of line configuration profile parts).

It is worth noting that attributes in the line configuration profile family affect the real-time service delivery of an xDSL UNI, e.g., by triggering diagnostics. Despite the fact that they are called profiles, it may be advisable to instantiate a complete set of these MEs for each PPTP xDSL UNI.

Relationships

An instance of this ME may be associated with zero or more instances of an xDSL UNI.

Attributes

Managed entity ID: This attribute uniquely identifies each instance of this ME. The value 0 is reserved. All xDSL and VDSL2 line configuration profiles and extensions that pertain to a given PPTP xDSL UNI must share a common ME ID. (R, set-by-create) (mandatory)

xTU transmission system enabling (xTSE): This configuration attribute specifies the transmission system coding types to be allowed by the near-end xTU. It is a bit map as defined in Table 9.7.12-1. (R, W, set-by-create) (mandatory) (7 bytes)

NOTE 1 – This attribute is only 7 bytes long. An eighth byte enabling VDSL2 capabilities is defined in the VDSL2 transmission system enabling attribute of the xDSL line configuration profile part 2 ME.

Power management state forced: This configuration parameter forces the line state of the near-end xTU. It is coded as an integer value with the following definition.

- 0 Force the line from the L3 idle state to the L0 full-on state. This transition requires the short initialization procedures. After reaching the L0 state, the line may enter into or exit from the L2 low-power state if the L2 state is enabled. If the L0 state is not reached after a vendor-discretionary number of retries or within a vendor-discretionary timeout, an initialization failure occurs. Whenever the line is in the L3 state, it attempts to transition to the L0 state until it is forced into another state through this configuration parameter.
- 2 Force the line from the L0 full-on to the L2 low-power state. This is an out-of-service test value for triggering the L2 mode.
- 3 Force the line from the L0 full-on or L2 low-power state to the L3 idle state. This transition requires the orderly shutdown procedure. After reaching the L3 state, the line remains there until it is forced into another state through this configuration parameter.

(R, W, set-by-create) (mandatory) (1 byte)

Power management state enabling: The PMMode attribute specifies the line states into which the xTU-C or x digital subscriber line transceiver unit at the remote end (xTU-R) may autonomously go. It is a bit map (0 if not allowed, 1 if allowed) with the following definition.

Bit 1 (LSB): L3 idle state

Bit 2: L1/L2 low-power state

(R, W, set-by-create) (mandatory) (1 byte)

Downstream target noise margin: This attribute specifies the noise margin the xTU-R receiver must achieve, relative to the BER requirement for each of the downstream bearer channels, to successfully complete initialization. Its value ranges from 0 (0.0 dB) to 310 (31.0 dB). (R, W, set-by-create) (mandatory) (2 bytes)

Upstream target noise margin: This attribute specifies the noise margin the xTU-C receiver must achieve, relative to the BER requirement for each of the upstream bearer channels, to successfully complete initialization. Its value ranges from 0 (0.0 dB) to 310 (31.0 dB). (R, W, set-by-create) (mandatory) (2 bytes)

Downstream maximum noise margin: The MAXSNRMds attribute specifies the maximum noise margin the xTU-R receiver tries to sustain. If the noise margin is above this level, the xTU-R requests the xTU-C to reduce its transmit power, if this functionality is supported by the applicable xDSL Recommendation. Its value ranges from 0 (0.0 dB) to 310 (31.0 dB). The special value 0xFFFF indicates that the maximum noise margin limit is unbounded. (R, W, set-by-create) (mandatory) (2 bytes)

Upstream maximum noise margin: The MAXSNRMus attribute specifies the maximum noise margin the xTU-C receiver tries to sustain. If the noise margin is above this level, the xTU-C requests the xTU-R to reduce its transmit power, if this functionality is supported by the applicable xDSL Recommendation. Its value ranges from 0 (0.0 dB) to 310 (31.0 dB). The special value 0xFFFF indicates that the maximum noise margin limit is unbounded. (R, W, set-by-create) (mandatory) (2 bytes)

Downstream minimum noise margin: This attribute specifies the minimum noise margin the xTU-R receiver must tolerate. If the noise margin falls below this level, the xTU-R requests the xTU-C to increase its transmit power. If an increase in

xTU-C transmit power is not possible, a loss-of-margin (LOM) defect occurs, the xTU-R fails and attempts to re-initialize, and the PPTP declares a line initialization failure (LINIT) alarm. Its value ranges from 0 (0.0 dB) to 310 (31.0 dB). (R, W, set-by-create) (mandatory) (2 bytes)

Upstream minimum noise margin: This attribute specifies the minimum noise margin the xTU-C receiver must tolerate. If the noise margin falls below this level, the xTU-C requests the xTU-R to increase its transmit power. If an increase in xTU-R transmit power is not possible, an LOM defect occurs, the xTU-C fails and attempts to re-initialize, and the PPTP declares a LINIT alarm. Its value ranges from 0 (0.0 dB) to 310 (31.0 dB). (R, W, set-by-create) (mandatory) (2 bytes)

Downstream rate adaptation mode: The RA-MODEs attribute specifies the mode of operation of a rate-adaptive xTU-C in the transmit direction. The parameter can take four values.

1 Mode 1: MANUAL – Rate changed manually.

At start-up

The minimum data rate attribute of the associated xDSL channel configuration profile specifies the minimum required data rate for each downstream bearer channel, with a noise margin that is at least as large as the specified downstream target noise margin, relative to the required BER for each of the downstream bearer channels. If the xTU-C fails to achieve the minimum data rate for any of the downstream bearer channels, the xTU-C fails to initialize and the PPTP declares a LINIT alarm. Although the xTU-C and the line might be able to support a higher data rate, the xTU-C does not transmit a higher data rate than is requested.

At showtime

The xTU-C transmitter maintains the specified minimum data rate for each of the bearer channels.

2 Mode 2: AT_INIT – Rate automatically selected at start-up only; rate does not change after that.

At start-up

The minimum data rate attribute of the associated xDSL channel configuration profile specifies the minimum required data rate for each downstream bearer channel, with a noise margin that is at least as large as the specified downstream target noise margin, relative to the required BER for each of the downstream bearer channels. If the xTU-C fails to achieve the minimum data rate for any of the downstream bearer channels, the xTU-C fails to initialize and the PPTP declares a LINIT alarm. If the xTU-C transmitter is able to support a higher downstream data rate at initialization, the excess data rate is distributed among the downstream bearer channels according to the weight specified by the rate adaptation ratio attribute of each bearer channel. When the maximum data rate is achieved in one of the downstream bearer channels, the remaining excess rate is assigned to the other bearer channels, still according to their relative rate adaptation ratios. As long as the downstream data rate is below the downstream

maximum data rate for one of the bearer channels, data rate increase takes priority over transmit power reduction.

At showtime

During showtime, no downstream data rate adaptation is allowed. The downstream data rate, determined during initialization for each bearer channel, is maintained.

3 Mode 3: DYNAMIC – Data rate is automatically selected at initialization and is continuously adapted during showtime. The dynamic rate adaptation mode is optional. All related configuration parameters are also optional.

At start-up

The xTU-C starts up as in mode 2.

At showtime

During showtime, rate adaptation is allowed according to the rate adaptation ratios for distributing the excess data rate among the bearer channels, as described in mode 2. The downstream data rate can vary between the downstream minimum data rate and the downstream maximum data rate. Downstream rate adaptation is performed when the conditions specified for downstream upshift noise margin and downstream upshift interval – or for downstream downshift noise margin and downstream downshift interval – are satisfied. This means the following.

- An upshift action is allowed when the downstream noise margin is above the downstream upshift noise margin during the downstream minimum time interval for upshift rate adaptation (RAU; i.e., upon RAU anomaly).
- A downshift action is allowed when the downstream noise margin is below the downstream downshift noise margin during the downstream minimum time interval for downshift rate adaptation (RAD; i.e., upon RAD anomaly).

As long as the downstream data rate is below the maximum data rate for one of the downstream bearer channels, data rate increase takes priority over transmit power reduction.

In ITU-T G.993.2 start-up, if it is detected that seamless rate adaptation (SRA) is supported in the downstream direction by neither xTU, the xTUs fall back to mode 2.

4 Mode 4: DYNAMIC with SOS – Data rate is automatically selected at initialization and is continuously adapted during showtime by SOS and SRA. Rate adaptation mode 4 is optional, but if it is selected, enabling of SOS and SRA is mandatory. This mode is defined only in [ITU-T G.993.2].

At start-up

The xTU-C starts up as in mode 2.

At showtime

SRA behaviour is the same as described for mode 3, unless the actual net data rate is below the minimum net data rate as a result of an SOS procedure.

Additionally, SOS may be performed when the conditions specified by the SOS trigger parameters are satisfied. The detailed specification of the SOS on-line reconfiguration (OLR) procedure appears in [ITU-T G.993.2].

If at start-up, it is detected that SOS is supported in the downstream direction by neither xTU, but SRA is supported by both xTUs, the xTUs fall back to mode 3.

If at start-up, it is detected that neither SOS nor SRA are supported in the downstream direction by both xTUs, the xTUs fall back to mode 2.

(R, W, set-by-create) (mandatory) (1 byte)

Upstream rate adaptation mode: The RA-MODEus attribute specifies the mode of operation of a rate-adaptive xTU-R in the transmit direction. The parameter is used only if rate-adaptive functionality is supported. It can take four values:

- 1 MANUAL
- 2 AT_INIT
- 3 DYNAMIC
- 4 DYNAMIC with SOS

The definition of each of the values is identical to its definition in the downstream rate adaptation mode, replacing xTU-C with xTU-R and downstream with upstream. (R, W, set-by-create) (mandatory) (1 byte)

Downstream upshift noise margin: If the downstream noise margin is above the downstream upshift noise margin and remains there for more than the time specified by the downstream minimum time interval for upshift rate adaptation, the xTU-R attempts to increase the downstream net data rate. This attribute ranges from 0 (0.0 dB) to 310 (31.0 dB). (R, W, set-by-create) (optional) (2 bytes)

Upstream upshift noise margin: If the upstream noise margin is above the upstream upshift noise margin and remains there for more than the time specified by the upstream minimum time interval for upshift rate adaptation, the xTU-C attempts to increase the upstream net data rate. This attribute ranges from 0 (0.0 dB) to 310 (31.0 dB). (R, W, set-by-create) (optional) (2 bytes)

Upstream PSD mask selection: This attribute enables one of several upstream PSD masks. It is used only for Annexes J and M of [ITU-T G.992.3] and [ITU-T G.992.5]. The same mask selection applies to all relevant modes enabled in the xTSE line configuration parameter (Table 9.7.12-1). This attribute selects the mask with the following definition.

Annex J of ITU-T G.992.3, .5**Annex M of ITU-T G.992.3, .5**

1	ADLU-32	EU-32
2	ADLU-36	EU-36
3	ADLU-40	EU-40
4	ADLU-44	EU-44
5	ADLU-48	EU-48
6	ADLU-52	EU-52
7	ADLU-56	EU-56
8	ADLU-60	EU-60
9	ADLU-64	EU-64

(R, W, set-by-create) (mandatory) (1 byte)

Minimum overhead rate upstream: This attribute specifies the minimum rate of the message based overhead to be maintained by the xTU in the upstream direction. MSGMINus ranges from 4000 to 248 000 bit/s. The value 0 specifies that the ONU uses its internal default. This attribute is only valid for [ITU T G.992.3], [ITU T G.992.4], [ITU T G.992.5] and [ITU-T G.993.2]. (R, W, set-by-create) (optional) (2 bytes)

NOTE 2 – For compatibility with previous versions of the OMCI, values between 4000 and 65535 are interpreted as bits per second. To align with [ITU-T G.997.1], values between 4 and 248 are interpreted as kilobits per second. For maximum flexibility, the ONU should support both conventions.

Minimum overhead rate downstream: This attribute specifies the minimum rate of the message based overhead to be maintained by the xTU in the downstream direction. MSGMINds ranges from 4000 to 248 000 bit/s. The value 0 specifies that the ONU uses its internal default. This attribute is only valid for [ITU-T G.992.3], [ITU T G.992.4], [ITU T G.992.5] and [ITU-T G.993.2]. (R, W, set-by-create) (optional) (2 bytes)

NOTE 3 – For compatibility with previous versions of the OMCI, values between 4000 and 65535 are interpreted as bits per second. To align with [ITU-T G.997.1], values between 4 and 248 are interpreted as kilobits per second. For maximum flexibility, the ONU should support both conventions.

Actions

Create, delete, get, set

Notifications

None.

9.7.4 xDSL line configuration profile part 2

The overall xDSL line configuration profile is modelled in several parts, all of which are associated together through a common ME ID (the client PPTP xDSL UNI part 1 has a single pointer, which refers to the entire set of line configuration profile parts).

Relationships

An instance of this ME may be associated with zero or more instances of an xDSL UNI.

Attributes

Managed entity ID: This attribute uniquely identifies each instance of this ME. All xDSL and VDSL2 line configuration profiles and extensions that pertain to a given PPTP xDSL UNI must share a common ME ID. (R, set-by-create) (mandatory) (2 bytes)

Downstream minimum time interval for upshift rate adaptation: This parameter defines the interval during which the downstream noise margin must remain above the downstream upshift noise margin before the xTU-R attempts to increase the downstream net data rate. Its value ranges from 0 to 16383 s. (R, W, set-by-create) (optional) (2 bytes)

Upstream minimum time interval for upshift rate adaptation: This parameter defines the interval during which the upstream noise margin must remain above the upstream upshift noise margin before the xTU-C attempts to increase the upstream net data rate. Its value ranges from 0 to 16383 s. (R, W, set-by-create) (optional) (2 bytes)

Downstream downshift noise margin: If the downstream noise margin is below the downstream downshift noise margin and remains there for more than the downstream minimum time interval for downshift rate adaptation, the xTU-R attempts to decrease the downstream net data rate. This attribute's value ranges from 0 (0.0 dB) to 310 (31.0 dB). (R, W, set-by-create) (optional) (2 bytes)

Upstream downshift noise margin: If the upstream noise margin is below the upstream downshift noise margin and remains there for more than the upstream minimum time interval for downshift rate adaptation, the xTU-C attempts to decrease the upstream net data rate. This attribute's value ranges from 0 (0.0 dB) to 310 (31.0 dB). (R, W, set-by-create) (optional) (2 bytes)

Downstream minimum time interval for downshift rate adaptation: This parameter defines the interval during which the downstream noise margin must remain below the downstream downshift noise margin before the xTU-R attempts to decrease the downstream net data rate. Its value ranges from 0 to 16383 s. (R, W, set-by-create) (optional) (2 bytes)

Upstream minimum time interval for downshift rate adaptation: This parameter defines the interval during which the upstream noise margin must remain below the upstream downshift noise margin before the xTU-C attempts to decrease the upstream net data rate. Its value ranges from 0 to 16383 s. (R, W, set-by-create) (optional) (2 bytes)

xTU impedance state forced: This parameter forces the impedance state of the xTU-C. It applies only to the T/S interface, and is deprecated in the OMCI, which stands proxy for the Q interface. It is only valid for Annex A of [ITU-T G.992.3], Annex A of [ITU-T G.992.4] and Annex A of [ITU-T G.992.5]. It is defined as follows.

- 1 Force the xTU-C to the disabled state.
- 2 Force the xTU-C to the inactive state.
- 3 Force the xTU-C to the active state.

(R, W, set-by-create) (optional) (1 byte)

L0-time: This parameter specifies the minimum time between an exit from the L2 state and the next entry into the L2 state. It is only valid for [ITU-T G.992.3], [ITU-T G.992.4] and [ITU-T G.992.5]. It ranges from 0 to 255 s. (R, W, set-by-create) (mandatory) (1 byte)

L2-time: This parameter specifies the minimum time between an entry into the L2 state and the first power trim in the L2 state, or between two consecutive power trims in the L2 state. It is only valid for [ITU-T G.992.3], [ITU-T G.992.4] and [ITU-T G.992.5]. It ranges from 0 to 255 s. (R, W, set-by-create) (mandatory) (1 byte)

Downstream maximum nominal power spectral density: This attribute specifies the maximum nominal transmit PSD in the downstream direction during initialization and showtime. A single MAXNOMPSDds attribute is defined per mode enabled in the xTSE line configuration attribute. It is only valid for [ITU-T G.992.3], [ITU-T G.992.4] and [ITU-T G.992.5]. Its value ranges from 0 (−60.0 dBm/Hz) to 300 (−30 dBm/Hz). (R, W, set-by-create) (mandatory) (2 bytes)

Upstream maximum nominal power spectral density: This attribute specifies the maximum nominal transmit PSD in the upstream direction during initialization and showtime. A single MAXNOMPSDus attribute is defined per mode enabled in the xTSE line configuration attribute. It is only valid for [ITU-T G.992.3], [ITU-T G.992.4] and [ITU-T G.993.2]. Its value ranges from 0 (−60.0 dBm/Hz) to 300 (−30 dBm/Hz). (R, W, set-by-create) (mandatory) (2 bytes)

Downstream maximum nominal aggregate transmit power: This attribute specifies the maximum nominal aggregate transmit power in the downstream direction during initialization and showtime. It is only valid for [ITU-T G.992.3], [ITU-T G.992.4], [ITU-T G.992.5] and [ITU-T G.993.2]. Its value ranges from 0 (0.0 dBm) to 255 (25.5 dBm). (R, W, set-by-create) (mandatory) (1 byte)

Upstream maximum nominal aggregate transmit power: This parameter specifies the maximum nominal aggregate transmit power in the upstream direction during initialization and showtime. It is only valid for [ITU-T G.992.3], [ITU-T G.992.4] and [ITU-T G.992.5]. Its value ranges from 0 (0.0 dBm) to 255 (25.5 dBm). (R, W, set-by-create) (mandatory) (1 byte)

Upstream maximum aggregate receive power: This parameter specifies the maximum upstream aggregate receive power over a set of subcarriers, as defined in the relevant Recommendation. The xTU-C requests an upstream power cutback such that the upstream aggregate receive power over that set of subcarriers is at or below the configured maximum value. It is only valid for [ITU-T G.992.3], [ITU-T G.992.4] and [ITU-T G.992.5]. This attribute ranges from 0 (−25.5 dBm) to 510 (+25.5 dBm). The special value 0xFFFF indicates that no upstream maximum aggregate receive power limit is to be applied. (R, W set-by-create) (mandatory) (2 bytes)

VDSL2 transmission system enabling: This configuration attribute extends the transmission system coding types to be allowed by the xTU-C. It is a bit map, defined as octet 8 (bits 57..64) in Table 9.7.12-1. (R, W, set-by-create) (optional) (1 byte)

Actions

Create, delete, get, set

Notifications

None.

9.7.5 xDSL line configuration profile part 3

The overall xDSL line configuration profile is modelled in several parts, all of which are associated together through a common ME ID (the client PPTP xDSL UNI part 1 has a single pointer, which refers to the entire set of line configuration profile parts).

Relationships

An instance of this ME may be associated with zero or more instances of an xDSL UNI.

Attributes

Managed entity ID: This attribute uniquely identifies each instance of this ME. All xDSL and VDSL2 line configuration profiles and extensions that pertain to a given PPTP xDSL UNI must share a common ME ID. (R, set-by-create) (mandatory) (2 bytes)

Loop diagnostics mode forced (LDSF): This configuration parameter forces the line into loop diagnostic mode via the xTU-C. It is only valid for [ITU-T G.992.3], [ITU-T G.992.4] and [ITU-T G.992.5]. It is defined as follows.

- 0 Inhibits the xTU-C from performing loop diagnostic mode procedures on the line. Loop diagnostic mode procedures may still be initiated by the xTU-R.
- 1 Forces the xTU-C to perform loop diagnostics procedures.

Only while the line power management state is L3 can the line be forced into loop diagnostic mode. When loop diagnostic procedures complete successfully, the ONU resets this attribute to 0. The line remains in the L3 idle state. The loop diagnostics data are available at least until the line is forced to the L0 state. As long as loop diagnostic procedures have not completed successfully, attempts are made to do so, until the loop diagnostic mode is no longer forced on the line through this configuration parameter. If loop diagnostic procedures cannot be completed successfully after a vendor-discretionary number of retries or within a vendor-discretionary timeout, then an initialization failure occurs. (R, W, set-by-create) (mandatory) (1 byte)

Automode cold start forced: This attribute is defined to improve testing of the performance of xTUs supporting automode. Valid values are 0 and 1. A change in value of this attribute indicates a change in loop conditions applied to the devices under test. The xTUs reset any historical information used for automode, for shortening an ITU-T G.994.1 handshake, or for shortening the initialization procedure.

Automode is defined as the case where multiple operation modes are enabled in xTSE (Table 9.7.12-1) and where the selection of the operation mode to be used for transmission depends, not only on the common capabilities of both xTUs (as exchanged in [ITU-T G.994.1]), but also on achievable data rates under given loop conditions. (R, W, set-by-create) (mandatory if automode is supported) (1 byte)

L2-ATPR: This parameter specifies the maximum aggregate transmit power reduction that can be performed in the L2 request (i.e., at the transition of L0 to L2 state) or through a single power trim in the L2 state. It is only valid for [ITU-T G.992.3], [ITU-T G.992.4] and [ITU-T G.992.5]. This attribute ranges from 0 (0 dB) dB to 31 (31 dB). (R, W, set-by-create) (mandatory) (1 byte)

L2-ATPRT: This parameter specifies the total maximum aggregate transmit power reduction (in decibels) that can be performed in an L2 state. This is the sum of

all reductions of L2 requests (i.e., at transitions from L0 to L2 state) and power trims. This attribute ranges from 0 (0 dB) dB to 31 (31 dB). (R, W, set-by-create) (mandatory) (1 byte)

Force INP downstream: When set to 1, the FORCEINPds attribute forces the framer settings of all downstream bearer channels to be selected such that the impulse noise protection (INP) computed according to the formula specified in the relevant Recommendation is greater than or equal to the minimal INP requirement. The default value 0 disables this function. (R, W) (mandatory for [ITU-T G.993.2], optional for other Recommendations that support it) (1 byte)

Force INP upstream: When set to 1, the FORCEINPus attribute forces the framer settings of all upstream bearer channels to be selected such that the INP computed according to the formula specified in the relevant Recommendation is greater than or equal to the minimal INP requirement. The default value 0 disables this function. (R, W) (mandatory for [ITU-T G.993.2], optional for other Recommendations that support it) (1 byte)

Update request flag for near-end test parameters: The UPDATE-TEST-NE attribute forces an update of all near-end test parameters that can be updated during showtime in [ITU-T G.993.2]. Update is triggered by setting this attribute to 1, whereupon the near-end test parameters are expected to be updated within 10 s, and the ONU should reset the attribute value to 0. The update request flag is independent of any autonomous update process in the system. The update request attribute must be prepared to accept another set after a period not to exceed 3 min, a period that starts when the flag is set via the OMCI or by an autonomous process in the system. (R, W) (optional) (1 byte)

Update request flag for far-end test parameters: The UPDATE-TEST-FE attribute forces an update of all far-end test parameters that can be updated during showtime in [ITU-T G.993.2]. Update is triggered by setting this attribute to 1, whereupon the far-end test parameters are expected to be updated within 10 s, and the ONU should reset the attribute value to 0. The update request flag is independent of any autonomous update process in the system. The update request attribute must be prepared to accept another set after a period not to exceed 3 min, a period that starts when the flag is set via the OMCI or by an autonomous process in the system. (R, W) (optional) (1 byte)

The following eight attributes configure the impulse noise monitoring (INM) function, whose results are available via the xDSL impulse noise monitor PM history data ME. The downstream attributes are applicable to [ITU-T G.993.2], [ITU-T G.992.3] and [ITU-T G.992.5]. Only [ITU-T G.993.2] supports the upstream attributes.

INM inter-arrival time offset upstream: INMIATOUS is the inter-arrival time (IAT) offset that the xTU-C receiver uses to determine in which bin of the IAT histogram the IAT is reported. Valid values for INMIATO range from 3 to 511 discrete multi-tone (DMT) symbols in steps of 1 DMT symbol. (R, W) (optional) (2 bytes)

INM inter-arrival time step upstream: INMIATSus is the IAT step that the xTU-C receiver uses to determine in which bin of the IAT histogram the IAT is reported. Valid values for INMIATS range from 0 to 7 in steps of 1. (R, W) (optional) (1 byte)

INM cluster continuation value upstream: INMCCus is the cluster continuation value that the xTU-C receiver uses in the cluster indication process described in the applicable Recommendation. Valid values for INMCC range from 0 to 64 DMT symbols in steps of 1 DMT symbol. (R, W) (optional) (1 byte)

INM equivalent INP mode upstream: INM_INPEQ_MODE_{Us} is the INM equivalent INP mode that the xTU-C receiver uses in the computation of the equivalent INP, as defined in the applicable Recommendation. Valid values for INM_INPEQ_MODE are 0..4. (R, W) (optional) (1 byte)

INM inter-arrival time offset downstream: INMIAT_{Os} is the IAT offset that the xTU-R receiver uses to determine in which bin of the IAT histogram the IAT is reported. Valid values for INMIATO range from 3 to 511 DMT symbols in steps of 1 DMT symbol. (R, W) (optional) (2 bytes)

INM inter-arrival time step downstream: INMIAT_{Ss} is the IAT step that the xTU-R receiver uses to determine in which bin of the IAT histogram the IAT is reported. Valid values for INMIATS range from 0 to 7 in steps of 1. (R, W) (optional) (1 byte)

INM cluster continuation value downstream: INMCC_{ds} is the cluster continuation value that the xTU-R receiver uses in the cluster indication process described in the applicable Recommendation. Valid values for INMCC range from 0 to 64 DMT symbols in steps of 1 DMT symbol. (R, W) (optional) (1 byte)

INM equivalent INP mode downstream: INM_INPEQ_MODE_{Eds} is the INM equivalent INP mode that the xTU-R receiver uses in the computation of the equivalent INP, as defined in the applicable Recommendation. Valid values for INM_INPEQ_MODE are 0..4. (R, W) (optional) (1 byte)

Actions

Create, delete, get, set

Notifications

Attribute value change

Number	Attribute value change	Description
1..6	N/A	
7	Update request NE	Need only be reported on the 1 → 0 transition to signal to the OLT that test parameters have been updated.
8	Update request FE	Need only be reported on the 1 → 0 transition to signal to the OLT that test parameters have been updated.
9..16	N/A	

9.7.6 VDSL2 line configuration extensions

This ME extends the xDSL line configuration MEs with attributes that were originally unique to ITU-T G.993.2 VDSL2. Due to continuing standards development, some attributes – and therefore this ME – have also become applicable to other Recommendations, specifically [ITU-T G.992.3] and [ITU-T G.992.5]. The attributes of this ME are further defined in [ITU-T G.997.1]. An instance of this ME is created and deleted by the OLT.

Relationships

An instance of this ME may be associated with zero or more instances of an xDSL UNI.

The overall xDSL line configuration profile is modelled in several parts, all of which are associated together through a common ME ID (the client PPTP xDSL UNI part 1 has a single pointer, which refers to the entire set of line configuration parts).

Attributes

Managed entity ID: This attribute uniquely identifies each instance of this ME. All xDSL and VDSL2 line configuration profiles and extensions that pertain to a given PPTP xDSL UNI must share a common ME ID. (R, set-by-create) (mandatory) (2 bytes)

VDSL2 profiles enabling: The PROFILES attribute contains the ITU-T G.993.2 profiles to be allowed by the xTU-C. It is coded in a bit map representation (0 if not allowed, 1 if allowed) with the following definition.

Bit	Meaning
1 (LSB)	ITU-T G.993.2 profile 8a
2	ITU-T G.993.2 profile 8b
3	ITU-T G.993.2 profile 8c
4	ITU-T G.993.2 profile 8d
5	ITU-T G.993.2 profile 12a
6	ITU-T G.993.2 profile 12b
7	ITU-T G.993.2 profile 17a
8	ITU-T G.993.2 profile 30a

(R, W, set-by-create) (mandatory for ITU-T G.993.2) (1 byte)

VDSL2 PSD mask class selection (CLASSMASK): To reduce the number of configuration possibilities, the limit PSD masks are grouped in the following PSD mask classes.

- Class 998 Annex A of [ITU-T G.993.2]: D-32, D-48, D-64, D-128
- Class 997-M1c Annex B of [ITU-T G.993.2]: 997-M1c-A-7
- Class 997-M1x Annex B of [ITU-T G.993.2]: 997-M1x-M
- Class 997-M2x Annex B of [ITU-T G.993.2]: 997E17-M2x-NUS0, 997E30-M2x-NUS0
- Class 998-M2x Annex B of [ITU-T G.993.2]: 998-M2x-A, 998-M2x-M, 998-M2x-B, 998-M2x-NUS0, 998E17-M2x-NUS0, 998E17-M2x-NUS0-M, 998E30-M2x-NUS0, 998E30-M2x-NUS0-M, 998E17-M2x-A
- Class 998ADE-M2x Annex B of [ITU-T G.993.2]: 998-M2x-A, 998-M2x-M, 998-M2x-B, 998-M2x-NUS0, 998ADE17-M2x-A, 998ADE17-M2x-B, 998ADE17-M2x-M, 998ADE17-M2x-NUS0-M, 998ADE30-M2x-NUS0-A, 998ADE30-M2x-NUS0-M, HPEADE1230, HPEADE1730
- Class 998-B Annex C: POTS-138b, POTS-276b (clause C.2.1.1 of [ITU-T G.993.2]), TCM-ISDN (clause C.2.1.2 of [ITU-T G.993.2])
- Class 998-CO Annex C of [ITU-T G.993.2]: POTS-138co, POTS-276co (clause C.2.1.1 of [ITU-T G.993.2])
- Class HPE-M1 Annex B of [ITU-T G.993.2]: HPE17-M1-NUS0, HPE30-M1-NUS0, HPE1230-M1-NUS0, HPE1730-M1-NUS0

Each class is designed such that the PSD levels of each limit PSD mask of a specific class are equal in their respective passbands above 552 kHz.

The CLASSMASK attribute is defined per annex of [ITU-T G.993.2] enabled in the xTSE table (see Table 9.7.12-1). It selects a single PSD mask class per annex of [ITU-T G.993.2] to be activated at the very high-speed digital subscriber line transceiver unit, operator end (VTU-O). The coding is as follows:

Attribute value	Annex A of [ITU-T G.993.2]	Annex B of [ITU-T G.993.2]	Annex C of [ITU-T G.993.2]
1	998	997-M1c	998-B
2		997-M1x	998-CO
3		997-M2x	
4		Deprecated	
5		998-M2x	
6		998ADE-M2x	
7		HPE	

NOTE 1 – A single PSD mask class may be selected per annex of [ITU-T G.993.2].

NOTE 2 – It is expected that only a single annex will be enabled at any given time, such that the CLASSMASK attribute, as well as the LIMITMASK and US0DISABLE attributes below, need not be vectors of values.

NOTE 3 – Attribute value 4 was formerly defined in [ITU-T G.997.1], and is no longer used.

(R, W, set-by-create) (mandatory) (1 byte)

VDSL2 limit PSD masks: The LIMITMASK attribute contains the ITU-T G.993.2 limit PSD masks of the selected PSD mask class, enabled by the near-end xTU for each class of profiles. One LIMITMASK parameter is defined per annex enabled in the xTSE (see Table 9.7.12-1).

The profiles are grouped in the following profile classes:

- Class 8: Profiles 8a, 8b, 8c, 8d
- Class 12: Profiles 12a, 12b
- Class 17: Profile 17a
- Class 30: Profile 30a

For each profile class, several limit PSD masks of the selected PSD mask class (CLASSMASK) may be enabled. The enabling attribute is coded in a bit map representation (0 if the associated mask is not allowed, 1 if it is allowed). The bit mask is defined in Table 9.7.6-1. (R, W, set-by-create) (mandatory) (8 bytes)

VDSL2 US0 disabling: The US0DISABLE attribute specifies whether channel US0 is disabled for each limit PSD mask enabled in the LIMITMASK attribute.

For each limit PSD mask enabled in the LIMITMASK attribute, one bit indicates if US0 is disabled. The disabling attribute is a bit map where the value 1 specifies that US0 is disabled for the associated limit mask. The bit map has the same structure as the LIMITMASK attribute. (R, W, set-by-create) (mandatory) (8 bytes)

VDSL2 US0 PSD masks: The US0MASK attribute contains the US0 PSD masks to be allowed by the xTU-C. This attribute is only defined for Annex A of [ITU-T G.993.2]. It is represented as a bit map (0 if not allowed, 1 if allowed)

with the definitions of Table 9.7.6-2. (R, W, set-by-create) (mandatory)
(4 bytes)

VDSL2-CARMASK table: This attribute specifies restrictions, additional to the band plan, that determine the set of subcarriers allowed for transmission in both upstream and downstream directions.

The VDSL2-CARMASK attribute describes the not-masked subcarriers in terms of one or more frequency bands. Each band is represented by start and stop subcarrier indices with a subcarrier spacing of 4.3125 kHz. The valid range of subcarrier indices is from 0 to at least the index of the highest allowed subcarrier in both transmission directions among all profiles enabled by the VDSL2 profiles enabling (PROFILES) attribute. Up to 32 bands may be specified. Other subcarriers are masked.

For profiles using 8.625 kHz tone spacing, the odd subcarrier indices $i_{4.3125}$ in VDSL2-CARMASK can be transformed into actual subcarrier indices $i_{8.625}$ using the following rule:

- for the start frequency of each band: $i_{8.625} = (i_{4.3125} + 1)/2$
- for the stop frequency of each band: $i_{8.625} = (i_{4.3125} - 1)/2$.

The VDSL2-CARMASK attribute is a table where each entry comprises:

- an entry number field (1 byte, first entry numbered 1);
- band start subcarrier index (2 bytes);
- band stop subcarrier index (2 bytes).

By default, the table is empty. Entries are added or modified using the set action. Setting a table entry with non-zero subcarrier references implies insertion into the table. Setting an entry's subcarrier references to zero implies deletion from the table, if present.

The maximum number of bands is 32, so the maximum size of the table is 160 bytes. (R, W) (mandatory) ($5 * N$ bytes, where N is the number of bands)

CARMASK valid: This attribute controls and reports the status of the VDSL2-CARMASK table. If CARMASK valid = 1, then the VDSL2-CARMASK has been effectuated on the xDSL equipment. If CARMASK valid = 0 (default), then the VDSL2-CARMASK table is under construction and has not been effectuated on the xDSL equipment.

This attribute behaves as follows.

- If the OLT changes any of the VDSL2-CARMASK table entries or sets CARMASK valid = 0, then CARMASK valid = 0.
- If CARMASK valid = 0 and the OLT sets CARMASK valid = 1, then the ONU updates the xDSL equipment with the contents of the table.

(R, W) (mandatory) (1 byte)

UPBOSHAPED: Upstream power back-off (UPBO) is specified in [ITU-T G.993.2] to provide spectral compatibility between loops of different lengths deployed in the same cable binder. The upstream transmit PSD mask, UPBOMASKus is defined in clause 7.2.1.3.2 of [ITU-T G.993.2].

The ITU-T G.993.2 UPBO configuration attributes a and b are set by the OLT via this attribute. The reference length kl_{0_REF} is set by the companion attribute UPBO kl_{REF-pb} , defined in the following. Further details appear in [ITU-T G.997.1].

This attribute includes two parameters for each band. The parameters are a and b , in that order. Parameter a lies in the range 4000 (40.00 dBm/Hz) to 8095 (80.95 dBm/Hz). Parameter b lies in the range 0 (0.00 dBm/Hz) to 4095 (40.95 dBm/Hz). The special values $a = b = 0$ disable UPBO in the respective upstream band.

The upstream electrical length parameter UPBOKL defines the electrical length expressed in decibels at 1 MHz, kl_0 , which may also be configured by the OLT. Its value ranges from 0 (0.0 dB) to 1280 (128.0 dB).

If the force electrical length parameter UPBOKLF is 1, the very high-speed digital subscriber line transceiver unit, remote end (VTU-R) is forced to use the electrical length from this attribute (UPBOKL) to compute UPBO. Otherwise, the VDSL2 transceiver units (VTUs) determine the electrical length themselves.

Upstream band 1	a	2 bytes
	b	2 bytes
Upstream band 2	a	2 bytes
	b	2 bytes
Upstream band 3	a	2 bytes
	b	2 bytes
Upstream band 4	a	2 bytes
	b	2 bytes
Upstream band 5	a	2 bytes
	b	2 bytes
UPBOKL		2 bytes
UPBOKLF		1 byte

(R, W) (mandatory) (23 bytes)

Cyclic extension: The CEFLAG attribute enables (1) the optional cyclic extension values. If set to 0, the cyclic extension is forced to the mandatory length $5N/32$. (R, W) (mandatory) (1 byte)

Downstream signal-to-noise ratio (SNR) mode: The SNRMODEd attribute controls transmitter referred virtual noise in the downstream direction. If set to 1, virtual noise is disabled. If set to 2, virtual noise is enabled. (R, W) (mandatory) (1 byte)

Upstream SNR mode: The SNRMODEu attribute controls transmitter referred virtual noise in the upstream direction. If set to 1, virtual noise is disabled. If set to 2, virtual noise is enabled. (R, W) (mandatory) (1 byte)

Transmitter referred virtual noise downstream table: The TXREFVNd table defines the downstream transmitter referred virtual noise. TXREFVNd is specified through a set of breakpoints. Each breakpoint comprises a subcarrier index t , with a subcarrier spacing of 4.3125 kHz, and a noise PSD level at that subcarrier. The set of breakpoints can then be represented as $[(t_1, \text{PSD}_1), (t_2, \text{PSD}_2), \dots, (t_N, \text{PSD}_N)]$. The subcarrier index t is an unsigned 2 byte integer. The noise level is 1 byte whose value ranges from 0 (–40 dBm/Hz) to 200 (–140 dBm/Hz), in steps of 0.5 dB. Values between 201 and 254 indicate a noise PSD level of 0 W/Hz. The maximum number of breakpoints is 32; no more

than 15 breakpoints may be configured below the upper edge of the passband of every mode enabled for [ITU-T G.992.3] and [ITU-T G.992.5].

Table entries for this attribute have the default value 254 for the noise PSD level. Entries are added or modified using the set action. Setting an entry to a noise PSD level less than or equal to 254 implies insertion into the table. Setting an entry's noise PSD level to 255 implies deletion from the table, if present.

(R, W) (optional) ($3N$ bytes, where N is the number of breakpoints)

Transmitter referred virtual noise upstream table: The TXREFVNus attribute defines the upstream transmitter referred virtual noise. TXREFVNus is specified through a set of breakpoints. Each breakpoint comprises a subcarrier index t , with a subcarrier spacing of 4.3125 kHz, and a noise PSD level at that subcarrier. The set of breakpoints can then be represented as $[(t_1, PSD_1), (t_2, PSD_2), \dots, (t_N, PSD_N)]$. The subcarrier index t is an unsigned 2 byte integer. The noise level is 1 byte whose value ranges from 0 (−40 dBm/Hz) to 200 (−140 dBm/Hz), in steps of 0.5 dB. Values between 201 and 254 indicate a noise PSD level of 0 W/Hz. The maximum number of breakpoints is 16; no more than three breakpoints may be configured below the upper edge of the passband of every mode enabled for [ITU-T G.992.3] and [ITU-T G.992.5].

Table entries for this attribute have the default value 254 for the noise PSD level. Entries are added or modified using the set action. Setting an entry to a noise PSD level less than or equal to 254 implies insertion into the table. Setting an entry's noise PSD level to 255 implies deletion from the table, if present.

(R, W) (optional) ($3N$ bytes, where N is the number of breakpoints)

DPBOSHAPED: Downstream power back-off – shaped is described in [ITU-T G.997.1] as a vector of parameters that modifies the downstream PSD mask.

DPBOEPSD – Assumed exchange PSD mask. This component points to a downstream xDSL PSD mask profile ME. The PSD mask profile should contain no more than 16 break points. (2 bytes)

DPBOESEL – E-side electrical length. This component is the assumed loss at some reference frequency of the electrical cable from the xDSL equipment to a possible flexibility point. It ranges from 0 (0.0 dB) to 511 (255.5 dB) in steps of 0.5 dB. The value 0 has the special meaning that it disables the DPBOSHAPED feature. (2 bytes)

The following three parameters describe the cable model. Further details appear in [ITU-T G.997.1]. Each is a scalar that represents the range −1 (coded as 0) to +1.5 (coded as 640) in steps of 1/256.

DPBOESCMA – (2 bytes)

DPBOESCMB – (2 bytes)

DPBOESCMC – (2 bytes)

DPBOMUS – Assumed minimum usable receive PSD mask. This component ranges from 0 (0.0 dBm/Hz) to 255 (−127.5 dBm/Hz) in steps of 0.5 dB. (1 byte)

DPBOFMIN – The lower frequency bound above which DPBO is applied. This component ranges from 0 (0.00 kHz) to 2048 (8832.00 kHz) in steps of 4.3125 kHz. (2 bytes)

DPBOFMAX – The upper frequency bound below which DPBO is applied. This component ranges from 32 (138.00 kHz) to 6956 (29997.75 kHz) in steps of 4.3125 kHz. (2 bytes)

(R, W) (optional) (15 bytes)

UPBOKLREF-pb: This attribute represents the reference loop length, the electrical length used to compute upstream power back-off (UPBO) for each upstream band except US₀, for the optional equalized FEXT UPBO method. The value for each upstream band ranges from 1.8 to 63.5 dB in steps of 0.1 dB, i.e., with values 18..635. The special value 0 is also allowed, with semantics as defined in clause 7.2.1.3.2 of [ITU-T G.993.2]. (R, W) (optional) (2 bytes * 5 upstream bands)

UPBOSHAPED (AELE-MODE, UPBOELMT): This attribute defines the UPBO electrical length estimation mode (AELE-MODE) and UPBO electrical length minimum threshold percentile (UPBOELMT) to be used in the alternative electrical length estimation method (ELE-M1). The format of this attribute is given in octet 1 of Table 12-27 of [ITU-T G.993.2]. (R, W) (optional) (1 byte)

Actions

Create, delete, get, get next, set

Set table (optional)

Notifications

None.

Table 9.7.6-1 – Limit mask definitions for each class mask

Bit	PSD mask classes									
	Annex A	Annex B							Annex C	
	998 Annex A	998-M2x Annex B	998ADE-M2x Annex B	997-M1x Annex B	997-M1c Annex B	997-M2x Annex B	HPE-M1 Annex B	998-B Annex C	998-CO Annex C	
Octet 1, profile class 8										
1	D-32		M2x-A	M2x-A		M1c-A-7		POTS-138b	POTS-138co	
2	D-48		M2x-B	M2x-B				TCM-ISDN	POTS-276co	
3			M2x-M	M2x-M	M1x-M			POTS-276b		
4			M2x-NUS0	M2x-NUS0						
5										
6										
7										
8										
Octet 2, profile class 8										
1	D-64									
2	D-128									
3										
4										
5										
6										
7										
8										
Octet 3, profile class 12										
1	D-32		M2x-A	M2x-A				POTS-138b	POTS-138co	
2	D-48		M2x-B	M2x-B				TCM-ISDN	POTS-276co	
3			M2x-M	M2x-M	M1x-M			POTS-276b		
4			M2x-NUS0	M2x-NUS0						
5										
6										
7										
8										
Octet 4, profile class 12										
1	D-64									
2	D-128									
3										
4										
5										
6										
7										
8										
Octet 5, profile class 17										

Table 9.7.6-1 – Limit mask definitions for each class mask

Bit	PSD mask classes									
	Annex A	Annex B							Annex C	
	998 Annex A		998-M2x Annex B	998ADE-M2x Annex B	997-M1x Annex B	997-M1c Annex B	997-M2x Annex B	HPE-M1 Annex B	998-B Annex C	998-CO Annex C
1	D-32		E17-M2x-NUS0	ADE17-M2x-A			E17-M2x-NUS0	17-M1-NUS0	POTS-138b	
2	D-48		E17-M2x-NUS0-M	ADE17-M2x-B					TCM-ISDN	
3			E17-M2x-A	ADE17-M2x-NUS0-M					POTS-276b	
4				ADE17-M2x-M						
5										
6										
7										
8										
Octet 6, profile class 17										
1	D-64									
2	D-128									
3										
4										
5										
6										
7										
8										
Octet 7, profile class 30										
1	D-32		E30-M2x-NUS0	ADE30-M2x-NUS0-A			E30-M2x-NUS0	30-M1-NUS0	POTS-138b	
2	D-48		E30-M2x-NUS0-M	ADE30-M2x-NUS0-M				1230-M1-NUS0	TCM-ISDN	
3				HPEADE 1230-NUS0				1730-M1-NUS0	POTS-276b	
4				HPEADE 1730-NUS0						
5										
6										
7										
8										

Table 9.7.6-1 – Limit mask definitions for each class mask

Bit	PSD mask classes									
	Annex A	Annex B							Annex C	
	998 Annex A	998-M2x Annex B	998ADE-M2x Annex B	997-M1x Annex B	997-M1c Annex B	997-M2x Annex B	HPE-M1 Annex B	998-B Annex C	998-CO Annex C	
Octet 8, profile class 30										
1	D-64									
2	D-128									
3										
4										
5										
6										
7										
8										
NOTE – All unassigned bits are reserved.										

NOTE – Some entries in this table have been modified relative to earlier versions of this Recommendation. See [ITU-T G.997.1] for details.

Table 9.7.6-2 – VDSL2 US0 PSD masks definition

Bit	US0MASK, Annex A of [ITU-T G.993.2]
<i>Octet 1</i>	
1	EU-32
2	EU-36
3	EU-40
4	EU-44
5	EU-48
6	EU-52
7	EU-56
8	EU-60
<i>Octet 2</i>	
1	EU-64
2	EU-128
3	Reserved
4	Reserved
5	Reserved
6	Reserved
7	Reserved
8	Reserved
<i>Octet 3</i>	
1	ADLU-32
2	ADLU-36
3	ADLU-40
4	ADLU-44
5	ADLU-48

Table 9.7.6-2 – VDSL2 US0 PSD masks definition

6	ADLU-52
7	ADLU-56
8	ADLU-60
<i>Octet 4</i>	
9	ADLU-64
10	ADLU-128
11	Reserved
12	Reserved
13	Reserved
14	Reserved
15	Reserved
16	Reserved
NOTE 1 – Valid combinations of US0MASK and LIMITMASK are described in [ITU-T G.993.2].	
NOTE 2 – More than one mask may be enabled simultaneously. If no US0 PSD masks are enabled, the line is configured without US0 support.	

9.7.7 xDSL channel configuration profile

This ME contains the channel configuration profile for an xDSL UNI. An instance of this ME is created and deleted by the OLT.

NOTE – If [ITU-T G.997.1] compatibility is required, bit rates should only be set to integer multiples of 1000 bits/s. The ONU may reject attempts to set other values for bit rate attributes.

Relationships

An instance of this ME may be associated with zero or more instances of the PPTP xDSL UNI part 1.

Attributes

Managed entity ID: This attribute uniquely identifies each instance of this ME. The value 0 is reserved. (R, set-by-create) (mandatory) (2 bytes)

Minimum data rate: This parameter specifies the minimum desired net data rate for the bearer channel. It is coded in bits per second. (R, W, set-by-create) (mandatory) (4 bytes)

Maximum data rate: This parameter specifies the maximum desired net data rate for the bearer channel. It is coded in bits per second. (R, W, set-by-create) (mandatory) (4 bytes)

Rate adaptation ratio: This attribute specifies the weight that should be taken into account when performing rate adaptation in the direction of the bearer channel. The attribute is defined as a percentage. The value 20, for example, means that 20% of the available data rate (in excess of the minimum data rate summed over all bearer channels) is assigned to this bearer channel and 80% to the other bearer channels. The OLT must ensure that the sum of rate adaptation ratios over all bearers in one direction is 100%. (R, W, set-by-create) (optional) (1 byte)

Maximum interleaving delay: This attribute is the maximum one-way interleaving delay introduced by the PMS-TC between the alpha and the beta reference points, in the direction of the bearer channel. The one-way interleaving delay is defined

in individual xDSL Recommendations as $\text{cap}(S \cdot D) / 4$ ms, where S is the S factor, D is the interleaving depth, and $\text{cap}()$ denotes rounding to the next higher integer. xTUs choose S and D values such that the actual one-way interleaving delay does not exceed the configured maximum interleaving delay.

The delay is coded in milliseconds, varying from 2 to 63, with special meaning assigned to values 0, 1 and 255. The value 0 indicates that no delay bound is imposed. The value 1 indicates the fast latency path is to be used in the ITU-T G.992.1 operating mode and S and D are to be selected such that $S \leq 1$ and $D = 1$ in ITU-T G.992.2, ITU-T G.992.3, ITU-T G.992.4, ITU-T G.992.5 and ITU-T G.993.2 operating modes. The value 255 indicates a delay bound of 1 ms in ITU-T G.993.2 operation. (R, W, set-by-create) (mandatory) (1 byte)

Data rate threshold upshift: This attribute is a threshold on the cumulative data rate upshift achieved over one or more bearer channel data rate adaptations. An upshift rate change (DRT up) notification is issued by the PPTP xDSL UNI part 1 when the actual data rate exceeds the data rate at the last entry into showtime by more than the threshold. The data rate threshold is coded in bits per second. (R, W, set-by-create) (mandatory for xDSL standards that use this attribute) (4 bytes)

Data rate threshold downshift: This attribute is a threshold on the cumulative data rate downshift achieved over one or more bearer channel data rate adaptations. A downshift rate change (DRT down) notification is issued by the PPTP xDSL UNI part 1 when the actual data rate is below the data rate at the last entry into showtime by more than the threshold. The data rate threshold is coded in bits per second. (R, W, set-by-create) (mandatory for xDSL standards that use this attribute) (4 bytes)

Minimum reserved data rate: This attribute specifies the desired minimum reserved net data rate for the bearer channel. The rate is coded in bits per second. This attribute is needed only if the rate adaptation mode is set to dynamic in the xDSL line configuration profile part 1. (R, W, set-by-create) (optional) (4 bytes)

Minimum data rate in low-power state: This parameter specifies the minimum desired net data rate for the bearer channel during the low-power state (L1/L2). The power management low-power states L1 and L2 are defined in [ITU-T G.992.2] and [ITU-T G.992.3], respectively. The data rate is coded in bits per second. (R, W, set-by-create) (mandatory) (4 bytes)

Minimum impulse noise protection: The INP_{\min} attribute specifies the minimum INP for the bearer channel if it is transported over DMT symbols with a subcarrier spacing of 4.3125 kHz. INP is expressed in DMT symbols with a subcarrier spacing of 4.3125 kHz. It can be $\frac{1}{2}$ symbol or any integer number of symbols from 0 to 16, inclusive.

If the xTU does not support the configured INP_{\min} value, it uses the nearest supported INP value greater than INP_{\min} .

Value INP_{\min}

1 0 symbols

2 $\frac{1}{2}$ symbol

N $(N - 2)$ symbols, $3 \leq N \leq 18$

(R, W, set-by-create) (optional for [ITU-T G.992.1], mandatory for other xDSL standards that use this attribute) (1 byte)

Maximum bit error ratio: This attribute specifies the desired maximum bit error ratio for the bearer channel. It is only valid for [ITU-T G.992.3], [ITU-T G.992.4] and [ITU-T G.992.5]. The bit error ratio is specified via the following values:

- 1 10^{-3}
- 2 10^{-5}
- 3 10^{-7}

(R, W, set-by-create) (mandatory for standards that use this attribute) (1 byte)

Minimum impulse noise protection 8 kHz: The INP_{min8} attribute specifies the minimum INP for the bearer channel if it is transported over DMT symbols with a subcarrier spacing of 8.625 kHz. It is only valid for [ITU-T G.993.2]. INP is expressed in DMT symbols with a subcarrier spacing of 8.625 kHz. It can take any integer value from 0 (default) to 16, inclusive. (R, W) (mandatory for [ITU-T G.993.2]) (1 byte)

Maximum delay variation: The DVMAX attribute specifies the maximum value for delay variation allowed in an OLR procedure. Its value ranges from 1 (0.1 ms) to 254 (25.4 ms). The special value 255 specifies that no delay variation bound is imposed. (R, W) (optional: used by [ITU-T G.993.2]) (1 byte)

Channel initialization policy selection: The CIPOLICY attribute specifies the policy to determine transceiver configuration at initialization. Valid values are 0..1, as defined in the Recommendations that use this attribute. (R, W) (optional) (1 byte)

Minimum SOS bit rate downstream: The MIN-SOS-BR-ds attribute specifies the minimum net data rate required for a valid SOS request in the downstream direction. The value is coded as an unsigned integer representing the data rate as a multiple of 8 kbit/s. (R, W) (optional) (4 bytes)

Minimum SOS bit rate upstream: The MIN-SOS-BR-us attribute specifies the minimum net data rate required for a valid SOS request in the upstream direction. The value is coded as an unsigned integer representing the data rate as a multiple of 8 kbit/s. (R, W) (optional) (4 bytes)

Actions

Create, delete, get, set

Notifications

None.

9.7.8 xDSL subcarrier masking downstream profile

This ME contains the subcarrier masking downstream profile for an xDSL UNI. Instances of this ME are created and deleted by the OLT.

Relationships

An instance of this ME may be associated with zero or more instances of the PPTP xDSL UNI part 1.

Attributes

Managed entity ID: This attribute uniquely identifies each instance of this ME. The value 0 is reserved. (R, set-by-create) (mandatory) (2 bytes)

The four following attributes are bit maps that represent downstream mask values for subcarriers 1..128 (mask 1) through 385..512 (mask 4). The MSB of the first byte corresponds to the lowest

numbered subcarrier, and the LSB of the last byte corresponds to the highest. Each bit position defines whether the corresponding downstream subcarrier is masked (1) or not masked (0).

The number of xDSL subcarriers, downstream (NSCds) is the highest numbered subcarrier that can be transmitted in the downstream direction. For [ITU-T G.992.3], [ITU-T G.992.4] and [ITU-T G.992.5], it is defined in the corresponding Recommendation. For [ITU-T G.992.1], NSCds = 256 and for [ITU-T G.992.2], NSCds = 128.

Downstream subcarrier mask 1: Subcarriers 1 to 128. (R, W, set-by-create) (mandatory) (16 bytes)

Downstream subcarrier mask 2: Subcarriers 129 to 256. (R, W) (mandatory for modems that support NSCds > 128) (16 bytes)

Downstream subcarrier mask 3: Subcarriers 257 to 384. (R, W) (mandatory for modems that support NSCds > 256) (16 bytes)

Downstream subcarrier mask 4: Subcarriers 385 to 512. (R, W) (mandatory for modems that support NSCds > 384) (16 bytes)

Mask valid: This Boolean attribute controls and reports the operational status of the downstream subcarrier mask attributes.

If this attribute is true (1), the downstream subcarrier mask represented in this ME has been impressed on the DSL equipment.

If this attribute is false (0), the downstream subcarrier mask represented in this ME has not been impressed on the DSL equipment. The default value is false.

The value of this attribute can be modified by the ONU and OLT, as follows.

- If the OLT changes any of the four mask attributes or sets mask valid false, then mask valid is false.
- If mask valid is false and the OLT sets mask valid true, the ONU impresses the downstream subcarrier mask data on to the DSL equipment.

(R, W) (mandatory) (1 byte)

Actions

Create, delete, get, set

Notifications

None.

9.7.9 xDSL subcarrier masking upstream profile

This ME contains the subcarrier masking upstream profile for an xDSL UNI. An instance of this ME is created and deleted by the OLT.

Relationships

An instance of this ME may be associated with zero or more instances of the PPTP xDSL UNI part 1.

Attributes

Managed entity ID: This attribute uniquely identifies each instance of this ME. The value 0 is reserved. (R, set-by-create) (mandatory) (2 bytes)

Upstream subcarrier mask: This attribute is a bit map representing upstream mask values for subcarriers 1 to 64. The MSB of byte 1 corresponds to subcarrier 1, and the

LSB of byte 8 corresponds to subcarrier 64. Each bit position defines whether the corresponding downstream subcarrier is masked (1) or not masked (0).

Subcarrier number 1 is the lowest, and the number of xDSL subcarriers, upstream (NSC_{us}) is the highest subcarrier that can be transmitted in the upstream direction. For [ITU-T G.992.3], [ITU-T G.992.4] and [ITU-T G.992.5], it is defined in the corresponding Recommendation. For Annex A of [ITU-T G.992.1] and [ITU-T G.992.2], NSC_{us} = 32 and for Annex B of [ITU-T G.992.1], NSC_{us} = 64. (R, W, set-by-create) (mandatory) (8 bytes)

Actions

Create, delete, get, set

Notifications

None.

9.7.10 xDSL PSD mask profile

This ME contains a PSD mask profile for an xDSL UNI. An instance of this ME is created and deleted by the OLT.

Relationships

An instance of this ME may be associated with zero or more instances of the PPTP xDSL UNI part 1.

Attributes

Managed entity ID: This attribute uniquely identifies each instance of this ME. The value 0 is reserved. (R, set-by-create) (mandatory) (2 bytes)

PSD mask table: This attribute is a table that defines the PSD mask applicable at the U-C2 reference point (downstream) or the U-R2 reference point (upstream). This mask may impose PSD restrictions in addition to the limit PSD mask defined in the relevant Recommendations ([ITU-T G.992.3], [ITU-T G.992.5], [ITU-T G.993.2]).

NOTE – In [ITU-T G.997.1], this attribute is called PSDMASK_ds (downstream) and PSDMASK_us (upstream). In [ITU-T G.993.2], this attribute is called MIBMASK_ds (downstream) and MIBMASK_us (upstream). The ITU-T G.993.2 MIBMASK_us does not include breakpoints to shape US₀.

The PSD mask is specified through a set of breakpoints. Each breakpoint comprises a 2 byte subcarrier index t , with a subcarrier spacing of 4.3125 kHz, and a 1 byte PSD mask level at that subcarrier. The set of breakpoints can then be represented as $[(t_1, PSD_1), (t_2, PSD_2), \dots, (t_N, PSD_N)]$. The PSD mask level is coded as 0 (0.0 dBm/Hz) to 190 (–95.0 dBm/Hz), in steps of 0.5 dB.

The maximum number of downstream breakpoints is 32. In the upstream direction, the maximum number of breakpoints is 4 for [ITU-T G.992.3] and 16 for [ITU-T G.993.2]. The requirements for a valid set of breakpoints are defined in the relevant Recommendations ([ITU-T G.992.3], [ITU-T G.992.5], [ITU-T G.993.2]).

Each table entry in this attribute comprises:

- an entry number field (1 byte, first entry numbered 1);
- a subcarrier index field, denoted t (2 bytes);
- a PSD mask level field (1 byte).

By default, the PSD mask table is empty. Setting a subcarrier entry with a valid PSD mask level implies insertion into the table or replacement of an existing entry. Setting an entry's PSD mask level to 0xFF implies deletion from the table.

(R, W) (mandatory) (4 * N bytes where N is the number of breakpoints)

Mask valid: This Boolean attribute controls and reports the status of the PSD mask attribute.

As a status report, the value false indicates that the PSD mask represented in this ME has not been impressed on the DSL equipment. The value true indicates that the PSD mask represented in this ME has been impressed on the DSL equipment.

This attribute behaves as follows.

- If the OLT changes any of the PSD mask table entries or sets mask valid false, then mask valid is false.
- If mask valid is false and the OLT sets mask valid true, the ONU impresses the PSD mask data on the DSL equipment.

(R, W) (mandatory) (1 byte)

Actions

Create, delete, get, get next, set

Set table (optional)

Notifications

None.

9.7.11 xDSL downstream RFI bands profile

This ME contains the downstream RFI bands profile for an xDSL UNI. Instances of this ME are created and deleted by the OLT.

Relationships

An instance of this ME may be associated with zero or more instances of the PPTP xDSL UNI part 1.

Attributes

Managed entity ID: This attribute uniquely identifies each instance of this ME. The value 0 is reserved. (R, set-by-create) (mandatory) (2 bytes)

Downstream RFI bands table: The RFIBANDS attribute is a table where each entry comprises:

- an entry number field (1 byte, first entry numbered 1);
- subcarrier index 1 field (2 bytes);
- subcarrier index 2 field (2 bytes).

For [ITU-T G.992.5], this configuration attribute defines the subset of downstream PSD mask breakpoints, as specified in the downstream PSD mask, to be used to notch an RFI band. This subset consists of couples of consecutive subcarrier indices belonging to breakpoints: $[t_i; t_{i+1}]$, corresponding to the low level of the notch. Interpolation around these points is defined in [ITU-T G.992.5].

For [ITU-T G.993.2], this attribute defines the bands where the PSD is to be reduced as specified in clause 7.2.1.2 of [ITU-T G.993.2]. Each band is represented by start and stop subcarrier indices with a subcarrier spacing of 4.3125 kHz. Up to 16 bands may be specified. This attribute defines the RFI bands for both upstream and downstream directions.

Entries have the default value 0 for both subcarrier index 1 and subcarrier index 2. Setting an entry with a non-zero subcarrier index 1 and subcarrier index 2 implies insertion into the table or replacement of an existing entry. Setting an entry's subcarrier index 1 and subcarrier index 2 to 0 implies deletion from the table, if present.

(R, W) (mandatory for [ITU-T G.992.5], [ITU-T G.993.2]) (5 * *N* bytes where *N* is the number of RFI bands)

Bands valid: This Boolean attribute controls and reports the operational status of the downstream RFI bands table.

If this attribute is true, the downstream RFI bands table has been impressed on the DSL equipment.

If this attribute is false, the downstream RFI bands table has not been impressed on the DSL equipment. The default value is false.

This attribute can be modified by the ONU and OLT, as follows.

- If the OLT changes any of the RFI bands table entries or sets bands valid false, then bands valid is false.
- If bands valid is false and OLT sets bands valid true, the ONU impresses the downstream RFI bands data on to the DSL equipment.

(R, W) (mandatory) (1 byte)

Actions

Create, delete, get, get next, set

Set table (optional)

Notifications

None.

9.7.12 xDSL line inventory and status data part 1

This ME contains part 1 of the line inventory and status data for an xDSL UNI. The ONU automatically creates or deletes an instance of this ME upon the creation or deletion of a PPTP xDSL UNI part 1.

Relationships

An instance of this ME is associated with an xDSL UNI.

Attributes

Managed entity ID: This attribute uniquely identifies each instance of this ME. Through an identical ID, this ME is implicitly linked to an instance of the PPTP xDSL UNI part 1. (R) (mandatory) (2 bytes)

xTU-C G.994.1 vendor ID: This is the vendor ID as inserted by the xTU-C in the ITU-T G.994.1 CL message. It comprises 8 octets, including a country code followed by a (regionally allocated) provider code, as defined in [ITU-T T.35]. (R) (mandatory) (8 bytes)

- xTU-R G.994.1 vendor ID:** This is the vendor ID as inserted by the xTU-R in the ITU-T G.994.1 CLR message. It comprises 8 binary octets, with the same format as the xTU-C ITU-T G.994.1 vendor ID. (R) (mandatory) (8 bytes)
- xTU-C system vendor ID:** This is the vendor ID as inserted by the xTU-C in the overhead messages of [ITU-T G.992.3] and [ITU-T G.992.4]. It comprises 8 binary octets, with the same format as the xTU-C ITU-T G.994.1 vendor ID. (R) (mandatory) (8 bytes)
- xTU-R system vendor ID:** This is the vendor ID as inserted by the xTU-R in the embedded operations channel and overhead messages of [ITU-T G.992.3] and [ITU-T G.992.4]. It comprises 8 binary octets, with the same format as the xTU-C ITU-T G.994.1 vendor ID. (R) (mandatory) (8 bytes)
- xTU-C version number:** This is the vendor-specific version number as inserted by the xTU-C in the overhead messages of [ITU-T G.992.3] and [ITU-T G.992.4]. It comprises up to 16 binary octets. (R) (mandatory) (16 bytes)
- xTU-R version number:** This is the version number as inserted by the xTU-R in the embedded operations channel of [ITU-T G.992.1] or [ITU-T G.992.2], or the overhead messages of [ITU-T G.992.3], [ITU-T G.992.4], [ITU-T G.992.5] and [ITU-T G.993.2]. The attribute value may be vendor-specific, but is recommended to comprise up to 16 ASCII characters, null-terminated if it is shorter than 16. The string should contain the xTU-R firmware version and the xTU-R model, encoded in that order and separated by a space character: "<xTU-R firmware version><xTU-R model>". It is recognized that legacy xTU-Rs may not support this format. (R) (mandatory) (16 bytes)
- xTU-C serial number part 1:** The vendor-specific serial number inserted by the xTU-C in the overhead messages of [ITU-T G.992.3] and [ITU-T G.992.4] comprises up to 32 ASCII characters, null terminated if it is shorter than 32 characters. This attribute contains the first 16 characters. (R) (mandatory) (16 bytes)
- xTU-C serial number part 2:** This attribute contains the second 16 characters of the xTU-C serial number. (R) (mandatory) (16 bytes)
- xTU-R serial number part 1:** The serial number inserted by the xTU-R in the embedded operations channel of [ITU-T G.992.1] or [ITU-T G.992.2], or the overhead messages of [ITU-T G.992.3], [ITU-T G.992.4], [ITU-T G.992.5] and [ITU-T G.993.2], comprises up to 32 ASCII characters, null-terminated if it is shorter than 32. It is recommended that the equipment serial number, the equipment model and the equipment firmware version, encoded in that order and separated by space characters, be contained: "<equipment serial number><equipment model><equipment firmware version>". It is recognized that legacy xTU-Rs may not support this format. This attribute contains the first 16 characters. (R) (mandatory) (16 bytes)
- xTU-R serial number part 2:** This attribute contains the second 16 characters of the xTU-R serial number. (R) (mandatory) (16 bytes)
- xTU-C self-test results:** This parameter reports the xTU-C self-test result. It is coded in two fields. The most significant octet is 0 if the self-test passed and 1 if it failed. The three least significant octets are a vendor-discretionary integer that can be interpreted in combination with [ITU-T G.994.1] and the system vendor ID. (R) (mandatory) (4 bytes)
- xTU-R self-test results:** This parameter defines the xTU-R self-test result. It is coded in two fields. The most significant octet is 0 if the self-test passed and 1 if it failed.

The three least significant octets are a vendor-discretionary integer that can be interpreted in combination with [ITU-T G.994.1] and the system vendor ID. (R) (mandatory) (4 bytes)

xTU-C transmission system capability: This attribute lists xTU-C transmission system capabilities. It is a bit map, defined in Table 9.7.12-1. (R) (mandatory) (7 bytes)

NOTE 1 – This attribute is only 7 bytes long. An eighth byte identifying VDSL2 capabilities is defined in the VDSL2 line inventory and status data part 1 ME.

xTU-R transmission system capability: This attribute lists xTU-R transmission system capabilities. It is a bit map, defined in Table 9.7.12-1. (R) (mandatory) (7 bytes)

NOTE 2 – This attribute is only 7 bytes long. An eighth byte identifying VDSL2 capabilities is defined in the VDSL2 line inventory and status data part 2 ME.

Initialization success/failure cause: This parameter represents the success or failure cause of the last full initialization performed on the line. It is coded as follows.

0 Successful

1 Configuration error

This error occurs with inconsistencies in configuration parameters, e.g., when the line is initialized in an xDSL transmission system whose xTU does not support the configured maximum delay or the configured minimum or maximum data rate for one or more bearer channels.

2 Configuration not feasible on the line

This error occurs if the minimum data rate cannot be achieved on the line with the minimum noise margin, maximum PSD level, maximum delay and maximum bit error ratio for one or more bearer channels.

3 Communication problem

This error occurs, for example, due to corrupted messages, bad syntax messages, if no common mode can be selected in the ITU-T G.994.1 handshake procedure or due to a timeout.

4 No peer xTU detected

This error occurs if the peer xTU is not powered or not connected or if the line is too long to allow detection of a peer xTU.

5 Any other or unknown initialization failure cause.

(R) (mandatory) (1 byte)

Actions

Get

Notifications

None.

Table 9.7.12-1 describes the xTU transmission system capability attributes in xDSL status MEs. It is a bit map (0 if not allowed, 1 if allowed) with the definition listed in Table 9.7.12-1.

Table 9.7.12-1– xTU transmission system table

Bit	Representation
<i>Octet 1</i>	
1 (LSB)	[b-ATIS-0600413]
2	Annex C of [ETSI TS 101 388]
3	ITU-T G.992.1 operation over POTS non-overlapped spectrum (Annex A of [ITU-T G.992.1])
4	ITU-T G.992.1 operation over POTS overlapped spectrum (Annex A of [ITU-T G.992.1])
5	ITU-T G.992.1 operation over ISDN non-overlapped spectrum (Annex B of [ITU-T G.992.1])
6	ITU-T G.992.1 operation over ISDN overlapped spectrum (Annex B of [ITU-T G.992.1])
7	ITU-T G.992.1 operation in conjunction with TCM-ISDN non-overlapped spectrum (Annex C of [ITU-T G.992.1])
8	ITU-T G.992.1 operation in conjunction with TCM-ISDN overlapped spectrum (Annex C of [ITU-T G.992.1])
<i>Octet 2</i>	
9	ITU-T G.992.2 operation over POTS non-overlapped spectrum (Annex A of [ITU-T G.992.2])
10	ITU-T G.992.2 operation over POTS overlapped spectrum (Annex B of [ITU-T G.992.2])
11	ITU-T G.992.2 operation in conjunction with TCM-ISDN non-overlapped spectrum (Annex C of [ITU-T G.992.2])
12	ITU-T G.992.2 operation in conjunction with TCM-ISDN overlapped spectrum (Annex C of [ITU-T G.992.2])
13	Reserved
14	Reserved
15	Reserved
16	Reserved
<i>Octet 3</i>	
17	Reserved
18	Reserved
19	ITU-T G.992.3 operation over POTS non-overlapped spectrum (Annex A of [ITU-T G.992.3])
20	ITU-T G.992.3 operation over POTS overlapped spectrum (Annex A of [ITU-T G.992.3])
21	ITU-T G.992.3 operation over ISDN non-overlapped spectrum (Annex B of [ITU-T G.992.3])
22	ITU-T G.992.3 operation over ISDN overlapped spectrum (Annex B of [ITU-T G.992.3])
23	ITU-T G.992.3 operation in conjunction with TCM-ISDN non-overlapped spectrum (Annex C of [ITU-T G.992.3])
24	ITU-T G.992.3 operation in conjunction with TCM-ISDN overlapped spectrum (Annex C of [ITU-T G.992.3]).
<i>Octet 4</i>	
25	ITU-T G.992.4 operation over POTS non-overlapped spectrum (Annex A of [ITU-T G.992.4])
26	ITU-T G.992.4 operation over POTS overlapped spectrum (Annex A of [ITU-T G.992.4])
27	Reserved
28	Reserved
29	ITU-T G.992.3 All digital mode operation with non-overlapped spectrum (Annex I of [ITU-T G.992.3])

Table 9.7.12-1– xTU transmission system table

Bit	Representation
30	ITU-T G.992.3 All digital mode operation with overlapped spectrum (Annex I of [ITU-T G.992.3])
31	ITU-T G.992.3 All digital mode operation with non-overlapped spectrum (Annex J of [ITU-T G.992.3])
32	ITU-T G.992.3 All digital mode operation with overlapped spectrum (Annex J of [ITU-T G.992.3])
<i>Octet 5</i>	
33	ITU-T G.992.4 All digital mode operation with non-overlapped spectrum (Annex I of [ITU-T G.992.4])
34	ITU-T G.992.4 All digital mode operation with overlapped spectrum (Annex I of [ITU-T G.992.4])
35	ITU-T G.992.3 Reach extended operation over POTS, Mode 1 (non-overlapped, wide upstream) (Annex L of [ITU-T G.992.3])
36	ITU-T G.992.3 Reach extended operation over POTS, Mode 2 (non-overlapped, narrow upstream) (Annex L of [ITU-T G.992.3])
37	ITU-T G.992.3 Reach extended operation over POTS, Mode 3 (overlapped, wide upstream) (Annex L of [ITU-T G.992.3])
38	ITU-T G.992.3 Reach extended operation over POTS, Mode 4 (overlapped, narrow upstream) (Annex L of [ITU-T G.992.3])
39	ITU-T G.992.3 Extended upstream operation over POTS non-overlapped spectrum (Annex M of [ITU-T G.992.3])
40	ITU-T G.992.3 Extended upstream operation over POTS overlapped spectrum (Annex M of [ITU-T G.992.3])
<i>Octet 6</i>	
41	ITU-T G.992.5 operation over POTS non-overlapped spectrum (Annex A of [ITU-T G.992.5])
42	ITU-T G.992.5 operation over POTS overlapped spectrum (Annex A of [ITU-T G.992.5])
43	ITU-T G.992.5 operation over ISDN non-overlapped spectrum (Annex B of [ITU-T G.992.5])
44	ITU-T G.992.5 operation over ISDN overlapped spectrum (Annex B of [ITU-T G.992.5])
45	ITU-T G.992.5 operation in conjunction with TCM-ISDN non-overlapped spectrum (Annex C of [ITU-T G.992.5])
46	ITU-T G.992.5 operation in conjunction with TCM-ISDN overlapped spectrum (Annex C of [ITU-T G.992.5])
47	ITU-T G.992.5 All digital mode operation with non-overlapped spectrum (Annex I of [ITU-T G.992.5])
48	ITU-T G.992.5 All digital mode operation with overlapped spectrum (Annex I of [ITU-T G.992.5])
<i>Octet 7</i>	
49	ITU-T G.992.5 All digital mode operation with non-overlapped spectrum (Annex J of [ITU-T G.992.5])
50	ITU-T G.992.5 All digital mode operation with overlapped spectrum (Annex J of [ITU-T G.992.5])
51	ITU-T G.992.5 Extended upstream operation over POTS non-overlapped spectrum (Annex M of [ITU-T G.992.5])

Table 9.7.12-1– xTU transmission system table

Bit	Representation
52	ITU-T G.992.5 Extended upstream operation over POTS overlapped spectrum (Annex M of [ITU-T G.992.5])
53	Reserved
54	Reserved
55	Reserved
56	Reserved
<i>Octet 8 (Note)</i>	
57	ITU-T G.993.2 region A (North America) (Annex A of [ITU-T G.993.2])
58	ITU-T G.993.2 region B (Europe) (Annex B of [ITU-T G.993.2])
59	ITU-T G.993.2 region C (Japan) (Annex C of [ITU-T G.993.2])
60	Reserved
61	Reserved
62	Reserved
63	Reserved
64	Reserved
NOTE – For backward compatibility reasons, the eighth octet of this table is represented as a separate attribute in separate managed entities.	

9.7.13 xDSL line inventory and status data part 2

This ME contains part 2 of the line inventory and status data for an xDSL UNI. The ONU automatically creates or deletes an instance of this ME upon the creation or deletion of a PPTP xDSL UNI part 1.

NOTE 1 – [ITU-T G.997.1] specifies that bit rate attributes have granularity of 1000 bit/s. If ITU-T G.997.1 compliance is required, the ONU should only report values with this granularity.

Relationships

An instance of this ME is associated with an xDSL UNI.

Attributes

Managed entity ID: This attribute uniquely identifies each instance of this ME. Through an identical ID, this ME is implicitly linked to an instance of the PPTP xDSL UNI part 1. (R) (mandatory) (2 bytes)

xDSL transmission system: This parameter defines the transmission system in use. It is a bit map, defined in Table 9.7.12-1. (R) (mandatory) (7 bytes)

NOTE 2 – This attribute is only 7 bytes long. An eighth byte identifying VDSL2 capabilities in use is defined in the VDSL2 line inventory and status data part 1 ME.

Line power management state: The line has four possible power management states.

- 0 L0: Synchronized – This line state occurs when the line has full transmission (i.e., showtime).
- 1 L1: Power down data transmission – This line state occurs when there is transmission on the line, but the net data rate is reduced (e.g., only for OAM and higher layer connection and session control). This state applies to [ITU-T G.992.2] only.

- 2 L2: Power down data transmission – This line state occurs when there is transmission on the line, but the net data rate is reduced (e.g., only for OAM and higher layer connection and session control). This state applies to [ITU-T G.992.3] and [ITU-T G.992.4] only.
- 3 L3: No power – This line state occurs when no power is transmitted on the line at all.

(R) (mandatory) (1 byte)

Downstream line attenuation: The LATNds attribute is the squared magnitude of the channel characteristics function $H(f)$ averaged over this band, and measured during loop diagnostic mode and initialization. The exact definition is included in the relevant xDSL Recommendation. The attribute value ranges from 0 (0.0 dB) to 1270 (127.0 dB) dB. The special value 0xFFFF indicates that line attenuation is out of range. (R) (mandatory) (2 bytes)

NOTE 3 – [ITU-T G.993.2] specifies a per-band array to represent this attribute. The array is defined in the VDSL2 line inventory and status data part 3 ME. In an ITU-T G.993.2 context, the downstream line attenuation attribute should be set to 0 here, and populated in the VDSL2 line inventory and status data part 3 ME instead.

Upstream line attenuation: The LATNus attribute is the squared magnitude of the channel characteristics function $H(f)$ averaged over this band, and measured during loop diagnostic mode and initialization. The exact definition is included in the relevant xDSL Recommendation. The attribute value ranges from 0 (0.0 dB) to 1270 (127.0 dB). The special value 0xFFFF indicates that line attenuation is out of range. (R) (mandatory) (2 bytes)

NOTE 4 – [ITU-T G.993.2] specifies a per-band array to represent this attribute. The array is defined in the VDSL2 line inventory and status data part 3 ME. In an ITU-T G.993.2 context, the upstream line attenuation attribute should be set to 0 here, and populated in the VDSL2 line inventory and status data part 3 ME instead.

Downstream signal attenuation: The SATNds attribute is the measured difference in the total power transmitted in this band by the xTU-C and the total power received in this band by the xTU-R during loop diagnostic mode, initialization and showtime. The exact definition is included in the relevant xDSL Recommendation. The attribute value ranges from 0 (0.0 dB) to 1270 (127.0 dB). The special value 0xFFFF indicates that signal attenuation is out of range. (R) (mandatory) (2 bytes)

NOTE 5 – During showtime, only a subset of the subcarriers may be transmitted by the xTU-C, as compared to loop diagnostic mode and initialization. Therefore, the downstream signal attenuation value during showtime may be significantly lower than the downstream signal attenuation value during loop diagnostic mode and initialization.

NOTE 6 – [ITU-T G.993.2] specifies a per-band array to represent this attribute. The array is defined in the VDSL2 line inventory and status data part 3 ME. In an ITU-T G.993.2 context, the downstream signal attenuation attribute should be set to 0 here, and populated in the VDSL2 line inventory and status data part 3 ME instead.

Upstream signal attenuation: The SATNus attribute is the measured difference in decibels in the total power transmitted in this band by the xTU-R and the total power received in this band by the xTU-C during loop diagnostic mode, initialization and showtime. The exact definition is included in the relevant xDSL Recommendation. The attribute value ranges from 0 (0.0 dB) to 1270 (127.0 dB). The special value 0xFFFF indicates that signal attenuation is out of range. (R) (mandatory) (2 bytes)

NOTE 7 – During showtime, only a subset of the subcarriers may be transmitted by the xTU-R, as compared to loop diagnostic mode and initialization. Therefore, the upstream signal attenuation value during showtime may be significantly lower than the upstream signal attenuation value during loop diagnostic mode and initialization.

NOTE 8 – [ITU-T G.993.2] specifies a per-band array to represent this attribute. The array is defined in the VDSL2 line inventory and status data part 3 ME. In an ITU-T G.993.2 context, the upstream signal attenuation attribute should be set to 0 here, and populated in the VDSL2 line inventory and status data part 3 ME instead.

Downstream SNR ratio margin: The downstream SNR margin SNRMds is the maximum increase of noise power received at the xTU-R, such that the BER requirements can still be met for all downstream bearer channels. The attribute value ranges from 0 (–64.0 dB) to 1270 (+63.0 dB). The special value 0xFFFF indicates that the attribute is out of range (R) (mandatory) (2 bytes)

Upstream SNR margin: The upstream SNR margin SNRMus is the maximum increase of noise power received at the xTU-C, such that the BER requirements can still be met for all upstream bearer channels. The attribute value ranges from 0 (–64.0 dB) to 1270 (+63.0 dB). The special value 0xFFFF indicates that the attribute is out of range. (R) (mandatory) (2 bytes)

Downstream maximum attainable data rate: The ATTNDRds attribute indicates the maximum downstream net data rate currently attainable. The rate is coded in bits per second. (R) (mandatory) (4 bytes)

Upstream maximum attainable data rate: The ATTNDRus attribute indicates the maximum upstream net data rate currently attainable. The rate is coded in bits per second. (R) (mandatory) (4 bytes)

Downstream actual power spectrum density: The ACTPSDds attribute is the average downstream transmit power spectrum density over the subcarriers in use (subcarriers to which downstream user data are allocated) delivered by the xTU-C at the U-C reference point, at the instant of measurement. The attribute value ranges from 0 (–90.0 dBm/Hz) to 900 (0.0 dBm/Hz). The special value (0xFFFF) indicates that the parameter is out of range. (R) (mandatory) (2 bytes)

Upstream actual power spectrum density: The ACTPSDus attribute is the average upstream transmit power spectrum density over the subcarriers in use (subcarriers to which upstream user data are allocated) delivered by the xTU-R at the U-R reference point, at the instant of measurement. The attribute value ranges from 0 (–90.0 dBm/Hz) to 900 (0.0 dBm/Hz). The special value 0xFFFF indicates that the attribute is out of range. (R) (mandatory) (2 bytes)

Downstream actual aggregate transmit power: The ACTATPds attribute is the total amount of transmit power delivered by the xTU-C at the U-C reference point, at the instant of measurement. The attribute value ranges from 0 (–31.0 dBm) to 620 (+31.0 dBm). The special value (0xFFFF) indicates that the parameter is out of range. (R) (mandatory) (2 bytes)

NOTE 9 – The downstream nominal aggregate transmit power may be taken as a best estimate of the parameter.

Upstream actual aggregate transmit power: The ACTATPus attribute is the total amount of transmit power delivered by the xTU-R at the U-R reference point, at the instant of measurement. The attribute value ranges from 0 (–31.0 dBm) to 620 (+31.0 dBm). The special value (0xFFFF) indicates that the parameter is out of range. (R) (mandatory) (2 bytes)

NOTE 10 – The upstream nominal aggregate transmit power may be taken as a best estimate of the parameter.

Initialization – last state transmitted downstream: This attribute represents the last successful transmitted initialization state in the downstream direction in the last full initialization performed on the line. Initialization states are defined in the individual xDSL Recommendations and are counted from 0 (if [ITU-T G.994.1] is used) or 1 (if [ITU-T G.994.1] is not used) up to showtime. This parameter must be interpreted along with the xDSL transmission system capabilities.

This parameter is available only when, after a failed full initialization, line diagnostic procedures are activated on the line. Line diagnostic procedures can be activated by the operator of the system (through the loop diagnostics mode forced attribute of the xDSL line configuration profile part 3) or autonomously by the xTU-C or xTU-R.

(R) (mandatory) (1 byte)

Initialization – last state transmitted upstream: This attribute represents the last successful transmitted initialization state in the upstream direction in the last full initialization performed on the line. Initialization states are defined in the individual xDSL Recommendations and are counted from 0 (if [ITU-T G.994.1] is used) or 1 (if [ITU-T G.994.1] is not used) up to showtime. This parameter must be interpreted along with the xDSL transmission system capabilities.

This parameter is available only when, after a failed full initialization, line diagnostic procedures are activated on the line. Line diagnostic procedures can be activated by the operator of the system (through the loop diagnostics mode forced attribute of the xDSL line configuration profile part 3) or autonomously by the xTU-C or xTU-R.

(R) (mandatory) (1 byte)

Actions

Get

Notifications

None.

9.7.14 xDSL line inventory and status data part 3

This ME extends the attributes defined in the xDSL line inventory and status data parts 1 and 2. This ME reports downstream attributes.

Relationships

This is one of the status MEs associated with an xDSL UNI. The ONU automatically creates or deletes an instance of this ME upon creation or deletion of a PPTP xDSL UNI part 1 that supports these attributes.

Attributes

Managed entity ID: This attribute uniquely identifies each instance of this ME. Through an identical ID, this ME is implicitly linked to an instance of the PPTP xDSL UNI part 1 ME. (R) (mandatory) (2 bytes)

- TSSpsds table:** This table contains downstream transmit spectrum shaping attributes expressed as the set of breakpoints exchanged during [ITU-T G.994.1]. Each breakpoint consists of a 2 byte subcarrier index and the associated shaping attribute. The shaping attribute is 1 byte, an integer value in the 0 to 126 range, represented as a multiple of -0.5 dB. The special value 127 indicates that the subcarrier is not transmitted. (R) (mandatory) ($3 * N$ bytes, where N is the number of breakpoints)
- HLINSCds:** This attribute is the scale factor to be applied to the downstream $H_{lin}(f)$ values. It is coded as a 16 bit unsigned integer. This attribute is only available after a loop diagnostic procedure. (R) (mandatory) (2 bytes)
- HLINpsds table:** This attribute is an array of complex coefficients $\{a, b\}$ that represent the downstream transfer function $H_{lin}(f)$ in linear form. Each array entry represents $H_{lin}(f) = i * H_{LINGds} * \Delta f$ for a particular subcarrier group index i , ranging from 0 to $\min(NSds, 511)$. $H_{lin}(f)$ may be reconstructed from the array as $((HLINSCds/2^{15}) * ((a(i) + j * b(i))/2^{15}))$, where $a(i)$ and $b(i)$ are 2s complement integers in the range $(-2^{15} + 1)$ to $(+2^{15} - 1)$. The granularity of a and b depends on the scale factor.
- The special value $a(i) = b(i) = -2^{15}$ indicates that no measurement could be done for this subcarrier group because it is out of the passband or that the attenuation is out of the range to be represented.
- This attribute is only available after a loop diagnostic procedure. (R) (mandatory) ($4 * N$ bytes, where N is the number of subcarrier groups)
- HLOGMTds:** After a loop diagnostic procedure, this attribute contains the number of symbols used to measure the downstream $H_{log}(f)$ values. It is a 16 bit unsigned value that corresponds to the value specified in the corresponding Recommendation (e.g., the number of symbols in a 1 s interval for [ITU-T G.992.3]). (R) (mandatory) (2 bytes)
- HLOGpsds table:** The HLOGpsds attribute contains an array of numbers $m(i)$, where i is a particular subcarrier group index, ranging from 0 to $\min(NSds, 511)$, and m lies in the range 0..1022, with a granularity of 0.1 dB. The downstream transfer function $H_{log}(f)$ can be reconstructed by the OLT management client as $(6 - m(i)/10)$ dBm/Hz, with a range from +6 to approximately -96 dBm/Hz.
- The special value $m = 1023$ indicates that no measurement could be done for this subcarrier group because it is out of the passband or that the attenuation is out of range to be represented.
- (R) (mandatory) ($2 * N$ bytes, where N is the number of subcarrier groups)
- QLNMTds:** After a loop diagnostic procedure, the quiet line noise (QLN) PSD measurement time attribute contains the number of symbols used to measure the downstream QLN(f) values. It is a 16 bit unsigned value that corresponds to the value specified in the corresponding Recommendation (e.g., the number of symbols in a 1 s interval for [ITU-T G.992.3]). (R) (mandatory) (2 bytes)
- QLNpsds table:** The QLN PSD attribute contains an array of numbers $n(i)$, where i is a subcarrier group index, ranging from 0 to $\min(NSds, 511)$, and n lies in the range 0..254, with a granularity of 0.5 dB. The downstream QLN(f) can be reconstructed by the OLT management client as $(-23 - n(i)/2)$ dBm/Hz, with a range from -150 to -23 dBm/Hz.

The special value $n = 255$ indicates that no measurement could be done for this subcarrier group because it is out of the passband or that the noise PSD is out of range to be represented.

(R) (mandatory) (N bytes, where N is the number of subcarrier groups)

SNRMTds: After a loop diagnostic procedure, the SNR measurement time attribute contains the number of symbols used to measure the downstream SNR(f) values. It is a 16 bit unsigned value that corresponds to the value specified in the corresponding Recommendation (e.g., the number of symbols in a 1 s interval for [ITU-T G.992.3]). (R) (mandatory) (2 bytes)

SNRpsds table: The SNRpsds attribute contains an array of numbers $\text{snr}(i)$, where i is a subcarrier group index, ranging from 0 to $\min(\text{NSds}, 511)$, and snr lies in the range 0..254, with a granularity of 0.5 dB. The downstream SNR function SNR(f) can be reconstructed by the OLT management client as $(-32 + \text{snr}(i)/2)$ dBm/Hz, with a range from -160 to -32 dBm/Hz.

The special value $\text{snr} = 255$ indicates that no measurement could be done for this subcarrier group because it is out of the passband or that the noise PSD is out of range to be represented.

(R) (mandatory) (N bytes, where N is the number of subcarrier groups)

BITSpds table: This attribute reports the downstream bits allocation table per subcarrier. It is an array of values in the range 0..15 for subcarriers 0..NSds. Entries for subcarriers out of the downstream medley set are set to 0. (R) (mandatory) (N bytes, where N is the number of subcarriers)

GAINSpds table: This attribute contains the downstream gain allocation table per subcarrier. It is an array of integer values in the range 0..4093 for subcarriers 0..NSds. The gain is represented as a multiple of 1/512 on a linear scale. Entries for subcarriers out of the downstream medley set are set to 0. (R) (mandatory) (2N bytes, where N is the number of subcarriers)

Actions

Get, get next

Notifications

None.

9.7.15 xDSL line inventory and status data part 4

This ME extends the attributes defined in the xDSL line inventory and status data parts 1, 2 and 3. This ME reports upstream attributes.

Relationships

This is one of the status data MEs associated with an xDSL UNI. The ONU automatically creates or deletes an instance of this ME upon creation or deletion of a PPTP xDSL UNI part 1 that supports these attributes.

Attributes

Managed entity ID: This attribute uniquely identifies each instance of this ME. Through an identical ID, this ME is implicitly linked to an instance of the PPTP xDSL UNI part 1 ME. (R) (mandatory) (2 bytes)

TSSpsus table: This attribute contains the upstream transmit spectrum shaping attributes, expressed as the set of breakpoints exchanged during [ITU-T G.994.1]. Each

breakpoint consists of a 2 byte subcarrier index and the associated shaping attribute. The shaping attribute is one byte, a value in the range 0..126, representing a multiple of -0.5 dB. The special value 127 indicates that the subcarrier is not transmitted. (R) (mandatory) ($3 * N$ bytes, where N is the number of breakpoints)

HLINSCus: This attribute is a 16 bit unsigned integer, the scale factor to be applied to the upstream $H_{lin}(f)$ values. It is only available after a loop diagnostic procedure. (R) (mandatory) (2 bytes)

HLINpsus table: This attribute is an array of complex upstream $H_{lin}(f)$ values in linear scale. It is coded in the same way as the related downstream attribute HLINpsds (see xDSL line inventory and status data part 3). This attribute is only available after a loop diagnostic procedure. (R) (mandatory) ($4N$ bytes, where N is the number of subcarrier groups)

HLOGMTus: After a loop diagnostic procedure, this attribute contains the number of symbols used to measure the upstream $H_{log}(f)$ values. Its value corresponds to the value specified in the corresponding Recommendation (e.g., the number of symbols in a 1 s interval for [ITU-T G.992.3]). (R) (mandatory) (2 bytes)

HLOGpsus table: This attribute is an array of real upstream $H_{log}(f)$ values. It is coded in the same way as the related downstream attribute HLOGpsds (see xDSL line inventory and status data part 3). (R) (mandatory) ($2 * N$ bytes, where N is the number of subcarrier groups)

QLNMTus: After a loop diagnostic procedure, the QLN PSD measurement attribute contains the number of symbols used to measure the upstream QLN(f) values. Its value corresponds to the value specified in the governing Recommendation (e.g., the number of symbols in a 1 s interval for [ITU-T G.992.3]). (R) (mandatory) (2 bytes)

QLNpsus table: The QLN attribute represents an array of real upstream QLN(f) values. It is coded in the same way as the related downstream attribute QLNpsds (see xDSL line inventory and status data part 3). (R) (mandatory) (N bytes, where N is the number of subcarrier groups)

SNRMTus: After a loop diagnostic procedure, the SNR measurement time attribute reports the number of symbols used to measure the upstream SNR(f) values. Its value corresponds to the value specified in the governing Recommendation (e.g., the number of symbols in a 1 s interval for [ITU-T G.992.3]). (R) (mandatory) (2 bytes)

SNRpsus table: This attribute is an array of real upstream SNR(f) values. It is coded in the same way as the related downstream attribute SNRpsds (see xDSL line inventory and status data part 3). (R) (mandatory) (N bytes, where N is the number of subcarrier groups)

BITSpus table: This attribute contains the upstream bits allocation table per subcarrier. It is an array in the range 0..15 for subcarriers 0.. N_{SUS} . Entries for subcarriers out of the upstream medley set are set to 0. (R) (mandatory) (N bytes, where N is the number of subcarriers)

GAINSpus table: This attribute contains the upstream gains allocation table per subcarrier. It is an array in the range 0..4093 for subcarriers 0.. N_{SUS} . The gain is represented as a multiple of $1/512$ on a linear scale. Entries for subcarriers out of the upstream medley set are set to 0. (R) (mandatory) ($2 * N$ bytes, where N is the number of subcarriers)

Actions

Get, get next

Notifications

None.

9.7.16 VDSL2 line inventory and status data part 1

This ME extends the xDSL line configuration MEs. The ME name was chosen because its attributes were initially unique to ITU-T G.993.2 VDSL2. Due to continuing standards development, some attributes – and therefore this ME – have also become applicable to other Recommendations, specifically [ITU-T G.992.3] and [ITU-T G.992.5].

This ME contains general and downstream attributes.

Relationships

This is one of the status data MEs associated with an xDSL UNI. It is meaningful if the PPTP supports [ITU-T G.992.3], [ITU-T G.992.5] or [ITU-T G.993.2]. The ONU automatically creates or deletes an instance of this ME upon creation and deletion of a PPTP xDSL UNI part 1 that supports these attributes.

Attributes

Managed entity ID: This attribute uniquely identifies each instance of this ME. Through an identical ID, this ME is implicitly linked to an instance of the PPTP xDSL UNI part 1 ME. (R) (mandatory) (2 bytes)

VDSL2 transmission system capability xTU-C: This attribute extends the xTU-C transmission system capability attribute of the xDSL line inventory and status data part 1 to include xTU-C VDSL2 capabilities. It is defined by bits 57..64 of Table 9.7.12-1. (R) (mandatory) (1 byte)

VDSL2 transmission system: This attribute reports the transmission system in use. It extends the xDSL transmission system attribute of the xDSL line inventory and status data part 2 ME with a byte that includes VDSL2 capabilities currently in use. It is defined by bits 57..64 of Table 9.7.12-1. (R) (mandatory) (1 byte)

VDSL2 profile: This attribute identifies the profile in use. It is a bit map (0 if not allowed, 1 if allowed) with the following definition:

Bit	Meaning
1 (LSB)	ITU-T G.993.2 profile 8a
2	ITU-T G.993.2 profile 8b
3	ITU-T G.993.2 profile 8c
4	ITU-T G.993.2 profile 8d
5	ITU-T G.993.2 profile 12a
6	ITU-T G.993.2 profile 12b
7	ITU-T G.993.2 profile 17a
8	ITU-T G.993.2 profile 30a

(R) (mandatory) (1 byte)

VDSL2 limit PSD mask and bandplan: This attribute defines the limit PSD mask and band plan in use. It is a bit map as defined by Table 9.7.6-1. (R) (mandatory) (8 bytes)

VDSL2 US0 PSD mask: This attribute defines the US0 PSD mask in use. It is a bit map as defined by Table 9.7.6-2. (R) (mandatory) (4 bytes)

ACTSNRMODEds: This attribute indicates whether transmitter-referred virtual noise is active on the line in the downstream direction.

- 1 Virtual noise inactive
- 2 Virtual noise active

(R) (mandatory) (1 byte)

The following four attributes have similar definitions. In each case, valid attribute values are 1, 2, 4, 8. In ADSL applications, the corresponding value is fixed at 1, and therefore need not be specified. For VDSL2, it is equal to the size of the subcarrier group used to compute these attributes (see clause 11.4.1 of [ITU-T G.993.2]).

HLINGds: This attribute contains the number of subcarriers per group used to report HLINpsds. (R) (mandatory) (1 byte)

HLOGGs: This attribute contains the number of subcarriers per group used to report HLOGpsds. (R) (mandatory) (1 byte)

QLNGds: This attribute contains the number of subcarriers per group used to report QLNpsds. (R) (mandatory) (1 byte)

SNRGds: This attribute contains the number of subcarriers per group used to report SNRpsds. (R) (mandatory) (1 byte)

MREFPSDds table: The downstream medley reference PSD table contains the set of breakpoints exchanged in the MREFPSDds fields of the O-PRM message of [ITU-T G.993.2].

The format is similar to that specified for the PSD descriptor in [ITU-T G.993.2]. In [ITU-T G.993.2], the first byte gives the size of the table, each entry of which is 3 bytes. In the OMCI definition, the first byte is omitted because the size of the table is known from the response to the get command.

(R) (mandatory) (3 * *N* bytes, where *N* is the number of breakpoints)

TRELLISds: This attribute reports whether trellis coding is in use in the downstream direction.

- 0 Trellis not used
- 1 Trellis used

(R) (mandatory for ITU-T G.993.2 VDSL2, optional for others) (1 byte)

Actual rate adaptation mode downstream: The ACT-RA-MODEds attribute indicates the actual active RA mode in the downstream direction.

- 1 MANUAL
- 2 AT_INIT
- 3 DYNAMIC
- 4 DYNAMIC with SOS ([ITU-T G.993.2] only)

(R) (optional) (1 byte)

Actual impulse noise protection robust operations channel (ROC) downstream: The ACTINP-ROC-ds attribute reports the actual INP of the ROC in the downstream direction expressed in multiples of T_{4k} . The INP of this attribute

is equal to the integer value multiplied by 0.1 symbols. Valid values and usage are given in clause 7.5.1.34.1 of [ITU-T G.997.1]. (R) (optional) (1 byte)

SNR margin ROC downstream: The SNRM-ROC-ds attribute reports the actual signal-to-noise margin of the ROC in the downstream direction. Its value ranges from 0 (−64.0 dB) to 1270 (+63.0 dB). The special value 0xFFFF indicates that the attribute is out of range. (R) (optional) (2 bytes)

Actions

Get, get next

Notifications

None.

9.7.17 VDSL2 line inventory and status data part 2

This ME extends the xDSL line configuration MEs. The ME name was chosen because its attributes were initially unique to ITU-T G.993.2 VDSL2. Due to continuing standards development, some attributes – and therefore this ME – have also become applicable to other Recommendations, specifically [ITU-T G.992.3] and [ITU-T G.992.5].

This ME contains upstream attributes.

Relationships

This is one of the status data MEs associated with an xDSL UNI. It is meaningful if the PPTP supports [ITU-T G.992.3], [ITU-T G.992.5] or [ITU-T G.993.2]. The ONU automatically creates or deletes an instance of this ME upon creation and deletion of a PPTP xDSL UNI part 1 that supports these attributes.

Attributes

Managed entity ID: This attribute uniquely identifies each instance of this ME. Through an identical ID, this ME is implicitly linked to an instance of the PPTP xDSL UNI part 1 ME. (R) (mandatory) (2 bytes)

VDSL2 transmission system capability xTU-R: This attribute extends the xTU-R transmission system capability attribute of the xDSL line inventory and status data part 1 to include xTU-R VDSL2 capabilities. It is defined by bits 57..64 of Table 9.7.12-1. (R) (mandatory) (1 byte)

ACTSNRMODEus: This attribute indicates whether transmitter-referred virtual noise is active on the line in the upstream direction.

- 1 Virtual noise inactive
- 2 Virtual noise active

(R) (mandatory) (1 byte)

UPBOKLE: This attribute contains the electrical length estimated by the VTU-O expressed in decibels at 1 MHz, kl_0 (see O-UPDATE in clause 12.3.3.2.1.2 of [ITU-T G.993.2]). This is the final electrical length that would have been sent from the VTU-O to the VTU-R if the electrical length were not forced by the OLT. The value lies in the range 0 (0.0 dB) to 1280 (128.0 dB) (R) (mandatory) (2 bytes)

The following four attributes have similar definitions. In each case, valid attribute values are 1, 2, 4, 8. In ADSL applications, the corresponding value is fixed at 1, and therefore need not be specified. For VDSL2, it is equal to the size of the subcarrier group used to compute these attributes (see clause 11.4.1 of [ITU-T G.993.2]).

- HLINGus:** This attribute is the number of subcarriers per group used to report HLINpsus. (R) (mandatory) (1 byte)
- HLOGGus:** This attribute is the number of subcarriers per group used to report HLOGpsus. (R) (mandatory) (1 byte)
- QLNGus:** This attribute is the number of subcarriers per group used to report QLNpsus. (R) (mandatory) (1 byte)
- SNRGus:** This attribute is the number of subcarriers per group used to report SNRpsus. (R) (mandatory) (1 byte)
- MREFPSDus table:** The upstream medley reference PSD attribute contains the set of breakpoints exchanged in the MREFPSDus fields of the R-PRM message of [ITU-T G.993.2].
The format is similar to that specified for the PSD descriptor in [ITU-T G.993.2]. In [ITU-T G.993.2], the first byte gives the size of the table, each entry of which is 3 bytes. In the OMCI definition, the first byte is omitted because the size of the table is known from the response to the get command.
(R) (mandatory) (3 * *N* bytes, where *N* is the number of breakpoints)
- TRELLISus:** This attribute reports whether trellis coding is in use in the upstream direction.
0 Trellis not used
1 Trellis used
(R) (mandatory for ITU-T G.993.2 VDSL2, optional for others) (1 byte)
- ACTUALCE:** This attribute reports the cyclic extension used on the line. It is coded as an unsigned integer from 2 to 16 in units of *N*/32 samples, where 2*N* is the IDFT size. (R) (mandatory) (1 byte)
- UPBOKLE-R:** This attribute contains the electrical length estimated by the VTU-R expressed in decibels at 1 MHz. This is the value contained in the message R-MSG1 (see clause 12.3.3.2.2.1 of [ITU-T G.993.2]). Its value lies in the range 0 (0.0 dB) to 1280 (128.0 dB) (R) (optional) (2 bytes)
- Actual rate adaptation mode upstream:** The ACT-RA-MODEus attribute indicates the actual active RA mode in the upstream direction.
1 MANUAL
2 AT_INIT
3 DYNAMIC
4 DYNAMIC with SOS ([ITU-T G.993.2] only)
(R) (optional) (1 byte)
- Actual impulse noise protection ROC upstream:** The ACTINP-ROC-us attribute reports the actual INP of the ROC in the upstream direction expressed in multiples of *T*_{4k}. The INP of this attribute is equal to the integer value multiplied by 0.1 symbols. Valid values and usage are given in clause 7.5.1.34.2 of [ITU-T G.997.1]. (R) (optional) (1 byte)
- SNR margin ROC upstream:** The SNRM-ROC-us attribute reports the actual signal-to-noise margin of the ROC in the upstream direction. Its value ranges from 0 (−64.0 dB) to 1270 (+63.0 dB). The special value 0xFFFF indicates that the attribute is out of range. (R) (optional) (2 bytes)

Actions

Get, get next

Notifications

None.

9.7.18 VDSL2 line inventory and status data part 3

This ME extends the other xDSL line inventory and status data MEs with attributes specific to VDSL2. This ME contains per-band attributes for both directions. These same attributes are defined in the xDSL line inventory and status data part 2 ME, but only for a single band. [ITU-T G.993.2] allows for VDSL2 to have as many as five bands upstream and as many as five bands downstream.

Relationships

This is one of the status data MEs associated with an xDSL UNI. It is required only if VDSL2 is supported by the PPTP. The ONU automatically creates or deletes an instance of this ME upon creation or deletion of a PPTP xDSL UNI part 1 that supports these attributes.

Attributes

Managed entity ID: This attribute uniquely identifies each instance of this ME. Through an identical ID, this ME is implicitly linked to an instance of the PPTP xDSL UNI part 1 ME. (R) (mandatory) (2 bytes)

Upstream bands count: This attribute reports the number of upstream bands. It can be used to filter the upstream attributes. All upstream attributes are arrays of per-band entries, of which the first upstream bands count are populated. The contents of the arrays for unused frequency bands are unspecified. The original attributes were allocated for as many as four upstream bands, US0, 1, 2, 3; optional extended attributes have been added to accommodate the possibility that five upstream bands may be needed. (R) (mandatory) (1 byte)

Downstream bands count: This attribute reports the number of downstream bands. It can be used to filter the downstream attributes. All downstream attributes are arrays of per-band entries, of which the first downstream bands count are populated. The contents of the arrays for unused frequency bands are unspecified. The original attributes were allocated for as many as three downstream bands, DS1, 2, 3; optional extended attributes have been added to accommodate the possibility that five downstream bands may be needed. (R) (mandatory) (1 byte)

Downstream line attenuation per band: The LATNds attribute is defined per usable band. It is the squared magnitude of the channel characteristics function, $H(f)$, averaged over this band, and measured during loop diagnostic mode and initialization. The exact definition is included in the relevant xDSL Recommendation. The upstream line attenuation per band ranges from 0 (0.0 dB) to 1270 (+127.0 dB). The special value 0xFFFF indicates that the line attenuation per band is out of the range to be represented. (R) (mandatory) (3 bands * 2 bytes = 6 bytes)

Upstream line attenuation per band: The LATNus attribute is defined per usable band. It is the squared magnitude of the channel characteristics function $H(f)$ averaged over this band, and measured during loop diagnostic mode and initialization. The exact definition is included in the relevant xDSL Recommendation. The upstream line attenuation per band ranges from 0 (0.0 dB) to 1270 (+127.0 dB). The special value 0xFFFF indicates that line attenuation per band is out of range to be represented. (R) (mandatory) (4 bands * 2 bytes = 8 bytes)

Downstream signal attenuation per band: The SATNds attribute is defined per usable band. It is the measured difference in the total power transmitted in this band by the

xTU-C and the total power received by the xTU-R during loop diagnostic mode, initialization and showtime. The exact definition is included in the relevant xDSL Recommendation. The downstream signal attenuation per band ranges from 0 (0.0 dB) to 1270 (+127.0 dB). The special value 0xFFFF indicates that the signal attenuation per band is out of the range to be represented. (R) (mandatory) (3 bands * 2 bytes = 6 bytes)

NOTE 1 – During showtime, only a subset of the subcarriers may be transmitted by the xTU-C, as compared to loop diagnostic mode and initialization. Therefore, the downstream signal attenuation value during showtime may be significantly lower than the downstream signal attenuation value during loop diagnostic mode and initialization.

Upstream signal attenuation per band: The SATNus attribute is defined per usable band. It is the measured difference in decibels in the total power transmitted in this band by the xTU-R and the total power received in this band by the xTU-C during loop diagnostic mode, initialization and showtime. The exact definition is included in the relevant xDSL Recommendation. The upstream signal attenuation per band ranges from 0 (0.0 dB) to 1270 (+127.0 dB). The special value 0xFFFF indicates the signal attenuation per band is out of range to be represented. (R) (mandatory) (4 bands * 2 bytes = 8 bytes)

NOTE 2 – During showtime, only a subset of the subcarriers may be transmitted by the xTU-R, as compared to loop diagnostic mode and initialization. Therefore, the upstream signal attenuation value during showtime may be significantly lower than the upstream signal attenuation value during loop diagnostic mode and initialization.

Downstream SNR margin per band: The SNRMpbds attribute is defined per usable band. The downstream SNR margin per band is the maximum increase of noise power received at the xTU-R, such that the BER requirements are met for all downstream bearer channels. Each array value ranges from 0 (–64.0 dB) to 1270 (+63.0 dB). The special value 0xFFFF indicates that the attribute is out of range to be represented. (R) (mandatory) (3 bands * 2 bytes = 6 bytes)

Upstream SNR margin per band: The SNRMpbus attribute is defined per usable band. The upstream SNR margin per band is the maximum increase of noise power received at the xTU-C, such that the BER requirements are met for all upstream bearer channels. Each array value ranges from 0 (–64.0 dB) to 1270 (+63.0 dB). The special value 0xFFFF indicates that the attribute is out of range to be represented. (R) (mandatory) (4 bands * 2 bytes = 8 bytes)

Downstream line attenuation extension: This attribute extends LATNds when more than three downstream bands are used. It is defined in the same way as the downstream line attenuation per band attribute. (R) (optional) (2 bands * 2 bytes = 4 bytes)

Upstream line attenuation extension: This attribute extends LATNus when more than four upstream bands are used. It is defined in the same way as the upstream line attenuation per band attribute. (R) (optional) (1 band * 2 bytes = 2 bytes)

Downstream signal attenuation extension: This attribute extends SATNds when more than three downstream bands are used. It is defined in the same way as the downstream signal attenuation per band attribute. (R) (optional) (2 bands * 2 bytes = 4 bytes)

Upstream signal attenuation extension: This attribute extends SATNus when more than four upstream bands are used. It is defined in the same way as the upstream signal attenuation per band attribute. (R) (optional) (1 band * 2 bytes = 2 bytes)

Downstream SNR margin extension: This attribute extends SNRMpbds when more than three downstream bands are used. It is defined in the same way as the downstream SNR margin per band attribute. (R) (optional) (2 bands * 2 bytes = 4 bytes)

Upstream SNR margin extension: This attribute extends SNRMpbus when more than four upstream bands are used. It is defined in the same way as the upstream SNR margin per band attribute. (R) (optional) (1 band * 2 bytes = 2 bytes)

Actions

Get

Notifications

None.

9.7.19 xDSL channel downstream status data

This ME contains downstream channel status data for an xDSL UNI. The ONU automatically creates or deletes instances of this ME upon the creation or deletion of a PPTP xDSL UNI part 1.

NOTE – [ITU-T G.997.1] specifies that bit rate attributes have a granularity of 1000 bit/s. If ITU-T G.997.1 compliance is required, the ONU should only report values with this granularity.

Relationships

One or more instances of this ME are associated with an instance of an xDSL UNI.

Attributes

Managed entity ID: This attribute uniquely identifies each instance of this ME. The two MSBs of the first byte are the bearer channel ID. Excluding the first 2 bits of the first byte, the remaining part of the ME ID is identical to that of this ME's parent PPTP xDSL UNI part 1. (R) (mandatory) (2 bytes)

Actual interleaving delay: This attribute is the actual one-way interleaving delay introduced by the PMS-TC between the alpha and beta reference points, excluding delay in the L1 and L2 states. In the L1 and L2 states, the attribute contains the interleaving delay in the previous L0 state. For ADSL, this attribute is derived from the *S* and *D* attributes as $\text{cap}(S*D)/4$ ms, where *S* is the number of symbols per codeword, *D* is the interleaving depth and $\text{cap}()$ denotes rounding to the next higher integer. For [ITU-T G.993.2], this attribute is computed according to the formula in clause 9.7 of [ITU-T G.993.2]. The actual interleaving delay is coded in milliseconds, rounded to the nearest millisecond. (R) (mandatory) (1 byte)

Actual data rate: This parameter reports the actual net data rate of the bearer channel, excluding the rate in the L1 and L2 states. In the L1 or L2 state, the parameter contains the net data rate in the previous L0 state. The data rate is coded in bits per second. (R) (mandatory) (4 bytes)

Previous data rate: This parameter reports the previous net data rate of the bearer channel just before the latest rate change event occurred, excluding transitions between the L0 state and the L1 or L2 states. A rate change can occur at a power management state transition, e.g., at full or short initialization, fast retrain or power down, or at a dynamic rate adaptation. The rate is coded in bits per second (R) (mandatory) (4 bytes)

Actual impulse noise protection: The ACTINP attribute reports the actual INP on the bearer channel in the L0 state. In the L1 or L2 state, the attribute contains the INP in

the previous L0 state. The value of this attribute is a number of DMT symbols, with a granularity of 0.1 symbols. Its range is from 0 (0.0 symbols) to 254 (25.4 symbols). The special value 255 indicates an ACTINP higher than 25.4. (R) (optional for [ITU-T G.992.1], mandatory for other xDSL Recommendations that support this attribute) (1 byte)

Actual size of Reed-Solomon codeword: The NFEC attribute reports the actual Reed-Solomon codeword size used in the latency path in which the bearer channel is transported. The value is coded in bytes, and ranges from 0..255. (R) (mandatory for ITU-T G.993.2 VDSL2, optional for others) (1 byte)

Actual number of Reed-Solomon redundancy bytes: The RFEC attribute reports the actual number of Reed-Solomon redundancy bytes per codeword used in the latency path in which the bearer channel is transported. The value is coded in bytes, and ranges from 0..16. The value 0 indicates no Reed-Solomon coding. (R) (mandatory for ITU-T G.993.2 VDSL2, optional for others) (1 byte)

Actual number of bits per symbol: The LSYMB attribute reports the actual number of bits per symbol assigned to the latency path in which the bearer channel is transported, excluding trellis overhead. The value is coded in bits, and ranges from 0..65535. (R) (mandatory for [TU-T G.993.2 VDSL2, optional for others) (2 bytes)

Actual interleaving depth: The INTLVDEPTH attribute reports the actual depth of the interleaver used in the latency path in which the bearer channel is transported. The value ranges from 1..4096 in steps of 1. The value 1 indicates no interleaving. (R) (mandatory for ITU-T G.993.2 VDSL2, optional for others) (2 bytes)

Actual interleaving block length: The INTLVBLOCK attribute reports the actual block length of the interleaver used in the latency path in which the bearer channel is transported. The value ranges from 4..255 in steps of 1. (R) (mandatory for ITU-T G.993.2 VDSL2, undefined for others) (1 byte)

Actual latency path: The LPATH attribute reports the index of the actual latency path in which the bearer channel is transported. Valid values are 0..3. In [ITU-T G.992.1], the fast path is mapped to latency index 0; the interleaved path to index 1. (R) (mandatory for ITU-T G.993.2 VDSL2, optional for others) (1 byte)

Actual impulse noise protection against repetitive electrical impulse noise (ACTINP_REIN): If retransmission is used in a given transmit direction, this parameter reports the actual INP against REIN on the bearer channel. The INP of this attribute is equal to the integer value multiplied by 0.1 symbols. Valid values and usage are given in clause 7.5.2.9 of [ITU-T G.997.1] (R) (optional) (1 byte)

Actions

Get

Notifications

None.

9.7.20 xDSL channel upstream status data

This ME contains upstream channel status data for an xDSL UNI. The ONU automatically creates or deletes instances of this ME upon the creation or deletion of a PPTP xDSL UNI part 1.

Relationships

One or more instances of this ME are associated with an instance of an xDSL UNI.

Attributes

Managed entity ID: This attribute uniquely identifies each instance of this ME. The two MSBs of the first byte are the bearer channel ID. Excluding the first 2 bits of the first byte, the remaining part of the ME ID is identical to that of this ME's parent PPTP xDSL UNI part 1. (R) (mandatory) (2 bytes)

Actual interleaving delay: This attribute is the actual one-way interleaving delay introduced by the PMS-TC between the alpha and beta reference points, excluding the L1 and L2 states. In the L1 and L2 states, this attribute contains the interleaving delay in the previous L0 state. For ADSL, this attribute is derived from the S and D attributes as $\text{cap}(S \cdot D)/4$ ms, where S is the number of symbols per codeword, D is the interleaving depth and $\text{cap}()$ denotes rounding to the next higher integer. For [ITU-T G.993.2], this attribute is computed according to the formula in clause 9.7 of [ITU-T G.993.2]. The actual interleaving delay is coded in milliseconds, rounded to the nearest millisecond. (R) (mandatory) (1 byte)

Actual data rate: This parameter reports the actual net data rate of the bearer channel, excluding the L1 and L2 states. In the L1 or L2 state, the parameter contains the net data rate in the previous L0 state. The data rate is coded in bits per second. (R) (mandatory) (4 bytes)

Previous data rate: This parameter reports the previous net data rate of the bearer channel just before the latest rate change event occurred, excluding transitions between the L0 state and the L1 or L2 state. A rate change can occur at a power management state transition, e.g., at full or short initialization, fast retrain or power down, or at a dynamic rate adaptation. The rate is coded in bits per second. (R) (mandatory) (4 bytes)

Actual impulse noise protection: The ACTINP attribute reports the actual INP on the bearer channel in the L0 state. In the L1 or L2 state, the attribute contains the INP in the previous L0 state. The value is coded in fractions of DMT symbols with a granularity of 0.1 symbols. The range is from 0 (0.0 symbols) to 254 (25.4 symbols). The special value 255 indicates an ACTINP higher than 25.4. (R) (mandatory for ITU-T G.993.2 VDSL2, optional for other xDSL Recommendations that support it) (1 byte)

Impulse noise protection reporting mode: The INPREPORT attribute reports the method used to compute the ACTINP. If set to 0, the ACTINP is computed according to the INP_no_erasure formula (clause 9.6 of [ITU-T G.993.2]). If set to 1, ACTINP is the value estimated by the xTU receiver. (R) (mandatory for ITU-T G.993.2 VDSL2) (1 byte)

Actual size of Reed-Solomon codeword: The NFEC attribute reports the actual Reed-Solomon codeword size used in the latency path in which the bearer channel is transported. Its value is coded in bytes in the range 0..255. (R) (mandatory for ITU-T G.993.2 VDSL2, optional for others) (1 byte)

Actual number of Reed-Solomon redundancy bytes: The RFEC attribute reports the actual number of Reed-Solomon redundancy bytes per codeword used in the latency path in which the bearer channel is transported. Its value is coded in bytes in the range 0..16. The value 0 indicates no Reed-Solomon coding. (R) (mandatory for ITU-T G.993.2 VDSL2, optional for others) (1 byte)

Actual number of bits per symbol: The LSYMB attribute reports the actual number of bits per symbol assigned to the latency path in which the bearer channel is transported, excluding trellis overhead. Its value is coded in bits in the range 0..65535. (R) (mandatory for ITU-T G.993.2 VDSL2, optional for others) (2 bytes)

Actual interleaving depth: The INTLVDEPTH attribute reports the actual depth of the interleaver used in the latency path in which the bearer channel is transported. Its value ranges from 1..4096 in steps of 1. The value 1 indicates no interleaving. (R) (mandatory for ITU-T G.993.2 VDSL2, optional for others) (2 bytes)

Actual interleaving block length: The INTLVBLOCK attribute reports the actual block length of the interleaver used in the latency part in which the bearer channel is transported. Its value ranges from 4..255 in steps of 1. (R) (mandatory for ITU-T G.993.2 VDSL2, optional for others) (1 byte)

Actual latency path: The LPATH attribute reports the index of the actual latency path in which the bearer channel is transported. Valid values are 0..3. In [ITU-T G.992.1], the fast path is mapped to latency index 0; the interleaved path to index 1. (R) (mandatory for ITU-T G.993.2 VDSL2, optional for others) (1 byte)

Actions

Get

Notifications

None.

9.7.21 xDSL xTU-C performance monitoring history data

This ME collects PM data on the xTU-C to xTU-R path as seen from the xTU-C. Instances of this ME are created and deleted by the OLT.

For a complete discussion of generic PM architecture, refer to clause I.4.

Relationships

An instance of this ME is associated with an xDSL UNI.

Attributes

Managed entity ID: This attribute uniquely identifies each instance of this ME. Through an identical ID, this ME is implicitly linked to an instance of the PPTP xDSL UNI part 1. (R, set-by-create) (mandatory) (2 bytes)

Interval end time: This attribute identifies the most recently finished 15 min interval. (R) (mandatory) (1 byte)

Threshold data 1/2 ID: This attribute points to an instance of the threshold data 1 and 2 MEs that contain PM threshold values. (R, W, set-by-create) (mandatory) (2 bytes)

Loss of frame seconds: (R) (mandatory) (2 bytes)

Loss of signal seconds: (R) (mandatory) (2 bytes)

Loss of link seconds: (R) (mandatory) (2 bytes)

Loss of power seconds: (R) (mandatory) (2 bytes)

Errored seconds (ES): This attribute counts 1 s intervals with one or more CRC-8 anomalies summed over all received bearer channels, or one or more loss of signal (LOS) defects, or one or more SEF defects, or one or more LPR defects. (R) (mandatory) (2 bytes)

Severely errored seconds: This attribute counts severely errored seconds (SES-L). An SES is declared if, during a 1 s interval, there were 18 or more CRC-8 anomalies in one or more of the received bearer channels, or one or more LOS defects, or one or more SEF defects, or one or more LPR defects.

If the relevant Recommendation ([ITU-T G.992.3], [ITU-T G.992.5] or [ITU-T G.993.2]) supports a 1 s normalized CRC-8 anomaly counter increment, the 1 s SES counter follows this value instead of counting CRC-8 anomalies directly.

If a common CRC is applied over multiple bearer channels, then each related CRC-8 anomaly is counted only once for the whole set of bearer channels over which the CRC is applied.

(R) (mandatory) (2 bytes)

Line initializations: This attribute counts the total number of full initializations attempted on the line, both successful and failed. (R) (mandatory) (2 bytes)

Failed line initializations: This attribute counts the total number of failed full initializations during the accumulation period. A failed full initialization occurs when showtime is not reached at the end of the full initialization procedure. (R) (mandatory) (2 bytes)

Short initializations: This attribute counts the total number of fast retrains or short initializations attempted on the line, successful and failed. Fast retrain is defined in [ITU-T G.992.2]. Short initialization is defined in [ITU-T G.992.3] and [ITU-T G.992.4]. (R) (optional) (2 bytes)

Failed short initializations: This attribute counts the total number of failed fast retrains or short initializations during the accumulation period, e.g., when:

- a CRC error is detected;
- a timeout occurs;
- a fast retrain profile is unknown.

(R) (optional) (2 bytes)

FEC seconds: This attribute counts seconds during which at least one uncorrectable FEC codeword was received. (R) (mandatory) (2 bytes)

Unavailable seconds: This attribute counts 1 s intervals during which the xDSL UNI is unavailable. The line becomes unavailable at the onset of 10 contiguous SES-Ls. The 10 SES-Ls are included in unavailable time. Once unavailable, the line becomes available at the onset of 10 contiguous seconds that are not severely errored. The 10 s with no SES-Ls are excluded from unavailable time. Some attribute counts are inhibited during unavailability – see clause 7.2.7.13 of [ITU-T G.997.1]. (R) (mandatory) (2 bytes)

SOS success count, near end: The SOS-SUCCESS-NE attribute is a count of the total number of successful SOS procedures initiated by the near-end xTU on the line during the accumulation period. Successful SOS is defined in clause 12.1.4 of [ITU-T G.993.2]. (R) (optional) (2 bytes)

SOS success count, far end: The SOS-SUCCESS-FE attribute is a count of the total number of successful SOS procedures initiated by the far-end xTU on the line during

the accumulation period. Successful SOS is defined in clause 12.1.4 of [ITU-T G.993.2]. (R) (optional) (2 bytes)

Actions

Create, delete, get, set

Get current data (optional)

Notifications

Threshold crossing alert

Alarm number	Threshold crossing alert	Threshold value attribute No. (Note)
0	Loss of frame seconds	1
1	Loss of signal seconds	2
2	Loss of link seconds	3
3	Loss of power seconds	4
4	Errored seconds	5
5	Severely errored seconds	6
6	Line initializations	7
7	Failed line initializations	8
8	Short initializations	9
9	Failed short initializations	10
10	FEC seconds	11
11	Unavailable seconds	12

NOTE – This number associates the TCA with the specified threshold value attribute of the threshold data 1/2 managed entities.

9.7.22 xDSL xTU-R performance monitoring history data

This ME collects PM data of the xTU-C to xTU-R path as seen from the xTU-R. Instances of this ME are created and deleted by the OLT.

For a complete discussion of generic PM architecture, refer to clause I.4.

Relationships

An instance of this ME is associated with an xDSL UNI.

Attributes

Managed entity ID: This attribute uniquely identifies each instance of this ME. Through an identical ID, this ME is implicitly linked to an instance of the PPTP xDSL UNI part 1. (R, set-by-create) (mandatory) (2 bytes)

Interval end time: This attribute identifies the most recently finished 15 min interval. (R) (mandatory) (1 byte)

Threshold data 1/2 ID: This attribute points to an instance of the threshold data 1 ME that contains PM threshold values. Since no threshold value attribute number exceeds 7, a threshold data 2 ME is optional. (R, W, set-by-create) (mandatory) (2 bytes)

Loss of frame seconds: (R) (mandatory) (2 bytes)

Loss of signal seconds: (R) (mandatory) (2 bytes)

Loss of power seconds: (R) (mandatory) (2 bytes)

Errored seconds: This attribute counts 1 s intervals with one or more far end block error (FEBE) anomalies summed over all transmitted bearer channels, or one or more LOS-FE defects, or one or more RDI defects, or one or more LPR-FE defects. (R) (mandatory) (2 bytes)

Severely errored seconds: This attribute counts severely errored seconds (SES-LFE). An SES is declared if, during a 1 s interval, 18 or more FEBE anomalies were reported across the totality of bearer channels, or there were one or more far-end LOS defects, one or more RDI defects or one or more LPR-FE defects.

If the relevant Recommendation ([ITU-T G.992.3], [ITU-T G.992.5] or [ITU-T G.993.2]) supports a 1 s normalized CRC-8 anomaly counter increment, the 1 s SES counter follows this value instead of counting FEBE anomalies directly.

If a CRC is applied for multiple bearer channels, then each related FEBE anomaly is counted only once for the whole set of related bearer channels.

(R) (mandatory) (2 bytes)

FEC seconds: This attribute counts seconds during which at least one uncorrectable FEC codeword was received. (R) (mandatory) (2 bytes)

Unavailable seconds: This attribute counts 1 s intervals during which the far-end xDSL termination is unavailable.

The far-end xDSL termination becomes unavailable at the onset of 10 contiguous SES-LFEs. The 10 SES-LFEs are included in unavailable time. Once unavailable, the far-end line becomes available at the onset of 10 contiguous seconds with no SES-LFEs. The 10 s with no SES-LFEs are excluded from unavailable time. Some attribute counts are inhibited during unavailability – see clause 7.2.7.13 of [ITU-T G.997.1].

(R) (mandatory) (2 bytes)

"leftr" defect seconds: If retransmission is used, this parameter is a count of the seconds with a near-end "leftr" defect present – see clause 7.2.1.1.6 of [ITU-T G.997.1]. (R) (optional) (2 bytes)

Error-free bits counter: If retransmission is used, this parameter is a count of the number of error-free bits passed over the β 1 reference point, divided by 2^{16} – see clause 7.2.1.1.7 of [ITU-T G.997.1]. (R) (optional) (4 bytes)

Minimum error-free throughput (MINEFTR): If retransmission is used, this parameter is the minimum error-free throughput in bits per second – see clause 7.2.1.1.8 of [ITU-T G.997.1]. (R) (optional) (4 bytes)

Actions

Create, delete, get, set

Get current data (optional)

Notifications

Threshold crossing alert

Alarm number	Threshold crossing alert	Threshold value attribute No. (Note)
0	Loss of frame seconds	1
1	Loss of signal seconds	2
2	Loss of power seconds	3
3	Errored seconds	4
4	Severely errored seconds	5
5	FEC seconds	6
6	Unavailable seconds	7
7	"left" defect seconds	8

NOTE – This number associates the TCA with the specified threshold value attribute of the threshold data 1 managed entity.

9.7.23 xDSL xTU-C channel performance monitoring history data

This ME collects PM data of an xTU-C to xTU-R channel as seen from the xTU-C. Instances of this ME are created and deleted by the OLT.

For a complete discussion of generic PM architecture, refer to clause I.4.

Relationships

An instance of this ME is associated with an xDSL bearer channel. Several instances may therefore be associated with an xDSL UNI.

Attributes

Managed entity ID: This attribute uniquely identifies each instance of this ME. The two MSBs of the first byte are the bearer channel ID. Excluding the first 2 bits of the first byte, the remaining part of the ME ID is identical to that of this ME's parent PPTP xDSL UNI part 1. (R, set-by-create) (mandatory) (2 bytes)

Interval end time: This attribute identifies the most recently finished 15 min interval. (R) (mandatory) (1 byte)

Threshold data 1/2 ID: This attribute points to an instance of the threshold data 1 ME that contains PM threshold values. Since no threshold value attribute number exceeds 7, a threshold data 2 ME is optional. (R, W, set-by-create) (mandatory) (2 bytes)

Corrected blocks: This attribute counts blocks received with errors that were corrected on this channel. (R) (mandatory) (4 bytes)

Uncorrected blocks: This attribute counts blocks received with uncorrectable errors on this channel. (R) (mandatory) (4 bytes)

Transmitted blocks: This attribute counts encoded blocks transmitted on this channel. (R) (mandatory) (4 bytes)

Received blocks: This attribute counts encoded blocks received on this channel. (R) (mandatory) (4 bytes)

Code violations: This attribute counts CRC-8 anomalies in the bearer channel. (R) (mandatory) (2 bytes)

Forward error corrections: This attribute counts FEC anomalies in the bearer channel. (R)
(mandatory) (2 bytes)

Actions

Create, delete, get, set

Get current data (optional)

Notifications

Threshold crossing alert

Alarm number	Threshold crossing alert	Threshold value attribute No. (Note)
0	Corrected blocks	1
1	Uncorrected blocks	2
2	Code violations	3
3	Forward error corrections	4
NOTE – This number associates the TCA with the specified threshold value attribute of the threshold data 1 managed entity.		

9.7.24 xDSL xTU-R channel performance monitoring history data

This ME collects PM data of the xTU-C to xTU-R channel as seen from the xTU-R. Instances of this ME are created and deleted by the OLT.

For a complete discussion of generic PM architecture, refer to clause I.4.

Relationships

An instance of this ME is associated with an xDSL bearer channel. Several instances may therefore be associated with an xDSL UNI.

Attributes

Managed entity ID: This attribute uniquely identifies each instance of this ME. The two MSBs of the first byte are the bearer channel ID. Excluding the first 2 bits of the first byte, the remaining part of the ME ID is identical to that of this ME's parent PPTP xDSL UNI part 1. (R, set-by-create) (mandatory) (2 bytes)

Interval end time: This attribute identifies the most recently finished 15 min interval. (R) (mandatory) (1 byte)

Threshold data 1/2 ID: This attribute points to an instance of the threshold data 1 ME that contains PM threshold values. Since no threshold value attribute number exceeds 7, a threshold data 2 ME is optional. (R, W, set-by-create) (mandatory) (2 bytes)

Corrected blocks: This attribute counts blocks received with errors that were corrected on this channel. (R) (mandatory) (4 bytes)

Uncorrected blocks: This attribute counts blocks received with uncorrectable errors on this channel. (R) (mandatory) (4 bytes)

Transmitted blocks: This attribute counts encoded blocks transmitted on this channel. (R) (mandatory) (4 bytes)

Received blocks: This attribute counts encoded blocks received on this channel. (R) (mandatory) (4 bytes)

Code violations: This attribute counts FEBE anomalies reported in the downstream bearer channel. If the CRC is applied over multiple bearer channels, then each related FEBE anomaly increments each of the counters related to the individual bearer channels. (R) (mandatory) (2 bytes)

Forward error corrections: This attribute counts FFEC anomalies reported in the downstream bearer channel. If FEC is applied over multiple bearer channels, each related FFEC anomaly increments each of the counters related to the individual bearer channels. (R) (mandatory) (2 bytes)

Actions

Create, delete, get, set
Get current data (optional)

Notifications

Threshold crossing alert

Alarm number	Threshold crossing alert	Threshold value attribute No. (Note)
0	Corrected blocks	1
1	Uncorrected blocks	2
2	Code violations	3
3	Forward error corrections	4
NOTE – This number associates the TCA with the specified threshold value attribute of the threshold data 1 managed entity.		

9.7.25 TC adaptor performance monitoring history data xDSL

This ME collects PM data of an xTU-C to xTU-R ATM data path. Instances of this ME are created and deleted by the OLT.

For a complete discussion of generic PM architecture, refer to clause I.4.

Relationships

An instance of this ME is associated with an xDSL UNI.

Attributes

Managed entity ID: This attribute uniquely identifies each instance of this ME. Through an identical ID, this ME is implicitly linked to an instance of the PPTP xDSL UNI part 1. (R) (mandatory) (2 bytes)

Interval end time: This attribute identifies the most recently finished 15 min interval. (R) (mandatory) (1 byte)

Threshold data1/2 ID: This attribute points to an instance of the threshold data1 ME that contains PM threshold values. Since no threshold value attribute number exceeds 7, a threshold data 2 ME is optional. (R, W, set-by-create) (mandatory) (2 bytes)

Near-end HEC violation count: This attribute counts near-end HEC anomalies in the ATM data path. (R) (mandatory) (2 bytes)

Near-end delineated total cell count (CD-P): This attribute counts the total number of cells passed through the cell delineation and HEC function process operating on the ATM data path while in the SYNC state. (R) (mandatory) (4 bytes)

Near-end user total cell count(CU-P): This attribute counts the total number of cells in the ATM data path delivered at the V-C interface. (R) (mandatory) (4 bytes)

Near-end idle cell bit error count: This attribute counts cells with bit errors in the ATM data path idle payload received at the near end. (R) (mandatory) (2 bytes)

Far-end HEC violation count: This attribute counts far-end HEC anomalies in the ATM data path. (R) (mandatory) (2 bytes)

Far-end delineated total cell count (CD-PFE): This attribute counts the total number of cells passed through the cell delineation process and HEC function operating on the ATM data path while in the SYNC state. (R) (mandatory) (4 bytes)

Far-end user total cell count (CU-PFE): This attribute counts the total number of cells in the ATM data path delivered at the T-R interface. (R) (mandatory) (4 bytes)

Far-end idle cell bit error count: This attribute counts cells with bit errors in the ATM data path idle payload received at the far end. (R) (mandatory) (2 bytes)

Actions

Create, delete, get, set

Get current data (optional)

Notifications

Threshold crossing alert

Alarm number	Threshold crossing alert	Threshold value attribute No. (Note)
0	Near-end HEC violation	1
1	Near-end idle cell bit error count	2
2	Far-end HEC violation count	3
3	Far-end idle cell bit error count	4
4	Near-end delineated total cell count (CD-P)	5
5	Near-end user total cell count (CU-P)	6
6	Far-end delineated total cell count (CD-PFE)	7
7	Far-end user total cell count (CU-PFE)	8

NOTE – This number associates the TCA with the specified threshold value attribute of the threshold data 1 managed entity.

9.7.26 VDSL2 line configuration extensions 2

This ME extends the xDSL line configuration MEs. The ME name was chosen because its attributes were initially unique to ITU-T G.993.2 VDSL2. Due to continuing standards development, two of the attributes (FEXT and NEXT TXREFVNdS) are also used in [ITU-T G.992.3] and [ITU-T G.992.5]. This ME therefore pertains to the latter Recommendations as well as to [ITU-T G.993.2].

The attributes of this ME are further defined in [ITU-T G.997.1].

An instance of this ME is created and deleted by the OLT.

Relationships

An instance of this ME may be associated with zero or more instances of the PPTP xDSL UNI part 1.

The overall xDSL line configuration profile is modelled in several parts, all of which are associated together through a common ME ID. (The client PPTP xDSL UNI part 1 has a single pointer, which refers to the entire set of line configuration parts.)

Attributes

Managed entity ID: This attribute uniquely identifies each instance of this ME. All xDSL and VDSL2 line configuration profiles and extensions that pertain to a given PPTP xDSL must share a common ME ID. (R, set-by-create) (mandatory) (2 bytes)

SOS time downstream: The SOS-TIME-ds attribute is used in the specification of receiver initiated SOS (see clause 13.4.3 of [ITU-T G.993.2]). If the attribute value is not zero, the standard SOS triggering criteria are enabled, and the value specifies the duration of the window used in the standard SOS triggering criteria in the downstream direction. The special value zero indicates that the standard SOS triggering criteria are disabled, i.e., vendor-discretionary values may be used instead of the values configured in the MIB for the following parameters: SOS-NTONES-ds, SOS-CRC-ds, SOS-TIME-ds. The valid range of non-zero values is from 1..255, specifying 64 ms to 16320 ms in steps of 64 ms. (R, W, set-by-create) (optional) (1 byte)

SOS time upstream: The SOS-TIME-us attribute is used in the specification of receiver initiated SOS (see clause 13.4.3 of [ITU-T G.993.2]). If the attribute value is not zero, the standard SOS triggering criteria are enabled, and the value specifies the duration of the window used in the standard SOS triggering criteria in the upstream direction. The special value zero indicates that the standard SOS triggering criteria are disabled, i.e., vendor-discretionary values may be used instead of the values configured in the MIB for the following parameters: SOS-NTONES-us, SOS-CRC-us, SOS-TIME-us. The valid range of non-zero values is from 1..255, specifying 64 ms to 16320 ms in steps of 64 ms. (R, W, set-by-create) (optional) (1 byte)

SOS degraded tones threshold downstream: The SOS-NTONES-ds attribute is the minimum percentage of tones in the downstream medley set that must be degraded in order to arm the first sub-condition of the standard SOS triggering criteria in the downstream direction. The valid range of values is from 1 to 100% in steps of 1. Use of the special value 0 is described in clause 13.4.3.2 of [ITU-T G.993.2]. (R, W, set-by-create) (optional) (1 byte)

SOS degraded tones threshold upstream: The SOS-NTONES-us attribute is the minimum percentage of tones in the upstream medley set that must be degraded in order to arm the first sub-condition of the standard SOS triggering criteria in the upstream direction. The valid range of values is from 1 to 100% in steps of 1. Use of the special value 0 is described in clause 13.4.3.2 of [ITU-T G.993.2]. (R, W, set-by-create) (optional) (1 byte)

SOS CRC threshold downstream: The SOS-CRC-ds attribute is the minimum number of normalized CRC anomalies received in SOS-TIME-ds seconds in order to arm the second sub-condition of the standard SOS triggering criteria (see clause 13.4.3.2 of [ITU T G.993.2]) in the downstream direction. The valid range of SOS-CRC values is 0.02 to $(2^{16}-1)*0.02$, in steps of 0.02. The value 0 specifies that the ONU uses its internal default. (R, W, set-by-create) (optional) (2 bytes)

- SOS CRC threshold upstream:** The SOS-CRC-us attribute is the minimum number of normalized CRC anomalies received in SOS-TIME-us seconds in order to arm the second sub-condition of the standard SOS triggering criteria (see clause 13.4.3.2 of [ITU T G.993.2]) in the upstream direction. The valid range of SOS-CRC values is 0.02 to $(2^{16}-1)*0.02$, in steps of 0.02. The value 0 specifies that the ONU uses its internal default. (R, W, set-by-create) (optional) (2 bytes)
- MAX SOS downstream:** The MAX-SOS-ds attribute is used in deactivation. If the number of successful SOS procedures in the downstream direction performed within a 120 s interval exceeds MAX-SOS-ds, the modem goes to state L3. See clause 12.1.4 of [ITU-T G.993.2] for details. The valid range of values is 1 to 15, with the special value 0 as described in clause 12.1 of [ITU-T G.993.2]. (R, W, set-by-create) (optional) (1 byte)
- MAX SOS upstream:** The MAX-SOS-us attribute is used in deactivation. If the number of successful SOS procedures in the upstream direction performed within a 120 s interval exceeds MAX-SOS-us, the modem goes to state L3. See clause 12.1.4 of [ITU-T G.993.2] for details. The valid range of values is 1 to 15, with the special value 0 as described in clause 12.1 of [ITU-T G.993.2]. (R, W, set-by-create) (optional) (1 byte)
- SNR max offset downstream:** The SNRMOFFSET-ROC-ds attribute is the SNR margin offset for the ROC in the downstream direction. The attribute is used in the specification of the channel initialization policy (see clause 12.3.7.1 of [ITU-T G.993.2]). The valid range of SNR margin offset values is from 0..31 dB in 0.1 dB steps. (R, W, set-by-create) (optional) (2 bytes)
- SNR max offset upstream:** The SNRMOFFSET-ROC-us attribute is the SNR margin offset for the ROC in the upstream direction. The attribute is used in the specification of the channel initialization policy (see clause 12.3.7.1 of [ITU-T G.993.2]). The valid range of SNR margin offset values is from 0..31 dB in 0.1 dB steps. (R, W, set-by-create) (optional) (2 bytes)
- ROC minimum impulse noise protection downstream:** The INPMIN-ROC-ds attribute specifies the minimum INP to apply on the ROC in the downstream direction expressed in multiples of equivalent 4k DMT, xDSL (DMT) symbol length. The minimum INP is an integer ranging from 0 to 8. (R, W, set-by-create) (optional) (1 byte)
- ROC minimum impulse noise protection upstream:** The INPMIN-ROC-us attribute specifies the minimum impulse noise protection to apply on the ROC in the upstream direction expressed in multiples of equivalent 4k DMT symbol length. The minimum INP is an integer ranging from 0 to 8. (R, W, set-by-create) (optional) (1 byte)
- FEXT downstream transmitter referred virtual noise table:** The FEXT TXREFVNdS attribute is the downstream transmitter referred virtual noise specified for FEXT_R duration in Annex C of [ITU-T G.992.3] (ADSL2) and Annex C of [ITU-T G.992.5] (ADSL2plus). The syntax of this attribute is the same as that of the TXREFVNdS table attribute of the VDSL2 line configuration extensions ME. (R, W) (mandatory for Annex C of [ITU-T G.992.3] and Annex C of [ITU-T G.992.5]) (3 * N bytes, where N is the number of breakpoints)
- NEXT downstream transmitter referred virtual noise table:** The NEXT TXREFVNdS attribute is the downstream transmitter referred virtual noise specified for NEXT_R duration in Annex C of [ITU-T G.992.3] (ADSL2) and Annex C of [ITU-T G.992.5] (ADSL2plus). The syntax of this attribute is the same as that

of the TXREFVNdS table attribute of the VDSL2 line configuration extensions ME. (R, W) (mandatory for Annex C of [ITU-T G.992.3] and Annex C of [ITU-T G.992.5]) (3 * N bytes, where N is the number of breakpoints)

Actions

Create, delete, get, get next, set

Set table (optional)

Notifications

None.

9.7.27 xDSL impulse noise monitor performance monitoring history data

This ME collects PM data from the impulse noise monitor function at both near and far ends. Instances of this ME are created and deleted by the OLT. Note that, unlike most xDSL PM, [ITU-T G.997.1] only requires current and previous 15 min interval storage; a longer view of this PM is not expected at 15 min granularity.

For a complete discussion of generic PM architecture, refer to clause I.4.

Relationships

An instance of this ME may be associated with an xDSL UNI. This ME is meaningful only for ITU-T G.993.2 VDSL2, [ITU-T G.992.3] and [ITU-T G.992.5].

Attributes

Managed entity ID: This attribute uniquely identifies each instance of this ME. The ME ID is identical to that of this ME's parent PPTP xDSL UNI part 1. (R, set-by-create) (mandatory) (2 bytes)

Interval end time: This attribute identifies the most recently finished 15 min interval. (R) (mandatory) (1 byte)

Threshold data 1/2 ID: No thresholds are defined for this ME. For uniformity with other PM, the attribute is retained and shown as mandatory, but it should be set to a null pointer. (R, W, set-by-create) (mandatory) (2 bytes)

INM INPEQ histogram table: INMINPEQ1..17-L is a count of the near-end INMAINPEQi anomalies occurring on the line during the accumulation period. This parameter is subject to inhibiting – see clause 7.2.7.13 of [ITU-T G.997.1]. (R) (optional) (2 bytes * 17 entries = 34 bytes)

INM total measurement: INMME-L is a count of the near-end INMAME anomalies occurring on the line during the accumulation period. This parameter is subject to inhibiting – see clause 7.2.7.13 of [ITU-T G.997.1]. (R) (optional) (2 bytes)

INM IAT histogram: INMIAT0..7-L is a count of the near-end INMAIATi anomalies occurring on the line during the accumulation period. This parameter is subject to inhibiting – see clause 7.2.7.13 of [ITU-T G.997.1]. (R) (optional) (2 bytes * 8 entries = 16 bytes)

INM INPEQ histogram LFE table: INMINPEQ1..17-LFE is a count of the far-end INMAINPEQi anomalies occurring on the line during the accumulation period. This parameter is subject to inhibiting – see clause 7.2.7.13 of [ITU-T G.997.1]. (R) (optional) (2 bytes * 17 entries = 34 bytes)

INM total measurement LFE: INMME-LFE is a count of the far-end INMAME anomalies occurring on the line during the accumulation period. This parameter is subject to inhibiting – see clause 7.2.7.13 of [ITU-T G.997.1]. (R) (optional) (2 bytes)

INM IAT histogram LFE: INMIAT0..7-LFE is a count of the far-end INMAIAT_i anomalies occurring on the line during the accumulation period. This parameter is subject to inhibiting – see clause 7.2.7.13 of [ITU-T G.997.1]. (R) (optional) (2 bytes * 8 entries = 16 bytes)

Actions

Create, delete, get, get next, set

Get current data (optional)

Notifications

None.

9.7.28 xDSL line inventory and status data part 5

This ME extends the attributes defined in the xDSL line inventory and status data parts 1..4. This ME reports FEXT and NEXT attributes, and pertains to Annex C of [ITU-T G.992.3] (ADSL2) and Annex C of [ITU-T G.992.5] (ADSL2plus).

Relationships

This is one of the status data MEs associated with an xDSL UNI. The ONU automatically creates or deletes an instance of this ME upon creation or deletion of a PPTP xDSL UNI part 1 that supports these attributes.

Attributes

Managed entity ID: This attribute uniquely identifies each instance of this ME. Through an identical ID, this ME is implicitly linked to an instance of the PPTP xDSL UNI part 1 ME. (R) (mandatory) (2 bytes)

FEXT downstream SNR margin: The FEXT SNRM_{ds} attribute is the downstream SNR margin measured during FEXT_R duration at the ATU-R. The attribute value ranges from 0 (–64.0 dB) to 1270 (+63.0 dB). The special value 0xFFFF indicates that the attribute is out of range. (R) (mandatory) (2 bytes)

NEXT downstream SNR margin: The NEXT SNRM_{ds} attribute is the downstream SNR margin measured during NEXT_R duration at the ATU-R. The attribute value ranges from 0 (–64.0 dB) to 1270 (+63.0 dB). The special value 0xFFFF indicates that the attribute is out of range. (R) (mandatory) (2 bytes)

FEXT upstream SNR margin: The FEXT SNRM_{us} attribute is the upstream SNR margin (see clause 7.5.1.16 of [ITU-T G.997.1]) measured during FEXT_C duration at the ATU-C. The attribute value ranges from 0 (–64.0 dB) to 1270 (+63.0 dB). The special value 0xFFFF indicates that the attribute is out of range. (R) (mandatory) (2 bytes)

NEXT upstream SNR margin: The NEXT SNRM_{us} attribute is the upstream SNR margin (see clause 7.5.1.16 of [ITU-T G.997.1]) measured during NEXT_C duration at the ATU-C. The attribute value ranges from 0 (–64.0 dB) to 1270 (+63.0 dB). The special value 0xFFFF indicates that the attribute is out of range. (R) (mandatory) (2 bytes)

FEXT downstream maximum attainable data rate: The FEXT ATTNDR_{ds} attribute is the maximum downstream net data rate calculated from FEXT downstream

SNR(f) (see clause 7.5.1.28.3.1 of [ITU-T G.997.1]). The rate is coded in bits per second. (R) (mandatory) (4 bytes)

NEXT downstream maximum attainable data rate: The NEXT ATTNDRds attribute is the maximum downstream net data rate calculated from NEXT downstream SNR(f) (see clause 7.5.1.28.3.2 of [ITU-T G.997.1]). The rate is coded in bits per second. (R) (mandatory) (4 bytes)

FEXT upstream maximum attainable data rate: The FEXT ATTNDRus attribute is the maximum upstream net data rate calculated from FEXT upstream SNR(f) (see clause 7.5.1.28.6.1 of [ITU-T G.997.1]). The rate is coded in bits per second. (R) (mandatory) (4 bytes)

NEXT upstream maximum attainable data rate: The NEXT ATTNDRus attribute is the maximum upstream net data rate calculated from NEXT upstream SNR(f) (see clause 7.5.1.28.6.2 of [ITU-T G.997.1]). The rate is coded in bits per second. (R) (mandatory) (4 bytes)

FEXT downstream actual power spectral density: The FEXT ACTPSDds attribute is the average downstream transmit PSD over the used subcarriers (see clause 7.5.1.21.1 of [ITU-T G.997.1]) calculated from the REFPSDds and RMSGIds for FEXT_R duration. The attribute value ranges from 0 (−90.0 dBm/Hz) to 900 (0.0 dBm/Hz). The special value 0xFFFF indicates that the parameter is out of range. (R) (mandatory) (2 bytes)

NEXT downstream actual power spectral density: The NEXT ACTPSDds attribute is the average downstream transmit PSD over the used subcarriers (see clause 7.5.1.21.2 of [ITU-T G.997.1]) calculated from the REFPSDds and RMSGIds for NEXT_R duration. The attribute value ranges from 0 (−90.0 dBm/Hz) to 900 (0.0 dBm/Hz). The special value 0xFFFF indicates that the parameter is out of range. (R) (mandatory) (2 bytes)

FEXT upstream actual power spectral density: The FEXT ACTPSDus attribute is the average upstream transmit PSD over the used subcarriers (see clause 7.5.1.22.1 of [ITU-T G.997.1]) calculated from the REFPSDus and RMSGIus for FEXT_c duration. The attribute value ranges from 0 (−90.0 dBm/Hz) to 900 (0.0 dBm/Hz). The special value 0xFFFF indicates that the parameter is out of range. (R) (mandatory) (2 bytes)

NEXT upstream actual power spectral density: The NEXT ACTPSDus attribute is the average upstream transmit PSD over the used subcarriers (see clause 7.5.1.22.2 of [ITU-T G.997.1]) calculated from the REFPSDus and RMSGIus for NEXT_c duration. The attribute value ranges from 0 (−90.0 dBm/Hz) to 900 (0.0 dBm/Hz). The special value 0xFFFF indicates that the parameter is out of range. (R) (mandatory) (2 bytes)

FEXT downstream actual aggregate transmit power: The FEXT ACTATPds attribute is the total amount of transmit power (see clause 7.5.1.24.1 of [ITU-T G.997.1]) calculated from PSDds measured during FEXT_R duration at the ATU-R. The attribute value ranges from 0 (−31.0 dBm) to 620 (+31.0 dBm). The special value 0xFFFF indicates that the parameter is out of range. (R) (mandatory) (2 bytes)

NEXT downstream actual aggregate transmit power: The NEXT ACTATPds attribute is the total amount of transmit power (see clause 7.5.1.24.2 of [ITU-T G.997.1]) calculated from PSDds measured during NEXT_R duration at the ATU-R. The attribute value ranges from 0 (−31.0 dBm) to 620 (+31.0 dBm). The special

value 0xFFFF indicates that the parameter is out of range. (R) (mandatory) (2 bytes)

FEXT upstream actual aggregate transmit power: The FEXT ACTATP_{us} attribute is the total transmit power (see clause 7.5.1.25.1 of [ITU-T G.997.1]) calculated from PSD_{us} measured during FEXT_C duration at the ATU-C. The attribute value ranges from 0 (–31.0 dBm) to 620 (+31.0 dBm). The special value 0xFFFF indicates that the parameter is out of range. (R) (mandatory) (2 bytes)

NEXT upstream actual aggregate transmit power: The NEXT ACTATP_{us} attribute is the total transmit power (see clause 7.5.1.25.2 of [ITU-T G.997.1]) calculated from PSD_{us} measured during NEXT_C duration at the ATU-C. The attribute value ranges from 0 (–31.0 dBm) to 620 (+31.0 dBm). The special value 0xFFFF indicates that the parameter is out of range. (R) (mandatory) (2 bytes)

Actions

Get, get next

Notifications

None.

9.7.29 xDSL line inventory and status data part 6

This ME extends the attributes defined in the xDSL line inventory and status data parts 1..4. This ME reports FEXT and NEXT attributes, and pertains to Annex C of [ITU-T G.992.3] (ADSL2) and Annex C of [ITU-T G.992.5] (ADSL2plus).

Relationships

This is one of the status data MEs associated with an xDSL UNI. The ONU automatically creates or deletes an instance of this ME upon creation or deletion of a PPTP xDSL UNI part 1 that supports these attributes.

Attributes

Managed entity ID: This attribute uniquely identifies each instance of this ME. Through an identical ID, this ME is implicitly linked to an instance of the PPTP xDSL UNI part 1 ME. (R) (mandatory) (2 bytes)

FEXT downstream quiet line noise PSD measurement time: The FEXT QLNMT_d attribute is the number of symbols used to measure FEXT downstream QLN(*f*) (see clause 7.5.1.27.3.1 of [ITU-T G.997.1]). (R) (mandatory) (2 bytes)

NEXT downstream quiet line noise PSD measurement time: The NEXT QLNMT_d attribute is the number of symbols used to measure NEXT downstream QLN(*f*) (see clause 7.5.1.27.3.2 of [ITU-T G.997.1]). (R) (mandatory) (2 bytes)

FEXT downstream QLN(*f*) table: The FEXT QLN_{psds} attribute is the downstream QLN(*f*) (see clause 7.5.1.27.3.1 of [ITU-T G.997.1]) measured during FEXT_R duration at the ATU-R. The attribute syntax is the same as that of the downstream QLN_{psds} table attribute of the xDSL line inventory and status data part 3 ME. (R) (mandatory) (*N* bytes, where *N* is the number of subcarrier groups)

NEXT downstream QLN(*f*) table: The NEXT QLN_{psds} attribute is the downstream QLN(*f*) (see clause 7.5.1.27.3.2 of [ITU-T G.997.1]) measured during NEXT_R duration at the ATU-R. The attribute syntax is the same as that of the downstream QLN_{psds} table attribute of the xDSL line inventory and status data part 3 ME. (R) (mandatory) (*N* bytes, where *N* is the number of subcarrier groups)

- FEXT upstream quiet line noise PSD measurement time:** The FEXT QLNMT_{us} attribute is the number of symbols used to measure FEXT upstream QLN(*f*) (see clause 7.5.1.27.6.1 of [ITU-T G.997.1]). (R) (mandatory) (2 bytes)
- NEXT upstream quiet line noise PSD measurement time:** The NEXT QLNMT_{us} attribute is the number of symbols used to measure NEXT upstream QLN(*f*) (see clause 7.5.1.27.6.2 of [ITU-T G.997.1]). (R) (mandatory) (2 bytes)
- FEXT upstream QLN(*f*) table:** The FEXT QLN_{psus} attribute is the upstream QLN(*f*) (see clause 7.5.1.27.6.1 of [ITU-T G.997.1]) measured during FEXT_c duration at the ATU-C. The attribute syntax is the same as that of the downstream QLN_{psds} table attribute of the xDSL line inventory and status data part 3 ME. (R) (mandatory) (*N* bytes, where *N* is the number of subcarrier groups)
- NEXT upstream QLN(*f*) table:** The NEXT QLN_{psus} attribute is the upstream QLN(*f*) (see clause 7.5.1.27.6.2 of [ITU-T G.997.1]) measured during NEXT_c duration at the ATU-C. The attribute syntax is the same as that of the downstream QLN_{psds} table attribute of the xDSL line inventory and status data part 3 ME. (R) (mandatory) (*N* bytes, where *N* is the number of subcarrier groups)
- FEXT downstream SNR measurement time:** The FEXT SNRMT_{ds} attribute is the number of symbols used to measure FEXT downstream SNR(*f*) values (see clause 7.5.1.28.1.1 of [ITU-T G.997.1]). Its value corresponds to the value specified in the corresponding Recommendation (e.g., the number of symbols in a 1 s interval for [ITU-T G.992.3]). (R) (mandatory) (2 bytes)
- NEXT downstream SNR measurement time:** The NEXT SNRMT_{ds} attribute is the number of symbols used to measure NEXT downstream SNR(*f*) values (see clause 7.5.1.28.1.2 of [ITU-T G.997.1]). Its value corresponds to the value specified in the corresponding Recommendation (e.g., the number of symbols in a 1 s interval for [ITU-T G.992.3]). (R) (mandatory) (2 bytes)
- FEXT downstream SNR(*f*) table:** The FEXT SNR_{psds} attribute is the downstream SNR(*f*) (see clause 7.5.1.28.3.1 of [ITU-T G.997.1]) measured during FEXT_R duration at the ATU-R. The attribute is represented in the same way as the SNR_{psds} table attribute of the xDSL line inventory and status data part 3 ME. (R) (mandatory) (*N* bytes, where *N* is the number of subcarrier groups)
- NEXT downstream SNR(*f*) table:** The NEXT SNR_{psds} attribute is the downstream SNR(*f*) (see clause 7.5.1.28.3.2 of [ITU-T G.997.1]) measured during NEXT_R duration at the ATU-R. The attribute is represented in the same way as the SNR_{psds} table attribute of the xDSL line inventory and status data part 3 ME. (R) (mandatory) (*N* bytes, where *N* is the number of subcarrier groups)
- FEXT upstream SNR measurement time:** The FEXT SNRMT_{us} attribute is the number of symbols used to measure FEXT upstream SNR(*f*) values (see clause 7.5.1.28.4.1 of [ITU-T G.997.1]). Its value corresponds to the value specified in the corresponding Recommendation (e.g., the number of symbols in a 1 s interval for [ITU-T G.992.3]). (R) (mandatory) (2 bytes)
- NEXT upstream SNR measurement time:** The NEXT SNRMT_{us} attribute is the number of symbols used to measure NEXT upstream SNR(*f*) values (see clause 7.5.1.28.4.2 of [ITU-T G.997.1]). Its value corresponds to the value specified in the corresponding Recommendation (e.g., the number of symbols in a 1 s interval for [ITU-T G.992.3]). (R) (mandatory) (2 bytes)
- FEXT upstream SNR(*f*) table:** The FEXT SNR_{psus} attribute is the upstream SNR(*f*) (see clause 7.5.1.28.6.1 of [ITU-T G.997.1]) measured during FEXT_c duration at

the ATU-C. The attribute is represented in the same way as the SNRpsds table attribute of the xDSL line inventory and status data part 3 ME. (R) (mandatory) (N bytes, where N is the number of subcarrier groups)

NEXT upstream SNR(f) table: The NEXT SNRpsus attribute is the upstream SNR(f) (see clause 7.5.1.28.6.2 of [ITU-T G.997.1]) measured during NEXT_C duration at the ATU-C. The attribute is represented in the same way as the SNRpsds table attribute of the xDSL line inventory and status data part 3 ME. (R) (mandatory) (N bytes, where N is the number of subcarrier groups)

Actions

Get, get next

Notifications

None.

9.7.30 xDSL line inventory and status data part 7

This ME extends the attributes defined in the xDSL line inventory and status data parts 1..4. This ME reports FEXT and NEXT attributes, and pertains to Annex C of [ITU-T G.992.3] (ADSL2) and Annex C of [ITU-T G.992.5] (ADSL2plus).

Relationships

This is one of the status data MEs associated with an xDSL UNI. The ONU automatically creates or deletes an instance of this ME upon creation or deletion of a PPTP xDSL UNI part 1 that supports these attributes.

Attributes

Managed entity ID: This attribute uniquely identifies each instance of this ME. Through an identical ID, this ME is implicitly linked to an instance of the PPTP xDSL UNI part 1 ME. (R) (mandatory) (2 bytes)

FEXT downstream bits allocation table: The FEXT BITSpsds attribute is the downstream bits allocation table per subcarrier (see clause 7.5.1.29.1.1 of [ITU-T G.997.1]) used during FEXT_R duration. The syntax of this attribute is the same as that of the BITSpsds table attribute of the xDSL line inventory and status data part 3 ME. (R) (mandatory) (N bytes, where N is the number of subcarriers)

NEXT downstream bits allocation table: The NEXT BITSpsds attribute is the downstream bits allocation table per subcarrier (see clause 7.5.1.29.1.2 of [ITU-T G.997.1]) used during NEXT_R duration. The syntax of this attribute is the same as that of the BITSpsds table attribute of the xDSL line inventory and status data part 3 ME. (R) (mandatory) (N bytes, where N is the number of subcarriers)

FEXT upstream bits allocation table: The FEXT BITSpsus attribute is the upstream bits allocation table per subcarrier (see clause 7.5.1.29.2.1 of [ITU-T G.997.1]) used during FEXT_C duration. The syntax of this attribute is the same as that of the BITSpsds table attribute of the xDSL line inventory and status data part 3 ME. (R) (mandatory) (N bytes, where N is the number of subcarriers)

NEXT upstream bits allocation table: The NEXT BITSpsus attribute is the upstream bits allocation table per subcarrier (see clause 7.5.1.29.2.2 of [ITU-T G.997.1]) used during NEXT_C duration. The syntax of this attribute is the same as that of the BITSpsds table attribute of the xDSL line inventory and status data part 3 ME. (R) (mandatory) (N bytes, where N is the number of subcarriers)

- FEXT downstream gains allocation table:** The FEXT GAINSpds attribute is the downstream gains allocation table per subcarrier (see clause 7.5.1.29.3.1 of [ITU-T G.997.1]) used during FEXT_R duration. The syntax of this attribute is the same as that of the GAINSpds table attribute of the xDSL line inventory and status data part 3 ME. (R) (mandatory) (2*N* bytes, where *N* is the number of subcarriers)
- NEXT downstream gains allocation table:** The NEXT GAINSpds attribute is the downstream gains allocation table per subcarrier (see clause 7.5.1.29.3.2 of [ITU-T G.997.1]) used during NEXT_R duration. The syntax of this attribute is the same as that of the GAINSpds table attribute of the xDSL line inventory and status data part 3 ME. (R) (mandatory) (2*N* bytes, where *N* is the number of subcarriers)
- FEXT upstream gains allocation table:** The FEXT GAINSpus attribute is the upstream gains allocation table per subcarrier (see clause 7.5.1.29.4.1 of [ITU-T G.997.1]) used during FEXT_C duration. The syntax of this attribute is the same as that of the GAINSpds table attribute of the xDSL line inventory and status data part 3 ME. (R) (mandatory) (2*N* bytes, where *N* is the number of subcarriers)
- NEXT upstream gains allocation table:** The NEXT GAINSpus attribute is the upstream gains allocation table per subcarrier (see clause 7.5.1.29.4.2 of [ITU-T G.997.1]) used during NEXT_C duration. The syntax of this attribute is the same as that of the GAINSpds table attribute of the xDSL line inventory and status data part 3 ME. (R) (mandatory) (2*N* bytes, where *N* is the number of subcarriers)
- FEXT downstream transmit spectrum shaping table:** The FEXT TSSpds attribute is the downstream transmit spectrum shaping parameter set per subcarrier (see clause 7.5.1.29.5.1 of [ITU-T G.997.1]) used during FEXT_R duration. The syntax of this attribute is the same as that of the TSSpds table attribute of the xDSL line inventory and status data part 3 ME. (R) (mandatory) (3*N* bytes, where *N* is the number of breakpoints)
- NEXT downstream transmit spectrum shaping table:** The NEXT TSSpds attribute is the downstream transmit spectrum shaping parameter set per subcarrier (see clause 7.5.1.29.5.2 of [ITU-T G.997.1]) used during NEXT_R duration. The syntax of this attribute is the same as that of the TSSpds table attribute of the xDSL line inventory and status data part 3 ME. (R) (mandatory) (3*N* bytes, where *N* is the number of breakpoints)
- FEXT upstream transmit spectrum shaping table:** The FEXT TSSpus attribute is the upstream transmit spectrum shaping parameter set per subcarrier (see clause 7.5.1.29.6.1 of [ITU-T G.997.1]) used during FEXT_C duration. The syntax of this attribute is the same as that of the TSSpus table attribute of the xDSL line inventory and status data part 4 ME. (R) (mandatory) (3*N* bytes, where *N* is the number of breakpoints)

NEXT upstream transmit spectrum shaping table: The NEXT TSSpsus attribute is the upstream transmit spectrum shaping parameter set per subcarrier (see clause 7.5.1.29.6.2 of [ITU-T G.997.1]) used during NEXT_C duration. The syntax of this attribute is the same as that of the TSSpsus table attribute of the xDSL line inventory and status data part 4 ME. (R) (mandatory) (3*N* bytes, where *N* is the number of breakpoints)

Actions

Get, get next

Notifications

None.

9.7.31 xDSL xTU-C performance monitoring history data part 2

This ME collects PM data on the xTU-C to xTU-R path as seen from the xTU-C. Instances of this ME are created and deleted by the OLT.

For a complete discussion of generic PM architecture, refer to clause I.4.

Relationships

An instance of this ME is associated with an xDSL UNI.

Attributes

Managed entity ID: This attribute uniquely identifies each instance of this ME. Through an identical ID, this ME is implicitly linked to an instance of the PPTP xDSL UNI part 1. (R, set-by-create) (mandatory) (2 bytes)

Interval end time: This attribute identifies the most recently finished 15 min interval. (R) (mandatory) (1 byte)

Threshold data 1/2 ID: This attribute points to an instance of the threshold data 1 and 2 MEs that contain PM threshold values. (R, W, set-by-create) (mandatory) (2 bytes)

"lefr" defect seconds: If retransmission is used, this attribute is a count of the seconds with a near-end "lefr" defect present – see clause 7.2.1.1.6 of [ITU-T G.997.1]. (R) (mandatory) (2 bytes)

Error-free bits counter: If retransmission is used, this attribute is a count of the number of error-free bits passed over the β_1 reference point, divided by 2^{16} – see clause 7.2.1.1.7 of [ITU-T G.997.1]. (R) (mandatory) (4 bytes)

Minimum error-free throughput (MINEFTR): If retransmission is used, this attribute is the minimum error-free throughput in bits per second – see clause 7.2.1.1.8 of [ITU-T G.997.1]. (R) (mandatory) (4 bytes)

Actions

Create, delete, get, set

Get current data (optional)

Notifications

Threshold crossing alert

Alarm number	Threshold crossing alert	Threshold value attribute No. (Note)
0	"lefr" defect seconds	1
NOTE – This number associates the TCA with the specified threshold value attribute of the threshold data 1/2 managed entities.		

9.7.32 PTM performance monitoring history data xDSL

This ME collects PM data of an xTU-C to xTU-R PTM data path. Instances of this ME are created and deleted by the OLT.

For a complete discussion of generic PM architecture, refer to clause I.4.

Relationships

An instance of this ME is associated with an xDSL UNI.

Attributes

Managed entity ID: This attribute uniquely identifies each instance of this ME. The two MSBs of the first byte are the bearer channel ID. Excluding the first 2 bits of the first byte, the remaining part of the ME ID is identical to that of this ME's parent PPTP xDSL UNI part 1. (R) (mandatory) (2 bytes)

Interval end time: This attribute identifies the most recently finished 15 min interval. (R) (mandatory) (1 byte)

Threshold data 1/2 ID: This attribute points to an instance of the threshold data1 ME that contains PM threshold values. Since no threshold value attribute number exceeds 7, a threshold data 2 ME is optional. (R, W, set-by-create) (mandatory) (2 bytes)

Near-end CRC-P counter: This attribute is a count of the number of occurrences of a CRC-n anomaly in the PTM data path at the near-end – see clause 7.2.5.1.1 of [ITU-T G.997.1] and clause N.4 of [ITU-T G.992.3]. (R) (mandatory) (2 bytes)

Near-end CRCP-P counter: This attribute is a count of the number of occurrences of a CRC-np anomaly in the PTM data path at the near-end – see clause 7.2.5.1.1 of [ITU-T G.997.1] and clause N.4 of [ITU-T G.992.3]. (R) (mandatory) (2 bytes)

Near-end CV-P counter: This attribute is a count of the number of occurrences of a CV-n anomaly in the PTM data path at the near-end – see clause 7.2.5.1.2 of [ITU-T G.997.1] and clause N.4 of [ITU-T G.992.3]. ® (mandatory) (4 bytes)

Near-end CVP-P counter: This attribute is a count of the number of occurrences of a CV-np anomaly in the PTM data path at the near-end – see clause 7.2.5.1.2 of [ITU-T G.997.1] and clause N.4 of [ITU-T G.992.3]. (R) (mandatory) (4 bytes)

Far-end CRC-PFE counter: This attribute is a count of the number of occurrences of a CRC-n anomaly in the PTM data path at the far-end – see clause 7.2.5.2.1 of [ITU-T G.997.1] and clause N.4 of [ITU-T G.992.3]. (R) (mandatory) (2 bytes)

Far-end CRCP-PFE counter: This attribute is a count of the number of occurrences of a CRC-np anomaly in the PTM data path at the far-end – see clause 7.2.5.2.1 of [ITU-T G.997.1] and clause N.4 of [ITU-T G.992.3]. (R) (mandatory) (2 bytes)

Far-end CV-PFE counter: This attribute is a count of the number of occurrences of a CV-n anomaly in the PTM data path at the far-end – see clause 7.2.5.2.2 of [ITU-T G.997.1] and clause N.4 of [ITU-T G.992.3]. (R) (mandatory) (4 bytes)

Far-end CVP-PFE counter: This attribute is a count of the number of occurrences of a CV-np anomaly in the PTM data path at the far-end – see clause 7.2.5.2.2 of [ITU-T G.997.1] and clause N.4 of [ITU-T G.992.3]. (R) (mandatory) (4 bytes)

Actions

Create, delete, get, set

Get current data (optional)

Notifications

Threshold crossing alert

Alarm number	Threshold crossing alert	Threshold value attribute No. (Note)
0	Near-end CRC-P counter	1
1	Near-end CRCP-P counter	2
2	Near-end CV-P counter	3
3	Near-end CVP-P counter	4
4	Far-end CRC-PFE counter	5
5	Far-end CRCP-PFE counter	6
6	Far-end CV-PFE counter	7
7	Far-end CVP-PFE counter	8
NOTE – This number associates the TCA with the specified threshold value attribute of the threshold data 1 managed entity.		

9.7.33 VDSL2 line configuration extensions 3

This ME extends the xDSL line configuration MEs.

An instance of this ME is created and deleted by the OLT.

Relationships

An instance of this ME may be associated with zero or more instances of an xDSL UNI.

The overall xDSL line configuration profile is modelled in several parts, all of which are associated together through a common ME ID (the client PPTP xDSL UNI part 1 has a single pointer, which refers to the entire set of line configuration parts).

Attributes

- Managed entity ID:** This attribute uniquely identifies each instance of this ME. All xDSL and VDSL2 line configuration profiles and extensions that pertain to a given PPTP xDSL UNI must share a common ME ID. (R, set-by-create) (mandatory) (2 bytes)
- RIPOLICYds:** This attribute indicates which policy shall be applied to determine the triggers for re-initialization in the downstream direction. A valid range of values is given in clause 7.3.1.1.12.1 of [ITU-T G.997.1]. (R, W) (optional) (1 byte)
- RIPOLICYus:** This attribute indicates which policy shall be applied to determine the triggers for re-initialization in the upstream direction. A valid range of values is given in clause 7.3.1.1.12.2 of [ITU-T G.997.1]. (R, W) (optional) (1 byte)
- REINIT_TIME_THRESHOLDds:** This attribute indicates defines the downstream threshold for re-initialization based on SES, to be used by the VTU receiver when re-initialization policy 1 is used in downstream. A valid range of values is given in clause 7.3.1.1.13.1 of [ITU-T G.997.1]. (R, W) (optional) (1 byte)
- REINIT_TIME_THRESHOLDus:** This attribute indicates defines the upstream threshold for re-initialization based on SES, to be used by the VTU receiver when re-initialization policy 1 is used in upstream. A valid range of values is given in clause 7.3.1.1.13.2 of [ITU-T G.997.1]. (R, W) (optional) (1 byte)
- RXREFVNSFus:** If SNRM_MODE = 4, this attribute defines the upstream receiver-referred virtual noise scaling factor. The attribute value ranges from 0 (-64.0 dBm) to 255 (+63.5 dBm) – see clause 7.3.1.7.5 of [ITU-T G.997.1]. (R, W) (optional) (1 byte)
- TXREFVNSFds:** If SNRM_MODE = 4, this attribute defines the downstream transmitter referred virtual noise scaling factor. The attribute value ranges from 0 (-64.0 dBm) to 255 (+63.5 dBm) – see clause 7.3.1.7.6 of [ITU-T G.997.1]. (R, W) (optional) (1 byte)
- RTX_MODEds:** This attribute controls the mode of operation of [ITU-T G.998.4] retransmission in the downstream direction. A valid range of values is given in clause 7.3.1.11 of [ITU-T G.997.1]. (R, W) (mandatory) (1 byte)
- RTX_MODEus:** This attribute controls the mode of operation of [ITU-T G.998.4] retransmission in the upstream direction. A valid range of values is given in clause 7.3.1.11 of [ITU-T G.997.1]. (R, W) (mandatory) (1 byte)
- LEFTR_THRESH:** If retransmission is used in a given transmit direction, LEFTR_THRESH specifies the threshold for declaring a near-end "lefr" defect. LEFTR_THRESH is equal to the integer value of this attribute multiplied by 0.01. Valid values and usage are given in clause 7.3.1.12 of [ITU-T G.997.1]. (R, W) (mandatory) (1 byte)
- MAXDELAYOCTET-split parameter (MDOSPLIT):** This attribute defines the percentage of the MAXDELAYOCTET_ext if operating in [ITU-T G.998.4] or MAXDELAYOCTET in other cases allocated to the downstream direction. MDOSPLIT is equal to the integer value of this attribute multiplied by 1%. Valid values and usage are given in clause 7.3.1.14 of [ITU-T G.997.1]. (R, W) (optional) (1 byte)
- ATTNDR Method (ATTNDR_METHOD):** This attribute specifies the method to be used for the calculation of the ATNDR in the downstream and upstream direction.

Valid values are given in clause 7.3.1.15.1 of [ITU-T G.997.1]. (R, W) (optional) (1 byte)

ATTNDR MAXDELAYOCTET-split parameter (ATTNDR_MDOSPLIT): This attribute defines the percentage of the MAXDELAYOCTET_ext if operating in [ITU-T G.998.4] or MAXDELAYOCTET in other cases allocated to the downstream direction to be used in the improved method for calculation of the ATTNDR. The valid values are identical to the values of the line configuration parameter MDOSPLIT. See clause 7.3.1.15.2 of [ITU-T G.997.1]. (R, W) (optional) (1 byte)

Actions

Create, delete, get, set

Notifications

None.

9.7.34 Vectoring line configuration extensions

This ME extends the xDSL line configuration MEs with attributes that are specific to vectoring. An instance of this ME is created and deleted by the OLT.

Relationships

An instance of this ME may be associated with zero or more instances of an xDSL UNI.

The overall xDSL line configuration profile is modelled in several parts, all of which are associated together through a common ME ID (the client PPTP xDSL UNI part 1 has a single pointer, which refers to the entire set of line configuration parts).

Attributes

Managed entity ID: This attribute uniquely identifies each instance of this ME. All xDSL and VDSL2 and vectoring line configuration profiles and extensions that pertain to a given PPTP xDSL UNI must share a common ME ID. (R, set-by-create) (mandatory) (2 bytes)

Vectoring frequency-band control upstream (VECTOR_BAND_CONTROLus) table: This configuration parameter is an array of pairs of sub-carrier indices [$a(i)$, $b(i)$]. Up to eight frequency bands may be configured. The same value of this parameter shall be set for all lines of the same vector group. See clause 7.3.1.13.1 of [ITU-T G.997.1].

This attribute is a table where each entry comprises:

- band number field, i (1 byte, range 1-8);
- band start subcarrier index, $a(i)$ (2 bytes);
- band stop subcarrier index, $b(i)$ (2 bytes).

The band number field is the table index. By default, the table is empty. Setting a table entry with non-zero subcarrier indices implies insertion into the table. Setting an entry's subcarrier indices to zero implies deletion from the table, if present.

The maximum number of bands is eight, so the maximum size of the table is 40 bytes. (R, W) (mandatory) ($N \times 5$ bytes)

Vectoring frequency-band control downstream (VECTOR_BAND_CONTROLSd) table: This configuration parameter is an array of pairs of sub-carrier indices [$a(i)$, $b(i)$]. Up to eight frequency bands may be configured. The same value of

this parameter shall be set for all lines of the same vector group. See clause 7.3.1.13.2 of [ITU-T G.997.1]. The format of this attribute is the same as VECTOR_BAND_CONTROLus. The maximum number of bands is eight, so the maximum size of the table is 40 bytes. (R, W) (mandatory) ($N \times 5$ bytes)

FEXT cancellation line priorities upstream (FEXT_CANCEL_PRIORITYus): This attribute specifies line priority for the line in the vectored group in the upstream direction. Allowed values are 0 (LOW) and 1 (HIGH). See clause 7.3.1.13.3 of [ITU-T G.997.1]. (R, W) (optional) (1 byte)

FEXT cancellation line priorities downstream (FEXT_CANCEL_PRIORITYds): This attribute specifies line priority for the line in the vectored group in the downstream direction. Allowed values are 0 (LOW) and 1 (HIGH). See clause 7.3.1.13.4 of [ITU-T G.997.1]. (R, W) (optional) (1 byte)

FEXT cancellation enabling/disabling upstream (FEXT_CANCEL_ENABLEus): A value of 1 enables and a value of 0 disables FEXT cancellation in the upstream direction from all the other vectored lines into the line in the vectored group. See clause 7.3.1.13.5 of [ITU-T G.997.1]. (R, W) (mandatory) (1 byte)

FEXT cancellation enabling/disabling downstream (FEXT_CANCEL_ENABLEds): A value of 1 enables and a value of 0 disables FEXT cancellation in the downstream direction from all the other vectored lines into the line in the vectored group. See clause 7.3.1.13.6 of [ITU-T G.997.1]. (R, W) (mandatory) (1 byte)

Downstream requested XLIN subcarrier group size (XLINGREQds): This attribute is the requested value of XLINGds. Valid values are given in clause 7.3.1.13.7 of [ITU-T G.997.1]. (R, W) (mandatory) (1 byte)

Upstream requested XLIN subcarrier group size (XLINGREQus): This attribute is the requested value of XLINGus. Valid values are given in clause 7.3.1.13.8 of [ITU-T G.997.1]. (R, W) (mandatory) (1 byte)

Vectoring mode enable (VECTORMODE_ENABLE): This attribute defines the vectoring initialization type to be allowed by the VTU-O on the line. It is coded in a bit-map representation as defined in clause 7.3.1.13.9 of [ITU-T G.997.1]. (R, W) (optional) (1 byte)

VCE ID (VCE_ID): For the line in a vectored group, the VCE ID uniquely identifies the VCE that manages and controls the vectored group to which the line belongs. The valid range of values is given in clause 7.4.13.1 of [ITU-T G.997.1]. (R) (mandatory) (1 byte)

VCE port index (VCE_port_index): For the line in a vectored group, the VCE port index is the physical index that uniquely identifies the VCE port to which the line is connected. The valid range of values is given in clause 7.4.13.2 of [ITU-T G.997.1]. (R) (mandatory) (2 bytes)

Actions

Create, delete, get, get next, set

Set table (optional)

Notifications

None.

9.7.35 xDSL channel configuration profile part 2

This ME contains the channel configuration profile for an xDSL UNI. An instance of this ME is created and deleted by the OLT.

NOTE – If [ITU-T G.997.1] compatibility is required, bit rates should only be set to integer multiples of 1000 bits/s. The ONU may reject attempts to set other values for bit rate attributes.

Relationships

An instance of this ME may be associated with zero or more instances of the PPTP xDSL UNI part 1.

Attributes

Managed entity ID: This attribute uniquely identifies each instance of this ME. Through an identical ID, this ME is implicitly linked to an instance of the xDSL channel configuration profile. (R, set-by-create) (mandatory) (2 bytes)

Minimum expected throughput for retransmission (MINETR_RTX): If retransmission is used in a given transmit direction, this attribute specifies the minimum expected throughput for the bearer channel, in bits per second. See clause 7.3.2.1.8 of [ITU-T G.997.1]. (R, W) (mandatory) (4 bytes)

Maximum expected throughput for retransmission (MAXETR_RTX): If retransmission is used in a given transmit direction, this parameter specifies the maximum expected throughput for the bearer channel, in bits per second. See clause 7.3.2.1.9 of [ITU-T G.997.1]. (R, W) (mandatory) (4 bytes)

Maximum net data rate for retransmission (MAXNDR_RTX): If retransmission is used in a given transmit direction, this parameter specifies the maximum net data rate for the bearer channel, in bits per second. See clause 7.3.2.1.10 of [ITU-T G.997.1]. (R, W) (mandatory) (4 bytes)

Maximum delay for retransmission (DELAYMAX_RTX): If retransmission is used in a given transmit direction, this parameter specifies the maximum for the instantaneous delay due to the effect of retransmission only. This delay is defined as the integer value of this attribute multiplied by 1 ms. The valid delay values are given in clause 7.3.2.11 of [ITU-T G.997.1]. (R, W) (mandatory) (1 bytes)

Minimum delay for retransmission (DELAYMIN_RTX): If retransmission is used in a given transmit direction, this parameter specifies the minimum for the instantaneous delay due to the effect of retransmission only. This delay is defined as the integer value of this attribute multiplied by 1 ms. The valid delay values are given in clause 7.3.2.12 of [ITU-T G.997.1]. (R, W) (mandatory) (1 bytes)

Minimum impulse noise protection against single high impulse noise event (SHINE) for retransmission (INPMIN_SHINE_RTX): If retransmission is used in a given transmit direction, this parameter specifies the minimum INP against a SHINE for the bearer channel if it is transported over DMT symbols with a subcarrier spacing of 4.3125 kHz. The valid range of values is given in clause 7.3.2.13 of [ITU-T G.997.1]. (R, W) (mandatory) (1 bytes)

Minimum impulse noise protection against SHINE for retransmission for systems using 8.625 kHz subcarrier spacing (INPMIN8_SHINE_RTX): If retransmission is used in a given transmit direction, this parameter specifies the minimum INP against SHINE for the bearer channel if it is transported over DMT symbols

with a subcarrier spacing of 8.625 kHz. The valid range of values is given in clause 7.3.2.14 of [ITU-T G.997.1]. (R, W) (mandatory) (1 bytes)

SHINERATIO_RTX: If retransmission is used in a given transmit direction, this parameter specifies the SHINE ratio. This ratio is defined as the integer value of this attribute multiplied by 0.001. The valid range of values is given in clause 7.3.2.15 of [ITU-T G.997.1]. (R, W) (mandatory) (1 bytes)

Minimum impulse noise protection against REIN for retransmission (INPMIN_REIN_RTX): If retransmission is used in a given transmit direction, this parameter specifies the minimum INP against REIN for the bearer channel if it is transported over DMT symbols with a subcarrier spacing of 4.3125 kHz. The valid range of values is given in clause 7.3.2.16 of [ITU-T G.997.1]. (R, W) (mandatory) (1 bytes)

Minimum impulse noise protection against REIN for retransmission for systems using 8.625 kHz subcarrier spacing (INPMIN8_REIN_RTX): If retransmission is used in a given transmit direction, this parameter specifies the minimum INP against REIN for the bearer channel if it is transported over DMT symbols with a subcarrier spacing of 8.625 kHz. The valid range of values is given in clause 7.3.2.17 of [ITU-T G.997.1]. (R, W) (mandatory) (1 bytes)

REIN inter-arrival time for retransmission (IAT_REIN_RTX): If retransmission is used in a given transmit direction, this parameter specifies the IAT that shall be assumed for REIN protection. The valid range of values is given in clause 7.3.2.18 of [ITU-T G.997.1]. (R, W) (mandatory) (1 bytes)

Target net data rate (TARGET_NDR): If retransmission is not used in a given transmit direction, this parameter specifies the target net data of the bearer channel, in bits per second. See clause 7.3.2.19.1 of [ITU-T G.997.1]. (R, W) (mandatory) (4 bytes)

Target expected throughput for retransmission (TARGET_ETR): If retransmission is used in a given transmit direction, this parameter specifies the target expected throughput for the bearer channel, in bits per second. See clause 7.3.2.19.2 of [ITU-T G.997.1]. (R, W) (mandatory) (4 bytes)

Actions

Create, delete, get, set

Notifications

None.

9.7.36 xTU data gathering configuration

This ME defines configurations specific to data gathering.

An instance of this ME is created and deleted by the OLT.

Relationships

An instance of this ME may be associated with zero or more instances of the PPTP xDSL UNI part 1.

Attributes

Managed entity ID: This attribute uniquely identifies each instance of this ME. Through an identical ID, this ME is implicitly linked to an instance of the PPTP xDSL UNI part 1 ME. (R, set-by-create) (mandatory) (2 bytes)

Logging depth event percentage per event – VTU-O (LOGGING_DEPTH_EVENT_PERCENTAGE_Oi) table: This parameter is the percentage of the data gathering event buffer assigned to event type i at the VTU-O. See clause 7.3.6.1 of [ITU-T G.997.1]. Each element in the table consists of 2 bytes, where the first byte is event type i , and the second byte is the percentage of event type i defined as the integer value multiplied by 1%. (R, W) (optional) ($2 \times N$ bytes for N event types)

Logging depth event percentage per event – VTU-R (LOGGING_DEPTH_EVENT_PERCENTAGE_Ri) table: This parameter is the percentage of the data gathering event buffer assigned to event type i at the VTU-R. See clause 7.3.6.2 of [ITU-T G.997.1]. Each element in the table consists of 2 bytes, where the first byte is event type i , and the second byte is the percentage of event type i defined as the integer value multiplied by 1%. (R, W) (optional) ($2 \times N$ bytes for N event types)

Logging depth for VTU-O reporting – VTU-R (LOGGING_DEPTH_REPORTING_O): This parameter is the logging depth that is requested for reporting the VTU-O event trace buffer in the CO-MIB, in number of 6 byte data gathering records. See clause 7.3.6.3 of [ITU-T G.997.1]. (R, W) (optional) (2 bytes)

Logging depth for VTU-R reporting – VTU-R (LOGGING_DEPTH_REPORTING_R): This parameter is the logging depth that is requested for reporting the VTU-R event trace buffer over the embedded operations channel (eoc), in number of 6 byte data gathering records. See clause 7.3.6.4 of [ITU-T G.997.1]. (R, W) (optional) (2 bytes)

Logging data report newer events first – VTU-R (LOGGING_REPORT_NEWER_FIRST): This parameter determines whether the VTU-R reports newer events first or older events first. See clause 7.3.6.4 of [ITU-T G.997.1]. False is mapped to 0, true is mapped to 1. (R, W) (optional) (1 byte)

Actions

Create, delete, get, get next, set

Set table (optional)

Notifications

None.

9.7.37 xDSL line inventory and status data part 8

This ME extends the attributes defined in the xDSL line inventory and status data parts 1..4.

Relationships

This is one of the status data MEs associated with an xDSL UNI. The ONU automatically creates or deletes an instance of this ME upon creation or deletion of a PPTP xDSL UNI part 1 that supports these attributes.

Attributes

Managed entity ID: This attribute uniquely identifies each instance of this ME. Through an identical ID, this ME is implicitly linked to an instance of the PPTP xDSL UNI part 1 ME. (R) (mandatory) (2 bytes)

Retransmission used downstream (RTX_USEDds): This parameter specifies whether [ITU-T G.998.4] retransmission is used (i.e., active in showtime) in the

downstream transmit direction. The valid range of values is given in clause 7.5.1.38 of [ITU-T G.997.1]. (R) (mandatory) (1 byte)

Retransmission used upstream (RTX_USEDus): This parameter specifies whether [ITU-T G.998.4] retransmission is used (i.e., active in showtime) in the upstream transmit direction. The valid range of values is given in clause 7.5.1.38 of [ITU-T G.997.1]. (R) (mandatory) (1 byte)

Date/time-stamping of near-end test parameters (STAMP-TEST-NE): This parameter indicates the date/time when the near-end test parameters that can change during showtime were last updated. See clause 7.5.1.36.3 of [ITU-T G.997.1]. The format of this parameter is as follows.

Year	2 bytes
Month	1 byte (1..12)
Day	1 byte (1..31)
Hour	1 byte (0..23)
Minute	1 byte (0..59)
Second	1 byte (0..59)

(R) (optional) (7 bytes)

Date/time-stamping of far-end test parameters (STAMP-TEST-FE): This parameter indicates the date/time when the far-end test parameters that can change during showtime were last updated. See clause 7.5.1.36.4 of [ITU-T G.997.1]. The format of this parameter is the same as STAMP-TEST-NE. (R) (optional) (7 bytes)

Date/time-stamping of last successful downstream OLR operation (STAMP-OLR-ds): This parameter indicates the date/time of the last successful OLR execution in the downstream direction that has modified the bits or gains. See clause 7.5.1.37.1 of [ITU-T G.997.1]. The format of this parameter is the same as STAMP-TEST-NE. (R) (optional) (7 bytes)

Date/time-stamping of last successful upstream OLR operation (STAMP-OLR-us): This parameter indicates the date/time of the last successful OLR execution in the upstream direction that has modified the bits or gains. See clause 7.5.1.37.2 of [ITU-T G.997.1]. The format of this parameter is the same as STAMP-TEST-NE. (R) (optional) (7 bytes)

Actions

Get, get next

Notifications

None.

9.7.38 VDSL2 line inventory and status data part 4

This ME extends the other xDSL line inventory and status data MEs with attributes specific to VDSL2.

Relationships

This is one of the status data MEs associated with an xDSL UNI. It is required only if VDSL2 is supported by the PPTP. The ONU automatically creates or deletes an instance of this ME upon creation or deletion of a PPTP xDSL UNI part 1 that supports these attributes.

Attributes

- Managed entity ID:** This attribute uniquely identifies each instance of this ME. Through an identical ID, this ME is implicitly linked to an instance of the PPTP xDSL UNI part 1 ME. (R) (mandatory) (2 bytes)
- VTU-O estimated upstream power back-off electrical length per band (UPBOKLE-pb):** This parameter is a vector of UPBO electrical length per-band estimates for each supported upstream band except US0, calculated by the VTU-O, based on separate measurements in the supported upstream bands excluding US0. This parameter is required for the alternative electrical length estimation method (ELE-M1). Each per-band estimate is represented by 2 bytes, where the estimate is defined as the integer value multiplied by 0.1 dB. The valid range of values is given in clause 7.5.1.23.3 of [ITU-T G.997.1] (R) (optional) (4 bands × 2 bytes)
- VTU-R estimated upstream power back-off electrical length per band (UPBOKLE-R-pb):** This parameter is a vector of UPBO electrical length per-band estimates for each supported downstream band, calculated by the VTU-R, based on separate measurements in the supported downstream bands. This parameter is required for the alternative electrical length estimation method (ELE-M1). Each per-band estimate is represented by 2 bytes, where the estimate is defined as the integer value multiplied by 0.1 dB. The valid range of values is given in clause 7.5.1.23.4 of [ITU-T G.997.1] (R) (optional) (3 bands × 2 bytes)
- UPBO downstream receiver signal level threshold (RXTHRSHds):** This parameter reports the downstream received signal level threshold value used in the alternative electrical length estimation method (ELE-M1). Valid values range from 0 (−64 dB) to 64 (0 dB). See clause 7.5.1.23.5 of [ITU-T G.997.1] (R) (optional) (1 byte)
- UPBO upstream receiver signal level threshold (RXTHRSHus):** This parameter reports the upstream received signal level threshold value used in the alternative electrical length estimation method. Valid values range from 0 (−64 dB) to 64 (0 dB). See clause 7.5.1.23.6 of [ITU-T G.997.1] (R) (optional) (1 byte)
- Actual alternative electrical length estimation mode (ACT-AELE-MODE):** This parameter reports the actual AELE-MODE. Valid values are given in clause 7.5.1.23.7 of [ITU-T G.997.1] (R) (optional) (1 byte)
- Actual downstream RIPOLICY (ACTRIPOLICYds):** This parameter indicates the actual re-initialization policy in use in the downstream direction. Valid values are given in clause 7.5.1.40.1 of [ITU-T G.997.1] (R) (optional) (1 byte)
- Actual upstream RIPOLICY (ACTRIPOLICYus):** This parameter indicates the actual re-initialization policy in use in the upstream direction. Valid values are given in clause 7.5.1.40.2 of [ITU-T G.997.1] (R) (optional) (1 byte)
- ATTNDR actual method (ATTNDR_ACTMETHOD):** This parameter indicates the actual ATTNDR Method used for calculation of the ATTNDR in the downstream and upstream direction. Valid values are given in clause 7.5.1.41.1 of [ITU-T G.997.1] (R) (optional) (1 byte)
- ATTNDR downstream actual impulse noise protection (ATTNDR_ACTINPDs):** If retransmission is not used in the downstream direction, this parameter indicates the actual INP used in the improved calculation of the ATTNDR in the downstream direction. If retransmission is used in the downstream direction, this parameter indicates the actual INP against SHINE used in the

improved calculation of the ATTNDR in the downstream direction. The format and usage is identical to that of the ACTINP attribute defined in the xDSL channel downstream status data ME. See clause 7.5.1.41.2 of [ITU-T G.997.1] (R) (optional) (1 byte)

ATTNDR upstream actual impulse noise protection (ATTNDR_ACTINPus): If retransmission is not used in the upstream direction, this parameter indicates the actual INP used in the improved calculation of the ATTNDR in the upstream direction. If retransmission is used in the upstream direction, this parameter indicates the actual INP against SHINE used in the improved calculation of the ATTNDR in the upstream direction. The format and usage is identical to that of the ACTINP attribute defined in the xDSL channel downstream status data ME. See clause 7.5.1.41.3 of [ITU-T G.997.1] (R) (optional) (1 byte)

ATTNDR downstream actual impulse noise protection against REIN (ATTNDR_ACTINP_REINds): If retransmission is used in the downstream direction, this parameter reports the actual INP against REIN used in the improved calculation of the ATTNDR in the downstream direction. The format and usage is identical to that of the ACTINP_REIN attribute defined in the xDSL channel downstream status data ME. See clause 7.5.1.41.4 of [ITU-T G.997.1] (R) (optional) (1 byte)

ATTNDR upstream actual impulse noise protection against REIN (ATTNDR_ACTINP_REINus): If retransmission is used in the upstream direction, this parameter reports the actual INP against REIN used in the improved calculation of the ATTNDR in the upstream direction. The format and usage is identical to that of the ACTINP_REIN attribute defined in the xDSL channel downstream status data ME. See clause 7.5.1.41.5 of [ITU-T G.997.1] (R) (optional) (1 byte)

ATTNDR downstream actual delay (ATTNDR_ACTDELAYds): This parameter indicates the actual delay used in the improved calculation of the ATTNDR in the downstream direction. The delay of this attribute is equal to the integer value multiplied by 0.1 ms. Valid values are given in clause 7.5.1.41.6 of [ITU-T G.997.1] (R) (optional) (1 byte)

ATTNDR upstream actual delay (ATTNDR_ACTDELAYus): This parameter indicates the actual delay used in the improved calculation of the ATTNDR in the upstream direction. The delay of this attribute is equal to the integer value multiplied by 0.1 ms. Valid values are given in clause 7.5.1.41.7 of [ITU-T G.997.1] (R) (optional) (1 byte)

Near-end aggregate achievable net data rate (AGGACHNDR_NE): This parameter reports the aggregate achievable net data rate of the VTU-O, in bits per second. See clause 7.5.1.42.1 of [ITU-T G.997.1] (R) (optional) (4 bytes)

Far-end aggregate achievable net data rate (AGGACHNDR_FE): This parameter reports the aggregate achievable net data rate of the VTU-R, in bits per second. See clause 7.5.1.42.2 of [ITU-T G.997.1] (R) (optional) (4 bytes)

Actions

Get

Notifications

None.

9.7.39 Vectoring line inventory and status data

This ME contains line inventory and status attributes specific to vectoring.

Relationships

This is one of the status data MEs associated with an xDSL UNI. It is meaningful if the PPTP supports [ITU-T G.993.5]. The ONU automatically creates or deletes an instance of this ME upon creation and deletion of a PPTP xDSL UNI part 1 that supports these attributes.

Attributes

Managed entity ID: This attribute uniquely identifies each instance of this ME. Through an identical ID, this ME is implicitly linked to an instance of the PPTP xDSL UNI part 1 ME. (R) (mandatory) (2 bytes)

Downstream XLIN scale (XLINSCds): This parameter is the scale factor to be applied to the downstream Xlinpsds values. Valid values are given in clause 7.5.1.39.1 of [ITU-T G.997.1] (R) (mandatory) (2 bytes)

Downstream XLIN subcarrier group size (XLINGds): This parameter is the number of subcarriers per group used to report Xlinpsds. Valid values are given in clause 7.5.1.39.2 of [ITU-T G.997.1] (R) (mandatory) (1 bytes)

Downstream XLIN bandedges (XLINBANDSds) table: XLINBANDSds contains pairs of indices (start_subcarrier_index, stop_subcarrier_index) for every band in which XLINpsds is reported. Each index is 2 bytes. This attribute is organized as a table, so the number of bands can be determined from the table's size. See clause 7.5.1.39.3 of [ITU-T G.997.1] (R) (mandatory) (N bands x 4 bytes)

Downstream FEXT coupling (XLINpsds) table: For each given VCE port index k , this parameter is a one-dimensional array of complex values in linear scale for downstream FEXT coupling coefficients $X_{\text{linds}}(f)$ originating from the loop connected to the VCE port k into the loop for which $X_{\text{linds}}(f)$ is being reported. Each complex value $[a(n) + j \times b(n)]$ is represented by a 2 byte signed two's complement value $[a(n)]$, followed by a 2 byte signed two's complement value $[b(n)]$. This attribute is organized as a table, so the number of complex values in the array can be determined from the table's size. See clause 7.5.1.39.4 of [ITU-T G.997.1] (R) (mandatory) (N complex values \times 4 bytes)

Upstream XLIN scale (XLINSCus): This parameter is the scale factor to be applied to the upstream XLINpsus values. Valid values are given in clause 7.5.1.39.5 of [ITU-T G.997.1] (R) (mandatory) (2 bytes)

Upstream XLIN subcarrier group size (XLINGus): This parameter is the number of subcarriers per group used to report XLINpsus. Valid values are given in clause 7.5.1.39.6 of [ITU-T G.997.1] (R) (mandatory) (1 bytes)

Upstream XLIN bandedges (XLINBANDSsus) table: XLINBANDSsus contains pairs of indices (start_subcarrier_index, stop_subcarrier_index) for every band in which XLINpsus is reported. Each index is 2 bytes. This attribute is organized as a table, so the number of bands can be determined from the table's size. See clause 7.5.1.39.7 of [ITU-T G.997.1] (R) (mandatory) (N bands x 4 bytes)

Upstream FEXT coupling (XLINpsus) table: For each given VCE port index k , this parameter is a one-dimensional array of complex values in linear scale for upstream FEXT coupling coefficients $X_{\text{linus}}(f)$ originating from the loop connected to the VCE port k into the loop for which $X_{\text{linus}}(f)$ is being reported. Each complex value $[a(n) + j \times b(n)]$ is represented by a 2 byte signed two's

complement value $[a(n)]$, followed by a 2 byte signed two's complement value $[b(n)]$. This attribute is organized as a table, so the number of complex values in the array can be determined from the table's size. See clause 7.5.1.39.8 of [ITU-T G.997.1] (R) (mandatory) (N complex values \times 4 bytes)

Actual vectoring mode (ACTVECTORMODE): This parameter reports the vectoring initialization type of the line. Valid values are given in clause 7.5.1.43.1 of [ITU-T G.997.1] (R) (optional) (1 byte)

Actions

Get, get next

Notifications

None.

9.7.40 Data gathering line test, diagnostic and status

This ME contains xDSL data gathering line test, diagnostic and status parameters.

An instance of this ME is created and deleted by the OLT.

Relationships

An instance of this ME may be associated with zero or more instances of the PPTP xDSL UNI part 1.

Attributes

Managed entity ID: This attribute uniquely identifies each instance of this ME. Through an identical ID, this ME is implicitly linked to an instance of the PPTP xDSL UNI part 1 ME. (R, set-by-create) (mandatory) (2 bytes)

Logging depth – VTU-O (LOGGING_DEPTH_O): This parameter is the maximum depth of the entire data gathering event buffer at the VTU-O, in number of 6 byte data gathering records. See clause 7.5.3.1 of [ITU-T G.997.1] (R) (optional) (4 bytes)

Logging depth – VTU-R (LOGGING_DEPTH_R): This parameter is the maximum depth of the entire data gathering event buffer at the VTU-R, in number of 6 byte data gathering records. See clause 7.5.3.2 of [ITU-T G.997.1] (R) (optional) (4 bytes)

Actual logging depth for reporting – VTU-O (ACT_logging_depth_reporting_O): This parameter is the actual logging depth that is used for reporting the VTU-O event trace buffer in the CO-MIB, in number of 6 byte data gathering records. See clause 7.5.3.3 of [ITU-T G.997.1] (R) (optional) (4 bytes)

Actual logging depth for reporting – VTU-R (ACT_logging_depth_reporting_R): This parameter is actual logging depth that is used for reporting the VTU-R event trace buffer over the eoc, in number of 6 byte data gathering records. See clause 7.5.3.4 of [ITU-T G.997.1] (R) (optional) (4 bytes)

Event trace buffer – VTU-O (EVENT_TRACE_BUFFER_O) table: This parameter is the event trace buffer containing the event records that originated at the VTU-O. See clause 7.5.3.5 of [ITU-T G.997.1] (R) (optional) (N bytes)

Event trace buffer – VTU-R (EVENT_TRACE_BUFFER_R) table: This parameter is the event trace buffer containing the event records that originated at the VTU-R. See clause 7.5.3.6 of [ITU-T G.997.1] (R) (optional) (N bytes)

Actions

Get, get next

Notifications

None.

9.7.41 EFM bonding group

The EFM bonding group represents a group of links that are bonded. In [IEEE 802.3], a bonding group is known as a PAF [physical medium entity (PME) aggregation function] and a link is known as a PME instance of this ME are created and deleted by the OLT.

Relationships

An instance of this ME may be associated with zero or more instances of an EFM bonding link.

Attributes

Managed entity ID: This attribute uniquely identifies each instance of this ME. The value 0 is reserved. (R, set-by-create) (mandatory) (2 bytes)

Group ID: This attribute is the unique number representing this bonding group. See clause C.3.1.1 of [ITU-T G.998.2]. (R, W, set-by-create) (mandatory) (6 bytes)

Minimum upstream group rate: This attribute sets the minimum upstream group rate, in bits per second, for this EFM Group. This attribute is used to determine the group US rate low alarm status. The group US rate low alarm means that the aggregate upstream rate of all active links associated with this group is less than the minimum upstream group rate. The default value for this rate is zero. (R, W) (mandatory, set-by-create) (4 bytes)

Minimum downstream group rate: This attribute sets the minimum downstream group rate, in bits per second, for this EFM Group. This attribute is used to determine the group DS rate low alarm status. The group DS rate low alarm means that the aggregate downstream rate of all active links associated with this group is less than the minimum downstream group rate. The default value for this rate is zero. (R, W) (mandatory) (4 bytes, set-by-create)

Group alarm enable: This bit mapped attribute enables the various group alarms. A bit value of 1 means "enable".

Bit	Meaning
1 (LSB)	Group down
2	Group partial
3	Group US rate low
4	Group DS rate low
5	4x rate ratio
6-8	Reserved

(R, W, set-by-create) (mandatory) (1 byte)

Actions

Create, delete, get, set

Notifications

Alarm

Alarm number	Alarm	Description
0	Group down	No links associated with this group are active
1	Group partial	Not all links associated with this group are active
2	Group US rate low	Aggregate upstream rate is less than the minimum upstream group rate
3	Group DS rate low	Aggregate downstream rate is less than the minimum downstream group rate
4	4x rate ratio	In this group, ratio of max link rate to min link rate > 4
5..207	Reserved	

NOTE – An "active" link means that the port is trained and fragments can flow across the link in both directions.

9.7.42 EFM bonding link

The EFM bonding link represents a link that can be bonded with other links to form a group. In [IEEE 802.3], a bonding group is known as a PAF and a link is known as a PME. Instances of this ME are created and deleted by the OLT.

Relationships

An instance of this ME may be associated with zero or one instance of an EFM bonding group.

Attributes

Managed entity ID: This attribute uniquely identifies each instance of this ME. The two MSBs of the first byte are the bearer channel ID. Excluding the first 2 bits of the first byte, the remaining part of the ME ID is identical to that of this ME's parent PPTP xDSL UNI part 1.

NOTE – This attribute has the same meaning as the Stream ID in clause C.3.1.2 of [ITU-T G.998.2], except that it cannot be changed. (R, set-by-create) (mandatory) (2 bytes)

Associated group ME ID: This attribute is the ME ID of the bonding group to which this link is associated. Changing this attribute moves the link from one group to another. Setting this attribute to an ME ID that has not yet been provisioned will result in this link being placed in a single-link group that contains only this link. The default value for this attribute is the null pointer, 0xFFFF. (R, W, set-by-create) (mandatory) (2 bytes)

Link alarm enable: This bit mapped attribute enables the group down and group partial alarms. A bit value of 1 means "enable".

Bit	Meaning
1 (LSB)	Link down
2-8	Reserved

(R, W, set-by-create) (mandatory) (1 bytes)

Actions

Create, delete, get, set

Notifications

Alarm

Alarm number	Alarm	Description
0	Link down	Link not active. See definition in EFM bonding group ME
1..207	Reserved	

9.7.43 EFM bonding group performance monitoring history data

This ME collects PM data as seen at the xTU-C. Instances of this ME are created and deleted by the OLT.

Relationships

An instance of this ME is associated with an xDSL UNI.

Attributes

Managed entity ID: This attribute uniquely identifies each instance of this ME. Through an identical ID, this ME is implicitly linked to an instance of the EFM bonding group. (R, set-by-create) (mandatory) (2 bytes)

Interval end time: This attribute identifies the most recently finished 15 min interval. (R) (mandatory) (1 byte)

Threshold data 1/2 ID: This attribute points to an instance of the threshold data 1 and 2 MEs that contain PM threshold values. (R, W, set-by-create) (mandatory) (2 bytes)

Rx bad fragments: Clause 45.2.3.33 of [IEEE 802.3]. (R) (mandatory) (4 bytes)

Rx lost fragments: Clause 45.2.3.34 of [IEEE 802.3]. (R) (mandatory) (4 bytes)

Rx lost starts: Clause 45.2.3.35 of [IEEE 802.3]. (R) (mandatory) (4 bytes)

Rx lost ends: Clause 45.2.3.36 of [IEEE 802.3]. (R) (mandatory) (4 bytes)

Rx frames: Number of Ethernet frames received over this group. (R) (mandatory) (4 bytes)

Tx frames: Number of Ethernet frames transmitted over this group. (R) (mandatory) (4 bytes)

Rx bytes: Number of bytes contained in the Ethernet frames received over this group. (R) (mandatory) (8 bytes)

Tx bytes: Number of bytes contained in the Ethernet frames transmitted over this group. (R) (mandatory) (8 bytes)

Tx discarded frames: Number of Ethernet frames discarded by the group transmit function. (R) (mandatory) (4 bytes)

Tx discarded bytes: Number of bytes contained in the Ethernet frames discarded by the group transmit function. (R) (mandatory) (4 bytes)

Actions

Create, delete, get, set

Get current data (optional)

Notifications

Threshold crossing alert

Alarm number	Threshold crossing alert	Threshold value attribute No. (Note)
0	Rx bad fragments	1
1	Rx lost fragments	2
2	Rx lost starts	3
3	Rx lost ends	4
4..207	Reserved	

NOTE – This number associates the TCA with the specified threshold value attribute of the threshold data 1/2 managed entities.

9.7.44 EFM bonding group performance monitoring history data part 2

This ME collects PM data as seen at the xTU-C. Instances of this ME are created and deleted by the OLT.

Relationships

An instance of this ME is associated with an xDSL UNI.

Attributes

Managed entity ID: This attribute uniquely identifies each instance of this ME. Through an identical ID, this ME is implicitly linked to an instance of the EFM bonding group. (R, set-by-create) (mandatory) (2 bytes)

Interval end time: This attribute identifies the most recently finished 15 min interval. (R) (mandatory) (1 byte)

Threshold data 1/2 ID: This attribute points to an instance of the threshold data 1 and 2 MEs that contain PM threshold values. (R, W, set-by-create) (mandatory) (2 bytes)

Rx unicast frames: Number of unicast Ethernet frames received over this group. (R) (mandatory) (4 bytes)

Tx unicast frames: Number of unicast Ethernet frames transmitted over this group. (R) (mandatory) (4 bytes)

Rx unicast bytes: Number of bytes contained in the unicast Ethernet frames received over this group. (R) (mandatory) (8 bytes)

Tx unicast bytes: Number of bytes contained in the unicast Ethernet frames transmitted over this group. (R) (mandatory) (8 bytes)

Rx broadcast frames: Number of broadcast Ethernet frames received over this group. (R) (mandatory) (4 bytes)

Tx broadcast frames: Number of broadcast Ethernet frames transmitted over this group. (R) (mandatory) (4 bytes)

Rx broadcast bytes: Number of bytes contained in the broadcast Ethernet frames received over this group. (R) (mandatory) (8 bytes)

Tx broadcast bytes: Number of bytes contained in the broadcast Ethernet frames transmitted over this group. (R) (mandatory) (8 bytes)

Rx multicast frames: Number of multicast Ethernet frames received over this group. (R) (mandatory) (4 bytes)

Tx multicast frames: Number of multicast Ethernet frames transmitted over this group. (R) (mandatory) (4 bytes)

Rx multicast bytes: Number of bytes contained in the multicast Ethernet frames received over this group. (R) (mandatory) (8 bytes)

Tx multicast bytes: Number of bytes contained in the multicast Ethernet frames transmitted over this group. (R) (mandatory) (8 bytes)

Actions

Create, delete, get, set

Get current data (optional)

Notifications

None.

9.7.45 EFM bonding link performance monitoring history data

This ME collects PM data as seen at the xTU-C. Instances of this ME are created and deleted by the OLT.

Relationships

An instance of this ME is associated with an xDSL UNI.

Attributes

Managed entity ID: This attribute uniquely identifies each instance of this ME. Through an identical ID, this ME is implicitly linked to an instance of the EFM bonding link. (R, set-by-create) (mandatory) (2 bytes)

Interval end time: This attribute identifies the most recently finished 15 min interval. (R) (mandatory) (1 byte)

Threshold data 1/2 ID: This attribute points to an instance of the threshold data 1 and 2 MEs that contain PM threshold values. (R, W, set-by-create) (mandatory) (2 bytes)

Rx errored fragments: Clause 45.2.3.29 of [IEEE 802.3]. (R) (mandatory) (4 bytes)

Rx small fragments: Clause 45.2.3.30 of [IEEE 802.3]. (R) (mandatory) (4 bytes)

Rx large fragments: Clause 45.2.3.31 of [IEEE 802.3]. (R) (mandatory) (4 bytes)

Rx discarded fragments: Clause 45.2.3.32 of [IEEE 802.3]. (R) (mandatory) (4 bytes)

Rx FCS errors: Clause 45.2.6.11 of [IEEE 802.3]. (R) (mandatory) (4 bytes)

Rx coding errors: Clause 45.2.6.12 of [IEEE 802.3]. (R) (mandatory) (4 bytes)

Rx fragments: Number of fragments received over this link. (R) (mandatory) (4 bytes)

Tx fragments: Number of fragments transmitted over this link. (R) (mandatory) (4 bytes)

Actions

Create, delete, get, set

Get current data (optional)

Notifications

Threshold crossing alert

Alarm number	Threshold crossing alert	Threshold value attribute No. (Note)
0	Rx errored fragments	1
1	Rx small fragments	2
2	Rx large fragments	3
3	Rx discarded fragments	4
4	Rx FCS errors	5
5	Rx coding errors	6
6-207	Reserved	

NOTE – This number associates the TCA with the specified threshold value attribute of the threshold data 1/2 managed entities.

9.7.46 EFM bonding port performance monitoring history data

This ME collects PM data as seen at the xTU-C. Instances of this ME are created and deleted by the OLT.

Relationships

An instance of this ME is associated with an xDSL UNI.

Attributes

Managed entity ID: This attribute uniquely identifies each instance of this ME. The two MSBs of the first byte are the bearer channel ID. Excluding the first 2 bits of the first byte, the remaining part of the ME ID is identical to that of this ME's parent PPTP xDSL UNI part 1. (R, set-by-create) (mandatory) (2 bytes)

Interval end time: This attribute identifies the most recently finished 15 min interval. (R) (mandatory) (1 byte)

Threshold data 1/2 ID: This attribute points to an instance of the threshold data 1 and 2 MEs that contain PM threshold values. (R, W, set-by-create) (mandatory) (2 bytes)

Rx frames: Number of Ethernet frames received over this port. (R) (mandatory) (4 bytes)

Tx frames: Number of Ethernet frames transmitted over this port. (R) (mandatory) (4 bytes)

Rx bytes: Number of bytes contained in the Ethernet frames received over this port. (R) (mandatory) (4 bytes)

Tx bytes: Number of bytes contained in the Ethernet frames transmitted over this port. (R) (mandatory) (4 bytes)

Tx discarded frames: Number of Ethernet frames discarded by the port transmit function. (R) (mandatory) (4 bytes)

Tx discarded bytes: Number of bytes contained in the Ethernet frames discarded by the port transmit function. (R) (mandatory) (4 bytes)

Actions

Create, delete, get, set

Get current data (optional)

Notifications

Threshold crossing alert

Alarm number	Threshold crossing alert	Threshold value attribute No. (Note)
0	Bad fragments	1
1	Lost fragments	2
2	Lost starts	3
3	Lost ends	4
4-207	Reserved	

NOTE – This number associates the TCA with the specified threshold value attribute of the threshold data 1/2 managed entities.

9.7.47 EFM bonding port performance monitoring history data part 2

This ME collects PM data as seen at the xTU-C. Instances of this ME are created and deleted by the OLT.

Relationships

An instance of this ME is associated with an xDSL UNI.

Attributes

Managed entity ID: This attribute uniquely identifies each instance of this ME. The two MSBs of the first byte are the bearer channel ID. Excluding the first 2 bits of the first byte, the remaining part of the ME ID is identical to that of this ME's parent PPTP xDSL UNI part 1. (R, set-by-create) (mandatory) (2 bytes)

Interval end time: This attribute identifies the most recently finished 15 min interval. (R) (mandatory) (1 byte)

Threshold data 1/2 ID: This attribute points to an instance of the threshold data 1 and 2 MEs that contain PM threshold values. (R, W, set-by-create) (mandatory) (2 bytes)

Rx unicast frames: Number of unicast Ethernet frames received over this port. (R) (mandatory) (4 bytes)

Tx unicast frames: Number of unicast Ethernet frames transmitted over this port. (R) (mandatory) (4 bytes)

Rx unicast bytes: Number of bytes contained in the unicast Ethernet frames received over this port. (R) (mandatory) (4 bytes)

Tx unicast bytes: Number of bytes contained in the unicast Ethernet frames transmitted over this port. (R) (mandatory) (4 bytes)

Rx broadcast frames: Number of broadcast Ethernet frames received over this port. (R) (mandatory) (4 bytes)

Tx broadcast frames: Number of broadcast Ethernet frames transmitted over this port. (R) (mandatory) (4 bytes)

Rx broadcast bytes: Number of bytes contained in the broadcast Ethernet frames received over this port. (R) (mandatory) (4 bytes)

Tx broadcast bytes: Number of bytes contained in the broadcast Ethernet frames transmitted over this port. (R) (mandatory) (4 bytes)

Rx multicast frames: Number of multicast Ethernet frames received over this port. (R) (mandatory) (4 bytes)

Tx multicast frames: Number of multicast Ethernet frames transmitted over this port. (R) (mandatory) (4 bytes)

Rx multicast bytes: Number of bytes contained in the multicast Ethernet frames received over this port. (R) (mandatory) (4 bytes)

Tx multicast bytes: Number of bytes contained in the multicast Ethernet frames transmitted over this port. (R) (mandatory) (4 bytes)

Actions

Create, delete, get, set

Get current data (optional)

Notifications

None.

9.7.48 Physical path termination point xDSL UNI part 3

This ME represents the point in the ONU where physical paths terminate on an xDSL CO modem (xTU-C). Standards and chip sets support several forms of DSL, including VDSL2 and FAST, and the xDSL ME family is used for all of them, with specific extensions for technology variations.

The ONU creates or deletes an instance of this ME at the same time it creates or deletes the corresponding PPTP xDSL UNI part 1.

Relationships

An instance of this ME is associated with each instance of a real or preprovisioned xDSL port

Attributes

Managed entity ID: This attribute uniquely identifies each instance of this ME. This 2 byte number indicates the physical position of the UNI. The six LSBs of the first byte are the slot ID, defined in clause 9.1.5. The two MSBs indicate the channel number in some of the implicitly linked MEs, and must be 0 in the PPTP itself. This reduces the possible number of physical slots to 64. The second byte is the port ID, with range 1..255. (R) (mandatory) (2 bytes)

FAST line configuration profile: This attribute points to an instance of the FAST line configuration profiles (part 1, 2, 3 and 4) MEs, also to FAST vectoring line configuration extension MEs. Upon ME instantiation, the ONU sets this attribute to 0, a null pointer. (R, W) (mandatory) (2 bytes)

FAST data path configuration profile: This attribute points to an instance of the FAST data configuration profile that defines data path parameters. Upon ME instantiation, the ONU sets this attribute to 0, a null pointer. (R, W) (optional) (2 bytes)

FAST channel configuration profile for bearer channel 0 downstream: This attribute points to an instance of the FAST channel configuration profile that defines channel parameters. Upon ME instantiation, the ONU sets this attribute to 0, a null pointer. (R, W) (optional) (2 bytes) (R, W) (optional) (2 bytes)

FAST xDSL channel configuration profile for bearer channel 0 upstream: This attribute points to an instance of the FAST channel configuration profile that defines channel parameters. Upon ME instantiation, the ONU sets this attribute to 0, a null pointer (R, W) (optional) (2 bytes)

Actions

Get, set

Notifications

None.

9.7.49 FAST line configuration profile part 1

This ME extends the xDSL line configuration MEs with attributes that were originally unique to [ITU-T G.9700] and [ITU-T G.9701] FAST. The attributes of this ME are defined in [ITU-T G.997.2]. An instance of this ME is created and deleted by the OLT.

Relationships

An instance of this ME may be associated with zero or more instances of an xDSL UNI.

The overall FAST line configuration profile is modelled in several parts, all of which are associated together through a common ME ID (the client PPTP xDSL UNI part 3 has a single pointer, which refers to the entire set of line configuration parts).

Attributes

Managed entity ID: This attribute uniquely identifies each instance of this ME. All FAST line configuration profiles and extensions that pertain to a given PPTP xDSL UNI must share a common ME ID. (R, set-by-create) (mandatory) (2 bytes)

ITU-T G.9701 profiles enabling (PROFILES): This attribute contains the ITU-T G.9701 profiles to be allowed by the xTU-C. See clause 7.1.0.1 of [ITU-T G.997.2]. It is coded in a bit map representation (0 if not allowed, 1 if allowed) with the following definition:

Bit	Meaning
1 (LSB)	ITU-T G.9701 profile 106a.

(R, W, set-by-create) (mandatory) (1 byte)

Symbol periods per TDD frame (MF): This attribute specifies the total number of symbol periods in a TDD frame. See clause 10.5 of [ITU-T G.9701]. Valid values are 23 and 36. (R, W, set-by-create) (mandatory) (1 byte)

Symbol periods per TDD frame dedicated for downstream transmission (Mds): This attribute specifies the total number of symbol positions in a TDD frame allocated for downstream transmission. The total number of symbol positions in a TDD frame allocated for upstream transmission is calculated as $M_{us} = MF - 1 - M_{ds}$. See clause 10.5 of [ITU-T G.9701]. Valid values range from 10 to 32 (if $MF = 36$) and from 6 to 19 (if $MF = 23$). The default value is 28 (if $MF = 36$) and 18 (if $MF = 23$). See clause 7.1.1.2 of [ITU-T G.997.2]. (R, W, set-by-create) (mandatory) (1 byte)

Downstream maximum aggregate transmit power (MAXATPds): This attribute specifies the maximum aggregate transmit power at the U-O2 reference point in the downstream direction during initialization and showtime (in decibel-milliwatts). Valid values range from 5 to 31 in steps of 1 s. See clause 7.1.2.1 of [ITU-T G.997.2]. (R, W) (mandatory) (2 bytes)

Upstream maximum aggregate transmit power (MAXATPus): This attribute specifies the maximum aggregate transmit power at the U-R2 reference point in the upstream direction during initialization and showtime (in decibel-milliwatts). The attribute value ranges from 0 (−31.0 dBm) to 620 (+31.0 dBm) in steps of 0.1 dBm. See clause 7.1.2.2 of [ITU-T G.997.2]. (R, W) (mandatory) (2 bytes)

Downstream subcarrier masking (CARMASKds) table: This attribute specifies the masked subcarrier bands in the downstream direction. All subcarriers within the band, i.e., with indices higher than or equal to the start subcarrier index and lower than or equal to the stop subcarrier index, are masked, i.e., have a transmit power set to zero (linear scale)

The CARMASK attribute is a table where each entry comprises:

- an entry number field (1 byte, first entry numbered 1);
- band start subcarrier index (2 bytes);
- band stop subcarrier index (2 bytes).

Subcarrier index valid values range from 0 to 4095 (subcarrier index 0 to 4095). By default, no masked subcarriers, the table is empty. Setting a table entry with non-zero subcarrier references implies insertion into the table. Setting an entry's subcarrier references to 0xFFFF implies deletion from the table, if present. See clause 7.1.2.3 of [ITU-T G.997.2].

(R, W) mandatory (5*N bytes)

Upstream subcarrier masking (CARMASKus) table: This attribute specifies the masked subcarrier bands in the upstream direction. All subcarriers within the band, i.e., with indices higher than or equal to the start subcarrier index and lower than or equal to the stop subcarrier index, have a transmit power set to zero (linear scale).

The CARMASK attribute is a table where each entry comprises:

- an entry number field (1 byte, first entry numbered 1);
- band start subcarrier index (2 bytes);
- band stop subcarrier index (2 bytes).

Valid value of band subcarrier index ranges from 0 to 4095. By default, no masked subcarriers, the table is empty. Setting a table entry with non-zero subcarrier references implies insertion into the table. Setting an entry's subcarrier references to 0xFFFF implies deletion from the table, if present. See clause 7.1.2.4 of [ITU-T G.997.2].

(R, W) (mandatory) (5*N bytes)

Downstream PSD mask (PSDMASKds) table: This attribute specifies the downstream PSD mask applicable at the U-O2 reference point. Requirements for a valid PSDMASKds are defined in [ITU-T G.9701] clauses 7.3.1.1.2.1 and 7.3.1.1.2.2.

Each table entry in this attribute comprises:

- an entry number field (1 byte, first entry numbered 1);
- a subcarrier index field, denoted t (2 bytes);
- a PSD mask level field (1 byte).

The valid value of the subcarrier index ranges from 0 to 4095. The valid values of PSD level range from 0 (0 dBm/Hz) to 255 (−127.5 dBm/Hz), with a granularity of −0.5 dBm/Hz. Setting a table entry with non-zero subcarrier references implies insertion into the table. Setting an entry's subcarrier references to 0xFFFF implies deletion from the table, if present. See clause 7.1.2.5 of [ITU-T G.997.2].

(R, W) (mandatory) (4*N N<=32bytes)

Upstream PSD mask (PSDMASKus) table: This attribute specifies the upstream PSD mask applicable at the U-R2 reference point. Requirements for a valid PSDMASKDs are defined in [ITU-T G.9701] clauses 7.3.1.1.2.1 and 7.3.1.1.2.2.

Each table entry in this attribute comprises:

- an entry number field (1 byte, first entry numbered 1);
- a subcarrier index field, denoted t (2 bytes);
- a PSD mask level field (1 byte).

The valid values of the subcarrier index range from 0 to 4095. The valid value of PSD level ranges from 0 (0 dBm/Hz) to 255 (–127.5 dBm/Hz), with a granularity of –0.5 dBm/Hz. Setting a table entry with non-zero subcarrier references implies insertion into the table. Setting an entry's subcarrier references to 0xFFFF implies deletion from the table, if present. See clause 7.1.2.6 of [ITU-T G.997.2]. (R, W) (mandatory) (4*N N<=32bytes)

RFI bands (RFIBANDS) table: This attribute specifies the bands where the PSD shall be reduced as specified in [ITU-T G.9701] clause 7.3.1.2.

The table where each entry comprises:

- an entry number field (1 byte, first entry numbered 1);
- subcarrier index 1 field (2 bytes);
- subcarrier index 2 field (2 bytes).

The valid value of the band subcarrier index ranges from 0 to 4095. By default, no masked subcarriers, the table is empty. Setting a table entry with non-zero subcarrier references implies insertion into the table. Setting an entry's subcarrier references to 0xFFFF implies deletion from the table, if present. See clause 7.1.2.7 of [ITU-T G.997.2].

(R, W) (mandatory) (5 * N bytes)

International amateur radio bands (IARBANDS): This attribute specifies for each international amateur radio (IAR) band whether transmit PSD reduction is enabled or disabled in that band.

Bit representation:

- 0 International amateur radio band 1800-2000 kHz
- 1 International amateur radio band 3500-4000 kHz
- 2 International amateur radio band 7000-7300 kHz
- 3 International amateur radio band 10100-10150 kHz
- 4 International amateur radio band 14000-14350 kHz
- 5 International amateur radio band 18068-18168 kHz
- 6 International amateur radio band 21000-21450 kHz
- 7 International amateur radio band 24890-24990 kHz
- 8 International amateur radio band 28000-29700 kHz
- 9 International amateur radio band 50000-54000 kHz
- 10 International amateur radio band 70000-70500 kHz
- 11 International amateur radio band 144000-148000 kHz

Default value: All IAR bands disabled (no PSD reduction)

See clause 7.1.2.8 of [ITU-T G.997.2]

(R, W) (mandatory) (2 bytes)

Upstream power back-off reference PSD (UPBOPSDA): This attribute specifies the parameter a for the UPBO reference PSD used to compute the UPBO for the upstream frequency band. The valid values range from 0 (40 dBm/Hz) to 4095 (80.95 dBm/Hz), with a granularity of -0.01 dBm/Hz. See clause 7.1.2.9 of [ITU-T G.997.2]. (R, W) (mandatory) (2 bytes)

Upstream power back-off reference PSD (UPBOPSDB): This attribute specifies the parameter b for the UPBO reference PSD used to compute the UPBO for the upstream frequency band. The valid values range from 0 (0 dBm/Hz) to 4095 (40.95 dBm/Hz), with a granularity of -0.01 dBm/Hz. See clause 7.1.2.10 of [ITU-T G.997.2]. (R, W) (mandatory) (2 bytes)

Upstream electrical length (UPBOKL): This attribute specifies the electrical length kl_0 (expressed in decibels at 1 MHz). The valid values range from 0 (0 dB) to 1280 (128 dB), with a granularity of -0.1 dB. See clause 7.1.2.11 of [ITU-T G.997.2]. (R, W) (mandatory) (2 bytes)

Force electrical length (UPBOKLF): This Boolean attribute specifies whether the FTU-R is forced to use the electrical length $kl_0 = \text{UPBOKL}$ to compute the UPBOMASK. If not forced, the FTUs determine the electrical length kl_0 : true specifies that the FTU-R is forced to use, false specifies not forced. See clause 7.1.2.12 of [ITU-T G.997.2]. (R, W) (mandatory) (1 byte)

UPBO reference electrical length per band (UPBOKLREF): This attribute specifies the UPBO reference electrical length kl_0_REF used to compute the UPBO for the Equalized FEXT UPBO method. The valid values range from 18 (1.8) to 635 (63.5 dB), with a granularity of -0.1 dB. The special value 0 indicates that the Equal PSD UPBO method is used. See clause 7.1.2.13 of [ITU-T G.997.2]. (R, W) (mandatory) (2 bytes)

Actions

Create, delete, get, get next, set
set table (optional)

Notifications

None.

9.7.50 FAST line configuration profile part 2

This ME extends the FAST line configuration MEs. An instance of this ME is created and deleted by the OLT.

Relationships

An instance of this ME may be associated with zero or more instances of the PPTP xDSL UNI part 1.

The overall FAST line configuration profile is modelled in several parts, all of which are associated together through a common ME ID. (The client PPTP xDSL UNI part 3 has a single pointer, which refers to the entire set of line configuration parts).

Attributes

- Managed entity ID:** This attribute uniquely identifies each instance of this ME. All FAST line configuration profiles and extensions that pertain to a given PPTP xDSL UNI must share a common ME ID. (R, set-by-create) (mandatory) (2 bytes)
- Downstream target noise margin (TARSNRMds):** This attribute specifies the downstream target noise margin for the channel initialization policy. The valid values range from 0 (0 dB) to 310 (31 dB) in steps of -0.1 dB. See clause 7.1.3.1 of [ITU-T G.997.2]. (R, W) (mandatory) (2 bytes)
- Upstream target noise margin (TARSNRMus):** This attribute specifies the upstream target noise margin used in the channel initialization policy. The valid values range from 0 (0 dB) to 310 (31 dB) in steps of -0.1 dB. See clause 7.1.3.2 of [ITU-T G.997.2]. (R, W) (mandatory) (2 bytes)
- Downstream maximum noise margin (MAXSNRMds):** This attribute specifies the downstream maximum noise margin used in the channel initialization policy. The special value indicates there is no maximum bound for the downstream noise margin (i.e., the downstream maximum noise margin is infinite). The valid values range 511 (special value) and 0..310 (0 to 31 dB) in steps of -0.1 dB. See clause 7.1.3.3 of [ITU-T G.997.2]. (R, W) (mandatory) (2 bytes)
- Upstream maximum noise margin (MAXSNRMus):** This attribute specifies the upstream maximum noise margin used in the channel initialization policy. The special value indicates there is no maximum bound for the upstream noise margin (i.e., the upstream maximum noise margin is infinite). The valid values range 511 (special value) and 0..310 (0 to 31 dB) in steps of -0.1 dB. See clause 7.1.3.3 of [ITU-T G.997.2]. (R, W) (mandatory) (2 bytes)
- Downstream minimum noise margin (MINSNRMds):** This attribute specifies the downstream minimum noise margin the FTU-R receiver shall tolerate. If the downstream noise margin (SNRMds) falls below this level, the FTU-R requests the FTU-O to increase the FTU-O transmit power. If an increase to FTU-O transmit power is not possible, an LOM defect occurs. Upon persistency of the LOM defect, the FTU-R triggers a re-initialization. See clause 12.1.4.2 of [ITU-T G.9701]. The valid values range from 0 (0 dB) to 310 (31 dB) in steps of -0.1 dB. See clause 7.1.3.4 of [ITU-T G.997.2]. (R, W) (mandatory) (2 bytes)
- Upstream minimum noise margin (MINSNRMus):** This attribute specifies the upstream minimum noise margin the FTU-O receiver shall tolerate. If the upstream noise margin (SNRMus) falls below this level, the FTU-O requests the FTU-R to increase the FTU-R transmit power. If an increase to FTU-R transmit power is not possible, an LOM defect occurs. Upon persistency of the LOM defect, the FTU-O triggers a re-initialization. See clause 12.1.4.2 of [ITU-T G.9701]. The valid values range from 0 (0 dB) to 310 (31 dB) in steps of -0.1 dB. See clause 7.1.3.5 of [ITU-T G.997.2]. (R, W) (mandatory) (2 bytes)
- Downstream target noise margin for RMC (TARSNRM-RMCds):** This attribute specifies the downstream RMC noise margin (SNRM-RMCds) that the FTU-R receiver shall achieve, relative to the BER requirement, or better, to successfully complete initialization. The valid values range from 0 (0 dB) to 310 (31 dB) in steps of 0.1 dB. See clause 7.1.6.1 of [ITU-T G.997.2] for detailed specification. (R, W) (mandatory) (2 bytes)

Upstream target noise margin (TARSNRM-RMCus): This attribute specifies the upstream RMC noise margin (SNRM-RMCus) that the FTU-O receiver shall achieve, relative to the BER requirement, or better, to successfully complete initialization. The valid values range from 0 (0 dB) to 310 (31 dB) in steps of 0.1 dB. See clause 7.1.6.2 of [ITU-T G.997.2] for detailed specification. (R, W) (mandatory) (2 bytes)

Downstream minimum noise margin for RMC (MINSNRM-RMCds): This attribute defines the downstream minimum noise margin the FTU-R receiver tolerates for the RMC. If the downstream RMC noise margin (SNRM-RMCds) falls below this level, the FTU-R initiates the RPA procedure. The valid values range from 0 (0 dB) to 310 (31 dB) in steps of 0.1 dB. See clause 7.1.6.3 of [ITU-T G.997.2] for detailed specification. (R, W) (mandatory) (2 bytes)

Upstream minimum noise margin for RMC (MINSNRM-RMCus): This attribute defines the upstream minimum noise margin the FTU-O receiver tolerates for the RMC. If the downstream RMC noise margin (SNRM-RMCus) falls below this level, the FTU-O initiates the RPA procedure. The valid values range from 0 (0 dB) to 310 (31 dB) in steps of 0.1 dB. See clause 7.1.6.4 of [ITU-T G.997.2] for detailed specification. (R, W) (mandatory) (2 bytes)

Downstream maximum bitloading for RMC (MAXBL-RMCds): This attribute defines the maximum allowed bit-loading for the downstream RMC subcarriers. The valid values range from 2 to 6. See clause 7.1.6.5 of [ITU-T G.997.2] for detailed specification. (R, W) (mandatory) (1 byte)

Upstream maximum bitloading for RMC (MAXBL-RMCus): This attribute defines the maximum allowed bit-loading for the upstream RMC subcarriers. The valid values range from 2 to 6. See clause 7.1.6.6 of [ITU-T G.997.2] for detailed specification. (R, W) (mandatory) (1 byte)

Actions

Create, delete, get, set

Notifications

None.

9.7.51 FAST line configuration profile part 3

This ME extends the FAST line configuration MEs. An instance of this ME is created and deleted by the OLT.

Relationships

An instance of this ME may be associated with zero or more instances of an xDSL UNI.

The overall FAST line configuration profile is modelled in several parts, all of which are associated together through a common ME ID (the client PPTP xDSL UNI part 3 has a single pointer, which refers to the entire set of line configuration parts).

Attributes

Managed entity ID: This attribute uniquely identifies each instance of this ME. All xDSL and VDSL2 line configuration profiles and extensions that pertain to a given PPTP xDSL UNI must share a common ME ID. (R, set-by-create) (mandatory) (2 bytes)

- Downstream upshift noise margin (SRA-USNRMds):** If the downstream noise margin (SNRMds) is above the downstream upshift noise margin and stays above that for more than the time specified by the downstream minimum upshift rate adaptation interval (SRA-UTIMEds), the FTU-R autonomously attempts to increase the downstream net data rate (NDR). The valid values range from 0 (0 dB) to 310 (31 dB) in steps of -0.1 dB. See clause 7.1.4.1 of [ITU-T G.997.2]. (R, W) (mandatory) (2 bytes)
- Upstream upshift noise margin (SRA-USNRMus):** If the upstream noise margin (SNRMus) is above the upstream upshift noise margin and stays above that for more than the time specified by the upstream minimum upshift rate adaptation interval (SRA-UTIMEus), the FTU-R autonomously attempts to increase the upstream net data rate (NDR). The valid values range from 0 (0 dB) to 310 (31 dB) in steps of -0.1 dB. See clause 7.1.4.2 of [ITU-T G.997.2]. (R, W) (mandatory) (2 bytes)
- Downstream minimum time interval for upshift SRA (SRA-UTIMEds):** This attribute specifies the interval of time the downstream noise margin (SNRMds) should stay above the downstream upshift noise margin (SRA-USNRMds) before the FTU-R autonomously attempts to increase the downstream net data rate (NDRds). The valid values range from 0 to 16383 s. See clause 7.1.4.3 of [ITU-T G.997.2]. (R, W) (mandatory) (2 bytes)
- Upstream minimum time interval for upshift SRA (SRA-UTIMEus):** This attribute specifies the interval of time the upstream noise margin (SNRMus) should stay above the upstream upshift noise margin (SRA-USNRMus) before the FTU-O autonomously attempts to increase the upstream net data rate (NDRus). The valid values range from 0 to 16383 s. See clause 7.1.4.4 of [ITU-T G.997.2]. (R, W) (mandatory) (2 bytes)
- Downstream downshift noise margin (SRA-DSNRMds):** If the downstream noise margin (SNRMds) is below the downstream downshift noise margin and stays below that for more than the time specified by the downstream minimum downshift rate adaptation interval (SRA-DTIMEds), the FTU-R autonomously attempts to decrease the downstream net data rate (NDRds). The valid values range from 0 (0 dB) to 310 (31 dB) in steps of -0.1 dB. See clause 7.1.4.5 of [ITU-T G.997.2]. (R, W) (mandatory) (2 bytes)
- Upstream downshift noise margin (SRA-DSNRMus):** If the upstream noise margin (SNRMus) is below the upstream downshift noise margin and stays below that for more than the time specified by the upstream minimum downshift rate adaptation interval (SRA-DTIMEus), the FTU-O autonomously attempts to decrease the upstream net data rate (NDRus). The valid values range from 0 (0 dB) to 310 (31 dB) in steps of -0.1 dB. See clause 7.1.4.6 of [ITU-T G.997.2]. (R, W) (mandatory) (2 bytes)
- Downstream minimum time interval for downshift SRA (SRA-DTIMEds):** This attribute specifies the interval of time the downstream noise margin (SNRMds) should stay below the downstream downshift noise margin (SRA-DSNRMds) before the FTU-R autonomously attempts to decrease the downstream net data rate (NDRds). The valid values range from 0 to 16383 s. See clause 7.1.4.7 of [ITU-T G.997.2]. (R, W) (mandatory) (2 bytes)
- Upstream minimum time interval for downshift SRA (SRA-DTIMEus):** This attribute specifies the interval of time the upstream noise margin (SNRMus) should stay below the upstream downshift noise margin (SRA-DSNRMus) before the

FTU-O autonomously attempts to decrease the upstream net data rate (NDRus). The valid values range from 0 to 16383 s. See clause 7.1.4.8 of [ITU-T G.997.2]. (R, W) (mandatory) (2 bytes)

Downstream FRA time window (FRA-TIMEds): In the standard FRA triggering criteria. See clause 13.3.1.1 of [ITU-T G.9701] for the downstream direction. The valid values range from 1 to 8 (if MF = 36) and from 1 to 12 (if MF = 23). See clause 7.1.5.1 of [ITU-T G.997.2]. (R, W) (mandatory) (1 byte)

Upstream FRA time window (FRA-TIMEus): This attribute specifies the duration of the time window used in the standard FRA triggering criteria. See clause 13.3.1.1 of [ITU-T G.9701] for the upstream direction. The valid values range from 1 to 8 (if MF = 36) and from 1 to 12 (if MF = 23). See clause 7.1.5.2 of [ITU-T G.997.2]. (R, W) (mandatory) (1 byte)

Downstream FRA minimum percentage of degraded tones (FRA-NTONESds): This attribute specifies the minimum percentage of loaded subcarriers (i.e., subcarriers with $b_i > 0$) that are detected as degraded throughout a time window equal to FRA-TIMEds in order to arm the first FRA triggering criteria. See clause 13.3.1.1.1.5 of [ITU-T G.9701] in the downstream direction. The valid values range from 1 to 100. The special value 0 indicates that monitoring of the percentage of degraded subcarriers is disabled. See clause 7.1.5.3 of [ITU-T G.997.2]. (R, W) (mandatory) (1 byte)

Upstream FRA minimum percentage of degraded tones (FRA-NTONESus): This attribute specifies the minimum percentage of loaded subcarriers (i.e., subcarriers with $b_i > 0$) that are detected as degraded throughout a time window equal to FRA-TIMEus in order to arm the first FRA triggering criteria. See clause 13.3.1.1.1.5 of [ITU-T G.9701] in the upstream direction. The valid values range from 1 to 100. The special value 0 indicates that monitoring of the percentage of degraded subcarriers is disabled. See clause 7.1.5.4 of [ITU-T G.997.2]. (R, W) (mandatory) (1 byte)

Downstream FRA number of uncorrectable DTU (FRA-RTXUCds): This attribute specifies the minimum number of rtx-uc anomalies received throughout a time window equal to FRA-TIMEds in order to arm the second FRA triggering criteria. See clause 13.3.1.1.1.5 of [ITU-T G.9701] in the downstream direction. The valid values range from 1 to 1023. The special value 0 indicates that monitoring of the number of rtx-uc anomalies is disabled. See clause 7.1.5.5 of [ITU-T G.997.2]. (R, W) (mandatory) (2 bytes)

Upstream FRA number of uncorrectable DTU (FRA-RTXUCus): This attribute specifies the minimum number of rtx-uc anomalies received throughout a time window equal to FRA-TIMEus in order to arm the second FRA triggering criteria. See clause 13.3.1.1.1.5 of [ITU-T G.9701] in the upstream direction. The valid values range from 1 to 1023. The special value 0 indicates that monitoring of the number of rtx-uc anomalies is disabled. See clause 7.1.5.6 of [ITU-T G.997.2]. (R, W) (mandatory) (2 bytes)

Downstream vendor discretionary FRA triggering criteria (FRA-VENDISCds): This Boolean attribute specifies whether vendor discretionary FRA triggering criteria may be used (enabled) or not (disabled) in the downstream direction. See clause 7.1.5.7 of [ITU-T G.997.2]. (R, W) (mandatory) (1 byte)

Upstream vendor discretionary FRA triggering criteria (FRA-VENDISCus): This Boolean attribute specifies whether vendor discretionary FRA triggering

criteria may be used (enabled) or not (disabled) in the upstream direction. See clause 7.1.5.8 of [ITU-T G.997.2]. (R, W) (mandatory) (1 byte)

Actions

Create, delete, get, set

Notifications

None.

9.7.52 FAST line configuration profile part 4

This ME extends the FAST line configuration MEs. An instance of this ME is created and deleted by the OLT.

Relationships

An instance of this ME may be associated with zero or more instances of an xDSL UNI.

The overall FAST line configuration profile is modelled in several parts, all of which are associated together through a common ME ID (the client PPTP xDSL UNI part 1 has a single pointer, which refers to the entire set of line configuration parts).

Attributes

Managed entity ID: This attribute uniquely identifies each instance of this ME. All FAST line configuration profiles and extensions that pertain to a given PPTP xDSL UNI must share a common ME ID. (R, set-by-create) (mandatory) (2 bytes)

Downstream los defect persistency (LOS_PERSISTENCYds): This attribute specifies the downstream los defect persistency for triggering a re-initialization (see clause 12.1.4.2 of [ITU-T G.9701]) at the FTU-R receiver, as part of the re-initialization policy. Valid values range from 1 (0.1 s) to 20 (2 s) in steps of 0.1 s. See clause 7.1.8.1 of [ITU-T G.997.2]. (R, W) (optional) (1 byte)

Upstream los defect persistency (LOS_PERSISTENCYus): This attribute specifies the upstream los defect persistency for triggering a re-initialization (see clause 12.1.4.2 of [ITU-T G.9701]) at the FTU-O receiver, as part of the re-initialization policy. Valid values range from 1 (0.1 s) to 20 (2 s) in steps of 0.1 s. See clause 7.1.8.2 of [ITU-T G.997.2]. (R, W) (optional) (1 byte)

Downstream lom defect persistency (LOM_PERSISTENCYds): This attribute specifies the downstream LOM defect persistency for triggering a re-initialization (see clause 12.1.4.2 of [ITU-T G.9701]) at the FTU-R receiver, as part of the re-initialization policy. Valid values range from 2 s to 20 s. See clause 7.1.8.3 of [ITU-T G.997.2]. (R, W) (optional) (1 byte)

Upstream lom defect persistency (LOM_PERSISTENCYus): This attribute specifies the upstream LOM defect persistency for triggering a re-initialization (see clause 12.1.4.2 of [ITU-T G.9701]) at the FTU-O receiver, as part of the re-initialization policy. Valid values range from 2 s to 20 s. See clause 7.1.8.4 of [ITU-T G.997.2]. (R, W) (optional) (1 byte)

Downstream lor defect persistency (LOR_PERSISTENCYds): This attribute specifies the downstream lor defect persistency for triggering a re-initialization (see clause 12.1.4.2 of [ITU-T G.9701]) at the FTU-R receiver, as part of the re-initialization policy. Valid values range from 1 (0.1 s) to 20 (2 s) in steps of 0.1 s. See clause 7.1.8.5 of [ITU-T G.997.2]. (R, W) (optional) (1 byte)

Upstream lor defect persistency (LOR_PERSISTENCY_{us}): This attribute specifies the upstream lor defect persistency for triggering a re-initialization (see clause 12.1.4.2 of [ITU-T G.9701]) at the FTU-O receiver, as part of the re-initialization policy. Valid values range from 1 (0.1 s) to 20 (2 s) in steps of 0.1 s. See clause 7.1.8.6 of [ITU-T G.997.2]. (R, W) (optional) (1 byte)

Downstream re-initialization time threshold (REINIT_TIME_THRESHOLD_{ds}): This attribute specifies the downstream threshold for the SES and eoc timeout conditions for declaring a High_BER event (see clause 12.1.4.3.4 of [ITU-T G.9701]) at the FTU-R receiver, as part of the re-initialization policy. Valid values range from 5 s to 30 s. See clause 7.1.8.7 of [ITU-T G.997.2]. (R, W) (optional) (1 byte)

Upstream re-initialization time threshold (REINIT_TIME_THRESHOLD_{us}): This attribute specifies the upstream threshold for the SES and eoc timeout conditions for declaring a High_BER event (see clause 12.1.4.3.4 of [ITU-T G.9701]) at the FTU-O receiver, as part of the re-initialization policy. Valid values range from 5 s to 31 s. See clause 7.1.8.8 of [ITU-T G.997.2]. (R, W) (optional) (1 byte)

Downstream low ETR threshold (LOW_ETR_THRESHOLD_{ds}): This attribute specifies the downstream threshold for the low ETR condition for declaring a High_BER event See clause 12.1.4.3.4) at the FTU-R receiver, as part of the re-initialization policy. Valid values range from 1 s to 30 s. The special value 0 indicates that no High_BER event is declared based on ETR being below the ETR_min. See clause 7.1.8.9 of [ITU-T G.997.2]. (R, W) (optional) (1 byte)

Upstream low ETR threshold (LOW_ETR_THRESHOLD_{us}): This attribute specifies the upstream threshold for the low ETR condition for declaring a High_BER event see clause 12.1.4.3.4) at the FTU-O receiver, as part of the re-initialization policy. Valid values range from 1 s to 30 s. The special value 0 indicates that no High_BER event is declared based on ETR being below the ETR_min. See clause 7.1.8.10 of [ITU-T G.997.2]. (R, W) (optional) (1 byte)

Actions

Create, delete, get, set

Notifications

None.

9.7.53 FAST channel configuration profile

This ME contains the FAST channel configuration profile for an xDSL UNI. An instance of this ME is created and deleted by the OLT.

Relationships

An instance of this ME may be associated with zero or more instances of the PPTP xDSL UNI part 1.

Attributes

Maximum net data rate (MAXNDR): This attribute specifies the value of the maximum net data rate. See clause 11.4.2.2 of [ITU-T G.9701]. Valid values range from 0 (0 kbit/s) to 4294967295 ($2^{32}-1$ kbit/s). See clause 7.2.1.1 of [ITU-T G.997.2]. (R, W) (mandatory) (4 bytes)

Minimum expected throughput (MINETR): This attribute specifies the value of the minimum expected throughput. See clause 11.4.2.1 of [ITU-T G.9701]. Valid values range from 0 (0 kbit/s) to 4294967295 ($2^{32}-1$ kbit/s). See clause 7.2.1.2 of [ITU-T G.997.2]. (R, W) (mandatory) (4 bytes)

Maximum gamma data rate (MAXGDR): This attribute specifies the maximum value of the GDR (see clause 7.11.1.3). The GDR shall not exceed MAXGDR at the start of showtime and during showtime. Valid values range from 0 (0 kbit/s) to 4294967295 ($2^{32}-1$ kbit/s). See clause 7.2.1.3 of [ITU-T G.997.2]. (R, W) (mandatory) (4 bytes)

Minimum gamma data rate (MINGDR): This attribute specifies the minimum value of the GDR (see clause 7.11.1.3). The GDR may be lower than MINGDR. If the GDR is lower than MINGDR at initialization or when GDR becomes lower than MINGDR during showtime, a TCA occurs. Valid values range from 0 (0 kbit/s) to 4294967295 ($2^{32}-1$ kbit/s). See clause 7.2.1.4 of [ITU-T G.997.2]. (R, W) (mandatory) (4 bytes)

Maximum delay (DELAYMAX): This attribute specifies the maximum allowed delay for retransmission. See clause 9.8 of [ITU-T G.9701]. The ITU-T G.9701 control parameter `delay_max` is set to the same value as the maximum delay. See clause 11.4.2.3 of [ITU-T G.9701]. Valid values range from 4 (1 ms) to 252 (63 ms) in steps of 0.25 ms. See clause 7.2.2.1 of [ITU-T G.997.2]. (R, W) (mandatory) (4 bytes)

Minimum impulse noise protection against SHINE (INPMIN_SHINE): This attribute specifies the minimum INP against SHINE. See clause 9.8 of [ITU-T G.9701]. The ITU-T G.9701 control parameter `INP_min_shine` is set to the same value as the minimum INP against SHINE. See clause 11.4.2.4 of [ITU-T G.9701]. Valid values range from 0 to 520 (520 symbol periods). See clause 7.2.2.2 of [ITU-T G.997.2]. (R, W) (mandatory) (2 bytes)

SHINE ratio (SHINERATIO): This attribute specifies the SHINE ratio that is used in the definition of the expected throughput rate (ETR). See clause 9.8 of [ITU-T G.9701]. The ITU-T G.9701 control parameter `SHINERatio` is set to the same value as the SHINE ratio. See clause 11.4.2.5 of [ITU-T G.9701]. The value is expressed in units of 0.001, Valid values range from 0 to 100 (0.01) in steps of 0.001. See clause 7.2.2.3 of [ITU-T G.997.2]. (R, W) (mandatory) (1 byte)

Minimum impulse noise protection against REIN (INPMIN_REIN): This attribute specifies the minimum INP against REIN. See clause 9.8 of [ITU-T G.9701]. The ITU-T G.9701 control parameter `INP_min_rein` is set to the same value as the minimum INP against REIN. See clause 11.4.2.6 of [ITU-T G.9701]. Valid values range from 0 to 63 (63 symbol periods). See clause 7.2.2.4 of [ITU-T G.997.2]. (R, W) (mandatory) (1 byte)

REIN Inter-arrival time (IAT_REIN): This attribute specifies the REIN IAT. See clause 9.8 of [ITU-T G.9701]. The ITU-T G.9701 control parameter `iat_rein_flag` is set to the same value as the REIN IAT. See clause 11.4.2.7 of [ITU-T G.9701].

The REIN IAT is specified via the following values:

- 1 100 Hz;
- 2 120 Hz;
- 3 360 Hz.

See clause 7.2.2.5 of [ITU-T G.997.2].

(R, W) (mandatory) (1 byte)

Minimum Reed-Solomon RFEC/NFEC ratio (RNRATIO): This attribute specifies the minimal required ratio, RFEC/NFEC, of Reed-Solomon code parameters. The ITU-T G.9701 control parameter rnratio is set to the same value as the minimum Reed-Solomon RFEC/NFEC ratio. See clause 11.4.2.8 of [ITU-T G.9701]. The value is expressed in units of 1/32, Valid values range from 0 to 8 (1/4). See clause 7.2.2.6 of [ITU-T G.997.2]. (R, W) (mandatory) (1 byte)

RTX-TC testmode (RTX_TESTMODE): This Boolean attribute specifies whether the retransmission test mode defined in clause 9.8.3.1.2 [ITU-T G.9701] is enabled (true) or disabled (disabled). See clause 7.2.2.7 of [ITU-T G.997.2]. (R, W) (optional) (1 byte)

Actions

Create, delete, get, set

Notifications

None.

9.7.54 FAST data path configuration profile

This ME contains FAST the data path configuration profile for an xDSL UNI. An instance of this ME is created and deleted by the OLT.

Relationships

An instance of this ME may be associated with zero or more instances of the PPTP xDSL UNI part 1.

Attributes

Managed entity ID: This attribute uniquely identifies each instance of this ME. The value 0 is reserved. (R, set-by-create) (mandatory) (2 bytes)

TPS-TC testmode (TPS_TESTMODE): This Boolean attribute specifies whether the TPS-TC test mode defined in clause 8.3.1 [ITU-T G.9701] is enabled (true) or disabled (disabled). See clause 7.3.1 of [ITU-T G.997.2]. (R, W) (mandatory) (1 byte)

Actions

Create, delete, get, set

Notifications

None.

9.7.55 FAST vectoring line configuration extensions

This ME extends FAST line configuration MEs with attributes that are specific to vectoring. An instance of this ME is created and deleted by the OLT.

Relationships

An instance of this ME may be associated with zero or more instances of an xDSL UNI.

The overall FAST line configuration MEs is modelled in several parts, all of which are associated together through a common ME ID (the client PPTP xDSL UNI part 3 has a single pointer, which refers to the entire set of line configuration parts).

Attributes

Managed entity ID: This attribute uniquely identifies each instance of this ME. The value 0 is reserved. (R, set-by-create) (mandatory) (2 bytes)

FEXT cancellation enabling/disabling upstream (FEXT_TO_CANCEL_ENABLEUs): A value of 1 enables and a value of 0 disables FEXT cancellation in the upstream direction from all the other vectored lines into the line in the vectored group. See clause 7.1.7.2 of [ITU-T G.997.2]. (R, W) (mandatory) (1 byte)

FEXT cancellation enabling/disabling downstream (FEXT_TO_CANCEL_ENABLEds): A value of 1 enables and a value of 0 disables FEXT cancellation in the downstream direction from all the other vectored lines into the line in the vectored group. See clause 7.1.7.1 of [ITU-T G.997.2]. (R, W) (mandatory) (1 byte)

Actions

Create, delete, get, set

Notifications

None.

9.7.56 FAST line inventory and status data

This ME extends the FAST line inventory and status data MEs with attributes specific to [ITU-T G.997.2]. The ONU automatically creates or deletes an instance of this ME upon the creation or deletion of a PPTP xDSL UNI part 1.

Relationships

This is one of the status data MEs associated with an xDSL UNI. It is required only if FAST is supported by the PPTP. The ONU automatically creates or deletes an instance of this ME upon creation or deletion of a PPTP xDSL UNI part 1 that supports these attributes.

Attributes

Managed entity ID: This attribute uniquely identifies each instance of this ME. Through an identical ID, this ME is implicitly linked to an instance of the PPTP xDSL UNI part 1. (R) (mandatory) (2 bytes)

ITU-T G.9701 profile (PROFILE): This attribute reports for each profile whether operation according to that profile is enabled (0) or disabled (1). Only one profile can be enabled. See clause 7.10.1.1 of [ITU-T G.997.2] (R) (mandatory) (1 byte)

Gamma data rate (GDR): This attribute reports the net data rate as defined in clause 7.11.1.1, lowered by any throughput capability limitations remaining in the DRA or L2+ functions, assuming no user data are transmitted over all the other lines. Valid values range from 0 (0 kbit/s) to 4294967295 ($2^{32}-1$ kbit/s). See clause 7.11.1.3 of [ITU-T G.997.2] (R) (mandatory) (bytes)

Attainable gamma data rate (ATTGDR): This attribute reports the attainable net data rate (as defined in clause 7.11.2.1), lowered by any throughput capability limitations remaining in the DRA or L2+ functions, assuming no user data are transmitted over all the other Lines, and assuming MAXGDR (as defined in clause 7.2.1.3) is configured to its maximum valid value. Valid values range from 0 (0 kbit/s) to 4294967295 ($2^{32}-1$ kbit/s). See clause 7.11.2.3 of [ITU-T G.997.2] (R) (mandatory) (bytes)

DPU system vendor ID (DPU_SYSTEM_VENDOR): This attribute reports the DPU system vendor ID as inserted by the FTU-O in the embedded operations channel (see clause 11.2.2.10 of [ITU-T G.9701]) and as defined in clause 9.3.3.1 of [ITU-T G.994.1]. See clause 7.13.2.1 of [ITU-T G.997.2] (R) (optional) (8 bytes)

NT system vendor ID (NT_SYSTEM_VENDOR): This attribute reports the NT system vendor ID as inserted by the FTU-R in the embedded operations channel (see clause 11.2.2.10 of [ITU-T G.9701]) and as defined in clause 9.3.3.1 of [ITU-T G.994.1]. See clause 7.13.2.2 of [ITU-T G.997.2] (R) (optional) (8 bytes)

DPU serial number (DPU_SYSTEM_SERIALNR): This attribute reports the DPU serial number as inserted by the FTU-O in the embedded operations channel. See clause 11.2.2.10 of [ITU-T G.9701]. It is vendor-specific information. The combination of DPU system vendor ID and DPU system serial number creates a unique number for each DPU. See clause 7.13.2.3 of [ITU-T G.997.2] (R) (optional) (32 bytes)

NT serial number (NT_SYSTEM_SERIALNR): This attribute reports the NT system serial number as inserted by the FTU-R in the embedded operations channel. See clause 11.2.2.10 of [ITU-T G.9701]. It shall contain the NT system serial number, the NT model and the NT firmware version. All shall be encoded in this order and separated by space characters, i.e., "<NT serial number><space><NT model><space><NT firmware version>". The combination of NT system vendor ID and NT system serial number creates a unique number for each NT. See clause 7.13.2.4 of [ITU-T G.997.2] (R) (optional) (32 bytes)

Actions

Get

Notifications

None.

9.7.57 FAST line inventory and status data part 2

This ME contains part 3 of the FAST line inventory and status data with attributes specific to [ITU T G.997.2]. The ONU automatically creates or deletes an instance of this ME upon the creation or deletion of a PPTP xDSL UNI part 1.

Relationships

This is one of the status data MEs associated with an xDSL UNI. It is required only if FAST is supported by the PPTP. The ONU automatically creates or deletes an instance of this ME upon creation or deletion of a PPTP xDSL UNI part 1 that supports these attributes.

Attributes

Managed entity ID: This attribute uniquely identifies each instance of this ME. Through an identical ID, this ME is implicitly linked to an instance of the PPTP xDSL UNI part 1. (R) (mandatory) (2 bytes)

Date/time-stamping of last successful downstream FRA operation (STAMP-FRAd): This attribute reports the date/time of the last successful FTU-R initiated FRA execution that has modified the bits allocation. See clause 7.10.14.5 of [ITU-T G.997.2]. The format of this parameter is as follows:

Year	2 bytes
Month	1 byte (1..12)
Day	1 byte (1..31)
Hour	1 byte (0..23)
Minute	1 byte (0..59)
Second	1 byte (0..59)

(R) (optional) (7 bytes)

Date/time-stamping of last successful upstream FRA operation (STAMP-FRAus): This parameter reports the date/time of the last successful FTU-O initiated FRA execution that has modified the bits allocation. See clause 7.10.14.6 of [ITU-T G.997.2]. The format of this parameter is the same as STAMP-TEST-NE. (R) (optional) (7 bytes)

Date/time-stamping of last successful downstream RPA operation (STAMP-RPAds): This parameter reports the date/time of the last successful FTU-R initiated RPA execution that has modified the bits allocation for the RMC. See clause 7.10.14.7 of [ITU-T G.997.2]. The format of this parameter is the same as STAMP-TEST-NE. (R) (optional) (7 bytes)

Date/time-stamping of last successful upstream RPA operation (STAMP-RPAus): This parameter reports the date/time of the last successful FTU-O initiated RPA execution that has modified the bits allocation for the RMC. See clause 7.10.14.8 of [ITU-T G.997.2]. The format of this parameter is the same as STAMP-TEST-NE. (R) (optional) (7 bytes)

Date/time-stamping of last successful downstream TIGA operation (STAMP-TIGA): This parameter reports the date/time of the last successful FTU-O initiated TIGA execution. See clause 7.10.14.9 of [ITU-T G.997.2]. The format of this parameter is the same as STAMP-TEST-NE. (R) (optional) (7 bytes)

Actions

Get

Notifications

None.

9.7.58 FAST xTU-C performance monitoring history data

This ME collects PM data on the xTU C to xTU R path as seen from the xTU-C. Instances of this ME are created and deleted by the OLT.

Relationships

An instance of this ME is associated with an xDSL UNI.

Attributes

Managed entity ID: This attribute uniquely identifies each instance of this ME. Through an identical ID, this ME is implicitly linked to an instance of the PPTP xDSL UNI part 1. (R, set-by-create) (mandatory) (2 bytes)

Interval end time: This attribute identifies the most recently finished 15 min interval. (R) (mandatory) (1 byte)

Threshold data 1/2 ID: This attribute points to an instance of the threshold data 1 and 2 MEs that contain PM threshold values. (R, W, set-by-create) (mandatory) (2 bytes)

Successful FRA counter: This attribute counts the successful FRA primitives (success_FRA). The successful FRA primitive (success_FRA) is defined in clause 11.3.1.6 of [ITU-T G.9701]. See clause 7.7.22 of [ITU-T G.997.2]. (R) (mandatory) (4 bytes)

Successful RPA counter: This attribute counts the successful RPA primitives (success_RPA). The successful RPA primitive (success_RPA) is defined in clause 11.3.1.6 of [ITU-T G.9701]. See clause 7.7.23 of [ITU-T G.997.2] (R) (optional) (4 bytes)

Successful TIGA counter: This attribute counts the successful TIGA primitives (success_TIGA). The successful TIGA primitive (success_TIGA) is defined in clause 11.3.1.6 of [ITU-T G.9701]. Reported only with the near-end measured time, invalid data flag and timestamp. See clause 7.7.24 of [ITU-T G.997.2] (R) (optional) (4 bytes)

Actions

Create, delete, get, set

Notifications

None.

9.7.59 FAST xTU-R performance monitoring history data

This ME collects PM data of the xTU C to xTU R path as seen from the xTU-R. Instances of this ME are created and deleted by the OLT. For a complete discussion of generic PM architecture, refer to clause I.4.

Relationships

An instance of this ME is associated with an xDSL UNI.

Attributes

Managed entity ID: This attribute uniquely identifies each instance of this ME. Through an identical ID, this ME is implicitly linked to an instance of the PPTP xDSL UNI part 1. (R, set-by-create) (mandatory) (2 bytes)

Interval end time: This attribute identifies the most recently finished 15 min interval. (R) (mandatory) (1 byte)

Threshold data 1/2 ID: This attribute points to an instance of the threshold data 1 and 2 MEs that contain PM threshold values. (R, W, set-by-create) (mandatory) (2 bytes)

Successful FRA counter: This attribute counts the successful FRA primitives (success_FRA). The successful FRA primitive (success_FRA) is defined in clause 11.3.1.6 of [ITU-T G.9701]. See clause 7.7.22 of [ITU-T G.997.2] (R) (mandatory) (4 bytes)

Successful RPA counter: This attribute counts the successful RPA primitives (success_RPA). The successful RPA primitive (success_RPA) is defined in clause 11.3.1.6 of [ITU-T G.9701]. See clause 7.7.23 of [ITU-T G.997.2] (R) (optional) (4 bytes)

Actions

Create, delete, get, set

9.8 Time division multiplex services

This clause defines MEs associated with CES UNIs, as shown in Figure 9.8-1.

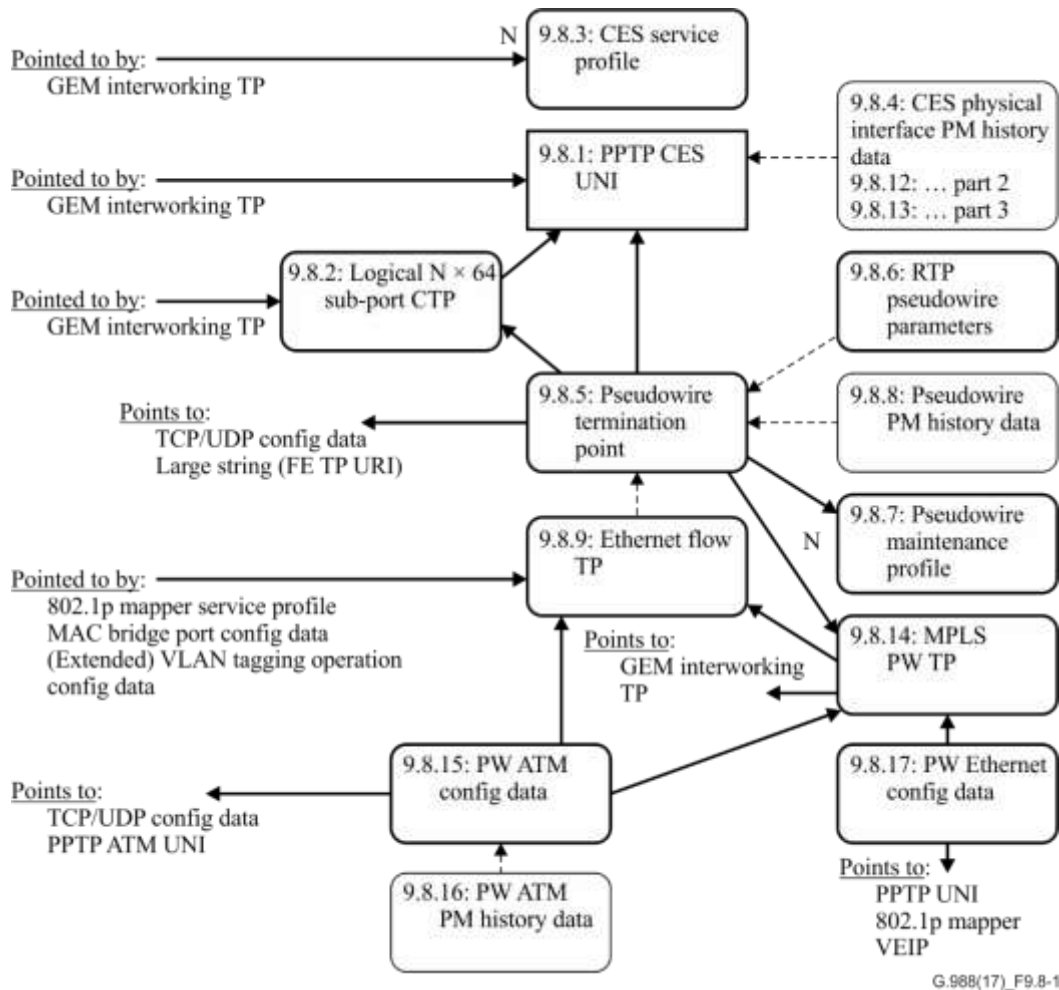

Figure 9.8-1 – Managed entities associated with TDM services

9.8.1 Physical path termination point CES UNI

This ME represents the point at a CES UNI in the ONU where the physical path terminates and physical level functions are performed.

The ONU automatically creates an instance of this ME per port:

- when the ONU has CES ports built into its factory configuration;
- when a cardholder is provisioned to expect a circuit pack of a CES type;
- when a cardholder provisioned for plug-and-play is equipped with a circuit pack of a CES type. Note that the installation of a plug-and-play card may indicate the presence of CES ports via equipment ID as well as its type and indeed may cause the ONU to instantiate a port-mapping package that specifies CES ports.

The ONU automatically deletes instances of this ME when a cardholder is neither provisioned to expect a CES circuit pack, nor is it equipped with a CES circuit pack.

Relationships

An instance of this ME is associated with each real or pre-provisioned CES port. It can be linked from a GEM IW TP, a pseudowire TP or a logical $N \times 64$ kbit/s CTP.

Attributes

Managed entity ID: This attribute uniquely identifies each instance of this ME. This 2 byte number indicates the physical position of the UNI. The first byte is the slot ID (defined in clause 9.1.5). The second byte is the port ID, with the range 1..255. (R) (mandatory) (2 bytes)

Expected type: The following coding is used for this attribute-

- 0 Autosense
- 1 to 254 One of the values from Table 9.1.5-1 that is compatible with a CES circuit pack

Upon ME instantiation, the ONU sets this attribute to 0. (R, W) (mandatory) (1 byte)

Sensed type: If the value of expected type is not 0, then the value of sensed type equals the value of expected type. If expected type = 0, then the value of sensed type is one of the compatible values from Table 9.1.5-1. Upon ME instantiation, the ONU sets this attribute to 0 or to the value that reflects the physically present equipment. (R) (mandatory if the ONU supports circuit packs with configurable interface types, e.g., C1.5/2/6.3) (1 byte)

CES loopback configuration: This attribute specifies and reports the loopback configuration of the physical interface.

- 0 No loopback
- 1 Payload loopback
- 2 Line loopback
- 3 Operations system-directed (OS-directed) loopback 1 (loopback from/to PON side)
- 4 OS-directed loopback 2 (loopback from/to CES UNI side)
- 5 OS-directed loopback 3 (loopback of both PON side and CES UNI side)
- 6 Manual button-directed loopback [read only (RO)]
- 7 Network-side code inband-directed loopback (RO)
- 8 SmartJack-directed loopback (RO)
- 9 Network-side code inband-directed loopback (armed; RO)
- 10 Remote-line loopback via facility data link (FDL)
- 11 Remote-line loopback via inband code
- 12 Remote-payload loopback

Upon ME instantiation, the ONU sets this attribute to 0. (R, W) (mandatory) (1 byte)

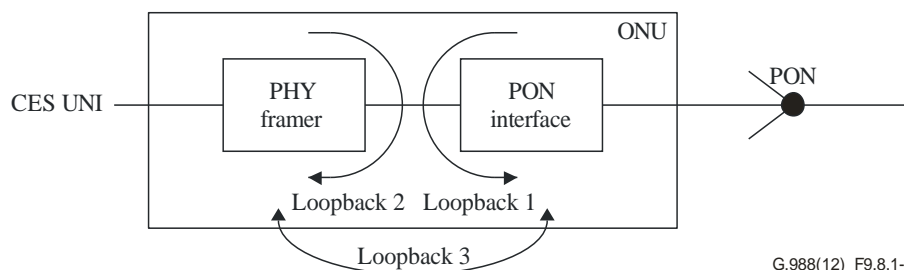

Figure 9.8.1-1 – CES loopback configuration

Administrative state: This attribute locks (1) and unlocks (0) the functions performed by this ME. Administrative state is further described in clause A.1.6. (R, W) (mandatory) (1 byte)

Operational state: This attribute indicates whether the ME is capable of performing its function. Valid values are enabled (0) and disabled (1). (R) (optional) (1 byte)

Framing: This attribute specifies the framing structure.

These code points are for use with DS1 services. Code point 2 may also be used for an unframed E1 service.

- 0 Extended superframe
- 1 Superframe
- 2 Unframed
- 3 ITU-T G.704

NOTE – [ITU-T G.704] describes both SF and ESF framing for DS1 signals. This code point is retained for backward compatibility, but its meaning is undefined.

- 4 JT-G.704

The following code points are for use with E1 services.

- 5 Basic framing: clause 2.3.2 of [ITU-T G.704]
- 6 Basic framing with CRC-4: clause 2.3.3 of [ITU-T G.704]
- 7 Basic framing with TS16 multiframe
- 8 Basic framing with CRC-4 and TS16 multiframe

Upon ME instantiation, the ONU sets this attribute to a value that reflects the vendor's default. (R, W) (optional) (1 byte)

Encoding: This attribute specifies the line coding scheme. Valid values are as follows.

- 0 B8ZS
- 1 AMI
- 2 HDB3
- 3 B3ZS

Upon ME instantiation, the ONU sets this attribute to 0. (R, W) (mandatory for DS1 and DS3 interfaces) (1 byte)

Line length: This attribute specifies the length of the twisted pair cable from a DS1 physical UNI to the DSX-1 cross-connect point or the length of coaxial cable from a DS3 physical UNI to the DSX-3 cross-connect point. Valid values are given in Table 9.8.1-1. Upon ME instantiation for a DS1 interface, the ONU assigns the value 0 for non-power feed type DS1 and the value 6 for power feed type DS1. Upon ME instantiation for a DS3 interface, the ONU sets this attribute to 0x0F. (R, W) (optional) (1 byte)

DS1 mode: This attribute specifies the mode of a DS1. Valid values are as follows.

Value	Mode	Connect	Line length	Power	Loopback
0	No.1	DS1 CPE	Short haul	No power feed	Smart jack
1	No.2	DS1 CPE	Long haul	No power feed	Smart jack
2	No.3	DS1 NIU CPE	Long haul	No power feed	Intelligent office repeater. Transparent to FDL.
3	No.4	DS1 NIU CPE	Long haul	With power feed	Intelligent office repeater. Transparent to FDL.

In the event of conflicting values between this attribute and the (also optional) line length attribute, the line length attribute is taken to be valid. This permits the separation of line build-out (LBO) and power settings from smart jack and

FDL behaviour. Upon ME instantiation, the ONU sets this attribute to 0. (R, W) (optional) (1 byte)

ARC: See clause A.1.4.3. (R, W) (optional) (1 byte)

ARC interval: See clause A.1.4.3. (R, W) (optional) (1 byte)

Line type: This attribute specifies the line type used in a DS3 or E3 application or when the sensed type of the PPTP is configurable. Valid values are as follows.

- 0 Other
- 1 ds3 m23
- 2 ds3 syntran
- 3 ds3 Cbit parity
- 4 ds3 clear channel
- 5 e3 framed
- 6 e3 plcp
- 7 DS1
- 8 E1
- 9 J1

(R, W) (mandatory for DS3, E3 and multi-configuration interfaces, not applicable to other interfaces) (1 byte)

Actions

Get, set

Notifications

Attribute value change

Number	Attribute value change	Description
1	N/A	
2	Sensed type	Sensed circuit pack type (value from Table 9.1.5-1)
3	CES loopback config	Loopback configuration of physical interface
4	N/A	
5	Op state	Operational state
6..9	N/A	
10	ARC	ARC timer expiration
11..12	N/A	
13..16	Reserved	

Alarms should be declared and cleared according to criteria defined separately in existing TDM standards.

Alarm

Alarm number	Alarm	Description
0	TF	Transmitter failure
1	LOS	Loss of signal
2	LOF	Loss of frame
3	OOF	Out of frame
4	RAI	Remote alarm indication
5	1.5 M BAIS	1.544 Mbit/s back alarm indication signal

Alarm

Alarm number	Alarm	Description
6	R-INH	Receive alarm inhibit
7	6M REC	6.312 Mbit/s receive alarm
8	6M SEND	6.312 Mbit/s send alarm
9	6M ERR	6.312 Mbit/s block error
10	6M BERR	6.312 Mbit/s back error
11	34M REC	34.368 Mbit/s receive alarm
12	34M AIS	34.368 Mbit/s alarm indication signal
13	2M REC	2.048 Mbit/s receive alarm
14	2M AIS	2.048 Mbit/s alarm indication signal
15	1.5M REC	1.544 Mbit/s receive alarm
16	1.5 AIS	1.544 Mbit/s alarm indication signal
17	INFO0	INFO0 reception (INFO0)
18	45M RDI	44.736 Mbit/s remote defect indication
19	45M AIS	44.736 Mbit/s alarm indication signal
20	AIS-CI	Refer to [b-ATIS-0300231]
21	DS1 idle	Refer to [b-ATIS-0600403]
22	RAI-CI	Refer to [b-ATIS-0300231]
23..207	Reserved	
208..223	Vendor-specific alarms	Not to be standardized

Table 9.8.1-1– Values for the line length attribute

Value	Power feed	Line length
0x00	Non-power feed type DS1	0..33.5 m (0..110 ft)
0x01	Non-power feed type DS1	33.5..67.1 m (110..220 ft)
0x02	Non-power feed type DS1	67.1..100.6 m (220..330 ft)
0x03	Non-power feed type DS1	100.6..134.1 m (330..440 ft)
0x04	Non-power feed type DS1	134.1..167.6 m (440..550 ft)
0x05	Non-power feed type DS1	167.6..201.2 m (550..660 ft)
0x06	Power feed type DS1 (Wet T1), short haul	0..40.5 m (0..133 ft)
0x07	Power feed type DS1 (Wet T1), short haul	40.5..81.1 m (133..266 ft)
0x08	Power feed type DS1 (Wet T1), short haul	81.1..121.6 m (266..399 ft)
0x09	Power feed type DS1 (Wet T1), short haul	121.6..162.5 m (399..533 ft)
0x0A	Power feed type DS1 (Wet T1), short haul	162.5..199.6 m (533..655 ft)
0x0B	Power feed type DS1 (Wet T1), long haul	0 dB
0x0C	Power feed type DS1 (Wet T1), long haul	7.5 dB
0x0D	Power feed type DS1 (Wet T1), long haul	15 dB
0x0E	Power feed type DS1 (Wet T1), long haul	22.5 dB

Table 9.8.1-1– Values for the line length attribute

Value	Power feed	Line length
0x0F	DS3 power feed	0..68.6 m (0..225 ft)
0x10	DS3 power feed	68.6..137.2 m (225..450 ft)

9.8.2 Logical $N \times 64$ kbit/s sub-port connection termination point

This ME models a logical sub-port contained within a higher level TDM physical layer interface (e.g., a group of DS0s within a DS1, a DS1 within a DS3, etc.). An instance of this ME can represent an arbitrary (i.e., consecutive or non-consecutive) group of multiple channels/time slots (e.g., multiple DS0/DS1) as an integral bundle.

Relationships

Zero or more instances of this ME are associated with an instance of the PPTP CES UNI. It can be linked from a pseudowire TP.

Attributes

Managed entity ID: This attribute uniquely identifies each instance of this ME. (R, set-by-create) (mandatory) (2 bytes)

Physical path termination pointer: This attribute points to the corresponding PPTP CES UNI ME instance. (R, W, set-by-create) (mandatory) (2 bytes)

List of time slots: This attribute is a bit map that indicates time slots or component tributaries. Each bit indicates whether the corresponding time slot is included in the connection (1) or not (0). Figure 9.8.2-1 shows the correspondence. (R, W, set-by-create) (mandatory) (12 bytes)

Byte	Bit							
	8 (MSB)	7	6	5	4	3	2	1
1	TS 0	TS 1	TS 2	TS 3	TS 4	TS 5	TS 6	TS 7
2	TS 8	TS 9	TS 10	TS 11	TS 12	TS 13	TS 14	TS 15
...								
12	TS 88	TS 89	TS 90	TS 91	TS 92	TS 93	TS 94	TS 95

Figure 9.8.2-1 – Mapping of time slots

Actions

Create, delete, get, set

Notifications

None.

9.8.3 CES service profile

NOTE – In [ITU-T G.984.4], this ME is called a CES service profile-G.

An instance of this ME organizes data that describe the CES service functions of the ONU. Instances of this ME are created and deleted by the OLT.

Relationships

An instance of this ME may be associated with zero or more instances of a GEM IW TP.

Attributes

Managed entity ID: This attribute uniquely identifies each instance of this ME. (R, set-by-create) (mandatory) (2 bytes)

CES buffered CDV tolerance: This attribute represents the duration of user data that must be buffered by the CES IW entity to offset packet delay variation. It is expressed in 10 μ s increments. 75 (750 μ s) is suggested as a default value. (R, W, set-by-create) (mandatory) (2 bytes)

Channel associated signalling (CAS): This attribute selects the signalling format. It applies to structured interfaces only. For unstructured interfaces, this value, if present, must be set to the default 0. Valid values are as follows.

- 0 Basic
- 1 E1 CAS
- 2 SF CAS
- 3 DS1 ESF CAS
- 4 J2 CAS

(R, W, set-by-create) (optional) (1 byte)

Actions

Create, delete, get, set

Notifications

None.

9.8.4 CES physical interface performance monitoring history data

This ME collects statistics for a CES physical interface. Interfaces include DS1, E1, J1, J2 and possibly others. The performance management requirements of particular interfaces are described in the corresponding ITU-T or other standards document, e.g., [ITU-T G.784] or [b-ATIS-0300231].

Instances of this ME are created and deleted by the OLT.

For a complete discussion of generic PM architecture, refer to clause I.4.

Relationships

An instance of this ME is associated with one instance of the PPTP CES UNI.

Attributes

Managed entity ID: This attribute uniquely identifies each instance of this ME. Through an identical ID, this ME is implicitly linked to an instance of the PPTP CES UNI. (R, set-by-create) (mandatory) (2 bytes)

Interval end time: This attribute identifies the most recently finished 15 min interval. (R) (mandatory) (1 byte)

Threshold data 1/2 ID: This attribute points to an instance of the threshold data 1 ME that contains PM threshold values. Since no mandatory threshold value attribute number exceeds 7, a threshold data 2 ME is optional. (R, W, set-by-create) (mandatory) (2 bytes)

Errored seconds: When a detailed distinction needs to be made, this attribute corresponds to near-end line errored seconds, ES-L, also known as LES. (R) (mandatory) (2 bytes)

Severely errored seconds: When a detailed distinction needs to be made, this attribute corresponds to near-end line severely errored seconds, SES-L. (R) (mandatory) (2 bytes)

Burst errored seconds: A burst errored second (BES) is any second that is not an unavailable second (UAS), that contains between 2 and 319 error events but no LOS, AIS or OOF condition. This attribute is also known as ESB-P. (R) (optional) (2 bytes)

Unavailable seconds: When a detailed distinction needs to be made, this attribute corresponds to near-end path unavailable seconds, UAS-P. (R) (mandatory) (2 bytes)

Controlled slip seconds: When a detailed distinction needs to be made, this attribute corresponds to near-end path controlled slip seconds CSS-P. (R) (mandatory) (2 bytes)

Each of the following attributes is (R) (optional) (2 bytes)

Attribute name	Common acronym
Loss of signal seconds	LOSS-L
AIS seconds	AISS-P
Errored seconds, path	ES-P
Errored seconds, type A	ESA-P
Severely errored seconds, path	SES-P
Severely errored frame and AIS seconds	SAS-P aka SEFS
Code violations, line	CV-L aka LCV
Code violations, path	CV-P aka PCV
Errored blocks (see [ITU-T G.826])	EB

Actions

Create, delete, get, set

Get current data (optional)

Notifications

Threshold crossing alert

Alarm number	Threshold crossing alert	Threshold value attribute No. (Note)
0	ES	1
1	SES	2
2	BES	3
3	UAS	4
4	CSS	5
5	LOSS-L	6
6	AISS-P	7
7	ES-P	8

Threshold crossing alert

Alarm number	Threshold crossing alert	Threshold value attribute No. (Note)
8	ESA-P	9
9	SES-P	10
10	SAS-P	11
11	CV-L	12
12	CV-P	13
13	EB	14

NOTE – This number associates the TCA with the specified threshold value attribute of the threshold data 1/2 managed entities.

9.8.5 Pseudowire termination point

The pseudowire TP supports packetized (rather than TDM) transport of TDM services, transported either directly over Ethernet, over UDP/IP or over MPLS. Instances of this ME are created and deleted by the OLT.

Relationships

One pseudowire TP ME exists for each distinct TDM service that is mapped to a pseudowire.

Attributes

Managed entity ID: This attribute uniquely identifies each instance of this ME. (R, set-by-create) (mandatory) (2 bytes)

Underlying transport:

- 0 Ethernet, MEF 8
- 1 UDP/IP
- 2 MPLS

(R, W, set-by-create) (mandatory) (1 byte)

Service type: This attribute specifies the basic service type, either a transparent bit pipe or an encapsulation that recognizes the underlying structure of the payload.

- 0 Basic unstructured (also known as structure agnostic)
- 1 Octet-aligned unstructured, structure agnostic. Applicable only to DS1, a mode in which each frame of 193 bits is encapsulated in 25 bytes with 7 padding bits.
- 2 Structured (structure-locked)

(R, W, set-by-create) (mandatory) (1 byte)

Signalling:

- 0 No signalling visible at this layer
- 1 CAS, to be carried in the same packet stream as the payload
- 2 CAS, to be carried in a separate signalling channel

(R, W, set-by-create) (mandatory for structured service type) (1 byte)

TDM UNI pointer: If service type = structured, this attribute points to a logical $N \times 64$ kbit/s sub-port CTP. Otherwise, this attribute points to a PPTP CES UNI. (R, W, set-by-create) (mandatory) (2 bytes)

North-side pointer: When the pseudowire service is transported via IP, as indicated by the underlying transport attribute, the north-side pointer attribute points to an instance of the TCP/UDP config data ME. When the pseudowire service is

transported directly over Ethernet, the north-side pointer attribute is not used – the linkage to the Ethernet flow TP is implicit in the ME IDs. When the pseudowire service is transported over MPLS, the north-side pointer attribute points to an instance of the MPLS PW TP. (R, W, set-by-create) (mandatory) (2 bytes)

Far-end IP info: When the pseudowire service is transported via IP, this attribute points to a large string ME that contains the URI of the far-end TP, e.g.,

```
udp://192.168.100.221:5000
udp://pwe3srvr.int.example.net:2222
```

A null pointer is appropriate if the pseudowire is not transported via IP. (R, W, set-by-create) (mandatory for IP transport) (2 bytes)

Payload size: Number of payload bytes per packet. Valid only if service type = basic unstructured or octet-aligned unstructured. Valid choices depend on the TDM service, but must include the following. Other choices are at the vendor's discretion.

```
DS1 192
DS1 200, required only if an octet-aligned unstructured service is
supported
E1 256
DS3 1024
E3 1024
```

(R, W, set-by-create) (mandatory for unstructured service) (2 bytes)

Payload encapsulation delay: Number of 125 μ s frames to be encapsulated in each pseudowire packet. Valid only if service type = structured. The minimum set of choices for various TDM services is listed in the following table, and is affected by the possible presence of in-band signalling. Other choices are at the vendor's discretion.

Payload encapsulation delay	Payload type
64 required (8 ms), 40 desired (5 ms)	NxDS0, no signalling, N = 1
32 (4 ms)	NxDS0, no signalling, N = 2..4
8 (1 ms)	NxDS0, no signalling, N > 4
24 (3 ms)	NxDS0 with DS1 CAS
16 (2 ms)	NxDS0 with E1 CAS

(R, W, set-by-create) (mandatory for structured service) (1 byte)

Timing mode: This attribute selects the timing mode of the TDM service. If RTP is used, this attribute must be set to be consistent with the value of the RTP timestamp mode attribute in the RTP pseudowire parameters ME, or its equivalent, at the far end.

```
0 Network timing (default)
1 Differential timing
2 Adaptive timing
3 Loop timing: local TDM transmit clock derived from local TDM
receive stream
```

(R, W) (mandatory) (1 byte)

Transmit circuit ID: This attribute is a pair of emulated circuit ID (ECID) values that the ONU transmits in the direction from the TDM termination towards the packet-switched network (PSN). MEF 8 ECIDs lie in the range 1..1048575 ($2^{20} - 1$). To allow for the possibility of other transport (L2TP) in the future, each ECID is allocated 4 bytes.

The first value is used for the payload ECID; the second is used for the optional separate signalling ECID. The first ECID is required for all MEF 8 pseudowires; the second is required only if signalling is to be carried in a distinct channel. If signalling is not present, or is carried in the same channel as the payload, the second ECID should be set to 0.

(R, W) (mandatory for MEF 8 transport) (8 bytes)

Expected circuit ID: This attribute is a pair of ECID values that the ONU can expect in the direction from the PSN towards the TDM termination. Checking ECIDs may be a way to detect circuit misconnection. MEF 8 ECIDs lie in the range 1..1048575 ($2^{20} - 1$). To allow for the possibility of other transport (L2TP) in the future, each ECID is allocated 4 bytes.

The first value is used for the payload ECID; the second is used for the optional separate signalling ECID. In both cases, the default value 0 indicates that no ECID checking is expected.

(R, W) (optional for MEF 8 transport) (8 bytes)

Received circuit ID: This attribute indicates the actual ECID(s) received on the payload and signalling channels, respectively. It may be used for diagnostic purposes. (R) (optional for MEF 8 transport) (8 bytes)

Exception policy: This attribute points to an instance of the pseudowire maintenance profile ME. If the pointer has its default value 0, the ONU's internal defaults apply. (R, W) (optional) (2 bytes)

ARC: See clause A.1.4.3. (R, W) (optional) (1 byte)

ARC interval: See clause A.1.4.3. (R, W) (optional) (1 byte)

Actions

Create, delete, get, set

Notifications

Attribute value change

Number	Attribute value change	Description
1..13	N/A	
14	ARC	Alarm-reporting control cancellation
15	N/A	
16	Reserved	

Alarm criteria may be customized through reference to a pseudowire maintenance profile managed object, or defined by the ONU's internal defaults.

Alarm

Alarm number	Event	Description
0	Misconnection	Excessive ratio of stray packets received from the PSN.
1	Loss of packets	Excessive ratio of lost packets from the PSN.
2	Buffer overrun	Excessive ratio of packets lost because they arrived from the PSN too early to be buffered for playout.
3	Buffer underrun	Excessive ratio of packets lost because they arrived from the PSN too late to be buffered for playout.
4	Malformed packets alarm	Excessive ratio of packets lost because their structure or payload type did not match the provisioned service.
5..207	Reserved	
208..223	Vendor-specific alarms	Not to be standardized

9.8.6 RTP pseudowire parameters

If a pseudowire service uses RTP, the RTP pseudowire parameters ME provides configuration information for the RTP layer. Instances of this ME are created and deleted by the OLT. The use of RTP on a pseudowire is optional, and is determined by the existence of the RTP pseudowire parameters ME.

Relationships

An instance of the RTP pseudowire parameters ME may exist for each pseudowire TP ME, to which it is implicitly bound by a common ME ID.

Attributes

Managed entity ID: This attribute uniquely identifies each instance of this ME. Through an identical ID, this ME is implicitly linked to an instance of the pseudowire TP ME. (R, set-by-create) (mandatory) (2 bytes)

Clock reference: This attribute specifies the frequency of the common timing reference, in multiples of 8 kHz. (R, W, set-by-create) (mandatory) (2 bytes)

RTP timestamp mode: This attribute determines the mode in which RTP timestamps are generated in the TDM to the PSN direction.

0 Unknown or not applicable.

1 Absolute. Timestamps are based on the timing of the incoming TDM signal.

2 Differential. Timestamps are based on the ONU's reference clock, which is understood to be stratum-traceable along with the reference clock at the far end.

(R, W, set-by-create) (mandatory) (1 byte)

PTYPE: This attribute specifies the RTP payload type in the TDM to the PSN direction. It comprises two 1 byte values. The first is for the payload channel, the second, for the optional separate signalling channel. Assignable PTYPEs lie in the dynamic range 96..127. If signalling is not transported in its own channel, the second value should be set to 0. (R, W, set-by-create) (mandatory) (2 bytes)

SSRC: This attribute specifies the RTP synchronization source in the TDM to the PSN direction. It comprises two 4 byte values. The first is for the payload channel, the second, for the optional separate signalling channel. If signalling is not

transported in its own channel, the second value should be set to 0. (R, W, set-by-create) (mandatory) (8 bytes)

Expected PTYPE: This attribute specifies the RTP payload type in the PSN to the TDM direction. The received payload type may be used to detect malformed packets. It comprises two 1 byte values. The first is for the payload channel, the second, for the optional separate signalling channel. To disable either or both of the check functions, set the corresponding value to its default value 0. (R, W, set-by-create) (optional) (2 bytes)

Expected SSRC: This attribute specifies the RTP synchronization source in the PSN to the TDM direction. The received SSRC may be used to detect misconnection (stray packets). It comprises two 4 byte values. The first is for the payload channel, the second, for the optional separate signalling channel. To disable either or both of the check functions, set the corresponding value to its default value 0. (R, W, set-by-create) (optional) (8 bytes)

Actions

Create, delete, get, set

Notifications

None.

9.8.7 Pseudowire maintenance profile

The pseudowire maintenance profile permits the configuration of pseudowire service exception handling. It is created and deleted by the OLT.

The settings, and indeed existence, of a pseudowire maintenance profile affect the behaviour of the pseudowire PM history data ME only in establishing criteria for counting SESs, but in no other way. The pseudowire maintenance profile primarily affects the alarms declared by the subscribing pseudowire TP.

Relationships

One or more instances of the pseudowire TP may point to an instance of the pseudowire maintenance profile. If the pseudowire TP does not refer to a pseudowire maintenance profile, the ONU's default exception handling is implied.

Attributes

Managed entity ID: This attribute uniquely identifies each instance of this ME. The value 0 is reserved. (R, set-by-create) (mandatory) (2 bytes)

Jitter buffer maximum depth: This attribute specifies the desired maximum depth of the playout buffer in the PSN to the TDM direction. The value is expressed as a multiple of the 125 μ s frame rate. The default value 0 selects the ONU's internal policy. (R, W, set-by-create) (optional) (2 bytes)

Jitter buffer desired depth: This attribute specifies the desired nominal fill depth of the playout buffer in the PSN to the TDM direction. The value is expressed as a multiple of the 125 μ s frame rate. The default value 0 selects the ONU's internal policy. (R, W, set-by-create) (optional) (2 bytes)

Fill policy: This attribute defines the payload bit pattern to be applied towards the TDM service if no payload packet is available to play out. The default value 0 specifies that the ONU apply its internal policy.

- 0 ONU default, vendor-specific (recommended: AIS for unstructured service, all 1s for structured service)
- 1 Play out AIS according to the service definition (for example, DS3 AIS)
- 2 Play out all 1s
- 3 Play out all 0s
- 4 Repeat the previous data
- 5 Play out DS1 idle (Appendix C of [b-ATIS-0600403])
- 6..15 Reserved for future standardization
- 16..255 Vendor-specific, not to be standardized

(R, W, set-by-create) (optional) (1 byte)

Four pairs of alarm-related policy attributes, defined in the following, share common behaviour.

The alarm declaration policy attribute defines the anomaly rate that causes the corresponding alarm to be declared. It is an integer percentage between 1..100. If this density of anomalies occurs during the alarm onset soak interval, the alarm is declared. The default value 0 selects the ONU's internal policy.

The alarm clear policy attribute defines the anomaly rate that causes the corresponding alarm to be cleared. It is an integer percentage between 0..99. If no more than this density of anomalies occurs during the alarm clear soak interval, the alarm is cleared. The default value 255 selects the ONU's internal policy.

Misconnected packets declaration policy: (R, W, set-by-create) (optional) (1 byte)

Misconnected packets clear policy: (R, W, set-by-create) (optional) (1 byte)

Loss of packets declaration policy: (R, W, set-by-create) (optional) (1 byte)

Loss of packets clear policy: (R, W, set-by-create) (optional) (1 byte)

Buffer overrun/underrun declaration policy: (R, W, set-by-create) (optional) (1 byte)

Buffer overrun/underrun clear policy: (R, W, set-by-create) (optional) (1 byte)

Malformed packets declaration policy: (R, W, set-by-create) (optional) (1 byte)

Malformed packets clear policy: (R, W, set-by-create) (optional) (1 byte)

R-bit transmit set policy: This attribute defines the number of consecutive lost packets that causes the transmitted R bit to be set in the TDM to the PSN direction, indicating lost packets to the far end. The default value 0 selects the ONU's internal policy. (R, W, set-by-create) (optional) (1 byte)

R-bit transmit clear policy: This attribute defines the number of consecutive valid packets that causes the transmitted R bit to be cleared in the TDM to the PSN direction, removing the remote failure indication to the far end. The default value 0 selects the ONU's internal policy. (R, W, set-by-create) (optional) (1 byte)

R-bit receive policy: This attribute defines the action towards the $N \times 64$ TDM interface when remote failure is indicated on packets received from the PSN (either R-bit set or $M = 0b10$ while the L bit is cleared).

- 0 Do nothing (recommended to be the default)
- 1 Play out service-specific RAI/REI/RDI code
- 2 Send channel idle signalling and idle channel payload to all DS0s comprising the service

(R, W, set-by-create) (optional) (1 byte)

L bit receive policy: This attribute defines the action towards the TDM interface when far-end TDM failure is indicated on packets received from the PSN (L bit set).

- 0 Play out service-specific AIS (recommended to be the default)
- 1 Repeat last received packet
- 2 Send channel idle signalling and idle channel payload to all DS0s comprising the service

(R, W, set-by-create) (optional) (1 byte)

SES threshold: Number of lost, malformed or otherwise unusable packets expected in the PSN to the TDM direction within a 1 s interval that causes an SES to be counted. Stray packets do not count towards an SES, nor do packets whose L bit is set at the far end. The value 0 specifies that the ONU uses its internal default, which is not necessarily the same as the recommended default value 3. (R, W, set-by-create) (optional) (2 bytes)

Actions

Create, delete, get, set

Notifications

None.

9.8.8 Pseudowire performance monitoring history data

This ME collects PM for a pseudowire TP. Most of the attributes monitor packets received from the PSN, and may therefore be considered egress PM. For the most part, ingress PM is collected at the CES PPTP ME.

NOTE – The pseudowire PM history data ME collects data similar, but not identical, to that available from the MAC bridge port PM history data ME associated with a MAC bridge. When the pseudowire is bridge-based, it may not be necessary to collect both.

Instances of this ME are created and deleted by the OLT.

For a complete discussion of generic PM architecture, refer to clause I.4.

Relationships

An instance of this ME is associated with an instance of the pseudowire TP.

Attributes

Managed entity ID: This attribute uniquely identifies each instance of this ME. Through an identical ID, this ME is implicitly linked to an instance of the pseudowire TP. (R, set-by-create) (mandatory) (2 bytes)

Interval end time: This attribute identifies the most recently finished 15 min interval. (R) (mandatory) (1 byte)

Threshold data 1/2 ID: This attribute points to an instance of the threshold data 1 and 2 MEs that contains PM threshold values. (R, W, set-by-create) (mandatory) (2 bytes)

- Received packets:** This attribute counts the total number of packets, both payload and signalling, received in the PSN to the TDM direction. (R) (mandatory) (4 bytes)
- Transmitted packets:** This attribute counts the total number of packets, both payload and signalling, transmitted in the TDM to the PSN direction. The count includes packets whose L bit is set and which may therefore not contain a payload. (R) (mandatory) (4 bytes)
- Missing packets:** This attribute counts the number of lost packets, as indicated by gaps in the control word numbering sequence. Both payload and signalling packets, if any, contribute to this count. (R) (mandatory) (4 bytes)
- Misordered packets, usable:** This attribute counts the number of packets received out of order, but which were able to be successfully re-ordered and played out. Both payload and signalling packets, if any, contribute to this count. (R) (mandatory) (4 bytes)
- Misordered packets dropped:** This attribute counts the number of packets received out of sequence that were discarded, either because the ONU did not support reordering or because it was too late to reorder them. Both payload and signalling packets, if any, contribute to this count. (R) (mandatory) (4 bytes)
- Playout buffer underruns/overruns:** This attribute counts the number of packets that were discarded because they arrived too late or too early to be played out. Both payload and signalling packets, if any, contribute to this count. (R) (mandatory) (4 bytes)
- Malformed packets:** This attribute counts the number of malformed packets, e.g., because the packet length was not as expected or because of an unexpected RTP payload type. Both payload and signalling packets, if any, contribute to this count. (R) (mandatory) (4 bytes)
- Stray packets:** This attribute counts the number of packets whose ECID or RTP SSRC failed to match the expected value, or which are otherwise known to have been misdelivered. Stray packets are discarded without affecting any of the other PM counters. Both payload and signalling packets, if any, contribute to this count. (R) (mandatory) (4 bytes)
- Remote packet loss:** This attribute counts received packets whose R bit is set, indicating the loss of packets at the far end. Both payload and signalling packets, if any, contribute to this count. (R) (mandatory) (4 bytes)
- TDM L-bit packets transmitted:** This attribute counts the number of packets transmitted with the L bit set, indicating a near-end TDM fault. Both payload and signalling packets, if any, contribute to this count. (R) (mandatory) (4 bytes)
- ES:** This attribute counts errored seconds. Any discarded, lost, malformed or unusable packet received from the PSN during a given second causes this counter to increment. Both payload and signalling packets, if any, contribute to this count. (R) (mandatory) (4 bytes)
- SES:** This attribute counts severely errored seconds. The criterion for an SES may be configured through the pseudowire maintenance profile ME. Both payload and signalling packets, if any, contribute to this count. (R) (mandatory) (4 bytes)
- UAS:** This attribute counts unavailable seconds. An unavailable second begins at the onset of 10 consecutive SES and ends at the onset of 10 consecutive seconds

that are not severely errored. A service is unavailable if either its payload or its signalling, if any, are unavailable. During unavailable time, only UAS should be counted; other anomalies should not be counted. (R) (mandatory) (4 bytes)

Actions

Create, delete, get, set

Get current data (optional)

Notifications

Threshold crossing alert

Alarm number	Threshold crossing alert	Threshold value attribute No. (Note)
0	Missing packets	1
1	Misordered packets, usable	2
2	Misordered packets dropped	3
3	Playout buffer underruns/overruns	4
4	Malformed packets	5
5	Stray packets	6
6	Remote packet loss	7
7	ES	8
8	SES	9
9	UAS	10

NOTE – This number associates the TCA with the specified threshold value attribute of the threshold data 1/2 managed entities.

9.8.9 Ethernet flow termination point

The Ethernet flow TP contains the attributes necessary to originate and terminate Ethernet frames in the ONU. It is appropriate when transporting pseudowire services via layer 2. Instances of this ME are created and deleted by the OLT.

Relationships

One Ethernet flow TP ME exists for each distinct pseudowire service that is transported via layer 2.

Attributes

Managed entity ID: This attribute uniquely identifies each instance of this ME. Through an identical ID, this ME is implicitly linked to a pseudowire TP ME. (R, set-by-create) (mandatory) (2 bytes)

Destination MAC: This attribute specifies the destination MAC address of upstream Ethernet frames. (R, W, set-by-create) (mandatory) (6 bytes)

Source MAC: This attribute specifies the near-end MAC address. It is established by non-OMCI means (e.g., factory programmed into ONU flash memory) and is included here for information only. (R) (mandatory) (6 bytes)

Tag policy: This attribute specifies the tagging policy to be applied to upstream Ethernet frames.

- 0 untagged frame
- 1 tagged frame

(R, W, set-by-create) (mandatory) (1 byte)

TCI: If the tag policy calls for tagging of upstream Ethernet frames, this attribute specifies the tag control information, which includes the VLAN tag, P bits and CFI bit. (R, W) (optional) (2 bytes)

Loopback: This attribute sets the loopback configuration as follows.

0 No loopback

1 Loopback of downstream traffic at MAC client

(R, W) (mandatory) (1 byte)

Actions

Create, delete, get, set

Notifications

None.

9.8.10 This clause is intentionally left blank

9.8.11 This clause is intentionally left blank

9.8.12 CES physical interface performance monitoring history data 2

This ME collects far-end statistics for a CES physical interface. It is specifically directed at DS1 interfaces ([b-ATIS-0300231], [b-ATIS-0600403]), but may be useful in other cases as well.

Instances of this ME are created and deleted by the OLT.

For a complete discussion of generic PM architecture, refer to clause I.4.

Relationships

An instance of this ME is associated with one instance of the PPTP CES UNI.

Attributes

Managed entity ID: This attribute uniquely identifies each instance of this ME. Through an identical ID, this ME is implicitly linked to an instance of the PPTP CES UNI. (R, set-by-create) (mandatory) (2 bytes)

Interval end time: This attribute identifies the most recently finished 15 min interval. (R) (mandatory) (1 byte)

Threshold data 1/2 ID: This attribute points to an instance of the threshold data 1 and 2 MEs that contain PM threshold values. (R, W, set-by-create) (mandatory) (2 bytes)

Each of the following attributes is (R) (optional) (2 bytes).

Attribute name	Common acronym
Errored seconds, line far-end	ES-LFE
Code violations, path far-end	CV-PFE
Errored seconds, path far-end	ES-PFE
Errored seconds type A, path far-end	ESA-PFE
Errored seconds type B, path far-end	ESB-PFE
Severely errored seconds, path far-end	SES-PFE
Severely errored framing seconds, path far-end	SEFS-PFE
Unavailable seconds, path far-end	UAS-PFE

Attribute name	Common acronym
Controlled slip seconds, path far-end	CSS-PFE
Failure count, path far-end	FC-PFE

Actions

Create, delete, get, set

Get current data (optional)

Notifications

Threshold crossing alert

Alarm number	Threshold crossing alert	Threshold value attribute No. (Note)
0	ES-LFE	1
1	CV-PFE	2
2	ES-PFE	3
3	ESA-PFE	4
4	ESB-PFE	5
5	SES-PFE	6
6	SEFS-PFE	7
7	UAS-PFE	8
8	CSS-PFE	9

NOTE – This number associates the TCA with the specified threshold value attribute of the threshold data 1/2 managed entities.

9.8.13 CES physical interface performance monitoring history data 3

This ME collects auxiliary statistics for a CES physical interface. It is specifically directed at DS1 interfaces ([b-ATIS-0300231], [b-ATIS-0600403]), but may be useful in other cases as well.

Instances of this ME are created and deleted by the OLT.

For a complete discussion of generic PM architecture, refer to clause I.4.

Relationships

An instance of this ME is associated with one instance of the PPTP CES UNI.

Attributes

Managed entity ID: This attribute uniquely identifies each instance of this ME. Through an identical ID, this ME is implicitly linked to an instance of the PPTP CES UNI. (R, set-by-create) (mandatory) (2 bytes)

Interval end time: This attribute identifies the most recently finished 15 min interval. (R) (mandatory) (1 byte)

Threshold data 1/2 ID: This attribute points to an instance of the threshold data 1 ME that contains PM threshold values. Since no threshold value attribute number exceeds 7, a threshold data 2 ME is optional. (R, W, set-by-create) (mandatory) (2 bytes)

Each of the following attributes is (R) (optional) (2 bytes).

Attribute name	Common acronym
AIS-CI seconds	AISSCI-P
Errored seconds, network performance	ES-NP
Severely errored seconds, network performance	SES-NP
Unavailable seconds, network performance	UAS-NP
Errored seconds, network performance, far-end	ES-NPFE
Severely errored seconds, NP far-end	SES-NPFE
Unavailable seconds, NP far-end	UAS-NPFE
Failure count	FC
Protection switch count	PSC
Protection switch duration	PSD

Actions

Create, delete, get, set

Get current data (optional)

Notifications

Threshold crossing alert

Alarm number	Threshold crossing alert	Threshold value attribute No. (Note)
0	AISSCI-P	1
1	ES-NP	2
2	SES-NP	3
3	UAS-NP	4
4	ES-NPFE	5
5	SES-NPFE	6
6	UAS-NPFE	7

NOTE – This number associates the TCA with the specified threshold value attribute of the threshold data 1 managed entity.

9.8.14 MPLS pseudowire termination point

This ME contains the configuration data of a pseudowire whose underlying transport method is MPLS. Instances of this ME are created and deleted by the OLT.

Relationships

Zero or one instance of this ME is associated with each instance of the pseudowire TP ME.

Attributes

Managed entity ID: This attribute uniquely identifies each instance of this ME. (R, set-by-create) (mandatory) (2 bytes)

TP type: This attribute specifies the type of ANI-side TP associated with this ME.

- 1 Ethernet flow termination point
- 2 GEM IW TP
- 3 TCP/UDP config data
- 4 MPLS pseudowire termination point

NOTE – If this instance of the MPLS PW TP is pointed to by another instance of the MPLS PW TP (i.e., whose TP type = 4), this instance represents a tunnelled MPLS flow, and the following attributes are not meaningful: MPLS PW direction; MPLS PW uplink label; MPLS PW downlink label; and MPLS PW TC. These attributes should be set to the proper number of 0x00 bytes by the OLT and ignored by the ONU.

(R, W, set-by-create) (mandatory) (1 byte)

TP pointer: This attribute points to the instance of the TP associated with this MPLS PW TP. The type of the associated TP is determined by the TP type attribute. (R, W, set-by-create) (mandatory) (2 bytes)

MPLS label indicator: This attribute specifies the MPLS label stacking situation.

- 0 Single MPLS labelled
- 1 Double MPLS labelled

(R, W, set-by-create) (mandatory) (1 byte)

MPLS PW direction: This attribute specifies the inner MPLS direction.

- 0 Upstream only
- 1 Downstream only
- 2 Bidirectional

(R, W, set-by-create) (mandatory) (1 byte)

MPLS PW uplink label: This attribute specifies the label of the inner MPLS pseudowire upstream. The attribute is not meaningful for unidirectional downstream PWs.

(R, W, set-by-create) (mandatory) (4 bytes)

MPLS PW downlink label: This attribute specifies the label of the inner MPLS pseudowire downstream. The attribute is not meaningful for unidirectional upstream PWs.

(R, W, set-by-create) (mandatory) (4 bytes)

MPLS PW TC: This attribute specifies the inner MPLS TC value in the upstream direction. The attribute is not meaningful for unidirectional downstream PWs. (R, W, set-by-create) (mandatory) (1 byte)

NOTE 1 – The TC field was previously known as EXP. Refer to [b-IETF RFC 5462].

MPLS tunnel direction: This attribute specifies the direction of the (outer) MPLS tunnel.

- 0 Upstream only
- 1 Downstream only
- 2 Bidirectional

(R, W, set-by-create) (mandatory for double-labelled case) (1 byte)

MPLS tunnel uplink label: This attribute specifies the (outer) label for the upstream MPLS tunnel. If the MPLS tunnel is downstream only, this attribute should be set to 0. (R, W, set-by-create) (mandatory for double-labelled case) (4 bytes)

MPLS tunnel downlink label: This attribute specifies the (outer) label for the downstream MPLS tunnel. If the MPLS tunnel is upstream only, this attribute should be set to 0. (R, W, set-by-create) (mandatory for double-labelled case) (4 bytes)

MPLS tunnel TC: This attribute specifies the TC value of the upstream MPLS tunnel. If the MPLS tunnel is downstream only, this attribute should be set to 0. (R, W, set-by-create) (mandatory for double MPLS labelled case) (1 byte)

NOTE 2 – The TC field was previously known as EXP. Refer to [b-IETF RFC 5462].

Pseudowire type: This attribute specifies the emulated service to be carried over this PW. The values are from [IETF RFC 4446].

- 2 ATM AAL5 SDU VCC transport

- 3 ATM transparent cell transport
- 5 Ethernet
- 9 ATM *n*-to-one VCC cell transport
- 10 ATM *n*-to-one VPC cell transport
- 12 ATM one-to-one VCC cell mode
- 13 ATM one-to-one VPC cell mode
- 14 ATM AAL5 PDU VCC transport

All other values are reserved.

(R, W, set-by-create) (mandatory) (2 bytes)

Pseudowire control word preference: When set to true, this Boolean attribute specifies that a control word is to be sent with each packet. Some PW types mandate the use of a control word in any event. In such cases, the value configured for this attribute has no effect on the presence of the control word. (R, W, set-by-create) (optional) (1 byte)

Administrative state: This attribute locks (1) and unlocks (0) the functions performed by the MPLS pseudowire TP. Administrative state is further described in clause A.1.6. (R, W) (optional) (1 byte)

Operational state: This attribute reports whether the ME is currently capable of performing its function. Valid values are enabled (0) and disabled (1). (R) (optional) (1 byte)

Actions

Create, delete, get, set

Notifications

Attribute value change

Number	Attribute value change	Description
1..14	N/A	
15	Op state	Operational state
16	Reserved	

9.8.15 PW ATM configuration data

This ME contains generic configuration data for an ATM pseudowire. Definitions of attributes are from PW-ATM-MIB [IETF RFC 5605]. Instances of this ME are created and deleted by the OLT.

Relationships

An instance of this ME is associated with an instance of the MPLS pseudowire TP ME with a pseudowire type attribute equal to one of the following.

- 2 ATM AAL5 SDU VCC transport
- 3 ATM transparent cell transport
- 9 ATM *n*-to-one VCC cell transport
- 10 ATM *n*-to-one VPC cell transport
- 12 ATM one-to-one VCC cell mode
- 13 ATM one-to-one VPC cell mode
- 14 ATM AAL5 PDU VCC transport

Alternatively, an instance of this ME may be associated with an Ethernet flow TP or a TCP/UDP config data ME, depending on the transport layer of the pseudowire.

Attributes

Managed entity ID: This attribute uniquely identifies each instance of this ME. (R, set-by-create) (mandatory) (2 bytes)

TP type: This attribute specifies the type of the underlying transport layer. (R, W, set-by-create) (mandatory) (1 byte)

- 0 MPLS pseudowire termination point
- 1 Ethernet flow termination point
- 2 TCP/UDP config data

Transport TP pointer: This attribute points to an associated instance of the transport layer TP, whose type is specified by the TP type attribute. (R, W, set-by-create) (mandatory) (2 bytes)

PPTP ATM UNI pointer: This attribute points to an associated instance of the ITU-T G.983.2 PPTP ATM UNI. Refer to [ITU-T G.983.2] for the definition of the target ME. (R, W, set-by-create) (mandatory) (2 bytes)

Max cell concatenation: This attribute specifies the maximum number of ATM cells that can be concatenated into one PW packet in the upstream direction. (R, W, set-by-create) (mandatory) (2 bytes)

Far-end max cell concatenation: This attribute specifies the maximum number of ATM cells that can be concatenated into one PW packet as provisioned at the far end. This attribute may be used for error checking of downstream traffic. The value 0 specifies that the ONU uses its internal default. (R, W, set-by-create) (optional) (2 bytes)

ATM cell loss priority (CLP) QoS mapping: This attribute specifies whether the CLP bits should be considered when setting the value in the QoS fields of the encapsulating protocol (e.g., TC fields of the MPLS label stack).

- 1 ATM CLP bits mapping to QoS fields of the encapsulating protocol
- 2 Not applicable

The value 0 specifies that the ONU uses its internal default. (R, W, set-by-create) (optional) (1 byte)

Timeout mode: This attribute specifies whether a packet is transmitted in the upstream direction based on timeout expiration for collecting cells. The actual handling of the timeout is implementation specific; as such, this attribute may be changed at any time with proper consideration of the traffic disruption effect.

- 1 Disabled. The ONU does not generate packets based on timeout cells.
- 2 Enabled. The ONU generates packets based on timeout cells.

The value 0 specifies that the ONU uses its internal default. (R, W, set-by-create) (optional) (1 byte)

PW ATM mapping table: This attribute lists ATM VPI/VCI mapping entries in both the upstream and downstream directions. In the upstream direction, ATM cells that match no entry's upstream VPI (and conditionally VCI) values are discarded; conversely in the downstream direction. Upon ME instantiation, the ONU sets this attribute to an empty table, which discards all cells in both directions.

The table can contain up to N entries when the pseudowire type is equal to one of the following:

- 9 ATM *n*-to-one VCC cell transport
- 10 ATM *n*-to-one VPC cell transport

The table contains only one entry when the pseudowire type is equal to one of the following.

- 2 ATM AAL5 SDU VCC transport
- 3 ATM transparent cell transport
- 12 ATM one-to-one VCC cell mode
- 13 ATM one-to-one VPC cell mode
- 14 ATM AAL5 PDU VCC transport

Each entry contains:

Entry number: (1 byte), the index of this row. A set operation with all fields zero has the effect of clearing the table. A set operation with a non-zero entry number and all other fields zero, has the effect of deleting one row.

Upstream VPI: (2 bytes)

The VPI value of this ATM PW at the UNI. When pseudowire type = ATM transparent cell transport (3), this field is ignored.

Upstream VCI: (2 bytes)

The VCI value of this ATM PW at the UNI. When pseudowire type = ATM transparent cell transport (3), or in virtual path (VP) cases, this field is ignored.

Upstream traffic descriptor profile pointer: (2 bytes)

A pointer to an instance of an ITU-T G.983.2 traffic descriptor profile ME that contains the traffic parameters used for the ATM upstream traffic. Refer to clause 7.5.2 of [ITU-T G.983.2] for the definition of this class of MEs. A null pointer indicates BE.

Upstream mapped VPI: (2 bytes)

The VPI value of the upstream MPLS ATM PW. This field is valid when the pseudowire type is as follows.

- 9 ATM *n*-to-one VCC cell transport
- 10 ATM *n*-to-one VPC cell transport
- 12 ATM one-to-one VCC cell mode
- 13 ATM one-to-one VPC cell mode

This field is not used for other pseudowire types.

Upstream mapped VCI: (2 bytes)

The VCI value of the upstream MPLS ATM PW. This field is valid when the pseudowire type is as follows.

- 9 ATM *n*-to-one VCC cell transport
- 10 ATM *n*-to-one VPC cell transport
- 12 ATM one-to-one VCC cell mode
- 13 ATM one-to-one VPC cell mode

This field is not used for other pseudowire types.

Downstream VPI: (2 bytes)

The downstream VPI value of this MPLS ATM PW. When pseudowire type = ATM transparent cell transport (3), this field is ignored.

Downstream VCI: (2 bytes)

The downstream VCI value of this MPLS ATM PW. When pseudowire type = ATM transparent cell transport (3) or in the VP case, this field is ignored.

Downstream traffic descriptor profile pointer: (2 bytes)

A pointer to an instance of an ITU-T G.983.2 traffic descriptor profile ME that contains the traffic parameters used for the ATM downstream traffic. Refer to clause 7.5.2 of [ITU-T G.983.2] for definition of this class of MEs. A null pointer indicates BE.

Downstream mapped VPI: (2 bytes)

The VPI value of this ATM PW at the UNI. This field is valid when the pseudowire type is as follows.

- 9 ATM *n*-to-one VCC cell transport
- 10 ATM *n*-to-one VPC cell transport
- 12 ATM one-to-one VCC cell mode
- 13 ATM one-to-one VPC cell mode

This field is not used for other pseudowire types.

Downstream mapped VCI: (2 bytes)

The VCI value of this ATM PW at the UNI. This field is valid when the pseudowire type is as follows.

- 9 ATM *n*-to-one VCC cell transport
- 10 ATM *n*-to-one VPC cell transport
- 12 ATM one-to-one VCC cell mode
- 13 ATM one-to-one VPC cell mode

This field is not used for other pseudowire types.

(R, W) (mandatory) (21*N* bytes, where *N* is the number of entries in the list)

Actions

Create, delete, get, get next, set
Set table (optional)

Notifications

None.

9.8.16 PW ATM performance monitoring history data

This ME collects PM data associated with an ATM pseudowire. Instances of this ME are created and deleted by the OLT.

For a complete discussion of generic PM architecture, refer to clause I.4.

Relationships

An instance of this ME is associated with an instance of the PW ATM configuration data ME.

Attributes

Managed entity ID: This attribute uniquely identifies each instance of this ME. Through an identical ID, this ME is implicitly linked to the instance of the PW ATM configuration data ME. (R, set-by-create) (mandatory) (2 bytes)

Interval end time: This attribute identifies the most recently finished 15 min interval. (R) (mandatory) (1 byte)

Threshold data 1/2 ID: This attribute points to an instance of the threshold data 1 ME that contains PM threshold values. Since no threshold value attribute number exceeds 7, a threshold data 2 ME is optional. (R, W, set-by-create) (mandatory) (2 bytes)

Downstream missing packets counter: This attribute counts missing packets, as detected via control word sequence number gaps. (R) (mandatory) (4 bytes)

Downstream reordered packets counter: This attribute counts packets detected out of sequence via the control word sequence number, but successfully reordered. Some implementations may not support this feature. (R) (optional) (4 bytes)

Downstream misordered packets counter: This attribute counts packets detected out of order via the control word sequence numbers. (R) (mandatory) (4 bytes)

Upstream timeout packets counter: This attribute counts packets transmitted due to timeout expiration while attempting to collect cells. (R) (mandatory) (4 bytes)

Upstream transmitted cells counter: This attribute counts transmitted cells. (R) (mandatory) (4 bytes)

Upstream dropped cells counter: This attribute counts dropped cells. (R) (mandatory) (4 bytes)

Upstream received cells counter: This attribute counts received cells. (R) (mandatory) (4 bytes)

Actions

Create, delete, get, set

Get current data (optional)

Notifications

Threshold crossing alert

Alarm number	Threshold crossing alert	Threshold value attribute No. (Note)
1	Downstream missing packets	1
2	Downstream reordered packets	2
3	Downstream timeout packets	3
4	Upstream dropped cells	4

NOTE – This number associates the TCA with the specified threshold value attribute of the threshold data 1 managed entity.

9.8.17 PW Ethernet configuration data

This ME contains the Ethernet pseudowire configuration data. Instances of this ME are created and deleted by the OLT.

Relationships

An instance of this ME is associated with an instance of the MPLS pseudowire TP ME with a pseudowire type attribute equal to the following.

- 5 Ethernet

Attributes

Managed entity ID: This attribute uniquely identifies each instance of this ME. (R, set-by-create) (mandatory) (2 bytes)

MPLS pseudowire TP pointer: This attribute points to an instance of the MPLS pseudowire TP ME associated with this ME. (R, W, set-by-create) (mandatory) (2 bytes)

TP type: This attribute identifies the type of UNI associated with this Ethernet PW. Valid values are as follows.

- 1 Physical path termination point Ethernet UNI
 - 3 IEEE 802.1p mapper service profile
 - 7 Physical path termination point xDSL UNI part 1
 - 11 Virtual Ethernet interface point
 - 12 Physical path termination point MoCA UNI
 - 13 MAC bridge port configuration data
- Other values are reserved

(R, W, set-by-create) (mandatory) (1 byte)

UNI pointer: This attribute points to the associated instance of a UNI-side ME. The type of UNI is determined by the TP type attribute. (R, W, set-by-create) (mandatory) (2 bytes)

Actions

Create, delete, get, set

Notifications

None.

9.8.18 Ethernet pseudowire parameters

This ME contains the Ethernet pseudowire parameters. Instances of this ME are created and deleted by the OLT.

Relationships

An instance of this ME is associated with an instance of the PW Ethernet configuration data ME.

Attributes

Managed entity ID: This attribute uniquely identifies each instance of this ME. Through an identical ID, this ME is implicitly linked to an instance of the PW Ethernet configuration data ME. (R, set-by-create) (mandatory) (2 bytes)

MTU: This attribute identifies the maximum transmission unit (bytes) that can be received from the CPE in the upstream direction. Larger frames are discarded. (R, W, set-by-create) (mandatory) (2 bytes)

Actions

Create, delete, get, set

Notifications

None.

9.9 Voice services

This clause defines MEs associated with a POTS (VoIP service), as shown in Figure 9.9-1.

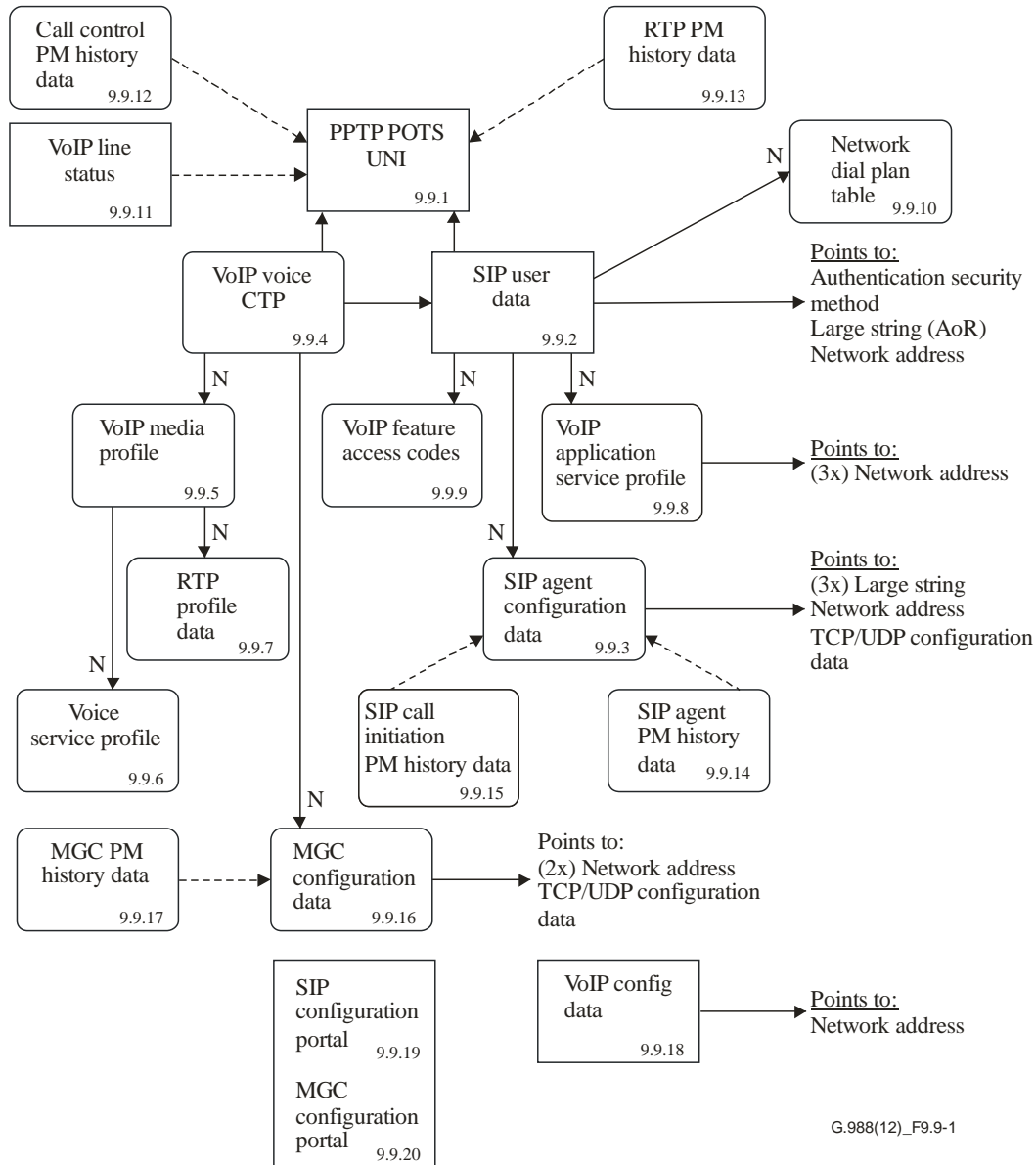

Figure 9.9-1 – Managed entities associated with a POTS (VoIP service)

9.9.1 Physical path termination point POTS UNI

This ME represents a POTS UNI in the ONU, where a physical path terminates and physical path level functions (analogue telephony) are performed.

The ONU automatically creates an instance of this ME per port as follows.

- When the ONU has POTS ports built into its factory configuration.
- When a cardholder is provisioned to expect a circuit pack of the POTS type.

- When a cardholder provisioned for plug-and-play is equipped with a circuit pack of the POTS type. Note that the installation of a plug-and-play card may indicate the presence of POTS ports via equipment ID as well as type, and indeed may cause the ONU to instantiate a port-mapping package that specifies POTS ports.

The ONU automatically deletes instances of this ME when a cardholder is neither provisioned to expect a POTS circuit pack, nor is it equipped with a POTS circuit pack.

Relationships

An instance of this ME is associated with each real or pre-provisioned POTS port. Either a SIP or a VoIP voice CTP links to the POTS UNI. Status is available from a VoIP line status ME, and RTP and call control PM may be collected on this point.

Attributes

Managed entity ID: This attribute uniquely identifies each instance of this ME. This 2 byte number indicates the physical position of the UNI. The first byte is the slot ID (defined in clause 9.1.5). The second byte is the port ID, with the range 1..255. (R) (mandatory) (2 bytes)

Administrative state: This attribute shuts down (2), locks (1) and unlocks (0) the functions performed by this ME. If the administrative state is set to shut down while the POTS UNI line state is non-idle, no action is taken until the POTS UNI line state changes to idle, whereupon the administrative state changes to locked. If the administrative state is set to shut down and the POTS UNI line state is already idle, the administrative state is immediately set to locked. In both cases, the transition from shutting down to locked state is signalled with an AVC.

When the administrative state is set to lock, all user functions of this UNI are blocked, and alarms, TCAs and AVCs for this ME and all dependent MEs are no longer generated. Selection of a default value for this attribute is outside the scope of this Recommendation. (R, W) (mandatory) (1 byte)

Deprecated: This attribute is not used and should not be supported. (R, W) (optional) (2 bytes)

ARC: See clause A.1.4.3. (R, W) (optional) (1 byte)

ARC interval: See clause A.1.4.3. (R, W) (optional) (1 byte)

Impedance: This attribute specifies the impedance for the POTS UNI. Valid values include the following.

- 0 600 Ohm
- 1 900 Ohm

The following parameter sets from Annex C of [ETSI TS 101 270-1] are also defined:

- 2 C1=150 nF, R1=750 Ohm, R2=270 Ohm
- 3 C1=115 nF, R1=820 Ohm, R2=220 Ohm
- 4 C1=230 nF, R1=1050 Ohm, R2=320 Ohm

where C1, R1, and R2 are related as shown in Figure 9.9.1-1. Upon ME instantiation, the ONU sets this attribute to 0. (R, W) (optional) (1 byte)

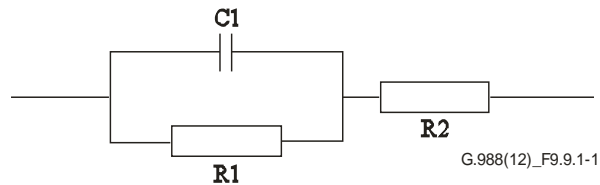

Figure 9.9.1-1 – Impedance model for POTS UNI

Transmission path: This attribute allows setting the POTS UNI either to full-time on-hook transmission (0) or part-time on-hook transmission (1). Upon ME instantiation, the ONU sets this attribute to 0. (R, W) (optional) (1 byte)

Rx gain: This attribute specifies a gain value for the received signal in the form of a 2s complement number. Valid values are -120 (12.0 dB) to 60 (+6.0 dB). The direction of the affected signal is in the D to A direction, towards the telephone set. Upon ME instantiation, the ONU sets this attribute to 0. (R, W) (optional) (1 byte)

Tx gain: This attribute specifies a gain value for the transmit signal in the form of a 2s complement number. Valid values are -120 (12.0 dB) to 60 (+6.0 dB). The direction of the affected signal is in the A to D direction, away from the telephone set. Upon ME instantiation, the ONU sets this attribute to 0. (R, W) (optional) (1 byte)

Operational state: This attribute indicates whether the ME is capable of performing its function. Valid values are enabled (0) and disabled (1). (R) (optional) (1 byte)

Hook state: This attribute indicates the current state of the subscriber line: 0 = on hook, 1 = off hook (R) (optional) (1 byte)

POTS holdover time: This attribute determines the time during which the POTS loop voltage is held up when a LOS or softswitch connectivity is detected (please refer to the following table for description of behaviours). After the specified time elapses, the ONU drops the loop voltage, and may thereby cause premises intrusion alarm or fire panel circuits to go active. When the ONU ranges successfully on the PON or softswitch connectivity is restored, it restores the POTS loop voltage immediately and resets the timer to zero. The attribute is expressed in seconds. The default value 0 selects the vendor's factory policy. (R, W) (optional) (2 bytes)

POTS holdover time	Loss of softswitch	Behaviour
0	Don't care	Vendor-specific
POTS holdover time > 0	False	T/R will be brought down on expiration of the holdover timer. The holdover timer is started upon detection of LOS. T/R is restored immediately upon ONU ranging. This setting is recommended for burglar alarms.
POTS holdover time > 0	True	T/R will be brought down on expiration of the holdover timer. The holdover timer is started on detection of softswitch connectivity keep alive signal. T/R is restored immediately upon softswitch connectivity. This setting is recommended for fire panels.

Nominal feed voltage: This attribute indicates the designed nominal feed voltage of the POTS loop. It is an absolute value with resolution 1 V. This attribute does not represent the actual voltage measured on the loop, which is available through the test command. (R, W) (optional) (1 byte)

Loss of softswitch: This Boolean attribute controls whether the T/R holdover initiation criteria. False disables loss of softswitch connectivity detection as criteria for initiating the POTS holdover timer. True enables loss of softswitch connectivity detection as criteria for initiating the POTS holdover timer. This attribute is optional (if not implemented, the POTS holdover time is triggered on a LOS when POTS holdover is greater than zero). (R, W) (optional) (1 byte)

Actions

Get, set

Test: Request that the ONU perform one or more mechanized loop tests (MLTs) or a dial tone make/break test. Vendor-specific tests are also supported by the test and test result message layouts in Annex A.

Notifications

Attribute value change

Number	Attribute value change	Description
1	Administrative state	The only change that is signalled with an AVC is the transition from shutting down to locked.
2	N/A	
3	ARC	ARC timer expiration
4..8	N/A	
9	Op state	Operational state
10..11	N/A	
12..16	Reserved	

9.9.2 SIP user data

The SIP user data defines the user specific configuration attributes associated with a specific VoIP CTP. This entity is conditionally required for ONUs that offer VoIP SIP services. If a non-OMCI interface is used to manage SIP for VoIP, this ME is unnecessary. The non-OMCI interface supplies the necessary data, which may be read back to the OLT via the SIP config portal ME.

An instance of this ME is created and deleted by the OLT. A SIP user data instance is required for each POTS UNI port using SIP protocol and configured by the OMCI.

Relationships

An instance of this ME is associated with one VoIP voice CTP ME and a PPTP POTS UNI.

Attributes

Managed entity ID: This attribute uniquely identifies each instance of this ME. (R, set-by-create) (mandatory) (2 bytes)

SIP agent pointer: This attribute points to the SIP agent config data ME to be used for signalling. (R, W, set-by-create) (mandatory) (2 bytes)

User part AOR: This attribute points to a large string that contains the user identification part of the address of record. This can take the form of an alphanumeric string or the subscriber's directory number. A null pointer indicates the absence of an AOR. (R, W, set-by-create) (mandatory) (2 bytes)

SIP display name: This ASCII string attribute defines the customer ID used for the display attribute in outgoing SIP messages. The default value is null (all zero bytes) (R, W) (mandatory) (25 bytes)

Username and password: This attribute points to an authentication security method ME that contains the SIP user name and password used for authentication. A null pointer indicates no username and password. (R, W, set-by-create) (mandatory) (2)

Voicemail server SIP URI: This attribute points to a network address ME that contains the name (IP address or URI) of the SIP voicemail server for SIP signalling messages. A null pointer indicates the absence of a SIP voicemail server. (R, W, set-by-create) (mandatory) (2 bytes)

Voicemail subscription expiration time: This attribute defines the voicemail subscription expiration time in seconds. If this value is 0, the SIP agent uses an implementation-specific value. This attribute is recommended to be set to 3600 s by default. (R, W, set-by-create) (mandatory) (4 bytes)

Network dial plan pointer: This attribute points to a network dial plan table. A null pointer indicates the absence of a network dial plan. (R, W, set-by-create) (mandatory) (2 bytes)

Application services profile pointer: This attribute points to a VoIP application services profile. (R, W, set-by-create) (mandatory) (2 bytes)

Feature code pointer: This attribute points to the VoIP feature access codes ME for this subscriber. A null pointer indicates the absence of a VoIP feature access codes ME. (R, W, set-by-create) (mandatory) (2 bytes)

PPTP pointer: This attribute points to the PPTP POTS UNI ME that provides the analogue telephony adaptor (ATA) function. (R, W, set-by-create) (mandatory) (2 bytes)

Release timer: This attribute contains a release timer defined in seconds. The value 0 specifies that the ONU is to use its internal default. The default value of this attribute is 10 s. (R, W) (optional) (1 byte)

Receiver off hook (ROH) timer: This attribute defines the time in seconds for the ROH condition before ROH tone is applied. The value 0 disables ROH timing. The value 0xFF specifies that the ONU is to use its internal default, which may or may not be the same as the 15 s OMCI default value. (R, W) (optional) (1 byte)

Actions

Create, delete, get, set

Notifications

Alarm

Alarm number	Alarm	Description
0	SIP UA register auth	Cannot authenticate a registration session (e.g., missing credentials)

Alarm

1	SIP UA register timeout	Timeout waiting for response from a registration server
2	SIP UA register fail	Failure response received from a registration server
3	SIPUA missing dial plan	Missing dial plan
4	SIPUA invalid dial plan	Invalid dial plan
5..207	Reserved	
208..223	Vendor-specific alarms	Not to be standardized

9.9.3 SIP agent config data

The SIP agent config data ME models a SIP signalling agent. It defines the configuration necessary to establish communication for signalling between the SIP user agent (UA) and a SIP server.

NOTE 1 – If a non-OMCI interface is used to manage SIP for VoIP, this ME is unnecessary. The non-OMCI interface supplies the necessary data, which may be read back to the OLT via the SIP config portal ME.

Instances of this ME are created and deleted by the OLT.

Relationships

An instance of this ME serves one or more SIP user data MEs and points to a TCP/UDP config data that carries signalling messages. Other pointers establish additional agent parameters such as proxy servers.

Attributes

Managed entity ID: This attribute uniquely identifies each instance of this ME. (R, set-by-create) (mandatory) (2 bytes)

Proxy server address pointer: This attribute points to a large string ME that contains the name (IP address or URI) of the SIP proxy server for SIP signalling messages. (R, W, set-by-create) (mandatory) (2 bytes)

Outbound proxy address pointer: An outbound SIP proxy may or may not be required within a given network. If an outbound SIP proxy is used, the outbound proxy address pointer attribute must be set to point to a valid large string ME that contains the name (IP address or URI) of the outbound proxy server for SIP signalling messages. If an outbound SIP proxy is not used, the outbound proxy address pointer attribute must be set to a null pointer. (R, W, set-by-create) (mandatory) (2 bytes)

Primary SIP DNS: This attribute specifies the primary SIP DNS IP address. If the value of this attribute is 0, the primary DNS server is defined in the corresponding IP host config data or IPv6 host config data ME. If the value is non-zero, it takes precedence over the primary DNS server defined in the IP host config data or IPv6 host config data ME. (R, W, set-by-create) (mandatory) (4 bytes)

Secondary SIP DNS: This attribute specifies the secondary SIP DNS IP address. If the value of this attribute is 0, the secondary DNS server is defined in the corresponding IP host config data or IPv6 host config data ME. If the value is non-zero, it takes precedence over the secondary DNS server defined in the IP host config data or IPv6 host config data ME. (R, W, set-by-create) (mandatory) (4 bytes)

TCP/UDP pointer: This pointer associates the SIP agent with the TCP/UDP config data ME to be used for communication with the SIP server. The default value is 0xFFFF, a null pointer. (R, W) (mandatory) (2 bytes)

SIP reg exp time: This attribute specifies the SIP registration expiration time in seconds. If its value is 0, the SIP agent does not add an expiration time to the registration requests and does not perform re-registration. The default value is 3600 s. (R, W) (mandatory) (4 bytes)

SIP rereg head start time: This attribute specifies the time in seconds prior to timeout that causes the SIP agent to start the re-registration process. The default value is 360 s. (R, W) (mandatory) (4 bytes)

Host part URI: This attribute points to a large string ME that contains the host or domain part of the SIP address of record for users connected to this ONU. A null pointer indicates that the current address in the IP host config ME is to be used. (R, W, set-by-create) (mandatory) (2 bytes)

SIP status: This attribute shows the current status of the SIP agent. Values are as follows.

- 0 Ok/initial
- 1 Connected
- 2 Failed – ICMP error
- 3 Failed – Malformed response
- 4 Failed – Inadequate info response
- 5 Failed – Timeout
- 6 Redundant, offline: this instance of the SIP agent config data occupies the role of a redundant server, and is not presently in use.

(R) (mandatory) (1 byte)

SIP registrar: This attribute points to a network address ME that contains the name (IP address or resolved name) of the registrar server for SIP signalling messages. Examples: "10.10.10.10" and "proxy.voip.net". (R, W, set-by-create) (mandatory) (2 bytes)

Softswitch: This attribute identifies the SIP gateway softswitch vendor. The format is four ASCII coded alphabetic characters [A..Z] as defined in [ATIS-0300220]. A value of four null bytes indicates an unknown or unspecified vendor. (R, W, set-by-create) (mandatory) (4 bytes)

SIP response table: This attribute specifies the tone and text to be presented to the subscriber upon receipt of various SIP messages (normally 4xx, 5xx, 6xx message codes). The table is a sequence of entries, each of which is defined as follows.

SIP response code (2 bytes): This field is the value of the SIP message code. It also serves as the index into the SIP response table. When a set operation is performed with the value 0 in this field, the table is cleared.

Tone (1 byte): This field specifies one of the tones in the tone pattern table of the associated voice service profile. The specified tone is played to the subscriber.

Text message (2 bytes): This field is a pointer to a large string that contains a message to be displayed to the subscriber. If the value of this field is a null pointer, text pre-associated with the tone may be displayed, or no text at all.

(R, W) (optional) ($N * 5$ bytes)

NOTE 2 – This model assumes that SIP response tones and text are common to all POTS lines that share a given SIP agent.

SIP option transmit control: This Boolean attribute specifies that the ONU is (true) or is not (false) enabled to transmit SIP options. The default value is recommended to be false. (R, W, set-by-create) (optional) (1 byte)

SIP URI format: This attribute specifies the format of the URI in outgoing SIP messages. The recommended default value 0 specifies TEL URIs; the value 1 specifies SIP URIs. Other values are reserved. (R, W, set-by-create) (optional) (1 byte)

Redundant SIP agent pointer: This attribute points to another SIP agent config data ME, which is understood to provide redundancy. The initial SIP agent is determined by the pointer from the SIP user data ME. It is the manager's responsibility to provision a group of redundant SIP agents with mutually consistent attributes. (R, W, set-by-create) (optional) (2 bytes)

Actions

Create, delete, get, set

Set table (optional)

Notifications

Attribute value change

Number	Attribute value change	Description
1..8	N/A	
9	SIP status	Status change
10..11	N/A	
12..16	Reserved	

Alarm

Alarm number	Alarm	Description
0	SIP UA register name	Failed to resolve the registration server name
1	SIP UA register reach	Cannot reach a registration server (the port cannot be reached, ICMP errors)
2	SIP UA register connect	Cannot connect to a registration server (due to bad credentials or other faults after the port has responded)
3	SIP UA register validate	Cannot validate a registration server
4 (Note)	SIP UA register auth	Cannot authenticate a registration session (e.g., missing credentials)
5 (Note)	SIP UA register timeout	Timeout waiting for response from a registration server
6 (Note)	SIP UA register fail	Failure response received from a registration server
7..207	Reserved	
208..223	Vendor-specific alarms	Not to be standardized

NOTE – These alarms are deprecated, and retained for backward compatibility. It is recommended that the SIP agent config data not declare these alarms, but that they be declared by the SIP user data ME instead. In any event, only one ME should declare the alarm, not both.

9.9.4 VoIP voice CTP

The VoIP voice CTP defines the attributes necessary to associate a specified VoIP service (SIP, ITU-T H.248) with a POTS UNI. This entity is conditionally required for ONUs that offer VoIP

services. If a non-OMCI interface is used to manage VoIP signalling, this ME is unnecessary.

An instance of this ME is created and deleted by the OLT. A VoIP voice CTP ME is needed for each PPTP POTS UNI served by VoIP.

Relationships

An instance of this ME links a PPTP POTS UNI ME with a VoIP media profile and a SIP user data or media gateway controller (MGC) config data ME.

Attributes

Managed entity ID: This attribute uniquely identifies each instance of this ME. (R, set-by-create) (mandatory) (2 bytes)

User protocol pointer: This attribute points to signalling protocol data. If the signalling protocol used attribute of the VoIP config data ME specifies that the ONU's signalling protocol is SIP, this attribute points to a SIP user data ME, which in turn points to a SIP agent config data ME. If the signalling protocol is ITU-T H.248, this attribute points directly to an MGC config data ME. (R, W, set-by-create) (mandatory) (2 bytes)

PPTP pointer: This attribute points to the PPTP POTS UNI ME that serves the analogue telephone port. (R, W, set-by-create) (mandatory) (2 bytes)

VoIP media profile pointer: This attribute points to an associated VoIP media profile. (R, W, set-by-create) (mandatory) (2 bytes)

Signalling code: This attribute specifies the POTS-side signalling as follows.

- 1 Loop start
- 2 Ground start
- 3 Loop reverse battery
- 4 Coin first
- 5 Dial tone first
- 6 Multi-party

(R, W, set-by-create) (mandatory) (1 byte)

Actions

Create, delete, get, set

Notifications

None.

9.9.5 VoIP media profile

The VoIP media profile ME contains settings that apply to VoIP voice encoding. This entity is conditionally required for ONUs that offer VoIP services. If a non-OMCI interface is used to manage VoIP signalling, this ME is unnecessary.

An instance of this ME is created and deleted by the OLT. A VoIP media profile is needed for each unique set of profile attributes.

Relationships

An instance of this ME may be associated with one or more VoIP voice CTP MEs.

Attributes

Managed entity ID: This attribute uniquely identifies each instance of this ME. (R, set-by-create) (mandatory) (2 bytes)

Fax mode: Selects the fax mode; values are as follows.

- 0 Passthru
- 1 ITU-T T.38

(R, W, set-by-create) (mandatory) (1 byte)

Voice service profile pointer: Pointer to a voice service profile, which defines parameters such as jitter buffering and echo cancellation. (R, W, set-by-create) (mandatory) (2 bytes)

Codec selection (1st order): This attribute specifies codec selection as defined by [IETF RFC 3551].

Value	Encoding name	Clock rate (Hz)
0	PCMU	8000
1	reserved	
2	reserved	
3	GSM	8000
4	ITU-T G.723	8000
5	DVI4	8000
6	DVI4	16000
7	LPC	8000
8	PCMA	8000
9	ITU-T G.722	8000
10	L16, 2 channels	44100
11	L16, 1 channel	44100
12	QCELP	8000
13	CN	8000
14	MPA	90000
15	ITU-T G.728	8000
16	DVI4	11025
17	DVI4	22050
18	ITU-T G.729	8000

(R, W, set-by-create) (mandatory) (1 byte)

Packet period selection (1st order): This attribute specifies the packet period selection interval in milliseconds. The recommended default value is 10 ms. Valid values are 10..30 ms. (R, W, set-by-create) (mandatory) (1 byte)

Silence suppression (1st order): This attribute specifies whether silence suppression is on or off. Valid values are 0 = off and 1 = on. (R, W, set-by-create) (mandatory) (1 byte)

Three more groups of three attributes are defined, with definitions identical to the preceding three:

Codec selection (2nd order): (R, W, set-by-create) (mandatory) (1 byte)

Packet period selection (2nd order): (R, W, set-by-create) (mandatory) (1 byte)

Silence suppression (2nd order): (R, W, set-by-create) (mandatory) (1 byte)

Codec selection (3rd order): (R, W, set-by-create) (mandatory) (1 byte)
Packet period selection (3rd order): (R, W, set-by-create) (mandatory) (1 byte)
Silence suppression (3rd order): (R, W, set-by-create) (mandatory) (1 byte)
Codec selection (4th order): (R, W, set-by-create) (mandatory) (1 byte)
Packet period selection (4th order): (R, W, set-by-create) (mandatory) (1 byte)
Silence suppression (4th order): (R, W, set-by-create) (mandatory) (1 byte)

OOB DTMF: This attribute specifies out-of-band DTMF carriage. When enabled (1), DTMF signals are carried out of band via RTP or the associated signalling protocol. When disabled (0), DTMF tones are carried in the PCM stream. (R, W, set-by-create) (mandatory) (1 byte)

RTP profile pointer: This attribute points to the associated RTP profile data ME. (R, W, set-by-create) (mandatory) (2 bytes)

Actions

Create, delete, get, set

Notifications

None.

9.9.6 Voice service profile

This ME organizes data that describe the voice service functions of the ONU. Instances of this ME are created and deleted by the OLT.

Relationships

An instance of this ME may be associated with zero or more instances of a VoIP voice CTP by way of a VoIP media profile.

Attributes

Managed entity ID: This attribute uniquely identifies each instance of this ME. (R, set-by-create) (mandatory) (2 bytes)

Announcement type: This attribute specifies the treatment when a subscriber goes off hook but does not attempt a call within the dial-tone timeout interval. Valid values include the following.

0x01	Silence
0x02	Reorder tone
0x03	Fast busy
0x04	Voice announcement
0xFF	Not specified; ONU is free to make its own choice.

(R, W, set-by-create) (mandatory) (1 byte)

Jitter target: This attribute specifies the target value of the jitter buffer in milliseconds. The system tries to maintain the jitter buffer at the target value. The value 0 specifies dynamic jitter buffer sizing. (R, W, set-by-create) (optional) (2 bytes)

Jitter buffer max: This attribute specifies the maximum depth of the jitter buffer associated with this service in milliseconds. The value 0 specifies that the ONU uses its internal default. (R, W, set-by-create) (optional) (2 bytes)

Echo cancel ind: The Boolean value true specifies that echo cancellation is on; false specifies off. (R, W, set-by-create) (mandatory) (1 byte)

PSTN protocol variant: This attribute controls which variant of POTS signalling is used on the associated UNIs. Its value is equal to the [ITU-T E.164] country code. The value 0 specifies that the ONU uses its internal default. (R, W, set-by-create) (optional) (2 bytes)

DTMF digit levels: This attribute specifies the power level of DTMF digits that may be generated by the ONU towards the subscriber set. It is a 2s complement value referred to 1 mW at the 0 transmission level point (TLP) (dBm0), with resolution 1 dB. The default value 0x8000 selects the ONU's internal policy. (R, W, set-by-create) (optional) (2 bytes)

DTMF digit duration: This attribute specifies the duration of DTMF digits that may be generated by the ONU towards the subscriber set. It is specified in milliseconds. The default value 0 selects the ONU's internal policy. (R, W, set-by-create) (optional) (2 bytes)

Hook flash minimum time: This attribute defines the minimum duration recognized by the ONU as a switchhook flash. It is expressed in milliseconds; the default value 0 selects the ONU's internal policy. (R, W, set-by-create) (optional) (2 bytes)

Hook flash maximum time: This attribute defines the maximum duration recognized by the ONU as a switchhook flash. It is expressed in milliseconds; the default value 0 selects the ONU's internal policy. (R, W, set-by-create) (optional) (2 bytes)

Tone pattern table: This attribute is a table, each of whose entries specifies a complex tone (or silence) and a duration. By linking tones and silence together, possibly cyclically, continuous, varying or interrupted tone sequences, repetitive or not, may be defined. A tone sequence is initiated by pointing to the first tone pattern table entry that defines its parameters. Each entry is a vector comprising the following components.

Index (1 byte): This component is simply an index into the table. It ranges from 1..255. In a set operation, the value 0 in this field clears the table.

Tone on (1 byte): This Boolean component controls whether the tone is on (true) or off. If the tone is off, the frequency and power fields are not meaningful.

Frequency 1 (2 bytes): This component specifies the frequency of one of the tone components in hertz.

Power 1 (1 byte): This component specifies the power level of the corresponding frequency component. It ranges from 0 (coded as 0) to -25.5 (coded as 255) dBm0 with 0.1 dB resolution.

Three additional pairs of frequency-power components may be specified to define a complex tone. If a pair of possibilities is not to be used, its frequency field should be set to 0.

Frequency 2 (2 bytes)

Power 2 (1 byte)

Frequency 3 (2 bytes)

Power 3 (1 byte)

Frequency 4 (2 bytes)

Power 4 (1 byte)

The following pair of frequency-power components allows the composite tone to be modulated (warble effect). If this effect is not to be used, the frequency should be set to 0.

Modulation frequency (2 bytes), hertz

Modulation power (1 byte), 0..25.5 dBm0

Duration (2 bytes): This component specifies the duration of the phase, in milliseconds. The value 0 specifies that the phase endures indefinitely, i.e., until terminated by other events such as call abandonment.

Next entry (1 byte): This component is a pointer to another entry in this same table, which permits sequences of tones to be defined, possibly cyclically. A reference to a non-existent table entry, or the value 0, indicates that the sequence should be terminated.

(R, W) (optional) ($N * 20$ bytes)

Tone event table: This attribute is a table, each of whose entries specifies an event for which a tone is defined. If the tone can be synthesized by a sequence of complex tones and silence, the event refers to an entry in the tone pattern table. Otherwise, the event refers to a file name that is expected to be recognized by the ONU environment. Each entry in the tone event table is a vector comprising the following components.

Event (1 byte): This component is an enumeration of the events for which a tone may be defined. The event component also serves as the index for the table. A set operation to event 0 causes the table to be cleared.

Value	Tone event
0	Not used for get operation; clears table under set operation
1	Busy
2	Confirmation
3	Dial
4	Message waiting
5	Off-hook warning (receiver off hook)
6	Ringback (audible ring)
7	Reorder
8	Stutter dial
9	Call waiting 1
10	Call waiting 2
11	Call waiting 3
12	Call waiting 4
13	Alerting signal
14	Special dial
15	Special info
16	Release
17	Congestion
18	User defined 1
19	User defined 2

Value	Tone event
20	User defined 3
21	User defined 4
22..32	Reserved
33	Intrusion
34	Dead tone
35..223	Reserved
224..255	Vendor-specific codes, not to be standardized

Tone pattern (1 byte): This component specifies an entry point into the tone pattern table attribute, to be invoked when the specified event occurs. The value 0 indicates that no tone from the tone pattern table is to be played.

Tone file (2 bytes): This component points to a large string ME that contains the path and name of a file containing a codec sequence to be played out. If no file is found after traversing these links, no tone is played. The behaviour is unspecified if both tone pattern and tone file are specified.

Tone file repetitions (1 byte): This component specifies the number of times the tone file is to be repeated. The value 0 means that the file is to be repeated indefinitely until terminated by some external event such as call abandonment.

Reserved (2 bytes)

(R, W) (optional) ($N * 7$ bytes).

Ringling pattern table: This attribute is a table, each of whose entries specifies a ringling pattern and a duration. By linking ringling and silence together, possibly cyclically, continuous or interrupted ringling sequences, repetitive or not, may be defined. A ringling sequence is initiated by pointing to the first ringling pattern table entry that defines its parameters. Each entry is a vector comprising the following components.

Index (1 byte): This component is simply an index into the table. It ranges from 1..255. In a set operation, the value 0 in this field clears the table.

Ringling on (1 byte): This Boolean component controls whether ringling is on (true) or off during this interval.

Duration (2 bytes): This component specifies the duration of the ringling phase, in milliseconds. The value 0 specifies that the phase endures indefinitely, i.e., until terminated by other events such as call abandonment.

Next entry (1 byte): This component is a pointer to another entry in this same table, which permits sequences of ringling bursts to be defined, possibly cyclically. A reference to a non-existent table entry, or the value 0, indicates that the sequence should be terminated.

(R, W) (optional) ($N * 5$ bytes).

Ringling event table: This attribute is a table, each of whose entries specifies an event for which a ringling sequence is defined. If the ringling sequence can be generated as a sequence of power ringling and silent intervals, the event refers to an entry in the ringling pattern table. Otherwise, the event refers to a file name that is expected to be recognized by the ONU environment. Each entry is a vector comprising the following components:

Event (1 byte): This component is an enumeration of the events for which a ringing sequence may be defined. The event component also serves as the index for the table. A set operation with the value 0 in this field causes the table to be cleared.

Value	Tone event
0	Not used for get operation; clears table under set operation
1	Default
2	Splash
3..223	Reserved
224..255	Vendor-specific codes, not to be standardized

Ringing pattern (1 byte): This component specifies an entry point into the ringing pattern table attribute, to be invoked when the specified event occurs. The value 0 indicates that no ringing sequence is defined in the ringing pattern table.

Ringing file (2 bytes): This component points to a large string ME that contains the path and name of a file containing a ring tone to be played out. If no file is found after traversing these links, no ringing is played. The behaviour is unspecified if both ringing pattern and ringing file fields are specified.

Ringing file repetitions (1 byte): This component specifies the number of times the ringing file is to be repeated. The value 0 means that the file is to be repeated indefinitely until terminated by some external event such as call abandonment.

Ringing text (2 bytes): This component points to a large string ME that contains a text string to be displayed on the CPE device in conjunction with this event. A null pointer indicates that no text is to be displayed.

(R, W) (optional) ($N * 7$ bytes).

Network specific extensions pointer: This attribute points to a network address ME that contains the path and name of a file containing network specific parameters for the associated UNIs. The default value for this attribute is 0xFFFF, a null pointer. (R, W, set-by-create) (optional) (2 bytes)

Actions

Create, delete, get, set

Set table (optional)

Notifications

Alarm

Number	Alarm	Description
1	File not found	The voice service profile attempted to access a network specific extensions file that is not available.
2..207	Reserved	

9.9.7 RTP profile data

This ME configures RTP. It is conditionally required for ONUs that offer VoIP service. If a non-

OMCI interface is used to manage VoIP, this ME is unnecessary.

An instance of this ME is created and deleted by the OLT. An RTP profile is needed for each unique set of attributes.

Relationships

An instance of this ME may be associated with one or more VoIP media profile MEs.

Attributes

Managed entity ID: This attribute uniquely identifies each instance of this ME. (R, set-by-create) (mandatory) (2 bytes)

Local port min: This attribute defines the base UDP port that should be used by RTP for voice traffic. The recommended default is 50000 (R, W, set-by-create) (mandatory) (2 bytes)

Local port max: This attribute defines the highest UDP port used by RTP for voice traffic. The value must be greater than the local port minimum. The value 0 specifies that the local port maximum be equal to the local port minimum. (R, W, set-by-create) (optional) (2 bytes)

DSCP mark: Diffserv code point to be used for outgoing RTP packets for this profile. The recommended default value is expedited forwarding (EF) = 0x2E. (R, W, set-by-create) (mandatory) (1 byte)

Piggyback events: Enables or disables RTP piggyback events.

- 0 Disabled (recommended default)
- 1 Enabled

(R, W, set-by-create) (mandatory) (1 byte)

Tone events: Enables or disables the handling of tones via RTP tone events per [IETF RFC 4733], (see also [IETF RFC 4734]).

- 0 Disabled (recommended default)
- 1 Enabled

(R, W, set-by-create) (mandatory) (1 byte)

DTMF events: Enables or disables the handling of DTMF via RTP DTMF events per [IETF RFC 4733], (see also [IETF RFC 4734]). This attribute is ignored unless the OOB DTMF attribute in the VoIP media profile is enabled.

- 0 Disabled
- 1 Enabled

(R, W, set-by-create) (mandatory) (1 byte)

CAS events: Enables or disables the handling of CAS via RTP CAS events per [IETF RFC 4733], (see also [IETF RFC 4734]).

- 0 Disabled
- 1 Enabled

(R, W, set-by-create) (mandatory) (1 byte)

IP host config pointer: This optional pointer associates the bearer (voice) flow with an IP host config data or IPv6 host config data ME. If this attribute is not present or is not populated with a valid pointer value, the bearer flow uses the same IP stack that is used for signalling, indicated by the TCP/UDP pointer in the associated SIP agent or MGC config data. The default value is 0xFFFF, a null pointer. (R, W) (optional) (2 bytes)

Actions

Create, delete, get, set

Notifications

None.

9.9.8 VoIP application service profile

The VoIP application service profile defines attributes of calling features used in conjunction with a VoIP line service. It is optional for ONUs that support VoIP services. If a non-OMCI interface is used to manage SIP for VoIP, this ME is unnecessary.

An instance of this ME is created and deleted by the OLT. A VoIP application service profile instance is needed for each unique set of profile attributes.

Relationships

An instance of this ME is associated with zero or more SIP user data MEs.

Attributes

Managed entity ID: This attribute uniquely identifies each instance of this ME.
(R, set-by-create) (mandatory) (2 bytes)

CID features: This attribute contains a bit map of caller ID features. Except as noted, the bit value 0 disables the feature; 1 enables it.

0x01	Calling number
0x02	Calling name
0x04	CID blocking (both number and name)
0x08	CID number – Permanent presentation status for number (0 = public, 1 = private)
0x10	CID name – Permanent presentation status for name (0 = public, 1 = private)
0x20	Anonymous CID blocking (ACR). It may not be possible to support this in the ONU.
0x40..0x80	Not used

The recommended default value is 0x00. (R, W, set-by-create) (mandatory) (1 byte)

Call waiting features: This attribute contains a bit map of call waiting features. The bit value 0 disables the feature; 1 enables it.

0x01	Call waiting
0x02	Caller ID announcement
0x04..0x80	Not used

The recommended default value is 0x00. (R, W, set-by-create) (mandatory) (1 byte)

Call progress or transfer features: This attribute is a bit map of call processing features. The bit value 0 disables the feature; 1 enables it.

0x0001	3way
0x0002	Call transfer
0x0004	Call hold (RFC 3264 sendonly SDP call hold)
0x0008	Call park
0x0010	Do not disturb
0x0020	Flash on emergency service call (flash is to be processed during an emergency service call)

0x0040	Emergency service originating hold (determines whether call clearing is to be performed on on-hook during an emergency service call)
0x0080	6way
0x0100	Call hold (RFC 2543 connection address 0.0.0.0 call hold)
0x0200..0x8000	Not used

The recommended default value is 0x0000. (R, W, set-by-create) (mandatory) (2 bytes)

Call presentation features: This attribute is a bit map of call presentation features. The bit value 0 disables the feature; 1 enables it.

0x0001	Message waiting indication splash ring
0x0002	Message waiting indication special dial tone
0x0004	Message waiting indication visual indication
0x0008	Call forwarding indication
0x0010	DC voltage based visual message waiting indicator (vmwi) (e.g., neon lamp on a phone to indicate a message waiting). For backwards compatibility reasons, the value 0x0010 is a companion value to 0x0004. If an ONU does not support DC voltage vmwi, the ONU uses other existing vmwi methods. If the ONU supports DC voltage vmwi and needs to apply DC voltage to turn on the phone lamp (to indicate message waiting), the values 0x0004 and 0x0010 are set.
0x0020..0x8000	Not used

The recommended default value is 0x0000. (R, W, set-by-create) (mandatory) (2 bytes)

Direct connect feature: This attribute is a bit map of characteristics associated with the direct connect feature. The bit value 0 disables the feature; 1 enables it.

0x01	Direct connect feature enabled
0x02	Dial tone feature delay option

The recommended default value is 0x00. (R, W, set-by-create) (mandatory) (1 byte)

Direct connect URI pointer: This attribute points to a network address ME that specifies the URI of the direct connect. If this attribute is set to a null pointer, no URI is defined. (R, W, set-by-create) (mandatory) (2 bytes)

Bridged line agent URI pointer: This attribute points to a network address ME that specifies the URI of the bridged line agent. If this attribute is set to a null pointer, no URI is defined. (R, W, set-by-create) (mandatory) (2 bytes)

Conference factory URI pointer: This attribute points to a network address ME that specifies the URI of the conference factory. If this attribute is set to a null pointer, no URI is defined. (R, W, set-by-create) (mandatory) (2 bytes)

Dial tone feature delay/warmline timer (new): This attribute defines the warmline timer/dial tone feature delay timer (seconds). The default value 0 specifies vendor-specific implementation. (R, W) (optional) (2 bytes)

IP host pointer: This attribute points to the IP host config data or IPv6 host config data ME associated with this VoIP config data ME. This attribute is only relevant when

the VoIP configuration method used attribute of this ME is set to configuration file retrieval (2) OR IETF sipping config framework (4). Upon instantiation ONU sets this value to NULL (0xFFFF) pointer. (R, W) (optional) (2 bytes)

Actions

Create, delete, get, set

Notifications

None.

9.9.9 VoIP feature access codes

The VoIP feature access codes ME defines administrable feature access codes for the VoIP subscriber. It is optional for ONUs that support VoIP services. If a non-OMCI interface is used to manage VoIP signalling, this ME is unnecessary.

Instances of this ME are created and deleted by the OLT. A VoIP feature access codes instance is needed for each unique set of feature access code attributes.

Relationships

An instance of this ME may be associated with one or more SIP user data MEs.

Attributes

Managed entity ID: This attribute uniquely identifies each instance of this ME. (R) (mandatory) (2 bytes)

The remaining attributes are access codes for the features mentioned in their names. Each attribute is a string of characters from the set {0..9, *, #}, with trailing nulls in any unused bytes.

Cancel call waiting:	(R, W) (optional) (5 bytes)
Call hold:	(R, W) (optional) (5 bytes)
Call park:	(R, W) (optional) (5 bytes)
Caller ID activate:	(R, W) (optional) (5 bytes)
Caller ID deactivate:	(R, W) (optional) (5 bytes)
Do not disturb activation:	(R, W) (optional) (5 bytes)
Do not disturb deactivation:	(R, W) (optional) (5 bytes)
Do not disturb PIN change:	(R, W) (optional) (5 bytes)
Emergency service number:	(R, W) (optional) (5 bytes)
Intercom service:	(R, W) (optional) (5 bytes)
Unattended/blind call transfer:	(R, W) (optional) (5 bytes)
Attended call transfer:	(R, W) (optional) (5 bytes)

Actions

Create, delete, get, set

Notifications

None.

9.9.10 Network dial plan table

The network dial plan table ME is optional for ONUs providing VoIP services. This ME is used to provision dial plans from the OLT. Instances of this ME are created and deleted by the OLT. If a non-OMCI interface is used to manage SIP for VoIP, this ME is unnecessary.

Relationships

An instance of this ME may be associated with one or more instances of the SIP user data ME.

Attributes

Managed entity ID: This attribute uniquely identifies each instance of this ME. (R, set-by-create) (mandatory) (2 bytes)

Dial plan number: This attribute indicates the current number of dial plans in the dial plan table. (R) (mandatory) (2 bytes)

Dial plan table max size: This attribute defines the maximum number of dial plans that can be stored in the dial plan table. (R, set-by-create) (mandatory) (2 bytes)

Critical dial timeout: This attribute defines the critical dial timeout for digit map processing, in milliseconds. The recommended default value is 4000 ms. (R, W, set-by-create) (mandatory) (2 bytes)

Partial dial timeout: This attribute defines the partial dial timeout for digit map processing, in milliseconds. The recommended default value is 16000 ms. (R, W, set-by-create) (mandatory) (2 bytes)

Dial plan format: This attribute defines the dial plan format standard that is supported in the ONU for VoIP. Valid values include the following.

- 0 Not defined
- 1 ITU-T H.248 format with a specific plan (table entries define the dialling plan)
- 2 NCS format [b-PKT-SP-NCS]
- 3 Vendor-specific format

(R, W, set-by-create) (mandatory) (1 byte)

Dial plan table: The table is the digit map that describes the dial plans used by the VoIP service, along with fields to manage the table. An example digit map is the string,

```
(0T|00T|[1-7]xxx|8xxxxxxxx|#xxxxxxxx|*xx|91xxxxxxxxxxxx|9011x.T)
```

Each row of the table comprises the following fields:

Dial plan ID: The row number, a unique identifier of a dial plan within the dial plan table (1 byte).

Action: Remove (0) or add (1) this plan (set action). When a dial plan is being removed, the dial plan token field is not used. (1 byte).

Dial plan token: The definition of the dial plan itself. In the previous example, tokens include the strings "0T" and "*xx". Unused trailing bytes may be padded with nulls or ASCII spaces. (28 bytes)

NOTE – Due to previously ambiguous documentation, implementations may vary. For interoperability, the OLT should write table entries as documented above, while it is encouraged for the ONU to accept any characters outside the formal grammar as delimiters and to accept the concatenation of rows as a single string that defines a digit map.

(R, W) (mandatory) (30 * N bytes, where N is the number of dial plans)

Actions

Create, delete, get, get next, set

Set table (optional)

Notifications

None.

9.9.11 VoIP line status

The VoIP line status ME contains line status information for POTS ports using VoIP services. An ONU that supports VoIP automatically creates or deletes an instance of this ME upon creation or deletion of a PPTP POTS UNI.

Relationships

An instance of this ME is associated with a PPTP POTS UNI.

Attributes

Managed entity ID: This attribute uniquely identifies each instance of this ME. Through an identical ID, this ME is implicitly linked to an instance of the PPTP POTS UNI. (R) (mandatory) (2 bytes)

Voip codec used: Reports the current codec used for a VoIP POTS port. Valid values are taken from [IETF RFC 3551], and are the same as specified in the codec selection attribute of the VoIP media profile. This attribute is meaningful only if the VoIP port session type attribute is not idle.

- 0 PCMU
- 1 reserved
- 2 reserved
- 3 GSM
- 4 ITU-T G.723
- 5 DVI4, 8 kHz
- 6 DVI4, 16 kHz
- 7 LPC
- 8 PCMA
- 9 ITU-T G.722
- 10 L16, 2 channels
- 11 L16, 1 channel
- 12 QCELP
- 13 CN
- 14 MPA
- 15 ITU-T G.728
- 16 DVI4, 11.025 kHz
- 17 DVI4, 22.050 kHz
- 18 ITU-T G.729

(R) (mandatory) (2 bytes)

Voip voice server status: Status of the VoIP session for this POTS port:

- 0 None/initial
- 1 Registered
- 2 In session
- 3 Failed registration – icmp error
- 4 Failed registration – failed tcp
- 5 Failed registration – failed authentication

- 6 Failed registration – timeout
- 7 Failed registration – server fail code
- 8 Failed invite – icmp error
- 9 Failed invite – failed tcp
- 10 Failed invite – failed authentication
- 11 Failed invite – timeout
- 12 Failed invite – server fail code
- 13 Port not configured
- 14 Config done
- 15 Disabled by switch

(R) (mandatory) (1 byte)

Voip port session type: This attribute reports the current state of a VoIP POTS port session:

- 0 Idle/none
- 1 2way
- 2 3way
- 3 Fax/modem
- 4 Telemetry
- 5 Conference

(R) (mandatory) (1 byte)

Voip call 1 packet period: This attribute reports the packet period for the first call on the VoIP POTS port. The value is defined in milliseconds. (R) (mandatory) (2 bytes)

Voip call 2 packet period: This attribute reports the packet period for the second call on the VoIP POTS port. The value is defined in milliseconds. (R) (mandatory) (2 bytes)

Voip call 1 dest addr: This attribute reports the DA for the first call on the VoIP POTS port. The value is an ASCII string. (R) (mandatory) (25 bytes)

Voip call 2 dest addr: This attribute reports the DA for the second call on the VoIP POTS port. The value is an ASCII string. (R) (mandatory) (25 bytes)

Voip line state: This attribute reports the state of the POTS line. This attribute may not be meaningful if the POTS port is administratively locked, is operationally disabled, or is being tested. Code points are assigned as follows:

- 0 Idle, on-hook
- 1 Off-hook dial tone
- 2 Dialling
- 3 Ringing or FSK alerting/data
- 4 Audible ringback
- 5 Connecting
- 6 Connected
- 7 Disconnecting, audible indication
- 8 ROH, no tone
- 9 ROH with tone
- 10 Unknown or undefined

(R) (optional) (1 byte)

Emergency call status: This attribute reports the current state of an emergency call session (when the ONU is the call originator) on the VoIP POTS port. The ONU determines the presence of an originating emergency call on the basis of the Emergency service number attribute of the VoIP feature access codes ME.

- 0 No emergency call in progress

1 Emergency call in progress

NOTE – The ONU may also be able to determine the presence of an emergency call on the basis of other, unspecified information.

(R) (Optional) (1 byte)

Actions

Get

Notifications

Attribute value change

Number	Attribute value change	Description
1..8	N/A	
9	Emergency call status	Indicates an update to the Emergency call status attribute
10..16	Reserved	

9.9.12 Call control performance monitoring history data

This ME collects PM data related to the call control channel. Instances of this ME are created and deleted by the OLT.

For a complete discussion of generic PM architecture, refer to clause I.4.

Relationships

An instance of this ME is associated with an instance of the PPTP POTS UNI ME.

Attributes

Managed entity ID: This attribute uniquely identifies each instance of this ME. Through an identical ID, this ME is implicitly linked to an instance of the PPTP POTS UNI. (R, set-by-create) (mandatory) (2 bytes)

Interval end time: This attribute identifies the most recently finished 15 min interval. (R) (mandatory) (1 byte)

Threshold data 1/2 ID: This attribute points to an instance of the threshold data 1 ME that contains PM threshold values. Since no threshold value attribute number exceeds 7, a threshold data 2 ME is optional. (R, W, set-by-create) (mandatory) (2 bytes)

Call setup failures: This attribute counts call set-up failures. (R) (mandatory) (4 bytes)

Call setup timer: This attribute is a high water-mark that records the longest duration of a single call set-up detected during this interval. Time is measured in milliseconds from the time an initial set-up was requested by the subscriber until the time at which a response was provided to the subscriber in the form of busy tone, audible ring tone, etc. (R) (mandatory) (4 bytes)

Call terminate failures: This attribute counts the number of calls that were terminated with cause. (R) (mandatory) (4 bytes)

Analog port releases: This attribute counts the number of analogue port releases without dialling detected (abandoned calls). (R) (mandatory) (4 bytes)

Analog port off-hook timer: This attribute is a high water-mark that records the longest period of a single off-hook detected on the analogue port. Time is measured in milliseconds. (R) (mandatory) (4 bytes)

Actions

Create, delete, get, set

Get current data (optional)

Notifications

Threshold crossing alert

Alarm number	Threshold crossing alert	Threshold value attribute No. (Note)
0	CCPM call set-up fail	1
1	CCPM set-up timeout	2
2	CCPM call terminate	3
3	CCPM port release with no dialling	4
4	CCPM port offhook timeout	5

NOTE – This number associates the TCA with the specified threshold value attribute of the threshold data 1 managed entity.

9.9.13 RTP performance monitoring history data

This ME collects PM data related to an RTP session. Instances of this ME are created and deleted by the OLT.

For a complete discussion of generic PM architecture, refer to clause I.4.

Relationships

An instance of this ME is associated with an instance of the PPTP POTS UNI ME.

Attributes

Managed entity ID: This attribute uniquely identifies each instance of this ME. Through an identical ID, this ME is implicitly linked to an instance of the PPTP POTS UNI ME. (R, set-by-create) (mandatory) (2 bytes)

Interval end time: This attribute identifies the most recently finished 15 min interval. (R) (mandatory) (1 byte)

Threshold data 1/2 ID: This attribute points to an instance of the threshold data 1 ME that contains PM threshold values. Since no threshold value attribute number exceeds 7, a threshold data 2 ME is optional. (R, W, set-by-create) (mandatory) (2 bytes)

RTP errors: This attribute counts RTP packet errors. (R) (mandatory) (4 bytes)

Packet loss: This attribute represents the fraction of packets lost. This attribute is calculated at the end of the 15 min interval, and is undefined under the get current data action. The value 0 indicates no packet loss, scaling linearly to 0xFFFF FFFF to indicate 100% packet loss (zero divided by zero is defined to be zero). (R) (mandatory) (4 bytes)

Maximum jitter: This attribute is a high water-mark that represents the maximum jitter identified during the measured interval, expressed in RTP timestamp units. (R) (mandatory) (4 bytes)

Maximum time between real-time transport control protocol (RTCP) packets: This attribute is a high water-mark that represents the maximum time between

RTCP packets during the measured interval, in milliseconds. (R) (mandatory)
(4 bytes)

Buffer underflows: This attribute counts the number of times the reassembly buffer underflows. In the case of continuous underflow caused by a loss of IP packets, a single buffer underflow should be counted. If the IW function is implemented with multiple buffers, such as a packet level buffer and a bit level buffer, then the underflow of either buffer increments this counter. (R) (mandatory)
(4 bytes)

Buffer overflows: This attribute counts the number of times the reassembly buffer overflows. If the IW function is implemented with multiple buffers, such as a packet level buffer and a bit level buffer, then the overflow of either buffer increments this counter. (R) (mandatory) (4 bytes)

Actions

Create, delete, get, set

Get current data (optional)

Notifications

Threshold crossing alert

Alarm number	Threshold crossing alert	Threshold value attribute No. (Note 2)
0	RTP errors	1
1	Packet loss(Note 1)	2
2	Maximum jitter	3
3	Max time between RTCP packets	4
4	Buffer underflows	6
5	Buffer overflows	7

NOTE 1 – Since packet loss is undefined until the end of the interval, this TCA may only be issued at the interval boundary, whereupon it is then immediately cleared.

NOTE 2 – This number associates the TCA with the specified threshold value attribute of the threshold data 1 managed entity.

9.9.14 SIP agent performance monitoring history data

This ME collects PM data for the associated VoIP SIP agent. Instances of this ME are created and deleted by the OLT.

For a complete discussion of generic PM architecture, refer to clause I.4.

Relationships

An instance of this ME is associated with a SIP agent config data or SIP config portal object.

Attributes

Managed entity ID: This attribute uniquely identifies each instance of this ME. Through an identical ID, this ME is implicitly linked to an instance of the corresponding SIP agent config data or to the SIP config portal. If a non-OMCI configuration method is used for VoIP, there can be only one live ME instance, associated with the SIP config portal, and with ME ID 0. (R, set-by-create) (mandatory)
(2 bytes)

- Interval end time:** This attribute identifies the most recently finished 15 min interval. (R) (mandatory) (1 byte)
- Threshold data 1/2 ID:** This attribute points to an instance of the threshold data 1 ME that contains PM threshold values. Since no threshold value attribute number exceeds 7, a threshold data 2 ME is optional. (R, W, set-by-create) (mandatory) (2 bytes)
- Transactions:** This attribute counts the number of new transactions that were initiated. (R) (optional) (4 bytes)
- Rx invite reqs:** This attribute counts received invite messages, including retransmissions. (R) (optional) (4 bytes)
- Rx invite retrans:** This attribute counts received invite retransmission messages. (R) (optional) (4 bytes)
- Rx noninvite reqs:** This attribute counts received non-invite messages, including retransmissions. (R) (optional) (4 bytes)
- Rx noninvite retrans:** This attribute counts received non-invite retransmission messages. (R) (optional) (4 bytes)
- Rx response:** This attribute counts total responses received. (R) (optional) (4 bytes)
- Rx response retransmissions:** This attribute counts total response retransmissions received. (R) (optional) (4 bytes)
- Tx invite reqs:** This attribute counts transmitted invite messages, including retransmissions. (R) (optional) (4 bytes)
- Tx invite retrans:** This attribute counts transmitted invite retransmission messages. (R) (optional) (4 bytes)
- Tx noninvite reqs:** This attribute counts transmitted non-invite messages, including retransmissions. (R) (optional) (4 bytes)
- Tx noninvite retrans:** This attribute counts transmitted non-invite retransmission messages. (R) (optional) (4 bytes)
- Tx response:** This attribute counts the total responses sent. (R) (optional) (4 bytes)
- Tx response retransmissions:** This attribute counts total response retransmissions sent. (R) (optional) (4 bytes)

Actions

Create, delete, get, set

Get current data (optional)

Notifications

Threshold crossing alert

Alarm number	Threshold crossing alert	Threshold value attribute No. (Note)
0	SIPAMD Rx invite req	1
1	SIPAMD Rx invite req retransmission	2
2	SIPAMD Rx noninvite req	3
3	SIPAMD Rx noninvite req retransmission	4

4	SIPAMD Rx response	5
5	SIPAMD Rx response retransmission	6
NOTE – This number associates the TCA with the specified threshold value attribute of the threshold data 1 managed entity.		

9.9.15 SIP call initiation performance monitoring history data

This ME collects PM data related to call initiations of a VoIP SIP agent. Instances of this ME are created and deleted by the OLT.

For a complete discussion of generic PM architecture, refer to clause I.4.

Relationships

An instance of this ME is associated with an instance of the SIP agent config data or SIP config portal ME.

Attributes

Managed entity ID: This attribute uniquely identifies each instance of this ME. Through an identical ID, this ME is implicitly linked to an instance of the SIP agent config data or the SIP config portal ME. If a non-OMCI configuration method is used for VoIP, there can be only one live ME instance, associated with the SIP config portal, and with ME ID 0. (R, set-by-create) (mandatory) (2 bytes)

Interval end time: This attribute identifies the most recently finished 15 min interval. (R) (mandatory) (1 byte)

Threshold data 1/2 ID: This attribute points to an instance of the threshold data 1 ME that contains PM threshold values. Since no threshold value attribute number exceeds 7, a threshold data 2 ME is optional. (R, W, set-by-create) (mandatory) (2 bytes)

Failed to connect counter: This attribute counts the number of times that the SIP UA failed to reach/connect its TCP/UDP peer during SIP call initiations. (R) (mandatory) (4 bytes)

Failed to validate counter: This attribute counts the number of times that the SIP UA failed to validate its peer during SIP call initiations. (R) (mandatory) (4 bytes)

Timeout counter: This attribute counts the number of times that the SIP UA timed out during SIP call initiations. (R) (mandatory) (4 bytes)

Failure received counter: This attribute counts the number of times that the SIP UA received a failure error code during SIP call initiations. (R) (mandatory) (4 bytes)

Failed to authenticate counter: This attribute counts the number of times that the SIP UA failed to authenticate itself during SIP call initiations. (R) (mandatory) (4 bytes)

Actions

Create, delete, get, set

Get current data (optional)

Notifications

Threshold crossing alert

Alarm number	Threshold crossing alert	Threshold value attribute No. (Note)
0	SIP call PM failed connect	1
1	SIP call PM failed to validate	2
2	SIP call PM timeout	3
3	SIP call PM failure error code received	4
4	SIP call PM failed to authenticate	5

NOTE – This number associates the TCA with the specified threshold value attribute of the threshold data 1 managed entity.

9.9.16 MGC config data

The MGC config data ME defines the MGC configuration associated with an MG subscriber. It is conditionally required for ONUs that support ITU-T H.248 VoIP services. If a non-OMCI interface is used to manage VoIP signalling, this ME is unnecessary.

Instances of this ME are created and deleted by the OLT.

Relationships

An instance of this ME may be associated with one or more VoIP voice CTP MEs.

Attributes

Managed entity ID: This attribute uniquely identifies each instance of this ME. (R, set-by-create) (mandatory) (2 bytes)

Primary MGC: This attribute points to a network address ME that contains the name (IP address or resolved name) of the primary MGC that controls the signalling messages. The port is optional and defaults to 2944 for text message formats and 2955 for binary message formats. (R, W, set-by-create) (mandatory) (2 bytes)

Secondary MGC: This attribute points to a network address ME that contains the name (IP address or resolved name) of the secondary or backup MGC that controls the signalling messages. The port is optional and defaults to 2944 for text message formats and 2955 for binary message formats. (R, W, set-by-create) (mandatory) (2 bytes)

TCP/UDP pointer: This attribute points to the TCP/UDP config data ME to be used for communication with the MGC. (R, W, set-by-create) (mandatory) (2 bytes)

Version: This integer attribute reports the version of the Megaco protocol in use. The ONU should deny an attempt by the OLT to set or create a value that it does not support. The value 0 indicates that no particular version is specified. (R, W, set-by-create) (mandatory) (1 byte)

Message format: This attribute defines the message format. Valid values are as follows.

- 0 Text long
- 1 Text short
- 2 Binary

The default value is recommended to be 0. (R, W, set-by-create) (mandatory) (1 byte)

Maximum retry time: This attribute specifies the maximum retry time for MGC transactions, in seconds. The default value 0 specifies vendor-specific implementation. (R, W) (optional) (2 bytes)

Maximum retry attempts: This attribute specifies the maximum number of times a message is retransmitted to the MGC. The recommended default value 0 specifies vendor-specific implementation. (R, W, set-by-create) (optional) (2 bytes)

Service change delay: This attribute specifies the service status delay time for changes in line service status. This attribute is specified in seconds. The default value 0 specifies no delay. (R, W) (optional) (2 bytes)

Termination ID base: This attribute specifies the base string for the ITU-T H.248 physical termination ID(s) for this ONU. This string is intended to uniquely identify an ONU. Vendor-specific termination identifiers (port IDs) are optionally added to this string to uniquely identify a termination on a specific ONU. (R, W) (optional) (25 bytes)

Softswitch: This attribute identifies the gateway softswitch vendor. The format is four ASCII coded alphabetic characters [A..Z] as defined in [ATIS-0300220]. A value of four null bytes indicates an unknown or unspecified vendor. (R, W, set-by-create) (mandatory) (4 bytes)

Message ID pointer: This attribute points to a large string whose value specifies the message identifier string for ITU-T H.248 messages originated by the ONU. (R, W, set-by-create) (optional) (2 bytes)

Actions

Create, delete, get, set

Notifications

Alarm

Alarm number	Alarm	Description
0	Timeout	Timeout of association with MG
1..207	Reserved	
208..223	Vendor-specific alarms	Not to be standardized

9.9.17 MGC performance monitoring history data

The MGC monitoring data ME provides run-time statistics for an active MGC association. Instances of this ME are created and deleted by the OLT.

For a complete discussion of generic PM architecture, refer to clause I.4.

Relationships

An instance of this ME is associated with an instance of the MGC config data or MGC config portal ME.

Attributes

Managed entity ID: This attribute uniquely identifies each instance of this ME. Through an identical ID, this ME is implicitly linked to an instance of the associated MGC config data or to the MGC config portal ME. If a non-OMCI configuration method is used for VoIP, there can be only one live ME instance, associated

with the MGC config portal, and with ME ID 0. (R, set-by-create) (mandatory) (2 bytes)

Interval end time: This attribute identifies the most recently finished 15 min interval. (R) (mandatory) (1 byte)

Threshold data 1/2 ID: This attribute points to an instance of the threshold data 1 ME that contains PM threshold values. Since no threshold value attribute number exceeds 7, a threshold data 2 ME is optional. (R, W, set-by-create) (mandatory) (2 bytes)

Received messages: This attribute counts the number of received Megaco messages on this association, as defined by [ITU-T H.341]. (R) (mandatory) (4 bytes)

Received octets: This attribute counts the total number of octets received on this association, as defined by [ITU-T H.341]. (R) (mandatory) (4 bytes)

Sent messages: This attribute counts the total number of Megaco messages sent over this association, as defined by [ITU-T H.341]. (R) (mandatory) (4 bytes)

Sent octets: This attribute counts the total number of octets sent over this association, as defined by [ITU-T H.341]. (R) (mandatory) (4 bytes)

Protocol errors: This attribute counts the total number of errors detected on this association, as defined by [ITU-T H.341]. This includes:

- syntax errors detected in a given received message;
- outgoing transactions that failed for protocol reasons.

(R) (mandatory) (4 bytes)

Transport losses: This attribute counts the total number of transport losses (e.g., socket problems) detected on this association. A link loss is defined as loss of communication with the remote entity due to hardware/transient problems, or problems in related software. (R) (mandatory) (4 bytes)

Last detected event: This attribute reports the last event detected on this association. This includes events such as the link failing or being set up. Under normal circumstances, a get action on this attribute would return 0 to indicate no abnormal activity. This field is an enumeration as follows.

- 0 No event – No event has yet been detected during this PM interval.
- 1 Link up – The transport link underpinning the association came up.
- 2 Link down – The transport link underpinning the association went down.
- 3 Persistent error – A persistent error was detected on the link (such as the socket/TCP connection to the remote node could not be set up).
- 4 Local shutdown – The association was brought down intentionally by the local application.
- 5 Failover down – The association was brought down as part of failover processing.
- 255 Other event – The latest event does not match any in the list.

(R) (mandatory) (1 byte)

Last detected event time: This attribute reports the time in seconds since the last event on this association was detected, as defined by [ITU-T H.341]. (R) (mandatory) (4 bytes)

Last detected reset time: This attribute reports the time in seconds since these statistics were last reset, as defined by [ITU-T H.341]. Under normal circumstances, a get

action on this attribute would return 900 s to indicate a completed 15 min interval. (R) (mandatory) (4 bytes)

Actions

Create, delete, get, set

Get current data (optional)

Notifications

Threshold crossing alert

Alarm number	Threshold crossing alert	Threshold value attribute No. (Note)
0	MGCP protocol errors	1
1	MGCP transport losses	2

NOTE – This number associates the TCA with the specified threshold value attribute of the threshold data 1 managed entity.

9.9.18 VoIP config data

The VoIP configuration data ME defines the configuration for VoIP in the ONU. The OLT uses this ME to discover the VoIP signalling protocols and configuration methods supported by this ONU. The OLT then uses this ME to select the desired signalling protocol and configuration method. The entity is conditionally required for ONUs that offer VoIP services.

An ONU that supports VoIP services automatically creates an instance of this ME.

Relationships

One instance of this ME is associated with the ONU.

Attributes

Managed entity ID: This attribute uniquely identifies each instance of this ME. There is only one instance, number 0. (R) (mandatory) (2 bytes)

Available signalling protocols: This attribute is a bit map that defines the VoIP signalling protocols supported in the ONU. The bit value 1 specifies that the ONU supports the associated protocol.

- 1 (LSB) SIP
- 2 ITU-T H.248
- 3 MGCP

(R) (mandatory) (1 byte)

Signalling protocol used: This attribute specifies the VoIP signalling protocol to use. Only one type of protocol is allowed at a time. Valid values are:

- 0 None
- 1 SIP
- 2 ITU-T H.248
- 3 MGCP
- 0xFF Selected by non-OMCI management interface

(R, W) (mandatory) (1 byte)

Available VoIP configuration methods: This attribute is a bit map that indicates the capabilities of the ONU with regard to VoIP service configuration. The bit value 1 specifies that the ONU supports the associated capability.

- 1 (LSB) ONU capable of using the OMCI to configure its VoIP services.
- 2 ONU capable of working with configuration file retrieval to configure its VoIP services.
- 3 ONU capable of working with [BBF TR-069] to configure its VoIP services.
- 4 ONU capable of working with IETF sipping config framework to configure its VoIP services.
- 5 ONU capable of working with [BBF TR-369] to configure its VoIP services.

Bits 56..24 are reserved by ITU-T. Bits 25..32 are reserved for proprietary vendor configuration capabilities. (R) (mandatory) (4 bytes)

VoIP configuration method used: Specifies which method is used to configure the ONU's VoIP service.

- 0 Do not configure – ONU default
- 1 OMCI
- 2 Configuration file retrieval
- 3 BBF TR-069
- 4 IETF sipping config framework
- 5 BBF TR-369
- 6..240 Reserved by ITU-T
- 241..255 Reserved for proprietary vendor configuration methods

(R, W) (mandatory) (1 byte)

VoIP configuration address pointer: If this attribute is set to any value other than a null pointer, it points to a network address ME, which indicates the address of the server to contact using the method indicated in the VoIP configuration method used attribute. This attribute is only relevant for non-OMCI configuration methods.

If this attribute is set to a null pointer, no address is defined by this attribute. However, the address may be defined by other methods, such as deriving it from the ONU identifier attribute of the IP host config data ME and using a well-known URI schema.

The default value is 0xFFFF (R, W) (mandatory) (2 bytes)

VoIP configuration state: Indicates the status of the ONU VoIP service.

- 0 Inactive: configuration retrieval has not been attempted
- 1 Active: configuration was retrieved
- 2 Initializing: configuration is now being retrieved
- 3 Fault: configuration retrieval process failed

Other values are reserved. At ME instantiation, the ONU sets this attribute to 0. (R) (mandatory) (1 byte)

Retrieve profile: This attribute provides a means by which the ONU may be notified that a new VoIP profile should be retrieved. By setting this attribute, the OLT triggers the ONU to retrieve a new profile. The actual value in the set action is ignored because it is the action of setting that is important. (W) (mandatory) (1 byte)

Profile version: This attribute is a character string that identifies the version of the last retrieved profile. (R) (mandatory) (25 bytes)

Actions

Get, set

Notifications

Attribute value change

Number	Attribute value change	Description
1..7	N/A	
8	Profile version	Version of last retrieved profile
9..16	Reserved	

Alarm

Alarm number	Alarm	Description
0	VCD config server name	Failed to resolve the configuration server name.
1	VCD config server reach	Cannot reach configuration server (the port cannot be reached, ICMP errors)
2	VCD config server connect	Cannot connect to the configuration server (due to bad credentials or other faults after the port has responded)
3	VCD config server validate	Cannot validate the configuration server
4	VCD config server auth	Cannot authenticate the configuration session (e.g., missing credentials)
5	VCD config server timeout	Timeout waiting for response from configuration server
6	VCD config server fail	Failure response received from configuration server
7	VCD config file error	Configuration file received has an error
8	VCD subscription name	Failed to resolve the subscription server name
9	VCD subscription reach	Cannot reach subscription server (the port cannot be reached, ICMP errors)
10	VCD subscription connect	Cannot connect to subscription server (due to bad credentials or other faults after the port has responded)
11	VCD subscription validate	Cannot validate subscription server
12	VCD subscription auth	Cannot authenticate subscription session (e.g., missing credentials)
13	VCD subscription timeout	Timeout waiting for response from subscription server
14	VCD subscription fail	Failure response received from subscription server
15	VCD reboot request	A non-OMCI management interface has requested a reboot of the ONU. NOTE – This alarm is used only to indicate the request and not to indicate that a reboot has actually taken place.
16	VCD Notify timeout	Failure to receive the NOTIFY that the server is required to send following acceptance of a SUBSCRIBE request.
17	VCD Notify malformed	Malformed NOTIFY request

Alarm

18	VCD Notify Rejected	NOTIFY request specifies that the subscription is terminated because it has been rejected by the server or the server has no resources to accept it (this may be received following a SUBSCRIBE to which the server returned a 202 (Accepted) response)
19..207	Reserved	
208..223	Vendor-specific alarms	Not to be standardized

9.9.19 SIP config portal

The SIP config portal ME provides a way for the OLT to discover the configuration text delivered to an ONU by a non-OMCI SIP VoIP configuration method ([BBF TR-069]/[BBF TR-369], sipping framework, etc.). Text retrieved from this ME is not required to be understood by the OLT or EMS, but it may be useful for human or vendor-specific analysis tools. See also the MGC config portal ME.

An instance of this ME may be created by an ONU that supports non-OMCI SIP configuration. It is not reported during an MIB upload.

Relationships

One instance of this ME is associated with the ONU.

Attributes

Managed entity ID: This attribute uniquely identifies each instance of this ME. There is one instance, number 0. (R) (mandatory) (2 bytes)

Configuration text table: This attribute is used to pass a textual representation of the VoIP configuration back to the OLT. The contents are vendor-specific. The get, get next sequence must be used with this attribute since its size is unspecified. Upon ME instantiation, the ONU sets this attribute to 0. (R) (mandatory) (*x* bytes)

Actions

Get, get next

Notifications

Attribute value change

Number	Attribute value change	Description
1	Configuration text	Indicates an update to the VoIP configuration from a non-OMCI interface. Because the attribute is a table, the AVC does not contain information about its value. The OLT must use the get, get next action sequence if it wishes to obtain the updated attribute content.
2..16	Reserved	

9.9.20 MGC config portal

The MGC config portal ME provides a way for the OLT to discover the configuration text delivered to an ONU by a non-OMCI ITU-T H.248 VoIP configuration method. Text retrieved from this ME is not required to be understood by the OLT or EMS, but it may be useful for human or vendor-specific analysis tools. See also the SIP config portal ME.

An instance of this ME may be created by an ONU that supports non-OMCI ITU-T H.248

configuration. It is not reported during an MIB upload.

Relationships

One instance of this ME is associated with the ONU.

Attributes

Managed entity ID: This attribute uniquely identifies each instance of this ME. There is one instance, number 0. (R, set-by-create) (mandatory) (2 bytes)

Configuration text table: This attribute is used to pass a textual representation of the VoIP configuration back to the OLT. The contents are vendor-specific. The get, get next sequence must be used with this attribute since its size is unspecified. Upon ME instantiation, the ONU sets this attribute to 0. (R) (mandatory) (x bytes)

Actions

Get, get next

Notifications

Attribute value change

Number	Attribute value change	Description
1	Configuration text	Indicates an update to the VoIP configuration from a non-OMCI interface. Because the attribute is a table, the AVC does not contain information about its value. The OLT must use the get, get next action sequence if it wishes to obtain the updated attribute content.
2..16	Reserved	

9.9.21 SIP agent config data 2

This ME supplements SIP agent config data ME. Instances of this ME are created and deleted by the OLT.

Relationships

An instance of this ME is associated with a SIP agent config data.

Attributes

Managed entity ID: This attribute uniquely identifies each instance of this ME. Through an identical ID, this ME is implicitly linked to an instance of the corresponding SIP agent config data. Note that this entity is associated with the primary SIP agent config data (if SIP agent is involved in protection). (R, set-by-create) (mandatory) (2 bytes)

In-Use-Options-Timer: This attribute defines the frequency that a SIP options packet is sent to the SIP proxy in-use. When a SIP options packet is not responded to by the SIP proxy, it is marked as unavailable. Otherwise, it is marked as available. Units are seconds. The default value 0 specifies vendor-specific implementation. (R, W, set-by-create) (mandatory) (2 byte)

Alternate-Options-Timer: This attribute defines the frequency that a SIP options packet is sent to the standby SIP proxy. When a SIP options packet is not responded to by the standby SIP proxy, it is marked as unavailable. Otherwise, it is marked as available. Units are seconds. The default value 0 specifies vendor-specific implementation. (R, W, set-by-create) (mandatory) (2 byte)

Revertive: This Boolean attribute specifies whether the SIP UA is involved in revertive (true) or non-revertive (false) switching. The default value is recommended to be false. (R, W, set-by-create) (mandatory) (1 byte)

Current proxy server resolved address: This attribute contains the resolved IP address of the in-use SIP proxy. If the value is 0.0.x.y, where x and y are not both 0, then x.y is to be interpreted as a pointer to a large string ME that represents an IPv6 address. Otherwise, the address is an IPv4 address (R) (optional) (4 bytes)

Current proxy server resolved name: This attribute contains a pointer to the large string ME that contains the resolved name of the SIP proxy in-use. (R) (optional) (2 bytes)

Alternate proxy server resolved address: This attribute contains the resolved IP address of the alternate SIP proxy. If the value is 0.0.x.y, where x and y are not both 0, then x.y is to be interpreted as a pointer to a large string ME that represents an IPv6 address. Otherwise, the address is an IPv4 address (R) (optional) (4 bytes)

Alternate proxy server resolved name: This attribute contains a pointer to the large string ME that contains the resolved name of the alternate SIP proxy. (R) (optional) (2 bytes)

Actions

Create, delete, get, set

Get current data (optional)

Notifications

None

9.10 Premises networks

This clause defines MEs associated with home networking UNIs, as shown in Figure 9.10-1.

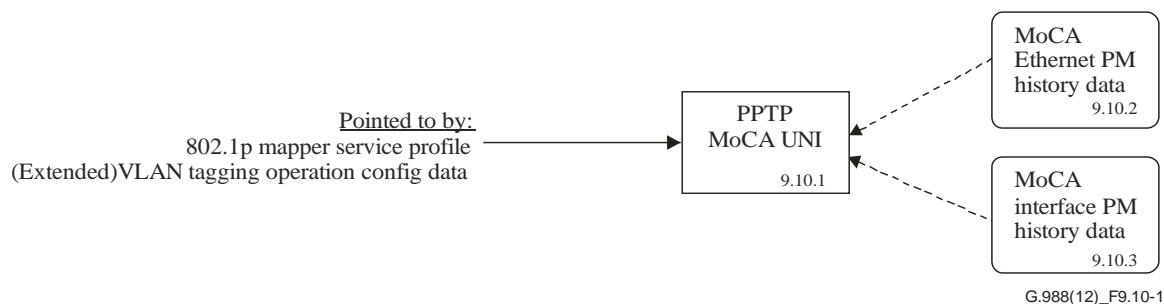

Figure 9.10-1 – Managed entities associated with home networking

9.10.1 Physical path termination point MoCA UNI

This ME represents an MoCA UNI, where physical paths terminate and physical path level functions are performed.

The ONU automatically creates an instance of this ME per port as follows.

- When the ONU has MoCA ports built into its factory configuration.
- When a cardholder is provisioned to expect a circuit pack of the MoCA type.
- When a cardholder provisioned for plug-and-play is equipped with a circuit pack of the MoCA type. Note that the installation of a plug-and-play card may indicate the presence of MoCA ports via equipment ID as well as its type, and indeed may cause the ONU to instantiate a port-mapping package that specifies MoCA ports.

The ONU automatically deletes instances of this ME when a cardholder is neither provisioned to expect an MoCA circuit pack, nor is it equipped with an MoCA circuit pack.

Relationships

An instance of this ME is associated with each real or pre-provisioned MoCA port.

Attributes

Managed entity ID: This attribute uniquely identifies each instance of this ME. This 2 byte number is directly associated with the physical position of the UNI. The first byte is the slot ID (defined in clause 9.1.5). The second byte is the port ID, with the range 1..255. (R) (mandatory) (2 bytes)

Loopback configuration: This attribute sets the MoCA loopback configuration. Note that normal bridge behaviour may defeat the loopback signal unless broadcast MAC addresses are used.

- 0 No loopback
- 3 Loopback3, loopback of downstream traffic after PHY transceiver, depicted in Figure 9.10.1-1.

Upon ME instantiation, the ONU sets this attribute to 0. (R, W) (optional) (1 byte)

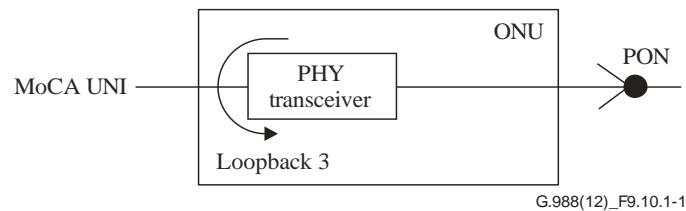

Figure 9.10.1-1 – MoCA loopback configuration

Administrative state: This attribute locks (1) and unlocks (0) the functions performed by this ME. Administrative state is further described in clause A.1.6. (R, W) (mandatory) (1 byte)

Operational state: This attribute indicates whether the ME is capable of performing its function. Valid values are enabled (0) and disabled (1). (R) (optional) (1 byte)

Max frame size: This attribute denotes the maximum frame size allowed across this interface. Upon ME instantiation, the ONU sets this attribute to 1518. (R, W) (mandatory) (2 bytes)

ARC: See clause A.1.4.3. (R, W) (optional) (1 byte)

ARC interval: See clause A.1.4.3. (R, W) (optional) (1 byte)

PPPoE filter: This attribute controls filtering of PPPoE packets on this MoCA port. When its value is 1, all packets other than PPPoE packets are discarded. The default 0 accepts packets of all types. (R, W) (optional) (1 byte)

Network status: This attribute indicates the networking state of the MoCA interface as follows.

- 0 The interface has not joined an MoCA network.
- 1 The interface has joined an MoCA network.
- 2 The interface has joined an MoCA network and is currently the network coordinator.

(R) (mandatory) (1 byte)

Password: This attribute specifies the MoCA encryption key. It is an ASCII string of 17 decimal digits. Upon ME instantiation, the ONU sets this attribute to 17 null bytes. (R, W) (mandatory) (17 bytes)

Privacy enabled: This attribute activates (1) link-layer security. The default value 0 deactivates it. (R, W) (mandatory) (1 byte)

Minimum bandwidth alarm threshold: This attribute specifies the minimum desired PHY link bandwidth between two nodes. If the actual bandwidth is lower, an LL alarm is declared. Valid values are 0 to 0x0410 (260 Mbit/s) in 0.25 Mbit/s increments. The default value is 0x02D0 (180 Mbit/s). The value 0 disables the threshold. (R, W) (optional) (2 bytes)

Frequency mask: This attribute is a bit map of the centre frequencies that the interface is permitted to use, where each bit represents a centre frequency. The LSB ($b[1]$) corresponds to centre frequency 800 MHz. The next significant bit ($b[2]$) corresponds to centre frequency 825 MHz. The 28th bit ($b[28]$) corresponds to centre frequency 1500 MHz. The four MSBs are not used. (R, W) (optional) (4 bytes)

RF channel: This attribute reports the frequency to which the MoCA interface is currently tuned, in megahertz. (R) (mandatory) (2 bytes)

Last operational frequency: This attribute reports the frequency to which the MoCA interface was tuned when last operational, in megahertz. (R) (mandatory) (2 bytes)

Actions

Get, set

Notifications

Attribute value change

Number	Attribute value change	Description
1..2	N/A	
3	Op state	Operational state
4	N/A	
5	ARC	ARC timer expiration
6..14	N/A	
15..16	Reserved	

Alarm

Alarm number	Alarm	Description
0	MoCA LOL	Loss of link at the MoCA interface
1	MoCA limited link (LL)	Bandwidth of link between two nodes on the MoCA network is less than the specified value
2..207	Reserved	
208..223	Vendor-specific alarms	Not to be standardized

9.10.2 MoCA Ethernet performance monitoring history data

This ME collects PM data for an MoCA Ethernet interface. Instances of this ME are created and deleted by the OLT.

For a complete discussion of generic PM architecture, refer to clause I.4.

Relationships

An instance of this ME is associated with an instance of the PPTP MoCA UNI ME.

Attributes

Managed entity ID: This attribute uniquely identifies each instance of this ME. Through an identical ID, this ME is implicitly linked to an instance of the PPTP MoCA UNI. (R, set-by-create) (mandatory) (2 bytes)

Interval end time: This attribute identifies the most recently finished 15 min interval. (R) (mandatory) (1 byte)

Threshold data 1/2 ID: This attribute points to an instance of the threshold data 1 and 2 MEs that contains PM threshold values. (R, W, set-by-create) (mandatory) (2 bytes)

Incoming PM refers to upstream traffic received on the UNI; outgoing PM refers to downstream traffic transmitted on the UNI.

- Incoming unicast packets:** (R) (optional) (4 bytes)
- Incoming discarded packets:** (R) (optional) (4 bytes)
- Incoming errored packets:** (R) (optional) (4 bytes)
- Incoming unknown packets:** (R) (optional) (4 bytes)
- Incoming multicast packets:** (R) (optional) (4 bytes)
- Incoming broadcast packets:** (R) (optional) (4 bytes)
- Incoming octets:** (R) (optional) (4 bytes)
- Outgoing unicast packets:** (R) (optional) (4 bytes)
- Outgoing discarded packets:** (R) (optional) (4 bytes)
- Outgoing errored packets:** (R) (optional) (4 bytes)
- Outgoing unknown packets:** (R) (optional) (4 bytes)
- Outgoing multicast packets:** (R) (optional) (4 bytes)
- Outgoing broadcast packets:** (R) (optional) (4 bytes)
- Outgoing octets:** (R) (optional) (4 bytes)

Actions

Create, delete, get, set

Notifications

Threshold crossing alert

Alarm number	Threshold crossing alert	Threshold value attribute No. (Note)
0	Incoming unicast packets	1
1	Incoming discarded packets	2
2	Incoming errored packets	3
3	Incoming unknown packets	4
4	Incoming multicast packets	5
5	Incoming broadcast packets	6
6	Incoming octets	7
7	Outgoing unicast packets	8

8	Outgoing discarded packets	9
9	Outgoing errored packets	10
10	Outgoing unknown packets	11
11	Outgoing multicast packets	12
12	Outgoing broadcast packets	13
13	Outgoing octets	14
NOTE – This number associates the TCA with the specified threshold value attribute of the threshold data 1/2 managed entities.		

9.10.3 MoCA interface performance monitoring history data

This ME collects PM data for an MoCA interface. Instances of this ME are created and deleted by the OLT.

NOTE – The structure of this ME is an exception to the normal definition of PM MEs and normal PM behaviour (clause I.4). It should not be used as a guide for the definition of future MEs. Among other exceptions, this ME contains only current values, which are retrievable by get and get next operations; no history is retained.

Relationships

An instance of this ME is associated with an instance of the PPTP MoCA UNI ME.

Attributes

Managed entity ID: This attribute uniquely identifies each instance of this ME. Through an identical ID, this ME is implicitly linked to an instance of the PPTP MoCA UNI. (R, set-by-create) (mandatory) (2 bytes)

Interval end time: This attribute identifies the most recently finished 15 min interval. (R) (mandatory) (1 byte)

Threshold data 1/2 ID: This attribute points to an instance of the threshold data 1 ME that contains PM threshold values. Since no threshold value attribute number exceeds 7, a threshold data 2 ME is optional. (R, W, set-by-create) (mandatory) (2 bytes)

PHY Tx broadcast rate: This attribute indicates the MoCA PHY broadcast transmit rate from the ONU MoCA interface to all the nodes in bits per second. (R) (optional) (4 bytes)

Node table: This attribute lists current nodes in the node table. The table contains MAC addresses and statistics for those nodes. These table attributes are further described in the following. Space for non-supported optional fields must be allocated in table records, and filled with zero bytes.

MAC address: A unique identifier of a node within the table. (6 bytes)

PHY Tx rate: MoCA PHY unicast transmit rate from the ONU MoCA interface to the node identified by the MAC address, in bits per second. (4 bytes)

Tx power control reduction: The reduction in transmitter level due to power control, in decibels. Valid values range from 0 (full power) to 60. (1 byte)

PHY Rx rate: MoCA PHY unicast receive rate to the ONU MoCA interface from the node identified by the MAC address, in bits per second. (optional) (4 bytes)

Rx power level: The power level received at the ONU MoCA interface from the node identified by the MAC address, in decibel-milliwatts, represented as a 2s complement integer. Valid values range from +10 (0x0A) to –80 (0xB0). (1 byte)

PHY Rx broadcast rate: MoCA PHY broadcast receive rate to the ONU MoCA interface from the node identified by MAC address, in bits per second. (optional) (4 bytes)

Rx broadcast power level: The power level received at the ONU MoCA interface from the node identified by the MAC address, in decibel-milliwatts, represented as a 2s complement integer. Valid values range from +10 (0x0A) to –80 (0xB0). (1 byte)

Tx packet: Number of packets transmitted to the node. (4 bytes)

Rx packet: Number of packets received from the node. (4 bytes)

Rx errored and missed: Number of errored and missed packets received from the node. The sum of this field across all entries in the node table contributes to the Rx errored and missed TCA. This field is reset to 0 on 15 min boundaries. (4 bytes)

Rx errored: Number of errored packets received from the node. The sum of this field across all entries in the node table contributes to the Rx errored TCA. This field is reset to 0 on 15 min boundaries. (optional) (4 bytes)

(R) (mandatory) (37 * N bytes, where N is the number of nodes in the node table)

Actions

Create, delete, get, get next, set

Notifications

Threshold crossing alert

Alarm number	Threshold crossing alert	Threshold value attribute No. (Note)
0	Total rx errored and missed	1
1	Total rx errored	2
NOTE – This number associates the TCA with the specified threshold value attribute of the threshold data 1 managed entity.		

9.11 This clause is intentionally left blank

9.12 General purpose managed entities

9.12.1 UNI-G

This ME organizes data associated with UNIs supported by GEM. One instance of the UNI-G ME exists for each UNI supported by the ONU.

The ONU automatically creates or deletes instances of this ME upon the creation or deletion of a real or virtual circuit pack ME, one per port.

Relationships

An instance of the UNI-G ME exists for each instance of a PPTP ME.

Attributes

Managed entity ID: This attribute uniquely identifies each instance of this ME. Through an identical ID, this ME is implicitly linked to an instance of a PPTP. (R) (mandatory) (2 bytes)

Deprecated: This attribute is not used. It should be set to 0 by the OLT and ignored by the ONU. (R, W) (mandatory) (2 bytes)

Administrative state: This attribute locks (1) and unlocks (0) the functions performed by this ME. Administrative state is further described in clause A.1.6. (R, W) (mandatory) (1 byte)

NOTE – PPTP MEs also have an administrative state attribute. The user port is unlocked only if both administrative state attributes are set to unlocked. It is recommended that this attribute not be used: that the OLT set it to 0 and that the ONU ignore it.

Management capability: An ONU may support the ability for some or all of its PPTPs to be managed either directly by the OMCI or from a non-OMCI management environment such as [BBF TR-069]/[[BBF TR-369](#)]. This attribute advertises the ONU's capabilities for each PPTP.

This attribute is an enumeration with the following code points:

- 0 OMCI only
- 1 Non-OMCI only. In this case, the PPTP may be visible to the OMCI, but only in a read-only sense, e.g., for PM collection.
- 2 Both OMCI and non-OMCI

(R) (optional) (1 byte)

Non-OMCI management identifier: If a PPTP can be managed either directly by the OMCI or a non-OMCI management environment, this attribute specifies how it is in fact to be managed. This attribute is either 0 (default = OMCI management), or it is a pointer to a VEIP, which in turn links to a non-OMCI management environment. (R, W) (optional) (2 bytes)

Relay agent options: This attribute is a pointer to a large string ME whose content specifies one or more DHCP relay agent options. (R, W) (optional) (2 bytes)

The contents of the large string are parsed by the ONU and converted into text strings. Variable substitution is based on defined three-character groups, each of which begins with the '%' character. The string '%%' is an escape mechanism whose output is a single '%' character. When the ONU cannot perform variable substitution on a substring of the large string, it generates the specified option as an exact quotation of the provisioned substring value.

Provisioning of the large string is separate from the operation of setting the pointer in this attribute. It is the responsibility of the OLT to ensure that the large string contents are correct and meaningful.

Three-character variable definitions are as follows. The first variable in the large string must specify one of the option types. Both options for a given IP version may be present if desired, each introduced by its option identifier. Terminology is taken from clause 3.9.3 of [b-BBF TR-101].

%01, %18

Specifies that the following string is for option 82 sub-option 1, agent circuit-ID (IPv4) or option 18, interface-ID (IPv6). The equivalence permits the same large string to be used in both IP environments.

%02, %37	Specifies that the following string is for option 82 sub-option 2, relay agent remote-ID (IPv4) or option 37, relay agent remote-ID (IPv6). The equivalence permits the same large string to be used in both IP environments.
%SL	In TR-101, this is called a slot. In an ONU, this variable refers to a shelf. It is meaningful if the ONU has multiple shelves internally or is daisy-chained to multiple equipment modules. The range of this variable is "0".. "99"
%SU	In TR-101, this is called a sub-slot. In fact, it represents a cardholder. The range of this variable is "0".. "99"
%PO	UNI port number. The range of this variable is "0".. "999"
%AE	ATM or Ethernet. This variable can take on the values "atm" or "eth".
%SV	S-VID for Ethernet UNI, or ATM VPI for ATM UNI, as it exists on the DHCP request received upstream across the UNI. Range "0".. "4096" for S-VID; range "0".. "255" for VPI. The value "4096" indicates no S-VID tag.
%CV	C-VID (Q-VID) for Ethernet UNI or ATM VCI for ATM UNI, as it exists on the DHCP request received upstream across the UNI. Range "0".. "4096" for C-VID; range "0".. "65535" for VCI. The value "4096" indicates no C-VID tag.

Spaces in the provisioned string are significant.

Example: if the large string were provisioned with the value

```
%01%SL/%SU/%PO:%AE/%SV.%CV<null>
```

then the ONU would generate the following DHCP option 82 agent circuit-ID string for an Ethernet UNI that sent a DHCP request with no S tag and C tag = 3210 on shelf 2, slot 3, port 4.

```
2/3/4:eth/4096.3210
```

With the same provisioning, the ONU would generate the following DHCP option 82 agent circuit-ID string for an ATM UNI that sent a DHCP request on VPI = 123 and VCI = 4567 on shelf 2, slot 3, port 4.

```
2/3/4:atm/123.4567
```

Actions

Get, set

Notifications

None.

9.12.2 OLT-G

This optional ME identifies the OLT to which an ONU is connected. This ME provides a way for the ONU to configure itself for operability with a particular OLT. It also provides a way for the OLT to communicate the time of day to the ONU.

An ONU that supports this ME automatically creates an instance of it. Immediately following the start-up phase, the OLT should set the ONU to the desired configuration. Interpretation of the OLT vendor ID, equipment ID and version attributes is a matter for negotiation between the two vendors involved.

Relationships

The single instance of this ME is associated with the ONU ME.

Attributes

Managed entity ID: This attribute uniquely identifies each instance of this ME. There is only one instance, number 0. (R) (mandatory) (2 bytes)

OLT vendor ID: This attribute identifies the OLT vendor. It is the same as the four most significant bytes of an ONU serial number specified in the respective TC layer specification. Upon instantiation, this attribute comprises all spaces. (R, W) (mandatory) (4 bytes)

Equipment ID: This attribute may be used to identify the specific type of OLT. The default value of all spaces indicates that equipment ID information is not available or applicable to the OLT being represented. (R, W) (mandatory) (20 bytes)

Version: This attribute identifies the version of the OLT as defined by the vendor. The default left-justified ASCII string "0" (padded with trailing nulls) indicates that version information is not available or applicable to the OLT being represented. (R, W) (mandatory) (14 bytes)

Time of day information: This attribute provides the information required to achieve time of day synchronization between a reference clock at the OLT and a local clock at the ONU. This attribute comprises two fields: the first field (4 bytes) is the sequence number of the specified GEM superframe. The second field (10 bytes) is TstampN as defined in clause 10.4.6 of [ITU-T G.984.3], clause 13.2 of [ITU-T G.987.3] and clause 13.2 of [ITU-T G.989.3], using the timestamp format of clause 5.3.3 of [IEEE 1588]. The value 0 in all bytes is reserved as a null value. (R, W) (optional) (14 bytes)

NOTE – In ITU-T G.987/ITU-T G.989 systems, the superframe count field of the time of day information attribute contains the 32 LSBs of the actual counter.

Actions

Get, set

Notifications

None.

9.12.3 Network address

The network address ME associates a network address with security methods required to access a server. It is conditionally required for ONUs that support VoIP services. The address may take the form of a URL, a fully qualified path or IP address represented as an ASCII string.

If a non-OMCI interface is used to manage VoIP signalling, this ME is unnecessary.

Instances of this ME are created and deleted by the OLT or the ONU, depending on the method used and case.

Relationships

Any ME that requires a network address may link to an instance of this ME.

Attributes

Managed entity ID: This attribute uniquely identifies each instance of this ME. Instances of this ME created autonomously by the ONU have IDs in the range 0..0x7FFF.

Instances created by the OLT have IDs in the range 0x8000..0xFFFFE. The value 0xFFFF is reserved. (R, set-by-create) (mandatory) (2 bytes)

Security pointer: This attribute points to an authentication security method ME. The authentication security method indicates the username and password to be used when retrieving the network address indicated by this ME. A null pointer indicates that security attributes are not defined for this network address. (R, W, set-by-create) (mandatory) (2 bytes)

Address pointer: This attribute points to the large string ME that contains the network address. It may contain a fully qualified domain name, URI or IP address. The URI may also contain a port identifier (e.g., "x.y.z.com:5060"). A null pointer indicates that no network address is defined. (R, W, set-by-create) (mandatory) (2 bytes)

Actions

Create, delete, get, set

Notifications

None.

9.12.4 Authentication security method

The authentication security method defines the user ID and password configuration to establish a session between a client and a server. This object may be used in the role of the client or server. An instance of this ME is created by the OLT if authenticated communication is necessary.

Relationships

One instance of this management entity may be associated with a network address ME. This ME may also be cited by other MEs that require authentication parameter management.

Attributes

Managed entity ID: This attribute uniquely identifies each instance of this ME. The value 0xFFFF is reserved. (R, set-by-create) (mandatory) (2 bytes)

Validation scheme: This attribute specifies the validation scheme used when the ONU validates a challenge. Validation schemes are defined as follows.

- 0 Validation disabled
- 1 Validate using MD5 digest authentication as defined in [IETF RFC 2617] (recommended)
- 3 Validate using basic authentication as defined in [IETF RFC 2617]

(R, W) (mandatory) (1 byte)

Username 1: This string attribute is the user name. If the string is shorter than 25 bytes, it must be null terminated (Note). (R, W) (mandatory) (25 bytes)

Password: This string attribute is the password. If the string is shorter than 25 bytes, it must be null terminated. (R, W) (mandatory) (25 bytes)

Realm: This string attribute specifies the realm used in digest authentication. If the string is shorter than 25 bytes, it must be null terminated. (R, W) (mandatory) (25 bytes)

Username 2: This string attribute allows for continuation of the user name beyond 25 characters (Note). Its default value is a null string. (R, W) (optional) (25 bytes)

NOTE – The total username is the concatenation of the username 1 and username 2 attributes if and only if: a) username 1 comprises 25 non-null characters; b) username 2 is supported by the ONU; and c) username 2 contains a leading non-null character string. Otherwise, the total username is simply the value of the username 1 attribute.

Actions

Create, delete, get, set

Notifications

None.

9.12.5 Large string

The large string ME holds character strings longer than 25 bytes, up to 375 bytes. It is maintained in up to 15 parts, each part containing 25 bytes. If the final part contains fewer than 25 bytes, it is terminated by at least one null byte. For example:

Number of parts	3
Part 1	sftp://myusername:mypassw
Part 2	ord@config.telecom.com:12
Part 3	34/path/to/filename<null>

Or

Number of parts	3
Part 1	sftp://myusername:mypassw
Part 2	ord@config.telecom.com:12
Part 3	34/path/to/longfilename<null>

Instances of this ME are created and deleted by the OLT. Under some circumstances, they may also be created by the ONU. To use this ME, the OLT or ONU instantiates the large string ME and then points to the created ME from other ME instances. Systems that maintain the large string should ensure that the large string ME is not deleted while it is still linked.

Relationships

An instance of this ME may be cited by any ME that requires a text string longer than 25 bytes.

Attributes

Managed entity ID: This attribute uniquely identifies each instance of this ME. The value 0xFFFF is reserved. When the large string is to be used as an IPv6 address, the value 0 is also reserved. The OLT should create large string MEs starting at 1 (or 0), and numbering upwards. The ONU should create large string MEs starting at 65534 (0xFFFFE) and numbering downwards. (R, set-by-create) (mandatory) (2 bytes)

Number of parts: This attribute specifies the number of non-empty parts that form the large string. This attribute defaults to 0 to indicate no large string content is defined. (R, W) (mandatory) (1 byte)

Fifteen additional attributes are defined in the following; they are identical. The large string is simply divided into as many parts as necessary, starting at part 1. If the end of the string does not lie at a part boundary, it is marked with a null byte.

**Part 1, Part 2, Part 3, Part 4, Part 5, Part 6, Part 7, Part 8, Part 9,
Part 10, Part 11, Part 12, Part 13, Part 14, Part 15:** (R, W) (mandatory)
(25 bytes * 15 attributes)

Actions

Create, delete, get, set

Notifications

Attribute value change

Number	Attribute value change	Description
1	Number of parts	
2	Part 1	
3	Part 2	
4	Part 3	
5	Part 4	
6	Part 5	
7	Part 6	
8	Part 7	
9	Part 8	
10	Part 9	
11	Part 10	
12	Part 11	
13	Part 12	
14	Part 13	
15	Part 14	
16	Part 15	

NOTE – Older implementations of the OMCI may not support this notification, which has been introduced in this version of this Recommendation.

9.12.6 Threshold data 1

Threshold data are partitioned into two MEs for historical reasons. An instance of this ME, together with an optional instance of the threshold data 2 ME, contains threshold values for counters in PM history data MEs.

For a complete discussion of generic PM architecture, refer to clause I.4.

Instances of this ME are created and deleted by the OLT.

Relationships

An instance of this ME may be related to multiple instances of PM history data type MEs.

Paired instances of threshold data 1 ME and threshold data 2 ME are implicitly linked together through a common ME ID.

Attributes

Managed entity ID: This attribute uniquely identifies each instance of this ME. (R, set-by-create) (mandatory) (2 bytes)

The following seven attributes specify threshold values for seven thresholded counters in associated PM history data MEs. The definition of each PM history ME includes a table that links each thresholded counter to one of these threshold value attributes.

Threshold value 1: (R, W, set-by-create) (mandatory) (4 bytes)

Threshold value 2: (R, W, set-by-create) (mandatory) (4 bytes)

Threshold value 3: (R, W, set-by-create) (mandatory) (4 bytes)

Threshold value 4: (R, W, set-by-create) (mandatory) (4 bytes)

Threshold value 5: (R, W, set-by-create) (mandatory) (4 bytes)

Threshold value 6: (R, W, set-by-create) (mandatory) (4 bytes)

Threshold value 7: (R, W, set-by-create) (mandatory) (4 bytes)

Actions

Create, delete, get, set

Notifications

None.

9.12.7 Threshold data 2

Together with an instance of the threshold data 1 ME, an instance of this ME contains threshold values for counters maintained in one or more instances of PM history data MEs.

For a complete discussion of generic PM architecture, refer to clause I.4.

Instances of this ME are created and deleted by the OLT.

Relationships

Refer to the relationships of the threshold data 1 ME.

Attributes

Managed entity ID: This attribute uniquely identifies each instance of this ME. Its value is the same as that of the paired threshold data 1 instance. (R, set-by-create) (mandatory) (2 bytes)

The following seven attributes specify threshold values for seven thresholded counters in associated PM history data MEs. The definition of each PM history ME includes a table that links each thresholded counter to one of these threshold value attributes.

Threshold value 8: (R, W, set-by-create) (mandatory) (4 bytes)

Threshold value 9: (R, W, set-by-create) (mandatory) (4 bytes)

Threshold value 10: (R, W, set-by-create) (mandatory) (4 bytes)

Threshold value 11: (R, W, set-by-create) (mandatory) (4 bytes)

Threshold value 12: (R, W, set-by-create) (mandatory) (4 bytes)

Threshold value 13: (R, W, set-by-create) (mandatory) (4 bytes)

Threshold value 14: (R, W, set-by-create) (mandatory) (4 bytes)

Actions

Create, delete, get, set

Notifications

None.

9.12.8 OMCI

This ME describes the ONU's general level of support for OMCI MEs and messages. This ME is not included in an MIB upload.

Relationships

One instance exists in the ONU. The ME entities are related to the OMCI entity.

Attributes

Managed entity ID: This attribute uniquely identifies each instance of this ME. There is only one instance, number 0. (R) (mandatory) (2 bytes)

ME type table: This attribute lists the ME classes supported by the ONU. Each entry contains the ME class value (see Table 11.2.4-1) of an ME type. (R) (mandatory) (2 * N bytes, where N is the number of entries in the list.)

Message type table: This attribute is a list of message types (MTs) supported by the ONU. Each entry contains the MT of an OMCI message (see Table 11.2.2-1). (R) (mandatory) (M bytes, where M is the number of entries in the list.)

Actions

Get, get next

Notifications

None.

9.12.9 Managed entity

The ME describes the details of each ME that is supported by the ONU. This ME is not included in an MIB upload.

Relationships

One or more MEs are related to the OMCI object entity.

Attributes

Managed entity ID: This attribute uniquely identifies each instance of this ME. Its value is equal to the ME type value, and is the same as the code found in the ME type table attribute of the OMCI ME and Table 11.2.4-1. (R) (mandatory) (2 bytes)

Name: This attribute contains a 25 byte ASCII coded mnemonic tag for the ME type. Strings shorter than 25 bytes are padded with null characters. (R) (mandatory) (25 bytes)

Attributes table: This table contains pointers to the attribute MEs that describe each of this ME's attributes. (R) (mandatory) (2 * X bytes, where X is the number of entries in the table.)

NOTE – The ME ID attribute is not included in the list, since the type of this attribute is fixed.

Access: This attribute represents who creates this ME. The following code points are defined.

- 1 Created by the ONU
- 2 Created by the OLT

3 Created by both the ONU and OLT

(R) (mandatory) (1 byte)

Alarms table: This attribute lists the alarm codes that are supported. (R) (mandatory) (Y bytes, where Y is the number of entries in the table.)

AVCs table: This attribute lists the AVCs that are supported. (R) (mandatory) (Z bytes, where Z is the number of entries in the table.)

Actions: This attribute lists the action codes supported on this object, formatted as a bit map. The action codes are the MTs from Table 11.2.2-1. The LSB represents action 0, and so on. (R) (mandatory) (4 bytes)

Instances table: This attribute is a list of pointers to all instances of this ME. (R) (mandatory) ($2 * V$ bytes, where V is the number of entries in the table.)

Support: This attribute represents the support capability of this ME in the ONU's implementation. This attribute does not declare whether the OMCI implementation complies with the Recommendations, but whether it complies with the OMCI declaration itself. The following code points are defined.

- 1 Supported (supported as defined in this object)
- 2 Unsupported (OMCI returns error code if accessed)
- 3 Partially supported (some aspects of ME supported)
- 4 Ignored (OMCI supported, but underlying function is not)

(R) (mandatory) (1 byte)

Actions

Get, get next

Notifications

None.

9.12.10 Attribute

This ME describes a particular attribute type that is supported by the ONU. This ME is not included in an MIB upload.

Relationships

One or more attribute entities are related to each ME entity. More than one ME entity can refer to a given attribute entity.

Attributes

Managed entity ID: This attribute uniquely identifies each instance of this ME. This number is the same as the one that appears in the attributes table in the ME. Only one instance of each unique attribute need be created. The ONU can assign attribute numbering as it pleases, out of the pool of 64K IDs; however, it is suggested that the numbering follow a rational scheme to aid human readability. (R) (mandatory) (2 bytes)

Name: This attribute contains a 25 byte mnemonic tag for the attribute. Strings shorter than 25 bytes are padded with null characters. (R) (mandatory) (25 bytes)

Size: This attribute contains the size of the attribute, in bytes. The value 0 indicates that the attribute can have a variable/unknown size. (R) (mandatory) (2 bytes)

Access: This attribute represents the OMCI access characteristics of the attribute. The following code points are defined.

- 1 Read
- 2 Write
- 3 Read, write
- 5 Read, set-by-create
- 6 Write, set-by-create
- 7 Read, write, set-by-create

(R) (mandatory) (1 byte)

Format: This attribute represents the format of the attribute. The following code points are defined.

- 1 Pointer
- 2 Bit field
- 3 Signed integer
- 4 Unsigned integer
- 5 String
- 6 Enumeration (that is, a set of defined code points)
- 7 Table

(R) (mandatory) (1 byte)

Lower limit: This attribute provides the lowest value for the attribute. Valid for numeric types (pointer, signed integer, unsigned integer) only. For attributes smaller than 4 bytes, the desired numeric value is expressed in 4 byte representation (for example, the 2s complement 1 byte integer 0xFE is expressed as 0xFFFF FFFE; the unsigned 1 byte integer 0xFE is expressed as 0x0000 00FE). (R) (mandatory) (4 bytes)

Upper limit: This attribute provides the highest value for the attribute. It has the same validity and format as the lower limit attribute. (R) (mandatory) (4 bytes)

Bit field: This attribute is a mask of the supported bits in a bit field attribute, valid for bit field type only. A 1 in any position signifies that its code point is supported, while 0 indicates that it is not supported. For bit fields smaller than 4 bytes, the attribute is aligned at the least significant end of the mask. (R) (mandatory) (4 bytes)

Code points table: This attribute lists the code points supported by an enumerated attribute. (R) (mandatory) ($2 * Q$ bytes, where Q is the number of entries in the table.)

Support: This attribute represents the level of support of the attribute (same notation as the attribute of the same name in the ME). The following code points are defined.

- 1 Fully supported (supported as defined in this object)
- 2 Unsupported (OMCI returns an error code if accessed)
- 3 Partially supported (some aspects of attribute supported)
- 4 Ignored (OMCI supported, but underlying function is not)

(R) (mandatory) (1 byte)

Actions

Get, get next

Notifications

None.

9.12.11 Octet string

The octet string is modelled on the large string ME. The large string is constrained to printable characters because it uses null as a trailing delimiter. The octet string has a length attribute and is therefore suitable for arbitrary sequences of bytes.

Instances of this ME are created and deleted by the OLT. To use this ME, the OLT instantiates the octet string ME and then points to the created ME from other ME instances. Systems that maintain the octet string should ensure that the octet string ME is not deleted while it is still linked.

Relationships

An instance of this ME may be cited by any ME that requires an octet string that can exceed 25 bytes in length.

Attributes

Managed entity ID: This attribute uniquely identifies each instance of this ME. The values 0 and 0xFFFF are reserved. (R, set-by-create) (mandatory) (2 bytes)

Length: This attribute specifies the number of octets that comprise the sequence of octets. This attribute defaults to 0 to indicate no octet string is defined. The maximum value of this attribute is 375 (15 parts, 25 bytes each). (R, W) (mandatory) (2 bytes)

In the following, 15 additional attributes are defined; they are identical. The octet string is simply divided into as many parts as necessary, starting at part 1 and left justified.

**Part 1, Part 2, Part 3, Part 4, Part 5, Part 6, Part 7, Part 8, Part 9,
Part 10, Part 11, Part 12, Part 13, Part 14, Part 15:**
(R, W) (part 1 mandatory, others optional) (25 bytes * 15 attributes)

Actions

Create, delete, get, set

Notifications

None.

9.12.12 General purpose buffer

This ME is created by the OLT when needed to store the results of an operation, such as a test command, that needs to return a block of data of indeterminate size. The buffer is retrieved with get next operations, since its size is not known *a priori*. An instance of this ME is created and deleted by the OLT, and typically made known to an ONU ME or to an action through a pointer.

The ME is defined as generically as possible, such that it can be used for other applications that may not initially be apparent, such as logging. The format of its content is specific to each application, and is documented there.

The general purpose buffer is neither captured in an MIB upload, nor retained in a non-volatile ONU memory.

Relationships

Through a pointer, the OLT may associate a general purpose buffer with an ME or an operation that has a need to create large or indeterminate blocks of data for subsequent upload.

Attributes

Managed entity ID: This attribute uniquely identifies each instance of this ME. (R, set-by-create) (mandatory) (2 bytes)

Maximum size: The ONU determines the actual size of the buffer table in the process of capturing the data directed to it. The maximum size attribute permits the OLT to restrict the maximum size of the buffer table. The value 0 indicates that the OLT imposes no limit on the size; it is recognized that ONU implementations will impose their own limits. The ONU will not create a buffer table larger than the value of this attribute. If the ONU cannot allocate enough memory to accommodate this size, it should deny the ME create action or a write operation that attempts to expand an existing ME. (R, W, set-by-create) (optional) (4 bytes)

Buffer table: This attribute is an octet string that contains the result of some operation performed on the ONU. The exact content depends on the operation, and is documented with the definition of each operation. (R) (mandatory) (*N* bytes)

Actions

Create, delete, get, get next

Notifications

Attribute value change

Number	Attribute value change	Description
1	N/A	
2	Buffer table	This AVC indicates that the ONU has completed writing the buffer, and thereby signals to the OLT that the operation is complete and the buffer is available for upload.
3..16	Reserved	

9.12.13 File transfer controller

This optional ME allows file transfers to be conducted out of band. It is intended to facilitate software image download, but may be used for other file transfer applications as well.

Relationships

One instance of this ME exists in an ONU that supports out-of-band file transfer.

Attributes

Managed entity ID: This attribute uniquely identifies each instance of this ME. There is one instance, whose value is 0. (R) (mandatory) (2 bytes)

Supported transfer protocols: This attribute is a bit map. Each bit indicates that the corresponding protocol is (1) or is not (0) supported for file transfers. TFTP is mandatory; the other protocols are optional. (R) (mandatory) (2 bytes)

Bit	Protocol
1 (LSB)	FTP
2	TFTP
3	SFTP
4	HTTP
5	HTTPS
6	FLUTE ([b-IETF RFC 3926]; multicast, download only)
7	DSM-CC (multicast, download only)

- 8..12 Reserved
- 13..16 Vendor-specific use; not to be standardized

File type: This attribute specifies the owner ME type of the file to be transferred. It is a value from Table 11.2.4-1. For example, for software image download, this attribute has the value 7. File systems on circuit packs are identified with the value 6, and on the ONU-G as a whole with the value 256. (R, W) (mandatory) (2 bytes)

File instance: This attribute specifies the instance of the file to be transferred. This attribute is the same as the ME ID attribute of the owner ME. (R, W) (mandatory) (2 bytes)

Local file name pointer: This attribute designates a large string ME that specifies a local file name. Since naming is not specified for any OMCI files, this attribute should be a null pointer in standard OMCI usage, e.g., in the software image case. The use of this attribute for named files is vendor-specific. (R, W) (mandatory) (2 bytes)

Network address pointer: This attribute is a pointer to a network address ME that specifies optional authentication information, along with the URI to be used for the file transfer. The URI should specify the protocol, one from the list of protocols supported by the ONU, an IP address or a string that can be resolved into an IP address, and optionally a port. For unidirectional multicast download (e.g., DSM-CC), the URI should specify a multicast IP source address. (R, W) (mandatory) (2 bytes)

File transfer trigger: This attribute causes the file transfer to begin. If a given set operation writes values to several attributes of this ME, the ONU should apply the file transfer trigger after updating all other attributes. Some operations may not be applicable to some files; the ONU should deny commands that request unsupported actions. (R, W) (mandatory) (1 byte)

Value	Meaning
0	Reserved
1	Initiate file download (to the ONU)
2	Initiate file upload (from the ONU)
3	Abort current file transfer
4	Delete target file (on the ONU)
5	Perform a directory listing operation. The scope of the directory is not specified; at the vendor's option, the listing may be filtered by matching some or all of file type, file instance and local file name attributes.
6..255	Reserved

File transfer status: This attribute reports the status of a file transfer. (R) (mandatory) (1 byte)

Value	Meaning
0	File transfer completed successfully
1	File transfer aborted successfully
2	File deleted
3	URL undefined or unreachable
4	Failure to authenticate
5	File transfer in progress
6	Remote failure

- 7 Local failure
- 8..255 Reserved

GEM IWTP pointer: This attribute is a pointer that specifies a unicast or multicast GEM IWTP, depending on whether the transfer protocol to be used is unicast or multicast. (R, W) (optional) (2 bytes)

VLAN: This attribute specifies the VLAN to be used for the transfer, assuming multicast protocol. The default value 0 indicates that no VLAN is specified. (R, W) (optional) (2 bytes)

File size: This attribute allows the OLT to specify the size of a file to be downloaded, in bytes. The ONU may use this value to reserve memory or to deny the download command if it has insufficient space. The default value 0 does not specify a file size. (R, W) (optional) (4 bytes)

Directory listing table: When a directory listing is complete, this attribute contains the result of a directory listing operation. The content and format of the table is not specified. (R) (optional) (*N* bytes)

Actions

Get, set

Notifications

Attribute value change

Number	Attribute value change	Description
1..6	N/A	
7	File transfer status	
8..10	N/A	
11	Directory listing table	This AVC signals to the OLT that a directory listing operation is complete and may be retrieved with a get, get next sequence.
12..16	Reserved	

9.12.14 Generic status portal

The generic status portal (GSP) ME provides a way for the OLT to discover the status and configuration information of a non-OMCI management domain within an ONU. The non-OMCI management domain is indicated by the VEIP associated with this GSP.

The GSP ME uses two table attributes to convey status and configuration from a non-OMCI managed domain to the OMCI. Each of these attributes uses an XML document to present this information. These XML documents are not required to be understood by the OLT or EMS. The schema for the documents may be used in the creation of tools that parse and interpret the contents of the document.

Relationships

One instance of this ME is created by the OLT for each separate non-OMCI management domain whose information is desired to be visible.

Attributes

Managed entity ID: This attribute uniquely identifies each instance of this ME. Through an identical ID, the GSP ME is implicitly linked to an instance of the VEIP ME. (R, set-by-create) (mandatory) (2 bytes). (R)

Status document table: This attribute is used to pass a textual representation of the non-OMCI managed domain status back to the OLT. The contents are vendor-specific and formatted as an XML document. The first element of the document must contain an XML declaration indicating the version of XML and encoding used in the remainder of the document. The second element of the document must contain a schema reference to the vendor-supplied schema used by the remainder of the document. The get, get next sequence must be used with this attribute since its size is unspecified. (R) (mandatory) (*N* bytes)

Configuration document table: This attribute is used to pass a textual representation of the non-OMCI managed domain configuration back to the OLT. The contents are vendor-specific and formatted as an XML document. The first element of the document must contain an XML declaration indicating the version of XML and encoding used in the remainder of the document. The second element of the document must contain a schema reference to the vendor-supplied schema used by the remainder of the document. The get, get next sequence must be used with this attribute since its size is unspecified. (R) (mandatory) (*M* bytes)

AVC report rate: This attribute governs the rate at which the GSP generates AVC notifications. The default value 0 disables AVCs, while the highest value 3, which may be useful for debugging, generates an AVC on every change seen in the non-OMCI management domain. As a guideline, the value 1 should collect changes into not more than one notification in 10 min, while value 2 should generate an AVC not more than once per second. (R, W, set-by-create) (optional) (1 byte)

Actions

Create, delete, Get, get next

Notifications

Attribute value change

Number	Attribute value change	Description
1	Status document table	Indicates an update to the status document table from a non-OMCI interface. Because the attribute is a table, the AVC does not contain information about its value. The OLT must use the get, get next action sequence if it wishes to obtain the updated attribute content.
2	Configuration document table	Indicates an update to the configuration document table from a non-OMCI interface. Because the attribute is a table, the AVC does not contain information about its value. The OLT must use the get, get next action sequence if it wishes to obtain the updated attribute content.
3..16	Reserved	

9.12.15 SNMP configuration data

The SNMP configuration data ME provides a way for the OLT to provision an IP path for an SNMP management agent.

The SNMP configuration data ME is created and deleted by the OLT.

Relationships

One instance of this ME is created by the OLT for each SNMP management path termination.

Attributes

- Managed entity ID:** This attribute uniquely identifies each instance of this ME. The ME IDs 0 and 0xFFFF are reserved. (R, set-by-create) (mandatory) (2 bytes)
- SNMP version:** This integer attribute is the SNMP protocol version to be supported. (R, W, set-by-create) (mandatory) (2 bytes)
- SNMP agent address:** This attribute is a pointer to a TCP/UDP config data ME, which provides the SNMP agent. (R, W, set-by-create) (mandatory) (2 bytes)
- SNMP server address:** This attribute is the IP address of the SNMP server. (R, W, set-by-create) (mandatory) (4 bytes)
- SNMP server port:** This attribute is the UDP port number of the SNMP server. (R, W, set-by-create) (mandatory) (2 bytes)
- Security name pointer:** This attribute points to a large string whose content represents the SNMP security name in a human-readable format that is independent of the security model. SecurityName is defined in [b-IETF RFC 2571]. (R, W, set-by-create) (mandatory) (2 bytes)
- Community for read:** This attribute is a pointer to a large string that contains the name of the read community. (R, W, set-by-create) (mandatory) (2 bytes)
- Community for write:** This attribute is a pointer to a large string that contains the name of the write community. (R, W, set-by-create) (mandatory) (2 bytes)
- Sys name pointer:** This attribute points to a large string whose content identifies the SNMP system name. SysName is defined in [b-IETF RFC 3418]. (R, W, set-by-create) (mandatory) (2 bytes)

Actions

Create, delete, Set, get

Notifications

None.

9.12.16 BBF TR-069 management server

If functions within the ONU are managed by [BBF TR-069], this ME allows OMCI configuration of the autoconfiguration server (ACS) URL and related authentication information for an ACS connection initiated by the ONU. [BBF TR-069] supports other means to discover its ACS, so not all BBF TR-069-compatible ONUs necessarily support this ME. Furthermore, even if the ONU does support this ME, some operators may choose not to use it.

An ONU that supports OMCI configuration of ACS information automatically creates instances of this ME.

Relationships

An instance of the BBF TR-069 management server ME exists for each instance of a BBF TR-069 management domain within the ONU.

Attributes

- Managed entity ID:** This attribute uniquely identifies each instance of this ME. Through an identical ID, this ME is implicitly linked to an instance of a VEIP that links to the BBF TR-069 management domain. (R) (mandatory) (2 bytes)

Administrative state: This attribute locks (1) and unlocks (0) the functions performed by this ME. When the administrative state is locked, the functions of this ME are disabled. BBF TR-069 connectivity to an ACS may be possible through means that do not depend on this ME. The default value of this attribute is locked. (R,W) (mandatory) (1 byte)

ACS network address: This attribute points to an instance of a network address ME that contains URL and authentication information associated with the ACS URL. (R, W) (mandatory) (2 bytes)

Associated tag: This attribute is a TCI value for BBF TR-069 management traffic passing through the VEIP. A TCI, comprising user priority, CFI and VID, is represented by 2 bytes. The value 0xFFFF specifies that BBF TR-069 management traffic passes through the VEIP with neither a VLAN nor a priority tag. (R, W) (mandatory) (2 bytes)

Actions

Get, set

9.12.17 Threshold data 64 bit

An instance of this ME contains threshold values for counters in PM history data MEs.

Instances of this ME are created and deleted by the OLT.

Relationships

An instance of this ME may be related to multiple instances of PM history data type MEs.

Attributes

Managed entity ID: This attribute uniquely identifies each instance of this ME. (R, set-by-create) (mandatory) (2 bytes)

The following attributes specify threshold values for thresholded counters in associated PM history data MEs. The definition of each PM history ME includes a table that links each thresholded counter to one of these threshold value attributes. The default values of these attributes are all 1s.

Threshold value 1: (R, W) (mandatory) (8 bytes)

Threshold value 2: (R, W) (mandatory) (8 bytes)

Threshold value 3: (R, W) (mandatory) (8 bytes)

Threshold value 4: (R, W) (mandatory) (8 bytes)

Threshold value 5: (R, W) (mandatory) (8 bytes)

Threshold value 6: (R, W) (mandatory) (8 bytes)

Threshold value 7: (R, W) (mandatory) (8 bytes)

Threshold value 8: (R, W) (mandatory) (8 bytes)

Threshold value 9: (R, W) (mandatory) (8 bytes)

Threshold value 10: (R, W) (mandatory) (8 bytes)

Threshold value 11: (R, W) (mandatory) (8 bytes)

Threshold value 12: (R, W) (mandatory) (8 bytes)

Threshold value 13: (R, W) (mandatory) (8 bytes)

Threshold value 14: (R, W) (mandatory) (8 bytes)

Actions

Create, delete, get, set

Notifications

None

9.12.18 OpenFlow config data

This ME contains the configuration data whose underlying transport method is OpenFlow. Instances of this ME are created and deleted by the OLT.

Relationships

An instance of this ME is associated with each instance per OpenFlow transportation channel. There might be more than one OpenFlow transportation channel per ONU.

Attributes

- Managed entity ID:** This attribute uniquely identifies each instance of this ME. (R, set-by-create) (mandatory) (2 bytes)
- TP type:** This attribute specifies the type of ANI-side TP associated with this ME.
1 GEM IW TP
(R, W, set-by-create) (mandatory) (1 byte)
- TP pointer:** This attribute points to the instance of the TP associated with this OpenFlow configuration data. The type of the associated TP is determined by the TP type attribute. (R, W, set-by-create) (mandatory) (2 bytes)
- Version:** This integer attribute reports the version of the OpenFlow protocol in use. The ONU should deny an attempt by the OLT to set or create a value that it does not support. The value 0 indicates that no particular version is specified. (R, W, set-by-create) (mandatory) (1 byte)
- DS OpenFlow message:** This attribute specifies the DS OpenFlow message which is carried over the OMCC channel. (R, W) (mandatory) (24N bytes)
- DS forwarding control:** This Boolean attribute indicates the current DS OpenFlow message is ready to be sent (true) or not. The default value is false. (R, W) (mandatory) (1 byte)
- DS receiving status:** This Boolean attribute indicates the ONU is ready to accept a new downstream packet (true) or not. The default value is false. (R) (mandatory) (1 byte)
- US OpenFlow message:** This attribute specifies the US OpenFlow message which is carried over the OMCC channel. (R, W) (mandatory) (24N bytes)
- US receiving control:** This Boolean attribute controls the current US OpenFlow message is safely received (true) or not. The default value is false. (R, W) (mandatory) (1 byte)
- US forwarding status:** This Boolean attribute reports the current US OpenFlow message is ready to be sent (true) or not. The default value is false. (R) (mandatory) (1 byte)
- Circuit ID:** This attribute identifies the first access information of the user
(R, W) (Optional) (24N byte)
- Remote ID:** This attribute identifies the second access information of the user as an addition identifier to circuit ID. (R, W) (Optional) (24N byte)

Administrative state: This attribute locks (1) and unlocks (0) the functions performed by the MPLS pseudowire TP. Administrative state is further described in clause A.1.6. (R, W) (optional) (1 byte)

Operational state: This attribute reports whether the ME is currently capable of performing its function. Valid values are enabled (0) and disabled (1). (R) (optional) (1 byte)

Actions

Create, delete, get, get next, set

Notifications

Attribute value change

Number	Attribute value change	Description
1..5	N/A	
6	DS receiving status	The DS packets receiving status has changed
7..8	N/A	
9	US forwarding status	A new ONU response has been loaded into the table for the OLT to retrieve
10-12	N/A	
13	Op state	Operational state
14..16	reserved	

9.12.19 Time status message

This ME provides status and characterization information for the time-transmitting node and its grandmaster. An ONU that supports time synchronization automatically creates an instance of this ME. The best practise is to set all the attributes at the same time.

Relationships

The single instance of this ME is associated with the ONU ME.

Attributes

Managed entity ID: This attribute uniquely identifies each instance of this ME. There is only one instance, number 0. (R) (mandatory) (2 bytes)

Domain number: Using the format of clause 7.1 of [IEEE 1588]. The default value is 0. (R, W) (mandatory) (1 byte)

Flag Field: The field format is given in the table. Value 1 represents "true". (R, W) (mandatory) (1 byte)

Bits	Usage
1 (LSB)	Leap61
2	Leap59
3	currentUtcOffsetValid
4	PTP timescale
5	Time traceable
6	Frequency traceable
7	Reserved
8 (MSB)	Reserved

currentUtcOffset: Provides the UTC offset value between the TAI and UTC timescales (UTC Offset = TAI – UTC), as specified in clause 7.2.3 of [IEEE 1588]. (R, W) (mandatory) (2 bytes)

Priority1: As specified in clause 7.6.2.2 of [IEEE 1588]. (R, W) (mandatory) (1 byte)

clockClass: Provides the clockClass information denoting the traceability of the time distributed by the grandmaster clock, as specified in clause 7.6.2.4 of [IEEE 1588]. (R, W) (mandatory) (1 byte)

Accuracy: Indicates the expected accuracy of a clock when it is the grandmaster, as specified in clause 7.6.2.5 of [IEEE 1588]. (R, W) (mandatory) (1 byte)

offsetScaledLogVariance: Provides the estimate of the time variance, as specified in clause 7.6.3 of [IEEE 1588]. (R, W) (mandatory) (2 bytes)

Priority2: As specified in clause 7.6.2.3 of [IEEE 1588]. (R, W) (mandatory) (1 byte)

Grandmaster ID: The clockIdentity attribute of the grandmaster, taken from the IEEE EUI-64 individual assigned numbers. (R, W) (mandatory) (8 bytes)

Steps removed: Provides the number of boundary clocks between the local clock and the master. (R, W) (mandatory) (2 bytes)

Time source: Indicates the source of time used by the grandmaster clock, as specified in clause 7.6.2.6 of [IEEE 1588]. (R, W) (mandatory) (1 byte)

Actions

Get, set

Notifications

None.

Alarm

Alarm number	Alarm	Description
0	Clock unlock	ITU-T G.781 clock unlock defect: If the status of the system clock is unlocked, a clock unlock is declared. The defect is cleared if the status of the system clock is "locked". Note that "unlocked" is a status of the clock, not a clock mode.

1	ESMC loss	ITU-T G.781 loss of ESMC channel. If no valid ESM PDU is received for 5 seconds, a loss of ESMC (LOESMC) is detected. The LOESMC defect is cleared upon the first ESMC PDU.
2	Time unlock	ITU-T G.781.1 time unlock (1PPS+TOD input). Alarm is declared when the system time is unlocked to the time source.
3..207	Reserved	Reserved for vendor-specific alarms.
208..223	Vendor-specific alarms	Not to be standardized

9.12.20 BBF TR-369 USP agent

The BBF TR-369 USP agent ME models a USP Agent and the configuration needed to establish communications between the USP Agent and a USP Controller.

[BBF TR-369] supports other means to discover its controller (e.g., pre-configured in firmware, DHCP/DNS/mDNS discovery, and through another known trusted controller). This ME is therefore optional (an ONU vendor may choose to implement it, and an operator may choose not to configure the USP controller through this ME if supported by the ONU vendor).

An ONU that supports OMCI configuration of USP information automatically creates instances of this ME

Relationships

An instance of the BBF TR-369 USP agent ME points to the virtual Ethernet interface point (VEIP) ME. This ME is used for associating USP as a non-OMCI management domain.

Attributes

Managed entity ID: This attribute uniquely identifies each instance of this ME. Through an identical ID, this ME is implicitly linked to an instance of a VEIP. (R) (mandatory) (2 bytes)

Available USP Message Transfer Protocols: This table is a list of IANA registered service-name for the available MTPs:

Service name: The service name of the USP MTP. It is a character string, padded with trailing nulls if it is shorter than 15 bytes (15 bytes)
(R) (mandatory) (15N bytes)

Controller table: Each record in the table (indexed by the controller network address) is comprised of the following fields:

Controller network address: This attribute points to an instance of a network address ME that contains an FQDN or absolute URL identifying the controller (e.g., "<scheme>://example.com:<port>[/<path>]"). (2 bytes)

Table control: This field controls the meaning of a set operation. The 1 byte size of this field is included in get/get-next operations, but its value is undefined under get-next and should be ignored by the OLT. (1 byte)

1 Add record to table; overwrite existing record, if any.

2 Delete record from table.

3 Clear all entries from table. This action may affect service and should be used judiciously.

Other values are reserved.

Associated tag: This field is a TCI value for BBF TR-369 management traffic passing through the VEIP. A TCI, comprising user priority, CFI and VID, is represented by 2 bytes. The value 0xFFFF specifies that BBF TR-369 management traffic passes through the VEIP with neither a VLAN nor a priority tag. (2 bytes)

Provisioning Code: This attribute points to a large string ME that contains the provisioning code (64 character UTF-8 string) that identifies the primary service provider and other provisioning information, which may be used by the Controller to determine service provider specific customization and provisioning parameters. A 0xFFFF null pointer indicates the absence of a provisioning code. (2 bytes)

USP retry minimum wait interval: This attribute configures the first retry wait interval in seconds as specified in TR-369 "Failure Handling in the session Context". The default value of 5 seconds is used. (2 bytes)

USP retry interval multiplier: This attribute configures the retry interval multiplier as specified in TR-369 "Failure Handling in the session Context". This value must be expressed in units of 0.001. Values range between 1000 and 65535. The default value of 2000 is used. (2 bytes)

Message Transfer Protocol (MTP) Used: The service name of the USP MTP. It is a character string, padded with trailing nulls if it is shorter than 15 bytes (15 bytes)

(R,W) (mandatory) (26N bytes)

Actions

Get, get next, set

Set table (optional)

Notifications

None.

9.13 Miscellaneous services

9.13.1 Physical path termination point video UNI

This ME represents an RF video UNI in the ONU, where physical paths terminate and physical path level functions are performed.

The ONU automatically creates an instance of this ME per port:

- when the ONU has RF video UNI ports built into its factory configuration;
- when a cardholder is provisioned to expect a circuit pack of the video UNI type;
- when a cardholder provisioned for plug-and-play is equipped with a circuit pack of the video UNI type. Note that the installation of a plug-and-play card may indicate the presence of video ports via equipment ID as well as its type, and indeed may cause the ONU to instantiate a port-mapping package that specifies video ports.

The ONU automatically deletes instances of this ME when a cardholder is neither provisioned to expect a video circuit pack, nor is it equipped with a video circuit pack.

Relationships

One or more instances of this ME are associated with an instance of a real or virtual circuit pack classified as video type.

Attributes

Managed entity ID: This attribute uniquely identifies each instance of this ME. This 2 byte number indicates the physical position of the UNI. The first byte is the slot ID (defined in clause 9.1.5). The second byte is the port ID, with the range 1..255. (R) (mandatory) (2 bytes)

Administrative state: This attribute locks (1) and unlocks (0) the functions performed by this ME. Administrative state is further described in clause A.1.6. (R, W) (mandatory) (1 byte)

Operational state: This attribute indicates whether the ME is capable of performing its function. Valid values are enabled (0) and disabled (1). (R) (optional) (1 byte)

ARC: See clause A.1.4.3. (R, W) (optional) (1 byte)

ARC interval: See clause A.1.4.3. (R, W) (optional) (1 byte)

Power control: This attribute controls whether power is provided from the ONU to an external equipment over the video PPTP. Value 1 enables power over coaxial cable. The default value 0 disables power feed. (R, W) (optional) (1 byte)

Actions

Get, set

Notifications

Attribute value change

Number	Attribute value change	Description
1	N/A	
2	Op state	Operational state of video UNI
3	ARC	ARC timer expiration
4..5	N/A	
6..16	Reserved	

Alarm

Alarm number	Alarm	Description
0	Video-LOS	No signal at the video UNI
1	Video-OOR-low	RF output below rated value
2	Video-OOR-high	RF output above rated value
3..207	Reserved	Reserved for vendor-specific alarms
208..223	Vendor-specific alarms	Not to be standardized

9.13.2 Physical path termination point video ANI

This ME represents an RF video ANI in the ONU, where physical paths terminate and physical path level functions are performed.

The ONU automatically creates an instance of this ME per port as follows.

- When the ONU has video ANI ports built into its factory configuration.
- When a cardholder is provisioned to expect a circuit pack of the video ANI type.

- When a cardholder provisioned for plug-and-play is equipped with a circuit pack of the video ANI type. Note that the installation of a plug-and-play card may indicate the presence of video ANI ports via equipment ID as well as its type, and indeed may cause the ONU to instantiate a port-mapping package that specifies video ANI ports.

The ONU automatically deletes instances of this ME when a cardholder is neither provisioned to expect a video ANI circuit pack, nor is it equipped with a video ANI circuit pack.

Relationships

An instance of this ME is associated with each instance of a real or pre-provisioned video ANI port.

Attributes

Managed entity ID: This attribute uniquely identifies each instance of this ME. This 2 byte number indicates the physical position of the ANI. The first byte is the slot ID (defined in clause 9.1.5). The second byte is the port ID, with the range 1..255. (R) (mandatory) (2 bytes)

Administrative state: This attribute locks (1) and unlocks (0) the functions performed by this ME. Administrative state is further described in clause A.1.6. (R, W) (mandatory) (1 byte)

Operational state: This attribute indicates whether the ME is capable of performing its function. Valid values are enabled (0) and disabled (1). (R) (optional) (1 byte)

ARC: See clause A.1.4.3. (R, W) (optional) (1 byte)

ARC interval: See clause A.1.4.3. (R, W) (optional) (1 byte)

Frequency range low: This attribute indicates the lower of the two possible frequency ranges supported. Different frequency ranges are indicated by code points:

0	No low band
1	50..550 MHz
2	50..750 MHz
3	50..870 MHz
4..255	Reserved

(R) (mandatory) (1 byte)

Frequency range high: This attribute indicates the higher of the two frequency ranges supported. Different frequency ranges are indicated by code points:

0	No high band
1	550..750 MHz
2	550..870 MHz
3	950..2050 MHz
4	2150..3250 MHz
5	950..3250 MHz
6..255	Reserved

(R) (mandatory) (1 byte)

Signal capability: This attribute indicates the capability of the ONU to measure the video signal level. Capabilities are indicated by code points, as follows.

- | | |
|--------|-------------------------------------------------------------------------|
| 0 | No signal level measurement capability |
| 1 | Total optical power level |
| 2 | Fixed frequency pilot tone power level |
| 3 | Total optical power level and fixed frequency pilot tone power level |
| 4 | Variable frequency pilot tone power level |
| 5 | Total optical power level and variable frequency pilot tone power level |
| 6 | Broadband RF power level |
| 7 | Total optical power level and broadband RF power level |
| 8..255 | Reserved |

(R) (mandatory) (1 byte)

Optical signal level: This attribute is an unsigned integer that returns the current measurement of the total optical signal level. The unit of this attribute is decibel-microwatt optical.

- If signal capability = 0, 2, 4 or 6, this attribute is undefined.
- If signal capability = 1, 3, 5 or 7, this attribute describes the total optical power that is generating photocurrent on the receiver.

(R) (optional) (1 byte)

Pilot signal level: This attribute indicates the current measurement of the pilot signal level or broadband RF level. The unit of this attribute is decibel-microvolt at the RF video service port.

- If signal capability = 0 or 1, then this attribute is undefined.
- If signal capability = 2, 3, 4 or 5, this attribute reports the pilot signal level at the output of the video UNI.
- If signal capability = 6 or 7, this attribute reports the total RF power level at the output of the video UNI.

(R) (optional) (1 byte)

Signal level min: This attribute indicates the minimum optical RF power per channel that results in a CNR of 47 dBc for a channel of 4.5 MHz bandwidth at a receive optical power of -5 dBm. The unit of this attribute is decibel-microwatt optical. (R) (mandatory) (1 byte)

Signal level max: This attribute indicates the maximum optical RF power per channel that results in a CTB of -57 dBc for an 80-channel ensemble of carriers at a per-channel optical modulation index (OMI) of 3.5%. The unit of this attribute is decibel-microwatt optical. (R) (mandatory) (1 byte)

Pilot frequency: This attribute specifies the frequency of the pilot channel receiver. The unit of this attribute is hertz.

- If signal capability = 0, 1, 6 or 7, this attribute is undefined.
- If signal capability = 2 or 3, this attribute is functionally RO.
- If signal capability = 4 or 5, this attribute is RW.

(R, W) (optional) (4 bytes)

AGC mode: This attribute allows the discovery and configuration of the ONU's AGC capabilities. The attribute contains a code point for several AGC types. The ONU displays the currently used AGC mode. The OLT can discover new

modes via the set command; the ONU denies attempts to set an unsupported mode. The code points are as follows.

- 0 No AGC
- 1 Broadband RF AGC
- 2 Optical AGC
- 3..255 Reserved

(R, W) (optional) (1 byte)

AGC setting: This attribute indicates the measurement offset that the ONU should use in AGC. The attribute has a step size of 0.1 dB, represented as a signed integer.

The theoretical nominal RF signal is 80 channels of NTSC video, each with a per-channel OMI of 3.5%. An ONU presented with such a signal should produce its specified output when this attribute is set to zero.

If total optical power is used for AGC, this attribute provides the OMI offset for any NTSC carriers present from the theoretical 3.5% value. For example, if the actual signal uses an OMI of 7.0% per channel (3 dB higher), then the ONU should be given an AGC setting of 30 (coded 0x1E).

If broadband RF power is used for AGC, this attribute provides the total power offset for any NTSC carriers present from the theoretical 80-channel value. For example, if an actual signal contains 40 NTSC channels (3 dB lower), then the ONU should be given an AGC setting of -30 (coded 0xE2).

(R, W) (optional) (1 byte)

Video lower optical threshold: This attribute specifies the optical level used to declare the video OOR low alarm. Valid values are -12 to +6 dBm in 0.1 dB increments, represented as a 2s complement integer. (Coding -120 to +60, where 0x00 = 0 dBm, 0x88 = -12.0 dBm, etc.) Upon ME instantiation, the ONU sets this attribute to 0xA1 (-9.5 dBm). (R, W) (optional) (1 byte)

NOTE – Because the power measurement returned in the optical signal level attribute has a resolution of 1 dB, it is possible that the measured value could appear to be in-range, even though an out-of-range alarm has been declared against a threshold with 0.1 dB resolution.

Video upper optical threshold: This attribute specifies the optical level used to declare the video OOR high alarm. Valid values are -12 to +6 dBm in 0.1 dB increments, represented as a 2s complement integer. (Coding -120 to +60, 0x00 = 0 dBm, 0x88 = -12.0 dBm, etc.) Upon ME instantiation, the ONU sets this attribute to 0x19 (+2.5 dBm). (R, W) (optional) (1 byte)

Actions

Get, set

Notifications

Attribute value change

Number	Attribute value change	Description
1	N/A	
2	Op state	Operational state of video ANI
3	ARC	ARC timer expiration
4..16	N/A	

Alarm

Alarm number	Alarm	Description
0	Video LOS	No signal at the video ANI
1	Video OOR low	Signal strength below lower optical threshold (optional)
2	Video OOR high	Signal strength above upper optical threshold (optional)
3..207	Reserved	
208..223	Vendor-specific alarms	Not to be standardized

9.13.3 Physical path termination point LCT UNI

This ME models debug access to the ONU from any physical or logical port, for example, via a dedicated LCT UNI, via ordinary subscriber UNIs, or via the IP host config ME.

The ONU automatically creates an instance of this ME per port:

- when the ONU has an LCT port built into its factory configuration;
- when a cardholder is provisioned to expect a circuit pack of the LCT type;
- when a cardholder provisioned for plug-and-play is equipped with a circuit pack of the LCT type;

NOTE – The installation of a plug-and-play card may indicate the presence of LCT ports via equipment ID as well as its type, and indeed may cause the ONU to instantiate a port-mapping package that specifies LCT ports.

- when the ONU supports debug access through some other physical or logical means.

The ONU automatically deletes an instance of this ME when a cardholder is neither provisioned to expect an LCT circuit pack, nor is it equipped with an LCT circuit pack, or if the ONU is reconfigured in such a way that it no longer supports debug access.

LCT instances are not reported during an MIB upload.

Relationships

An instance of this ME is associated with an instance of a real or virtual circuit pack ME classified as an LCT type. An instance of this ME may also be associated with the ONU as a whole, if the ONU supports debug access through means other than a dedicated physical LCT port.

Attributes

Managed entity ID: This attribute uniquely identifies each instance of this ME. This 2 byte number indicates the physical position of the UNI. The first byte is the slot ID (defined in clause 9.1.5). The second byte is the port ID, with the range 1..255. If the LCT UNI is associated with the ONU as a whole, its ME ID should be 0. (R) (mandatory) (2 bytes)

Administrative state: This attribute locks (1) and unlocks (0) the functions performed by this ME. Administrative state is described generically in clause A.1.6. The LCT has additional administrative state behaviour. When the administrative state is set to lock, debug access through all physical or logical means is blocked, except that the operation of a possible ONU remote debug ME is not affected. Administrative lock of ME instance 0 overrides administrative lock of any other PPTP LCT UNIs that may exist. (R, W) (mandatory) (1 byte)

Actions

Get, set

Notifications

None.

9.13.4 Interworking VCC termination point

An instance of this ME represents a point in the ONU where the IW of a service or underlying physical infrastructure (e.g., ADSL) to an ATM layer takes place. At this point, ATM cells are generated from a bit stream (e.g., Ethernet) or a bit stream is reconstructed from ATM cells.

Instances of this ME are created and deleted by the OLT.

Relationships

One instance of this ME exists for each occurrence of transformation of a data stream into ATM cells and *vice versa*.

Attributes

Managed entity ID: This attribute uniquely identifies each instance of this ME. (R, set-by-create) (mandatory) (2 bytes)

VCI value: This attribute identifies the VCI value associated with this IW VCC TP. (R, W, set-by-create) (mandatory) (2 bytes)

VP network CTP connectivity pointer: This attribute points to the VP network CTP associated with this IW VCC TP. (R, W, set-by-create) (mandatory) (2 bytes)

Deprecated 1: Not used; should be set to 0. (R, W, set-by-create) (mandatory) (1 byte)

Deprecated 2: Not used; should be set to 0. (R, W, set-by-create) (mandatory) (2 bytes)

AAL5 profile pointer: This attribute points to an instance of the AAL5 profile. (R, W, set-by-create) (mandatory) (2 bytes)

Deprecated 3: Not used; should be set to 0. (R, W, set-by-create) (mandatory) (2 bytes)

AAL loopback configuration: This attribute sets the ATM loopback configuration. All code points are retained for backward compatibility, but some are not expected to be needed in current and future applications.

- 0 No loopback
- 1 Loopback 1, loopback of downstream traffic before FEC of AAL1
- 2 Loopback 2, loopback of downstream traffic after FEC of AAL1
- 3 Loopback after AAL, loopback of downstream traffic after any AAL. Loopback after AAL is depicted in Figure 9.13.4-1.

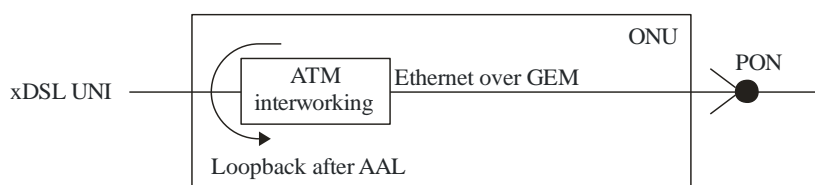

Figure 9.13.4-1 – AAL loopback configuration

The default value of this attribute is 0. (R, W) (mandatory) (1 byte)

PPTP counter: This value is the number of instances of PPTP MEs associated with this instance of the IW VCC TP. (R) (optional) (1 byte)

Operational state: This attribute indicates whether the ME is capable of performing its function. Valid values are enabled (0) and disabled (1). (R) (optional) (1 byte)

Actions

Create, delete, get, set

Notifications

Attribute value change

Number	Attribute value change	Description
1..8	N/A	
9	Op state	Operational state change
10..16	Reserved	

Alarm

Alarm number	Alarm	Description
0	End-to-end VC AIS layer management indication receiving (LMIR)	End-to-end VC-AIS receiving indication (optional)
1	End-to-end VC RDI LMIR	End-to-end VC-RDI receiving indication (optional)
2	End-to-end VC AIS layer management indication generation (LMIG)	End-to-end VC-AIS generation indication (optional)
3	End-to-end VC RDI LMIG	End-to-end VC-RDI generation indication (optional)
4	Segment loss of continuity	Loss of continuity detected when the interworking VCC termination point is a segment end point (optional)
5	End-to-end loss of continuity	Loss of continuity detected at the interworking VCC termination point (optional)
6	CSA	Cell starvation alarm
7..207	Reserved	
208..223	Vendor-specific alarms	Not to be standardized

9.13.5 AAL5 profile

This ME organizes data that describe the AAL type 5 processing functions of the ONU. It is used with the IW VCC TP ME.

This ME is created and deleted by the OLT.

Relationships

An instance of this ME may be associated with zero or more instances of the IW VCC TP.

Attributes

Managed entity ID: This attribute uniquely identifies each instance of this ME. (R, set-by-create) (mandatory) (2 bytes)

Max CPCS PDU size: This attribute specifies the maximum CPCS PDU size to be transmitted over the connection in both upstream and downstream directions. (R, W, set-by-create) (mandatory) (2 bytes)

AAL mode: This attribute specifies the AAL mode as follows.

- 0 Message assured
- 1 Message unassured
- 2 Streaming assured
- 3 Streaming non assured

(R, W, set-by-create) (mandatory) (1 byte)

SSCS type: This attribute specifies the SSCS type for the AAL. Valid values are as follows.

- 0 Null
- 1 Data SSCS based on SSCOP, assured operation
- 2 Data SSCS based on SSCOP, non-assured operation
- 3 Frame relay SSCS

(R, W, set-by-create) (mandatory) (1 byte)

Actions

Create, delete, get, set

Notifications

None.

9.13.6 AAL5 performance monitoring history data

This ME collects PM data as a result of performing segmentation and reassembly (SAR) and convergence sublayer (CS) level protocol monitoring. Instances of this ME are created and deleted by the OLT.

For a complete discussion of generic PM architecture, refer to clause I.4.

Relationships

An instance of this ME is associated with an instance of an IW VCC TP that represents AAL5 functions.

Attributes

Managed entity ID: This attribute uniquely identifies each instance of this ME. Through an identical ID, this ME is implicitly linked to an instance of the IW VCC TP. (R, set-by-create) (mandatory) (2 bytes)

Interval end time: This attribute identifies the most recently finished 15 min interval. (R) (mandatory) (1 byte)

Threshold data 1/2 ID: This attribute points to an instance of the threshold data 1 ME that contains PM threshold values. Since no threshold value attribute number exceeds 7, a threshold data 2 ME is optional. (R, W, set-by-create) (mandatory) (2 bytes)

Sum of invalid CS field errors: This attribute counts the sum of invalid CS field errors. For AAL type 5, this attribute is a single count of the number of CS PDUs discarded due to one of the following error conditions: invalid common part indicator (CPI), oversized received SDU, or length violation. (R) (mandatory) (4 bytes)

CRC violations: This attribute counts CRC violations detected on incoming SAR PDUs. (R) (mandatory) (4 bytes)

Reassembly timer expirations: This attribute counts reassembly timer expirations. (R) (mandatory if reassembly timer is implemented) (4 bytes)

Buffer overflows: This attribute counts the number of times where there was not enough buffer space for a reassembled packet. (R) (mandatory) (4 bytes)

Encap protocol errors: This attribute counts the number of times that [IETF RFC 2684] encapsulation protocol detected a bad header. (R) (mandatory) (4 bytes)

Actions

Create, delete, get, set

Get current data (optional)

Notifications

Threshold crossing alert

Alarm number	Threshold crossing alert	Threshold value attribute No. (Note)
0	Invalid fields	1
1	CRC violation	2
2	Reassembly timer expirations	3
3	Buffer overflows	4
4	Encap protocol errors	5

NOTE – This number associates the TCA with the specified threshold value attribute of the threshold data 1 managed entity.

9.13.7 This clause is intentionally left blank

9.13.8 This clause is intentionally left blank

9.13.9 VP network CTP

NOTE – In [ITU-T G.984.4], this ME is called VP network CTP-G.

This ME represents the termination of VP links on an ONU. It aggregates connectivity functionality from the network view and alarms from the network element view as well as artefacts from trails. Instances of this ME are created and deleted by the OLT.

An instance of the VP network CTP ME can be deleted only when no ATM IW VCC TP is associated with it. It is the responsibility of the OLT to ensure that this condition is met.

Relationships

Zero or more instances of the VP network CTP ME may exist for each instance of the IW VCC TP ME.

Attributes

Managed entity ID: This attribute uniquely identifies each instance of this ME. (R, set-by-create) (mandatory) (2 bytes)

VPI value: This attribute identifies the VPI value associated with the VP link being terminated. (R, W, set-by-create) (mandatory) (2 bytes)

UNI pointer: This pointer indicates the xDSL PPTP UNI associated with this VP TP. The bearer channel may be indicated by the two MSBs of the pointer. (R, W, set-by-create) (mandatory) (2 bytes)

Direction: This attribute specifies whether the VP link is used for UNI-to-ANI (value 1), ANI-to-UNI (value 2), or bidirectional (value 3) connection. (R, W, set-by-create) (mandatory) (1 byte)

Deprecated 1: Not used; should be set to 0. (R, W, set-by-create) (mandatory) (2 bytes)

Deprecated 2: Not used; should be set to 0. (R, W, set-by-create) (mandatory) (2 bytes)

Deprecated 3: Not used; should be set to 0. (R, W, set-by-create) (optional) (2 bytes)

Deprecated 4: Not used; if present, should be set to 0. (R) (optional) (1 byte)

Actions

Create, delete, get, set

Notifications

Alarm

Alarm number	Alarm	Description
0	VP AIS LMIR	VP-AIS receiving indication
1	VP RDI LMIR	VP-RDI receiving indication
2	VP AIS LMIG	VP-AIS generation indication
3	VP RDI LMIG	VP-RDI generation indication
4	Segment loss of continuity	Loss of continuity is detected when the VP network CTP is a segment end point
5	End-to-end loss of continuity	Loss of continuity can be detected when the VP network CTP supports an interworking VCC termination point
6..207	Reserved	
208..223	Vendor-specific alarms	Not to be standardized

9.13.10 VP performance monitoring history data

This ME collects PM data associated with a VP network CTP. Instances of this ME are created and deleted by the OLT.

Relationships

An instance of this ME is associated with an instance of the VP network CTP ME. The performance of upstream ATM flows is reported.

Attributes

Managed entity ID: This attribute uniquely identifies each instance of this ME. Through an identical ID, this ME is implicitly linked to an instance of the VP network CTP. (R, set-by-create) (mandatory) (2 bytes)

Interval end time: This attribute identifies the most recently finished 15 min interval. (R) (mandatory) (1 byte)

Threshold data 1/2 ID: This attribute points to an instance of the threshold data 1 ME that contains PM threshold values. Since no threshold value attribute number exceeds 7, a threshold data 2 ME is optional. (R, W, set-by-create) (mandatory) (2 bytes)

Lost C = 0 + 1 cells: This attribute counts all cell loss. It cannot distinguish between cells lost because of header bit errors, ATM-level header errors, cell policing, or buffer

overflows. It records only loss of information, independent of the priority of the cell. (R) (mandatory) (2 bytes)

Lost C = 0 cells: This attribute counts loss of high priority cells. It cannot distinguish between cells lost because of header bit errors, ATM-level header errors, cell policing, or buffer overflows. It records only loss of high priority cells. (R) (mandatory) (2 bytes)

Misinserted cells: This attribute counts cells that are misrouted to a monitored VP. (R) (mandatory) (2 bytes)

Transmitted C = 0 + 1 cells: This attribute counts cells originated by the transmitting end point (i.e., backward reporting is assumed). (R) (mandatory) (5 bytes)

Transmitted C = 0 cells: This attribute counts high priority cells originated by the transmitting end point (i.e., backward reporting is assumed). (R) (mandatory) (5 bytes)

Impaired blocks: This severely errored cell block counter is incremented whenever one of the following events takes place: the number of misinserted cells reaches its threshold; the number of bipolar violations reaches its threshold; or the number of lost cells reaches its threshold. Threshold values are based on vendor-operator negotiation. (R) (mandatory) (2 bytes)

Actions

Create, delete, get, set

Get current data (optional)

Notifications

Threshold crossing alert

Alarm number	Threshold crossing alert	Threshold value attribute No. (Note)
0	Lost CLP = 0 + 1 cells	1
1	Lost CLP = 0 cells	2
2	Misinserted cells	3
3	Impaired blocks	4
NOTE – This number associates the TCA with the specified threshold value attribute of the threshold data 1 managed entity.		

9.13.11 Enhanced security control

This ME contains the capabilities, parameters and controls of enhanced G-PON security features when they are negotiated via the OMCI (Note). The attributes in this ME are intended to be used to implement a symmetric-key-based three step authentication process as described in the supplemental information section in the following.

NOTE – If an ITU-T G.987 system uses 802.1X authentication as defined in [ITU-T G.987.3], the only applicable attribute of this ME is the broadcast key table.

Relationships

One instance of this ME is associated with the ONU ME.

Attributes

Managed entity ID: This attribute uniquely identifies each instance of this ME. There is only one instance, number 0. (R) (mandatory) (2 bytes)

OLT crypto capabilities: This attribute specifies the cryptographic mechanisms available at the OLT. It is written by the OLT during authentication step 1. It is formatted as a bit map, where a 1 bit indicates that the particular algorithm is supported, and a 0 bit indicates it is not supported.

Bit position	Algorithm
1 (LSB)	AES-CMAC-128 (support is mandatory)
2	HMAC-SHA-256
3	HMAC-SHA-512
4-128	Reserved

(W) (mandatory) (16 bytes)

OLT random challenge table: This attribute specifies the random challenge OLT_challenge issued by the OLT during authentication step 1. It is structured as a table, with each entry being 17 bytes. The first byte is the table row number, starting at 1, and the remaining 16 bytes are the contents of the entry. OLT_challenge is the concatenation of all 16 byte content fields. In normal use, the OLT will write all the entries in the table, and then trigger the ONU's processing of the entire table using the OLT challenge status attribute. The table size is known by the maximum index set by the OLT. The OLT can clear the table with a set operation to row 0. (R, W) (mandatory) (17 * N bytes)

NOTE – It is assumed that the length of OLT_challenge is always an integer multiple of 16 bytes.

OLT challenge status: This Boolean attribute controls the completion of authentication step 1. This attribute behaves as follows.

When the OLT performs the first of possibly several set operations to the OLT crypto capabilities or the OLT random challenge table attributes, a side effect of the set operation is that the ONU sets the OLT challenge status attribute to false.

When the OLT completes the set operation(s) to the OLT crypto capabilities and the OLT random challenge table attributes, then it sets the OLT challenge status attribute to true. This triggers the ONU to process the OLT random challenge table, using its choice of the OLT's candidate cryptographic hash algorithms.

The ONU initializes this attribute to the value false. (R, W) (mandatory) (1 byte)

ONU selected crypto capabilities: This attribute specifies the cryptographic capability selected by the ONU in authentication step 2. Its value specifies one of the bit positions that has the value 1 in the OLT crypto capabilities attribute. (R) (mandatory) (1 byte)

ONU random challenge table: This attribute specifies the random challenge ONU_challenge issued by the ONU during authentication step 2. It is structured as a table, with each entry being 16 bytes of content. ONU_challenge is the concatenation of all 16 byte content fields in the table. Once the OLT triggers a response to be generated using the OLT challenge status attribute, the ONU generates the response and writes the table (in a single operation). The AVC generated by this attribute signals to the OLT that the challenge is ready, so that the OLT can commence a get/get-next sequence to obtain the table's contents. (R) (mandatory) (16 * P bytes)

ONU authentication result table: (authentication step 2). This attribute contains the result of the authentication computation from the ONU (ONU_result), according to the ONU's selected crypto capabilities attribute.

ONU_result = SelectedHashFunction (PSK, (ONU_selected_crypto_capabilities | OLT_challenge | ONU_challenge | 0x0000 0000 0000 0000)),

where "|" denotes concatenation.

This attribute is structured as a table, with each entry being 16 bytes of content. The number of rows Q is implicit in the choice of hash algorithm.

Once the OLT triggers a response to be generated using the OLT challenge status attribute, the ONU generates ONU_result and writes the table (in a single operation). The AVC generated by this attribute signals to the OLT that the response is ready, so that the OLT can commence a get/get-next sequence to obtain the table's contents. (R) (mandatory) (16 * Q bytes)

OLT authentication result table: This attribute is used in authentication step 3. It contains OLT_result, the result of the authentication computation from the OLT.

OLT_result = SelectedHashFunction (PSK, (ONU_selected_crypto_capabilities | ONU_challenge | OLT_challenge | ONU_serial_number)).

The ONU_serial_number is the serial number attribute of the ONU-G ME, 8 bytes.

This attribute is structured as a table, with each entry being 17 bytes. The first byte is the table row number, starting at 1; the remaining 16 bytes are content. OLT_result is the concatenation of all 16 byte content fields. The OLT writes all entries into the table, and then triggers the ONU's processing of the table using the OLT result status attribute. The number of rows R is implicit in the choice of hash algorithm. The OLT can clear the table with a set operation to row 0. (W) (mandatory) (17 * R bytes)

OLT result status: (authentication step 3). This Boolean attribute controls and reports the status of the OLT authentication result table attribute. This attribute behaves as follows.

When the OLT performs the first of possibly several set operations to the OLT authentication result table attribute, a side effect of the set operation is that the ONU sets the OLT result status attribute to false.

When the OLT completes the set operation(s) to the OLT authentication result table, then it sets the OLT result status attribute to true. This triggers the ONU to process the OLT authentication result table.

(R, W) (mandatory) (1 byte)

ONU authentication status: This attribute indicates the status of the authentication relationship from the perspective of the ONU. It has the following values.

- 0 Indeterminate. This initial value indicates that the OMCI authentication process has not yet completed, and may not even have been started.
- 1 Reserved.
- 2 Reserved.
- 3 Authentication success: the procedure has completed at least once since the latest ONU activation and in its most recent execution, the ONU has authenticated the OLT.

- 4 Authentication failure: the procedure has completed at least once since the latest ONU activation, and either its most recent execution resulted in an error or the ONU has failed to authenticate the OLT.
- 5 Reserved.

Upon ONU activation, the ONU sets the attribute to the initial value. When the ONU authentication status has the value 3, encryption keys exchanged in the TC layer will be encrypted using the master session key (ITU-T G.984 systems) or the key encryption key (KEK, ITU-T G.987 systems). The OLT should check the value of this attribute before initiating a key switch.

(R) (mandatory) (1 byte)

Master session key name: Following successful authentication, this register contains the "name," or the hash signature, of the current master session key. The master session key is defined as:

MSK = SelectedHashFunction (PSK, (OLT_challenge | ONU_challenge)).

The master session key name is defined as:

MSKname = SelectedHashFunction (PSK, (ONU_challenge | OLT_challenge | 0x 3141 5926 5358 9793 3141 5926 5358 9793)).

If the selected hash function generates more than 128 bits, the result is truncated to the leftmost (most significant) 128 bits.

Upon the invalidation of a master session key (e.g., due to an ONU reset or deactivation, or due to an ONU-local decision that the master session key has expired), the ONU sets the master session key name to all zeros. (R) (mandatory) (16 bytes)

Broadcast key table: This attribute is defined only in ITU-T G.987 systems. It contains the broadcast key generated by the OLT. It is a table, each of whose rows is structured as follows.

Row control (1 byte): The two LSBs of this byte determine the attribute's behaviour under the set action. They always read back as 0 under the get next action.

- 00 Set the specified row.
- 01 Clear the specified row.
- 10 Clear the entire table.
- 11 Reserved.

The four MSBs specify the length of the fragment, which is left-justified in the key fragment field. The value 0 indicates 16 bytes of key fragment.

The other two bits are reserved.

Row identifier (1 byte): The two MSBs of this field are the key index, which appears in the header of encrypted multicast GEM frames. Key index 0 always indicates cleartext, and should therefore not appear in the identifier. The four LSBs identify the key fragment number, starting with 0. The other two bits are reserved.

Key fragment (16 bytes): This field contains the specified fragment of the key (encrypted with AES-ECB using the KEK).

(R, W) (optional) (18N bytes)

Effective key length: This attribute specifies the maximum effective length, in bits, of keys generated by the ONU. (R) (optional) (2 bytes)

Actions

Get, set, get next

Notifications

Attribute value change

Number	Attribute value change	Description
1..4	Reserved	
5	ONU random challenge table	A new ONU challenge has been loaded into the table for the OLT to retrieve
6	ONU authentication result table	A new ONU response has been loaded into the table for the OLT to retrieve
7..8	Reserved	
9	ONU authentication status	The ONU authentication status has changed
10..16	Reserved	

Supplementary information

This ME contains the facilities to perform a conventional three step hash-based authentication sequence found in [ISO/IEC 9798-4] (used in DSL systems that employ MS-CHAPv2 and elsewhere) using get and set messages.

The logical structure of the conventional three step sequence is as follows. In the present situation, peer 1 is the OLT and peer 2 is the ONU.

Message 1: (Peer 1 → peer 2) my_cryptographic_capabilities | random_challenge_1

Message 2: (Peer 2 → peer 1): selected_cryptographic_capabilities | random_challenge_2 |
MsgHash (PSK, (selected_cryptographic_capabilities | random_challenge_1 |
random_challenge_2, peer_1_identity))

Message 3: (Peer 1 → peer 2): MsgHash (PSK, (selected_cryptographic_capabilities |
random_challenge_2 | random_challenge_1 | peer_2_identity))

Where:

MsgHash () is a keyed hash function of the message

PSK is the pre-shared secret key known to the peers of the session

Peer_1_identity is always "0x0000 0000 0000 0000"

Peer_2_identity is the ONU serial number

The prerequisite is the availability of a PSK. A PSK of 128 bits simplifies the application of security algorithms based on AES-128 (e.g., AES-CMAC-128). A PSK is associated with a particular ONU and is stored at that ONU and at the operator infrastructure. On the operator side, the PSK for a particular ONU might be stored in the physically connected OLT, or at a central server that the OLT accesses during authentication. Configuration of the PSK into the ONU and into the operator infrastructure may be done in any manner that satisfies these requirements.

In the OMCI, the authentication message sequence follows the steps illustrated in Figure 9.13.11-1.

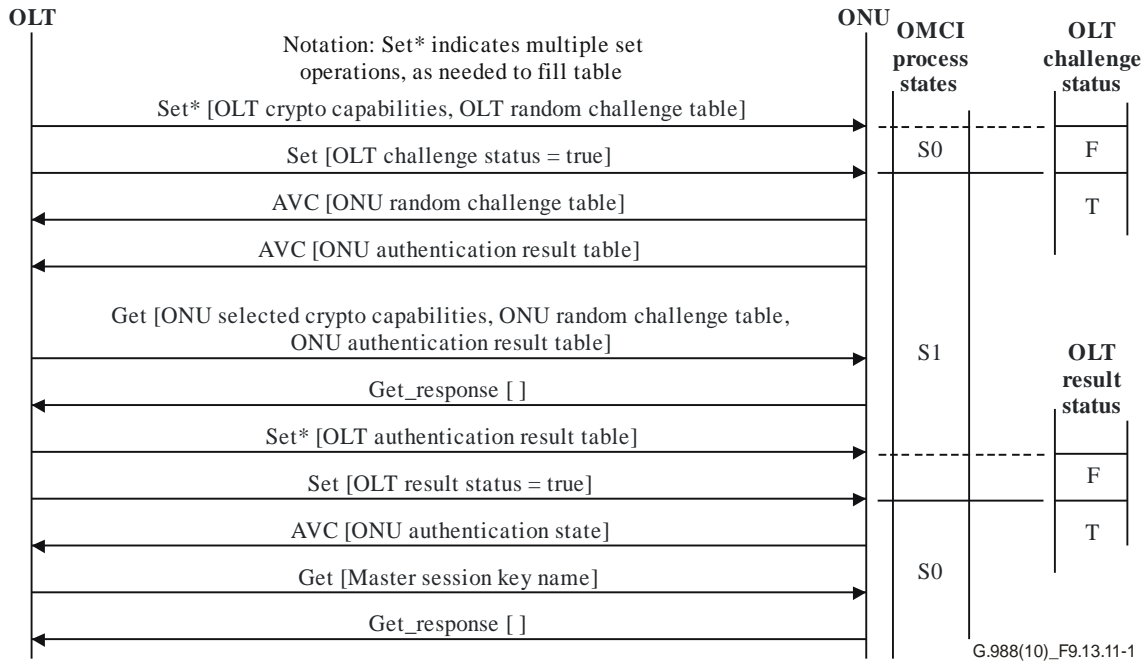

Figure 9.13.11-1 – Authentication message exchange sequence

States of the OMCI authentication process

When an ONU is in operation state O5, as defined in the respective TC layer specification, it maintains an OMCI authentication process state machine that tracks the phase of the authentication-related OMCI message flow exchange. The OMCI authentication process state machine is driven by the OLT challenge and result status indications, and generates output that indicates the ONU authentication status.

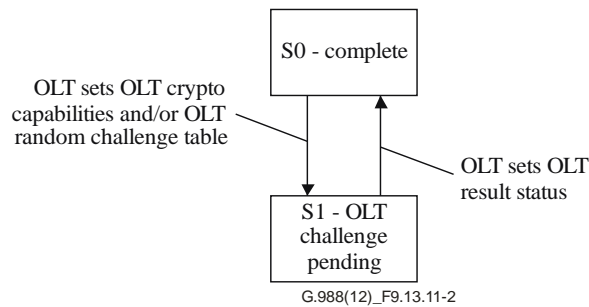

Figure 9.13.11-2 – ONU state diagram

Synchronization with TC layer and security considerations (ITU-T G.984 systems only)

When the ONU is in authenticated state, it uses its master session key to encrypt the key transmitted in the encryption_key PLOAM message.

The master session key is defined as:

$$\text{MasterSessionKey} = \text{SelectedHashFunction}(\text{PSK}, (\text{OLT_challenge} \mid \text{ONU_challenge}))$$

where SelectedHashFunction () is the hash function selected by the ONU in the ONU selected crypto capabilities attribute from the list supplied by the OLT.

The encryption of the encryption key is performed using AES-128 in electronic codebook (ECB) mode.

Since the encryption key carried in the encryption key PLOAM message is not protected against forgery, there is the possibility that the key can be forged or replayed by an attacker. Both forged and replayed keys can be detected with key synchronization mechanisms. A replay attack, however, could force the OLT to use an old encryption key, which would violate the security requirements of downstream data encryption. Consequently, an OLT designed to resist a replay attack should ensure that the ONU does not send a previously used encryption key between authentication cycles.

9.14 Mid-span passive optical network reach extender

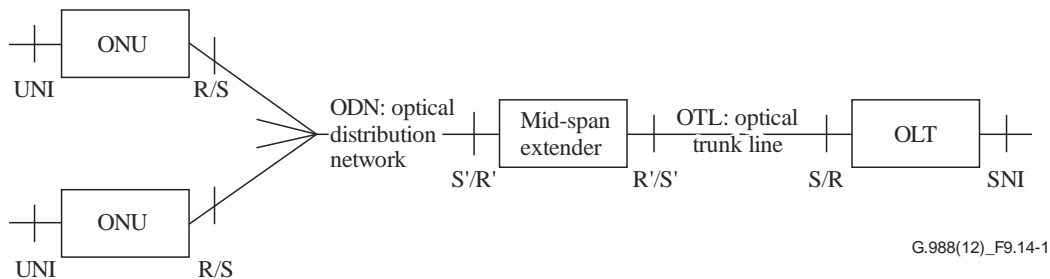

Figure 9.14.1 – Mid-span PON reach extender

[ITU-T G.984.6] defines a mid-span PON RE. An RE may extend more than one PON, using optical amplification (OA) or optical-electrical-optical (OEO) regeneration technology. For easy reference, Figure 9.14-1 illustrates the interface designations.

The RE model includes one built-in ONU, which serves for management of the RE itself, as well as for optional subscriber or craft UNIs. The ONU embedded within the RE is therefore able to use any of the MEs defined elsewhere in this Recommendation, including the ANI-G and T-CONT MEs, which represent the built-in ONU's individual uplink.

NOTE 1 – Although the built-in management ONU is physically contained within physical RE equipment, the management model perspective is that the ONU software controls the entire equipment. In terms of the model, therefore, the management ONU contains the RE equipment and functionality.

This clause defines additional MEs that pertain to the RE function separately.

The current scope of the RE model includes the use of either OEO regeneration or OA in the upstream and downstream directions, independently. Split ratio enhancement (more than one RE UNI for every RE ANI) is also included. This results in eight possible arrangements, are listed in the following tables.

NOTE 2 – Each amplifier ME is associated with an RE common amplifier parameters ME.

Downstream technology	Upstream technology	Internal optical split	Model
OEO	OEO	1:1	One PPTP RE UNI pointing to one RE ANI-G, all attributes active
OEO	OEO	1:N	N PPTP RE UNIs pointing to one RE ANI-G, all attributes active
OA	OA	1:1	One RE upstream amplifier pointing to one RE downstream amplifier
OA	OA	1:N	N RE upstream amplifiers pointing to one RE downstream amplifier

Downstream technology	Upstream technology	Internal optical split	Model
OA	OEO	1:1	One PPTP RE UNI pointing to one RE ANI-G. Downstream transmit optical attributes of the RE ANI-G not used. One downstream amplifier, likely sharing ME ID with the RE ANI-G.
OA	OEO	1:N	N PPTP RE UNIs pointing to one RE ANI-G. Downstream transmit optical attributes of the RE ANI-G not used. One downstream amplifier, likely sharing ME ID with the RE ANI-G.
OEO	OA	1:1	One PPTP RE UNI pointing to one RE ANI-G. Upstream transmit optical attributes of the RE UNI not used. One upstream amplifier, likely sharing ME ID with the PPTP RE UNI.
OEO	OA	1:N	N PPTP RE UNIs pointing to one RE ANI-G. Upstream transmit optical attributes of the RE UNI not used. <i>N</i> upstream amplifiers, likely sharing ME IDs with the PPTP RE UNIs.

9.14.1 RE ANI-G

This ME organizes data associated with each R'/S' physical interface of an RE if the RE supports OEO regeneration in either direction. The management ONU automatically creates one instance of this ME for each R'/S' physical port (uni- or bidirectional) as follows.

- When the RE has mid-span PON RE ANI interface ports built into its factory configuration.
- When a cardholder is provisioned to expect a circuit pack of the mid-span PON RE ANI type.
- When a cardholder provisioned for plug-and-play is equipped with a circuit pack of the mid-span PON RE ANI type. Note that the installation of a plug-and-play card may indicate the presence of a mid-span PON RE ANI port via equipment ID as well as its type attribute, and indeed may cause the management ONU to instantiate a port-mapping package to specify the ports precisely.

The management ONU automatically deletes instances of this ME when a cardholder is neither provisioned to expect a mid-span PON RE ANI circuit pack, nor is it equipped with a mid-span PON RE ANI circuit pack.

As illustrated in Figure 8.2.10-4, an RE ANI-G may share the physical port with an RE downstream amplifier. The ONU declares a shared configuration through the port-mapping package combined port table, whose structure defines one ME as the master. It is recommended that the RE ANI-G be the master, with the RE downstream amplifier as a secondary ME.

The administrative state, operational state and ARC attributes of the master ME override similar attributes in secondary MEs associated with the same port. In the secondary ME, these attributes are present, but cause no action when written and have undefined values when read. The RE downstream amplifier should use its provisionable downstream alarm thresholds and should declare downstream alarms as necessary; other isomorphic alarms should be declared by the RE ANI-G. The test action should be addressed to the master ME.

Relationships

An instance of this ME is associated with each R'/S' physical interface of an RE that includes OEO regeneration in either direction, and with one or more instances of the PPTP RE UNI. It may also be associated with an RE downstream amplifier.

Attributes

Managed entity ID: This attribute uniquely identifies each instance of this ME. Its value indicates the physical position of the R/S' interface. The first byte is the slot ID (defined in clause 9.1.5). The second byte is the port ID. (R) (mandatory) (2 bytes)

NOTE 1 – This ME ID may be identical to that of an RE downstream amplifier if it shares the same physical slot and port.

Administrative state: This attribute locks (1) and unlocks (0) the functions performed by this ME. Administrative state is further described in clause A.1.6. (R, W) (mandatory) (1 byte)

NOTE 2 – When an RE supports multiple PONs, or protected access to a single PON, its primary ANI-G cannot be completely shut down, due to a loss of the management communications capability. Complete blocking of service and removal of power may nevertheless be appropriate for secondary RE ANI-Gs. Administrative lock suppresses alarms and notifications for an RE ANI-G, be it either primary or secondary.

Operational state: This attribute indicates whether the ME is capable of performing its function. Valid values are enabled (0) and disabled (1). (R) (optional) (1 byte)

ARC: See clause A.1.4.3. (R, W) (optional) (1 byte)

ARC interval: See clause A.1.4.3. (R, W) (optional) (1 byte)

Optical signal level: This attribute reports the current measurement of total downstream optical power. Its value is a 2s complement integer referred to 1 mW (i.e., dBm), with 0.002 dB granularity. (Coding –32768 to +32767, where 0x00 = 0 dBm, 0x03e8 = +2 dBm, etc.) (R) (optional) (2 bytes)

Lower optical threshold: This attribute specifies the optical level that the RE uses to declare the downstream low received optical power alarm. Valid values are –127 dBm (coded as 254) to 0 dBm (coded as 0) in 0.5 dB increments. The default value 0xFF selects the RE's internal policy. (R, W) (optional) (1 byte)

Upper optical threshold: This attribute specifies the optical level that the RE uses to declare the downstream high received optical power alarm. Valid values are –127 dBm (coded as 254) to 0 dBm (coded as 0) in 0.5 dB increments. The default value 0xFF selects the RE's internal policy. (R, W) (optional) (1 byte)

Transmit optical level: This attribute reports the current measurement of mean optical launch power. Its value is a 2s complement integer referred to 1 mW (i.e., dBm), with 0.002 dB granularity. (Coding –32768 to +32767, where 0x00 = 0 dBm, 0x03e8 = +2 dBm, etc.) (R) (optional) (2 bytes)

Lower transmit power threshold: This attribute specifies the minimum mean optical launch power that the RE uses to declare the low transmit optical power alarm. Its value is a 2s complement integer referred to 1 mW (i.e., dBm), with 0.5 dB granularity. The default value 0x7F selects the RE's internal policy. (R, W) (optional) (1 byte)

Upper transmit power threshold: This attribute specifies the maximum mean optical launch power that the RE uses to declare the high transmit optical power alarm. Its value is a 2s complement integer referred to 1 mW (i.e., dBm), with 0.5 dB granularity. The default value 0x7F selects the RE's internal policy. (R, W) (optional) (1 byte)

Usage mode: In a mid-span PON RE, an R/S' interface may be used as the PON interface for the embedded management ONU or the uplink interface for an S/R' interface. This attribute specifies the usage of the R/S' interface. (R, W) (mandatory) (1 byte)

- 0 Disable
- 1 This R/S' interface is used as the uplink for the embedded management ONU
- 2 This R/S' interface is used as the uplink for one or more PPTP RE UNI(s)
- 3 This R/S' interface is used as the uplink for both the embedded management ONU and one or more PPTP RE UNI(s) (in a time division fashion).

Target upstream frequency: This attribute specifies the frequency of the converted upstream signal on the optical trunk line (OTL), in gigahertz. The converted frequency must conform to the frequency plan specified in [ITU-T G.984.6]. The value 0 means that the upstream signal frequency remains the same as the original frequency; no frequency conversion is done. If the RE does not support provisionable upstream frequency (wavelength), this attribute should take the fixed value representing the RE's capability and the RE should deny attempts to set the value of the attribute. If the RE does support provisionable upstream frequency conversion, the default value of this attribute is 0. (R, W) (optional) (4 bytes).

Target downstream frequency: This attribute specifies the frequency of the downstream signal received by the RE on the OTL, in gigahertz. The incoming frequency must conform to the frequency plan specified in [ITU-T G.984.6]. The default value 0 means that the downstream frequency remains the same as its original frequency; no frequency conversion is done. If the RE does not support provisionable downstream frequency selectivity, this attribute should take the fixed value representing the RE's capability, and the RE should deny attempts to set the value of the attribute. If the RE does support provisionable downstream frequency selectivity, the default value of this attribute is 0. (R, W) (optional) (4 bytes).

Upstream signal transmission mode: When true, this Boolean attribute enables conversion from burst mode to continuous mode. The default value false specifies burst mode upstream transmission. If the RE does not have the ability to convert from burst to continuous mode transmission, it should deny attempts to set this attribute to true. (R, W) (optional) (1 byte)

Actions

Get, set

Test Test the RE-ANI. The test action can be used to perform optical line supervision tests; refer to the test and test result message definitions in Annex A.

Notifications

Attribute value change

Number	Attribute value change	Description
1	N/A	
2	Op state	Operational state of RE ANI-G

Attribute value change

Number	Attribute value change	Description
3	ARC	Alarm-reporting control cancellation
4..14	N/A	
15..16	Reserved	

Alarm

Alarm number	Alarm	Description
0	Low received optical power	Received downstream optical power below threshold
1	High received optical power	Received downstream optical power above threshold
2	Low transmit optical power	Transmitted upstream optical power below lower threshold
3	High transmit optical power	Transmitted upstream optical power above upper threshold
4	High laser bias current	Laser bias current above threshold determined by vendor; laser end of life pending
5..207	Reserved	
208..223	Vendor-specific alarms	Not to be standardized

Test result: The RE may report a test result autonomously if it performs self-test functions autonomously.

9.14.2 Physical path termination point RE UNI

This ME represents an S'/R' interface in a mid-span PON RE that supports OEO regeneration in at least one direction, where physical paths terminate and physical path level functions are performed (transmit or receive).

Such an RE automatically creates an instance of this ME for each S'/R' interface port as follows.

- When the RE has mid-span PON RE UNI interface ports built into its factory configuration.
- When a cardholder is provisioned to expect a circuit pack of the mid-span PON RE UNI type.
- When a cardholder provisioned for plug-and-play is equipped with a circuit pack of the mid-span PON RE UNI type. Note that the installation of a plug-and-play card may indicate the presence of a mid-span PON RE UNI port via equipment ID as well as its type attribute, and indeed may cause the management ONU to instantiate a port-mapping package to specify the ports precisely.

The management ONU automatically deletes instances of this ME when a cardholder is neither provisioned to expect a mid-span PON RE UNI circuit pack, nor is it equipped with a mid-span PON RE UNI circuit pack.

As illustrated in Figure 8.2.10-3, a PPTP RE UNI may share the physical port with an RE upstream amplifier. The ONU declares a shared configuration through the port-mapping package combined port table, whose structure defines one ME as the master. It is recommended that the PPTP RE UNI be the master, with the RE upstream amplifier as a secondary ME.

The administrative state, operational state and ARC attributes of the master ME override similar attributes in secondary MEs associated with the same port. In the secondary ME, these attributes are present, but cause no action when written and have undefined values when read. The RE upstream amplifier should use its provisionable upstream alarm thresholds and should declare upstream alarms

as necessary; other isomorphic alarms should be declared by the PPTP RE UNI. The test action should be addressed to the master ME.

Relationships

An instance of this ME is associated with each instance of a mid-span PON RE S'/R' physical interface of an RE that includes OEO regeneration in either direction, and it may also be associated with an RE upstream amplifier.

Attributes

Managed entity ID: This attribute uniquely identifies each instance of this ME. This 2 byte number indicates the physical position of the UNI. The first byte is the slot ID (defined in clause 9.1.5). The second byte is the port ID, with the range 1..255. (R) (mandatory) (2 bytes)

NOTE 1 – This ME ID may be identical to that of an RE upstream amplifier if it shares the same physical slot and port.

Administrative state: This attribute locks (1) and unlocks (0) the functions performed by this ME. Administrative state is further described in clause A.1.6. (R, W) (mandatory) (1 byte)

NOTE 2 – Administrative lock of a PPTP RE UNI results in loss of signal to any downstream ONUs.

Operational state: This attribute indicates whether the ME is capable of performing its function. Valid values are enabled (0) and disabled (1). (R) (optional) (1 byte)

ARC: See clause A.1.4.3. (R, W) (optional) (1 byte)

ARC interval: See clause A.1.4.3. (R, W) (optional) (1 byte)

RE ANI-G pointer: This attribute points to an RE ANI-G instance. (R, W) (mandatory) (2 bytes)

Total optical receive signal level table: This table attribute reports a series of measurements of time averaged received upstream optical signal power. The measurement circuit should have a temporal response similar to a simple 1 pole low pass filter, with an effective time constant of the order of a GTC frame time. Each table entry has a 2 byte frame counter field (most significant end), and a 2 byte power measurement field. The frame counter field contains the least significant 16 bits of the superframe counter received closest to the time of the measurement. The power measurement field is a 2s complement integer referred to 1 mW (i.e., dBm), with 0.002 dB granularity. (Coding -32768 to $+32767$, where $0x00 = 0$ dBm, $0x03e8 = +2$ dBm, etc.) The RE equipment should add entries to this table as frequently as is reasonable. The RE should clear the table once it is read by the OLT. (R) (optional) ($4 * N$ bytes, where N is the number of measurements present.)

Per burst receive signal level table: This table attribute reports the most recent measurement of received burst upstream optical signal power. Each table entry has a 2 byte ONU-ID field (most significant end), and a 2 byte power measurement field. The power measurement field is a 2s complement integer referred to 1 mW (i.e., dBm), with 0.002 dB granularity. (Coding -32768 to $+32767$, where $0x00 = 0$ dBm, $0x03e8 = +2$ dBm, etc.) (R) (optional) ($4 * N$ bytes, where N is the number of distinct ONUs connected to the S'/R' interface.)

Lower receive optical threshold: This attribute specifies the optical level that the RE uses to declare the burst mode low received optical power alarm. Valid values are

–127 dBm (coded as 254) to 0 dBm (coded as 0) in 0.5 dB increments. The default value 0xFF selects the RE's internal policy. (R, W) (optional) (1 byte)

Upper receive optical threshold: This attribute specifies the optical level that the RE uses to declare the burst mode high optical power alarm. Valid values are –127 dBm (coded as 254) to 0 dBm (coded as 0) in 0.5 dB increments. The default value 0xFF selects the RE's internal policy. (R, W) (optional) (1 byte)

Transmit optical level: This attribute reports the current measurement of the downstream mean optical launch power. Its value is a 2s complement integer referred to 1 mW (i.e., dBm), with 0.002 dB granularity. (R) (optional) (2 bytes)

Lower transmit power threshold: This attribute specifies the downstream minimum mean optical launch power at the S'/R' interface that the RE uses to declare the low transmit optical power alarm. Its value is a 2s complement integer referred to 1 mW (i.e., dBm), with 0.5 dB granularity. The default value 0x7F selects the RE's internal policy. (R, W) (optional) (1 byte)

Upper transmit power threshold: This attribute specifies the downstream maximum mean optical launch power at the S'/R' interface that the RE uses to declare the high transmit optical power alarm. Its value is a 2s complement integer referred to 1 mW (i.e., dBm), with 0.5 dB granularity. The default value 0x7F selects the RE's internal policy. (R, W) (optional) (1 byte)

Additional preamble: This attribute indicates the number of bytes of PLOu preamble that are unavoidably consumed while passing the RE. (R) (mandatory) (1 byte)

Additional guard time: This attribute indicates the number of bytes of extra guard time that are needed to ensure correct operation with the RE. (R) (mandatory) (1 byte)

Connected ONUs table: s attribute is used to pass ONU ID information of the connected ONUs per RE UNI. The get, get next sequence must be used with this attribute since its size is unspecified. Upon ME instantiation, this attribute is an empty list.

Each entry contains:

– ONU ID (2 bytes)

(R) (optional) (2N bytes, where N is the number of ONUs)

Clear ONU table: the attribute is used to notify RE to clear the entire Connected ONUs table by OLT. The OLT must insure that the ONU IDs have been retrieved before clearing the table, or loss of data may occur.

When the value of the byte is set to 1, the RE clears the entire Connected ONUs table and resets the byte to 0.

(W) (optional) (1 byte)

Actions

Get, get next, set

Test Test the PPTP RE UNI. The test action can be used to perform optical line supervision tests; refer to the test and test result message definitions in Annex A.

Notifications

Attribute value change

Number	Attribute value change	Description
1	N/A	
2	Op state	Operational state of PPTP RE UNI
3	ARC	ARC timer expiration
4..14	N/A	
15..16	Reserved	

Alarm

Alarm number	Alarm	Description
0	Low received optical power	Received upstream optical power of one or more ONUs below threshold
1	High received optical power	Received upstream optical power of one or more ONUs above threshold
2	Low transmit optical power	Transmit downstream optical power below lower threshold
3	High transmit optical power	Transmit downstream optical power above upper threshold
4	High laser bias current	Laser bias current above threshold determined by vendor; laser end of life pending
5	S'/R' LOS	S'/R' LOS detected. No optical signal received at the S'/R' upstream interface in 500 μ s
6..207	Reserved	
208..223	Vendor-specific alarms	Not to be standardized

9.14.3 RE upstream amplifier

This ME organizes data associated with each upstream RE optical amplifier (OA) supported by the RE. The management ONU automatically creates one instance of this ME for each upstream OA as follows.

- When the RE has mid-span PON RE upstream OA ports built into its factory configuration.
- When a cardholder is provisioned to expect a circuit pack of the mid-span PON RE upstream OA type.
- When a cardholder provisioned for plug-and-play is equipped with a circuit pack of the mid-span PON RE upstream OA type. Note that the installation of a plug-and-play card may indicate the presence of a mid-span PON RE upstream OA via equipment ID as well as its type attribute, and indeed may cause the management ONU to instantiate a port-mapping package to specify the ports precisely.

The management ONU automatically deletes instances of this ME when a cardholder is neither provisioned to expect a mid-span PON RE upstream OA circuit pack, nor is it equipped with a mid-span PON RE upstream OA circuit pack.

Relationships

An instance of this ME is associated with an upstream OA, and with an instance of a circuit pack. If the RE includes OEO regeneration in either direction, the RE upstream amplifier is also associated with a PPTP RE UNI. Refer to clause 9.14.2 for further discussion.

Attributes

Managed entity ID: This attribute uniquely identifies each instance of this ME. Its value indicates the physical position of the upstream OA. The first byte is the slot ID (defined in clause 9.1.5). The second byte is the port ID. (R) (mandatory) (2 bytes)

NOTE 1 – This ME ID may be identical to that of a PPTP RE UNI if it shares the same physical slot and port.

Administrative state: This attribute locks (1) and unlocks (0) the functions performed by this ME. Administrative state is further described in clause A.1.6. (R, W) (mandatory) (1 byte)

NOTE 2 – Administrative lock of an RE upstream amplifier results in LOS from any downstream ONUs.

Operational state: This attribute indicates whether the ME is capable of performing its function. Valid values are enabled (0) and disabled (1). (R) (optional) (1 byte)

Operational mode: This attribute indicates the operational mode as follows.

- 0 Constant gain
- 1 Constant output power
- 2 Autonomous

(R, W) (mandatory) (1 byte)

ARC: See clause A.1.4.3. (R, W) (optional) (1 byte)

ARC interval: See clause A.1.4.3. (R, W) (optional) (1 byte)

RE downstream amplifier pointer: This attribute points to an RE downstream amplifier instance. The default value is 0xFFFF, a null pointer. (R, W) (mandatory) (2 bytes)

Total optical receive signal level table: This table attribute reports a series of measurements of time-averaged input upstream optical signal power. The measurement circuit should have a temporal response similar to a simple 1 pole low pass filter, with an effective time constant on the order of a GTC frame time. Each table entry has a 2 byte frame counter field (most significant end), and a 2 byte power measurement field. The frame counter field contains the least significant 16 bits of the superframe counter received closest to the time of the measurement. The power measurement field is a 2s complement integer referred to 1 mW (i.e., dBm), with 0.002 dB granularity. (Coding –32768 to +32767, where 0x00 = 0 dBm, 0x03e8 = +2 dBm, etc.) The RE equipment should add entries to this table as frequently as is reasonable. The RE should clear the table once it is read by the OLT. (R) (optional) (4 * N bytes, where N is the number of measurements present.)

Per burst receive signal level table: This table attribute reports the most recent measurement of received burst upstream optical signal power. Each table entry has a 2 byte ONU-ID field (most significant end), and a 2 byte power measurement field. The power measurement field is a 2s complement integer referred to 1 mW (i.e., dBm), with 0.002 dB granularity. (Coding -32768 to $+32767$, where $0x00 = 0$ dBm, $0x03e8 = +2$ dBm, etc.) (R) (optional) ($4 * N$ bytes, where N is the number of distinct ONUs connected to the S'/R' interface.)

Lower receive optical threshold: This attribute specifies the optical level that the RE uses to declare the low received optical power alarm. Valid values are -127 dBm (coded as 254) to 0 dBm (coded as 0) in 0.5 dB increments. The default value $0xFF$ selects the RE's internal policy. (R, W) (optional) (1 byte)

Upper receive optical threshold: This attribute specifies the optical level that the RE uses to declare the high received optical power alarm. Valid values are -127 dBm (coded as 254) to 0 dBm (coded as 0) in 0.5 dB increments. The default value $0xFF$ selects the RE's internal policy. (R, W) (optional) (1 byte)

Transmit optical signal level: This attribute reports the current measurement of the mean optical launch power of the upstream OA. Its value is a 2s complement integer referred to 1 mW (i.e., dBm), with 0.002 dB granularity. (R) (optional) (2 bytes)

Lower transmit optical threshold: This attribute specifies the minimum mean optical launch power that the RE uses to declare the low transmit optical power alarm. Its value is a 2s complement integer referred to 1 mW (i.e., dBm), with 0.5 dB granularity. The default value $0x7F$ selects the RE's internal policy. (R, W) (optional) (1 byte)

Upper transmit optical threshold: This attribute specifies the maximum mean optical launch power that the RE uses to declare the high transmit optical power alarm. Its value is a 2s complement integer referred to 1 mW (i.e., dBm), with 0.5 dB granularity. The default value $0x7F$ selects the RE's internal policy. (R, W) (optional) (1 byte)

Actions

Get, get next, set

Test Test the upstream amplifier. The test action can be used to perform optical line supervision tests; refer to the test and test result message descriptions in Annex A.

Notifications

Attribute value change

Number	Attribute value change	Description
1	N/A	
2	Op state	Operational state of RE upstream amplifier
3	N/A	
4	ARC	Alarm-reporting control cancellation
5..13	N/A	
14..16	Reserved	

Alarm

Alarm number	Alarm	Description
0	Low received optical power	Received upstream optical power of one or more ONUs below threshold
1	High received optical power	Received upstream optical power of one or more ONUs above threshold
2	Low transmit optical power	Transmit upstream optical power below lower threshold
3	High transmit optical power	Transmit upstream optical power above upper threshold
4	High laser bias current	Laser bias current above threshold determined by vendor; laser end of life pending
5	S'/R' LOS	S'/R' LOS detected. No optical signal received at the S'/R' upstream interface in 500 μ s
6..207	Reserved	
208..223	Vendor-specific alarms	Not to be standardized

Test result: The RE may report a test result autonomously if it performs self-test functions autonomously.

9.14.4 RE downstream amplifier

This ME organizes data associated with each OA for downstream data supported by the RE. The management ONU automatically creates one instance of this ME for each downstream OA as follows.

- When the RE has mid-span PON RE downstream OA ports built into its factory configuration.
- When a cardholder is provisioned to expect a circuit pack of the mid-span PON RE downstream OA type.
- When a cardholder provisioned for plug-and-play is equipped with a circuit pack of the mid-span PON RE downstream OA type. Note that the installation of a plug-and-play card may indicate the presence of a mid-span PON RE downstream OA via equipment ID as well as its type attribute, and indeed may cause the management ONU to instantiate a port-mapping package to specify the ports precisely.

The management ONU automatically deletes instances of this ME when a cardholder is neither provisioned to expect a mid-span PON RE downstream OA circuit pack, nor is it equipped with a mid-span PON RE downstream OA circuit pack.

Relationships

An instance of this ME is associated with a downstream OA and with an instance of a circuit pack. If the RE includes OEO regeneration in either direction, the RE downstream amplifier is also associated with an RE ANI-G. Refer to clause 9.14.1 for further discussion.

Attributes

Managed entity ID: This attribute uniquely identifies each instance of this ME. Its value indicates the physical position of the downstream OA. The first byte is the slot ID (defined in clause 9.1.5 of [ITU-T G.984.4]). The second byte is the port ID. (R) (mandatory) (2 bytes)

NOTE 1 – This ME ID may be identical to that of an RE ANI-G if it shares the same physical slot-port.

Administrative state: This attribute locks (1) and unlocks (0) the functions performed by this ME. Administrative state is further described in clause A.1.6. (R, W) (mandatory) (1 byte)

NOTE 2– When an RE supports multiple PONs, or protected access to a single PON, its primary ANI-G cannot be completely shut down, due to a loss of the management communications capability. Complete blocking of service and removal of power may nevertheless be appropriate for secondary RE ANI-Gs. Administrative lock suppresses alarms and notifications for both primary and secondary RE ANI-Gs. Administrative lock suppresses alarms and notifications for an RE downstream amplifier, be it either primary or secondary.

Operational state: This attribute indicates whether the ME is capable of performing its function. Valid values are enabled (0) and disabled (1). (R) (optional) (1 byte)

ARC: See clause A.1.4.3. (R, W) (optional) (1 byte)

ARC interval: See clause A.1.4.3. (R, W) (optional) (1 byte)

Operational mode: This attribute indicates the operational mode as follows.

- 0 Constant gain
- 1 Constant output power
- 2 Autonomous

(R,W) (mandatory) (1 byte)

Input optical signal level: This attribute reports the current measurement of the input optical signal power of the downstream OA. Its value is a 2s complement integer referred to 1 mW (i.e., dBm), with 0.002 dB granularity. (Coding –32768 to +32767, where 0x00 = 0 dBm, 0x03e8 = +2 dBm, etc.) (R) (optional) (2 bytes)

Lower input optical threshold: This attribute specifies the optical level the RE uses to declare the low received optical power alarm. Valid values are –127 dBm (coded as 254) to 0 dBm (coded as 0) in 0.5 dB increments. The default value 0xFF selects the RE's internal policy. (R, W) (optional) (1 byte)

Upper input optical threshold: This attribute specifies the optical level the RE uses to declare the high received optical power alarm. Valid values are –127 dBm (coded as 254) to 0 dBm (coded as 0) in 0.5 dB increments. The default value 0xFF selects the RE's internal policy. (R, W) (optional) (1 byte)

Output optical signal level: This attribute reports the current measurement of the mean optical launch power of the downstream OA. Its value is a 2s complement integer referred to 1 mW (i.e., dBm), with 0.002 dB granularity. (Coding –32768 to +32767, where 0x00 = 0 dBm, 0x03e8 = +2 dBm, etc.) (R) (optional) (2 bytes)

Lower output optical threshold: This attribute specifies the minimum mean optical launch power that the RE uses to declare the low transmit optical power alarm. Its value is a 2s complement integer referred to 1 mW (i.e., dBm), with 0.5 dB granularity. The default value 0x7F selects the RE's internal policy. (R, W) (optional) (1 byte)

Upper output optical threshold: This attribute specifies the maximum mean optical launch power that the RE uses to declare the high transmit optical power alarm. Its value is a 2s complement integer referred to 1 mW (i.e., dBm), with 0.5 dB granularity. The default value 0x7F selects the RE's internal policy. (R, W) (optional) (1 byte)

R'S' splitter coupling ratio: This attribute reports the coupling ratio of the splitter at the R/S' interface that connects the embedded management ONU and the amplifiers to the OTL. Valid values are 99:1 (coded as 99 decimal) to 1:99 (coded as 1 decimal), where the first value is the value encoded and is the percentage of the optical signal connected to the amplifier. The default value 0xFF indicates that there is no splitter connected to this upstream/downstream amplifier pair. (R) (optional) (1 byte)

Actions

Get, set

Test Test the RE downstream amplifier. The test action can be used to perform optical line supervision tests; refer to the test and test result message descriptions in Annex A.

Notifications

Attribute value change

Number	Attribute value change	Description
1	N/A	
2	Op state	Operational state of RE downstream amplifier
3	ARC	Alarm-reporting control cancellation
4..12	N/A	
13..16	Reserved	

Alarm

Alarm number	Alarm	Description
0	Low received optical power	Received downstream optical power below threshold
1	High received optical power	Received downstream optical power above threshold
2	Low transmit optical power	Transmit downstream optical power below lower threshold
3	High transmit optical power	Transmit downstream optical power above upper threshold
4	High laser bias current	Laser bias current above threshold determined by vendor; laser end of life pending
5..207	Reserved	
208..223	Vendor-specific alarms	Not to be standardized

Test result: The RE may report a test result autonomously if it performs self-test functions autonomously.

9.14.5 RE config portal

The RE config portal ME provides a way for the OLT to discover the configuration delivered to an RE by a non-OMCI configuration method (SNMP, etc.). Text retrieved from this ME is not required to be understood by the OLT or EMS, but it may be useful for human or vendor-specific analysis tools.

An instance of this ME may be created by an RE that supports non-OMCI RE configuration. It is not reported during an MIB upload.

Relationships

One instance of this ME is associated with an instance of a TCP/UDP config data ME.

Attributes

Managed entity ID: This attribute uniquely identifies each instance of this ME. There is one instance, number 0. (R) (mandatory) (2 bytes)

Configuration text table: This attribute is used to pass a textual representation of the RE configuration back to the OLT. The contents are vendor-specific. The get, get next sequence must be used with this attribute since its size is unspecified. Upon ME instantiation, the management ONU sets this attribute to 0. (R) (mandatory) (x bytes)

TCP/UDP pointer: This pointer associates the RE config portal with the TCP/UDP config data ME to be used for communication with any valid and necessary in-band protocol server. The default value is 0xFFFF. (R, W) (mandatory) (2 bytes)

Actions

Get, get next

Notifications

Attribute value change

Number	Attribute value change	Description
1	Configuration text	Indicates an update to the RE configuration from a non-OMCI interface. Because the attribute is a table, the AVC does not contain information about its value. The OLT must use the get, get next action sequence if it wishes to obtain the updated attribute content.
2	N/A	
3..16	Reserved	

9.14.6 RE common amplifier parameters

This ME organizes data associated with each OA supported by the RE. The management ONU automatically creates one instance of this ME for each upstream or downstream OA.

Relationships

An instance of this ME is associated with an instance of the RE downstream amplifier or RE upstream amplifier ME.

Attributes

Managed entity ID: This attribute uniquely identifies each instance of this ME. Through an identical ID, this ME is implicitly linked to an instance of an upstream or downstream OA. The first byte is the slot ID (defined in clause 9.1.5). The second byte is the port ID. (R) (mandatory) (2 bytes)

NOTE – The type of the linked ME can be determined by uniqueness of slot and port.

Gain: This attribute reports the current measurement of the OA's gain, in decibels. Its value is a 2s complement integer with 0.25 dB granularity, and with a range from –32 dB to 31.5 dB. The value 0x7F indicates that the current measured gain is 0, i.e., negative infinity in decibels terms. (R) (optional) (1 byte)

Lower gain threshold: This attribute specifies the gain the RE uses to declare the low gain alarm. Valid values are 0 dB (coded as 0x00) to 63.5 dB (coded as 0xFE). The default value 0xFF selects the RE's internal policy. (R, W) (optional) (1 byte)

Upper gain threshold: This attribute specifies the gain the RE uses to declare the high gain alarm. Valid values are 0 dB (coded as 0x00) to 63.5 dB (coded as 0xFE). The default value 0xFF selects the RE's internal policy. (R, W) (optional) (1 byte)

Target gain: This attribute specifies the target gain, when the operational mode of the parent RE downstream or upstream amplifier is set to constant gain mode. Valid values are 0 dB (coded as 0x00) to 63.5 dB (coded as 0xFE). The default value 0xFF selects the RE's internal policy. (R, W) (optional) (1 byte)

Device temperature: This attribute reports the temperature in degrees Celcius of the active device (SOA or pump) in the OA. Its value is a 2s complement integer with granularity 1/256 °C. (R) (optional) (2 bytes)

Lower device temperature threshold: This attribute is a 2s complement integer that specifies the temperature the RE uses to declare the low temperature alarm. Valid values are –64 to +63 °C in 0.5 °C increments. The default value 0x7F selects the RE's internal policy. (R, W) (optional) (1 byte)

Upper device temperature threshold: This attribute is a 2s complement integer that specifies the temperature the RE uses to declare the high temperature alarm. Valid values are –64 to +63 °C in 0.5 °C increments. The default value 0x7F selects the RE's internal policy. (R, W) (optional) (1 byte)

Device bias current: This attribute contains the measured bias current applied to the SOA or pump laser. Its value is an unsigned integer with granularity 2 mA. Valid values are 0 to 512 mA. (R) (optional) (1 byte)

Amplifier saturation output power: This attribute reports the saturation output power of the amplifier as specified by the manufacturer. Its value is an unsigned integer referred to 1 mW (i.e., dBm), with 0.1 dB granularity. (R) (optional) (2 bytes)

Amplifier noise figure: This attribute reports the intrinsic noise figure of the amplifier, as specified by the manufacturer. Its value is an unsigned integer with 0.1 dB granularity (R) (optional) (1 byte)

Amplifier saturation gain: This attribute reports the gain of the amplifier at saturation, as specified by the manufacturer. Its value is an unsigned integer with 0.25 dB granularity, and with a range from 0 to 63.75 dB. (R) (optional) (1 byte)

Actions

Get, set

Notifications

Alarm

Alarm number	Alarm	Description
0	Low gain	Gain below lower threshold
1	High gain	Gain above upper threshold
2	Low temperature	Device temperature below lower threshold
3	High temperature	Device temperature above upper threshold
4	High bias current	Device bias current above threshold determined by vendor; device end of life pending

Alarm

Alarm number	Alarm	Description
5	High temperature shutdown	Device has shut down due to temperature exceeding manufacturer's specifications
6	High current shutdown	Device has shut down due to bias current exceeding manufacturer's specifications
7..207	Reserved	
208..223	Vendor-specific alarms	Not to be standardized

9.15 RS232/RS485 interface service

This clause defines MEs associated with RS232/RS485 UNI, as shown in Figure 9.15-1.

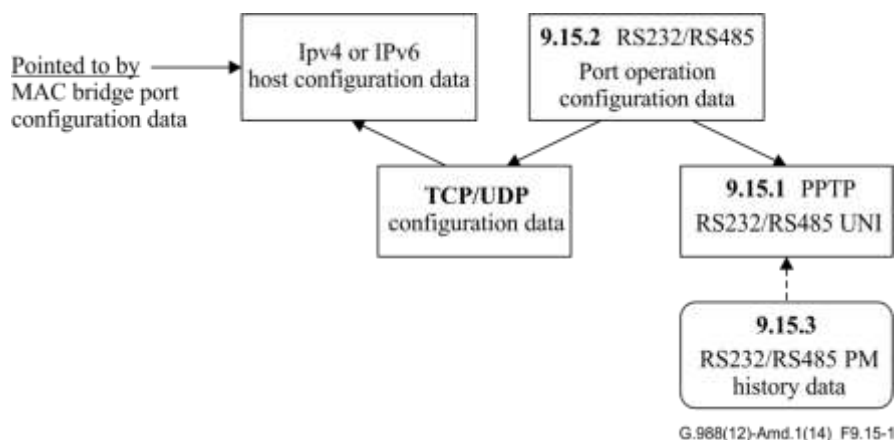

Figure 9.15-1 – Managed entities associated with RS232/RS485 UNI

9.15.1 Physical path termination point RS232/RS485 UNI

This ME represents an RS232/RS485 UNI in the ONU, where physical paths terminate and physical path level functions are performed.

The ONU automatically creates an instance of this ME per port as follows.

- When the ONU has RS232/RS485 ports built into its factory configuration.
- When a cardholder is provisioned to expect a circuit pack of RS232/RS485 type.
- When a cardholder provisioned for plug and play is equipped with a circuit pack of RS232/RS485 type. Note that the installation of a plug and play card may indicate the presence of RS232/RS485 ports via equipment ID as well as its type, and indeed may cause the ONU to instantiate a port-mapping package that specifies RS232/RS485 ports.

The ONU automatically deletes instances of this ME when a cardholder is neither provisioned to expect a RS232/RS485 circuit pack, nor is equipped with a RS232/RS485 circuit pack.

Relationships

An instance of this ME is associated with each real RS232/RS485 port.

Attributes

Managed entity ID: This attribute uniquely identifies each instance of this ME. This 2 byte number is directly associated with the physical position of the UNI. The first byte is the slot ID (defined in clause 9.1.5). The second byte is the port ID, with range 1..255. (R) (mandatory) (2 bytes)

Administrative state: This attribute locks (1) and unlocks (0) the functions performed by this ME. Administrative state is further described in clause A.1.6. (R, W) (mandatory) (1 byte)

Operational state: This attribute indicates whether the ME is capable of performing its function. Valid values are enabled (0) and disabled (1). (R) (optional) (1 byte)

Port mode: This attribute indicates the working mode of the RS232/RS485 controller chipset. Valid values are as follows.

- 0 half-duplex
- 1 full duplex

(mandatory) (1 byte)

Baud_rate: This attribute specifies the working baud rate of RS232/RS485 port. Valid values are as follows.

- 0 300 bit/s
- 1 600 bit/s
- 2 1200 bit/s
- 3 2400 bit/s
- 4 4800 bit/s
- 5 9600 bit/s
- 6 19200 bit/s
- 7 38400 bit/s
- 8 43000 bit/s
- 9 56000 bit/s
- 10 57600 bit/s
- 11 115200 bit/s

(R, W, set-by-create) (mandatory) (1 byte)

Data_bits: This attribute specifies the bits of the data. Valid values are as follows.

- 5 5 bits
- 6 6 bits
- 7 7 bits
- 8 8 bits

(R, W, set-by-create) (mandatory) (1 byte)

Parity: This attribute specifies the parity of the data. Valid values are as follows.

- 0 no parity
- 1 odd parity
- 2 even parity

(R, W, set-by-create) (mandatory) (1 byte)

Stop_bits: This attribute specifies the number of stop bits of the data. Valid values are as follows.

- 1 1 bit
- 2 2 bits

(R, W, set-by-create) (mandatory) (1 byte)

Flow_control: This attribute specifies the flow control of the data. Valid values are as follows.

- 0 no flow control
- 1 hardware flow control (RTS/CTS)
- 2 software flow control (Xon/Xoff)

(R, W, set-by-create) (mandatory) (1 byte)

Min_send_payload: This attribute specifies the length of serial data acquisition by RS232/RS485 controller chipset in the fixed length mode. (R) (mandatory) (4 bytes)

Min_send_time: This attribute specifies the time of serial data acquisition by RS232/RS485 controller chipset in the timing mode. (R) (mandatory) (4 bytes)

Reserve: This attribute is reserved for future use.

Actions

Get, set

9.15.2 RS232/RS485 port operation configuration data

This ME specifies the RS232/RS485 port operation mode. The ONU automatically creates instances of this ME if RS232/RS485 data acquisition services are available.

Relationships

An instance of this ME is associated with a TCP/UDP config data ME and a PPTP RS232/RS485 UNI.

Attributes

Managed entity ID: This attribute uniquely identifies each instance of this ME. (R, set-by-create) (mandatory) (2 bytes)

Socket mode: This attribute identifies the RS232/RS485 port operation mode as follows:
0x00 TCP/server mode;
0x01 TCP/client mode;
0x02 UDP mode,
Other values are reserved.
(R) (mandatory) (1 byte)

TCP/UDP pointer: This pointer associates the RS232/RS485 port operation configuration with the TCP/UDP config data ME to be used for communication with the serial server. The default value is 0xFFFF, a null pointer. (R, W) (mandatory) (2 bytes)

PPTP pointer: This attribute points to the PPTP RS232/RS485 UNI ME that serves the serial data acquisition function. (R, W, set-by-create) (mandatory) (2 bytes)

9.15.3 RS232/RS485 performance monitoring history data

This ME collects PM data for a RS232/RS485 interface. Instances of this ME are created and deleted by the OLT.

Relationships

An instance of this ME is associated with an instance of the PPTP RS232/RS485 UNI ME.

Attributes

Managed entity ID: This attribute uniquely identifies each instance of this ME. Through an identical ID, this ME is implicitly linked to an instance of the PPTP RS232/RS485 UNI. (R, set-by-create) (mandatory) (2 bytes)

Interval end time: This attribute identifies the most recently finished 15 min interval. (R) (mandatory) (1 byte)

Threshold data 1/2 id: This attribute points to an instance of the threshold data 1 and 2 MEs that contains PM threshold values. (R, W, set-by-create) (mandatory) (2 bytes)

Incoming bytes from PON port: This attribute counts the bytes received on the PON port. (R) (optional) (4 bytes)

Outgoing bytes from PON port: This attribute counts the bytes transmitted on the PON port. (R) (optional) (4 bytes)

Incoming bytes from RS232/RS485 controller chipset: This attribute counts the bytes received on the RS232/RS485 chipset. (R) (optional) (4 bytes)

Outgoing bytes from RS232/RS485 controller chipset: This attribute counts the bytes transmitted on the RS232/RS485 chipset. (R) (optional) (4 bytes)

Actions

Create, delete, get, set

Notifications

Threshold crossing alert

Number	Threshold crossing alert	Threshold value attribute No. (Note)
1	Incoming packets	1
2	Incoming bits	2
3	Outgoing packets	3
4	Outgoing bits	4

NOTE – This number associates the TCA with the specified threshold value attribute of the threshold data 1/2 managed entities.

9.16 [ITU-T G.989.3 TWDM](#) and [ITU-T G.9804.2 PON TWDM/TDM PON](#)

This clause defines MEs associated with TWDM/TDM PON management.

9.16.1 TWDM/TDM System Profile managed entity

This ME models the TWDM subsystem of NG-PON2 system [and TWDM/TDM subsystem of ITU-T G.9804.2 based PON system](#). An instance of this ME corresponds to a physical or virtual slot of the ONU housing one or more access network interfaces. The instances of this ME are instantiated autonomously by the ONU.

Relationships

An instance of this ME is associated with an instance of a circuit pack that supports a PON interface function. It is, therefore, implicitly associated with all ANI-G MEs whose ME ID refers the specific Slot ID.

Attributes

Managed entity ID: This attribute uniquely identifies each instance of this ME. This 2 byte number is represented as 0xSS00, where SS indicates the slot ID (as defined in clause 9.1.5 and referenced in clause 9.2.1 of G.988. (R) (mandatory) (2 bytes)

Total TWDM channel number: This attribute indicates the number of distinct TWDM channels the optical network termination (ONT) supports in given slot. (R) (mandatory) (1 byte)

Channel partition index: Channel partition index represented as 0x0P, and maintained as a part of the OMCI MIB, rather than a TC layer config parameter. See

clauses 6.1.5.9 of [ITU-T G.989.3] and 6.5.2.8 of [ITU-T G.9804.2] for a complete description. (R, W) (mandatory) (1 byte)

Channel partition waiver timer: An unsigned integer representing the time interval measured in seconds for which the ONU is blocked from an activation attempt on Channel Partition restriction. The timer corresponds to the T_{cpi} parameter of G.989.3A1/G.9804.2 and measures the elapsed time from the moment an ONU finds a downstream wavelength channel belonging to a non-matching channel partition, to the moment the ONU resets its CPI in non-volatile memory to the default value (zero) in order to waive the CPI restriction. The default is 300 s. The value of 0xFFFF indicates infinity (no channel partition waiver is granted). (R, W) (mandatory) (4 bytes)

LODS re-initialization timer: This attribute, which corresponds to timer TO2 of [ITU-T G.989.3]/[ITU-T G.9804.2] expressed as an integer number of PHY frame intervals, specifies the duration of time an ONU without configured wavelength channel protection (WLCP = OFF) waits in the intermittent LODS (O6) state before transitioning into the initial (O1) state for reactivation. The default value upon instantiation is 1000 (125 ms). (R, W) (mandatory) (4 bytes)

LODS protection timer: This attribute, which corresponds to timer TO3 of [ITU-T G.989.3]/[ITU-T G.9804.2] expressed as an integer number of PHY frame intervals, specifies the duration of time an ONU with configured WLCP = ON waits in the intermittent LODS (O6) state before transitioning into the downstream tuning (O8) state to tune into the pre-configured protection wavelength channel. The default value upon instantiation is 200 (25 ms). ~~(R)~~ for TWDM system. This attribute is not applicable to ITU-T G.9804.2 TDM systems (and will be ignored). (R, W) (mandatory) (4 bytes)

Downstream tuning timer: This attribute, which corresponds to timer TO4 of [ITU-T G.989.3]/[ITU-T G.9804.2] expressed as an integer number of PHY frame intervals, specifies the duration of time an ONU in the downstream tuning (O8) state attempts to validate the specified target downstream wavelength channel [obtaining downstream wavelength channel (DWLCH) ok to work], before transitioning into the initial (O1) state for reactivation. Note that the Rx tuning time proper is included in this interval. The default value upon instantiation is 1000 (125 ms). (R, W) (mandatory) (4 bytes)

Upstream tuning timer: This attribute, which corresponds to timer TO5 of [ITU-T G.989.3]/[ITU-T G.9804.2] expressed as an integer number of PHY frame intervals, specifies the duration of time an ONU in the upstream tuning (O9) state attempts to obtain the upstream tuning confirmation in the specified target upstream wavelength channel before transitioning into the initial (O1) state for reactivation. The default value upon instantiation is 1000 (125 ms). (R, W) (mandatory) (4 bytes)

Location label 1: This attribute represents the first part of the field, which is written by the OLT to provide the topological location information for the specific OLT channel termination within the operator domain. This attribute is not interpreted by the ONU, but may be used by a dual-managed ONU as a part of an alarm report provided over non-OMCI management channel. (R, W) (mandatory) (24 bytes)

Location label 2: This attribute represents the second part of the field, which is written by the OLT to provide the topological location information for the specific OLT

channel termination within the operator domain. This attribute is not interpreted by the ONU, but may be used by a dual-managed ONU as a part of an alarm report provided over non-OMCI management channel. (R, W) (mandatory) (24 bytes)

Actions

Get, set.

9.16.2 TWDM/TDM channel managed entity

This ME provides an anchor for the MEs involved in collection of PM statistics per TWDM/TDM channel, as stipulated by clause 14 of [ITU-T G.989.3]. Instances of this ME are instantiated autonomously by the ONU.

Relationships

One or more instances of this ME are implicitly associated with the TWDM System profile ME. The number of instances created is announced by the total TWDM channel number attribute of the TWDM system profile ME.

Attributes

Managed entity ID: This attribute uniquely identifies each instance of this ME. This 2 byte number is represented as 0xSSBB, where SS indicates the ONU slot ID, and BB is the TWDM channel ME number assigned by the ONU itself, starting from 0 in the ascending order. (R) (mandatory) (2 bytes)

Active channel indication: The default value is false. The ONU sets the attribute to true when it receives the non-void Channel_Profile PLOAM messages for that channel. The ONU clears the attribute when it receives the Channel_Profile PLOAM message marked "void" for that channel. (R) (mandatory) (1 byte)

Operational channel indication: A Boolean attribute that is set to true for an active TWDM channel in which the ONT is currently operating. The operational statistic is accumulated in the PM history data MEs associated with that TWDM channel. (R) (mandatory) (1 byte)

Downstream wavelength channel: For an active TWDM channel, this attribute identifies the downstream wavelength channel in reference to Table 11-2 of [ITU-T G.989.2]. [For fixed wavelength TDM system, the downstream wavelength channel number is 0x0F.](#) For an inactive channel it has value 0xFF. (R) (mandatory) (1 byte)

Upstream wavelength channel: For an active TWDM channel, this attribute identifies the upstream wavelength channel in reference to Table VIII-5 of [ITU-T G.989.2]. [For fixed wavelength TDM system, the downstream wavelength channel number is 0x0F.](#) For an inactive channel its value of 0xFF. (R) (mandatory) (1 byte)

Actions

Get, set.

9.16.3 TWDM channel PHY/LODS performance monitoring history data

This ME collects certain PM data associated with the slot/circuit pack, hosting one or more ANI-G MEs, and a specific TWDM channel. Instances of this ME are created and deleted by the OLT.

For a complete discussion of generic PM architecture, refer to clause I.4.

Relationships

An instance of this ME is associated with an instance of TWDM channel ME.

Attributes

- Managed entity ID:** This attribute uniquely identifies each instance of this ME. Through an identical ID, this ME is implicitly linked to an instance of the TWDM channel ME. (R, set-by-create) (mandatory) (2 bytes)
- Interval end time:** This attribute identifies the most recently finished 15 min interval. (R) (mandatory) (1 byte)
- Threshold data 1/2 ID:** This attribute points to an instance of the threshold data 1 and 2 MEs that contains PM threshold values. (R, W, set-by-create) (mandatory) (2 bytes)
- Total received words protected by bit-interleaved parity-32 (BIP-32):** The count of 4 byte words included in BIP-32 check. This is a product of the number of downstream FS frames received by the size of the downstream FS frame after the FEC parity byte, if any, have been removed. The count applies to the entire downstream data flow, whether or not addressed to that ONT. (R) (mandatory) (8 bytes)
- BIP-32 bit error count:** Count of the bit errors in the received downstream FS frames as measured using BIP-32. If FEC is supported in the downstream direction, the BIP-32 count applies to the downstream FS frame after the FEC correction has been applied and the FEC parity bytes have been removed. (R) (mandatory) (4 bytes)
- Corrected PSBd HEC error count:** The count of the errors in either CFC or OCS fields of the PSBd block that have been corrected using the HEC technique. (R) (mandatory) (4 bytes)
- Uncorrectable PSBd HEC error count:** The count of the errors in either CFC or OCS fields of the PSBd block that could not be corrected using the HEC technique. (R) (mandatory) (4 bytes)
- Corrected downstream FS header HEC error count:** The count of the errors in the downstream FS header that have been corrected using the HEC technique. (R) (mandatory) (4 bytes)
- Uncorrectable downstream FS header HEC error count:** The count of the errors in the downstream FS header that could not be corrected using the HEC technique. (R) (mandatory) (4 bytes)
- Total number of LODS events:** The count of the state transitions from O5.1/O5.2 to O6, referring to the ONU activation cycle state machine, clause 12 of [ITU-T G.989.3]. (R) (mandatory) (4 bytes)
- LODS events restored in operating TWDM channel:** The count of LODS events cleared automatically without retuning. (R) (mandatory) (4 bytes)
- LODS events restored in protection TWDM channel:** The count of LODS events resolved by retuning to a pre-configured protection TWDM channel. The event is counted against the original operating channel. (R) (mandatory) (4 bytes)
- LODS events restored in discretionary TWDM channel:** The count of LODS events resolved by retuning to a TWDM channel chosen by the ONU, without retuning. Implies that the wavelength channel protection for the operating channel is not active. The event is counted against the original operating channel (R) (mandatory) (4 bytes)

LODS events resulting in reactivation: The count of LODS events resolved through ONU reactivation; that is, either TO2 (without WLCP) or TO3 + TO4 (with WLCP) expires before the downstream channel is reacquired, referring to the ONU activation cycle state machine, clause 12 of [ITU-T G.989.3]. The event is counted against the original operating channel (R) (mandatory) (4 bytes)

LODS events resulting in reactivation after retuning to protection TWDM channel: The count of LODS events resolved through ONU reactivation after attempted protection switching, which turns unsuccessful due to a handshake failure. (R) (mandatory) (4 bytes)

LODS events resulting in reactivation after retuning to discretionary TWDM channel: The count of LODS events resolved through ONU reactivation after attempted retuning to a discretionary channel, which turns unsuccessful due to a handshake failure. (R) (mandatory) (4 bytes)

Actions

Create, delete, get, set

Get current data (optional)

Notifications

Threshold crossing alert

Alarm number	Threshold crossing alert	Threshold value attribute No. (Note)
0	N/A	
1	BIP-32 bit error count	2
2	PSBd HEC errors – corrected	3
3	PSBd HEC errors – uncorrectable	4
4	FS header errors – corrected	5
5	FS header errors – uncorrectable	6
6	Total LODS event count	7
7	LODS – restored in operating TWDM channel	8
8	LODS – restored in protection TWDM channel	9
9	LODS – restored in discretionary TWDM channel	10
10	LODS – reactivations	11
11	LODS – handshake failure in protection channel	12
12	LODS – handshake failure in discretionary channel	13
NOTE – This number associates the TCA with the specified threshold value attribute of the threshold data 1/2 managed entities.		

9.16.4 TWDM channel XGEM performance monitoring history data

This ME collects certain XGEM-related PM data associated with the slot/circuit pack, hosting one or more ANI-G MEs, for a specific TWDM channel. Instances of this ME are created and deleted by the OLT.

For a complete discussion of generic PM architecture, refer to clause I.4.

Relationships

An instance of this ME is associated with an instance of TWDM channel ME.

Attributes

Managed entity ID: This attribute uniquely identifies each instance of this ME. Through an identical ID, this ME is implicitly linked to an instance of the TWDM channel ME. (R, set-by-create) (mandatory) (2 bytes)

Interval end time: This attribute identifies the most recently finished 15 min interval. (R) (mandatory) (1 byte)

Threshold data 64 bit ID: This attribute points to an instance of the threshold data 64 bit ME that contains PM threshold values. (R, W, set-by-create) (mandatory) (2 bytes)

Total transmitted XGEM frames: The counter aggregated across all XGEM ports of the given ONU. (R) (mandatory) (8 byte)

Transmitted XGEM frames with LF bit not set: The counter aggregated across all XGEM ports of the given ONU identifies the number of fragmentation operations. (R) (mandatory) (8 byte)

Total received XGEM frames: The counter aggregated across all XGEM ports of the given ONU. (R) (mandatory) (8 byte)

Received XGEM frames with XGEM header HEC errors: The counter aggregated across all XGEM ports of the given ONU identifies the number of loss XGEM frame delineation events. (R) (mandatory) (8 byte)

FS words lost to XGEM header HEC errors: The counter of the FS frame words lost due to XGEM frame header errors that cause loss of XGEM frame delineation. (R) (mandatory) (8 byte)

XGEM encryption key errors: The counter aggregated across all XGEM ports of the given ONU identifies the number of received XGEM frames that have to be discarded because of unknown or invalid encryption key. The number is included into the Total received XGEM frame count above. (R) (mandatory) (8 byte)

Total transmitted bytes in non-idle XGEM frames: The counter aggregated across all XGEM ports of the given. (R) (mandatory) (8 byte)

Total received bytes in non-idle XGEM frames: The counter aggregated across all XGEM ports of the given ONU. (R) (mandatory) (8 byte)

Actions

Create, delete, get, set

Get current data (optional)

Notifications

Threshold crossing alert

Alarm number	Threshold crossing alert	Threshold value attribute No. (Note)
0	Received XGEM header HEC errors	1
1	FS words lost to XGEM header HEC errors	2
2	XGEM encryption key errors	3

NOTE – This number associates the TCA with the specified threshold value attribute of the threshold data 64 bit managed entity.

9.16.5 TWDM channel PLOAM performance monitoring history data part 1

This ME collects certain PLOAM-related PM data associated with the slot/circuit pack, hosting one or more ANI-G MEs, for a specific TWDM channel. Instances of this ME are created and deleted by the OLT.

The downstream PLOAM message counts of this ME include only the received PLOAM messages pertaining to the given ONU, i.e.:

- unicast PLOAM messages, addressed by ONU-ID;
- broadcast PLOAM messages, addressed by serial number;
- broadcast PLOAM messages, addressed to all ONUs on the PON.

This ME includes all PLOAM PM counters characterized as *mandatory* in clause 14 of [ITU-T G.989.3].

For a complete discussion of generic PM architecture, refer to clause I.4.

Relationships

An instance of this ME is associated with an instance of TWDM channel ME.

Attributes

Managed entity ID: This attribute uniquely identifies each instance of this ME. Through an identical ID, this ME is implicitly linked to an instance of the TWDM channel ME. (R, set-by-create) (mandatory) (2 bytes)

Interval end time: This attribute identifies the most recently finished 15 min interval. (R) (mandatory) (1 byte)

Threshold data 1/2 ID: This attribute points to an instance of the threshold data 1 and 2 MEs that contains PM threshold values. (R, W, set-by-create) (mandatory) (2 bytes)

PLOAM MIC errors: The counter of received PLOAM messages that remain unparseable due to MIC error. (R) (mandatory) (4 bytes)

Downstream PLOAM message count: The counter of received broadcast and unicast PLOAM messages pertaining to the given ONU. (R) (mandatory) (4 bytes)

Ranging_Time message count: The counter of received Ranging_Time PLOAM messages. (R) (mandatory) (4 bytes)

Protection_Control message count: The counter of received Protection_Control PLOAM messages. (R) (mandatory) (4 bytes)

Adjust_Tx_Wavelength message count: The counter of received Adjust_Tx_Wavelength PLOAM messages. (R) (mandatory) (4 bytes)

Adjust_Tx_Wavelength adjustment amplitude: An estimator of the absolute value of the transmission wavelength adjustment. (R) (mandatory) (4 bytes)

Actions

Create, delete, get, set

Get current data (optional)

Notifications

Threshold crossing alert

Alarm number	Threshold crossing alert	Threshold value attribute No. (Note)
0	PLOAM MIC errors	1
NOTE – This number associates the TCA with the specified threshold value attribute of the threshold data 1/2 managed entities.		

9.16.6 TWDM channel PLOAM performance monitoring history data part 2

This ME collects additional PLOAM-related PM data associated with the slot/circuit pack, hosting one or more ANI-G MEs, for a specific TWDM channel. Instances of this ME are created and deleted by the OLT.

The downstream PLOAM message counts of this ME include only the received PLOAM messages pertaining to the given ONU, i.e.:

- unicast PLOAM messages, addressed by ONU-ID;
- broadcast PLOAM messages, addressed by serial number;
- broadcast PLOAM messages, addressed to all ONUs on the PON.

All these counters are characterized as *optional* in clause 14 of [ITU-T G.989.3].

For a complete discussion of generic PM architecture, refer to clause I.4.

Relationships

An instance of this ME is associated with an instance of TWDM channel ME.

Attributes

Managed entity ID: This attribute uniquely identifies each instance of this ME. Through an identical ID, this ME is implicitly linked to an instance of the TWDM channel ME. (R, set-by-create) (mandatory) (2 bytes)

Interval end time: This attribute identifies the most recently finished 15 min interval. (R) (mandatory) (1 byte)

Threshold data 1/2 ID: This attribute points to an instance of the threshold data 1 and 2 MEs that contains PM threshold values. (R, W, set-by-create) (mandatory) (2 bytes)

System_Profile message count: The counter of received System_Profile PLOAM messages. (R) (mandatory) (4 bytes)

Channel_Profile message count: The counter of received Channel_Profile PLOAM messages. (R) (mandatory) (4 bytes)

Burst_Profile message count: The counter of received Burst_Profile PLOAM messages. (R) (mandatory) (4 bytes)

Assign_ONU-ID message count: The counter of received Assign_ONU-ID PLOAM messages. (R) (mandatory) (4 bytes)

Unsatisfied Adjust_Tx_Wavelength requests: The counter of Adjust_Tx_Wavelength requests not applied or partially applied due to target US wavelength being out of Tx tuning range. (R) (mandatory) (4 bytes)

Deactivate_ONU-ID message count: The counter of received Deactivate_ONU-ID PLOAM messages. (R) (mandatory) (4 bytes)

- Disable_Serial_Number message count:** The counter of received Disable_Serial_Number PLOAM messages. (R) (mandatory) (4 bytes)
- Request_Registration message count:** The counter of received Request_Registration PLOAM messages. (R) (mandatory) (4 bytes)
- Assign_Alloc-ID message count:** The counter of received Assign_Alloc-ID PLOAM messages. (R) (mandatory) (4 bytes)
- Key_Control message count:** The counter of received Key_Control PLOAM messages. (R) (mandatory) (4 bytes)
- Sleep_Allow message count:** The counter of received Sleep_Allow PLOAM messages. (R) (mandatory) (4 bytes)
- Tuning_Control/Request message count:** The counter of received Tuning_Control PLOAM messages with Request operation code. (R) (mandatory) (4 bytes)
- Tuning_Control/Complete_d message count:** The counter of received Tuning_Control PLOAM messages with Complete_d operation code. (R) (mandatory) (4 bytes)
- Calibration_Request message count:** The counter of received Calibration_Request PLOAM messages. (R) (mandatory) (4 bytes)

Actions

- Create, delete, get, set
- Get current data (optional)

Notifications

Threshold crossing alert

Alarm number	Threshold crossing alert	Threshold value attribute No. (Note)
0	Unsatisfied Adjust_Tx_Wavelength requests	1
NOTE – This number associates the TCA with the specified threshold value attribute of the threshold data 1/2 managed entities.		

9.16.7 TWDM channel PLOAM performance monitoring history data part 3

This ME collects remaining PLOAM-related PM data associated with the slot/circuit pack, hosting one or more ANI-G MEs, for a specific TWDM channel. Instances of this ME are created and deleted by the OLT.

This ME contains the counters related to transmitted upstream PLOAM messages. All these counters are characterized as *optional* in clause 14 of [ITU-T G.989.3].

For a complete discussion of generic PM architecture, refer to clause I.4.

Relationships

An instance of this ME is associated with an instance of TWDM channel ME.

Attributes

Managed entity ID: This attribute uniquely identifies each instance of this ME. Through an identical ID, this ME is implicitly linked to an instance of the TWDM channel ME. (R, set-by-create) (mandatory) (2 bytes)

- Interval end time:** This attribute identifies the most recently finished 15 min interval. (R) (mandatory) (1 byte)
- Threshold data 1/2 ID:** This attribute points to an instance of the threshold data 1 and 2 MEs that contains PM threshold values. (R, W, set-by-create) (mandatory) (2 bytes)
- Upstream PLOAM message count:** The aggregate counter of PLOAM messages, other than AK PLOAM MT, transmitted by the given ONU. (R) (mandatory) (4 bytes)
- Serial_Number_ONU (in-band) message count:** The counter of transmitted in-band Serial_Number_ONU PLOAM messages. (R) (mandatory) (4 bytes)
- Serial_Number_ONU (AMCC) message count:** The counter of transmitted auxiliary management and control channel (AMCC) Serial_Number_ONU PLOAM messages. (R) (mandatory) (4 bytes)
- Registration message count:** The counter of transmitted Registration PLOAM messages. (R) (mandatory) (4 bytes)
- Key_Report message count:** The counter of transmitted Key_Report PLOAM messages. (R) (mandatory) (4 bytes)
- Acknowledgement message count:** The counter of transmitted Registration PLOAM messages. (R) (mandatory) (4 bytes)
- Sleep_Request message count:** The counter of transmitted Sleep_Request PLOAM messages. (R) (mandatory) (4 bytes)
- Tuning_Response (ACK/NACK) message count:** The counter of transmitted Tuning_Response PLOAM messages with ACK/NACK operation code. (R) (mandatory) (4 bytes)
- Tuning_Response (Complete_u/Rollback) message count:** The counter of transmitted Tuning_Response PLOAM messages with Complete_u/Rollback operation code. (R) (mandatory) (4 bytes)
- Power_Consumption_Report message count:** The counter of transmitted Power_Consumption_Report PLOAM messages. (R) (mandatory) (4 bytes)
- Change_Power_Level parameter error count:** The counter of transmitted Acknowledgement PLOAM messages with Parameter Error completion code in response to Change_Power_Level PLOAM message. (R) (mandatory) (4 bytes)

Actions

- Create, delete, get, set
- Get current data (optional)

Notifications

Threshold crossing alert

Alarm number	Threshold crossing alert	Threshold value attribute No. (Note)
0	Change_Power_Level parameter error count	1
NOTE – This number associates the TCA with the specified threshold value attribute of the threshold data 1/2 managed entities.		

9.16.8 TWDM channel tuning performance monitoring history data part 1

This ME collects certain tuning-control-related PM data associated with the slot/circuit pack, hosting one or more ANI-G MEs, for a specific TWDM channel. Instances of this ME are created and deleted by the OLT.

The relevant events this ME is concerned with are counted towards the PM statistics associated with the source TWDM channel. The attribute descriptions refer to the ONU activation cycle states and timers specified in clause 12 of [ITU-T G.989.3]. This ME contains the counters characterized as *mandatory* in clause 14 of [ITU-T G.989.3].

For a complete discussion of generic PM architecture, refer to clause I.4.

Relationships

An instance of this ME is associated with an instance of TWDM channel ME.

Attributes

Managed entity ID: This attribute uniquely identifies each instance of this ME. Through an identical ID, this ME is implicitly linked to an instance of the TWDM channel ME. (R, set-by-create) (mandatory) (2 bytes)

Interval end time: This attribute identifies the most recently finished 15 min interval. (R) (mandatory) (1 byte)

Threshold data 1/2 ID: This attribute points to an instance of the threshold data 1 and 2 MEs that contains PM threshold values. (R, W, set-by-create) (mandatory) (2 bytes)

Tuning control requests for Rx only or Rx and Tx: The counter of received Tuning_Control PLOAM messages with Request operation code that contain tuning instructions either for receiver only or for both receiver and transmitter. (R) (mandatory) (4 bytes)

Tuning control requests for Tx only: The counter of received Tuning_Control PLOAM messages with Request operation code that contain tuning instructions for transmitter only. (R) (mandatory) (4 bytes)

Tuning control requests rejected/INT_SFC: The counter of transmitted Tuning_Response PLOAM messages with NACK operation code and INT_SFC response code, indicating inability to start transceiver tuning by the specified time (SFC). (R) (mandatory) (4 bytes)

Tuning control requests rejected/DS_XXX: The aggregate counter of transmitted Tuning_Response PLOAM messages with NACK operation code and any DS_XXX response code, indicating target downstream wavelength channel inconsistency. (R) (mandatory) (4 bytes)

Tuning control requests rejected/US_XXX: The aggregate counter of transmitted Tuning_Response PLOAM messages with NACK operation code and any US_XXX response code, indicating target upstream wavelength channel inconsistency. (R) (mandatory) (4 bytes)

Tuning control requests fulfilled with ONU reacquired at target channel: The counter of controlled tuning attempts for which an upstream tuning confirmation has been obtained in the target channel. (R) (mandatory) (4 bytes)

Tuning control requests failed due to target DS wavelength channel not found: The counter of controlled tuning attempts that failed due to timer TO4 expiration in the DS Tuning state (O8) in the target channel. (R) (mandatory) (4 bytes)

Tuning control requests failed due to no feedback in target DS wavelength channel: The counter of controlled tuning attempts that failed due to timer TO5 expiration in the US Tuning state (O9) in the target channel. (R) (mandatory) (4 bytes)

Tuning control requests resolved with ONU reacquired at discretionary channel: The counter of controlled tuning attempts for which an upstream tuning confirmation has been obtained in the discretionary channel. (R) (mandatory) (4 bytes)

Tuning control requests Rollback/COM_DS: The counter of controlled tuning attempts that failed due to communication condition in the target channel, as indicated by the Tuning_Response PLOAM message with Rollback operation code and COM_DS response code. (R) (mandatory) (4 bytes)

Tuning control requests Rollback/DS_xxx: The aggregate counter of controlled tuning attempts that failed due to target downstream wavelength channel inconsistency, as indicated by the Tuning_Response PLOAM message with Rollback operation code and any DS_xxx response code. (R) (mandatory) (4 bytes)

Tuning control requests Rollback/US_xxx: The aggregate counter of controlled tuning attempts that failed due to target upstream wavelength channel parameter violation, as indicated by the Tuning_Response PLOAM message with Rollback operation code and US_xxx response code. (R) (mandatory) (4 bytes)

Tuning control requests failed with ONU reactivation: The counter of controlled tuning attempts that failed on any reason, with expiration of timers TO4 or TO5 causing the ONU transition into state O1. (R) (mandatory) (4 bytes)

Actions

Create, delete, get, set

Get current data (optional)

Notifications

Threshold crossing alert

Alarm number	Threshold crossing alert	Threshold value attribute No. (Note)
0	Tuning control requests rejected/INT_SFC	1
1	Tuning control requests rejected/DS_xxx	2
2	Tuning control requests rejected/US_xxx	3
3	Tuning control requests failed/TO4 exp.	4
4	Tuning control requests failed/TO5 exp.	5
5	Tuning control requests Rollback/COM_DS	6
6	Tuning control requests Rollback/DS_xxx	7
7	Tuning control requests Rollback/US_xxx	8
8	Tuning control requests failed/Reactivation	9

NOTE – This number associates the TCA with the specified threshold value attribute of the threshold data 1/2 managed entities.

9.16.9 TWDM channel tuning performance monitoring history data part 2

This ME collects additional tuning-control-related PM data associated with the slot/circuit pack, hosting one or more ANI-G MEs, for a specific TWDM channel. Instances of this ME are created and deleted by the OLT.

The relevant events this ME is concerned with are counted towards the PM statistics associated with the source TWDM channel. This ME contains the counters characterized as *optional* in clause 14 of [ITU-T G.989.3].

For a complete discussion of generic PM architecture, refer to clause I.4.

Relationships

An instance of this ME is associated with an instance of TWDM channel ME.

Attributes

Managed entity ID: This attribute uniquely identifies each instance of this ME. Through an identical ID, this ME is implicitly linked to an instance of the TWDM channel ME. (R, set-by-create) (mandatory) (2 bytes)

Interval end time: This attribute identifies the most recently finished 15 min interval. (R) (mandatory) (1 byte)

Threshold data 1/2 ID: This attribute points to an instance of the threshold data 1 and 2 MEs that contains PM threshold values. (R, W, set-by-create) (mandatory) (2 bytes)

Tuning control requests rejected/DS_ALBL: The counter of transmitted Tuning_Response PLOAM messages with NACK operation code and DS_ALBL response code, indicating downstream administrative label inconsistency. (R) (mandatory) (4 bytes)

Tuning control requests rejected/DS_VOID: The counter of transmitted Tuning_Response PLOAM messages with NACK operation code and DS_VOID response code, indicating that the target downstream wavelength channel descriptor is void. (R) (mandatory) (4 bytes)

Tuning control requests rejected/DS_PART: The counter of transmitted Tuning_Response PLOAM messages with NACK operation code and DS_PART response code, indicating that tuning request involves channel partition violation. (R) (mandatory) (4 bytes)

Tuning control requests rejected/DS_TUNR: The counter of transmitted Tuning_Response PLOAM messages with NACK operation code and DS_TUNR response code, indicating that the target DS wavelength channel is out of receiver tuning range. (R) (mandatory) (4 bytes)

Tuning control requests rejected/DS_LNRT: The counter of transmitted Tuning_Response PLOAM messages with NACK operation code and DS_LNRT response code, indicating downstream line rate inconsistency in the target channel. (R) (mandatory) (4 bytes)

Tuning control requests rejected/DS_LNCD: The counter of transmitted Tuning_Response PLOAM messages with NACK operation code and DS_LNCD response code, indicating downstream line code inconsistency in the target channel. (R) (mandatory) (4 bytes)

Tuning control requests rejected/US_ALBL: The counter of transmitted Tuning_Response PLOAM messages with NACK operation code and US_ALBL response code,

indicating upstream administrative label inconsistency. (R) (mandatory) (4 bytes)

Tuning control requests rejected/US_VOID: The counter of transmitted Tuning_Response PLOAM messages with NACK operation code and US_VOID response code, indicating that the target upstream wavelength channel descriptor is void. (R) (mandatory) (4 bytes)

Tuning control requests rejected/US_TUNR: The counter of transmitted Tuning_Response PLOAM messages with NACK operation code and US_TUNR response code, indicating that the target US wavelength channel is out of transmitter tuning range. (R) (mandatory) (4 bytes)

Tuning control requests rejected/US_CLBR: The counter of transmitted Tuning_Response PLOAM messages with NACK operation code and US_CLBR response code, indicating that the transmitter has insufficient calibration accuracy in the target US wavelength channel. (R) (mandatory) (4 bytes)

Tuning control requests rejected/US_LKTP: The counter of transmitted Tuning_Response PLOAM messages with NACK operation code and US_LKTP response code, indicating upstream optical link type inconsistency. (R) (mandatory) (4 bytes)

Tuning control requests rejected/US_LNRT: The counter of transmitted Tuning_Response PLOAM messages with NACK operation code and US_LNRT response code, indicating upstream line rate inconsistency in the target channel. (R) (mandatory) (4 bytes)

Tuning control requests rejected/US_LNCD: The counter of transmitted Tuning_Response PLOAM messages with NACK operation code and US_LNCD response code, indicating upstream line code inconsistency in the target channel. (R) (mandatory) (4 bytes)

Actions

Create, delete, get, set

Get current data (optional)

Notifications

Threshold crossing alert

Alarm number	Threshold crossing alert	Threshold value attribute No. (Note)
0	Tuning control requests rejected/DS_ALBL	1
1	Tuning control requests rejected/DS_VOID	2
2	Tuning control requests rejected/DS_PART	3
3	Tuning control requests rejected/DS_TUNR	4
4	Tuning control requests rejected/DS_LNRT	5
5	Tuning control requests rejected/DS_LNCD	6
6	Tuning control requests rejected/US_ALBL	7
7	Tuning control requests rejected/US_VOID	8
8	Tuning control requests rejected/US_TUNR	9
9	Tuning control requests rejected/US_CLBR	10
10	Tuning control requests rejected/US_LKTP	11

Threshold crossing alert

Alarm number	Threshold crossing alert	Threshold value attribute No. (Note)
11	Tuning control requests rejected/US_LNRT	12
12	Tuning control requests rejected/US_LNCD	13

NOTE – This number associates the TCA with the specified threshold value attribute of the threshold data 1/2 managed entities.

9.16.10 TWDM channel tuning performance monitoring history data part 3

This ME collects remaining tuning-control-related PM data associated with the slot/circuit pack, hosting one or more ANI-G MEs, for a specific TWDM channel. Instances of this ME are created and deleted by the OLT.

The relevant events this ME is concerned with are counted towards the PM statistics associated with the source TWDM channel. This ME contains the counters characterized as *optional* in clause 14 of [ITU-T G.989.3].

For a complete discussion of generic PM architecture, refer to clause I.4.

Relationships

An instance of this ME is associated with an instance of TWDM channel ME.

Attributes

Managed entity ID: This attribute uniquely identifies each instance of this ME. Through an identical ID, this ME is implicitly linked to an instance of the TWDM channel ME. (R, set-by-create) (mandatory) (2 bytes)

Interval end time: This attribute identifies the most recently finished 15 min interval. (R) (mandatory) (1 byte)

Threshold data 1/2 ID: This attribute points to an instance of the threshold data 1 and 2 MEs that contains PM threshold values. (R, W, set-by-create) (mandatory) (2 bytes)

Tuning control requests Rollback/DS_ALBL: The counter of controlled tuning attempts that failed due to downstream administrative label inconsistency, as indicated by the Tuning_Response PLOAM message with Rollback operation code and DS_ALBL response code. (R) (mandatory) (4 bytes)

Tuning control requests Rollback/DS_LKTP: The counter of controlled tuning attempts that failed due to downstream optical link type inconsistency, as indicated by the Tuning_Response PLOAM message with Rollback operation code and DS_LKTP response code. (R) (mandatory) (4 bytes)

Tuning control requests Rollback/US_ALBL: The counter of controlled tuning attempts that failed due to upstream administrative label violation, as indicated by the Tuning_Response PLOAM message with Rollback operation code and US_ALBL response code. (R) (mandatory) (4 bytes)

Tuning control requests Rollback/US_VOID: The counter of controlled tuning attempts that failed due to the target upstream wavelength channel descriptor being void, as indicated by the Tuning_Response PLOAM message with Rollback operation code and US_VOID response code. (R) (mandatory) (4 bytes)

Tuning control requests Rollback/US_TUNR: The counter of controlled tuning attempts that failed due to the transmitter tuning range violation, as indicated by the

Tuning_Response PLOAM message with Rollback operation code and US_TUNR response code. (R) (mandatory) (4 bytes)

Tuning control requests Rollback/US_LKTP: The counter of controlled tuning attempts that failed due to the upstream optical link type violation, as indicated by the Tuning_Response PLOAM message with Rollback operation code and US_LKTP response code. (R) (mandatory) (4 bytes)

Tuning control requests Rollback/US_LNRT: The counter of controlled tuning attempts that failed due to the upstream line rate violation, as indicated by the Tuning_Response PLOAM message with Rollback operation code and US_LNRT response code. (R) (mandatory) (4 bytes)

Tuning control requests Rollback/US_LNCD: The counter of controlled tuning attempts that failed due to the upstream line code violation, as indicated by the Tuning_Response PLOAM message with Rollback operation code and US_LNCD response code. (R) (mandatory) (4 bytes)

Actions

Create, delete, get, set

Get current data (optional)

Notifications

Threshold crossing alert

Alarm number	Threshold crossing alert	Threshold value attribute No. (Note)
0	Tuning control requests Rollback/DS_ALBL	1
1	Tuning control requests Rollback /DS_LKTP	2
2	Tuning control requests Rollback/US_ALBL	3
3	Tuning control requests Rollback /US_VOID	4
4	Tuning control requests Rollback/US_TUNR	5
5	Tuning control requests Rollback /US_LKTP	6
6	Tuning control requests Rollback/US_LNRT	7
7	Tuning control requests Rollback /US_LNCD	8

NOTE – This number associates the TCA with the specified threshold value attribute of the threshold data 1/2 managed entities.

9.16.11 TWDM channel OMCI performance monitoring history data

This ME collects OMCI-related PM data associated with the slot/circuit pack, hosting one or more ANI-G MEs, for a specific TWDM channel. Instances of this ME are created and deleted by the OLT.

The counters maintained by this ME are characterized as *optional* in clause 14 of [ITU-T G.989.3].

For a complete discussion of generic PM architecture, refer to clause I.4.

Relationships

An instance of this ME is associated with an instance of TWDM channel ME.

Attributes

Managed entity ID: This attribute uniquely identifies each instance of this ME. Through an identical ID, this ME is implicitly linked to an instance of the TWDM channel ME. (R, set-by-create) (mandatory) (2 bytes)

Interval end time: This attribute identifies the most recently finished 15 min interval. (R) (mandatory) (1 byte)

Threshold data 1/2 ID: This attribute points to an instance of the threshold data 1 and 2 MEs that contains PM threshold values. (R, W, set-by-create) (mandatory) (2 bytes)

OMCI baseline message count: The counter of baseline format OMCI messages directed to the given ONU. (R) (mandatory) (4 bytes)

OMCI extended message count: The counter of extended format OMCI messages directed to the given ONU. (R) (mandatory) (4 bytes)

OMCI MIC error count: The counter of OMCI messages received with MIC errors. (R) (mandatory) (4 bytes)

Actions

Create, delete, get, set

Get current data (optional)

Notifications

Threshold crossing alert

Alarm number	Threshold crossing alert	Threshold value attribute No. (Note)
0	OMCI MIC error count	1
NOTE – This number associates the TCA with the specified threshold value attribute of the threshold data 1/2 managed entities.		

10 This clause is intentionally left blank

11 ONU management and control protocol

11.1 Baseline and extended messages

This clause defines two formats for OMCI messages, baseline and extended.

ITU-T GTC based PON systems are free to use either the baseline or the extended OMCI message format. The baseline format is the default at initialization. Use of the extended format is then negotiated between the OLT and ONU.

The conventions for the use of baseline and extended messages by systems complying with other Recommendations are for further study.

Baseline messages have 48 byte fixed length PDUs, while extended messages have variable length PDUs. A receiver that does not support extended messages may therefore reject an extended message based on nothing more than their length.

Both baseline and extended messages carry an MIC in their final 4 bytes. This facilitates *ad hoc* recovery of both MTs by a receiver. In ITU-T G.984 systems, the MIC is an ITU-T I.363.5 CRC; in the subsequent ITU-T PON systems, the MIC is a cryptographic hash as specified in the respective TC layer specification.

Baseline and extended messages are distinguished from one another by the device identifier field, which is in the same byte location in both MTs. Baseline messages contain device identifier 0x0A, while extended messages employ device identifier 0x0B.

All G-PON ONUs and OLTs are required to support the baseline format. During initialization, and whenever the ONU is re-ranged on to the PON, both entities use the baseline format to establish

communications and to negotiate their capabilities. If both endpoints support extended messages, they may or may not choose to conduct all or some subsequent communications in the extended message set. Baseline messages may be used for any transaction, i.e., any exchange of one or more related messages such as a get/get-next sequence.

Figure 11.1-1 illustrates the negotiation and the exchange of messages in one or the other message format.

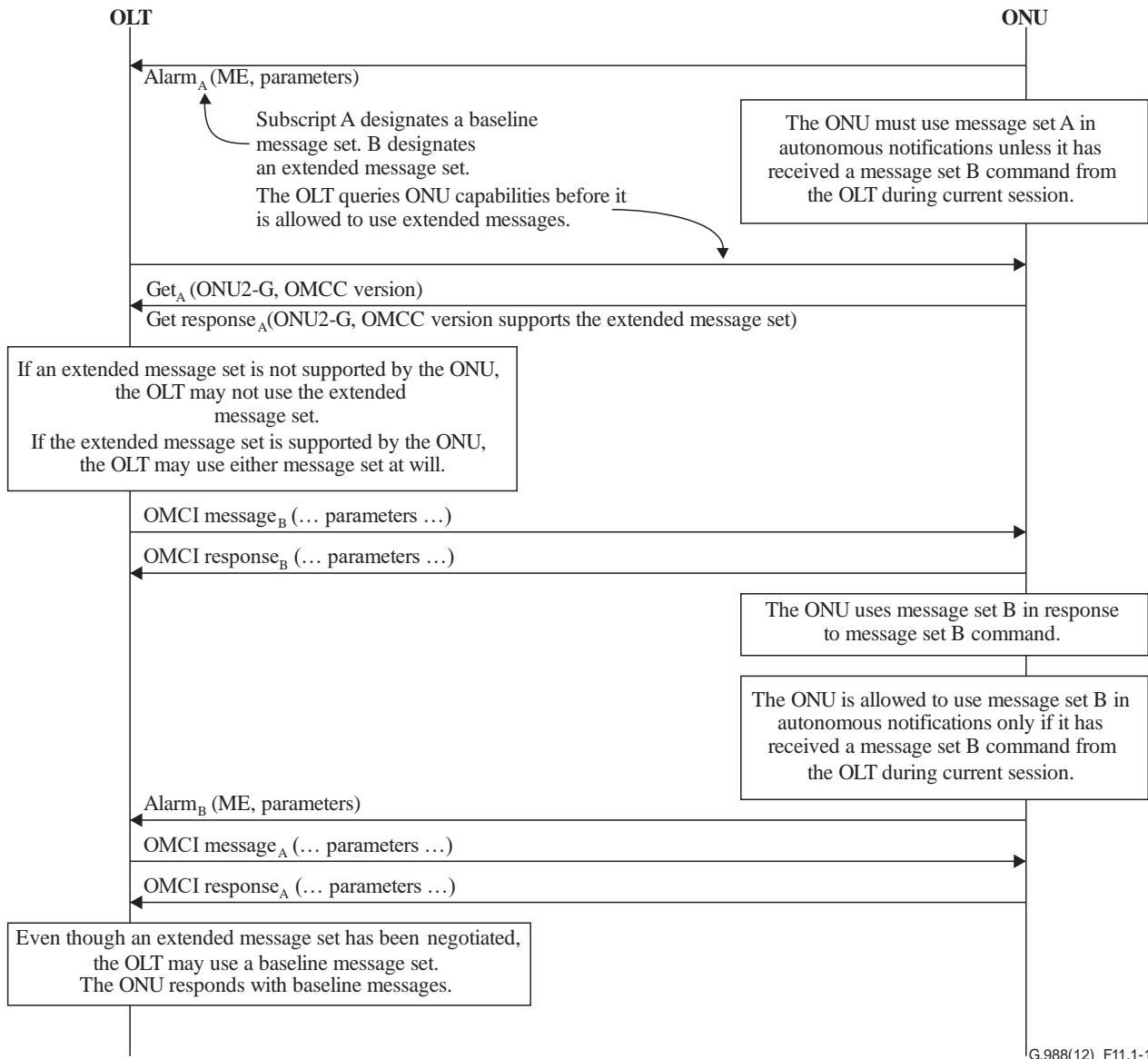

Figure 11.1-1 – G-PON OMCI message set negotiation

If a G-PON OLT has *a priori* knowledge that the ONU supports the extended message set, it may choose to omit the query step. However, a G-PON ONU may not transmit extended messages, including autonomous notifications, until it has received at least one extended message from the OLT during the current session (since initialization or re-activation on the PON).

11.2 Common message characteristics

Each OMCI protocol packet is encapsulated directly in one GEM frame, or several GEM frames if necessary to satisfy the normal fragmentation rules. The GEM frame header contains the OMCC port-ID.

Table 11.2-1 shows the baseline message format. The packet has a fixed length of 48 bytes.

Table 11.2-1 – Baseline OMCI message format

Byte number	Size	Use
1..2	2	Transaction correlation identifier
3	1	Message type
4	1	Device identifier
5..8	4	Managed entity identifier
9..40	32	Message contents
41..48	8	OMCI trailer

Table 11.2-2 shows the extended message format. The packet has variable length N , up to 1980 bytes.

Table 11.2-2 – Extended OMCI message format

Byte number	Size	Use
1..2	2	Transaction correlation identifier
3	1	Message type
4	1	Device identifier
5..8	4	Managed entity identifier
9..10	2	Message contents length
11..(N-4)	–	Message contents
(N-3)..N	4	Message integrity check (MIC)

Clauses 11.2.1 to 11.2.8 specify each field of these messages.

11.2.1 Transaction correlation identifier

The transaction correlation identifier is used to associate a request message with its response message. For request messages, the OLT selects a transaction identifier, an arbitrary value that should be chosen to avoid the possibility of ambiguous responses from ONUs. A response message carries the transaction identifier of the message to which it is responding. The transaction identifier of messages generated autonomously by an ONU is 0.

As explained in clause B.2.2, and for the baseline message format only, the MSB of the transaction correlation identifier indicates the priority of the message. The following coding is used: 0 = low priority, 1 = high priority. The OLT decides whether a command should be executed with low or high priority. The extended message format does not recognize priorities.

11.2.2 Message type

The MT field is subdivided into four parts. These are shown in Figure 11.2.2-1.

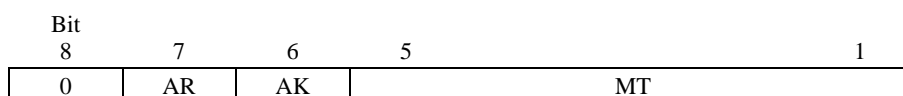

Figure 11.2.2-1 – Message type field subdivision

Bit 8, the MSB, is reserved for future use, and is always 0.

Bit 7, acknowledge request (AR), indicates whether the message requires an AK. An AK is a response to an action request, not a link layer handshake. If an AK is expected, this bit is set to 1. If no AK is expected, this bit is 0. In messages sent by the ONU, this bit is always 0.

Bit 6, AK, indicates whether this message is an AK to an action request. If a message is an AK, this bit is set to 1. If the message is not a response to a command, this bit is set to 0. In messages sent by the OLT, this bit is always 0.

Bits 5..1, MT, indicate the MT, as defined in Table 11.2.2-1. Values not shown in Table 11.2.2-1 are reserved.

Table 11.2.2-1 – OMCI message types

MT	Type	Purpose	AK	Increment MIB data sync
4	Create	Create a managed entity instance with its attributes	Yes	Yes
6	Delete	Delete a managed entity instance	Yes	Yes
8	Set	Set one or more attributes of a managed entity	Yes	(Note 1)
9	Get	Get one or more attributes of a managed entity. When directed to a table attribute, get causes the ONU to latch a copy of the table for retrieval with a sequence of get next commands.	Yes	No
11	Get all alarms	Latch the alarm statuses of all managed entities and reset the alarm message counter	Yes	No
12	Get all alarms next	Get the active alarm status of the next managed entity or entities from the latched alarm status copy	Yes	No
13	MIB upload	Latch a copy of the MIB. Some MEs and some attributes are not included in an MIB upload.	Yes	No
14	MIB upload next	Get the next set of attributes of the managed entity instances included in the latched MIB copy	Yes	No
15	MIB reset	Clear the MIB, re-initialize it to its default, and reset the MIB data sync counter to 0	Yes	No
16	Alarm	Notification of an alarm or a threshold crossing alert	No	No
17	Attribute value change	Autonomous notification of an attribute value change	No	No
18	Test	Request a test on a specific managed entity	Yes	No
19	Start software download	Start a software download action	Yes	Yes
20	Download section	Download a section of a software image	(Note 2)	No
21	End software download	End of a software download action	Yes	Yes
22	Activate software	Activate the downloaded software image	Yes	Yes
23	Commit software	Commit the downloaded software image	Yes	Yes
24	Synchronize time	Synchronize PM interval time between OLT and ONU	Yes	No
25	Reboot	Reboot ONU or circuit pack	Yes	No

Table 11.2.2-1 – OMCI message types

MT	Type	Purpose	AK	Increment MIB data sync
26	Get next	Get the latched attribute values of the managed entity within the current snapshot	Yes	No
27	Test result	Notification of result initiated by a test command	No	No
28	Get current data	Get current counter value associated with one or more attributes of a performance monitoring managed entity	Yes	No
29	Set table (Note 3)	Set one or more rows of a table	Yes	Yes
<p>NOTE 1 – MIB sync is incremented if a set action successfully updates any of the attributes specified, even if some other attributes of the same set action were to fail.</p> <p>NOTE 2 – The download section action is acknowledged only for the last section within a window. See clause I.3.</p> <p>NOTE 3 – Set table is defined only in the extended message set.</p>				

11.2.3 Device identifier

In baseline OMCI messages, this field is defined to be 0x0A.

In extended OMCI messages, this field is defined to be 0x0B.

All other values are reserved.

11.2.4 Managed entity identifier

The ME identifier comprises 4 bytes. The most significant 2 bytes of the ME identifier field designate the ME class value of the target ME. The maximum number of possible ME classes is thus 65535 (0 is not used). The least significant 2 bytes of the ME identifier field identify the ME instance. Depending on the ME class, there may be none, one (e.g., ONU-G) or several (e.g., MAC bridge port config data) instances in an ONU.

Table 11.2.4-1 specifies the MEs and their class values in the OMCI.

NOTE – This table contains all ME classes ever standardized for the OMCI, including [ITU-T G.983.2] and [ITU-T G.984.4], as well as features now deprecated. These class values remain assigned to their original values.

Table 11.2.4-1 – Managed entity identifiers

Managed entity class value	Managed entity
1	ONT _{B-PON}
2	ONU data
3	PON IF line cardholder
4	PON IF line card
5	Cardholder
6	Circuit pack
7	Software image
8	UNI _{B-PON}

Table 11.2.4-1 – Managed entity identifiers

Managed entity class value	Managed entity
9	TC Adapter _{B-PON}
10	Physical path termination point ATM UNI
11	Physical path termination point Ethernet UNI
12	Physical path termination point CES UNI
13	Logical $N \times 64$ kbit/s sub-port connection termination point
14	Interworking VCC termination point
15	AAL1 profile _{B-PON}
16	AAL5 profile
17	AAL1 protocol monitoring history data _{B-PON}
18	AAL5 performance monitoring history data
19	AAL2 profile
20	(Intentionally left blank)
21	CES service profile
22	(Reserved)
23	CES physical interface performance monitoring history data
24	Ethernet performance monitoring history data
25	VP network CTP _{BPON}
26	ATM VP cross-connection
27	Priority queue _{B-PON}
28	DBR/CBR traffic descriptor
29	UBR traffic descriptor
30	SBR1/VBR1 traffic descriptor
31	SBR2/VBR2 traffic descriptor
32	SBR3/VBR3 traffic descriptor
33	ABR traffic descriptor
34	GFR traffic descriptor
35	ABT/DT/IT traffic descriptor
36	UPC disagreement monitoring history data _{B-PON}
37	(Intentionally left blank)
38	ANI (B-PON)
39	PON TC adapter
40	PON physical path termination point
41	TC adapter protocol monitoring history data
42	Threshold data _{B-PON}
43	Operator specific
44	Vendor specific
45	MAC bridge service profile

Table 11.2.4-1 – Managed entity identifiers

Managed entity class value	Managed entity
46	MAC bridge configuration data
47	MAC bridge port configuration data
48	MAC bridge port designation data
49	MAC bridge port filter table data
50	MAC bridge port bridge table data
51	MAC bridge performance monitoring history data
52	MAC bridge port performance monitoring history data
53	Physical path termination point POTS UNI
54	Voice CTP
55	Voice PM history data
56	AAL2 PVC profile _{B-PON}
57	AAL2 CPS protocol monitoring history data _{B-PON}
58	Voice service profile
59	LES service profile
60	AAL2 SCS parameter profile1
61	AAL2 SCS parameter profile2
62	VP performance monitoring history data
63	Traffic scheduler _{B-PON}
64	T-CONT buffer
65	UBR+ traffic descriptor
66	AAL2 SCS protocol monitoring history data _{B-PON}
67	IP port configuration data
68	IP router service profile
69	IP router configuration data
70	IP router performance monitoring history data 1
71	IP router performance monitoring history data 2
72	ICMP performance monitoring history data 1
73	ICMP performance monitoring history data 2
74	IP route table
75	IP static routes
76	ARP service profile
77	ARP configuration data
78	VLAN tagging operation configuration data
79	MAC bridge port filter pre-assign table
80	Physical path termination point ISDN UNI
81	(Reserved)
82	Physical path termination point video UNI

Table 11.2.4-1 – Managed entity identifiers

Managed entity class value	Managed entity
83	Physical path termination point LCT UNI
84	VLAN tagging filter data
85	ONU _{B-PON}
86	ATM VC cross-connection
87	VC network CTP _{B-PON}
88	VC PM history data
89	Ethernet performance monitoring history data 2
90	Physical path termination point video ANI
91	Physical path termination point IEEE 802.11 UNI
92	IEEE 802.11 station management data 1
93	IEEE 802.11 station management data 2
94	IEEE 802.11 general purpose object
95	IEEE 802.11 MAC and PHY operation and antenna data
96	IEEE 802.11 performance monitoring history data
97	IEEE 802.11 PHY FHSS DSSS IR tables
98	Physical path termination point xDSL UNI part 1
99	Physical path termination point xDSL UNI part 2
100	xDSL line inventory and status data part 1
101	xDSL line inventory and status data part 2
102	xDSL channel downstream status data
103	xDSL channel upstream status data
104	xDSL line configuration profile part 1
105	xDSL line configuration profile part 2
106	xDSL line configuration profile part 3
107	xDSL channel configuration profile
108	xDSL subcarrier masking downstream profile
109	xDSL subcarrier masking upstream profile
110	xDSL PSD mask profile
111	xDSL downstream RFI bands profile
112	xDSL xTU-C performance monitoring history data
113	xDSL xTU-R performance monitoring history data
114	xDSL xTU-C channel performance monitoring history data
115	xDSL xTU-R channel performance monitoring history data
116	TC adaptor performance monitoring history data xDSL
117	Physical path termination point VDSL UNI (ITU-T G.993.1 VDSL1)
118	VDSL VTU-O physical data
119	VDSL VTU-R physical data

Table 11.2.4-1 – Managed entity identifiers

Managed entity class value	Managed entity
120	VDSL channel data
121	VDSL line configuration profile
122	VDSL channel configuration profile
123	VDSL band plan configuration profile
124	VDSL VTU-O physical interface monitoring history data
125	VDSL VTU-R physical interface monitoring history data
126	VDSL VTU-O channel performance monitoring history data
127	VDSL VTU-R channel performance monitoring history data
128	Video return path service profile
129	Video return path performance monitoring history data
130	IEEE 802.1p mapper service profile
131	OLT-G
132	Multicast interworking VCC termination point
133	ONU power shedding
134	IP host config data
135	IP host performance monitoring history data
136	TCP/UDP config data
137	Network address
138	VoIP config data
139	VoIP voice CTP
140	Call control performance monitoring history data
141	VoIP line status
142	VoIP media profile
143	RTP profile data
144	RTP performance monitoring history data
145	Network dial plan table
146	VoIP application service profile
147	VoIP feature access codes
148	Authentication security method
149	SIP config portal
150	SIP agent config data
151	SIP agent performance monitoring history data
152	SIP call initiation performance monitoring history data
153	SIP user data
154	MGC config portal
155	MGC config data
156	MGC performance monitoring history data

Table 11.2.4-1 – Managed entity identifiers

Managed entity class value	Managed entity
157	Large string
158	ONU remote debug
159	Equipment protection profile
160	Equipment extension package
161	Port-mapping package _{EBPON} (B-PON only; use 297 for G-PON)
162	Physical path termination point MoCA UNI
163	MoCA Ethernet performance monitoring history data
164	MoCA interface performance monitoring history data
165	VDSL2 line configuration extensions
166	xDSL line inventory and status data part 3
167	xDSL line inventory and status data part 4
168	VDSL2 line inventory and status data part 1
169	VDSL2 line inventory and status data part 2
170	VDSL2 line inventory and status data part 3
171	Extended VLAN tagging operation configuration data
172..239	Reserved for future B-PON managed entities
240-255	Reserved for vendor-specific managed entities
256	ONU-G (NOTE – In [ITU-T G.984.4] this was called ONT-G)
257	ONU2-G (NOTE – In [ITU-T G.984.4] this was called ONT2-G)
258	ONU-G (deprecated – note that the name is re-used for code point 256)
259	ONU2-G (deprecated – note that the name is re-used for code point 257)
260	PON IF line card-G
261	PON TC adapter-G
262	T-CONT
263	ANI-G
264	UNI-G
265	ATM interworking VCC termination point
266	GEM interworking termination point
267	GEM port performance monitoring history data (obsolete)
268	GEM port network CTP
269	VP network CTP
270	VC network CTP-G
271	GAL TDM profile (deprecated)
272	GAL Ethernet profile
273	Threshold data 1
274	Threshold data 2
275	GAL TDM performance monitoring history data (deprecated)

Table 11.2.4-1 – Managed entity identifiers

Managed entity class value	Managed entity
276	GAL Ethernet performance monitoring history data
277	Priority queue
278	Traffic scheduler
279	Protection data
280	Traffic descriptor
281	Multicast GEM interworking termination point
282	Pseudowire termination point
283	RTP pseudowire parameters
284	Pseudowire maintenance profile
285	Pseudowire performance monitoring history data
286	Ethernet flow termination point
287	OMCI
288	Managed entity
289	Attribute
290	Dot1X port extension package
291	Dot1X configuration profile
292	Dot1X performance monitoring history data
293	Radius performance monitoring history data
294	TU CTP
295	TU performance monitoring history data
296	Ethernet performance monitoring history data 3
297	Port-mapping package
298	Dot1 rate limiter
299	Dot1ag maintenance domain
300	Dot1ag maintenance association
301	Dot1ag default MD level
302	Dot1ag MEP
303	Dot1ag MEP status
304	Dot1ag MEP CCM database
305	Dot1ag CFM stack
306	Dot1ag chassis-management info
307	Octet string
308	General purpose buffer
309	Multicast operations profile
310	Multicast subscriber config info
311	Multicast subscriber monitor
312	FEC performance monitoring history data

Table 11.2.4-1 – Managed entity identifiers

Managed entity class value	Managed entity
313	RE ANI-G
314	Physical path termination point RE UNI
315	RE upstream amplifier
316	RE downstream amplifier
317	RE config portal
318	File transfer controller
319	CES physical interface performance monitoring history data 2
320	CES physical interface performance monitoring history data 3
321	Ethernet frame performance monitoring history data downstream
322	Ethernet frame performance monitoring history data upstream
323	VDSL2 line configuration extensions 2
324	xDSL impulse noise monitor performance monitoring history data
325	xDSL line inventory and status data part 5
326	xDSL line inventory and status data part 6
327	xDSL line inventory and status data part 7
328	RE common amplifier parameters
329	Virtual Ethernet interface point
330	Generic status portal
331	ONU-E
332	Enhanced security control
333	MPLS pseudowire termination point
334	Ethernet frame extended PM
335	SNMP configuration data
336	ONU dynamic power management control
337	PW ATM configuration data
338	PW ATM performance monitoring history data
339	PW Ethernet configuration data
340	BBF TR-069 management server
341	GEM port network CTP performance monitoring history data
342	TCP/UDP performance monitoring history data
343	Energy consumption performance monitoring history data
344	XG-PON TC performance monitoring history data
345	XG-PON downstream management performance monitoring history data
346	XG-PON upstream management performance monitoring history data
347	IPv6 host config data
348	MAC bridge port ICMPv6 process pre-assign table
349	PoE control

Table 11.2.4-1 – Managed entity identifiers

Managed entity class value	Managed entity
350-399	Reserved for vendor-specific use
400	Ethernet pseudowire parameters
401	Physical path termination point RS232/RS485 UNI
402	RS232/RS485 port operation configuration data
403	RS232/RS485 performance monitoring history data
404	L2 multicast GEM interworking termination point
405	ANI-E
406	EPON downstream performance monitoring configuration
407	SIP agent config data 2
408	xDSL xTU-C performance monitoring history data part 2
409	PTM performance monitoring history data xDSL
410	VDSL2 line configuration extensions 3
411	Vectoring line configuration extensions
412	xDSL channel configuration profile part 2
413	xTU data gathering configuration
414	xDSL line inventory and status data part 8
415	VDSL2 line inventory and status data part 4
416	Vectoring line inventory and status data
417	Data gathering line test, diagnostic and status
418	EFM bonding group
419	EFM bonding link
420	EFM bonding group performance monitoring history data
421	EFM bonding group performance monitoring history data part 2
422	EFM bonding link performance monitoring history data
423	EFM bonding port performance monitoring history data
424	EFM bonding port performance monitoring history data part 2
425	Ethernet frame extended PM 64 bit
426	Threshold data 64 bit
427	Physical path termination point xDSL UNI part 3
428	FAST line configuration profile part 1
429	FAST line configuration profile part 2
430	FAST line configuration profile part 3
431	FAST line configuration profile part 4
432	FAST channel configuration profile
433	FAST data path configuration profile
434	FAST vectoring line configuration extensions
435	FAST line inventory and status data

Table 11.2.4-1 – Managed entity identifiers

Managed entity class value	Managed entity
436	FAST line inventory and status data part 2
437	FAST xTU-C performance monitoring history data
438	FAST xTU-R performance monitoring history data
439	OpenFlow config data
440	Time Status Message
441	ONU3-G
442	TWDM System Profile managed entity
443	TWDM channel managed entity
444	TWDM channel PHY/LODS performance monitoring history data
445	TWDM channel XGEM performance monitoring history data
446	TWDM channel PLOAM performance monitoring history data part 1
447	TWDM channel PLOAM performance monitoring history data part 2
448	TWDM channel PLOAM performance monitoring history data part 3
449	TWDM channel tuning performance monitoring history data part 1
450	TWDM channel tuning performance monitoring history data part 2
451	TWDM channel tuning performance monitoring history data part 3
452	TWDM channel OMCI performance monitoring history data
453	Enhanced FEC performance monitoring history data
454	Enhanced TC performance monitoring history data
455	Link aggregation service profile
456	ONU manufacturing data
457	ONU time configuration
458	IP host performance monitoring history data part 2
459	ONU operational performance monitoring history data
<u>460</u>	<u>ONU4-G</u>
<u>461</u>	<u>BBF TR-369 USP agent</u>
460 <u>462</u> -65279	Reserved for future standardization
65280-65535	Reserved for vendor-specific use

11.2.5 Message contents length, extended message format

These 2 bytes contain the length, in bytes, of the message contents field. Its value lies between 0 and 1966, for a 1980 byte PDU limit.

To specify this range, 11 bits suffice. The five MSBs of this field are reserved for future use.

From time to time, new parameters may be added to OMCI messages. The rules for the extended message set are as follows.

- For backward compatibility, any new field must be added at the end of the OMCI message, they must be optional (and be documented as such) with the default value 0 that has backward compatible semantics.

- Trailing optional fields in a message may be omitted or included at the option of the transmitting device. The transmitting device sets the message content length field accordingly.
- The receiving device should not reject the message on the grounds of unexpected message content length.
- A receiving device that does not support the optional trailing fields should ignore them.
- The OLT must be prepared to accept a response based on the premise that the ONU does not support the optional fields, whether the optional fields are in the transmitted command message or in the received response message or both. In such a case, the value in the received response message content length field will be lower than expected.

11.2.6 Message contents

The layout of the message content field is specific to each MT. The detailed layout of all messages appears in Annex A.

11.2.7 OMCI trailer, baseline message format

The 8 bytes of this field are based on the AAL5 trailer definition:

- The first 2 bytes correspond to common part convergence sublayer user-to-user (CPCS-UU) and CPI. They are set to 0 at the transmitter and ignored at the receiver.
- The length of the common part convergence sublayer service data unit (CPCS-SDU) field is set to 0x0028 (40 decimal).
- In ITU-T G.984 applications, the MIC is a 32 bit CRC as specified in [ITU-T I.363.5]. In ITU-T G.987 applications, the MIC is as specified in [ITU-T G.987.3].

11.2.8 MIC, extended message format

The integrity of an extended format OMCI message is verified by this 4 byte field. In ITU-T G.984 systems, the MIC is a 32 bit CRC as specified in [ITU-T I.363.5]. In subsequent PON systems the MIC calculation is defined in the respective TC layer specification.

11.2.9 Message limits

Baseline OMCI messages impose limits on the size of attributes. Table 11.2.9-1 lists the important limits.

Table 11.2.9-1 – OMCI baseline message limitations

Item	Limited by	Maximum size, bytes
Total size of set-by-create attributes (including ME ID)	Create	34
Size of (R) or (R,W) simple attribute	Get response	25
Size of (R) or (R,W) structured table entry (Note)	Set	30
Total size of a get	Get response	25
Total size of a get current data	Get current data response	25
NOTE – A structured table is one that contains distinct and separable rows, each row of which has the same syntax as the others. Long strings of bytes are also designated tables in clause 9, because the mechanism for retrieval is the same: get, followed by a number of get next commands. Such a byte string could be regarded as a table with but a single row, the length of which is limited only by the number of get next commands that can be specified. There is no way to set a value into such a byte string, however, so these attributes are necessarily read-only.		

Extended messages are limited by the total size of the PDU, and there is no possibility that a get or set or create message, even with a maximum number (16) of maximum length (25 byte) attributes, can exceed the message size limit. For backward compatibility, attribute definitions remain within the size limits of baseline messages, but a single extended message may contain more attributes than a baseline message.

In cases where compatibility with [ITU-T G.984.4] is not required, future MEs are not intrinsically subject to these constraints. However, the evolution of common code encourages that attributes longer than 25 bytes be designated as table attributes, and that the get and get-next sequence be used to retrieve tables.

The following considerations apply to baseline messages only. The larger PDU eliminates the possibility of message length violation in the extended message set.

It is important that OLT and ONU implementations take size limits into account. For example, it is easy to form a (baseline) get command that asks the ONU to return more attributes than can fit into a (baseline) get response message. If the OLT asks for too many attributes in a get request, the ONU may respond with as many attributes as fit into the space available. From the attribute-present mask, the OLT can parse the attributes that were sent correctly, and can issue another get to retrieve the attributes that did not fit.

While this is the preferred behaviour, an alternate interpretation is that the ONU returns a parameter error code when it receives a (baseline) get request whose response does not completely fit into one (baseline) get response message. For the sake of interoperability, the expected behaviour between an OLT and ONU with different interpretations is provided as follows.

Case 1. The ONU reports a parameter error, and the OLT expects a partial list. If this happens, the OLT should react by simplifying its get request. The ONU then responds without an error.

Case 2. The ONU provides a partial list, while the OLT expects to get an error. The OLT receives a normal message and processes it normally. The OLT asks again for any attributes it did not get.

11.2.10 Test result enumeration

Test actions can return measurements of various physical parameters in vendor-specific ways. Table 11.2.10-1 identifies parameters that may be of interest, with enumerated values to represent them in the test response message defined in Annex A.

The resolution shown in the following descriptions merely indicates the weight attached to the LSB, and is not intended to impose requirements for precision or accuracy of the measured value.

Table 11.2.10-1 – Codes to represent measured values

Type	Parameter	Representation
1	Power feed voltage, V	DC voltage, 2s complement, 20 mV resolution
2	Low voltage, V	DC voltage, 2s complement, 100 μ V resolution
3	Received optical power, dB	dB μ W, 2s complement, 0.002 dB resolution
4	Received optical power, W	Power, unsigned integer, 0.1 μ W resolution
5	Transmitted optical power, dB μ W	dB μ W, 2s complement, 0.002 dB resolution
6	Transmitted optical power, W	Power, unsigned integer, 0.1 μ W resolution
7	Video level, dBmV	dBmV, 2s complement, 0.002 dB resolution
8	Video level, V	RF voltage, unsigned integer, 200 μ V resolution. May be filtered or weighted in accordance with vendor-specific needs.

Table 11.2.10-1 – Codes to represent measured values

Type	Parameter	Representation
9	Laser bias current	Unsigned integer, 2 μ A resolution
10	Received voice signal quality measure Q	Unsigned integer, resolution 0.1
11	Signal-to-noise ratio, dB	Unsigned integer, resolution 0.1 dB
12	Temperature, degrees C	2s complement, 1/256 degree C resolution
13..239	Reserved for future standardization	
240-254	Not to be standardized. Available for vendor use.	
255	Reserved	Indicates an unavailable field in an ordered list of response values.

Annex A

OMCI message syntax and common features

(This annex forms an integral part of this Recommendation.)

A.1 General

A.1.1 Result and reason

Responses to commands can indicate the result of the command. A zero value indicates that the command was processed successfully. Non-zero values indicate the reason for the failure. If the result was failure, the rest of the message contents may provide details of the failure, may be filled with all 0, or in the extended message set, may simply be omitted. The definition of each result and reason appears in Table A.1.1-1.

Table A.1.1-1 – Result and reason codes

Code	Headline	Description
0000	Command processed successfully	There are two functions for command processing: command interpretation and command execution. This result means that the received command, such as get/set/test/reboot, was properly interpreted by the ONU's command interpretation function without errors and that the interpreted command was successfully transferred to the ONU's command execution function.
0001	Command processing error	This result means the command processing failed at the ONU for reasons not described by one of the more specific error codes.
0010	Command not supported	This result means that the message type indicated in byte 3 is not supported by the ONU.
0011	Parameter error	This result means that the command message received by the ONU was errored. It would be appropriate if an attribute mask were out of range, for example. In practice, this result code is frequently used interchangeably with code 1001. However, the optional attribute and attribute execution masks in the reply messages are only defined for code 1001.
0100	Unknown managed entity	This result means that the managed entity class (bytes 5..6) is not supported by the ONU.
0101	Unknown managed entity instance	This result means that the managed entity instance (bytes 7..8) does not exist in the ONU.
0110	Device busy	This result means that the command could not be processed due to process-related congestion at the ONU. This result code may also be used as a pause indication to the OLT while the ONU conducts a time-consuming operation such as storage of a software image into non-volatile memory.
0111	Instance exists	This result means that the ONU already has a managed entity instance that corresponds to the one the OLT is attempting to create.

Table A.1.1-1 – Result and reason codes

Code	Headline	Description
1001	Attribute(s) failed or unknown	<p>This result means that an optional attribute is not supported by the ONU or that a mandatory/optional attribute could not be executed by the ONU, even if it is supported, e.g., because of a range or type violation. In conjunction with this result, attribute masks are used to indicate which attributes failed or were unknown.</p> <p>Two kinds of attribute masks are used when this result/reason is raised:</p> <ul style="list-style-type: none"> • <i>optional attribute mask coding</i>, which indicates whether the optional attribute is supported; • <i>attribute execution mask coding</i>, which indicates whether the mandatory/optional attribute was executed. <p>See the set response and get response message layouts (see clauses A.2.6, A.3.6, A.2.8 and A.3.8) for the placement of these masks.</p> <p>If one or more optional attributes are not supported by the ONU, the optional attribute mask coding for each <i>unsupported</i> optional attribute becomes 1 while the corresponding attribute execution mask coding remains 0.</p> <p>If one or more mandatory or optional attributes were not executed by the ONU, the optional attribute mask coding remains 0, while the attribute execution mask coding becomes 1 for each <i>failed</i> attribute.</p> <p>If the ONU could not latch copies of all specified table attributes, e.g., because of insufficient memory, the attribute execution mask is set to 1 for each attribute that does <i>not</i> have a latched copy available for get next retrieval.</p>

When the result-reason code in a response message indicates an exception (i.e., its value is not 0), the response message is permitted to include vendor-specific additional information. The rules for additional error information are as follows.

1. Additional error information is optional for the ONU to insert.
2. Additional information may or may not be represented in textual form.
3. The semantics of additional error information are specific to the ONU vendor.
4. The ONU must not rely on the OLT being able to detect or interpret additional error information.
5. Additional error information may occupy only padding bytes (baseline message set) or only uncommitted trailing bytes (extended message set).
6. In get, get current data and get next responses, the attribute mask controls the padding definition.
7. No additional error information is permitted in responses to start download and end download messages that are directed to multiple target MEs, as indicated by 0xFFFF in the target ME identifier.

These rules are defined with a view to maximizing the simplicity of an implementation.

A.1.2 Table attributes

Normal attributes are coded such that they do not exceed the maximum OMCI attribute size, as limited by the baseline message format. However, there are cases where attributes need to be larger because they comprise arrays of data. In other cases, the attribute may be unstructured, but nevertheless be too large to be represented as a conventional attribute. Both types of large attributes are known as tables, and can be identified by the word *table* in their names.

A table entry may be short enough that more than one row would fit into a (baseline) set command. However, the set command has no deterministic way to specify how many such rows are present. Therefore, the set action is permitted to set only a single entry in the table, the size of which is specified in clause 9 for the particular attribute in question.

The set operation on a table row is possible only when individual table entries have a fixed size that does not exceed the maximum that can be conveyed in the (baseline) set message. A table attribute with variable-length rows or longer fixed-length rows is restricted to being read-only.

NOTE 1 – Future managed entity definitions may relax the attribute size restrictions if baseline message set compatibility is not required. This is a matter for further study.

An optional set table command is defined in the extended message set. Functionally, the set table command is the equivalent of an ordered sequence of set commands, each directed to the same table attribute of a given managed entity. As with the set command, table rows must have a fixed length, and because of the backward compatibility requirement, no table row may exceed the baseline length limit.

The actual size of any given table attribute instance at any given time may be smaller than the OMCI single-message limit. Regardless of its actual size, however, the following sequence governs the retrieval of all table attributes.

Figure A.1.2-1 shows how the OLT retrieves a table attribute. The OLT sends a get command, just as for any other attribute. The ONU latches a copy of the table for the anticipated get next sequence. In the get response, the ONU returns, not the value of the table attribute, but a 4 byte field containing the table's size, expressed in bytes.

NOTE 2 – Zero is a valid size for many table attributes.

The OLT then requests the attribute data from the ONU via the appropriate number of get next commands. There is no structure in the get next response; it simply regards the table as a byte string.

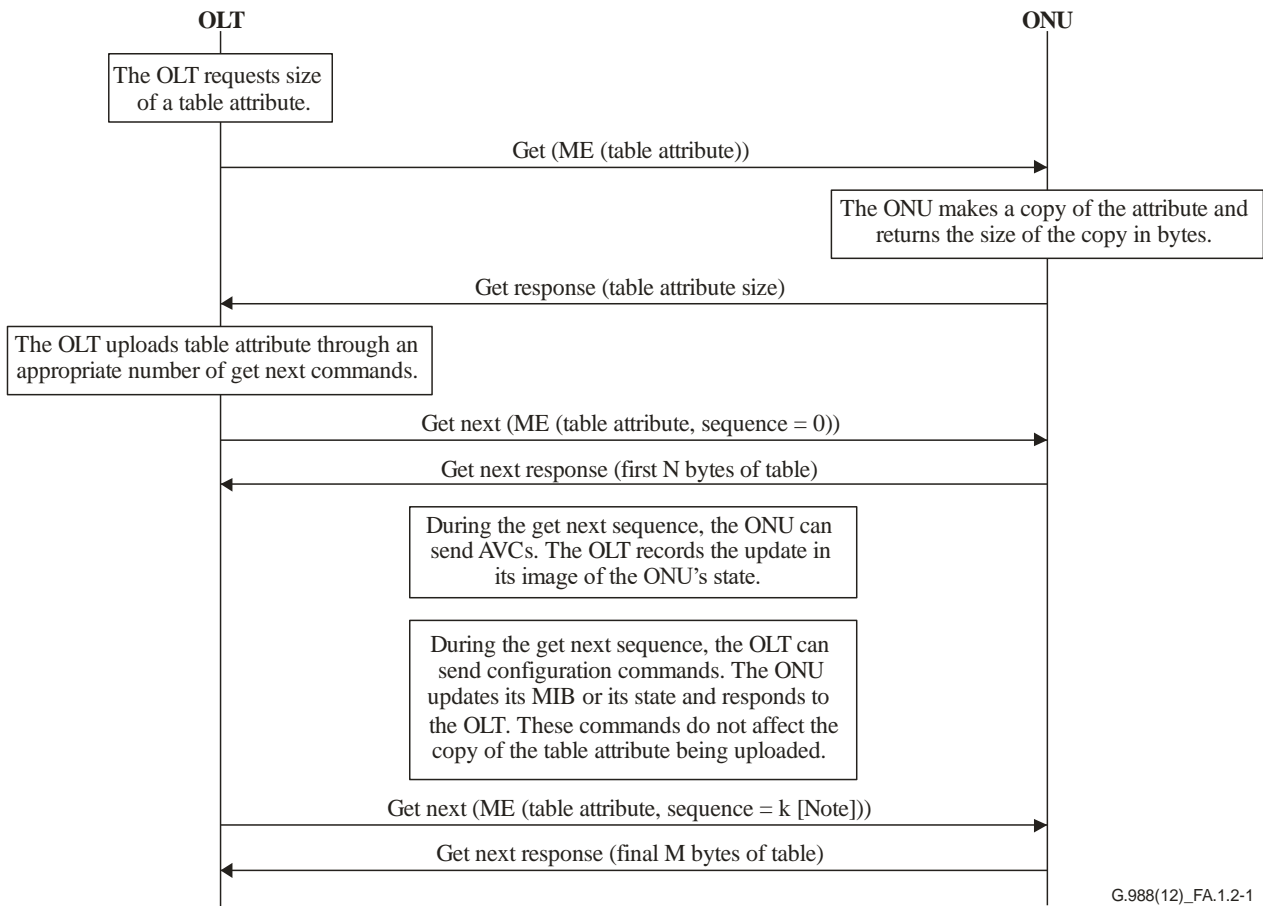

G.988(12)_FA.1.2-1

NOTE –The number of get next commands, $k + 1$, is derived by the OLT to retrieve the complete table. For baseline OMCI messages, each get next response contains 29 bytes; for extended OMCI messages, up to 1966 bytes (1980 maximum PDU size – 14 bytes of OMCI header) are returned in a full-length response.

Figure A.1.2-1 – Get a table attribute

The OLT issues as many get next requests as are needed to accommodate the size of the table attribute. As illustrated in Figure A.1.2-2, the ONU returns a parameter error response if the OLT overruns the size of the table attribute copy.

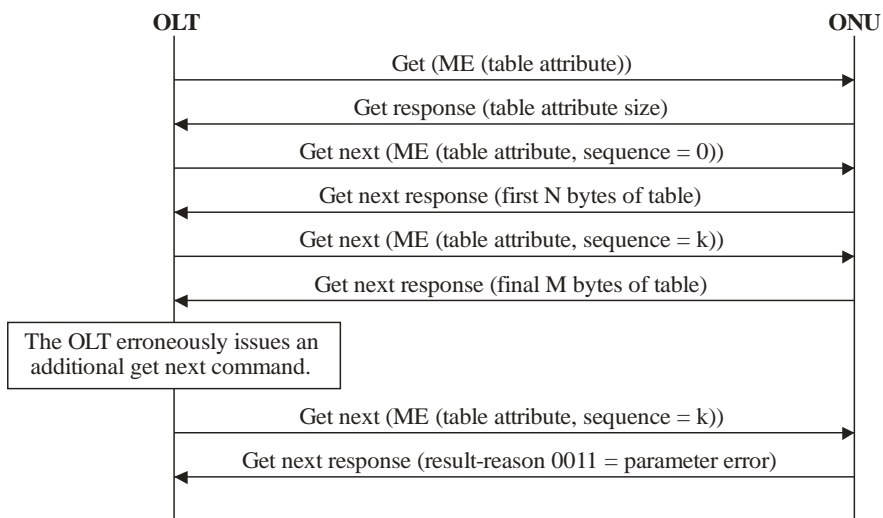

G.988(12)_FA.1.2-2

Figure A.1.2-2 – OLT overruns table attribute size

The maximum time between two get next requests is 60 s. If the OLT does not send a get next request within 60 s of the previous get next request or after the initial get request, the ONU assumes the get attribute transaction has terminated, discards its copy of the table attribute, and denies further get next requests directed to that attribute, again with a parameter error result-reason code.

Capturing snapshots of multiple large tables could exhaust the limited memory resources of the ONU. Within any one ONU, the OLT should get and get-next only one table attribute at a time. If more than one table attribute is selected in the get command attribute mask, the ONU may reject the command with an attributes failed or unknown result-reason code.

If more than one bit is set in the get-next command attribute mask or if the specified attribute is not a table, the ONU should respond with a parameter error result code.

In each get next command, the OLT generates a sequence number, starting from 0. The sequence number resets to 0 for each attribute, even if successive attributes are part of the same ME parent.

A.1.3 Get, get response, create response and set messages

For an attribute mask, a bit map is used in the get, get response, create response and set messages. This bit map indicates which attributes are requested (get) or provided (get response and set). The bit map is composed as follows.

Byte	Bit							
	8	7	6	5	4	3	2	1
1	Attribute 1	Attribute 2	Attribute 3	Attribute 4	Attribute 5	Attribute 6	Attribute 7	Attribute 8
2	Attribute 9	Attribute 10	Attribute 11	Attribute 12	Attribute 13	Attribute 14	Attribute 15	Attribute 16

Attribute numbers correspond to the ordering of the attributes in clause 9. The ME identifier, which is an attribute of each ME, has no corresponding bit in the attribute mask. Thus, attributes are counted starting from the first attribute after the ME identifier.

A.1.4 Alarm notifications

The ONU sends this notification each time an alarm status changes for the entity indicated in the ME identifier message field. The message shows the status of all alarms of this entity. It is up to the OLT to determine which alarm status has changed. The alarm message also reports declarations and cancellations of PM TCAs.

The maximum number of alarms supported by the OMCI for a given ME instance is 224, because of the available message field of the baseline get all alarm next message. The bit map is composed as follows.

Byte	Bit							
	8	7	6	5	4	3	2	1
1	Alarm 0	Alarm 1	Alarm 2	Alarm 3	Alarm 4	Alarm 5	Alarm 6	Alarm 7
2	Alarm 8	Alarm 9	Alarm 10	Alarm 11	Alarm 12	Alarm 13	Alarm 14	Alarm 15
...								
28	Alarm 216	Alarm 217	Alarm 218	Alarm 219	Alarm 220	Alarm 221	Alarm 222	Alarm 223

Alarm numbers correspond to the alarm coding or threshold coding in clause 9 (no ME class declares both alarms and TCAs). Bits in the alarm bit map that correspond to non-existing alarms are always set to 0. Bits that correspond to defined alarms are set to 0 to indicate that the corresponding alarm is cleared or to 1 to indicate that the alarm is currently active.

Alarm message sequence numbers can take values in the interval 1 to 255. Zero is excluded in order to make this counter similar to the MIB data sync counter.

A.1.4.1 Alarm sequence number increase

The ONU informs the OLT of alarm status changes by sending alarm status change notifications. These notifications are sent in unacknowledged messages that carry an 8 bit alarm sequence number so that the OLT can detect loss of alarm notifications. Use cases are illustrated in Figures A.1.4.1-1 to A.1.4.1-3.

After a restart of the ONU, the alarm sequence number is reset, so that the first alarm notification sent by the ONU will have an alarm sequence number equal to 1. The alarm sequence number is incremented for each alarm notification and wraps around from 255 to 1. No alarm notification ever has the sequence number 0.

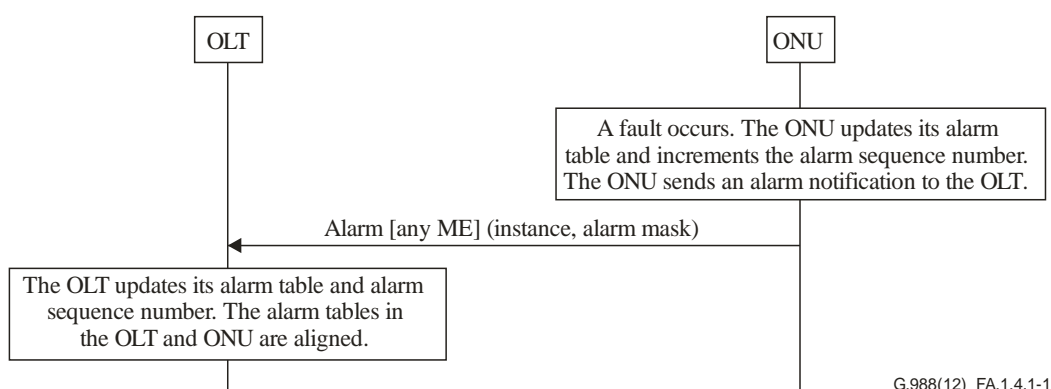

Figure A.1.4.1-1 – Increment of alarm sequence number at the ONU and OLT

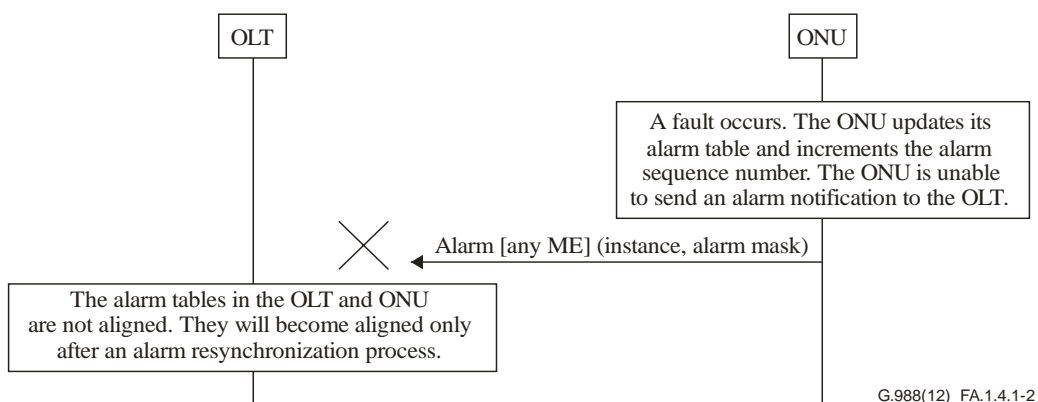

Figure A.1.4.1-2 – Alarm sequence number fails to stay in sync

When alarms are suppressed by ARC (clause A.1.4.3), the alarm is recorded by the ONU, but no alarm message is sent. Therefore, the alarm sequence number is not incremented.

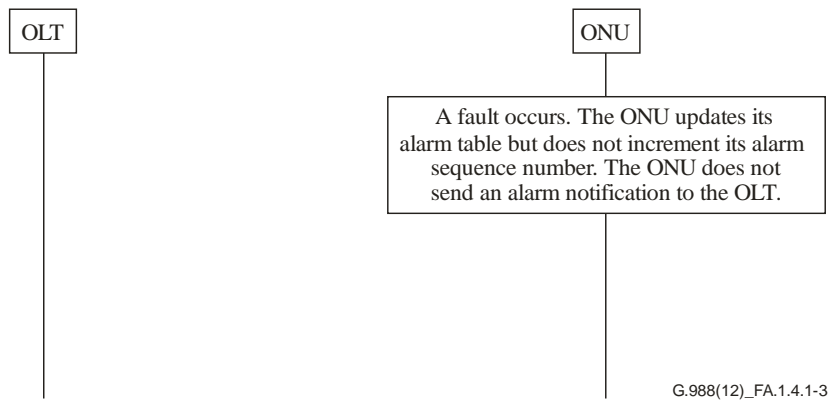

Figure A.1.4.1-3 – No increment of alarm sequence number at the ONU and OLT under ARC

A.1.4.2 Alarm audit and resynchronization

At initialization, periodically or when the OLT detects a gap in the alarm sequence number, it reconciles its view of the ONU's alarm status by sending a get all alarms command targeted at the ONU data ME, as shown in Figure A.1.4.2-1.

When it receives the get all alarms request, the ONU resets the alarm sequence number to zero.

If the OLT sets the alarm retrieval mode indicator in the get all alarms command to 1, the ONU only returns alarms that are not currently under ARC. Otherwise, the ONU returns all alarms regardless of ARC status. In accordance with this request option, the ONU creates a copy of its current alarm status table. ME instances with no reportable alarms are not represented in this copy.

The ONU responds to the OLT with the number of get all alarms next commands required to retrieve the alarm status table copy (baseline message set) or the number of ME instances to be retrieved (extended message set). These are in fact the same value because each baseline message returns the alarm mask from one ME instance. The OLT then uploads the copy via a sequence of get all alarms next commands targeted at the ONU data ME.

During the upload, the ONU is permitted to issue alarm notifications, both to declare and to clear alarms.

When the upload is complete, the OLT compares the received alarm statuses with its own alarm table entries for that ONU, along with any alarm notifications received during the upload process, and notifies the network manager of any changes.

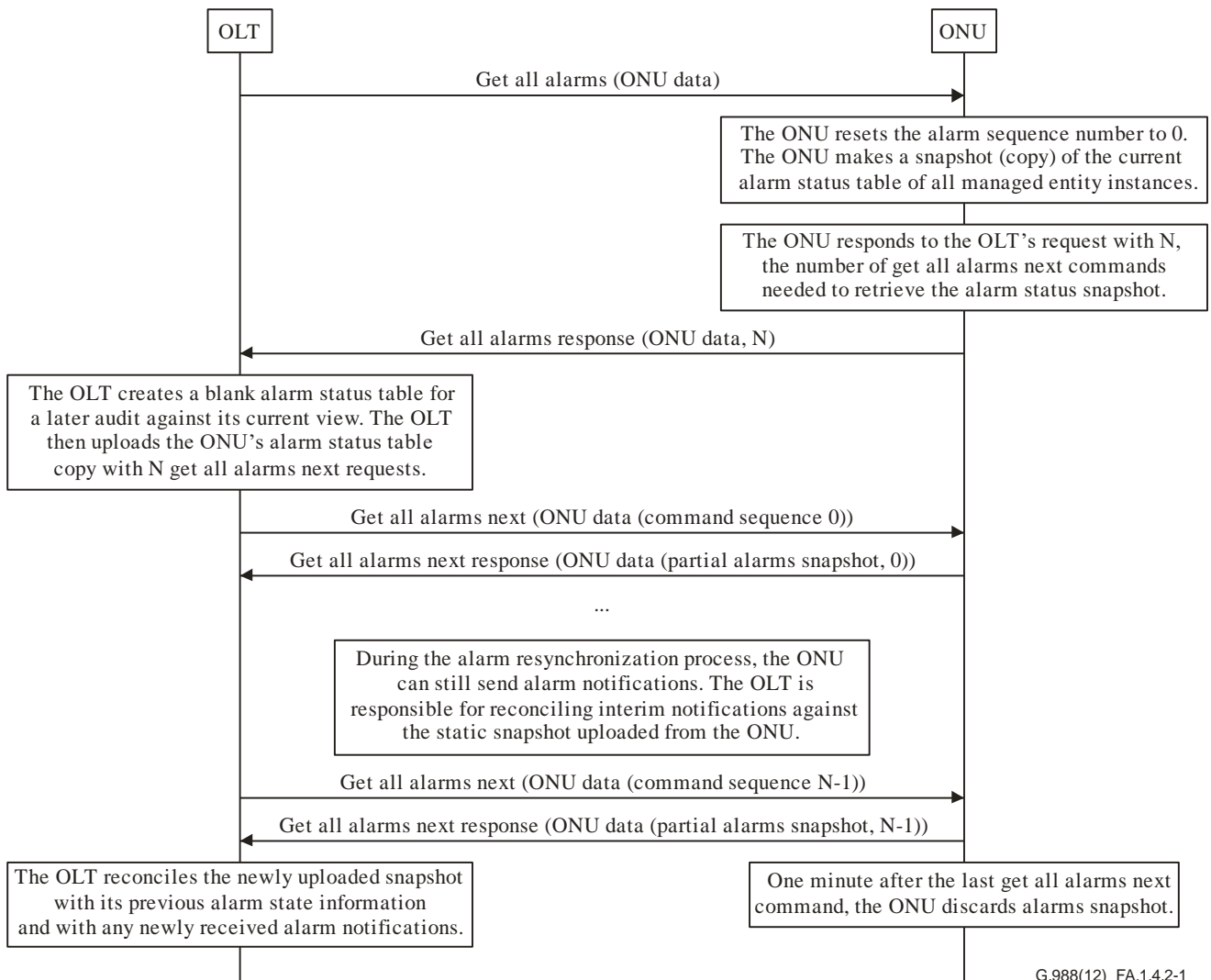

G.988(12)_FA.1.4.2-1

Figure A.1.4.2-1 – Alarm resynchronization

The ONU allows 1 min between two get all alarms next requests. If the OLT does not send a get all alarms next request within this time after the previous get all alarms next request or after the get all alarms request, the ONU assumes the alarm upload to be terminated. It then discards the copy of the alarm table and considers any further get all alarms next requests to be out of range.

A.1.4.3 Alarm-reporting control

ARC allows for the suppression of alarms from PPTPs and cardholders, under the control of the management system. ARC suppresses alarm-reporting on the parent ME and all dependent entities, but does not suppress alarm conditions themselves. Therefore, if an alarm condition develops during an ARC interval, the ONU should maintain the internal indication of the alarm, and if the OLT gets all alarms regardless of ARC, it should be reported.

[ITU-T M.3100] completely describes ARC from a generic viewpoint. The OMCI provides for ARC functions using two attributes of the parent ME: ARC and ARC interval. These two attributes are described below.

Alarm-reporting control

This attribute allows the activation of ARC for this PPTP or cardholder. The attribute works in concert with the ARC interval attribute. The value 0 disables ARC, while the value 1 enables ARC. The default value is disabled. When the ARC attribute is set to disabled, the PPTP or cardholder is in the ITU-T M.3100 ALM state, in which alarms are reported normally. When the ARC attribute is set to

enabled, the PPTP or cardholder is in the ITU-T M.3100 NALM-QI state, in which alarm reporting is suppressed.

The PPTP or cardholder moves from state ALM to state NALM-QI when the OLT changes the ARC attribute to enabled. The PPTP or cardholder moves from the NALM-QI state to the ALM state when either the PPTP or cardholder is trouble-free and the ARC interval timer expires or the ARC attribute is set to disabled by the OLT. Continuation or recurrence of a fault resets the timer. If the ARC interval timer expires, the ONU sets the ARC attribute to disabled autonomously, and sends an AVC to notify the OLT. Refer to [ITU-T M.3100] for a more extensive discussion.

The ARC interval attribute can assume normal timing values of 0 to 254 min. The value 0 implies that a PPTP or cardholder in the NALM-QI state goes immediately to the ALM state upon detection of a problem-free state. An ARC interval value of 255 has the special meaning that the timer never expires. The PPTP or cardholder remains in the NALM-QI state until the OLT sets the ARC attribute to disabled. This behaviour is equivalent to the NALM state, which is another generic behaviour of the ARC function in [ITU-T M.3100].

The OMCI does not support the ITU-T M.3100 NALM-TI sub-function.

ARC interval

This attribute defines the interval to be used with the ARC function for this PPTP or cardholder. The values 0 to 254 give the duration in minutes for the NALM-QI timer of [ITU-T M.3100]. The special value 255 means that the timer never expires. The default value is zero.

A.1.5 Test, test response and test result

This clause describes how test, test response and test result messages are related.

Test: This message is used to initiate either a self-test or any of the specific tests defined against various ME types.

Test response: This message is the ONU's immediate AK of a test message. The test response message reports the ability of the ONU to run the required test, but it does not contain any specific results. A successful test response message implies that a test result message will be forthcoming in due course.

Test result: This autonomous message is used to report the result of a self-test or one of the specific tests defined against various ME types.

A test on a particular ME instance is invoked by sending a test message to this instance. Each ME that supports tests has a test action defined for it. The type of test invoked by a test message depends on the ME type.

Figure A.1.5-1 shows the sequence of events when the OLT requests the ONU to perform a test. The OLT starts the test by sending a test command. The ONU acknowledges this command with a test response. Then the ONU carries out the test. After the test is complete, the ONU reports the test result via an autonomous test result notification.

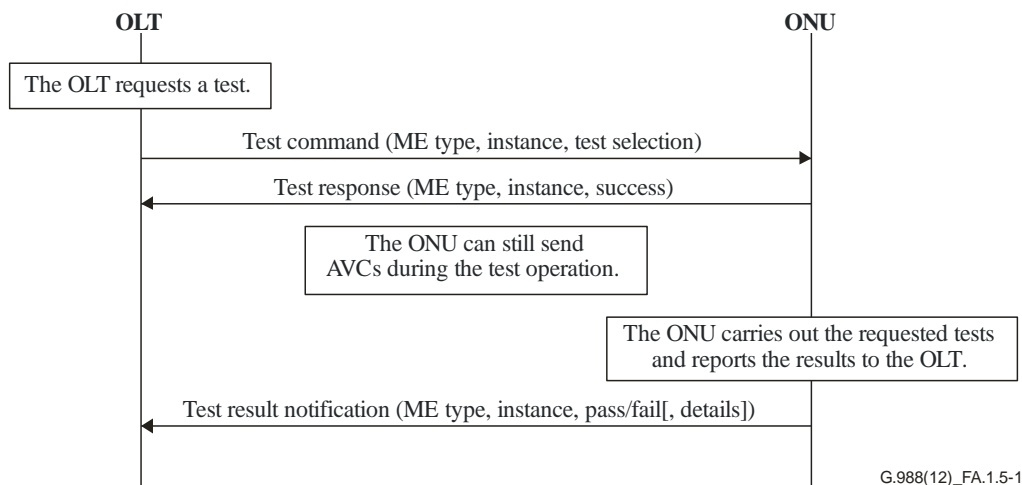

Figure A.1.5-1 – Reporting of test result

If the test was requested by the OLT, the test result notification contains the transaction identifier of the original test command. An ONU may also run continuing diagnostic or monitoring routines, and report failures either through alarms or through autonomous test result messages or both. A test result message from a self-initiated test contains the transaction identifier zero.

A.1.6 Administrative state considerations

The administrative state attribute has two values: 0 (unlock) and 1 (lock).

In the state model of [ITU-T X.731], administrative state represents the intention of management to allow (unlock) or deny (lock) the functionality of an ME. Administrative lock must not inhibit management access to the ME. Though specified by neither [ITU-T X.731] nor [ITU-T X.733], a common side effect of administrative lock is to suppress notifications from the locked entity and any dependent entities. This avoids unnecessary alarms during maintenance and repair, or when a resource is not in use. The OMCI conforms to this convention.

The need for continuing management access implies that, regardless of the administrative state, an ONU must maintain its presence on the PON, and it may also have to provide local craft access, e.g., to enter registration information.

Subject to continuing management access, it is suggested that the ONU itself, any separable circuit packs and all ports should power down as much as possible when the administrative state is locked. It is further suggested that the default value for administrative state be locked. This reduces power consumption in cases such as pre-installation of ONUs and unsubscribed or unused ports.

Operators may have additional requirements that override power-down or that override the suggested lock default.

NOTE – When an ITU-T G.987 ONU enters initial state, as defined in [ITU-T G.987.3], it may set administrative lock on the ONU-G ME, thereby preventing all user traffic from flowing until the OLT unlocks the ONU-G. Although this is optional behaviour on the part of the ONU, the OLT is advised to check the state of this attribute when bringing an ONU into service.

A.2 Extended message set

The extended OMCI message set may be used by G-PON systems after initial start-up on the baseline message set.

Extended OMCI messages may be up to 1980 bytes long, including headers.

A.2.1 Create

The contents of the create message apply only to attributes that are defined to be set-by-create. Writeable attributes that are not set-by-create are not permitted in a create message. Thus, the first byte of the message contents field begins with the value of the first set-by-create attribute and so forth. Space for each set-by-create attribute must be allocated in the create message, even if the attribute is optional. When an optional attribute is not to be instantiated, the placeholder value to be entered into this space is specific to the definition of each attribute. If the ONU does not support a given optional set-by-create attribute, the ONU should simply ignore that field in the create message, and the ONU should not set an illegal value flag in the create message response.

When the OMCI specifies a default value for a set-by-create attribute, the intention is that the OLT populate the default recommendation into the create message. The ONU is not responsible for instantiating any particular value for a set-by-create attribute.

Field	Byte	8	7	6	5	4	3	2	1	Comments
Transaction correlation identifier	1-2									
Message type	3	0	1	0						DB = 0, AR = 1, AK = 0 bits 5-1: action = create
Device identifier	4	0	0	0	0	1	0	1	1	Extended OMCI = 0x0B
Managed entity identifier	5-6									Entity class
	7-8									Entity instance
Message contents length	9-10									Size of message contents field, bytes
Message contents	11-n									Value of first set-by-create attribute, NOT the ME ID (size depending on the type of attribute)
										...
										Value of last set-by-create attribute
MIC										Message integrity check, 4 bytes

A.2.2 Create response

Field	Byte	8	7	6	5	4	3	2	1	Comments
Transaction correlation identifier	1-2									
Message type	3	0	0	1						DB = 0, AR = 0, AK = 1 bits 5-1: action = create
Device identifier	4	0	0	0	0	1	0	1	1	Extended OMCI = 0x0B
Managed entity identifier	5-6									Entity class
	7-8									Entity instance
Message contents length	9-10									Size of message contents field = 3 bytes

Field	Byte	8	7	6	5	4	3	2	1	Comments
Message contents	11	0	0	0	0	x	x	x	x	Result, reason 0000 command processed successfully 0001 command processing error 0010 command not supported 0011 parameter error 0100 unknown managed entity 0101 unknown managed entity instance 0110 device busy 0111 instance exists
	12-13									Attribute execution mask, used when result, reason = 0011 0 attribute ok 1 illegal attribute value
MIC	14-17									Message integrity check
NOTE – If the result, reason code is not 0011, the attribute execution mask in bytes 12-13 is omitted.										

A.2.3 Delete

Field	Byte	8	7	6	5	4	3	2	1	Comments
Transaction correlation identifier	1-2									
Message type	3	0	1	0						DB = 0, AR = 1, AK = 0 bits 5-1: action = delete
Device identifier	4	0	0	0	0	1	0	1	1	Extended OMCI = 0x0B
Managed entity identifier	5-6									Entity class
	7-8									Entity instance
Message contents length	9-10									Size of message contents field = 0
MIC	11-14									Message integrity check

A.2.4 Delete response

Field	Byte	8	7	6	5	4	3	2	1	Comments
Transaction correlation identifier	1-2									
Message type	3	0	0	1						DB = 0, AR = 0, AK = 1 bits 5-1: action = delete
Device identifier	4	0	0	0	0	1	0	1	1	Extended OMCI = 0x0B
Managed entity identifier	5-6									Entity class
	7-8									Entity instance
Message contents length	9-10									Size of message contents field = 1 byte

Field	Byte	8	7	6	5	4	3	2	1	Comments
Message contents	11									Result, reason 0000 command processed successfully 0001 command processing error 0010 command not supported 0011 parameter error 0100 unknown managed entity 0101 unknown managed entity instance 0110 device busy
MIC	12-15									Message integrity check

A.2.5 Set

As well as simple attributes, the set command may be used to set rows of tables. If it is used for this purpose, however, one set command must set exactly one row of the table, because there is no way to enumerate or separate multiple table entries. The set table command is available to set more than one row with a single command.

Field	Byte	8	7	6	5	4	3	2	1	Comments
Transaction correlation identifier	1-2									
Message type	3	0	1	0						DB = 0, AR = 1, AK = 0 bits 5-1: action = set
Device identifier	4	0	0	0	0	1	0	1	1	Extended OMCI = 0x0B
Managed entity identifier	5-6									Entity class
	7-8									Entity instance
Message contents length	9-10									Size of message contents field, bytes
Message contents	11-12									Attribute mask
	13- <i>n</i>									Value of first attribute to set (size depending on the type of attribute)
										...
										Value of last attribute to set
MIC										Message integrity check, 4 bytes

A.2.6 Set response

Field	Byte	8	7	6	5	4	3	2	1	Comments
Transaction correlation identifier	1-2									
Message type	3	0	0	1						DB = 0, AR = 0, AK = 1 bits 5-1: action = set
Device identifier	4	0	0	0	0	1	0	1	1	Extended OMCI = 0x0B
Managed entity identifier	5-6									Entity class
	7-8									Entity instance

Field	Byte	8	7	6	5	4	3	2	1	Comments
Message contents length	9-10									Size of message contents field, bytes
Message contents	11	0	0	0	0	x	x	x	x	Result, reason 0000 command processed successfully 0001 command processing error 0010 command not supported 0011 parameter error 0100 unknown managed entity 0101 unknown managed entity instance 0110 device busy 1001 attribute(s) failed or unknown
	12-13									Optional-attribute mask, used with 1001 encoding: 0 default 1 unsupported attribute
	14-15									Attribute execution mask, used with 1001 encoding: 0 default 1 failed attribute
MIC										Message integrity check, 4 bytes
NOTE – The attribute masks in bytes 12-15 are present if, and only if, the result-reason code is 1001.										

A.2.7 Get

Field	Byte	8	7	6	5	4	3	2	1	Comments
Transaction correlation identifier	1-2									
Message type	3	0	1	0						DB = 0, AR = 1, AK = 0 bits 5-1: action = get
Device identifier	4	0	0	0	0	1	0	1	1	Extended OMCI = 0x0B
Managed entity identifier	5-6									Entity class
	7-8									Entity instance
Message contents length	9-10									Size of message contents field = 2 bytes
Message contents	11-12									Attribute mask
MIC	13-16									Message integrity check

A.2.8 Get response

Bytes 14-17 are always reserved for the optional-attribute and attribute execution masks; however, the contents of these bytes are only valid in conjunction with result code 1001 used to indicate failed or unknown attributes. When the result code is not 1001, these bytes should be set to 0 by the ONU transmitter and ignored by the OLT receiver.

When the OLT wishes to retrieve a table attribute, i.e., an attribute whose size is, or might be, larger than the space available in one OMCI baseline message, the ONU indicates the size of that attribute in bytes, rather than its value. The size is conveyed as 4 bytes in the value field for that attribute, with the attribute execution mask set to indicate that the attribute is included. The OLT should then use a

sequence of get next messages to retrieve such an attribute. This convention also pertains to extended OMCI messages, even though some table attributes might fit into an extended get response message.

Field	Byte	8	7	6	5	4	3	2	1	Comments
Transaction correlation identifier	1-2									
Message type	3	0	0	1						DB = 0, AR = 0, AK = 1 bits 5-1: action = get
Device identifier	4	0	0	0	0	1	0	1	1	Extended OMCI = 0x0B
Managed entity identifier	5-6									Entity class
	7-8									Entity instance
Message contents length	9-10									Size of message contents field, bytes
Message contents	11	0	0	0	0	x	x	x	x	Result, reason 0000 command processed successfully 0001 command processing error 0010 command not supported 0011 parameter error 0100 unknown managed entity 0101 unknown managed entity instance 0110 device busy 1001 attribute(s) failed or unknown
	12-13									Attribute mask
	14-15									Optional-attribute mask, used with 1001 encoding: 0 default 1 unsupported attribute
	16-17									Attribute execution mask, used with 1001 encoding: 0 default 1 failed attribute
	18-n									Value of first attribute included (size depending on the type of attribute)
										...
										Value of last attribute included
MIC										Message integrity check, 4 bytes

A.2.9 Get all alarms

Field	Byte	8	7	6	5	4	3	2	1	Comments
Transaction correlation identifier	1-2									
Message type	3	0	1	0						DB = 0, AR = 1, AK = 0 bits 5-1: action = get all alarms
Device identifier	4	0	0	0	0	1	0	1	1	Extended OMCI = 0x0B
	5-6									Entity class = ONU data

Field	Byte	8	7	6	5	4	3	2	1	Comments
Managed entity identifier	7-8									Entity instance
Message contents length	9-10									Size of message contents field = 1 byte
Message contents	11	0	0	0	0	0	0	0	x	x = alarm retrieval mode 0 Get all alarms regardless of ARC status 1 Get all alarms not currently under ARC
MIC	12-15									Message integrity check

A.2.10 Get all alarms response

Field	Byte	8	7	6	5	4	3	2	1	Comments
Transaction correlation identifier	1-2									
Message type	3	0	0	1						DB = 0, AR = 0, AK = 1 bits 5-1: action = get all alarms
Device identifier	4	0	0	0	0	1	0	1	1	Extended OMCI = 0x0B
Managed entity identifier	5-6									Entity class = ONU data
	7-8									Entity instance
Message contents length	9-10									Size of message contents field = 2 bytes
Message contents	11-12									Number of ME instances to be retrieved
MIC	13-16									Message integrity check

A.2.11 Get all alarms next

Command sequence numbers start from 0.

Field	Byte	8	7	6	5	4	3	2	1	Comments
Transaction correlation identifier	1-2									
Message type	3	0	1	0						DB = 0, AR = 1, AK = 0 bits 5-1: action = get all alarms next
Device identifier	4	0	0	0	0	1	0	1	1	Extended OMCI = 0x0B
Managed entity identifier	5-6									Entity class = ONU data
	7-8									Entity instance
Message contents length	9-10									Size of message contents field = 2 bytes
Message contents	11-12									Command sequence number
MIC	13-16									Message integrity check

A.2.12 Get all alarms next response

Note that alarm bit maps for a number of MEs may be returned within a single message.

The bit map used in the get all alarms next response for a given ME class is identical to the bit map used in the alarm notification for that ME class.

If the ONU receives a get all alarms next request message whose command sequence number is out of range, the get all alarms next response message should contain a null message contents field.

Field	Byte	8	7	6	5	4	3	2	1	Comments
Transaction correlation identifier	1-2									
Message type	3	0	0	1						DB = 0, AR = 0, AK = 1 bits 5-1: action = get all alarms next
Device identifier	4	0	0	0	0	1	0	1	1	Extended OMCI = 0x0B
Managed entity identifier	5-6									Entity class = ONU data
	7-8									Entity instance
Message contents length	9-10									Size of message contents field including all sub-parts, bytes
Message contents 1	11-12									Entity class whose alarms are reported
	13-14									Entity instance whose alarms are reported
	15-42	x	x	x	x	x	x	x	x	Bit map alarms
Message contents 2 (as needed)	43-44									Entity class whose alarms are reported
	45-46									Entity instance whose alarms are reported
	47-74	x	x	x	x	x	x	x	x	Bit map alarms
...										Further managed entity alarm maps as needed
Message contents n										
MIC										Message integrity check, 4 bytes

A.2.13 MIB upload

Field	Byte	8	7	6	5	4	3	2	1	Comments
Transaction correlation identifier	1-2									
Message type	3	0	1	0						DB = 0, AR = 1, AK = 0 bits 5-1: action = MIB upload
Device identifier	4	0	0	0	0	1	0	1	1	Extended OMCI = 0x0B
Managed entity identifier	5-6									Entity class = ONU data
	7-8									Entity instance
Message contents length	9-10									Size of message contents field = 0
MIC	11-14									Message integrity check

A.2.14 MIB upload response

Field	Byte	8	7	6	5	4	3	2	1	Comments
Transaction correlation identifier	1-2									

Field	Byte	8	7	6	5	4	3	2	1	Comments
Message type	3	0	0	1						DB = 0, AR = 0, AK = 1 bits 5-1: action = MIB upload
Device identifier	4	0	0	0	0	1	0	1	1	Extended OMCI = 0x0B
Managed entity identifier	5-6									Entity class = ONU data
	7-8									Entity instance
Message contents length	9-10									Size of message contents field = 2 bytes
Message contents	11-12									Number of MIB upload next commands required
MIC	13-16									Message integrity check

A.2.15 MIB upload next

Field	Byte	8	7	6	5	4	3	2	1	Comments
Transaction correlation identifier	1-2									
Message type	3	0	1	0						DB = 0, AR = 1, AK = 0 bits 5-1: action = MIB upload next
Device identifier	4	0	0	0	0	1	0	1	1	Extended OMCI = 0x0B
Managed entity identifier	5-6									Entity class = ONU data
	7-8									Entity instance
Message contents length	9-10									Size of message contents field = 2 bytes
Message contents	11-12									Command sequence number
MIC	13-16									Message integrity check

Command sequence numbers start from 0.

A.2.16 MIB upload next response

Note that, if not all attributes of a ME fit within one MIB upload next response message, the attributes are split over several messages. The OLT can use the information in the attribute mask to determine which attribute values are reported in which MIB upload next response message.

Thus, a single extended MIB upload next response message must contain an integer number of attribute values. A message may contain leading or trailing fragments of ME instance reports and any number of complete ME instance reports.

If the ONU receives an MIB upload next request message whose command sequence number is out of range, it should respond with a message containing no message contents field. This is also the appropriate response if the ONU times out (one minute) from the most recent MIB upload next or MIB upload request from the OLT.

Field	Byte	8	7	6	5	4	3	2	1	Comments
Transaction correlation identifier	1-2									
Message type	3	0	0	1						DB = 0, AR = 0, AK = 1 bits 5-1: action = MIB upload next
Device identifier	4	0	0	0	0	1	0	1	1	Extended OMCI = 0x0B

Field	Byte	8	7	6	5	4	3	2	1	Comments
Managed entity identifier	5-6									Entity class = ONU data
	7-8									Entity instance
Message contents length	9-10									Size of message contents field including all sub-fields, bytes
Message contents, ME instance 1	11-12									Size of ME instance 1 attribute values included (excluding bytes 11-18), bytes
	13-14									Entity class of ME instance 1
	15-16									Entity instance
	17-18									Attribute mask
	19-n									Value of first attribute (size depending on the type of the attribute)
										...
										Value of last attribute
Message contents, ME instance 2										Content of ME instance 2, defined as above.
...										...
Message contents, ME instance k										Content of ME instance k, defined as above.
MIC										Message integrity check, 4 bytes

A.2.17 MIB reset

Field	Byte	8	7	6	5	4	3	2	1	Comments
Transaction correlation identifier	1-2									
Message type	3	0	1	0						DB = 0, AR = 1, AK = 0 bits 5-1: action = MIB reset
Device identifier	4	0	0	0	0	1	0	1	1	Extended OMCI = 0x0B
Managed entity identifier	5-6									Entity class = ONU data
	7-8									Entity instance
Message contents length	9-10									Size of message contents field = 0
MIC	11-14									Message integrity check

A.2.18 MIB reset response

Field	Byte	8	7	6	5	4	3	2	1	Comments
Transaction correlation identifier	1-2									
Message type	3	0	0	1						DB = 0, AR = 0, AK = 1 bits 5-1: action = MIB reset
Device identifier	4	0	0	0	0	1	0	1	1	Extended OMCI = 0x0B
Managed entity identifier	5-6									Entity class = <u>ONU</u> data
	7-8									Entity instance

Field	Byte	8	7	6	5	4	3	2	1	Comments
Message contents length	9-10									Size of message contents field = 1 byte
Message contents	11	0	0	0	0	x	x	x	x	Result, reason 0000 command processed successfully 0001 command processing error 0010 command not supported 0011 parameter error 0100 unknown managed entity 0101 unknown managed entity instance 0110 device busy
MIC	12-15									Message integrity check

A.2.19 Alarm

Field	Byte	8	7	6	5	4	3	2	1	Comments
Transaction correlation identifier	1-2									
Message type	3	0	0	0						DB = 0, AR = 0, AK = 0 bits 5-1: action = alarm
Device identifier	4	0	0	0	0	1	0	1	1	Extended OMCI = 0x0B
Managed entity identifier	5-6									Entity class
	7-8									Entity instance
Message contents length	9-10									Size of message contents field = 29 bytes
Message contents	11-38									Alarm bit map
	39									Alarm sequence number
MIC	40-43									Message integrity check

A.2.20 Attribute value change

Field	Byte	8	7	6	5	4	3	2	1	Comments
Transaction correlation identifier	1-2									
Message type	3	0	0	0						DB = 0, AR = 0, AK = 0 bits 5-1: action = attribute value change
Device identifier	4	0	0	0	0	1	0	1	1	Extended OMCI = 0x0B
Managed entity identifier	5-6									Entity class
	7-8									Entity instance
Message contents length	9-10									Size of message contents field, bytes
Message contents	11-12									Attribute mask
	13-n									Value of first changed attribute (size depending on the type of attribute)
										...

Field	Byte	8	7	6	5	4	3	2	1	Comments
										Value of last changed attribute
MIC										Message integrity check, 4 bytes
NOTE – The AVC message for a table attribute does not contain an attribute value, only a mask, and the ONU does not create a snapshot of the table. If the OLT wishes to obtain the new value, it must do a get operation, followed by the required number of get next operations.										

A.2.21 Test

The format of the test message is specific to the target entity class. Several formats are defined. Future test extensions for a given entity class can be supported by adding additional encodings to presently unused bits or bytes. Future specification of tests for other entity classes may use an existing format or may define new formats for the test message. These extension mechanisms allow future tests to be supported without changing the principle of operation.

A.2.21.1 Format for ONU-G, ANI-G, RE ANI-G, PPTP RE UNI, RE upstream amplifier, RE downstream amplifier and circuit pack entity classes

Field	Byte	8	7	6	5	4	3	2	1	Comments
Transaction correlation identifier	1-2									
Message type	3	0	1	0						DB = 0, AR = 1, AK = 0 bits 5-1: action = test
Device identifier	4	0	0	0	0	1	0	1	1	Extended OMCI = 0x0B
Managed entity identifier	5-6									Entity class NOTE – This format applies to entity classes ONU-G, ANI-G, RE ANI-G, PPTP RE UNI, RE upstream amplifier, RE downstream amplifier and circuit pack.
	7-8									Entity instance
Message contents length	9-10									Size of message contents field
Message contents	11	0	0	0	0	x	x	x	x	xxxx = select test 0000..0110 Reserved for future use 0111 Self-test 1000..1111 Vendor-specific use. See description related to the test result message.
	12-13									Pointer to a general purpose buffer ME, used to return vendor-specific test results. This field is optional. The OLT may include this field, or in case it is not used, set it to zero. If the following field is not used or not supported, the OLT may omit both fields. The ONU should accept either option, ignoring the field if it does not support the feature.

Field	Byte	8	7	6	5	4	3	2	1	Comments
	14-15									Pointer to an octet string ME, used to define the vendor-specific test parameters. This field is optional. The OLT may include this field, or in case it is not used, omit it or set it to zero. The ONU should accept either option, ignoring the field if it does not support the feature.
MIC										Message integrity check

A.2.21.2 Format for IP host config data and IPv6 host config data entity classes

Field	Byte	8	7	6	5	4	3	2	1	Comments
Transaction correlation identifier	1-2									
Message type	3	0	1	0						DB = 0, AR = 1, AK = 0 Bits 5-1: action = test
Device identifier	4	0	0	0	0	1	0	1	1	Extended OMCI = 0x0B
Managed entity identifier	5-6									Entity class NOTE – This format applies to entity classes IP host config data and IPv6 host config data.
	7-8									Entity instance
Message contents length	9-10									Size of message contents field – 5 bytes (IPv4 address) or 17 bytes (IPv6 address)
Message contents	11	0	0	0	0	x	x	x	x	xxxx = select test 0001 Ping 0010 Traceroute 0011 Extended ping 0100..0111 Reserved 1000..1111 Vendor-specific use. The ICMP message is intended to be sent from the ONU upstream towards the network. See discussion related to the test result message.
	12-15									Option 1: IPv4 address of target (zero if byte 11 specifies extended ping test)
	12-27									Option 2: IPv6 address of target (zero if byte 11 specifies extended ping test)
	28									Number of times to ping. This field pertains to both explicit and extended ping tests. The value 0 or the absence of this field selects the ONU's internal default.
	29-30									Pointer to large string ME that identifies the target via a DNS-parsable string. This field is used only for the extended ping test.

Field	Byte	8	7	6	5	4	3	2	1	Comments
MIC										Message integrity check

A.2.21.3 Format for PPTP POTS UNI entity class

The test message for POTS UNIs supports two basic categories of test operation, a defined set of tests that look in and out from the POTS port, and a set of code points that may be used for vendor-specific tests. The latter category is further subdivided into code points that return test results in a general purpose buffer ME, using the test result message primarily as an event trigger to signal test completion, and code points that return all test results in an ordinary test result message. If it is needed, the OLT must create the general purpose buffer ME before initiating the test action.

Note that a single message can be used to initiate multiple tests on a given ME if desired.

Bytes 12-25 are used by the dial tone make-break test. A zero value for a timer causes the ONU to use its built-in defaults. As many as three dial tone frequencies can be specified, or omitted by setting their values to 0. Other fields are also omitted with the value 0, or controlled by flags. An ONU can support the dial tone test with internal defaults only, and is not required to support any of the attributes of bytes 12-25. Likewise, an ONU can use internal defaults for a drop test, rather than the values given in bytes 26-35. The capabilities of an ONU are documented by the vendor and known through administrative practices.

Several distinct test classes are defined.

Field	Byte	8	7	6	5	4	3	2	1	Comments
Transaction correlation identifier	1-2									
Message type	3	0	1	0						DB = 0, AR = 1, AK = 0 Bits 5-1: action = test
Device identifier	4	0	0	0	0	1	0	1	1	Extended OMCI = 0x0B
Managed entity identifier	5-6									Entity class NOTE – This format applies to entity class PPTP POTS UNI.
	7-8									Entity instance
Message contents length	9-10									Size of message contents field
Message contents	11	x	0	t	t	x	x	x	x	tt selects one of the POTS test class formats 0 MLT, dial tone make-break 1 SIP/ITU-T H.248 test call 2..3 Reserved x Bits reserved for use in specific test classes as defined below

Test class 0:

Field	Byte	8	7	6	5	4	3	2	1	Comments
Message contents	11	a	0	0	0	x	x	x	x	<p>a – test mode</p> <p>0 normal; deny test if line busy</p> <p>1 forced mode</p> <p>xxxx = select test</p> <p>0000 all MLTs</p> <p>0001 hazardous potential</p> <p>0010 foreign EMF</p> <p>0011 resistive faults</p> <p>0100 receiver off-hook</p> <p>0101 ringer</p> <p>0110 NT1 dc signature test</p> <p>0111 self-test</p> <p>1000 dial tone make-break test</p> <p>1001..1011 vendor-specific test, all results returned in test results message</p> <p>1100..1111 vendor-specific test, test results returned in general purpose buffer ME. The ONU should deny a test operation command in this range if bytes 36..37 do not point to a GP buffer.</p>
	12									Draw-break dial tone (DBDT) timer T1 (slow dial tone threshold), in units of 0.1 s. Range 0.1 to 6.0 s.
	13									DBDT timer T2 (no dial tone threshold), in units of 0.1 s. Range 1.0 to 10.0 s.
	14									DBDT timer T3 (slow break dial tone threshold), in units of 0.1 s. Range 0.1 to 3.0 s.
	15									DBDT timer T4 (no break dial tone threshold), in units of 0.1 s. Range 1.0 to 3.0 s.
	16							d	p	<p>DBDT control byte</p> <p>d: dialled digit</p> <p>1 dialled digit specified in byte 17</p> <p>0 use default digit</p> <p>p = pulse (1) or tone (0) dialling</p>
	17									Digit to be dialled, ASCII character in range "0"-"9", "*", "#".
	18-19									Dial tone frequency 1, in hertz
	20-21									Dial tone frequency 2, in hertz. 0 = unused (i.e., if only one tone is specified).

Field	Byte	8	7	6	5	4	3	2	1	Comments
	22-23									Dial tone frequency 3, in hertz. 0 = unused (i.e., if only one or two tones are specified).
	24									Dial tone power threshold, absolute value, 0.1 dB resolution, range [-]0.1 to [-]25.3 dBm0. E.g., -13 dBm0 = 0x82. 0 = unspecified.
	25									Idle channel power threshold, absolute value, 1 dB resolution, range [-]1 to [-]90 dBm0. 0 = unspecified.
	26									DC hazardous voltage threshold, absolute value, volts. 0 = unspecified.
	27									AC hazardous voltage threshold, volts RMS. 0 = unspecified.
	28									DC foreign voltage threshold, absolute value, volts. 0 = unspecified.
	29									AC foreign voltage threshold, volts RMS. 0 = unspecified.
	30									Tip-ground and ring-ground resistance threshold, kilohms 0 = unspecified.
	31									Tip-ring resistance threshold, kilohms. 0 = unspecified.
	32-33									Ringer equivalence minimum threshold, in 0.01 REN (ringer equivalent number) units. 0 = unspecified.
	34-35									Ringer equivalence maximum threshold, in 0.01 REN units. 0 = unspecified.
	36-37									Pointer to a general purpose buffer ME, used to return vendor-specific test results.
	38-39									Pointer to an octet string ME, used to define vendor-specific test parameters. This field is optional. The OLT may include this field, or in case it is not used, omit it or set it to zero. The ONU should accept either option, ignoring the field if it does not support the feature.
MIC										Message integrity check

Test class 1:

Field	Byte	8	7	6	5	4	3	2	1	Comments
Message contents	11	a	0	0	1	x	x	x	x	a – test mode 0 normal; deny test if line busy 1 forced mode x Reserved
	12-27									ASCII string containing the number to be dialed. Trailing unused octets are padded with null bytes.
MIC	28-31									Message integrity check

A.2.21.4 Format for dot1ag MEP entity class, loopback test

Field	Byte	8	7	6	5	4	3	2	1	Comments
Transaction correlation identifier	1-2									
Message type	3	0	1	0						DB = 0, AR = 1, AK = 0 Bits 5-1: action = test
Device identifier	4	0	0	0	0	1	0	1	1	Extended OMCI = 0x0B
Managed entity identifier	5-6									Entity class. NOTE – This format applies to the dot1ag MEP entity class
	7-8									Entity instance
Message contents length	9-10									Size of message contents field = 20 bytes
Message contents	11	0	0	0	0	0	0	0	x	x = select test 0: Ethernet loopback test 1: IEEE 802.1ag linktrace test (see separate format description below) Other values reserved
	12	0	0	0	c	p	p	p	d	If c = 1, the value of the MEP's CCM and LTM priority attribute is used, with drop eligibility false. If c = 0, pppd represents the priority (P bits) and drop eligibility fields of the transmitted LBM frame.
	13-18									MAC address of target MHF or MEP, or 0 if the destination MEP ID is to be used instead. [IEEE 802.1ag] specifies unicast addresses; [ITU-T Y.1731] also allows for multicast.
	19-20									Destination MEP ID, in the range 1..8191, or 0 if the MAC address in bytes 13..18 is to be used instead.

Field	Byte	8	7	6	5	4	3	2	1	Comments
	21-22									Repetition count, range 1..1024. This governs how many LBMs are generated. The rate at which LBMs are generated is not specified. If 5 seconds elapses with no LBRs received, the test aborts.
	23-24									These four fields are pointers to as many as 4 octet string MEs, which are concatenated to form an octet string of up to 1500 bytes. The string is packaged into a data TLV and transmitted as part of the LBM. If all four fields are null pointers, no data TLV is sent. If only one octet string is needed, it should be specified in bytes 23..24, etc., with null pointers in the higher-numbered bytes of the test message.
	25-26									
	27-28									
	29-30									
MIC	31-33									Message integrity check

A.2.21.5 Format for dot1ag MEP entity class, linktrace test

Field	Byte	8	7	6	5	4	3	2	1	Comments
Transaction correlation identifier	1-2									
Message type	3	0	1	0						DB = 0, AR = 1, AK = 0 Bits 5-1: action = test
Device identifier	4	0	0	0	0	1	0	1	1	Extended OMCI = 0x0B
Managed entity identifier	5-6									Entity class. NOTE – This format applies to the dot1ag MEP entity class
	7-8									Entity instance
Message contents length	9-10									Size of message contents field = 13 bytes
Message contents	11	0	0	0	0	0	0	0	x	x = select test 0: Ethernet loopback test (see separate format description above) 1: IEEE 802.1ag linktrace test Other values reserved
	12	f	0	0	0	0	0	0	0	Flags, a bit map f: <i>Use FDB only</i> . When 1, the bridge uses only its normal MAC forwarding tables for forwarding. When 0, the bridge may also consult its MIP CCM database to determine the forwarding port.
	13-18									Unicast MAC address of target MHF or MEP, or 0 if the destination MEP ID is to be used instead.

Field	Byte	8	7	6	5	4	3	2	1	Comments
	19-20									Destination MEP ID, in the range 1..8191, or 0 if the unicast MAC address in bytes 13..18 is to be used instead.
	21									Max hops count – specifies initial time to live (TTL); limits the number of relay stages through which the LTM is forwarded before being discarded, and the number of LTRs that may be returned. [IEEE 802.1ag] recommends a default value of 64.
	22-23									Pointer to a general purpose buffer ME, used to return the linktrace results. The ONU should deny the test operation command if this field is a null or an invalid pointer.
MIC	24-27									Message integrity check

A.2.22 Test response

If an ONU does not support all tests requested in byte 11 of the test request message, it should not execute any test and should respond with result 0010, command not supported. If an ONU supports all of the requested tests but cannot support one or more of the explicitly specified threshold attributes, it should not execute any test and should respond with result 0011, parameter error. The test command could then be re-issued with different thresholds or with default thresholds, and would be expected to succeed.

The test response message is an indication to the OLT that the test request is received and is being processed. Test outcome is reported by a subsequent autonomous test result message.

Field	Byte	8	7	6	5	4	3	2	1	Comments
Transaction correlation identifier	1-2									
Message type	3	0	0	1						DB = 0, AR = 0, AK = 1 bits 5-1: action = test
Device identifier	4	0	0	0	0	1	0	1	1	Extended OMCI = 0x0B
Managed entity identifier	5-6									Entity class
	7-8									Entity instance
Message contents length	9-10									Size of message contents field = 1 byte
Message contents	11	0	0	0	0	x	x	x	x	Result, reason 0000 command processed successfully 0001 command processing error 0010 command not supported 0011 parameter error 0100 unknown managed entity 0101 unknown managed entity instance 0110 device busy
MIC	12-15									Message integrity check

A.2.23 Start software download

When a file is to be downloaded to a single instance of the software image ME, the target ME ID is specified in bytes 7..8. An optional feature permits the same file to be downloaded to a number of circuit packs by setting bytes 7..8 = 0xFFFF and specifying the software image ME IDs in bytes 17-18, 19-20, etc.

Field	Byte	8	7	6	5	4	3	2	1	Comments
Transaction correlation identifier	1-2									
Message type	3	0	1	0						DB = 0, AR = 1, AK = 0 bits 5-1: action = start software download
Device identifier	4	0	0	0	0	1	0	1	1	Extended OMCI = 0x0B
Managed entity identifier	5-6									Entity class = software image
	7									MS byte of software image instance 0 ONU-G 1..254 slot number 255 download to multiple software image managed entities
	8									LS byte of software image instance 0 instance 0 1 instance 1 2..254 vendor-specific use 255 multiple download
Message contents length	9-10									Size of message contents field, bytes
Message contents	11									Window size – 1
	12-15									Image size in bytes
	16									Number of circuit packs to be updated in parallel (value 1..9)
	17-18									ME ID of software image entity instance (first byte: slot number; second byte: instance 0..1 or 2..254 vendor-specific)
	19-20, etc.									Additional software image ME IDs (same format as bytes 17..18) for additional simultaneous downloads.
MIC										Message integrity check, 4 bytes

A.2.24 Start software download response

When a file is downloaded to a single software image ME, the response contains the target ME ID in bytes 7..8, a result code in byte 11, and a window size counter-proposal (which may be the same as that suggested by the OLT in the original request) in byte 12. Bytes 13..N are omitted.

An ONU that supports the optional parallel download feature responds to a multiple download command with the full format shown below, where unused trailing image references may be omitted. If the ONU does not support the parallel download feature, it responds with result code 0b0101, unknown ME instance.

Field	Byte	8	7	6	5	4	3	2	1	Comments
Transaction correlation identifier	1-2									
Message type	3	0	0	1						DB = 0, AR = 0, AK = 1 bits 5-1: action = start software download
Device identifier	4	0	0	0	0	1	0	1	1	Extended OMCI = 0x0B
Managed entity identifier	5-6									Entity class = software image
	7									MS byte of software image instance 0 ONU-G 1..254 slot number 255 download to multiple software image managed entities
	8									LS byte of software image instance 0 instance 0 1 instance 1 2..254 vendor-specific use 255 multiple download
Message contents length	9-10									Size of message contents field, bytes
Message contents	11	0	0	0	0	x	x	x	x	Result, reason 0000 command processed successfully 0001 command processing error 0010 command not supported 0011 parameter error 0100 unknown managed entity 0101 unknown managed entity instance 0110 device busy
	12									Window size – 1
	13									Number of instances responding (value 0..9)
	14-15									ME ID of software image entity instance (first byte: slot number; second byte: instance 0..1 or 2..254 vendor-specific)
	16									Result, reason for bytes 14..15 – same coding as byte 11
	17-n									Repeat coding of bytes 14..16 for additional requested software image instances.
MIC										Message integrity check, 4 bytes

A.2.25 Download section

Field	Byte	8	7	6	5	4	3	2	1	Comments
Transaction correlation identifier	1-2									
Message type	3	0	x	0						DB = 0, AR = x, AK = 0 x = 0 no response expected (section within a window) x = 1 response expected (last section of a window) bits 5-1: action = sw download section
Device identifier	4	0	0	0	0	1	0	1	1	Extended OMCI = 0x0B
Managed entity identifier	5-6									Entity class = software image
	7									MS byte of software image instance 0 ONU-G 1..254 slot number 255 download to multiple software image managed entities
	8									LS byte of software image instance 0 instance 0 1 instance 1 2..254 vendor-specific use 255 multiple download
Message contents length	9-10									Size of message contents field, bytes
Message contents	11									Download section number
	12-n									Software image data
MIC										Message integrity check, 4 bytes

A.2.26 Download section response

Field	Byte	8	7	6	5	4	3	2	1	Comments
Transaction correlation identifier	1-2									
Message type	3	0	0	1						DB = 0, AR = 0, AK = 1 bits 5-1: action = sw download section
Device identifier	4	0	0	0	0	1	0	1	1	Extended OMCI = 0x0B
Managed entity identifier	5-6									Entity class = software image
	7									MS byte of software image instance 0 ONU-G 1..254 slot number 255 download to multiple software image managed entities

Field	Byte	8	7	6	5	4	3	2	1	Comments
	8									LS byte of software image instance 0 instance 0 1 instance 1 2..254 vendor-specific use 255 multiple download
Message contents length	9-10									Size of message contents field = 2
Message contents	11	0	0	0	0	x	x	x	x	Result, reason 0000 command processed successfully 0001 command processing error 0010 command not supported 0011 parameter error 0100 unknown managed entity 0101 unknown managed entity instance 0110 device busy
	12									Download section number
MIC	13-16									Message integrity check

A.2.27 End software download

The format of this command is similar to that of the start software download message. Bytes 19..n support the optional parallel download feature, and are omitted for download to a single target.

Field	Byte	8	7	6	5	4	3	2	1	Comments
Transaction correlation identifier	1-2									
Message type	3	0	1	0						DB = 0, AR = 1, AK = 0 bits 5-1: action = end software download
Device identifier	4	0	0	0	0	1	0	1	1	Extended OMCI = 0x0B
Managed entity identifier	5-6									Entity class = software image
	7									MS byte of software image instance 0 ONU-G 1..254 slot number 255 download to multiple software image managed entities
	8									LS byte of software image instance 0 instance 0 1 instance 1 2..254 vendor-specific use 255 multiple download
Message contents length	9-10									Size of message contents field, bytes

Field	Byte	8	7	6	5	4	3	2	1	Comments
Message contents	11-14									CRC-32, computed over all bytes of the software image (excluding padding), as specified in [ITU-T I.363.5].
	15-18									Image size in bytes
	19									Number of parallel download instances sent in this message (value 1..9)
	20-21									ME ID of software image entity instance (first byte: slot number; second byte: instance 0..1 or 2..254 vendor-specific)
	22-23, etc.									Software image ME IDs (same format as bytes 20..21) for additional simultaneous downloads.
MIC										Message integrity check, 4 bytes

A.2.28 End software download response

The response message informs the OLT whether the download command was successful. If a single software image ME was targeted for download, byte 11 reports the result of the process, and bytes 12..N are omitted. If a number of software images were targeted for parallel download, byte 11 reports device busy as long as any of the instances is busy writing the image to a non-volatile store. Once the ONU has stored all images successfully, it responds to continued end software download commands with a 0 in byte 11 and a separate result for each software image ME. Unused trailing instance references may be omitted.

Field	Byte	8	7	6	5	4	3	2	1	Comments
Transaction correlation identifier	1-2									
Message type	3	0	0	1						DB = 0, AR = 0, AK = 1 bits 5-1: action = end software download
Device identifier	4	0	0	0	0	1	0	1	1	Extended OMCI = 0x0B
Managed entity identifier	5-6									Entity class = software image
	7									MS byte of software image instance 0 ONU-G 1..254 slot number 255 download to multiple software image managed entities
	8									LS byte of software image instance 0 instance 0 1 instance 1 2..254 vendor-specific use 255 multiple download
Message contents length	9-10									Size of message contents field, bytes

Field	Byte	8	7	6	5	4	3	2	1	Comments
Message contents	11	0	0	0	0	x	x	x	x	Result, reason 0000 command processed successfully (CRC correct) 0001 command processing error (CRC incorrect, in addition to the normal criteria) 0100 unknown managed entity 0101 unknown managed entity instance 0110 device busy
	12									Number of instances responding (value 0..9)
	13-14									ME ID of software image entity instance (first byte: slot number; second byte: instance 0..1 or 2..254 vendor-specific)
	15									Result, reason for bytes 13..14 – same coding as byte 11
	16-n									Repeat coding of bytes 13..15 for additional software image instances.
MIC										Message integrity check, 4 bytes

A.2.29 Activate image

Field	Byte	8	7	6	5	4	3	2	1	Comments
Transaction correlation identifier	1-2									
Message type	3	0	1	0						DB = 0, AR = 1, AK = 0 bits 5-1: action = activate image
Device identifier	4	0	0	0	0	1	0	1	1	Extended OMCI = 0x0B
Managed entity identifier	5-6									Entity class = software image
	7									MS byte entity instance 0 ONU-G 1..254 slot number
	8	0	0	0	0	0	0	0	x	LS byte entity instance 0 first instance 1 second instance 2..254 vendor-specific use
Message contents length	9-10									Size of message contents field

Field	Byte	8	7	6	5	4	3	2	1	Comments
Flags (Note 1)	11	0	0	0	0	0	0	F	F	Bits FF: 00 Activate image unconditionally 01 Activate image only if no POTS/VoIP calls are in progress 10 Activate image only if no emergency call is in progress (Note 2) 11 Reserved If the ONU denies the activate image command because of the FF field, it returns result, reason code 0110, device busy.
MIC										Message integrity check
NOTE 1 – The Flags byte is optional. If it is absent, the activate image command is to be executed unconditionally. NOTE 2 – The ONU determines the presence of an originating emergency call on the basis of the Emergency service number attribute of the VoIP feature access codes ME. Other ways for the ONU to determine the presence of an emergency call are for further study.										

A.2.30 Activate image response

Field	Byte	8	7	6	5	4	3	2	1	Comments
Transaction correlation identifier	1-2									
Message type	3	0	0	1						DB = 0, AR = 0, AK = 1 bits 5-1: action = activate image
Device identifier	4	0	0	0	0	1	0	1	1	Extended OMCI = 0x0B
Managed entity identifier	5-6									Entity class = software image
	7									MS byte entity instance 0 ONU-G 1..254 slot number
	8	0	0	0	0	0	0	0	x	LS byte entity instance 0 first instance 1 second instance 2..254 vendor-specific use
Message contents length	9-10									Size of message contents field = 1 byte
Message contents	11	0	0	0	0	x	x	x	x	Result, reason 0000 command processed successfully 0001 command processing error 0010 command not supported 0011 parameter error 0100 unknown managed entity 0101 unknown managed entity instance 0110 device busy
MIC	12-15									Message integrity check

A.2.31 Commit image

Field	Byte	8	7	6	5	4	3	2	1	Comments
Transaction correlation identifier	1-2									
Message type	3	0	1	0						DB = 0, AR = 1, AK = 0 bits 5-1: action = commit image
Device identifier	4	0	0	0	0	1	0	1	1	Extended OMCI = 0x0B
Managed entity identifier	5-6									Entity class = software image
	7									MS byte entity instance 0 ONU-G 1..254 slot number
	8	0	0	0	0	0	0	0	x	LS byte entity instance 0 first instance 1 second instance 2..254 vendor-specific use
Message contents length	9-10									Size of message contents field = 0
MIC	11-14									Message integrity check

A.2.32 Commit image response

Field	Byte	8	7	6	5	4	3	2	1	Comments
Transaction correlation identifier	1-2									
Message type	3	0	0	1						DB = 0, AR = 0, AK = 1 bits 5-1: action = commit image
Device identifier	4	0	0	0	0	1	0	1	1	Extended OMCI = 0x0B
Managed entity identifier	5-6									Entity class = software image
	7									MS byte entity instance 0 ONU-G 1..254 slot number
	8	0	0	0	0	0	0	0	x	LS byte entity instance 0 first instance 1 second instance 2..254 vendor-specific use
Message contents length	9-10									Size of message contents field = 1 byte
Message contents	11	0	0	0	0	x	x	x	x	Result, reason 0000 command processed successfully 0001 command processing error 0010 command not supported 0011 parameter error 0100 unknown managed entity 0101 unknown managed entity instance 0110 device busy

Field	Byte	8	7	6	5	4	3	2	1	Comments
MIC	12-15									Message integrity check

A.2.33 Synchronize time

The synchronize time command controls the tick boundary for PM collection, and optionally, a date and time clock.

If this message specifies the time (and optionally the date), the ONU sets its PM interval counter to a current offset from the most recent quarter-hour boundary, i.e., to a value in the range 0..899 s. This may cause the current PM collection interval to be longer or shorter than 900 s. Date and time are not explicitly required in an ONU, but if the ONU has a real-time clock, it is also set by this message. If the OLT does not wish to specify a date, it may set year, month and day fields to 0. If the ONU does not support the setting of the date, it will use the success result info field in the synchronize time response message to indicate that only the 15 min tick boundary was set.

If date and time are not present in the message, the ONU sets its PM interval counter to 0. This may cause the current PM collection interval to be shorter than 900 s. The effect on a possible ONU real-time clock is not specified.

There is no intention that this message be used to establish a precise time of day reference.

Field	Byte	8	7	6	5	4	3	2	1	Comments
Transaction correlation identifier	1-2									
Message type	3	0	1	0						DB = 0, AR = 1, AK = 0 bits 5-1: action = synchronize time
Device identifier	4	0	0	0	0	1	0	1	1	Extended OMCI = 0x0B
Managed entity identifier	5-6									Entity class = ONU-G
	7-8									Entity instance = 0
Message contents length	9-10									Size of message contents field, bytes
Message contents	11-12									Year, e.g., 2009
	13									Month, range 1..12
	14									Day of month, range 1..31
	15									Hour of day, range 0..23
	16									Minute of hour, range 0..59
	17									Second of minute, range 0..59
MIC										Message integrity check, 4 bytes

A.2.34 Synchronize time response

Field	Byte	8	7	6	5	4	3	2	1	Comments
Transaction correlation identifier	1-2									
Message type	3	0	0	1						DB = 0, AR = 0, AK = 1 Bits 5-1: action = synchronize time
Device identifier	4	0	0	0	0	1	0	1	1	Extended OMCI = 0x0B
Managed entity identifier	5-6									Entity class = ONU-G
	7-8									Entity instance = 0

Field	Byte	8	7	6	5	4	3	2	1	Comments
Message contents length	9-10									Size of message contents field
Message contents	11	x	x	x	x	r	r	r	R	Result, reason 0000 command processed successfully 0001 command processing error 0010 command not supported 0011 parameter error 0100 unknown managed entity 0101 unknown managed entity instance 0110 device busy
	12	x	x	x	x	r	r	r	r	x: reserved rrrr: Success result info 0000 15 min tick boundary set successfully 0001 Date and 15 min tick boundary set successfully This byte is present and meaningful only when the result, reason code in byte 11 is 0000. Byte 12 is optional and is treated as described in clause 11.2.5.
MIC										Message integrity check

A.2.35 Reboot

Field	Byte	8	7	6	5	4	3	2	1	Comments
Transaction correlation identifier	1-2									
Message type	3	0	1	0						DB = 0, AR = 1, AK = 0 bits 5-1: action = reboot
Device identifier	4	0	0	0	0	1	0	1	1	Extended OMCI = 0x0B
Managed entity identifier	5-6									Entity class
	7-8									Entity instance
Message contents length	9-10									Size of message contents field
Flags (Note 1)	11	0	0	0	0	0	0	F	F	Bits FF: 00 Reboot unconditionally 01 Reboot only if no POTS/VoIP calls are in progress 10 Reboot only if no emergency call is in progress (Note 2) 11 Reserved If the ONU denies the reboot command because of the FF field, it returns result, reason code 0110, device busy.

Field	Byte	8	7	6	5	4	3	2	1	Comments
MIC										Message integrity check
NOTE 1 – The Flags byte is optional. If it is absent, the activate image command is to be executed unconditionally.										
NOTE 2 – The ONU determines the presence of an originating emergency call on the basis of the Emergency service number attribute of the VoIP feature access codes ME. Other ways for the ONU to determine the presence of an emergency call are for further study.										

A.2.36 Reboot response

Field	Byte	8	7	6	5	4	3	2	1	Comments
Transaction correlation identifier	1-2									
Message type	3	0	0	1						DB = 0, AR = 0, AK = 1 bits 5-1: action = reboot
Device identifier	4	0	0	0	0	1	0	1	1	Extended OMCI = 0x0B
Managed entity identifier	5-6									Entity class
	7-8									Entity instance
Message contents length	9-10									Size of message contents field = 1 byte
Message contents	11									Result, reason 0000 command processed successfully 0001 command processing error 0010 command not supported 0011 parameter error 0100 unknown managed entity 0101 unknown managed entity instance 0110 device busy
MIC	12-15									Message integrity check

A.2.37 Get next

The ONU should reject a get next command:

- if the attribute mask specifies more than one attribute (result code 0011);
- if the attribute mask specifies an attribute that is not a table (result code 0011);
- if the specified attribute has not been prepared for upload with a prior get command (the prior get is subject to 1 min timeout) (result code 0001).

Command sequence numbers start from 0.

Field	Byte	8	7	6	5	4	3	2	1	Comments
Transaction correlation identifier	1-2									
Message type	3	0	1	0						DB = 0, AR = 1, AK = 0 bits 5-1: action = get next
Device identifier	4	0	0	0	0	1	0	1	1	Extended OMCI = 0x0B
	5-6									Entity class

Field	Byte	8	7	6	5	4	3	2	1	Comments
Managed entity identifier	7-8									Entity instance
Message contents length	9-10									Size of message contents field = 4 bytes
Message contents	11-12									Attribute mask
	13-14									Command sequence number
MIC	15-18									Message integrity check

A.2.38 Get next response

If the ONU receives a get next request message whose command sequence number is out of range, the ONU responds with parameter error.

Field	Byte	8	7	6	5	4	3	2	1	Comments
Transaction correlation identifier	1-2									
Message type	3	0	0	1						DB = 0, AR = 0, AK = 1 bits 5-1: action = get next
Device identifier	4	0	0	0	0	1	0	1	1	Extended OMCI = 0x0B
Managed entity identifier	5-6									Entity class
	7-8									Entity instance
Message contents length	9-10									Size of message contents field, bytes
Message contents	11	0	0	0	0	x	x	x	x	Result, reason 0000 command processed successfully 0001 command processing error 0010 command not supported 0011 parameter error 0100 unknown managed entity 0101 unknown managed entity instance 0110 device busy
	12-13									Attribute mask
	14-n									Value of the specified attribute (size depending on the type of attribute, limited by message capacity)
MIC										Message integrity check, 4 bytes

A.2.39 Test result

The test result message reports the outcome of a test. In the case of a requested test, the transaction identifier of the test result message is identical to the transaction identifier of the test message that initiated the corresponding test. In the case of a self-triggered test result, the transaction identifier is set to 0.

Several formats are currently defined. They are used as follows:

- self-test results, ONU-G, circuit pack, or any other ME that supports self-test;

- vendor-specific test results, generic format, any ME that supports it;
- POTS test results, either an MLT, dial tone draw-break or vendor-specific POTS tests that use a general purpose buffer;
- ICMP tests, either ping or traceroute;
- the results of an optical line supervision test on the ANI-G, RE ANI-G, PPTP RE UNI, RE upstream amplifier or RE downstream amplifier;
- [IEEE 802.1ag] loopback and linktrace tests.

If a new test for the currently supported entities is defined in the future, the corresponding test results can be reported by extending the test result message layout. If a new test for other ME classes is defined in the future, a new test result message layout may be defined.

A.2.39.1 Format for self-test action invoked against ONU-G and circuit pack entity classes

Field	Byte	8	7	6	5	4	3	2	1	Comments
Transaction correlation identifier	1-2									
Message type	3	0	0	0						DB = 0, AR = 0, AK = 0 bits 5-1: action = test result
Device identifier	4	0	0	0	0	1	0	1	1	Extended OMCI = 0x0B
Managed entity identifier	5-6									Entity class NOTE – This message format pertains to ONU-G and circuit pack entity classes.
	7-8									Entity instance
Message contents length	9-10									Size of message contents field
Message contents	11	0	0	0	0	0	0	0	0	Reserved
	12	0	0	0	0	0	0	x	x	xx: self-test result 00 failed 01 passed 10 not completed
	13-14									Pointer to a general purpose buffer ME. Valid only for vendor-specific tests that require a GP buffer. This field is optional. The ONU may include this field, or in case it is not used, omit it or set it to zero. The OLT should accept either option.
MIC										Message integrity check

A.2.39.2 Format for vendor-specific test actions invoked against ONU-G and circuit pack entity classes

This format is also used for vendor-specific test actions invoked against the PPTP POTS UNI entity class when no general purpose buffer is needed.

Field	Byte	8	7	6	5	4	3	2	1	Comments
Transaction correlation identifier	1-2									

Field	Byte	8	7	6	5	4	3	2	1	Comments
Message type	3	0	0	0						DB = 0, AR = 0, AK = 0 bits 5-1: action = test result
Device identifier	4	0	0	0	0	1	0	1	1	Extended OMCI = 0x0B
Managed entity identifier	5-6									Entity class NOTE – This message format pertains to ONU-G, circuit pack and PPTP POTS UNI entity classes.
	7-8									Entity instance
Message contents length	9-10									Size of message contents field, bytes
Message contents	11									Type 1 (Note)
	12-13									Value 1
	14									Type 2
	15-16									Value 2
	17									Type 3
	18-19									Value 3
	20									Type 4
	21-22									Value 4
	23									Type 5
	24-25									Value 5
	26									Type 6
27-28									Value 6	
	29									Type 7
	30-31									Value 7
	32									Type 8
	33-34									Value 8
	35									Type 9
	36-37									Value 9
	38									Type 10
	39-40									Value 10
MIC										Message integrity check

NOTE – Test result types are specified in clause 11.2.10. Type-value fields are packed in the lowest byte positions. Unused trailing byte positions may be omitted. If more than 10 type-value pairs are to be returned, an additional test type should be defined in the test message. At the vendor's discretion, a test result may include an ordered sequence of repeated type-value pairs to represent, for example, port ordering, or first/second power input. In this case, missing values can be flagged with type = 255.

A.2.39.3 Format for POTS UNI entity class

In this format, byte 11 reports a summary MLT result. The result for each test category is limited to the two values *pass test* or *test not run* or *failed test*. Byte 13 reports the results of a dial tone test.

Byte 12 reports the result of a self-test or a vendor-specific test that returns results in a general purpose buffer. At present, self-test is not supported for the POTS UNI entity class, and this byte should be set to 0.

There are four possible outcomes for a given test: it can pass, fail, not be run, or not be recognized by the ONU. If an ONU does not support or recognize a given test, it is expected to deny the test request message. To avoid physical damage, an ONU may cease testing if a test fails – usually the hazardous potential test – and thus some subsequent tests will not be run. In addition, the ONU may support some but not all tests of a given suite, such as power measurements in the dial tone test sequence. The category summary in byte 11 includes two values. The value 1 indicates either that all tests in a category passed, or that nothing in the category was tested, while 0 indicates that at least one test in the category failed. Further information appears in flags specific to each test results attribute to indicate whether each detailed test was run or not, whether it passed or failed and whether a measured result is reported or not.

Several distinct test classes are defined.

Field	Byte	8	7	6	5	4	3	2	1	Comments
Transaction correlation identifier	1-2									
Message type	3	0	0	0						DB = 0, AR = 0, AK = 0 bits 5-1: action = test result
Device identifier	4	0	0	0	0	1	0	1	1	Extended OMCI = 0x0B
Managed entity identifier	5-6									Entity class NOTE – This message format pertains to the PPTP POTS UNI entity class.
	7-8									Entity instance
Message contents length	9-10									Size of message contents field
Message contents	11	t	t	x	x	x	x	x	x	tt selects one of the POTS test class formats 0 MLT, dial tone make-break 1 SIP/ITU-T H.248 test call 2..3 Reserved x Bits reserved for use in specific test classes as defined below

Test class 0:

Message contents	11	0	0	a	b	c	d	e	f	MLT drop test result: 0 fail test a/b/c/d/e/f 1 pass test, or test not run a hazardous potential b foreign EMF c resistive faults d receiver off-hook e ringer f NT1 dc signature test
	12	0	0	0	0	0	0	x	x	xx: Result of self-test or vendor-specific test 00 failed 01 passed 10 not completed

	13			b	b	b	d	d	d	<p>Dial tone make-break flags:</p> <p>ddd – Dial tone draw</p> <p>000 test not run</p> <p>01m failed, could not draw</p> <p>10m slow draw</p> <p>11m passed</p> <p>bbb – Dial tone break</p> <p>000 test not run</p> <p>01m failed, could not break</p> <p>10m slow break</p> <p>11m passed</p> <p>m – measured value flag</p> <p>0 measurement not reported</p> <p>1 measurement reported</p>
	14			a	a	a	b	b	b	<p>Dial tone power flags (Note)</p> <p>aaa – Quiet channel power</p> <p>bbb – Dial tone power</p>
	15			a	a	a	b	b	b	<p>Loop test DC voltage flags (Note)</p> <p>aaa – VDC, tip-ground</p> <p>bbb – VDC, ring-ground</p>
	16			a	a	a	b	b	b	<p>Loop test AC voltage flags (Note)</p> <p>aaa – VAC, tip-ground</p> <p>bbb – VAC, ring-ground</p>
	17			a	a	a	b	b	b	<p>Loop test resistance flags 1 (Note)</p> <p>aaa – Resistance, tip-ground</p> <p>bbb – Resistance, ring-ground</p>
	18			a	a	a	b	b	b	<p>Loop test resistance flags 2 (Note)</p> <p>aaa – Resistance, tip-ring</p> <p>bbb – Ringer load test</p>
	19									<p>Time to draw dial tone, in 0.1 s units.</p> <p>Valid only if byte 13 ddd = xx1.</p>
	20									<p>Time to break dial tone, in 0.1 s units.</p> <p>Valid only if byte 13 bbb = xx1.</p>
	21									<p>Total dial tone power measurement, unsigned absolute value, 0.1 dB resolution, range 0 to [–] 25.5 dBm0. Values above 0 dBm0 are reported as 0. Valid only if byte 14 bbb = xx1.</p>
	22									<p>Quiet channel power measurement, unsigned absolute value, 1 dB resolution, range 0 to [–]90 dBm0. Valid only if byte 14 aaa = xx1.</p>
	23-24									<p>Tip-ground DC voltage, 2s complement, resolution 1 V. Valid only if byte 15 aaa = xx1.</p>
	25-26									<p>Ring-ground DC voltage, 2s complement, resolution 1 V. Valid only if byte 15 bbb = xx1.</p>
	27									<p>Tip-ground AC voltage, V_{rms}. Valid only if byte 16 aaa = xx1.</p>

	28									Ring-ground AC voltage, Vrms. Valid only if byte 16 bbb = xx1.
	29-30									Tip-ground DC resistance, kilohms. Infinite resistance: 0xFFFF. Valid only if byte 17 aaa = xx1.
	31-32									Ring-ground DC resistance, kilohms. Infinite resistance: 0xFFFF. Valid only if byte 17 bbb = xx1.
	33-34									Tip-ring DC resistance, kilohms. Infinite resistance: 0xFFFF. Valid only if byte 18 aaa = xx1.
	35									Ringer equivalence, in 0.1 REN units. Valid only if byte 18 bbb = xx1.
	36-37									Pointer to a general purpose buffer ME. Valid only for vendor-specific tests that require a GP buffer.
	38			a	a	a	b	b	b	Loop tip-ring test AC/DC voltage flags. Bytes 38-41 are optional as a group. The ONU may include or omit them as a group. The OLT should accept either option in accordance with clause 11.2.5. aaa – VAC, tip-ring bbb – VDC, tip-ring (Note)
	39									Tip-ring AC voltage, Vrms. Valid only if byte 38 aaa = xx1.
	40-41									Tip-ring DC voltage, 2s complement, resolution 1 V. Valid only if byte 38 bbb = xx1.
MIC										Message integrity check
<p>NOTE – Coding for 3 bit flag sets is as follows:</p> <p>000 test not run</p> <p>010 fail, measurement not reported</p> <p>011 fail, measurement reported</p> <p>110 pass, measurement not reported</p> <p>111 pass, measurement reported.</p>										

Test class 1:

Field	Byte	8	7	6	5	4	3	2	1	Comments
Message contents (Note)	11	0	0	0	1	x	y	y	y	yyy report the results of the test 000 Test failed 001 Test passed 010 Not completed, line off hook 011 Not completed, other reason 100 Reserved 101 Reserved 110 Reserved 111 Reserved x Reserved
MIC	12-15									Message integrity check
NOTE – Test class 1 tt bits and x reserved bits do not align with clause A.2.39.3 description for tt and x reserved bits. For backwards compatibility reasons, ITU-T G.988 tt bits and reserved bits will continue to be represented as described in this clause. Interoperable implementations should be ready to code test class 1 bits as described in this table.										

A.2.39.4 Format for test action invoked against IP host config data and IPv6 host config data entity classes

Field	Byte	8	7	6	5	4	3	2	1	Comments
Transaction correlation identifier	1-2									
Message type	3	0	0	0						DB = 0, AR = 0, AK = 0 bits 5-1: action = test result
Device identifier	4	0	0	0	0	1	0	1	1	Extended OMCI = 0x0B
Managed entity identifier	5-6									Entity class NOTE – This format applies to entity classes IP host config data and IPv6 host config data.
	7-8									Entity instance
Message contents length	9-10									Size of message contents field, bytes
Message contents	11	0	0	0	0	0	x	x	x	xxx: Test result 000 Timed out, no response 001 ICMP echo responses attached 010 ICMP time exceeded responses attached 011 Unexpected ICMP response 100 Target address in large string ME could not be resolved 101..111 Reserved
	12..n									See following descriptions for the contents of these bytes
MIC										Message integrity check, 4 bytes

If xxx = 001 (echo response – ping), the remainder of the message contains the following content. If the test message specifies the number of times to ping, the ONU should generate that number of echo requests; otherwise the number of echo requests generated is the ONU vendor's default. The resolution of the delay measurement is vendor-specific. The special value 0xFFFF indicates a lost response.

	12-27									In the extended ping test, these bytes contain the actual IP address that was pinged 4 bytes for IPv4, 16 bytes for IPv6. If the network address was not resolvable, the ONU should set these bytes to all zeroes. In the normal (non-extended ping test), delay measurements begin immediately in byte 12, according to the same pattern shown in bytes 28-29, etc.
	28-29									16 bit measurement of response delay n , expressed in milliseconds.
	30-31									16 bit measurement of response delay $n + 1$, expressed in milliseconds.
	...									Etc.

If xxx = 010 (time exceeded – traceroute), the remainder of the message contains the following content. In PON applications, it is not expected that a route trace will exceed the available space in the message, but if it does, the more distant responses should be dropped.

										IP address of nearest neighbour (4 bytes, IPv4, or 16 bytes, IPv6)
										IP address of second nearest neighbour (4 bytes, IPv4, or 16 bytes, IPv6)
	...									Etc.

If xxx = 011 (unexpected ICMP response), the remainder of the message contains the following content:

	12									Type
	13									Code
	14-15									Checksum
	16-19									Bytes 5-8 of ICMP message (meaning depends on type/code)
	20- n									Internet header + original datagram (truncated if necessary by extended OMCI message size limit)

A.2.39.5 Format for optical line supervision test action invoked against ANI-G, RE ANI-G, PPTP RE UNI, RE upstream amplifier or RE downstream amplifier entity class

Field	Byte	8	7	6	5	4	3	2	1	Comments
Transaction correlation identifier	1-2									
Message type	3	0	0	0						DB = 0, AR = 0, AK = 0 bits 5-1: action = test result
Device identifier	4	0	0	0	0	1	0	1	1	Extended OMCI = 0x0B
Managed entity identifier	5-6									Entity class NOTE – This message format pertains to ANI-G, RE ANI-G, PPTP RE UNI, RE upstream amplifier or RE downstream amplifier entity classes
	7-8									Entity instance
Message contents length	9-10									Size of message contents field
Message contents	11	0	0	0	0	0	0	0	1	Type = 1, Power feed voltage
	12-13									Volts, 2s complement, 20 mV resolution
	14	0	0	0	0	0	0	1	1	Type = 3, Received optical power
	15-16									Decibel-microwatts, 2s complement, 0.002 dB resolution (Coding –32768 to +32767, where 0x00 = 0dBuW, 0x03e8 = +2dBuW, etc.)
	17	0	0	0	0	0	1	0	1	Type = 5, Mean optical launch power
	18-19									Decibel-microwatts, 2s complement, 0.002 dB resolution (Coding –32768 to +32767, where 0x00 = 0dBuW, 0x03e8 = +2dBuW, etc.)
	20	0	0	0	0	1	0	0	1	Type = 9, Laser bias current
	21-22									Unsigned integer, 2 µA resolution
	23	0	0	0	0	1	1	0	0	Type 12, temperature, degrees Celsius
	24-25									2s complement, 1/256 °C resolution
26-27									Pointer to a general purpose buffer ME. Valid only for vendor-specific tests that require a GP buffer. This field is optional. The OLT may include this field, or in case it is not used, omit it or set it to zero. The OLT should accept either option.	
MIC										Message integrity check
NOTE – Unsupported tests are indicated with test type indicator 0 and 2 bytes of 0 data.										

A.2.39.6 Format for test action invoked against dot1lag MEP entity class, loopback test

Field	Byte	8	7	6	5	4	3	2	1	Comments
Transaction correlation identifier	1-2									
Message type	3	0	0	0						DB = 0, AR = 0, AK = 0 bits 5-1: action = test result
Device identifier	4	0	0	0	0	1	0	1	1	Extended OMCI = 0x0B
Managed entity identifier	5-6									Entity class. NOTE – This message format pertains to ONU-G and circuit pack entity classes.
	7-8									Entity instance
Message contents length	9-10									Size of message contents field = 9 bytes
Message contents	11	0	0	0	0	0	0	0	x	x = 1: indicates failure to receive any loopback replies (LBRs) within 5 s
	12-13									Valid LBRs count: the number of valid, in-order LBRs received.
	14-15									Out-of-order LBRs count: the number of valid LBRs received that were out of order.
	16-17									Mismatch LBRs count: the number of received LBRs whose MAC SDU did not match that of the corresponding LBM (except for opcode). Optional feature, set to 0xFF if not supported.
	18-19									Delay from LB message transmission to LB response reception, measured in microseconds. The value 0 indicates no information available.
MIC	20-23									Message integrity check

A.2.39.7 Format for test action invoked against dot1lag MEP entity class, linktrace test

Field	Byte	8	7	6	5	4	3	2	1	Comments
Transaction correlation identifier	1-2									
Message type	3	0	0	0						DB = 0, AR = 0, AK = 0 bits 5-1: action = test result
Device identifier	4	0	0	0	0	1	0	1	1	Extended OMCI = 0x0B
Managed entity identifier	5-6									Entity class. NOTE – This message format pertains to ONU-G and circuit pack entity classes.
	7-8									Entity instance
Message contents length	9-10									Size of message contents field = 13 bytes

Field	Byte	8	7	6	5	4	3	2	1	Comments
Message contents	11	0	0	0	0	0	0	0	x	x = 1: indicates failure to receive any linktrace replies (LTRs) within 5 s
	12-15									Transaction ID of transmitted LTM
	16-23									Content of egress TLV data field in transmitted LTM (clause 21.8.8 of [IEEE 802.1ag]). The LTRs themselves are captured in the general purpose buffer designated by the test command.
MIC	24-27									Message integrity check

A.2.40 Get current data

Field	Byte	8	7	6	5	4	3	2	1	Comments
Transaction correlation identifier	1-2									
Message type	3	0	1	0						DB = 0, AR = 1, AK = 0 bits 5-1: action = get current data
Device identifier	4	0	0	0	0	1	0	1	1	Extended OMCI = 0x0B
Managed entity identifier	5-6									Entity class
	7-8									Entity instance
Message contents length	9-10									Size of message contents field = 2 bytes
Message contents	11-12									Attribute mask
MIC	13-16									Message integrity check

A.2.41 Get current data response

Bytes 14..17 are always reserved for the optional-attribute and attribute execution masks; however, the contents of these bytes are only valid in conjunction with the 1001 encoding used to indicate failed or unknown attributes. If the result code is not 1001, these bytes should be set to 0 by the ONU and ignored by the OLT.

Field	Byte	8	7	6	5	4	3	2	1	Comments
Transaction correlation identifier	1-2									
Message type	3	0	0	1						DB = 0, AR = 0, AK = 1 bits 5-1: action = get current data
Device identifier	4	0	0	0	0	1	0	1	1	Extended OMCI = 0x0B
Managed entity identifier	5-6									Entity class
	7-8									Entity instance
Message contents length	9-10									Size of message contents field, bytes

Field	Byte	8	7	6	5	4	3	2	1	Comments
Message contents	11	0	0	0	0	x	x	x	x	Result, reason 0000 command processed successfully 0001 command processing error 0010 command not supported 0011 parameter error 0100 unknown managed entity 0101 unknown managed entity instance 0110 device busy 1001 attribute(s) failed or unknown
	12-13									Attribute mask
	14-15									Optional-attribute mask, used with 1001 encoding: 0 default 1 unsupported attribute
	16-17									Attribute execution mask, used with 1001 encoding: 0 default 1 failed attribute
	18- <i>n</i>									Value of first attribute included (size depending on the type of attribute)
										...
										Value of last attribute included
MIC										Message integrity check, 4 bytes

A.2.42 Set table

The set table command provides a way in which a number of rows may be written into a table with a single command. The same function can be achieved with individual set commands, with each command instance directed to a single row of the table.

Writeable tables in the OMCI have various mechanisms to control whether a given set operation causes a new row to be added to the table, an existing row to be overwritten or deleted, or the entire table cleared. All such mechanisms are embedded within the definition of the table row itself. Conflicting control semantics are therefore possible. The set table command executes each table row sequentially, in list order.

Field	Byte	8	7	6	5	4	3	2	1	Comments
Transaction correlation identifier	1-2									
Message type	3	0	1	0						DB = 0, AR = 1, AK = 0 bits 5-1: action = set table
Device identifier	4	0	0	0	0	1	0	1	1	Extended OMCI = 0x0B
Managed entity identifier	5-6									Entity class
	7-8									Entity instance
Message contents length	9-10									Size of message contents field, bytes

Field	Byte	8	7	6	5	4	3	2	1	Comments
Message contents	11-12									Attribute mask (Note)
	13-n									Value of the first table row (size depending on table definition)
										...
										Value of the last table row
MIC										Message integrity check, 4 bytes

NOTE – Exactly one bit of the attribute mask must be set, and that bit must correspond to a read-write table attribute in the definition of the parent managed entity.

A.2.43 Set table response

Field	Byte	8	7	6	5	4	3	2	1	Comments
Transaction correlation identifier	1-2									
Message type	3	0	0	1						DB = 0, AR = 0, AK = 1 bits 5-1: action = set table
Device identifier	4	0	0	0	0	1	0	1	1	Extended OMCI = 0x0B
Managed entity identifier	5-6									Entity class
	7-8									Entity instance
Message contents length	9-10									Size of message contents field = 1 byte
Message contents	11	0	0	0	0	x	x	x	x	Result, reason 0000 command processed successfully 0001 command processing error 0010 command not supported 0011 parameter error 0100 unknown managed entity 0101 unknown managed entity instance 0110 device busy 1001 attribute(s) failed or unknown
MIC	12-15									Message integrity check

A.3 Baseline message set

All G-PON OLTs and ONUs support the baseline message set.

A.3.1 Create

It should be noted that the message contents for the create message apply only to attributes that are defined to be set-by-create. Writeable attributes that are not set-by-create are not permitted in a create message. Thus, the first byte of the message contents field begins with the attribute value for the first set-by-create attribute and so forth. Space for each set-by-create attribute must be allocated in the create message, even if the attribute is optional. When an optional attribute is not to be instantiated, the placeholder value to be entered into this space is specific to the definition of each attribute. If the ONU does not support a given optional set-by-create attribute, the ONU should simply ignore that field in the create message, and the ONU should not set an illegal value flag in the create message response.

When the OMCI specifies a default value for a set-by-create attribute, the intention is that the OLT populate the default recommendation into the create message. The ONU is not responsible for instantiating any particular value for a set-by-create attribute.

Field	Byte	8	7	6	5	4	3	2	1	Comments
Transaction correlation identifier	1-2									
Message type	3	0	1	0						DB = 0, AR = 1, AK = 0 bits 5-1: action = create
Device identifier	4	0	0	0	0	1	0	1	0	OMCI = 0x0A
Managed entity identifier	5-6									Entity class
	7-8									Entity instance
Message contents	9									Attribute value of first set-by-create attribute, NOT the ME ID (size depending on the type of attribute)
										...
										Attribute value of last set-by-create attribute (size depending on the type of attribute)
	xx-40									Zero padding
OMCI trailer	41-48									

A.3.2 Create response

Field	Byte	8	7	6	5	4	3	2	1	Comments
Transaction correlation identifier	1-2									
Message type	3	0	0	1						DB = 0, AR = 0, AK = 1 bits 5-1: action = create
Device identifier	4	0	0	0	0	1	0	1	0	OMCI = 0x0A
Managed entity identifier	5-6									Entity class
	7-8									Entity instance
Message contents	9	0	0	0	0	x	x	x	x	Result, reason 0000 = command processed successfully 0001 = command processing error 0010 = command not supported 0011 = parameter error 0100 = unknown managed entity 0101 = unknown managed entity instance 0110 = device busy 0111 = instance exists
	10-11									Attribute execution mask, used with 0011 encoding: 0 = attribute ok 1 = illegal value attribute

Field	Byte	8	7	6	5	4	3	2	1	Comments
	12-40									Zero padding
OMCI trailer	41-48									

A.3.3 Delete

Field	Byte	8	7	6	5	4	3	2	1	Comments
Transaction correlation identifier	1-2									
Message type	3	0	1	0						DB = 0, AR = 1, AK = 0 bits 5-1: action = delete
Device identifier	4	0	0	0	0	1	0	1	0	OMCI = 0x0A
Managed entity identifier	5-6									Entity class
	7-8									Entity instance
Message contents	9-40									Zero padding
OMCI trailer	41-48									

A.3.4 Delete response

Field	Byte	8	7	6	5	4	3	2	1	Comments
Transaction correlation identifier	1-2									
Message type	3	0	0	1						DB = 0, AR = 0, AK = 1 bits 5-1: action = delete
Device identifier	4	0	0	0	0	1	0	1	0	OMCI = 0x0A
Managed entity identifier	5-6									Entity class
	7-8									Entity instance
Message contents	9									Result, reason 0000 command processed successfully 0001 command processing error 0010 command not supported 0011 parameter error 0100 unknown managed entity 0101 unknown managed entity instance 0110 device busy
	10-40									Zero padding
OMCI trailer	41-48									

A.3.5 Set

Field	Byte	8	7	6	5	4	3	2	1	Comments
Transaction correlation identifier	1-2									
Message type	3	0	1	0						DB = 0, AR = 1, AK = 0 bits 5-1: action = set
Device identifier	4	0	0	0	0	1	0	1	0	OMCI = 0x0A

Field	Byte	8	7	6	5	4	3	2	1	Comments
Managed entity identifier	5-6									Entity class
	7-8									Entity instance
Message contents	9-10									Attribute mask
	11									Attribute value of first attribute to set (size depending on the type of attribute)
										...
										Attribute value of last attribute to set (size depending on the type of attribute)
	xx-40									Zero padding
OMCI trailer	41-48									

A.3.6 Set response

Field	Byte	8	7	6	5	4	3	2	1	Comments
Transaction correlation identifier	1-2									
Message type	3	0	0	1						DB = 0, AR = 0, AK = 1 bits 5-1: action = set
Device identifier	4	0	0	0	0	1	0	1	0	OMCI = 0x0A
Managed entity identifier	5-6									Entity class
	7-8									Entity instance
Message contents	9	0	0	0	0	x	x	x	x	Result, reason 0000 command processed successfully 0001 command processing error 0010 command not supported 0011 parameter error 0100 unknown managed entity 0101 unknown managed entity instance 0110 device busy 1001 attribute(s) failed or unknown
	10-11									Optional attribute mask, used with 1001 encoding: 0 = default 1 = unsupported attribute
	12-13									Attribute execution mask, used with 1001 encoding: 0 = default 1 = failed attribute
	14-40									Zero padding
	OMCI trailer	41-48								

A.3.7 Get

Based on the size of the message contents field, the aggregate size of the attributes requested by a single get command should not exceed 25 bytes.

Field	Byte	8	7	6	5	4	3	2	1	Comments
Transaction correlation identifier	1-2									
Message type	3	0	1	0						DB = 0, AR = 1, AK = 0 bits 5-1: action = get
Device identifier	4	0	0	0	0	1	0	1	0	OMCI = 0x0A
Managed entity identifier	5-6									Entity class
	7-8									Entity instance
Message contents	9-10									Attribute mask
	11-40									Zero padding
OMCI trailer	41-48									

A.3.8 Get response

Bytes 37 to 40 are always reserved for the optional attribute and attribute execution masks; however, the contents of these bytes are only valid in conjunction with the 1001 encoding used to indicate failed or unknown attributes.

When the OLT wishes to transfer an attribute whose size is, or might be larger than the space available in one OMCI message (table attribute), the ONU responds with four bytes to indicate the size of that attribute with an appropriate attribute mask. The OLT should then use the get next message in order to retrieve the attribute.

Field	Byte	8	7	6	5	4	3	2	1	Comments
Transaction correlation identifier	1-2									
Message type	3	0	0	1						DB = 0, AR = 0, AK = 1 bits 5-1: action = get
Device identifier	4	0	0	0	0	1	0	1	0	OMCI = 0x0A
Managed entity identifier	5-6									Entity class
	7-8									Entity instance
Message contents	9	0	0	0	0	x	x	x	x	Result, reason 0000 command processed successfully 0001 command processing error 0010 command not supported 0011 parameter error 0100 unknown managed entity 0101 unknown managed entity instance 0110 device busy 1001 attribute(s) failed or unknown
	10-11									Attribute mask

Field	Byte	8	7	6	5	4	3	2	1	Comments
	12									Value of first attribute included (size depending on the type of attribute)
										...
										Value of last attribute included (size depending on the type of attribute)
	xx-36									Zero padding
	37-38									Optional attribute mask, used with 1001 encoding: 0 = default 1 = unsupported attribute
	39-40									Attribute execution mask, used with 1001 encoding: 0 = default 1 = failed attribute
OMCI trailer	41-48									

A.3.9 Get all alarms

Field	Byte	8	7	6	5	4	3	2	1	Comments
Transaction correlation identifier	1-2									
Message type	3	0	1	0						DB = 0, AR = 1, AK = 0 bits 5-1: action = get all alarms
Device identifier	4	0	0	0	0	1	0	1	0	OMCI = 0x0A
Managed entity identifier	5-6									Entity class = ONU data
	7-8	0	0	0	0	0	0	0	0	Entity instance
Message contents	9	0	0	0	0	0	0	0	x	x = alarm retrieval mode 0 = Get all alarms regardless of ARC status 1 = Get all alarms not currently under ARC
	10-40									Zero padding
OMCI trailer	41-48									

A.3.10 Get all alarms response

Field	Byte	8	7	6	5	4	3	2	1	Comments
Transaction correlation identifier	1-2									
Message type	3	0	0	1						DB = 0, AR = 0, AK = 1 bits 5-1: action = get all alarms
Device identifier	4	0	0	0	0	1	0	1	0	OMCI = 0x0A
Managed entity identifier	5-6									Entity class = ONU data
	7-8									Entity instance = 0
Message contents	9-10									Number of subsequent get all alarms next commands
	11-40									Zero padding

Field	Byte	8	7	6	5	4	3	2	1	Comments
OMCI trailer	41-48									

A.3.11 Get all alarms next

Command sequence numbers start from 0 onwards.

Field	Byte	8	7	6	5	4	3	2	1	Comments
Transaction correlation identifier	1-2									
Message type	3	0	1	0						DB = 0, AR = 1, AK = 0 bits 5-1: action = get all alarms next
Device identifier	4	0	0	0	0	1	0	1	0	OMCI = 0x0A
Managed entity identifier	5-6									Entity class = ONU data
	7-8									Entity instance = 0
Message contents	9-10									Command sequence number
	11-40									Zero padding
OMCI trailer	41-48									

A.3.12 Get all alarms next response

The bit map used in the get all alarms next response for a given ME class is identical to the bit map used in the alarm notifications for that ME class.

In the case where the ONU receives a get all alarms next request message in which the command sequence number is out of range, the ONU should respond with a message in which bytes 9 to 40 are all set to 0. This corresponds to a response with entity class 0, entity instance 0, and bit map all 0s.

Field	Byte	8	7	6	5	4	3	2	1	Comments
Transaction correlation identifier	1-2									
Message type	3	0	0	1						DB = 0, AR = 0, AK = 1 bits 5-1: action = get all alarms next
Device identifier	4	0	0	0	0	1	0	1	0	OMCI = 0x0A
Managed entity identifier	5-6									Entity class = ONU data
	7-8									Entity instance = 0
Message contents	9-10									Entity class whose alarms are reported
	11-12									Entity instance whose alarms are reported
	13-40	x	x	x	x	x	x	x	x	Bit map alarms
OMCI trailer	41-48									

A.3.13 MIB upload

Field	Byte	8	7	6	5	4	3	2	1	Comments
Transaction correlation identifier	1-2									
Message type	3	0	1	0						DB = 0, AR = 1, AK = 0 bits 5-1: action = MIB upload
Device identifier	4	0	0	0	0	1	0	1	0	OMCI = 0x0A
Managed entity identifier	5-6									Entity class = ONU data
	7-8									Entity instance = 0
Message contents	9-40									Zero padding
OMCI trailer	41-48									

A.3.14 MIB upload response

Field	Byte	8	7	6	5	4	3	2	1	Comments
Transaction correlation identifier	1-2									
Message type	3	0	0	1						DB = 0, AR = 0, AK = 1 bits 5-1: action = MIB upload
Device identifier	4	0	0	0	0	1	0	1	0	OMCI = 0x0A
Managed entity identifier	5-6									Entity class = ONU data
	7-8									Entity instance = 0
Message contents	9-10									Number of subsequent MIB upload next commands
	11-40									Zero padding
OMCI trailer	41-48									

A.3.15 MIB upload next

Command sequence numbers start from 0 onwards.

Field	Byte	8	7	6	5	4	3	2	1	Comments
Transaction correlation identifier	1-2									
Message type	3	0	1	0						DB = 0, AR = 1, AK = 0 bits 5-1: action = MIB upload next
Device identifier	4	0	0	0	0	1	0	1	0	OMCI = 0x0A
Managed entity identifier	5-6									Entity class = ONU data
	7-8									Entity instance = 0
Message contents	9-10									Command sequence number
	11-40									Zero padding
OMCI trailer	41-48									

A.3.16 MIB upload next response

If the ONU receives an MIB upload next request message whose command sequence number is out of range, it should respond with a message in which bytes 9 to 40 are all set to 0. This corresponds to a response with entity class 0, entity instance 0, attribute mask 0, and padding from byte 15 to byte 40.

Note that if all attributes of a ME do not fit within one MIB upload next response message, the attributes will be split over several messages. The OLT can use the information in the attribute mask to determine which attribute values are reported in which MIB upload next response message.

Field	Byte	8	7	6	5	4	3	2	1	Comments
Transaction correlation identifier	1-2									
Message type	3	0	0	1						DB = 0, AR = 0, AK = 1 bits 5-1: action = MIB upload next
Device identifier	4	0	0	0	0	1	0	1	0	OMCI = 0x0A
Managed entity identifier	5-6									Entity class = ONU data
	7-8									Entity instance = 0
Message contents	9-10									Entity class of object
	11-12									Entity instance of object
	13-14									Attribute mask
	15-n									Value of the first attribute (size depending on type of the attribute)
										...
	xx-40									Zero padding
OMCI trailer	41-48									

A.3.17 MIB reset

Field	Byte	8	7	6	5	4	3	2	1	Comments
Transaction correlation identifier	1-2									
Message type	3	0	1	0						DB = 0, AR = 1, AK = 0 bits 5-1: action = MIB reset
Device identifier	4	0	0	0	0	1	0	1	0	OMCI = 0x0A
Managed entity identifier	5-6									Entity class = ONU data
	7-8									Entity instance = 0
Message contents	9-40									Zero padding
OMCI trailer	41-48									

A.3.18 MIB reset response

Field	Byte	8	7	6	5	4	3	2	1	Comments
Transaction correlation identifier	1-2									
Message type	3	0	0	1						DB = 0, AR = 0, AK = 1 bits 5-1: action = MIB reset
Device identifier	4	0	0	0	0	1	0	1	0	OMCI = 0x0A
Managed entity identifier	5-6									Entity class = ONU data
	7-8									Entity instance = 0

Field	Byte	8	7	6	5	4	3	2	1	Comments
Message contents	9	0	0	0	0	x	x	x	x	Result, reason 0000 command processed successfully 0001 command processing error 0010 command not supported 0011 parameter error 0100 unknown managed entity 0101 unknown managed entity instance 0110 device busy
	10-40									Zero padding
OMCI trailer	41-48									

A.3.19 Alarm

Field	Byte	8	7	6	5	4	3	2	1	Comments
Transaction correlation identifier	1-2									
Message type	3	0	0	0						DB = 0, AR = 0, AK = 0 bits 5-1: action = alarm
Device identifier	4	0	0	0	0	1	0	1	0	OMCI = 0x0A
Managed entity identifier	5-6									Entity class
	7-8									Entity instance
Message contents	9-36									Alarm bit map
	37-39									Zero padding
	40									Alarm sequence number
OMCI trailer	41-48									

A.3.20 Attribute value change

Field	Byte	8	7	6	5	4	3	2	1	Comments
Transaction correlation identifier	1-2									
Message type	3	0	0	0						DB = 0, AR = 0, AK = 0 bits 5-1: action = attribute value change
Device identifier	4	0	0	0	0	1	0	1	0	OMCI = 0x0A
Managed entity identifier	5-6									Entity class
	7-8									Entity instance

Field	Byte	8	7	6	5	4	3	2	1	Comments
Message contents	9-10									Attribute mask
	11- <i>n</i>									Attribute value of first attribute changed (size depending on the type of attribute)
										...
										Attribute value of last attribute changed (size depending on the type of attribute)
	xx-40									Zero padding
OMCI trailer	41-48									
<p>NOTE 1 – For table attributes, the AVC message does not contain an attribute value (only a mask), and no snapshot of the table is created. If the OLT wishes to obtain the new value, it must then do a get operation, followed by the required number of get next operations.</p> <p>NOTE 2 – If there is insufficient space in the message body for the new values of all changed (non-table) attributes, the ONU should issue multiple AVCs, each with a consistent attribute mask and a list of new attribute values, the total to include all changed attributes and their new values.</p>										

A.3.21 Test

The format of the test message is specific to the target entity class. A number of formats are presently defined. Future test extensions for a given entity class can be supported by adding additional encodings to presently unused bits or bytes. Future specification of tests for other entity classes may use an existing format or may define new formats for the test message. These extension mechanisms allow future tests to be supported without changing the principle of operation.

A.3.21.1 Format for ONU-G, ANI-G, RE ANI-G, PPTP RE UNI, RE upstream amplifier, RE downstream amplifier and circuit pack entity classes

Field	Byte	8	7	6	5	4	3	2	1	Comments
Transaction correlation identifier	1-2									
Message type	3	0	1	0						DB = 0, AR = 1, AK = 0 bits 5-1: action = test
Device identifier	4	0	0	0	0	1	0	1	0	OMCI = 0x0A
Managed entity identifier	5-6									Entity class. NOTE – This format applies to entity classes ONU-G, ANI-G, RE ANI-G, PPTP RE UNI, RE upstream amplifier, RE downstream amplifier and circuit pack.
	7-8									Entity instance
Message contents	9	0	0	0	0	x	x	x	x	xxxx = select test 0000..0110 reserved for future use 0111 self-test 1000..1111 vendor-specific use See the description related to the test result message.
	10-11									Pointer to a general purpose buffer ME, used to return vendor-specific test results. 0 = unused (vendor-specific results are not expected).
	12-13									Pointer to an octet string ME, used to define the vendor-specific test parameters. 0 = unused (vendor-specific parameters are not specified).
	14-40									Zero padding
OMCI trailer	41-48									

A.3.21.2 Format for IP host config data and IPv6 host config entity classes

Field	Byte	8	7	6	5	4	3	2	1	Comments
Transaction correlation identifier	1-2									
Message type	3	0	1	0						DB = 0, AR = 1, AK = 0 Bits 5-1: action = test
Device identifier	4	0	0	0	0	1	0	1	0	OMCI = 0x0A
Managed entity identifier	5-6									Entity class. NOTE – This format applies to entity classes IP host config data and IPv6 host config data.

Field	Byte	8	7	6	5	4	3	2	1	Comments
	7-8									Entity instance
Message contents	9	0	0	0	0	x	x	x	x	xxxx = select test 0001 = Ping 0010 = Traceroute 0011 = Extended ping 0100..0111 Reserved 1000..1111 Vendor-specific use The ICMP message is intended to be from the ONU upstream towards the network. See discussion related to the test result message.
	10-13									Option 1: IPv4 address of target (zero if byte 0 specifies extended ping test)
	10-25									Option 2: IPv6 address of target (zero if byte 0 specifies extended ping test)
	26									Number of times to ping. This field pertains to both explicit and extended ping tests. The value 0 selects the ONU's internal default. NOTE – The number is bounded by the size of the test result message. It can be up to 15 for explicit ping and up to 7 for extended ping.
	27-28									Pointer to large string ME that identifies the target via a DNS-parsable string. This field is used only for the extended ping test.
	...-40									Zero padding
OMCI trailer	41-48									

A.3.21.3 Format for PPTP POTS UNI entity class

The test message for POTS UNIs supports two basic categories of test operation, a defined set of tests that look in and out from the POTS port, and a set of code points that may be used for vendor-specific tests. The latter category is further subdivided into code points that return test results in a general purpose buffer ME, using the test results message primarily as an event trigger to signal test completion, and code points that return all test results in an ordinary test result message. If it is needed, the OLT must create the general purpose buffer ME before initiating the test action.

Note that a single message can be used to initiate multiple tests on a given ME if desired.

Bytes 10-23 are used by the dial tone make-break test. A zero value for a timer causes the ONU to use its built-in defaults. As many as three dial tone frequencies can be specified, or omitted by setting their values to 0. Other fields are also omitted with the value 0, or controlled by flags. An ONU can support the dial tone test with internal defaults only, and it is not required to support any of the attributes of bytes 10-23. Likewise, an ONU can use internal defaults for a drop test, rather than the

values given in bytes 24-33. The capabilities of an ONU are documented by the vendor and known through administrative practices.

Several distinct test classes are defined.

Field	Byte	8	7	6	5	4	3	2	1	Comments
Transaction correlation identifier	1-2									
Message type	3	0	1	0						DB = 0, AR = 1, AK = 0 Bits 5-1: action = test
Device identifier	4	0	0	0	0	1	0	1	0	OMCI = 0x0A
Managed entity identifier	5-6									Entity class. NOTE – This format applies to entity class PPTP POTS UNI.
	7-8									Entity instance
Message contents	9	x	0	t	t	x	x	x	x	tt selects one of the POTS test class formats 0 MLT, dial tone make-break 1 SIP/ITU-T H.248 test call 2..3 Reserved x Bits reserved for use in specific test classes as defined below

Test class 0:

<u>Field</u>	<u>Byte</u>	<u>8</u>	<u>7</u>	<u>6</u>	<u>5</u>	<u>4</u>	<u>3</u>	<u>2</u>	<u>1</u>	<u>Comments</u>
Message contents	9	a	0	0	0	x	x	x	x	a – test mode 0 = normal; deny test if line busy 1 = forced mode xxxx = select test 0000 = all MLTs 0001 = hazardous potential 0010 = foreign EMF 0011 = resistive faults 0100 = receiver off-hook 0101 = ringer 0110 = NT1 dc signature test 0111 = self-test 1000 = dial tone make-break test 1001..1011 = vendor-specific test, all results returned in test results message 1100..1111 is a vendor-specific test, test results returned in general purpose buffer ME. The ONU should deny a test operation command in this range if bytes 34-35 do not point to a GP buffer.
	10									DBDT timer T1 (slow dial tone threshold), in units of 0.1 s. Range 0.1 to 6.0 s.

<u>Field</u>	<u>Byte</u>	<u>8</u>	<u>7</u>	<u>6</u>	<u>5</u>	<u>4</u>	<u>3</u>	<u>2</u>	<u>1</u>	<u>Comments</u>
	11									DBDT timer T2 (no dial tone threshold), in units of 0.1 s. Range 1.0 to 10.0 s.
	12									DBDT timer T3 (slow break dial tone threshold), in units of 0.1 s. Range 0.1 to 3.0 s.
	13									DBDT timer T4 (no break dial tone threshold), in units of 0.1 s. Range 1.0 to 3.0 s.
	14							d	p	DBDT control byte d: dialled digit 1 = dialled digit specified in byte 15 0 = use default digit p = pulse (1) or tone (0) dialling
	15									Digit to be dialled, ASCII character in range "0"- "9", "*", "#".
	16-17									Dial tone frequency 1, in hertz
	18-19									Dial tone frequency 2, in hertz. 0 = unused (i.e., if only one tone is specified).
	20-21									Dial tone frequency 3, in hertz. 0 = unused (i.e., if only one or two tones are specified).
	22									Dial tone power threshold, absolute value, 0.1 dB resolution, range [-]0.1 to [-]25.3 dBm0, e.g., -13 dBm0 = 0x82. 0x00 = unspecified.
	23									Idle channel power threshold, absolute value, 1 dB resolution, range [-]1 to [-]90 dBm0. 0x00 = unspecified.
	24									DC hazardous voltage threshold, absolute value, volts 0x00 = unspecified.
	25									AC hazardous voltage threshold, volts RMS 0x00 = unspecified
	26									DC foreign voltage threshold, absolute value, volts 0x00 = unspecified
	27									AC foreign voltage threshold, volts RMS 0x00 = unspecified
	28									Tip-ground and ring-ground resistance threshold, kilohms 0x00 = unspecified
	29									Tip-ring resistance threshold, kilohms 0x00 = unspecified

<u>Field</u>	<u>Byte</u>	<u>8</u>	<u>7</u>	<u>6</u>	<u>5</u>	<u>4</u>	<u>3</u>	<u>2</u>	<u>1</u>	<u>Comments</u>
	30-31									Ringer equivalence minimum threshold, in 0.01 REN units 0x00 = unspecified
	32-33									Ringer equivalence maximum threshold, in 0.01 REN units 0x00 = unspecified.
	34-35									Pointer to a general purpose buffer ME, used to return vendor-specific test results
	36-37									Pointer to an octet string ME, used to define vendor-specific test parameters. 0 = unused (vendor-specific parameters are not specified).
	38-40									Zero padding
OMCI trailer	41-48									

Test class 1:

Field	Byte	8	7	6	5	4	3	2	1	Comments
Message contents	9	a	0	0	1	x	x	x	x	a – test mode 0 normal; deny test if line busy 1 forced mode x Reserved
	10-25									ASCII string containing the number to be dialled. Trailing unused octets are padded with null bytes.
	26-40									Zero padding
OMCI trailer	41-48									

A.3.21.4 Format for dot1ag MEP entity class, loopback test

Field	Byte	8	7	6	5	4	3	2	1	Comments
Transaction correlation identifier	1-2									
Message type	3	0	1	0						DB = 0, AR = 1, AK = 0 bits 5-1: action = test
Device identifier	4	0	0	0	0	1	0	1	0	OMCI = 0x0A
Managed entity identifier	5-6									Entity class. NOTE – This format applies to the dot1ag MEP entity class.
	7-8									Entity instance
Message contents	9	0	0	0	0	0	0	0	x	x = select test 0: Ethernet loopback test 1: IEEE 802.1ag linktrace test (see separate format description below) Other values are reserved.

Field	Byte	8	7	6	5	4	3	2	1	Comments
	10	0	0	0	c	p	p	p	d	If c = 1, the value of the MEP's CCM and LTM priority attribute is used, with drop eligibility false. If c = 0, pppd represents the priority (P bits) and drop eligibility fields of the transmitted LBM frame.
	11-16									MAC address of target MHF or MEP, or 0 if the destination MEP ID is to be used instead. [IEEE 802.1ag] specifies unicast addresses; [ITU-T Y.1731] also allows for multicast.
	17-18									Destination MEP ID, in the range 1..8191, or 0 if the MAC address in bytes 11-16 is to be used instead.
	19-20									Repetition count, range 1..1024. This governs how many LBMs are generated. The rate at which LBMs are generated is not specified. If 5 s elapse with no LBRs received, the test aborts.
	21-22									These four fields are pointers to as many as four octet string MEs, which are concatenated to form an octet string of up to 1500 bytes. The string is packaged into a data TLV and transmitted as part of the LBM. If all four fields are null pointers, no data TLV is sent. If only one octet string is needed, it should be specified in bytes 21-22, etc., with null pointers in the higher-numbered bytes of the test message.
	23-24									
	25-26									
	27-28									
	29-40									Zero padding
OMCI trailer	41-48									

A.3.21.5 Format for dot1ag MEP entity class, linktrace test

Field	Byte	8	7	6	5	4	3	2	1	Comments
Transaction correlation identifier	1-2									
Message type	3	0	1	0						DB = 0, AR = 1, AK = 0 bits 5-1: action = test
Device identifier	4	0	0	0	0	1	0	1	0	OMCI = 0x0A
Managed entity identifier	5-6									Entity class. NOTE – This format applies to the dot1ag MEP entity class.
	7-8									Entity instance

Field	Byte	8	7	6	5	4	3	2	1	Comments
Message contents	9	0	0	0	0	0	0	0	x	x = select test 0: Ethernet loopback test (see separate format description above) 1: IEEE 802.1ag linktrace test Other values reserved.
	10	f	0	0	0	0	0	0	0	Flags, a bit map f: <i>Use FDB only</i> . When 1, the bridge uses only its normal MAC forwarding tables for forwarding. When 0, the bridge may also consult its MIP CCM database to determine the forwarding port.
	11-16									Unicast MAC address of target MHF or MEP, or 0 if the destination MEP ID is to be used instead.
	17-18									Destination MEP ID, in the range 1..8191, or 0 if the unicast MAC address in bytes 11-16 is to be used instead.
	19									Max hops count – specifies initial TTL; limits the number of relay stages through which the LTM is forwarded before being discarded, and the number of LTRs that may be returned. [IEEE 802.1ag] recommends a default value of 64.
	20-21									Pointer to a general purpose buffer ME, used to return the linktrace results. The ONU should deny the test operation command if this field is a null or an invalid pointer.
	22-40									Zero padding
OMCI trailer	41-48									

A.3.22 Test response

If an ONU does not support all tests requested in byte 9 of the test message, it should not execute any test and should respond with result 0010, command not supported. If an ONU supports all of the requested tests but cannot support one or more of the explicitly specified threshold attributes, it should not execute any test and should respond with result 0011, parameter error. The test command could then be reissued with different thresholds or default thresholds, and would be expected to succeed.

The test response message is an indication to the OLT that the test request is received and is being processed.

Field	Byte	8	7	6	5	4	3	2	1	Comments
Transaction correlation identifier	1-2									
Message type	3	0	0	1						DB = 0, AR = 0, AK = 1 bits 5-1: action = test

Field	Byte	8	7	6	5	4	3	2	1	Comments
Device identifier	4	0	0	0	0	1	0	1	0	OMCI = 0x0A
Managed entity identifier	5-6									Entity class
	7-8									Entity instance
Message contents	9	0	0	0	0	x	x	x	x	Result, reason 0000 command processed successfully 0001 command processing error 0010 command not supported 0011 parameter error 0100 unknown managed entity 0101 unknown managed entity instance 0110 device busy
	10-40									Zero padding
OMCI trailer	41-48									

A.3.23 Start software download

When a file is to be downloaded to a single instance of the software image ME, the ME ID is specified in bytes 7-8. An optional feature permits the same file to be downloaded to a number of circuit packs by setting bytes 7-8 = 0xFFFF and specifying the software image ME IDs in bytes 15..16, etc.

Field	Byte	8	7	6	5	4	3	2	1	Comments
Transaction correlation identifier	1-2									
Message type	3	0	1	0						DB = 0, AR = 1, AK = 0 bits 5-1: action = start software download
Device identifier	4	0	0	0	0	1	0	1	0	OMCI = 0x0A
ME identifier	5-6									Entity class = software image
	7									MS byte of software image instance 0 ONU-G 1..254 slot number 255 download to multiple software image managed entities

Field	Byte	8	7	6	5	4	3	2	1	Comments
	8									LS byte of software image instance 0 instance 0 1 instance 1 2..254 vendor-specific use 255 multiple download
Message contents	9									Window size – 1
	10-13									Image size in bytes
	14									Number of circuit packs to be updated in parallel (value 1..9)
	15									MS byte of software image instance (slot number of circuit pack)
	16									LS byte of software image instance (value 0..1 or 2..254 vendor-specific)
	17- <i>n</i>									Software image ME IDs (same format as bytes 15..16) for additional simultaneous downloads
	xx-40									Zero padding
OMCI trailer	41-48									

A.3.24 Start software download response

When a file is downloaded to a single software image ME, the response contains the target ME ID in bytes 7-8, a result code in byte 9, a window size counterproposal (which may be the same as that suggested by the OLT in the original request) in byte 10, and 0 padding for the remaining bytes.

An ONU that supports the optional parallel download feature responds with the full format shown below. If the ONU does not support the parallel download feature, it responds with the code 0b0101, unknown ME instance.

Field	Byte	8	7	6	5	4	3	2	1	Comments
Transaction correlation identifier	1-2									
Message type	3	0	0	1						DB = 0, AR = 0, AK = 1 bits 5-1: action = start software download
Device identifier	4	0	0	0	0	1	0	1	0	OMCI = 0x0A
Managed entity identifier	5-6									Entity class = software image
	7									MS byte of software image instance 0 ONU-G 1..254 slot number 255 download to multiple software image managed entities
	8									LS byte of software image instance 0 instance 0 1 instance 1 2..254 vendor-specific use 255 multiple download
Message contents	9	0	0	0	0	x	x	x	x	Result, reason 0000 command processed successfully 0001 command processing error 0010 command not supported 0011 parameter error 0100 unknown managed entity 0101 unknown managed entity instance 0110 device busy
	10									Window size – 1
	11									Number of instances responding (value 0..9)
	12-13									ME ID of software image entity instance (slot number plus instance 0..1 or 2..254 vendor-specific)
	14									Result, reason for bytes 12..13 – same coding as byte 9
	15- <i>n</i>									Repeat coding of bytes 12..14 for additional requested software image instances
	xx-40									Zero padding
OMCI trailer	41-48									

A.3.25 Download section

Field	Byte	8	7	6	5	4	3	2	1	Comments
Transaction correlation identifier	1-2									

Field	Byte	8	7	6	5	4	3	2	1	Comments
Message type	3	0	x	0						DB = 0, AR = x, AK = 0 x = 0: no response expected (section within the window) x = 1: response expected (last section of a window) bits 5-1: action = sw download section
Device identifier	4	0	0	0	0	1	0	1	0	OMCI = 0x0A
Managed entity identifier	5-6									Entity class = software image
	7									MS byte of software image instance 0 ONU-G 1..254 slot number 255 download to multiple software image managed entities
	8									LS byte of software image instance 00 instance 0 01 instance 1 2..254 vendor-specific use 255 multiple download
Message contents	9									Download section number
	10-40									Data; 0 padding if final transfer requires only a partial block
OMCI trailer	41-48									

A.3.26 Download section response

Field	Byte	8	7	6	5	4	3	2	1	Comments
Transaction correlation identifier	1-2									
Message type	3	0	0	1						DB = 0, AR = 0, AK = 1 bits 5-1: action = sw download section
Device identifier	4	0	0	0	0	1	0	1	0	OMCI = 0x0A
Managed entity identifier	5-6									Entity class = software image
	7									MS byte of software image instance 0 ONU-G 1..254 slot number 255 download to multiple software image managed entities
	8									LS byte of software image instance 0 instance 0 1 instance 1 2..254 vendor-specific use 255 multiple download

Field	Byte	8	7	6	5	4	3	2	1	Comments
Message contents	9	0	0	0	0	x	x	x	x	Result, reason 0000 command processed successfully 0001 command processing error 0010 command not supported 0011 parameter error 0100 unknown managed entity 0101 unknown managed entity instance 0110 device busy
	10									Download section number
	11-40									Zero padding
OMCI trailer	41-48									

A.3.27 End software download

The format of this command is similar to that of the start software download message. Bytes 17..N support the optional parallel download feature, and are set to 0 for download to a single target.

Field	Byte	8	7	6	5	4	3	2	1	Comments
Transaction correlation identifier	1-2									
Message type	3	0	1	0						DB = 0, AR = 1, AK = 0 bits 5-1: action = end software download
Device identifier	4	0	0	0	0	1	0	1	0	OMCI = 0x0A
Managed entity identifier	5-6									Entity class = software image
	7									MS byte of software image instance 0 ONU-G 1..254 slot number 255 download to multiple software image managed entities
	8									LS byte of software image instance 0 instance 0 1 instance 1 2..254 vendor-specific use 255 multiple download
Message contents	9-12									CRC-32, computed over all bytes of the software image (excluding padding), as specified in [ITU-T I.363.5].
	13-16									Image size in bytes
	17									Number of parallel download instances sent in this message (value 1..9)
	18									MS byte of software image instance (slot number of circuit pack)

Field	Byte	8	7	6	5	4	3	2	1	Comments
	19									LS byte of software image instance (value 0..1 or 2..254 vendor-specific)
	20-n									Software image ME IDs (same format as bytes 18..19) for additional simultaneous downloads
	xx-40									Zero padding
OMCI trailer	41-48									

A.3.28 End software download response

The response message informs the OLT whether the download command was successful. If a single software image ME was targeted for download, byte 9 reports the result of the process. Byte 9 reports device busy as long as any of the instances is busy writing the image to a non-volatile store. Once the ONU has stored all images successfully, it responds with a 0 in byte 9 and a separate result for each software image ME.

Field	Byte	8	7	6	5	4	3	2	1	Comments
Transaction correlation identifier	1-2									
Message type	3	0	0	1						DB = 0, AR = 0, AK = 1 bits 5-1: action = end software download
Device identifier	4	0	0	0	0	1	0	1	0	OMCI = 0x0A
Managed entity identifier	5-6									Entity class = software image
	7									MS byte of software image instance 0 ONU-G 1..254 slot number 255 download to multiple software image managed entities
	8									LS byte of software image instance 0 instance 0 1 instance 1 2..254 vendor-specific use 255 multiple download
Message contents	9	0	0	0	0	x	x	x	x	Result, reason 0000 command processed successfully (CRC correct) 0001 command processing error (CRC incorrect) 0100 unknown managed entity 0101 unknown managed entity instance 0110 device busy
	10									Number of instances responding (value 0..9)

Field	Byte	8	7	6	5	4	3	2	1	Comments
	11-12									ME ID of software image entity instance (slot number plus instance 0..1 or 2..254 vendor-specific)
	13									Result, reason for bytes 11..12 – same coding as byte 9
	14-37									Repeat coding of bytes 11..13 for additional software image instances
	38-40									Zero padding
OMCI trailer	41-48									

A.3.29 Activate image

Because the end software download only signals completion after a new image has been stored in non-volatile memory, it is possible for the OLT to send the activate image command immediately after a successful end software download response.

Field	Byte	8	7	6	5	4	3	2	1	Comments
Transaction correlation identifier	1-2									
Message type	3	0	1	0						DB = 0, AR = 1, AK = 0 bits 5-1: action = activate image
Device identifier	4	0	0	0	0	1	0	1	0	OMCI = 0x0A
Managed entity identifier	5-6									Entity class = software image
	7									MS byte entity instance 0 ONU-G 1..254 slot number
	8	0	0	0	0	0	0	0	x	LS byte entity instance 0 first instance 1 second instance 2..254 vendor-specific use
Message contents	9	0	0	0	0	0	0	F	F	Bits FF: 00 Activate image unconditionally 01 Activate image only if no POTS/VoIP calls are in progress 10 Activate image only if no emergency call is in progress (Note) 11 Reserved If the ONU denies the Activate image command because of the FF field, it returns result, reason code 0110, device busy.
	10-40									Zero padding
OMCI trailer	41-48									

Field	Byte	8	7	6	5	4	3	2	1	Comments
NOTE – The ONU determines the presence of an originating emergency call on the basis of the Emergency service number attribute of the VoIP feature access codes ME. Other ways for the ONU to determine the presence of an emergency call are for further study.										

A.3.30 Activate image response

Field	Byte	8	7	6	5	4	3	2	1	Comments
Transaction correlation identifier	1-2									
Message type	3	0	0	1						DB = 0, AR = 0, AK = 1 bits 5-1: action = activate image
Device identifier	4	0	0	0	0	1	0	1	0	OMCI = 0x0A
Managed entity identifier	5-6									Entity class = software image
	7									MS byte entity instance 0 ONU-G 1..254 slot number
	8	0	0	0	0	0	0	0	x	LS byte entity instance 0 first instance 1 second instance 2..254 vendor-specific use
Message contents	9	0	0	0	0	x	x	x	x	Result, reason 0000 command processed successfully 0001 command processing error 0010 command not supported 0011 parameter error 0100 unknown managed entity 0101 unknown managed entity instance 0110 device busy
	10-40									Zero padding
OMCI trailer	41-48									

A.3.31 Commit image

Field	Byte	8	7	6	5	4	3	2	1	Comments
Transaction correlation identifier	1-2									
Message type	3	0	1	0						DB = 0, AR = 1, AK = 0 bits 5-1: action = commit image
Device identifier	4	0	0	0	0	1	0	1	0	OMCI = 0x0A
Managed entity identifier	5-6									Entity class = software image
	7									MS byte entity instance 0 ONU-G 1..254 slot number
	8	0	0	0	0	0	0	0	x	LS byte entity instance 0 first instance 1 second instance 2..254 vendor-specific use
Message contents	9-40									Zero padding
OMCI trailer	41-48									

A.3.32 Commit image response

Field	Byte	8	7	6	5	4	3	2	1	Comments
Transaction correlation identifier	1-2									
Message type	3	0	0	1						DB = 0, AR = 0, AK = 1 bits 5-1: action = commit image
Device identifier	4	0	0	0	0	1	0	1	0	OMCI = 0x0A
Managed entity identifier	5-6									Entity class = software image
	7									MS byte entity instance 0 ONU-G 1..254 slot number
	8	0	0	0	0	0	0	0	x	LS byte entity instance 0 first instance 1 second instance 2..254 vendor-specific use
Message contents	9	0	0	0	0	x	x	x	x	Result, reason 0000 command processed successfully 0001 command processing error 0010 command not supported 0011 parameter error 0100 unknown managed entity 0101 unknown managed entity instance 0110 device busy
	10-40									Zero padding
OMCI trailer	41-48									

A.3.33 Synchronize time

The synchronize time command controls the tick boundary for PM collection, and optionally, a date and time clock.

If this message specifies the time (and optionally the date), the ONU sets its PM interval counter to a current offset from the most recent 15 min boundary, i.e., to a value in the range 0..899 s. This may cause the current PM collection interval to be longer or shorter than 900 s. Date and time are not explicitly required in an ONU, but if the ONU has a real-time clock, it is also set by this message. If the OLT does not wish to specify a date, it may set year, month and day fields to 0. If the ONU does not support the setting of the date, it will use the success result info field in the synchronize time response message to indicate that only the 15 min tick boundary was set.

If date and time are not present in the message, the ONU sets its PM interval counter to 0. This may cause the current PM collection interval to be shorter than 900 s. The effect on a possible ONU real-time clock is not specified.

There is no intention that this message be used to establish a precise time of day reference.

Field	Byte	8	7	6	5	4	3	2	1	Comments
Transaction correlation identifier	1-2									
Message type	3	0	1	0						DB = 0, AR = 1, AK = 0 bits 5-1: action = synchronize time
Device identifier	4	0	0	0	0	1	0	1	0	OMCI = 0x0A
Managed entity identifier	5-6									Entity class = ONU-G
	7-8									Entity instance = 0
Message contents	9-10									Year, e.g., 2009
	11									Month, range 1..12
	12									Day of month, range 1..31
	13									Hour of day, range 0..23
	14									Minute of hour, range 0..59
	15									Second of minute, range 0..59
	16-40									Zero padding
OMCI trailer	41-48									

A.3.34 Synchronize time response

Field	Byte	8	7	6	5	4	3	2	1	Comments
Transaction correlation identifier	1-2									
Message type	3	0	0	1						DB = 0, AR = 0, AK = 1 Bits 5-1: action = synchronize time
Device identifier	4	0	0	0	0	1	0	1	0	OMCI = 0x0A
	5-6									Entity class = ONU-G

Field	Byte	8	7	6	5	4	3	2	1	Comments
Managed entity identifier	7-8									Entity instance = 0
Message contents	9									Result, reason 0000 command processed successfully 0001 command processing error 0010 command not supported 0011 parameter error 0100 unknown managed entity 0101 unknown managed entity instance 0110 device busy
	10									Success result info – this field has a meaning only when the result, reason code in byte 9 was "0000 command processed successfully". 0000 15 min tick boundary set successfully 0001 Date and 15 min tick boundary set successfully
	11-40									Zero padding
OMCI trailer	41-48									

A.3.35 Reboot

Field	Byte	8	7	6	5	4	3	2	1	Comments
Transaction correlation identifier	1-2									
Message type	3	0	1	0						DB = 0, AR = 1, AK = 0 bits 5-1: action = reboot
Device identifier	4	0	0	0	0	1	0	1	0	OMCI = 0x0A
Managed entity identifier	5-6									Entity class
	7-8									Entity instance
Message contents	9	0	0	0	0	0	0	F	F	Bits FF: 00 Reboot unconditionally 01 Reboot only if no POTS/VoIP calls are in progress 10 Reboot only if no emergency call is in progress (Note) 11 Reserved If the ONU denies the reboot command because of the FF field, it returns result, reason code 0110, device busy.
	10-40									Zero padding
OMCI trailer	41-48									

NOTE – The ONU determines the presence of an originating emergency call on the basis of the Emergency service number attribute of the VoIP feature access codes ME. Other ways for the ONU to determine the presence of an emergency call are for further study.

A.3.36 Reboot response

Field	Byte	8	7	6	5	4	3	2	1	Comments
Transaction correlation identifier	1-2									
Message type	3	0	0	1						DB = 0, AR = 0, AK = 1 bits 5-1: action = reboot
Device identifier	4	0	0	0	0	1	0	1	0	OMCI = 0x0A
Managed entity identifier	5-6									Entity class
	7-8									Entity instance
Message contents	9									Result, reason 0000 command processed successfully 0001 command processing error 0010 command not supported 0011 parameter error 0100 unknown managed entity 0101 unknown managed entity instance 0110 device busy
	10-40									Zero padding
OMCI trailer	41-48									

A.3.37 Get next

Command sequence numbers start from 0 onwards.

Field	Byte	8	7	6	5	4	3	2	1	Comments
Transaction correlation identifier	1-2									
Message type	3	0	1	0						DB = 0, AR = 1, AK = 0 bits 5-1: action = get next
Device identifier	4	0	0	0	0	1	0	1	0	OMCI = 0x0A
Managed entity identifier	5-6									Entity class
	7-8									Entity instance
Message contents	9-10									Attribute mask
	11-12									Command sequence number
	13-40									Zero padding
OMCI trailer	41-48									

A.3.38 Get next response

If the ONU receives a get next request message whose command sequence number is out of range, the ONU responds with parameter error.

Field	Byte	8	7	6	5	4	3	2	1	Comments
Transaction correlation identifier	1-2									

Field	Byte	8	7	6	5	4	3	2	1	Comments
Message type	3	0	0	1						DB = 0, AR = 0, AK = 1 bits 5-1: action = get next
Device identifier	4	0	0	0	0	1	0	1	0	OMCI = 0x0A
Managed entity identifier	5-6									Entity class
	7-8									Entity instance
Message contents	9	0	0	0	0	x	x	x	x	Result, reason 0000 command processed successfully 0001 command processing error 0010 command not supported 0011 parameter error 0100 unknown managed entity 0101 unknown managed entity instance 0110 device busy
	10-11									Attribute mask
	12- <i>n</i>									Attribute value (size depending on the type of attribute)
	xx-40									Zero padding
OMCI trailer	41-48									

A.3.39 Test result

The test result message reports the outcome of a test. In the case of a requested test, the transaction correlation identifier of the test result message is identical to the transaction correlation identifier of the test message that initiated the corresponding test. In the case of a self-triggered test result, the transaction correlation identifier is set to 0.

Several formats are currently defined. They are used as follows:

- self-test results, ONU-G, circuit pack, or any other ME that supports self-test;
- vendor-specific test results, generic format, any ME that supports it;
- POTS test results, either MLT, dial tone draw-break or vendor-specific POTS tests that use a general purpose buffer;
- ICMP tests, either ping or traceroute;
- the results of an optical line supervision test on the ANI-G, RE ANI-G, PPTP RE UNI, RE upstream amplifier or RE downstream amplifier;
- [IEEE 802.1ag] loopback and linktrace tests.

If a new test for the currently supported entities is defined in the future, the corresponding test results can be reported by extending the test result message layout. If a new test for other ME classes is defined in the future, a new test result message layout may be defined.

A.3.39.1 Format for self-test action invoked against ONU-G and circuit pack entity classes

Field	Byte	8	7	6	5	4	3	2	1	Comments
Transaction correlation identifier	1-2									
Message type	3	0	0	0						DB = 0, AR = 0, AK = 0 bits 5-1: action = test result

Field	Byte	8	7	6	5	4	3	2	1	Comments
Device identifier	4	0	0	0	0	1	0	1	0	OMCI = 0x0A
Managed entity identifier	5-6									Entity class. NOTE – This message format pertains to ONU-G and circuit pack entity classes.
	7-8									Entity instance
Message contents	9	0	0	0	0	0	0	0	0	Unused
	10	0	0	0	0	0	0	x	x	Self-test result: xx = 00: failed xx = 01: passed xx = 10: not completed
	11-12									Pointer to a general purpose buffer ME. Valid only for vendor-specific tests that require a GP buffer, otherwise zero.
	13-40									Zero padding
OMCI trailer	41-48									

A.3.39.2 Format for vendor-specific test actions invoked against ONU-G and circuit pack entity classes

This format is also used for vendor-specific test actions invoked against the PPTP POTS UNI entity class when no general purpose buffer is needed.

Field	Byte	8	7	6	5	4	3	2	1	Comments
Transaction correlation identifier	1-2									
Message type	3	0	0	0						DB = 0, AR = 0, AK = 0 bits 5-1: action = test result
Device identifier	4	0	0	0	0	1	0	1	0	OMCI = 0x0A
Managed entity identifier	5-6									Entity class. NOTE – This message format pertains to ONU-G, circuit pack and PPTP POTS UNI entity classes.
	7-8									Entity instance
Message contents	9									Type 1 (Note)
	10-11									Value 1
	12									Type 2
	13-14									Value 2
	15									Type 3
	16-17									Value 3
	18									Type 4
	19-20									Value 4
	21									Type 5
22-23									Value 5	

Field	Byte	8	7	6	5	4	3	2	1	Comments
	24									Type 6
	25-26									Value 6
	27									Type 7
	28-29									Value 7
	30									Type 8
	31-32									Value 8
	33									Type 9
	34-35									Value 9
	36									Type 10
	37-38									Value 10
	39-40									Zero padding
OMCI trailer	41-48									

NOTE – Test result types are specified in clause 11.2.10. Type-value fields are packed in the lowest byte positions. Unused trailing byte positions are filled with 0 values. If more than 10 type-value pairs are to be returned, an additional test type should be defined in the test message. At the vendor's discretion, a test result may include an ordered sequence of repeated type-value pairs to represent, for example, port ordering, or first/second power input. In this case, missing values can be flagged with type = 255.

A.3.39.3 Format for PPTP POTS UNI entity class

Byte 9 reports a summary MLT result. The result for each test category is limited to the two values *test passed or was not executed* or *test failed*. Bytes 11 and 12 report the results of a dial tone test.

Byte 10 reports the result of a self-test or a vendor-specific test that returns results in a general purpose buffer. At present, self-test is not supported for the PPTP POTS UNI entity class, and this byte should be set to 0.

There are four possible outcomes for a given test: it can pass, fail, not be run, or not be recognized by the ONU. If an ONU does not support or recognize a given test, it is expected to deny the test request message. To avoid physical damage, an ONU may cease testing if a test – usually hazardous potential – fails, and thus some subsequent tests will not be run. In addition, the ONU may support some but not all tests of a given suite, such as power measurements in the dial tone test sequence. The category summary in byte 9 includes two values. The value 1 indicates either that all tests in a category passed, or that nothing in the category was tested, while 0 indicates that at least one test in the category failed. Further information appears in flags specific to each test result attribute to indicate whether each detailed test was run or not, whether it passed or failed and whether a measured result is reported or not.

Several distinct test classes are defined.

Field	Byte	8	7	6	5	4	3	2	1	Comments
Transaction correlation identifier	1-2									
Message type	3	0	0	0						DB = 0, AR = 0, AK = 0 bits 5-1: action = test result
Device identifier	4	0	0	0	0	1	0	1	0	OMCI = 0x0A
Managed entity identifier	5-6									Entity class. NOTE – This message format pertains to PPTP POTS UNI entity class.

Field	Byte	8	7	6	5	4	3	2	1	Comments
	7-8									Entity instance
Message contents	9	t	t	x	x	x	x	x	x	tt selects one of the POTS test class formats 0 MLT, dial tone make-break 1 SIP/ITU-T H.248 test call 2..3 Reserved x Bits reserved for use in specific test classes as defined below

Test class 0:

Message contents	9	0	0	a	b	c	d	e	f	MLT drop test result: 0 = fail test a/b/c/d/e/f 1 = pass test, or test not run a/b/c/d/e/f: a = hazardous potential b = foreign EMF c = resistive faults d = receiver off-hook e = ringer f = NT 1 dc signature test
	10	0	0	0	0	0	0	x	x	Result of self-test or vendor-specific test: xx = 00: failed xx = 01: passed xx = 10: not completed
	11			b	b	b	d	d	d	Dial tone make-break flags: Ddd – Dial tone draw = 000 test not run = 01 m failed, could not draw = 10 m slow draw = 11 m passed bbb – Dial tone break = 000 test not run = 01 m failed, could not break = 10 m slow break = 11 m passed m – measured value flag = 0 measurement not reported = 1 measurement reported
	12			a	a	a	b	b	b	Dial tone power flags: aaa – quiet channel power bbb – dial tone power (Note)
	13			a	a	a	b	b	b	Loop test DC voltage flags aaa – VDC, tip-ground bbb – VDC, ring-ground (Note)

14			a	a	a	b	b	b	Loop test AC voltage flags aaa – VAC, tip-ground bbb – VAC, ring-ground (Note)
15			a	a	a	b	b	b	Loop test resistance flags 1 aaa – resistance, tip-ground bbb – resistance, ring-ground (Note)
16			a	a	a	b	b	b	Loop test resistance flags 2 aaa – resistance, tip-ring bbb – ringer load test (Note)
17									Time to draw dial tone, in 0.1 s units. Valid only if byte 11 ddd = xx1.
18									Time to break dial tone, in 0.1 s units. Valid only if byte 11 bbb = xx1.
19									Total dial tone power measurement, unsigned absolute value, 0.1 dB resolution, range 0 to [–]25.5 dBm0. Values above 0 dBm0 are reported as 0. Valid only if byte 12 bbb = xx1.
20									Quiet channel power measurement, unsigned absolute value, 1 dB resolution, range 0 to [–]90 dBm0. Valid only if byte 12 aaa = xx1.
21-22									Tip-ground DC voltage, 2s complement, resolution 1 V. Valid only if byte 13 aaa = xx1.
23-24									Ring-ground DC voltage, 2s complement, resolution 1 V. Valid only if byte 13 bbb = xx1.
25									Tip-ground AC voltage, Vrms. Valid only if byte 14 aaa = xx1.
26									Ring-ground AC voltage, Vrms. Valid only if byte 14 bbb = xx1.
27-28									Tip-ground DC resistance, kilohms. Infinite resistance: 0xFFFF. Valid only if byte 15 aaa = xx1.
29-30									Ring-ground DC resistance, kilohms. Infinite resistance: 0xFFFF. Valid only if byte 15 bbb = xx1.
31-32									Tip-ring DC resistance, kilohms. Infinite resistance: 0xFFFF. Valid only if byte 16 aaa = xx1.

	33										Ringer equivalence, in 0.1 REN units. Valid only if byte 16 bbb = xx1.
	34-35										Pointer to a general purpose buffer ME. Valid only for vendor-specific tests that require a GP buffer.
	36			a	a	a	b	b	b		Loop tip-ring test AC/DC voltage flags aaa – VAC, tip-ring bbb – VDC, tip-ring (Note)
	37										Tip-ring AC voltage, Vrms. Valid only if byte 36 aaa = xx1.
	38-39										Tip-ring DC voltage, 2s complement, resolution 1 V. Valid only if byte 36 bbb = xx1.
	40										Zero padding
OMCI trailer	41-48										

NOTE – Coding for 3 bit flag sets is as follows:

- = 000 test not run
- = 010 fail, measurement not reported
- = 011 fail, measurement reported
- = 110 pass, measurement not reported
- = 111 pass, measurement reported.

Test class 1:

Field	Byte	8	7	6	5	4	3	2	1	Comments
Message contents (Note)	9	0	0	0	1	x	y	y	y	yyy report the results of the test 000 Test failed 001 Test passed 010 Not completed, line off hook 011 Not completed, other reason 100 Reserved 101 Reserved 110 Reserved 111 Reserved x Reserved
	10-40									Zero padding
OMCI trailer	41-48									

NOTE – The test class 1 tt bits and x reserved bits do not align with clause A.3.39.3 description for tt and x reserved bits. For backwards compatibility reasons, ITU-T G.988 tt bits and reserved bits will continue to be represented as described in this table. Interoperable implementations should be ready to code test class 1 bits as described in this clause.

A.3.39.4 Format for test action invoked against IP host config data and IPv6 host config data entity classes

Field	Byte	8	7	6	5	4	3	2	1	Comments
Transaction correlation identifier	1-2									
Message type	3	0	0	0						DB = 0, AR = 0, AK = 0 bits 5-1: action = test result
Device identifier	4	0	0	0	0	1	0	1	0	OMCI = 0x0A
Managed entity identifier	5-6									Entity class. NOTE – This format applies to entity classes IP host config data and IPv6 host config data.
	7-8									Entity instance
Message contents	9	0	0	0	0	0	x	x	x	Test result: xxx = 000: timed out, no response xxx = 001: ICMP echo responses attached xxx = 010: ICMP time exceeded responses attached xxx = 011: Unexpected ICMP response xxx = 100: target address in large string ME could not be resolved xxx = 101-111: Reserved
	10	0	0	0	y	y	y	y	y	yyyyy: number of meaningful bytes in the remainder of the test result message. In the case of extended ping, this field is the number of bytes that contain delay measurement values.

If xxx = 001 (echo response – ping), the remainder of the message contains the following content. If the test message specifies the number of times to ping, the ONU should generate that number of echo requests; otherwise the number of echo requests generated is the ONU vendor's default. The resolution of the delay measurement is vendor-specific. The special value 0xFFFF indicates a lost response.

	11-12									16 bit measurement of response delay 1, expressed in milliseconds
	13-14									16 bit measurement of response delay 2, expressed in milliseconds
	...									Etc.

	25-40									For ping test 0001, these bytes can be either delay measurements or padding. For extended ping, these bytes contain the actual IP address that was pinged, 4 bytes for IPv4, 16 bytes for IPv6. If the network address was not resolvable, the ONU should set these bytes to all zeroes.
OMCI trailer	41-48									

If xxx = 010 (time exceeded – traceroute), the remainder of the message contains the following content. In PON applications, it is not expected that a route trace will exceed the available space in the message, but if it does, the more distant responses should be dropped. There is only enough space in the message body for a single IPv6 address.

	11-14									IP address of the nearest neighbour
	15-18									IP address of the second nearest neighbour
	...									Etc.
	...-40									Zero padding
OMCI trailer	41-48									

If xxx = 011 (unexpected ICMP response), the remainder of the message contains the following content:

	11									Type
	12									Code
	13-14									Checksum
	15-18									Bytes 5-8 of ICMP message (meaning depends on type/code)
	19-40									Internet header + 64 bits of original datagram (truncated)
OMCI trailer	41-48									

A.3.39.5 Format for optical line supervision test action invoked against ANI-G, RE ANI-G, PPTP RE UNI, RE upstream amplifier or RE downstream amplifier entity class

Field	Byte	8	7	6	5	4	3	2	1	Comments
Transaction correlation identifier	1-2									
Message type	3	0	0	0						DB = 0, AR = 0, AK = 0 bits 5-1: action = test result
Device identifier	4	0	0	0	0	1	0	1	0	OMCI = 0x0A

Field	Byte	8	7	6	5	4	3	2	1	Comments
Managed entity identifier	5-6									Entity class. NOTE – This message format pertains to ANI-G, RE ANI-G, PPTP RE UNI, RE upstream amplifier or RE downstream amplifier entity class.
	7-8									Entity instance
Message contents	9	0	0	0	0	0	0	0	1	Type = 1, power feed voltage
	10-11									Volts, 2s complement, 20 mV resolution
	12	0	0	0	0	0	0	1	1	Type = 3, received optical power
	13-14									Decibel-microwatts, 2s complement, 0.002 dB resolution (Coding –32768 to +32767, where 0x00 = 0dBuW, 0x03e8 = +2dBuW, etc.)
	15	0	0	0	0	0	1	0	1	Type = 5, Mean optical launch power
	16-17									Decibel-microwatts, 2s complement, 0.002 dB resolution (Coding –32768 to +32767, where 0x00 = 0dBuW, 0x03e8 = +2dBuW, etc.)
	18	0	0	0	0	1	0	0	1	Type = 9, laser bias current
	19-20									Unsigned integer, 2 μ A resolution
	21	0	0	0	0	1	1	0	0	Type 12, temperature, degrees Celsius
	22-23									2s complement, 1/256 $^{\circ}$ C resolution
	24-25									Pointer to a general purpose buffer ME. Valid only for vendor-specific tests that require a GP buffer.
26-40									Zero padding	
OMCI trailer	41-48									

NOTE – Unsupported tests are indicated with test type indicator 0 and 2 bytes of 0 data.

A.3.39.6 Format for test action invoked against dot1ag MEP entity class, loopback test

Field	Byte	8	7	6	5	4	3	2	1	Comments
Transaction correlation identifier	1-2									
Message type	3	0	0	0						DB = 0, AR = 0, AK = 0 bits 5-1: action = test result
Device identifier	4	0	0	0	0	1	0	1	0	OMCI = 0x0A
Managed entity identifier	5-6									Entity class. NOTE – This message format pertains to the dot1ag MEP entity class.
	7-8									Entity instance

Field	Byte	8	7	6	5	4	3	2	1	Comments
Message contents	9	0	0	0	0	0	0	0	x	x = 1: indicates failure to receive any loopback replies (LBRs) within 5 s
	10-11									Valid LBRs count: the number of valid, in-order LBRs received.
	12-13									Out of order LBRs count: the number of valid LBRs received that were out of order.
	14-15									Mismatch LBRs count: the number of received LBRs whose MAC SDU did not match that of the corresponding LBM (except for opcode). Optional feature, set to 0xFF if not supported.
	16-19									Delay from LB message transmission to LB response reception, measured in microseconds. The value 0 indicates no information available.
	20-40									Zero padding
OMCI trailer	41-48									

A.3.39.7 Format for test action invoked against dot1ag MEP entity class, linktrace test

Field	Byte	8	7	6	5	4	3	2	1	Comments
Transaction correlation identifier	1-2									
Message type	3	0	0	0						DB = 0, AR = 0, AK = 0 bits 5-1: action = test result
Device identifier	4	0	0	0	0	1	0	1	0	OMCI = 0x0A
Managed entity identifier	5-6									Entity class. NOTE – This message format pertains to the dot1ag MEP entity class.
	7-8									Entity instance
Message contents	9	0	0	0	0	0	0	0	x	x = 1: indicates failure to receive any linktrace replies (LTRs) within 5 s
	10-13									Transaction ID of transmitted LTM
	14-21									Content of egress TLV data field in transmitted LTM ([IEEE 802.1ag], clause 21.8.8). The LTRs themselves are captured in the general purpose buffer designated by the test command.
	22-40									Zero padding
OMCI trailer	41-48									

A.3.40 Get current data

Based on the size of the message contents field, the aggregate size of the attributes requested by a single get current data command should not exceed 25 bytes.

Field	Byte	8	7	6	5	4	3	2	1	Comments
Transaction correlation identifier	1-2									
Message type	3	0	1	0						DB = 0, AR = 1, AK = 0 bits 5-1: action = get current data
Device identifier	4	0	0	0	0	1	0	1	0	OMCI = 0x0A
Managed entity identifier	5-6									Entity class
	7-8									Entity instance
Message contents	9-10									Attribute mask
	11-40									Zero padding
OMCI trailer	41-48									

A.3.41 Get current data response

Bytes 37 to 40 are always reserved for the optional attribute and attribute execution masks; however, the contents of these bytes are only valid in conjunction with the 1001 encoding used to indicate failed or unknown attributes.

Field	Byte	8	7	6	5	4	3	2	1	Comments
Transaction correlation identifier	1-2									
Message type	3	0	0	1						DB = 0, AR = 0, AK = 1 bits 5-1: action = get current data
Device identifier	4	0	0	0	0	1	0	1	0	OMCI = 0x0A
Managed entity identifier	5-6									Entity class
	7-8									Entity instance
Message contents	9	0	0	0	0	x	x	x	x	Result, reason 0000 command processed successfully 0001 command processing error 0010 command not supported 0011 parameter error 0100 unknown managed entity 0101 unknown managed entity instance 0110 device busy 1001 attribute(s) failed or unknown
	10-11									Attribute mask
	12- <i>n</i>									Attribute value of first attribute included (size depending on the type of attribute)
										...
										Attribute value of last attribute included (size depending on the type of attribute)
	xx-36									

Field	Byte	8	7	6	5	4	3	2	1	Comments
	37-38									Optional attribute mask, used with 1001 encoding: 0 = default 1 = unsupported attribute
	39-40									Attribute execution mask, used with 1001 encoding: 0 = default 1 = failed attribute
OMCI trailer	41-48									

Annex B

OMCI in ITU-T PON systems

(This annex forms an integral part of this Recommendation.)

B.1 Establishing the ONU management and control channel (OMCC)

This clause should be read in conjunction with the respective TC layer specification, as applicable to the system under consideration.

Upon initialization, the ONU creates a default alloc-ID for the OMCC. The default alloc-ID neither requires nor uses a T-CONT. The following discussion explains when a T-CONT may meaningfully be associated with the default alloc-ID.

The establishment of the OMCC follows the process shown in Figure B.1-1. During activation, the ONU receives a PLOAM message from the OLT indicating the assignment of the ONU-ID. The ONU creates the default alloc-ID with the same value as the ONU-ID. It is therefore not necessary for the OLT to send an assign_alloc-ID message to establish the OMCC. If the OLT nevertheless chooses to send an assign_alloc-ID PLOAM with the default alloc-ID, the ONU should acknowledge this message without taking any specific further action. This is true regardless of the alloc-ID type value in the assign_alloc-ID message: it is not allowed to de-allocate the default alloc-ID with an assign_alloc-ID type 255 message.

Upon completion of ONU activation in ITU-T G.984 systems, the OLT assigns a GEM port-ID to the ONU for OMCI messages. This is accomplished by a configure_port-ID PLOAM message. The ONU maps the OMCI port-ID attribute to OMCC traffic and the default alloc-ID, and responds back to the OLT with an AK.

In subsequent ITU-T systems, the GEM port for OMCI use is automatically assigned, and is equal to the ONU-ID.

At this point, the OMCC path has been successfully established.

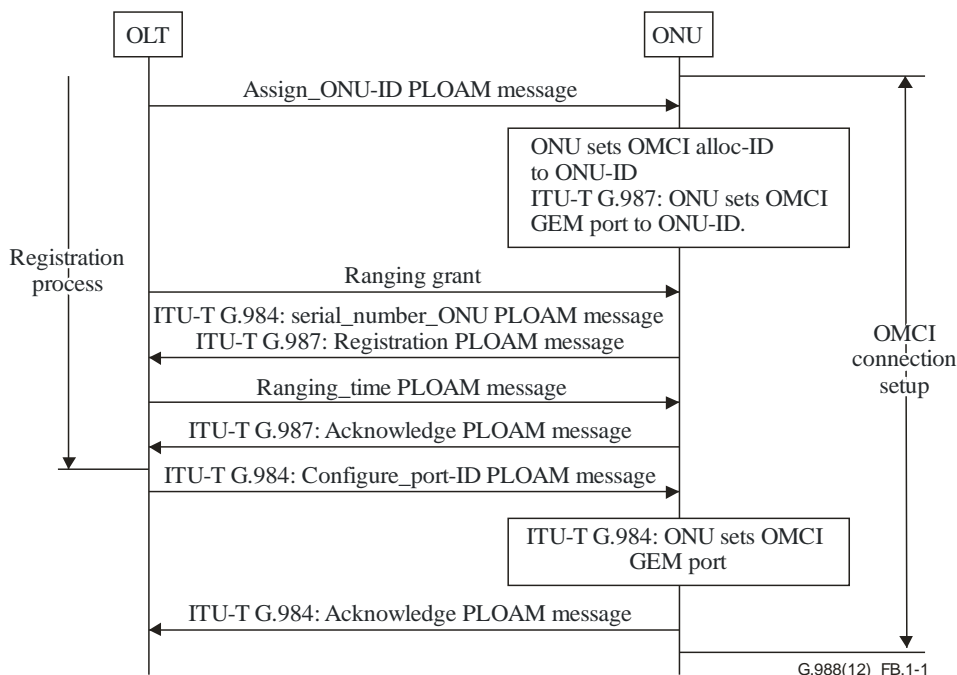

Figure B.1-1 – OMCC establishment

While it is not forbidden, it is not recommended that the default alloc-ID be used to carry subscriber traffic. If subscriber traffic is nevertheless to be carried in the default alloc-ID, this alloc-ID must be mapped to a T-CONT through normal OMCI messages.

OMCI traffic then consumes bandwidth allocated to the designated alloc-ID, but with strictly higher priority than all other traffic in the same alloc-ID. DBA reports for such a dual-purpose alloc-ID include both OMCI and subscriber traffic queues.

A T-CONT shared with the OMCC can be deallocated for subscriber traffic, in which case it disappears from the MIB view of the ONU. OMCC traffic over the default alloc-ID cannot be removed, deleted or redirected.

After the OMCC has been established, it is possible for the OLT to enable encryption on the OMCC GEM port. In ITU-T G.984 systems, this is accomplished by the OLT sending an encrypted_port-ID PLOAM that names the OMCC GEM port.

In subsequent PON systems, port encryption is normally established through the corresponding GEM port network CTP. The OMCC has no such associated ME, so it relies on defaults. If the GEM frame itself contains an encryption key index, it is understood to refer to the unicast key and to require encryption both up- and downstream. OMCI message channel failure may indicate the absence or miscoordination of unicast keys.

Regardless of OMCC encryption, OMCI messages are protected by an MIC, whose computation is specified in the relevant TC layer specification.

B.2 OMCI handling within the ONU

Message response times should not exceed 1 s. The message definition considers cases where command execution may take longer than this. For example, in executing tests, the ONU acknowledges the test command from the OLT within the required 1 s, then initiates an autonomous test result message at some later time when the test is complete. Another example is the case where downloaded software may take some significant time to write into a non-volatile store; in this case, the ONU responds to the end download command from the OLT with a device busy code and the OLT retries periodically until the operation is complete.

B.2.1 Message flow control and error recovery

NOTE – Prioritized message handling is defined only for the baseline OMCI message set. In the context of the extended message set, this clause should be read with the understanding that there is only one priority class.

The flow control/error recovery procedures for message exchange over the OMCC are based on a simplex acknowledged transaction stop-and-wait mechanism that can be extended to support concurrent execution of multiple transaction requests of different priority levels. These flow control procedures ensure that a low level acknowledged transaction request transmitted from the OLT has been properly received and processed to completion by the ONU before the next message of the same priority level is sent by the OLT. The stop-and-wait protocol uses the transaction correlation identifier field, retry counter(s) and applicable transaction request timer(s) to control the message flow rate while relying on an MIC to verify the data integrity of all received messages.

When a transaction request message of priority level i is sent to an ONU, a transaction request timer T_i is started. Timer T_i is stopped upon receipt of an AK message containing the same transaction correlation identifier value. If a valid AK message is not received by the OLT after timer T_i expires at time T_{maxi} , the OLT re-sends the original transaction request message. A retransmitted acknowledged transaction request message carries the same transaction correlation ID as the original message.

Retry counter R_i is defined at priority level i . Upon the first transmission of a new command at priority i , R_i is initialized to zero, and each time an acknowledged transaction request message is retransmitted, the OLT increments R_i . When R_i reaches the maximum retry value, R_{maxi} , the OLT stops retransmitting the message and declares an OMCC link state error.

These timers (T_i) and retry counters (R_i) are only maintained within the OLT and do not exist within the ONU. Threshold values for timer expiration (T_{maxi}) and number of retries (R_{maxi}) are not subject to standardization. It is suggested that the default threshold values of both T_{max} and R_{max} be independently configurable for each priority level. The default value for the high priority T_{max} should account for the typical message transmission delay plus the command message response time.

These flow control/error recovery procedures are illustrated in Figure B.2.1-1 for a case where the OMCC link is not permanently broken. First, the OLT sends an acknowledged transaction request (message 1) with priority level 0. While message 1 is outstanding, the OLT issues message 2 with priority level 1. Both of these commands are received and executed with the associated response messages returned to the OLT by the ONU. The AK for message 1 is received by the OLT in time; however, the response to message 2 is lost and never received. The OLT detects that something went wrong because timer T_1 expires, and the OLT therefore retransmits the original command (message 2). From the identical transaction ID, the ONU detects that this retransmitted command is identical to the last received priority level 1 command and therefore does not re-execute it. The ONU simply retransmits the original response from the previous execution of message 2, which in Figure B.2.1-1 reaches the OLT in time.

The final transaction in the example shows the case where the OLT sends an acknowledged transaction request (message 3) with priority level 0, but the message itself gets lost and is never properly received by the ONU. After the associated timer (T_0) expires, the OLT retransmits the command and now all goes well.

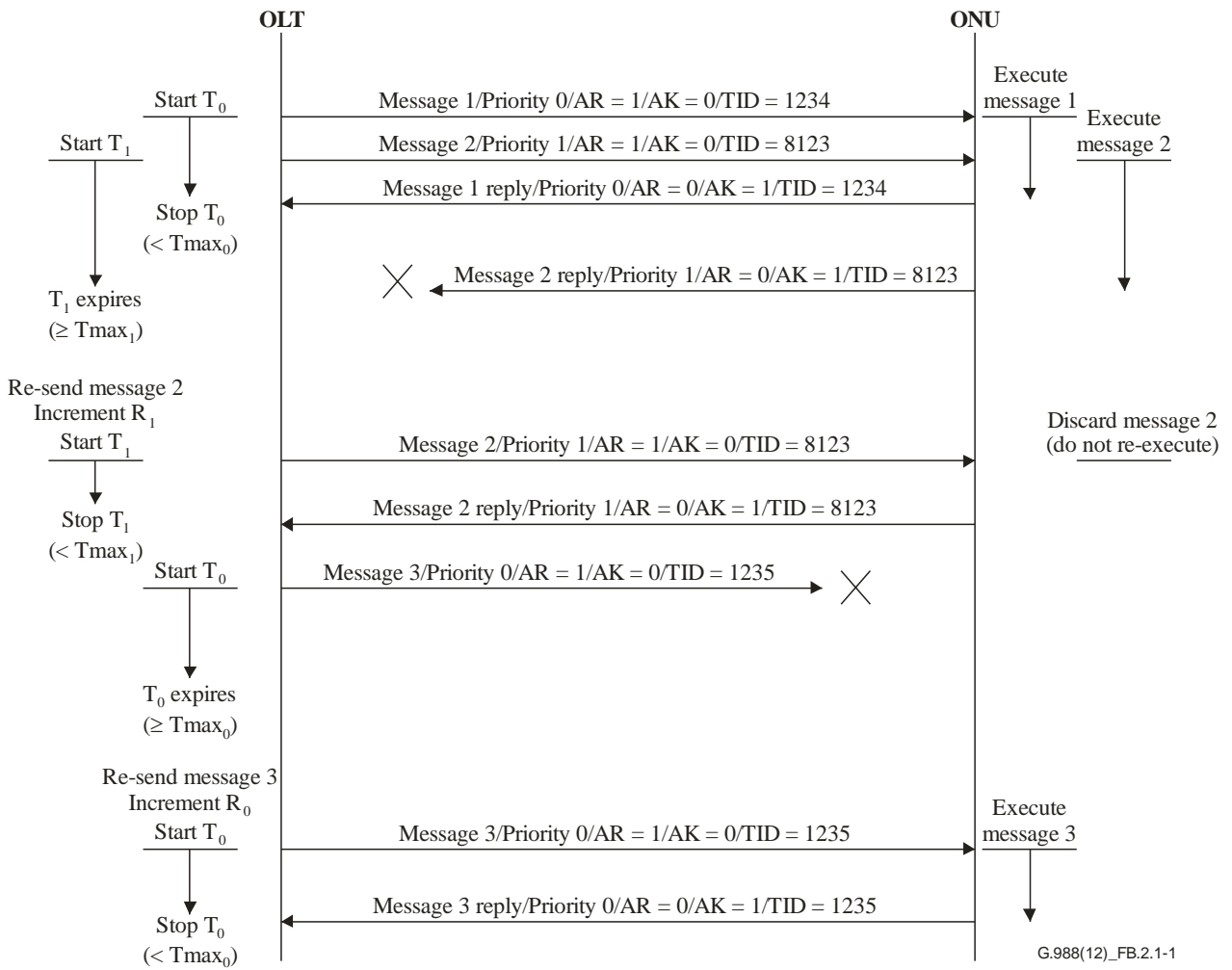

Figure B.2.1-1 – Concurrent message exchange with error recovery

A case where the OMCC link is effectively broken (link down) is shown in Figure B.2.1-2.

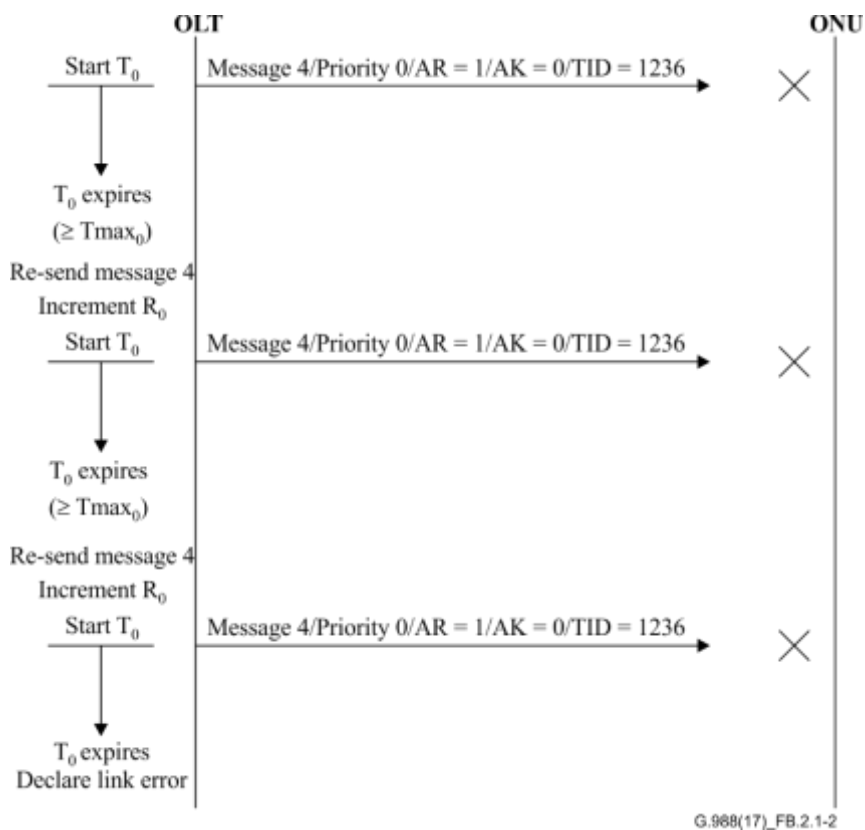

Figure B.2.1-2 – OMCC link error detection

B.2.2 Prioritized protocol entities

NOTE 1 – Prioritized message handling is defined only for the baseline message set. In the context of the extended message set, this clause should be read with the understanding that there is only one priority class.

This clause specifies the behaviour of the ONU more precisely than in the preceding clause with respect to the prioritized request mechanism of the OMCC.

Conceptually, the way the ONU handles the OMCC requests can be illustrated by referring to the dual priority level implementation example shown in Figure B.2.2-1.

When the ONU receives a GEM frame via the GEM port associated with the management channel, it calculates the MIC and compares it with the value found in the OMCI trailer. If the values do not match, the ONU discards the message. It is recommended that this event be logged by the ONU and possibly communicated to the OLT by an out-of-band mechanism but, as far as the protocol is concerned, the message is discarded silently.

NOTE 2 – Loss of encrypted OMCI communications with an otherwise functional ONU may indicate lost or corrupt keys. The OLT is advised to renegotiate keys or to fall back to an unencrypted OMCI as the first steps in diagnosing the trouble.

Messages with a correct MIC are then placed into either of two distinct incoming message queues, according to the high or low priority level of the associated command encoded in the MSB of the transaction correlation identifier field. If the associated incoming message queue is already full, the ONU discards the message. It is recommended that this event be logged by the ONU and possibly communicated to the OLT by an out-of-band mechanism but, as far as the protocol is concerned, the message is discarded silently.

There are two distinct incoming command processing protocol entities, one associated with each priority level, which serve messages sequentially from independent incoming queues. Each protocol entity can execute concurrently. If a message is a one-way (unacknowledged) command, the protocol entity simply executes the command. If a message is an acknowledged command, the protocol entity

must first look at the transaction correlation identifier. If it is not equal to the transaction correlation identifier of the last executed command with the same priority level, the protocol entity executes the command and places the response/acknowledgement, with an identical transaction correlation identifier, in the outgoing queue of the same priority level. If the transaction correlation identifier is equal to that of the last executed command with the same priority level (the case where the OLT retransmits a command due to a lack of proper acknowledgement), the protocol entity does not actually execute the command but simply places the response from the last execution of that command in the outgoing queue to resend the previous acknowledgement response. In both cases, the command processing protocol entity for a given priority level should block until there is room in the associated outgoing queue for the response message.

In the upstream direction, requests by ONU applications to send autonomous event notifications simply result in the corresponding messages being directed to an event notification protocol entity for transmission to the OLT. The event notification protocol entity forwards these event notification messages to the low priority outgoing queue. In this case as well, the event notification protocol entity should block until there is room in the low priority outgoing queue to hold the notification message. The MIC generator removes messages from the outgoing queues using a strict priority discipline (that is, the low-priority queue is served only when the high-priority queue is empty), generates an MIC, formats the packet as either a baseline or an extended message, depending on which form is in use, and transmits the message to the OLT.

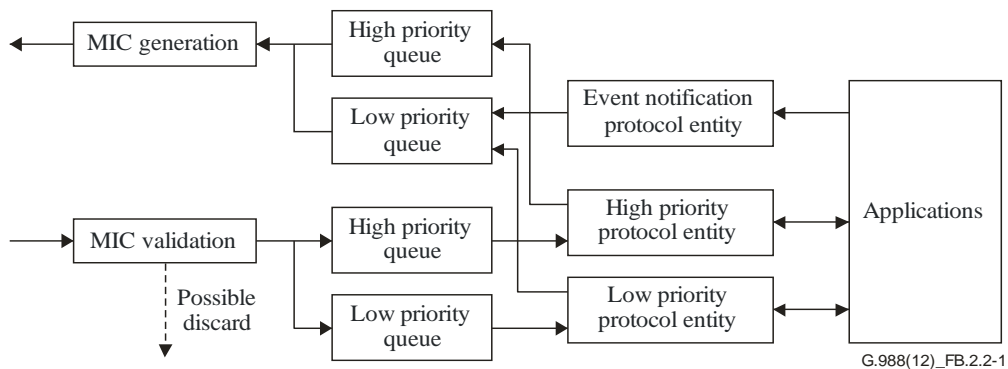

Figure B.2.2-1 – Protocol entities within the ONU

B.2.3 Restrictions on actions in relation to the protocol entities

To reduce the complexity and the amount of memory necessary in the ONU, the OLT is not allowed to issue an MIB upload or a software download of a certain priority level while a similar action in the other priority level is in progress.

B.2.4 Use of the default alloc-ID

The upstream OMCC is carried in the default allocation_ID. In some implementations, the default alloc_ID is also used for user traffic, and is associated with a T-CONT ME. In these cases, the OMCC traffic is combined with the user traffic using simple strict priority multiplexing, with the OMCC having a higher priority.

Annex C

OMCI in Ethernet PON systems

(This annex forms an integral part of this Recommendation.)

C.1 Establishing the ONU management and control channel (OMCC)

Ethernet PON registration is described in clauses 64 and 77 of [IEEE 802.3]; the differences between the descriptions are immaterial to the establishment of the OMCC.

The OMCC for an Ethernet PON is established during the ONU discovery process. Figure C.1-1 replicates the illustration of the ONU discovery process from clause 77 of [IEEE 802.3]. During the discovery process, the OLT and ONU exchange their MAC addresses and physical parameters. The OLT then assigns a unique logical link ID (LLID) to the ONU, whereupon a logical connection between the OLT and ONU is established. When this discovery handshake is complete, the OMCC has been established. No additional process is needed to establish the OMCC in an Ethernet PON system.

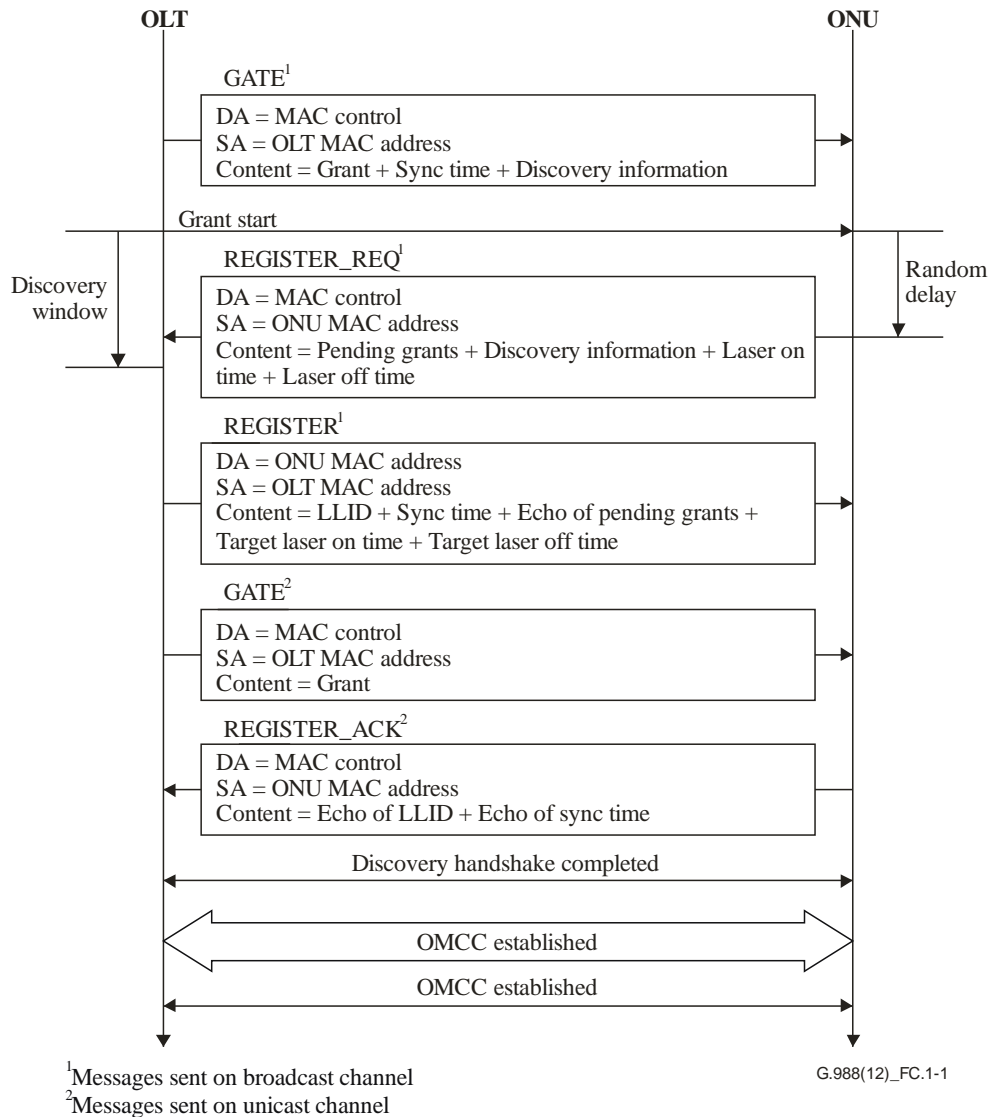

Figure C.1-1 – OMCC establishment process, Ethernet PON

C.2 Encapsulating OMCI messages in Ethernet frames

The extended OAM frame defined in IEEE 802.3 is used for the EPON OMCI frame format. Figure C.2-1 shows the extended OAM frame for EPON OMCI.

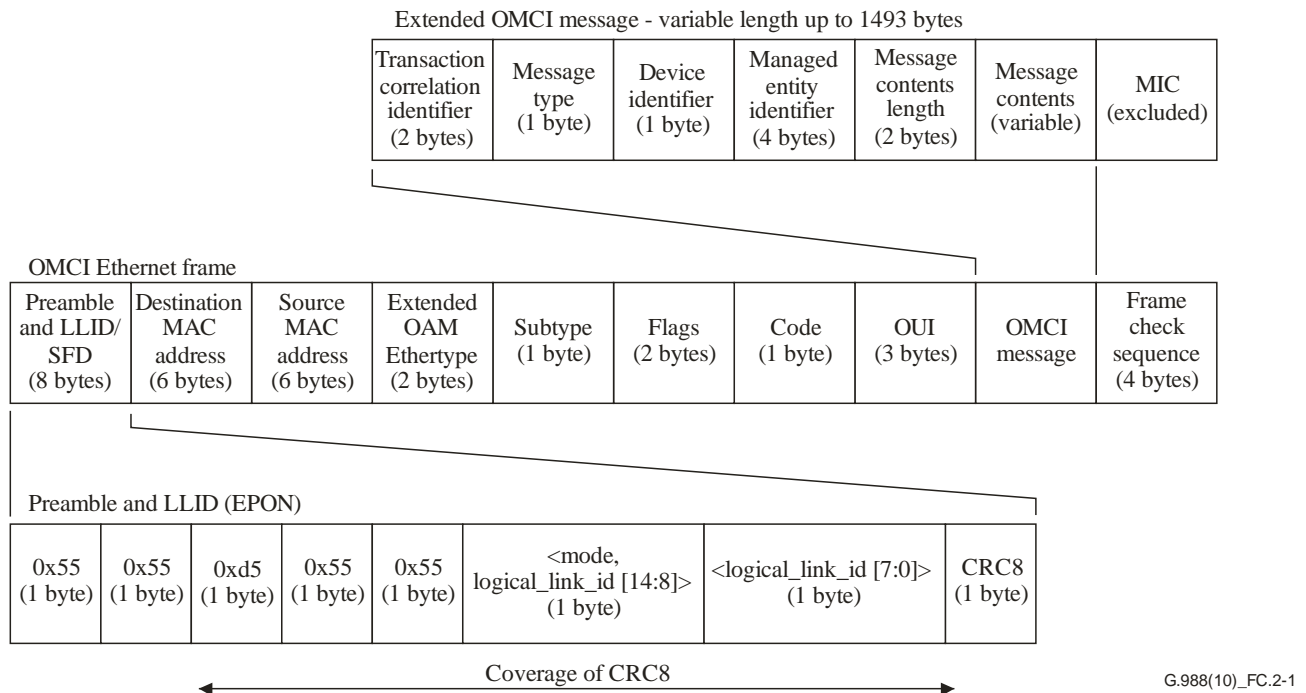

Figure C.2-1 – Extended OAM frame structure for EPON OMCI

The extended OAM frame format and fields for the OMCI are defined in Table C.2-1.

Table C.2-1 – Extended OAM frame format and fields for EPON OMCI

Field	Length	Definition	Value
Preamble and LLID/SFD	8 bytes	Defined in clause 4.2 and clause 76 of [IEEE 802.3]	LLID is assigned during ONU discovery process
Destination MAC address	6 bytes	Destination MAC address	0x0180C2000002
Source MAC address	6 bytes	Source MAC address	MAC address of source equipment
Ethertype	2 bytes	Clause 57 of [IEEE 802]	0x8809 (Slow protocol)
Subtype	1 byte	Clause 57 of [IEEE 802]	0x03 (OAM)
Flags	2 bytes	Clause 57 of [IEEE 802]	
Code	1 byte	Clause 57 of [IEEE 802]	0xFE
OUI	3 bytes	ITU-T OUI	0x0019A7
OMCI message	up to 1493 bytes	Defined in clauses 11 and A.2. Extended OMCI message Excludes MIC (4 bytes)	
Frame check sequence FCS	4 bytes	Defined in [IEEE 802.3]	

C.3 Relationship between the OMCI and OAM defined in clause 57 of [IEEE 802.3]

Clause 57 of [IEEE 802.3] describes OAM as an optional function. Items described in this clause can be covered by the OMCI. In most cases, an ITU-T G.988 support system does not need to support clause 57 of [IEEE 802.3] OAM; however, it is a system dependent matter.

Table C.3-1 – Relationship between clause 57 of [IEEE 802.3] OAM and OMCI

No.	Items in clause 57 of [IEEE 802.3]	Corresponding OMCI functionalities
1	Information	This item is the OAM channel set-up procedure. It is provided by the OMCC initial set-up procedures.
2	Event notification	This item is alarm notification. It is provided by the alarm notification function defined in the OMCI.
3	Variable request/response	This item can be interpreted as MIB get/set. The OMCI supports the same functions.
4	Loopback control	This item is provided by OMCI loopback control.

C.4 Adaptation of the G-PON information model to EPON

C.4.1 Overview

Table 8-1 lists the MEs that are mandatory or not applicable for EPON systems. Some MEs are redefined in this clause for use in EPON.

MEs on the ANI side were originally defined for the G-PON system architecture. In an EPON system, the PON framing protocol is different from G-PON or XG-PON. To adapt the OMCI to an EPON system, the following interpretations are required.

In EPON, GEM ports and T-CONTs are not defined, because EPON conveys Ethernet frames transparently in the PON section. However, these differences can be absorbed by the interpretation shown in Table C.4-1. On the other hand, the MEs on the UNI side are usable without modification.

Table C.4-1 – Interpretation of ANI-side MEs

No.	Items	Interpretation in EPON system
1	GEM port	The concept of GEM port is interpreted as a layer 2 flow, such as VLAN or CoS. In an EPON system, GEM port network CTP and GEM interworking termination point MEs exist for binding the layer 2 flows and priority queue MEs and the MAC bridge ME.
2	T-CONT	The T-CONT is the unit of bandwidth assignment. In an EPON system, the unit of bandwidth assignment is the logical link.

For providing an Ethernet service to users in a PON system,

- G-PON/XG-PON1: Ethernet flows are encapsulated by GEM/XGEM in the PON section.
- EPON/10G-EPON: Ethernet flows are transparently conveyed in the PON section.

Except for GEM encapsulation, there is no difference between G-PON and EPON. MEs on the UNI side are compatible in both systems. Both systems require QoS configuration, cross-connection, filtering, VLAN operation etc., for each layer 2 service flow.

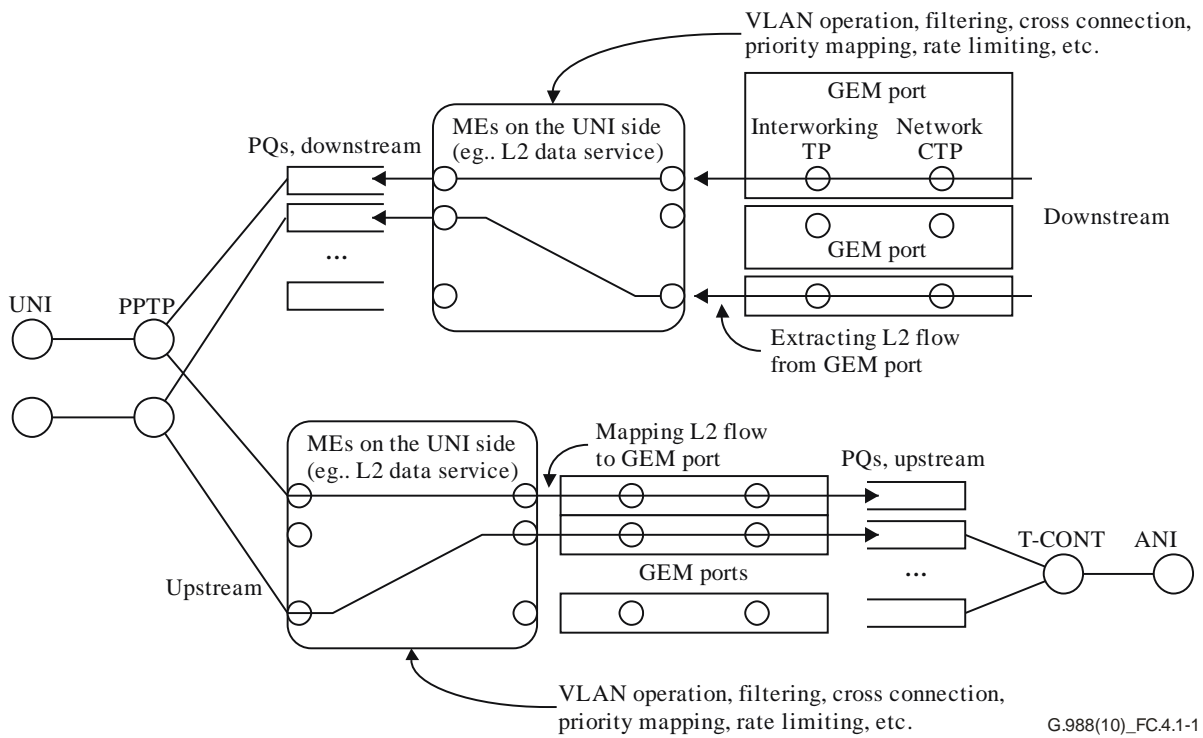

Figure C.4.1-1 – Layer 2 flows in G-PON ONU

By introducing the concept of a virtual GEM port into the OMCI, the MEs in this Recommendation can be re-used for EPON. In G-PON, a GEM port is defined to convey each layer 2 flow. The GEM port network CTP connects the MAC bridge port and upstream/downstream priority queues in the ONU for an Ethernet service. EPON requires the same configuration of connectivity between the MAC bridge port and upstream/downstream priority queues. By configuring the GEM ports virtually, G-PON and EPON are compatible in the OMCI. A virtual GEM port exists for the purpose of connecting the MAC bridge port and priority queue. GEM port network CTP and GEM IW TP MEs are created for the ME pointer relationship.

What this means is that the GEM port network CTP is re-used in EPON, but the value of the GEM port attribute is not used. It is suggested that it be set to 0 by the OLT, and it must be ignored by the ONU.

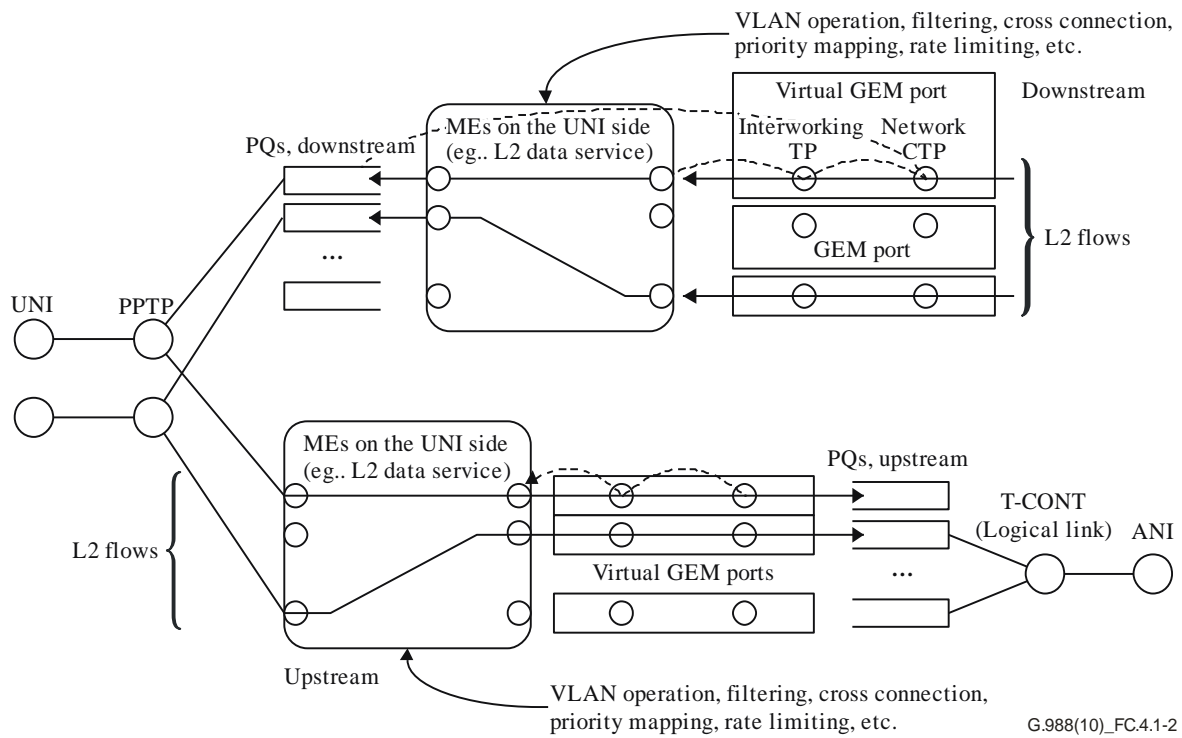

Figure C.4.1-2 – Virtual GEM ports in EPON ONU

C.4.2 ME definitions

This clause modifies certain MEs from their definitions in clause 9. Where no change is noted, the clause 9 definition remains applicable.

C.4.2.1 Clause 9.2.3: GEM port network CTP

This ME represents the termination of a GEM port on an ONU. In an EPON system, the GEM port exists virtually for keeping the pointer relationship. The value of the port-ID attribute is "don't care", because it does not represent an actual Port-ID. The optional attributes encryption state and encryption key ring are not used in an EPON system for the same reason.

Relationships

No change required.

Attributes

Table C.4.2.1-1 summarizes the attributes of the GEM port network CTP for EPON.

Table C.4.2.1-1 – Attributes of GEM port network CTP

Attributes	R/W, M/O	Definition changes in EPON
Managed entity ID	(R, set-by-create) (mandatory)	No change required.
Port-ID	(R, W, set-by-create) (mandatory)	Don't care. Recommended to be set to 0 by OLT. Must be ignored by ONU.
T-CONT pointer	(R, W, set-by-create) (mandatory)	T-CONT represents logical link in EPON.
Direction	(R, W, set-by-create) (mandatory)	No change required.
Traffic management pointer for upstream	(R, W, set-by-create) (mandatory)	No change required.

Table C.4.2.1-1 – Attributes of GEM port network CTP

Attributes	R/W, M/O	Definition changes in EPON
Traffic descriptor profile pointer for upstream	(R, W, set-by-create) (optional)	No change required.
UNI counter	(R) (optional)	No change required.
Priority queue pointer for downstream	(R, W, set-by-create) (mandatory)	No change required.
Encryption state	(R) (optional)	Not used.
Traffic descriptor profile pointer for downstream	(R, W, set-by-create) (optional)	No change required.
Encryption key ring	(R, W, set-by-create) (optional)	Not used.

Actions

No change required.

Notifications

End-to-end loss of continuity (optional) is not used in EPON.

C.4.2.2 Clause 9.2.4: GEM interworking termination point

An instance of this ME represents a point in the ONU where the IW of a bearer service (usually Ethernet) to the GEM layer takes place. In an EPON system, the GEM port exists virtually, only for keeping pointer relationships. IW option attribute values are limited because there is no actual IW function. The value of the GAL profile pointer is null because there is no GAL profile in EPON. Likewise, the value of GAL loopback configuration is always 0 (no loopback).

Relationships

No change required.

Attributes

Table C.4.2.2-1 summarizes the attributes of the GEM IW TP for EPON.

Table C.4.2.2-1 – Attributes of the GEM interworking termination point

Attributes	R/W, M/O	Definition changes in EPON
Managed entity ID	(R, set-by-create) (mandatory)	No change required.
GEM port network CTP connectivity pointer	(R, W, set-by-create) (mandatory)	No change required.
Interworking option	(R, W, set-by-create) (mandatory)	0 Reserved 1 MAC bridged LAN 2 Reserved 3 Reserved 4 Reserved 5 802.1p mapper 6 Downstream broadcast 7 Reserved

Table C.4.2.2-1 – Attributes of the GEM interworking termination point

Attributes	R/W, M/O	Definition changes in EPON
Service profile pointer	(R, W, set-by-create) (mandatory)	No change required.
Interworking termination point pointer	(R, W, set-by-create) (mandatory)	No change required.
PPTP counter	(R) (optional)	No change required.
Operational state	(R) (optional)	No change required.
GAL profile pointer	(R, W, set-by-create) (mandatory)	Not used. Set to 0 by OLT, ignored by ONU.
GAL loopback configuration	(R, W) (mandatory)	Fixed value 0x00 (No loopback)

Actions

No change required.

Notifications

No change required.

Appendix I

OMCI common services

(This appendix does not form an integral part of this Recommendation.)

This appendix describes the common services of the OMCI.

NOTE – Although this appendix describes capabilities that are intended to be common to any technology that employs the OMCI, some information in this appendix should be modified appropriately when applied to [ITU-T G.986].

Common services comprise:

- a) ONU MIB management;
- b) equipment management;
- c) software upgrade;
- d) performance monitoring.

These services are explained with the aid of scenario diagrams.

I.1 ONU MIB management

An ONU contains data known as an MIB that reflects its hardware configuration and whatever service provisioning may have been done.

Viewing an access system as a distributed system, it is important that the OLT retain its own view of the ONU, e.g., if the ONU needs to be replaced, and that the OLT's view remains synchronized with the ONU's own MIB.

The results of external events such as DHCP queries or adapting to subscriber interfaces are also visible via OMCI get commands or AVCs. The OLT is normally also interested in this transient information, but transient information synchronization is beyond the scope of this clause. In general, the OLT is expected to use a variety of techniques including AVCs, alarms, including indications from the TC layer, periodic retrievals, or features such as snooping of protocols (e.g., IGMP) for this information.

I.1.1 MIB discovery

I.1.1.1 OMCI capability report option

The OLT may discover the ONU's software capability and a summary of its existing provisioning by querying the two table attributes contained in the optional OMCI ME of clause 9.12.8, and the contents of the ME instances.

The OLT may obtain the ME types supported by the ONU through the ME type table attribute of the OMCI ME. The OLT may then obtain the MTs supported by the ONU through the MT attribute of the OMCI ME.

The OLT may obtain further details about the ONU's support for a given OMCI ME, as well as a summary of existing instances of that ME type by reading the ME for that ME. Refer to clause 9.12.9.

I.1.1.2 MIB upload

When an ONU initializes, it populates its MIB with information about its equipment configuration and restores any other inbuilt information. The ONU makes this MIB visible to the OLT. MIB population should occur before the ONU responds to discovery messages, so that the response to an MIB upload request reflects the current configuration of the ONU. This permits the OLT to discover the hardware and service configuration of the ONU by analysing the uploaded MIB.

I.1.2 MIB data sync

I.1.2.1 MIB data sync attribute

It is essential to the correct operation of the composite access system to keep the MIB synchronized between the OLT and ONU. The generic tool to achieve this is the MIB data sync attribute of the ONU data ME. The MIB data sync attribute is an 8 bit sequence number. When auditing the ONU's MIB, the OLT requests this sequence number. If the ONU's sequence number is equal to the sequence number in the OLT, the OLT may decide that no further action is needed, as the copy of the MIB in the ONU and the copy in the OLT are likely to be identical. However, the MIB data sync attribute does not reflect the state of the entire MIB, so it is important to understand its operation.

I.1.2.2 MIB data sync operation

The MIB data sync attribute is incremented for the creation and deletion of ME instances that are the consequences of commands by the OLT. The MIB data sync counter is also incremented for changes in attribute values that are the consequences of commands by the OLT (Figure I.1.2.2-1). The MIB data sync counter is incremented once per executed command, not once per changed attribute. This includes the modification of the MIB data sync counter attribute itself via a set command from the OLT. Therefore, a set of the MIB data sync counter to the value N results in an MIB data sync counter value of $N + 1$ after completion of the set command.

A set action can include several attributes, some of which may result in changes to the ONU's MIB, and others which may fail. MIB sync is updated if and only if the ONU's MIB changes, i.e., if any of the attributes are modified. This rule is not intended to establish a policy on all-or-nothing transaction semantics, which is beyond the scope of this Recommendation.

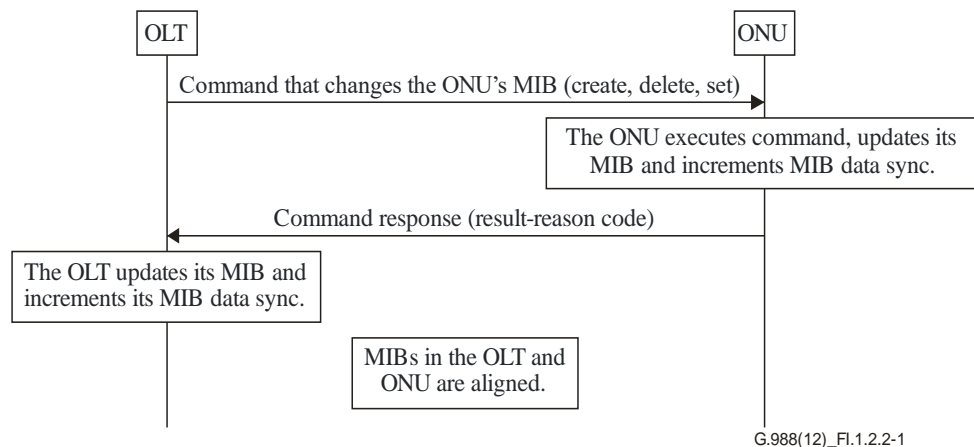

Figure I.1.2.2-1 – Increment of MIB data sync at the ONU and OLT under OLT command

In contrast, the MIB data sync counter is not incremented for autonomous creation and deletion of ME instances by the ONU itself, nor is the MIB data sync counter incremented for autonomous changes to attributes of MEs within the ONU (Figure I.1.2.2-2).

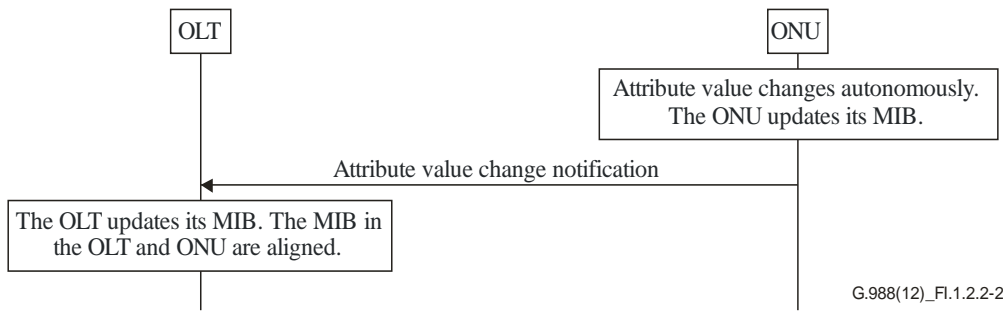

Figure I.1.2.2-2 – No increment of MIB data sync at the ONU and OLT

If the ONU is offline when the OS sends a command (create/delete/set), the OLT updates its MIB locally and increments its MIB data sync, but it cannot send the command to the ONU. The incremented OLT MIB data sync value guarantees that when the ONU comes online, the MIB audit will fail. This mechanism also forces audit and reconciliation when an ONU is replaced.

The order in which the OLT and the ONU update their MIBs and increment the MIB data sync attribute is not specified. Regardless of the order chosen, both the OLT and the ONU must locally update their MIBs and increment their MIB data syncs as atomic actions. It is considered good practice for the OLT not to increment its MIB data sync counter until it has received a positive AK to the command that it sent to the ONU.

When incremented, the sequence number that follows 255 is 1. Zero is reserved for the following cases:

- 1) default MIB with which the ONU left the factory;
- 2) an ONU which after initialization cannot restore its MIB.

In other words, a sequence number of 0 indicates that the ONU's MIB is not well defined or that it does not contain service provisioning and therefore requires configuration or reconfiguration.

I.1.2.3 Loss of MIB synchronization

In the process of an OLT modifying the MIB in an ONU, the MIB at the OLT could fall out of synchronization with the MIB at the ONU. Figure I.1.2.3-1 shows one possible scenario for this.

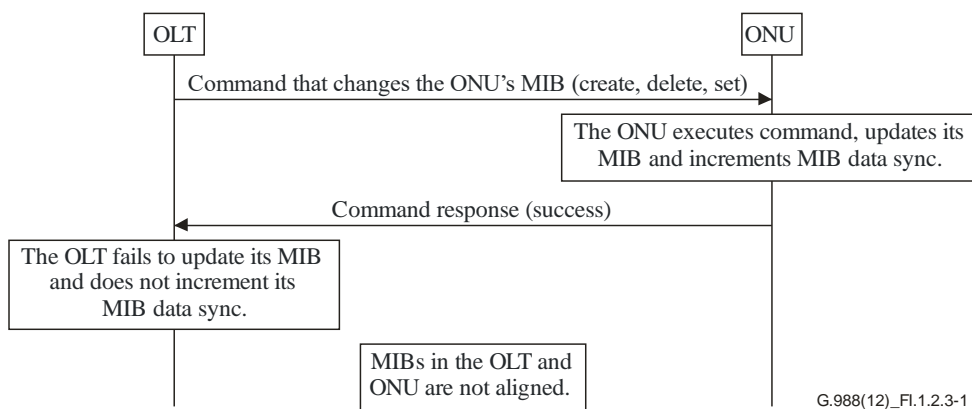

Figure I.1.2.3-1 – Mismatch of MIBs at the ONU and OLT under OLT command

Figure I.1.2.3-2 illustrates an autonomous change at the ONU, whose AVC is not received by the OLT. Normally, this information is transient and is not part of the MIB as strictly defined, but it must be recognized that the OLT no longer has a correct view of the ONU's current state. Periodic scans of ONU information are therefore encouraged.

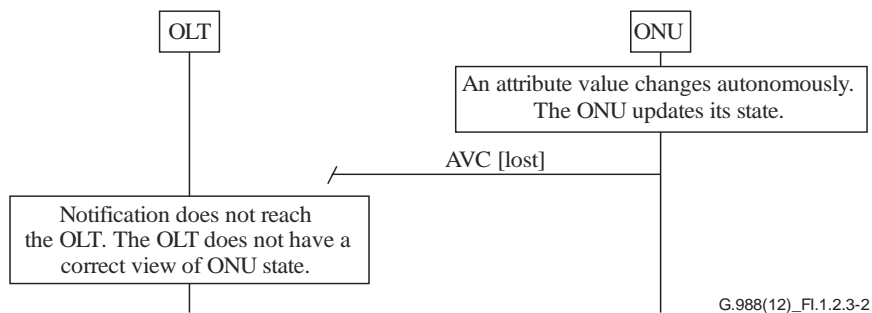

Figure I.1.2.3-2 – Lost AVC

I.1.3 MIB audit and resynchronization

I.1.3.1 MIB audit

The ONU is audited with respect to its MIB in three cases:

- 1) on loss and re-establishment of the OMCC;
- 2) periodically, based on the operator's requirements;
- 3) on demand of an OS.

On detecting a newly installed ONU, regardless of the sequence number of its MIB, the OLT will directly perform a MIB reset and the new-ONU bring up procedure (clause I.1.4.1). Figure I.1.3.1-1 is the scenario diagram of a MIB audit that uncovers no problems.

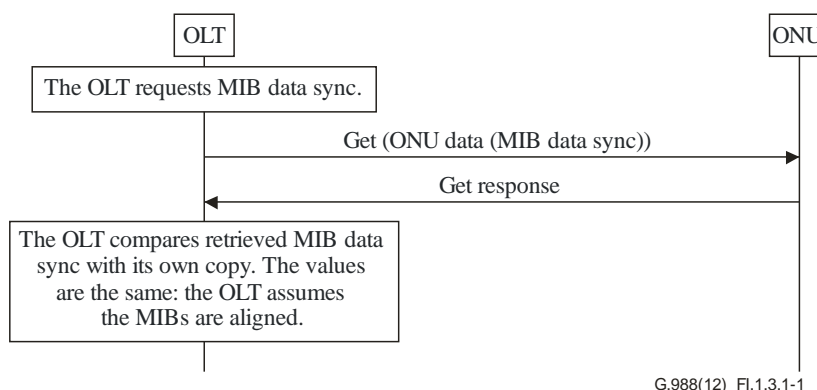

Figure I.1.3.1-1 – MIB audit

I.1.3.2 MIB resynchronization

Since the MIB data sync attribute does not reflect the status of the entire MIB, it is considered good practice for the OLT to periodically perform a MIB resynchronization regardless of the outcome of an MIB audit. The OLT may repair the MIB incrementally, as illustrated in Figure I.1.3.2-1, or it may choose to simply reset the MIB and rebuild it from scratch.

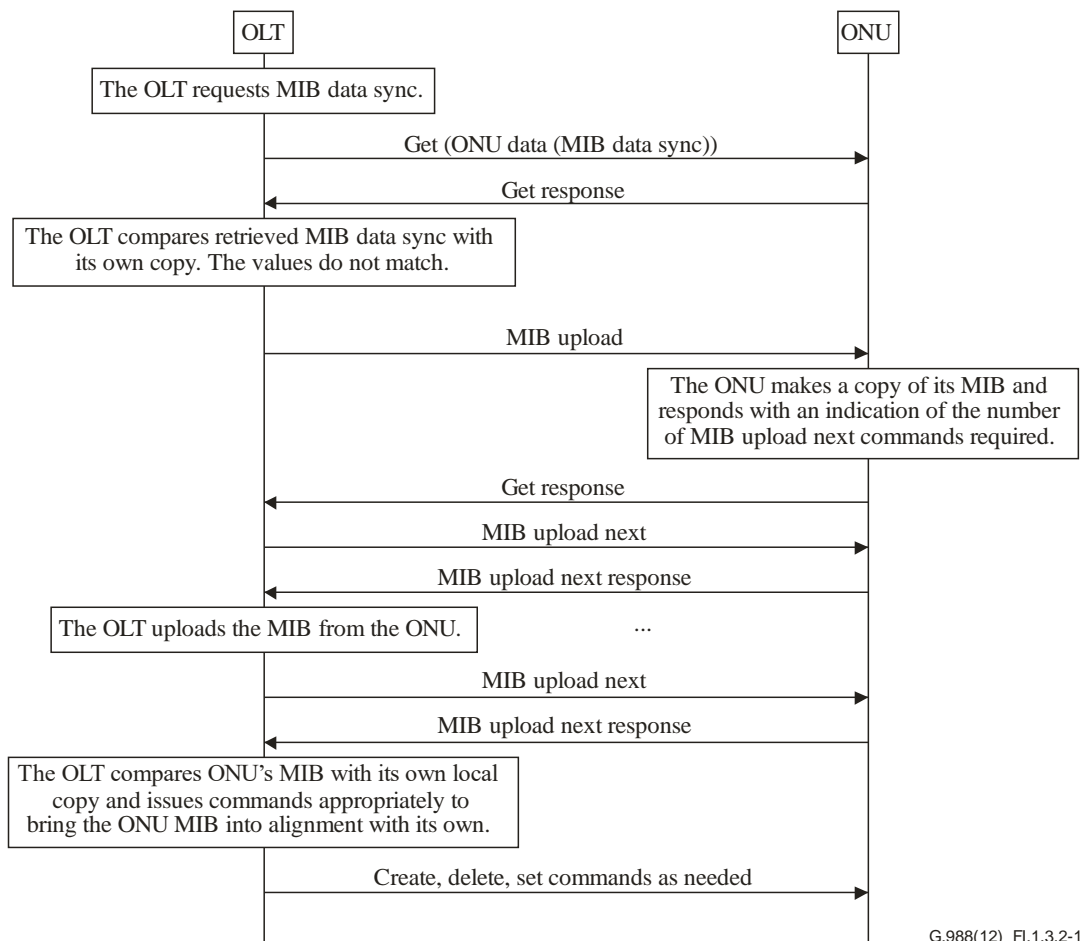

Figure I.1.3.2-1 – MIB resynchronization

The OLT must issue as many MIB upload next requests as the number of commands given in the MIB upload response. The maximum time between two MIB upload next requests is 1 min. If the OLT does not send an MIB upload next request within this time after the previous MIB upload next request or after the MIB upload start request, the ONU assumes the MIB upload to be terminated. The ONU can drop its copy of the MIB, and consider any further MIB upload next requests to be invalid.

MIB upload returns all attributes of most MEs, including those that reflect transient information. MIB upload is therefore a valid way for the OLT to synchronize much transient information, as well as data of long-term interest. However, certain MEs are excluded from the MIB upload. In particular, instances of some general purpose MEs, such as theME and the attribute ME, are not included in an MIB upload. Table attributes are never included in an MIB upload. If the OLT requires this information, it obtains it on a per table basis through the use of the get/get next mechanism. And finally, the measurement attributes of PM MEs are not included in MIB uploads.

As the final step of MIB resynchronization, the OLT sets the MIB data sync attribute of the ONU data ME to some suitable value of its own choice. It then sets its own record of the same attribute to the same value, incremented by 1, as explained in clause I.1.2.2.

I.1.4 Bringing up ONUs

ONU bring-up may be separated into two classes: new ONU bring-up and old ONU bring-up. The definition of new versus old ONU is based on the status of the ONU as viewed by the OLT.

New ONU: The ONU has never completed MIB synchronization with the OLT. Some examples follow.

- 1) The ONU has never been connected to the OLT, and the OLT has never recorded its serial number. This could arise during initial installation or replacement of an ONU.
- 2) The ONU has been connected to the OLT but the OLT did not assign a management layer ONU-ID to it. This could happen if an ONU is auto-discovered but has not been provisioned for service.

NOTE – A TC layer ONU-ID is a precondition of successful transition into state O5. The TC layer ONU-ID is not necessarily the same as the management layer ONU-ID, nor is it necessarily stable from one activation lifetime to another. The management layer ONU-ID is the name by which an ONU is visible from a service and maintenance point of view, and normally persists for the lifetime of a service endpoint, even across the possible replacement of physical ONUs.

- 3) The ONU has been provisioned but later de-provisioned by an OS. That is, its management layer ONU-ID has been de-assigned from the OLT.

Old ONU: The ONU has been connected to the OLT, it has been assigned a management layer ONU-ID, and has completed MIB synchronization at least once. The OLT has a non-trivial MIB for this ONU and needs to confirm during bring-up that the ONU's MIB matches its own.

I.1.4.1 Old ONU bring-up

After the ONU powers up and begins execution of a valid software image, it automatically creates an MIB. Refer to the respective TC layer specification for a detailed explanation of state transitions during the activation process.

Once the ONU enters operation state O5 after activation, the OLT creates the OMCC as described in clause B.1. As described in clause I.1.3.1, the OLT then retrieves the ONU MIB data sync value by sending a get (ONU data (MIB data sync)) message to the ONU. The OLT compares the received MIB data sync attribute value to the OLT's own MIB data sync value for that ONU. The result of the comparison leads to three possible ONU bring-up scenarios as follows.

- If the ONU's MIB data sync value matches the OLT's value, and is not zero, the OLT may assume that their MIBs are in alignment. The ONU bring-up process is complete.
NOTE – The OLT ultimately makes the choice between trusting MIB sync match – which is not a guarantee – and resynchronizing the MIBs in detail. The OLT also has the choice to reset the MIB and rebuild it from scratch or to audit and repair it incrementally.
- If the ONU's MIB data sync value equals zero, possibly the result of an ONU software upgrade or because the ONU considers its MIB to be invalid, the OLT follows the bring-up sequence described for a new ONU (clause I.1.4.2).
- If the ONU's MIB data sync value does not match the OLT's value, the OLT executes the MIB synchronization process, as described in clause I.1.3.2. Once the OLT has provisioned the ONU's MIB, it must align MIB data sync values. The OLT completes the bring-up process by sending a set (ONU data (MIB data sync)) command.

I.1.4.2 New ONU bring-up

The bring-up process for a new ONU is shown in Figure I.1.4.2-1. Initially, the OLT sets the ONU MIB to its default state by sending an MIB reset to the ONU. The ONU re-initializes its MIB to the default and resets the MIB data sync attribute to zero. Next, the OLT uploads the ONU's MIB to retrieve all ME instances and capabilities. The OLT then issues create, delete and set commands to bring the ONU's MIB into sync with the OLT's MIB.

NOTE – The details of initialization may differ in other (non-G-PON) access technologies.

When an ONU changes an attribute value autonomously, it sends an AVC message to the OLT. The ONU can send AVCs during the MIB synchronization or MIB download processes. AVCs should be viewed as a partial method of ONU state discovery. Not all MEs or attributes issue AVCs, and an

AVC message can be lost in transmission without an error being detected. Therefore, the OLT should audit the ONU state immediately after a reset has been completed.

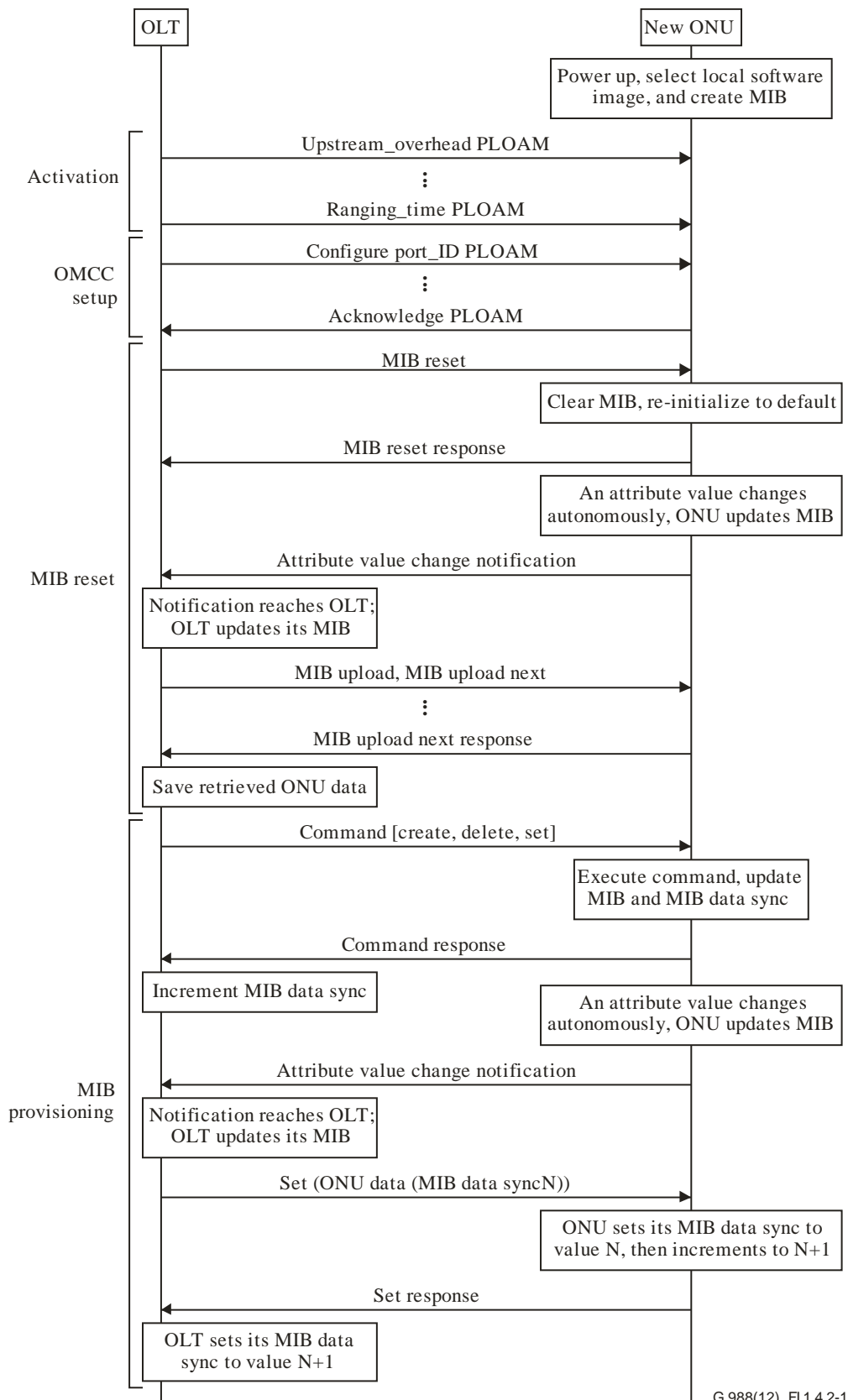

G.988(12)_Fl.1.4.2-1

Figure I.1.4.2-1 – New ONU bring-up

I.2 Equipment management

I.2.1 Slot-port model

ONU equipment management is modelled on a three-level hierarchy: the chassis (the ONU itself), cardholders (also known as slots), which may contain circuit packs of varying types over the course of time, and ports, which present external interfaces either to the subscriber, to the PON or to a local management tool. Many OMCI MEs are addressed in accordance with the slot-port model. Ports – the PPTP group of MEs – would be expected to follow this model, but the T-CONT, MAC bridge service profile and traffic scheduler are also modelled by slot, if not by port.

All ONUs must therefore adhere to at least a minimal slot-port model. An integrated ONU is represented as a virtual chassis containing virtual cardholders. There are three ways in which this may be done.

- 1) Several virtual cardholders may be defined, one for each interface type. This was the original model and is the most common. The more significant byte of the ME ID of a virtual cardholder has the value 1; a real cardholder has the value 0. In both cases, the slot number (actual or virtual) is the value of the less significant byte.
- 2) A single virtual cardholder may be defined as slot 0 (LS byte), and all interfaces may be represented through the port-mapping package ME, which maps ports of arbitrary types in arbitrary combinations. The port-mapping package has the merit that it is universally applicable to integrated and chassis-based ONUs equipped with any type of real or virtual circuit pack, but for historical reasons, it is commonly used only when it is the only choice: a chassis-based ONU that contains circuit packs with mixed port types.
- 3) The port-mapping package may be contained by the ONU directly, rather than by a virtual cardholder. This approach has the merit that it avoids a virtual cardholder that serves no real purpose, and the disadvantage that it applies only to integrated ONUs. It is unlikely to appear in actual practice.

In the original model, real or virtual slot numbering was segregated by PON-side (128 up) vs subscriber-side (127 down). Although this constraint is no longer specified – it was unsatisfactory for real chassis with real slots, as well as mixed-function circuit packs – some virtual-slot implementations continue to follow this convention for historical reasons.

In addition, the two MSBs of the slot address are available to designate xDSL bearer channels when desired. While this violates orthogonality, it poses fewer problems in practice than in theory, since a space of 64 slots more than suffices for real or virtual cardholders. Best practice would indicate that slot numbers be unique within their 6 LSBs, particularly if there is any possibility that xDSL bearer channels may need to be modelled.

As to port addressing, the original model specified ports numbered in increasing order, left to right, bottom to top, but this was inappropriate both for three-dimensional ONU packages with mixed ports of all types on several surfaces or edges and for chassis-based ONUs with service connections through the backplane rather than on circuit pack faceplates. Today, port addresses are expected only to start with 1 and to be unique. Small numbers in a contiguous sequence are preferred.

Finally, it is worth mentioning that nothing actually prohibits mixing port types on any card type, without benefit of the port-mapping package. The combined video UNI and PON type (code point 44) even explicitly allows for differing port types. No convention exists for the numbering of such ports, configuration discovery is likely to be a problem and best practice would avoid this option.

I.2.2 The chassis-based ONU

The original slot-port model was, and is, arguably adequate for integrated ONUs, where it is easy to create as many virtual cardholders as may be desirable. For chassis-based ONUs, however, a number of difficulties arise.

- The model does not readily accommodate the richness of possible service interfaces. Table 9.1.5-1 defines circuit pack types, with an eye to listing all possibilities, but it does not scale well. As an example, the long list of VF specials is not presently represented. See also the next two list entries.
- The model does not adequately represent common equipment, circuit packs with no external ports at all, for example, power supply packs. This Recommendation includes a single code point for common equipment; it does not distinguish different types of common equipment.
- It has no way to flexibly model equipment with a combination of interfaces, e.g., a single circuit pack with a PON interface, a craft port and an RF video port (code point 44 includes PON and RF video, but not craft). Code point 45 is defined for multi-function packs; it does not distinguish different types of multi-function packs. As mentioned above, port numbering conventions are undefined, except by way of the port-mapping package.
- There were ambiguities in the original plug-in unit type definitions of [ITU-T G.984.4], specifically between the possible mixes of 10/100/1000 Mbit/s Ethernet and its physical media. The ambiguity was resolved with a compromise, but existing implementations must be regarded with caution.
- The original model could not distinguish between two Ethernet packs, e.g., with four ports on one and eight on the other. Port count attributes were added as a patch, but they do not address the reality that both operators and vendors are likely to manage real equipment inventory by a code (CLEI, for example, or vendor product name/number), rather than simply by generic type.

The integrated ONU was first to be developed, so the issues aforementioned were not immediately apparent. Various extensions have been added to the equipment model to address these concerns, as discussed in the following.

While the generic circuit pack types of Table 9.1.5-1 arguably suffice for the integrated ONU, it is recommended that the chassis-based ONU use the equipment ID attributes as its primary means to identify equipment options. Equipment ID is also the preferred way to identify an integrated ONU for inventory purposes.

In Table 9.1.5-1, a small range of equipment types is reserved for vendor-specific assignment. Vendor-specific code points would seem to introduce interoperability issues, but they are in principle no worse than equipment ID as an identifier: the OLT and EMS must have *a priori* knowledge of the meaning and characteristics of whatever identifiers are used, presumably through business agreements and information exchange between the vendors concerned.

1.2.3 Dynamic behaviour

1.2.3.1 ONU initialization: the ONU's view

When an ONU initializes, it populates its MIB with information about its equipment configuration. The Recommendations are written as if the ONU discovers this information for itself when it comes to life. This may be the case, but it is also possible that an ONU, especially an integrated ONU, may be equipped with a basic MIB at the factory, in which case initialization may comprise merely copying the MIB into a working store and discovering only options that may have changed after the last shutdown and prior to the current initialization.

If it exists, the non-volatile MIB image used as the initialization reference for a chassis-based ONU may be populated with circuit pack types or equipment IDs, either by factory predetermination or from prior operation of the ONU. This equipment may or may not be present during the current initialization. Whether there is a non-volatile MIB or not, the ONU must actually perform some level of self-discovery to determine what, if anything, exists in its cardholders.

The ONU is specified to issue AVCs or alarms when it discovers circuit packs or when it discovers that a circuit pack that was recorded in its non-volatile MIB (if there is one) is no longer present or no longer has the same type or equipment ID. However, it is recommended that ONU initialization occur before the ONU is activated on the PON, so transmission of AVCs and alarms is not possible. Queueing of notifications for future delivery is not specified, so the OLT must audit the connected equipment when the ONU re-ranges.

If there are mismatches between an ONU's actual equipped configuration and its (possible) non-volatile MIB, the ONU should declare alarms as appropriate and should not attempt to bring the mismatched circuit packs into service.

I.2.3.2 ONU initialization: the OLT view

When the OLT activates an ONU, the OLT either has an MIB that corresponds to that ONU or it does not.

If the OLT does not have an MIB for that particular ONU already, it uploads the ONU's MIB as a starting point. Subsequent operation and provisioning is recorded both in the ONU's MIB and in the OLT's functional duplicate. AVCs from the ONU alert the OLT to changes that could occur from external causes such as craft removal or the installation of circuit packs. An AVC triggers the OLT to update its view of the ONU. The details of such an update are beyond the scope of this Recommendation.

When it activates the ONU, the OLT may already have an MIB (or database functional equivalent) for a particular ONU, either because the ONU has been pre-provisioned or because the ONU has previously been active on the PON. The initialization requirements are the same in either case.

Assuming that the OLT has an MIB for this particular ONU, an audit is necessary once activation is complete as part of service (re-)activation. The ONU is responsible for knowing its current equipment configuration, which must be reconciled by the OLT. The OLT, on the other hand, is responsible for knowing all provisioned information, and to ensure that, once initialization is complete, the ONU is provisioned accordingly. The OLT should declare alarms or events towards an EMS if the configuration has changed unexpectedly or provisioning reconciliation fails.

I.2.3.3 Circuit pack provisioning

Clause I.2.3.2 discusses ONU initialization. This clause discusses the dynamics of circuit pack provisioning, installation and removal for an ONU that is active on the PON. It assumes a chassis-based ONU: changes to (virtual) circuit packs should not occur on integrated ONUs. An integrated ONU should deny attempts to provision cardholder and circuit pack attributes that are in fact immutable, even if their OMCI definitions indicate that they have write or set-by-create semantics.

The ONU is sensitive to four events in this context, each of which has a number of use cases. Each event is discussed in clauses I.2.3.3.1 to I.2.3.3.4.

- 1) A circuit pack is provisioned into a cardholder.
- 2) A cardholder is de-provisioned.
- 3) A circuit pack is physically inserted into a cardholder.
- 4) A circuit pack is physically extracted from a cardholder.

I.2.3.3.1 Circuit pack provisioned into a cardholder

This event comprises the change of any of the writable attributes of the cardholder, except setting the expected plug-in unit type to 0, which is covered in I.2.3.3.2. If the expected plug-in unit type is 0, all of the other attributes of the cardholder may be freely altered without generating a provisioning event or affecting the ONU's state or its alarms. That is, the ONU's expectation of the presence or absence of a circuit pack is based entirely on the non-zero value of the expected plug-in unit type attribute.

If the cardholder is empty at the time of provisioning, the ONU can, and should, confirm that all attributes are consistent within the scope of its knowledge. That is, if either or both the expected port count and expected equipment ID are also provisioned, either in the same set command or separately, the combination of attributes must be consistent with the expected plug-in unit type. An Ethernet pack CLEI, for example, should be denied in the expected equipment ID attribute if the expected plug-in unit type is xDSL. Likewise, if the only Ethernet packs supported by the ONU have four ports, the ONU should deny an attempt to pre-provision an Ethernet slot with eight ports. Expected plug-in unit type code-point 255 (plug-and-play) is a "don't care" case in terms of consistency checking, but the remaining attributes must still be mutually consistent and known to the ONU.

Assuming the provisioning event succeeds, the cardholder immediately declares the plug-in line interface module (LIM) missing alarm. If a standing alarm is undesirable, the alarm may be suppressed with an ARC. The ONU should then instantiate a circuit pack ME, though it may be only an empty husk if insufficient information is provided (plug-and-play case).

It is possible that the provisioning command does not unambiguously define the equipment. For example, an ONU may support both a four-port and an eight-port Ethernet pack. If pre-provisioning merely calls out an Ethernet pack in such an example, best practice suggests that the ONU create an empty husk circuit pack ME. It is also acceptable for the ONU to deny the provisioning command, but creating four ports now and possibly four more ports later is discouraged.

Given enough information about type, port count and equipment ID, the ONU now creates a fully populated circuit pack ME, along with a suitable number of PPTP or ANI-G MEs, and any other MEs known to be appropriate to the configuration, e.g., a port-mapping package ME, an equipment extension package or a protection data ME, software images, traffic shapers or T-CONTs. From this enhanced MIB, the ONU is prepared to accept pre-provisioning of services. Service pre-provisioning should be denied if an empty husk circuit pack ME was created.

If the cardholder is occupied at the time of provisioning, the provisioning action may either create a mismatch with the existing circuit pack or resolve a mismatch.

Provisioning creates a mismatch if it sets the expected plug-in unit type to any value other than 0, to 255 (plug-and-play) or to the actual type. Provisioning creates a mismatch if it sets the expected equipment ID to any value other than all spaces, or to the actual equipment ID. Provisioning creates a mismatch if it sets the expected port count to any value other than 0 or to the actual port count. The ONU declares an alarm for a type or equipment ID mismatch. No alarm is defined for expected port count mismatch; rather the ONU should deny a provisioning command that attempts to create such a mismatch. The ONU should take no additional action upon mismatch creation. For example, if service is in fact running on existing hardware, it should be left in place. (However, service would not be restored to a mismatch after ONU initialization, because the ONU would have no independent record of the prior configuration.)

If the cardholder was in mismatch before the provisioning action, the mismatch is resolved if all of the following are true.

- The expected plug-in unit type is provisioned to the actual plug-in unit type. If the ONU supports plug-and-play, code point 255 also resolves a mismatch.
- The expected port count is provisioned either to 0 or to the actual port count.
- The expected equipment ID is provisioned either to the actual equipment ID or to a string of all spaces.

The ONU should clear any alarms that may have been declared as a consequence of the mismatch state. It should also initialize (or complete the initialization of) the physical circuit pack, up to and including bringing up any services that may be provisioned on to it.

I.2.3.3.2 Cardholder de-provisioned

This event occurs when the cardholder's expected type is set to 0. If it was already 0, this is a no-op. The ONU should delete all associated MEs (see the list and foregoing examples), and clear any alarms associated with the equipment. It is an error for the OLT to de-provision equipment without first de-provisioning all services that depend on the equipment, and while ONU robustness is encouraged, the ONU's behaviour is undefined, up to and including the possibility that orphan or conflicting MEs may be left behind in the MIB, and nothing less than an MIB reset can recover.

If the cardholder is populated with a circuit pack at the time of de-provisioning, the ONU should place it in an inactive holding pattern, awaiting extraction or re-provisioning. The holding pattern state implies no user services; provisioning and test commands should be denied, alarms should be cleared and no new ones generated, and ports and preferably the entire circuit pack should be powered down. ONU initialization from this state should initiate the sequence that occurs when a circuit pack is inserted into an unprovisioned slot.

I.2.3.3.3 Circuit pack physically inserted into a cardholder

The two cases to consider in this event are distinguished by whether the circuit pack ME already exists. The common cases are the installation of new packs and the replacement of defective packs. In the normal course of events, a circuit pack ME exists before either of these events.

If the cardholder is provisioned with an expected plug-in unit type, then a circuit pack ME exists, either of the specified type or of type 255, signifying unknown. When the actual circuit pack appears, the ONU updates the circuit pack ME with actual values from the equipment. If the appearance of the circuit pack resolves ambiguous provisioning, e.g., as a plug-and-play circuit pack, this is the point at which the ONU creates the subordinate MEs mentioned above: PPTPs, software images, etc.

NOTE 1 – The OMCI does not define AVCs for changes to normally immutable attributes that may in fact change during this process. The OLT should use the AVC on the cardholder actual type and actual equipment ID to trigger a query of all cardholder and circuit pack attributes.

The appearance of a circuit pack either triggers a mismatch, in accordance with the mismatch discussion above, or it does not. If there is no mismatch, the ONU continues initialization and bring-up of the circuit pack and services. If there is a mismatch, the ONU declares a mismatch alarm through the cardholder ME. No alarm is defined for a mismatch of port count.

Most, if not all, PPTPs (ports) include an optional operational state ME. Among other circumstances, this attribute should have the value *disabled* when the pack is not present. Operational state should change to *enabled*, and be reported via an AVC, when the port successfully enters service. Within the scope of a current OMCI, the failure to receive an AVC on the port is the only notification the OLT has of port mismatch.

If the circuit pack ME does not already exist, the ONU should instantiate it upon pack insertion. The ONU should populate the attributes of the circuit pack from the equipment itself, and report them to the OLT via AVCs from the cardholder.

NOTE 2 – The OMCI does not define AVCs for changes to all attributes that may change during this process. The OLT should use the AVC on the cardholder actual type and actual equipment ID to trigger a query of all cardholder and circuit pack attributes.

The ONU should instantiate the complete set of PPTP/ANI MEs, port.mapping packages, etc., as previously described. If the pack and ports pass self-test, each should report an AVC when its operational state becomes *enabled*.

The absence of the circuit pack ME *a priori* guarantees that no additional pre-provisioned information exists in the MIB, except possibly in the de-provisioned corner case previously discussed, in which the ONU's behaviour is undefined.

I.2.3.3.4 Circuit pack physically extracted from a cardholder

The most common cause of this event is the replacement of a defective circuit pack. When the old circuit pack is extracted, the event may trigger additional alarms – the circuit pack and some or all of the services are likely already in alarm – such as cardholder improper removal. No MEs are deleted as the consequence of this event; MEs are only destroyed through de-provisioning.

Replacing the defective pack with a like pack follows the normal sequence of events: the pack is initialized, no MIB changes are necessary and services are restored. Replacing the pack with an incompatible pack triggers mismatch behaviour as described in I.2.3.3.3. Replacing the pack with a functionally similar pack (e.g., different CLEI, same capabilities) may or may not be accepted by the ONU, depending on its built-in knowledge of equipment compatibilities.

Less common is the removal of a circuit pack, either to leave the slot unpopulated or to reuse it for other purposes. It is recommended that services first be de-provisioned and then the cardholder be de-provisioned before the circuit pack is extracted, but if the pack is extracted first, it is treated exactly as if it were simply being replaced with another pack of the same type.

I.2.3.4 MIB sanity

Regardless of the flows previously described, it is always allowed and encouraged for an ONU to deny provisioning actions that create MIB inconsistencies.

I.2.4 Protection

Two kinds of protection can be supported within the OMCI model: ANI (PON) protection; and equipment protection. Vendor-interoperable protection has not been widely deployed as yet; in the absence of real-world experience, some aspects of its operation doubtless remain for further study.

The model for PON protection assumes two ANI MEs, which would presumably reside on separate circuit packs. The protection data ME coordinates the two ANIs and specifies various attributes of the protection group. PON protection handshaking is based on SDH K bytes. If more than LOS-based single-ended protection were to be supported, further work would likely be needed to rationalize the details of K-byte protection with G-PON.

The model for equipment protection is exemplified by a chassis-based ONU with DS1 circuit packs, in which one or two circuit packs protect up to eight working packs. Protection of this nature is likely to be built into the backplane or cabling of the ONU; protection packs may or may not be the same as the working packs. This function is supported by the equipment protection profile ME. Equipment protection can be manually invoked through an attribute of the working cardholder ME.

Subscriber facility protection, for example 1 + 1 protection of 155 Mbit/s drops, is not presently supported by the OMCI.

I.2.5 Environmental inputs and outputs

The OMCI provides an equipment extension package that may be associated either with an ONU or a cardholder to provide external sense or control points. The conceptual model is of equipment able to detect external contact closures, and report either a closed or an open contact as an off-normal event. Rectifier plant alarms may be reported with this mechanism, for example. The semantics of these alarms are undefined to the OMCI and the ONU, and must be interpreted at the OLT or EMS level.

Where the ONU structure is hard-wired for particular alarms that are already defined in the OMCI, the hard-wired alarms should be reported in preference to the general-purpose capabilities of the equipment extension package. For example, a physical intrusion alarm can be declared by the ONU-G, and is preferred, as long as no ONU provisioning is needed to associate the alarm with a specific input point. Likewise, existing battery alarms, declared by the ONU-G ME, are preferred where they convey the correct semantics and require no provisioning.

The equipment extension package ME also allows for external control points to be activated or released.

I.2.6 Managed entity analysis

This clause discusses MEs and attributes of interest. It is not a complete list of all concerned MEs or their characteristics; it represents those for which commentary is appropriate.

I.2.6.1 ONU-G, ONU2-G

These MEs define attributes, actions and notifications that conceptually pertain to the ONU as a whole equipment unit. When the ONU is implemented as integrated equipment, no issues arise. This clause describes the common attributes, actions and notifications for the chassis-based ONU.

Attributes

Vendor ID, version, serial number, vendor product code (RO) – These attributes may not exist for the chassis *per se*. Their values may be taken from a controller pack, and may require re-provisioning or re-learning if a controller pack is replaced.

Traffic management option (RO) – Report the value from the pack that implements traffic management. In most cases, this would be the controller pack.

Battery backup [read, write (RW)] – The integrated ONU should proxy this value on behalf of the pack that implements battery monitoring unless explicit provisioning is required, in which case the external sense points of the equipment extension ME should be used instead. If the ONU/ONU has no capability to monitor battery-related states, it should deny an attempt to enable battery monitoring.

Admin state (RW) – Administrative lock at the ONU level should disable all subscriber services on all ports of all circuit packs, and suppress all alarms, as well as powering down as much as possible, consistent with continued craft and PON access.

Operational state (RO) – Operational state indicates whether the ONU in its entirety is capable of performing some (vs none) of its functions. In accordance with the state model of [ITU-T X.731], the ONU should report its operational state as *disabled* only if all of its ports are out of service for autonomous reasons (e.g., failure or circuit pack extraction). At the ONU level, this information is not very useful because operational state is an optional attribute, it may be omitted.

Equipment ID (RO) – The equipment ID string is 20 characters, typically long enough for two informative fields. It is recommended that the primary information field be left justified in the equipment ID attribute, e.g., a CLEI code in markets that use this identifier. If a second identifier (e.g., vendor product designator) is desired, it is recommended that it be right-justified in the equipment ID attribute, with spaces padding the gap in the centre. Although this information may be provided by the controller pack rather than the backplane, it is quite likely to differ from the corresponding equipment ID attribute of the controller circuit pack, since it represents the ONU, rather than the circuit pack.

OMCC version (RO) – This attribute indicates the OMCI version supported by the ONU as an entirety, and should be reported as the most primitive version, considering all software residing on all circuit packs.

NOTE – For historical reasons, an implementation may report 0x80, even though it actually supports a more recent version of the OMCI.

Total priority queue number, total traffic scheduler number (RO) – These attributes are defined to be the count of queues (schedulers) not associated with a specific circuit pack. The chassis-based ONU should report these on behalf of the controller (or traffic management) circuit pack, if a specific pack provides these functions. It is also acceptable to report these values as 0, and to report values for individual packs instead.

Total GEM port-ID number (RO) – This attribute should be reported for the ONU as an entirety on behalf of the ANI or traffic management circuit pack, typically the (primary) controller.

Actions

Reboot – This action should cause the ONU as an entirety to re-boot. It would be expected that the controller pack (or both controller packs) would re-boot, and any other circuit packs would be re-booted or re-initialized as applicable. Re-boot is not expected to be hitless to subscriber services. POTS calls are allowed to be dropped, and layers 2, 3 and 4 data associations are allowed to be lost.

Test – The test action on a chassis-based ONU may not be meaningful. If the test action is not meaningful, it is the vendor's choice whether to reject an ONU-directed test action, or whether to proxy the action to the (primary) controller pack.

Synchronize time – This action should resynchronize all circuit packs that maintain PM-related interval timers and counters.

Notifications – AVCs

Op state – As previously noted, the operational state attribute is optional, and conveys little information at best. When the ONU is really incapable of performing any of its functions, it is likely also to be incapable of conveying a state indication over the PON.

Notifications – alarms

Equipment alarm, ONU self-test fail – This alarm would be expected to be declared against an individual circuit pack, rather than against a chassis-based ONU as an entirety. If one of these alarms is declared by a chassis-based ONU, the alarm should really indicate a chassis-wide problem, not a circuit pack problem.

Powering alarm, battery missing, battery failure, battery low, physical intrusion, voltage yellow, voltage red – These alarms are meaningfully declared by the ONU as entities in their own right.

Dying gasp – The purpose of this alarm is to help the OLT distinguish, when possible, between fibre cuts and equipment faults. Dying gasp should therefore be declared by the ONU on behalf of the circuit pack that supports the ANI. That is, other parts of the ONU may remain up and running; the alarm indicates only the state of the PON optics, or of the ONU as an entirety. If the ONU has redundant PON interface circuit packs, dying gasp should not be declared to indicate failure, loss of power or imminent shutdown of one controller. In that sense, the alarm is really declared by the PON circuit pack, but using the ONU-G as a reporting entity. Dying gasp is not an irrevocable commitment to drop off the PON: the OLT should accept the possibility that the ONU remains active on the PON and clears the alarm after a last-second recovery.

Temperature yellow, temperature red – While it is possible that a chassis could contain global temperature sensors, it is expected that, in the case of a chassis-based ONU, temperature alarms would be declared by individual circuit packs instead. In any event, the alarms should be declared by the ME that best represents the scope of the problem.

ONU manual power off – This alarm is similar to dying gasp, inasmuch as it signals the likelihood that the ONU will drop off the PON, but it conveys the additional information that the shutdown is due to subscriber action.

I.2.6.2 Cardholder

The cardholder ME is needed even by integrated ONUs because it contains information pertinent to the virtual slot model.

Attributes

Actual plug-in unit type (RO) – This attribute takes a value from Table 9.1.5-1. Choices from the table are expected to suffice for the integrated ONU, and the equipment ID attributes are not expected to be used.

Expected plug-in unit type (RW) – This attribute permits some level of pre-provisioning. Although the equipment ID is preferred to indicate a precise circuit pack type, this attribute should be selected from Table 9.1.5-1 to be as meaningful as possible. Even though this attribute is marked RW, the integrated ONU should deny attempts to change its value.

Expected port count (RW) – This attribute permits pre-provisioning of generic circuit pack types when the equipment ID is not specified. Since equipment ID is preferred, this attribute should not be used. If it is used, it must be set to a value that does not conflict with other attributes, such as equipment ID, that may exist already or that may be part of the same set operation. As with the expected plug-in type, which is also RW, an integrated ONU should deny an attempt to change the value of this attribute.

Expected equipment ID (RW) – The OMCI definition states that this attribute pertains only to real (not virtual) cardholders. An integrated ONU should deny an attempt to write its value. As noted earlier, vendors may choose to encode two informative fields into this attribute, e.g., a CLEI and a vendor product code name. No substring matching behaviour is expected: the provisioned value of this attribute must match exactly the value found in the equipment itself.

Actual equipment ID (RO) – The OMCI definition states that this attribute pertains only to real (not virtual) cardholders.

ARC and ARC interval (RW) – These attributes permit alarms to be suppressed on cardholders. The specific application is automatic in-service provisioning, whereby no alarms are declared on pre-provisioned empty slots, but upon insertion of the circuit packs, alarm behaviour goes to normal without further intervention from an OS.

Notifications – AVCs

Actual type, actual equipment ID – These AVCs are not meaningful for integrated ONUs.

Notifications – alarms

Plug-in circuit pack missing, plug-in type mismatch, improper card removal, plug-in equipment ID mismatch, protection switch – These alarms are not meaningful for integrated ONUs.

I.2.6.3 Circuit pack

VC packs exist for an integrated ONU. The type and number of port attributes are meaningful from an equipment management point of view.

Attributes

Type (RWSC) – This attribute takes a value from Table 9.1.5-1. While the attribute value should align as closely as possible with an appropriate equipment type (Table 9.1.5-1), a chassis-based ONU should rely on the equipment ID attribute to convey precise information about circuit pack type.

Number of ports (RO) – Because a circuit pack can have only one type, all of its ports must be the same, and this attribute is just a scalar port count. More complex configurations are managed either by defining additional virtual cardholders and VC packs (integrated ONU) or with the port-mapping package ME.

Serial number, version, vendor ID, equipment ID (RO) – These attributes are reported from the circuit pack hardware. For the (primary) controller pack, they would have the same value as reported in the ONU-G ME pair.

Administrative state (RWSC) – When this attribute has the value locked, all subscriber (and craft) services depending on this circuit pack are blocked. It may not be meaningful to lock circuit packs without subscriber (or craft) interfaces, or circuit packs with mixed interfaces such as ANI, LCT and video UNI; the behaviour in such a case depends on the vendor. It would be reasonable for the ONU to deny the lock operation, or for the operation to have no effect. It is desirable to power down as much circuitry as possible, and to minimize power consumption by establishing locked as the default state.

Operational state (RO) – This attribute has the value disabled if none of the circuit pack's functions is operational for autonomous reasons.

Power shed override (RW) – This attribute permits ports to be declared essential and thereby to be excluded from power-shedding timeout. It assumes a simple scalar numbering of ports, not to exceed 32.

Actions

Reboot – This action is intended to permit an individual (real) circuit pack to be re-booted. If the circuit pack is the (primary) controller, however, it may have the same effect as an ONU reboot action.

Notifications – alarms

Powering alarm – This alarm is intended to indicate a more specific failure of the equipment. The failed equipment could be either a power supply circuit pack or a client circuit pack with a failed input fuse or converter. Battery and AC alarms are declared at the ONU level if they are hard-wired.

1.2.7 Power shedding

Power shedding is the ability of an ONU to reduce power consumption during AC power outages. It is predicated on the assumption that the ONU is attached to a power source that contains a battery back-up and the ability to notify the ONU of AC power loss and restoration. When the ONU is notified by the power source that AC power has been lost, the ONU may reduce power consumption by shutting down selected ONU interfaces. For the purposes of provisioning, these interfaces are divided into classes that may be individually provisioned to shed power after AC power loss is reported to the ONU.

Provisioning of ONU power shedding is accomplished through the use of two OMCI MEs. These are the ONU power-shedding ME and the circuit pack ME. The ONU power-shedding ME contains most of the attributes associated with power shedding. The circuit pack ME contains a single attribute, power shed override, that allows for the override of power shedding on a per port basis.

The power-shedding ME is auto-created by an ONU if that ONU supports power shedding.

The power shed override attribute within the circuit pack ME is a bit map that can be used on a per port basis to override the settings contained in the ONU power-shedding ME. This attribute is defined as a 4 byte bit map with port 1 as MSB. When a bit in this attribute is set to 1, the corresponding port in its circuit pack is exempt from the ONU power-shedding ME.

If the hardware associated with the circuit pack does not support individually powering off its ports, then the entire attribute is taken as a single composite value. In this case, any bit of value 1 exempts all ports on that circuit pack from the ONU power-shedding ME. Intermediate cases are also possible, e.g., where the hardware permits ports to be powered down in groups of four. The point is to retain power on ports designated as essential, while powering down all other ports within the capabilities of the hardware.

Of particular interest in the management of ONU power shedding is the expected behaviour of the ONU during various power-shedding scenarios. This is especially true for the relationship between the two timers represented by the attributes restore power reset interval (T_r) and shedding interval (T_s). This behaviour is depicted in Figure I.2.7-1, in which the following terms are used.

- Start timer – The timer is started or resumed from its existing value. A start timer action does not imply a reset of the timer.
- Stop timer – The specified timer is stopped and not reset.
- Reset timer – Stops and resets a timer. The timer is not started.

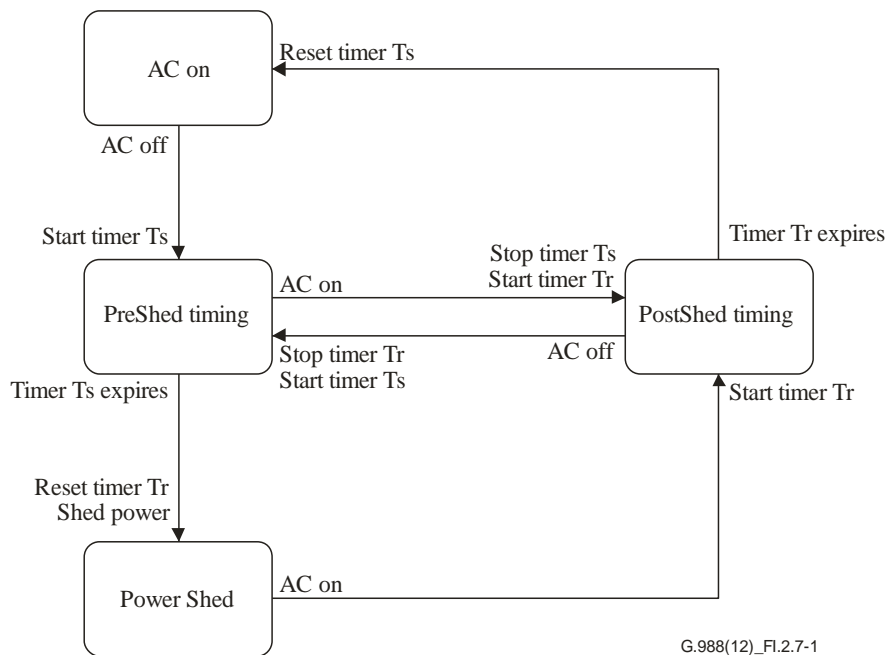

Figure I.2.7-1 – Power-shedding state diagram

I.2.8 Remote debug

The remote debug ME (clause 9.1.12) is used for free-form information exchange with an ONU for the purpose of debugging an ONU from an OLT. This may be appropriate due to the lack of other debug access (primarily due to security concerns of the operator) or because the ONU is located remotely. It is not the purpose of remote debug access to offer management abilities that should be done using conventional OMCI or other vendor-specific MEs.

The remote debug entity has the ability to send 25 bytes of information to an ONU and collect up to 0xFFFFFFFF bytes of response. The information exchange may be ASCII coded or in vendor-specific binary format.

It is assumed that the majority of the OLTs and ONUs would implement the ASCII format, whereby OLTs could inject basic ASCII commands to an ONU and receive ASCII formatted reports in reply. The raw binary data format offers the ability to collect information in a single-vendor environment for advanced debugging purposes.

The ME ID of this object is always zero. Since the object is created by the ONU, no other ME IDs are possible. The remote debug capability of an ONU can be detected by a get operation on the remote debug ME, with an error response if the object does not exist.

Command syntax (in either mode) is vendor-specific, as is the reply information. However, some general guidelines for the ASCII mode are suggested as best practice. The ASCII command *help* should be supported by the ONU, such that the ONU would then reply back with the available commands that may be supported by the remote debug process. In addition, if a command is not

recognized or cannot be parsed by the ONU, a reply to that nature should be returned in the specified format. The use of OMCI error codes to indicate an error in the ASCII command (not the OMCI command) is not advised.

Figure I.2.8-1 illustrates a potential remote debug exchange. In this example, the OLT sends an ASCII text string command *dump status* to the ONU, and the ONU replies.

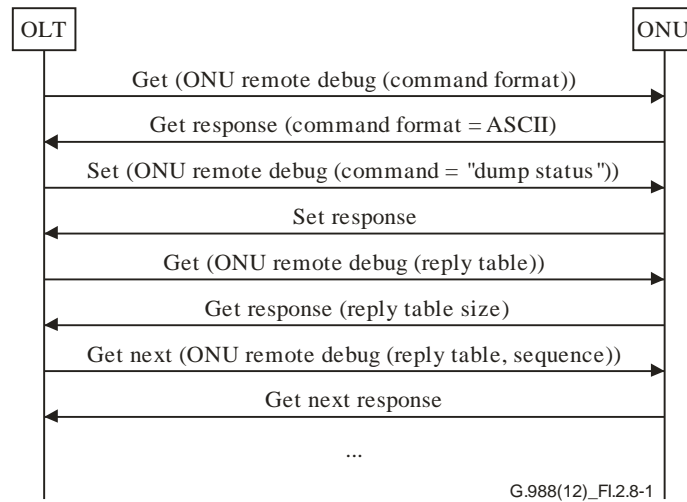

Figure I.2.8-1 – Success example

I.3 Software upgrade

I.3.1 Overview

The software image ME is defined in clause 9.1.4. For each ME that contains independently manageable software (either the ONU or a circuit pack), the ONU creates two software images, 0 and 1. Each image has three Boolean attributes: committed; active; and valid. An image is valid if the contents have been verified to be an executable code image. An image is committed if it is loaded and executed upon reboot of the ONU or circuit pack. An image is active if it is currently loaded and executing in the ONU or circuit pack. At any given time, at most one image may be active and at most one image may be committed.

An ONU goes through a series of states to download and activate a software image as shown in Figure I.3.1-1. Each state is determined by the status of both software images. For example, S3 is the state where both images are valid but only image 0 is committed and active. State S0 is a conceptual initialization state.

The OLT controls the state of the ONU through a series of commands defined in clause 9.1.4. For example, an ONU in state S3 will traverse to state S4 upon receipt of the activate(1) command. The defined commands are start download, download section, end download, activate image and commit image.

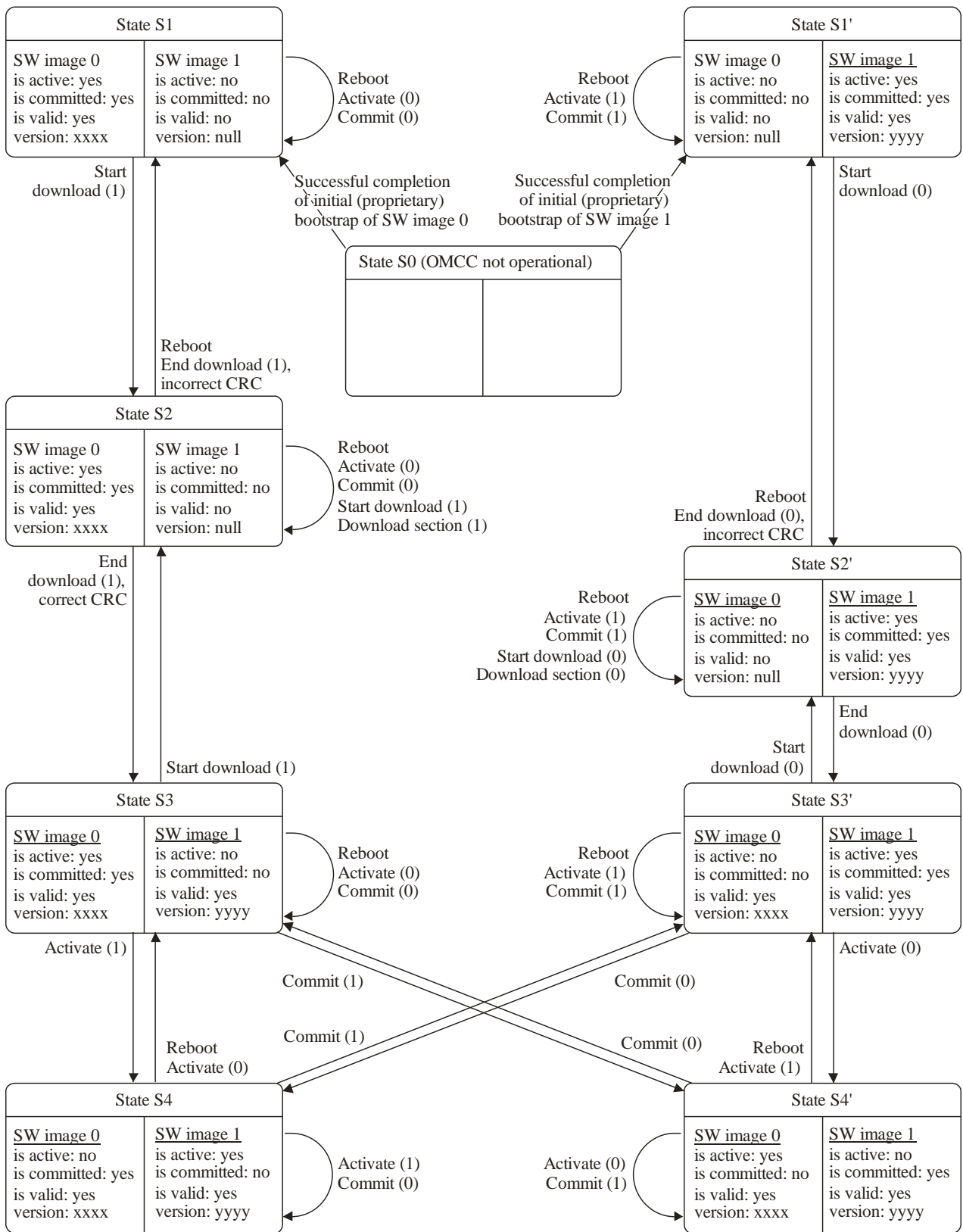

G.988(12)_FI.3.1-1

NOTE – In Figure I.3.1-1, states S1 and S2 (and S1' and S2') are distinguished only for convenience in understanding the flow. Upon receipt of a start download message, and particularly when the ONU re-boots, any partial downloads in progress are discarded.

Figure I.3.1-1 – Software image state diagram

I.3.2 Software image download

The software image download operation is a file transfer from the OLT to the ONU. The OMCI defines two mechanisms to download software images to ONUs. This clause describes the mechanism

built into the OMCI, first describing download in the context of the baseline OMCI message set; the description is then modified as appropriate for the extended message set.

The second download mechanism uses the OMCI to define the parameters of a file transfer from an external server, which may or may not be the OLT. The file transfer controller is defined in clause 9.12.13, and is not discussed further in this clause.

I.3.2.1 Baseline message set download The atomic unit of file transfer is the section, the 31 bytes of data that can be transferred in a single (baseline) download section message. The last section in a software download may be padded with null bytes as needed.

A number of sections comprise a so-called window. A window may not exceed 256 sections. Figure I.3.2.1-1 illustrates the relationship between a software image and its decomposition into windows and sections.

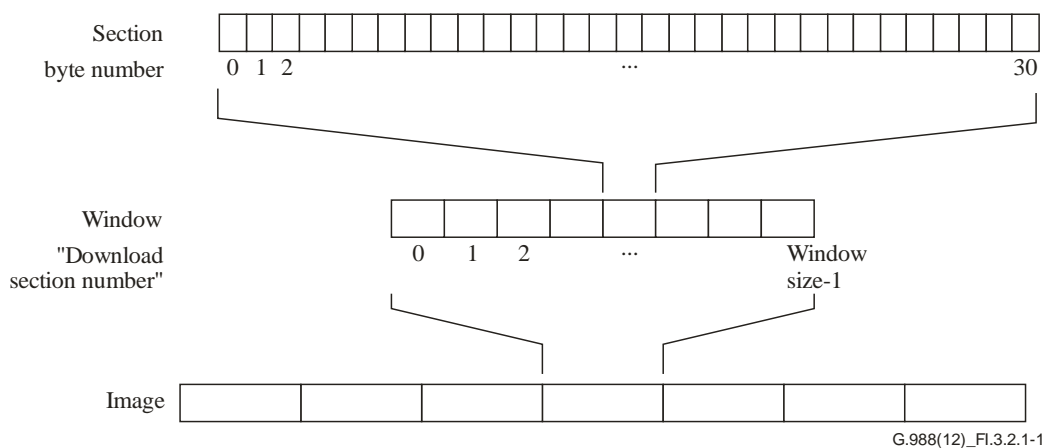

Figure I.3.2.1-1 – Relationship between image, windows and sections (baseline message set)

During the initial software download message exchange, the OLT proposes a maximum window size, but a lower value can be stipulated by the ONU, which must be accepted by the OLT. The OLT may send windows with fewer sections than this negotiated maximum, but may not exceed the maximum. Though it is not a preferred choice, the OLT may send all windows at the full negotiated maximum size, with the final window of the download operation padded out with download section messages containing only null pad bytes.

Each download section message contains a sequence number, which begins anew at 0 with each window. By tracking the incrementing sequence numbers, the ONU can confirm that it has in fact received each section of code.

In the MT field of the last download section message of each window, the OLT indicates the end of the window by setting the AR (acknowledgement request) bit – prior download section messages are unacknowledged. If the ONU has not received the entire window correctly, i.e., if it misses a sequence number, it acknowledges with a command processing error result, whereupon the OLT falls back to the beginning of the window and tries again. To improve the chance of successful transmission, the OLT may choose to reduce the size of the window on its next attempt.

When the final window has been successfully downloaded, the OLT sends an end software download message whose contents include the size of the downloaded image in bytes, along with a CRC-32 computed according to [ITU-T I.363.5], across the entire image but excluding pad bytes that may have been transmitted. If the ONU agrees with both of these values, it updates the software image validity attribute to indicate that the newly downloaded image is valid. Figure I.3.2.1-2 illustrates this process.

The negotiation of the window size is governed by two opposing criteria: 1) maximize throughput and 2) avoid ONU receive buffer overflow. A problem arises if the ONU supports both baseline message set and extended message set. At the time when the ONU negotiates the window size, the ONU does not know whether the OLT will use baseline or extended message set for the download. If the ONU assumes the OLT will use extended message set for software download but the OLT actually uses baseline message set, then the ONU will choose a small window size and the throughput could be low. If the ONU assumes the OLT will use baseline message set for software download but the OLT actually uses extended message set, then the ONU will choose a large window size and the ONU receive buffer could overflow.

Although ITU-T G.989.3 allows the OLT to switch between baseline and extended message set on subsequent messages, the following OLT behaviour is recommended (not mandatory) to prevent the resource constrained ONU from overflowing OR negotiating a low throughput:

- If the OLT uses baseline "Start Download" message then all subsequent "Download segment" messages should also use baseline message format. Likewise if the OLT uses extended "Start Download" message then all subsequent "Download segment" message should also uses extended message format. The ONU can respond with an appropriate window size based on the knowledge of the message set the OLT intends to use based on the "Download segment" message
- If the OLT supports OLT-G ME, the ONU can derive the OLT use of baseline or extended message set in software download based on a priori knowledge of the vendor/equipment information.

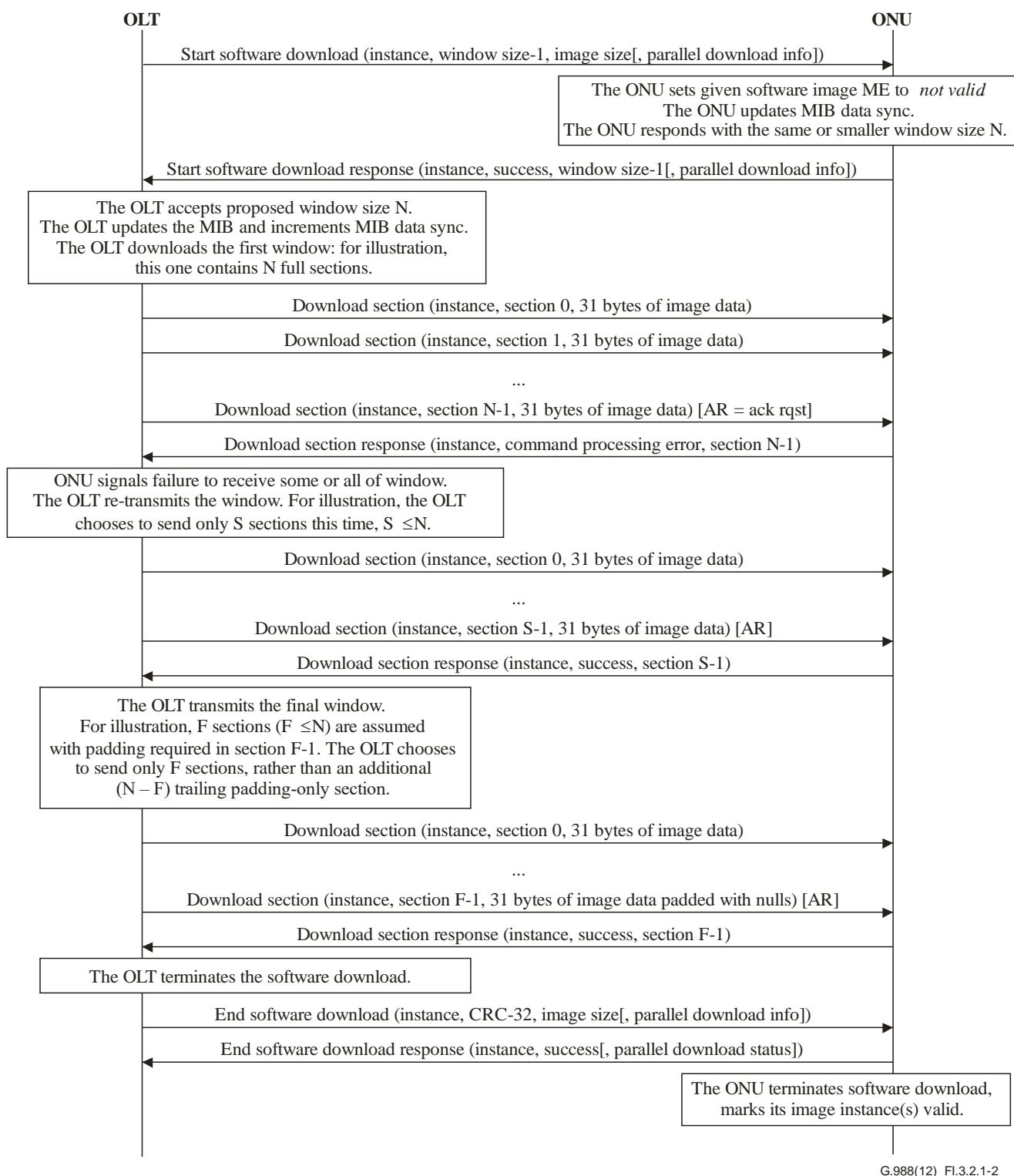

G.988(12)_FI.3.2.1-2

Figure I.3.2.1-2 – Software download, baseline message set

The ONU should positively acknowledge an end download message only after it has performed whatever operations may be necessary – such as storage in non-volatile memory – to accept an immediate activate or commit message from the OLT. As illustrated in Figure I.3.2.1-3, the ONU should respond with a device busy result code until these operations are complete, and the OLT should periodically retry the end download command. The OLT should include a timeout to detect an ONU that never completes the download operation.

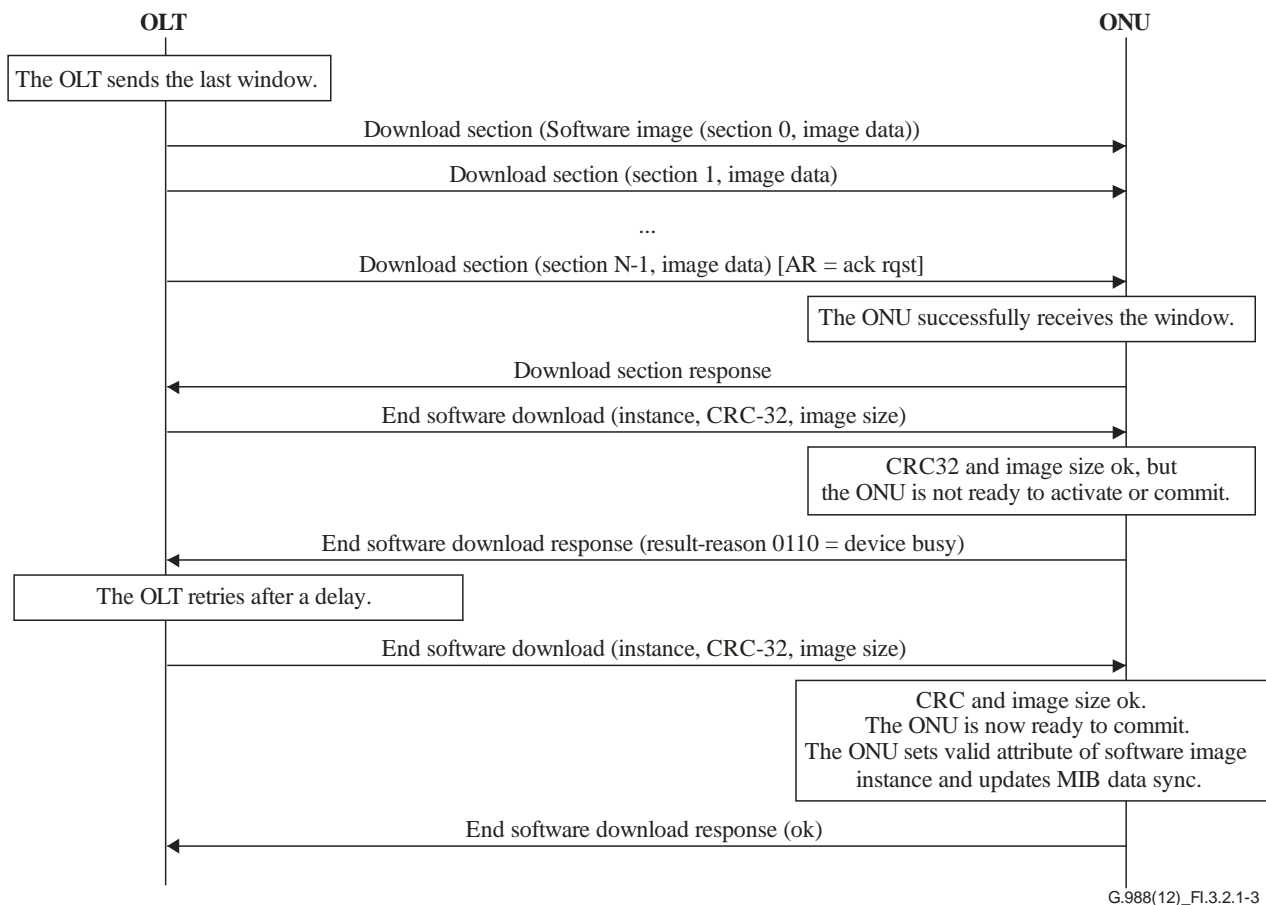

Figure I.3.2.1-3 – Busy response handling

The nested state machines in the OLT and ONU can conceivably get out of step in a number of unspecified ways; nor is it specified how to escape from a loop of transmission failure and retry. As a recovery mechanism from detectable state errors, it is recommended that the ONU reply with command processing error result codes to both the acknowledged download section and end software download commands, and that the OLT send a final end software download command with a known bad CRC and image size (e.g., all 0), whereupon both the OLT and ONU should reset to the state in which no download is in progress, i.e., state S1/S1' of Figure I.3.1-1. Likewise, the OLT should be able to abort the download operation at any time by sending an end software download message with invalid CRC and image size.

As well as the download of an image to the ONU as a whole, the download messages allow an option to download an image to each of several circuit packs in parallel. The starting assumption is that the OLT knows the set of circuit packs that require the same download file, so that it can specify this set in the download command sequence.

I.3.2.2 Extended message set download

The description of clause I.3.2.1 pertains also to download using the extended OMCI message set, except that the maximum size of the section is limited by the extended message format itself, and is potentially as large as 1965 bytes. The OLT may send smaller sections at will, including the final section of a file transfer. Because the extended message format allows for variable length, software image sections are never padded in this message format.

The negotiation of the window size is governed by two opposing criteria: 1) maximize throughput and 2) avoid ONU receive buffer overflow. A problem arises if the ONU supports both baseline message set and extended message set. At the time when the ONU negotiates the window size, the ONU does not know whether the OLT will use baseline or extended message set for the download. If

the ONU assumes the OLT will use extended message set for software download but the OLT actually uses baseline message set, then the ONU will choose a small window size and the throughput could be low. If the ONU assumes the OLT will use baseline message set for software download but the OLT actually uses extended message set, then the ONU will choose a large window size and the ONU receive buffer could overflow.

Although ITU-T G.989.3 allows the OLT to switch between baseline and extended message set on subsequent messages, the following OLT behaviour is recommended (not mandatory) to prevent the resource constrained ONU from overflowing OR negotiating a low throughput:

- If the OLT uses baseline "Start Download" message then all subsequent "Download segment" messages should also use baseline message format. Likewise if the OLT uses extended "Start Download" message then all subsequent "Download segment" message should also uses extended message format. The ONU can respond with an appropriate window size based on the knowledge of the message set the OLT intends to use based on the "Download segment" message
- If the OLT supports OLT-G ME, the ONU can derive the OLT use of baseline or extended message set in software download based on a priori knowledge of the vendor/equipment information.

I.3.3 Software image activate and commit

Figure I.3.3-1 shows the details of software image activate and commit. When the ONU has downloaded and validated a new image, that image is initially not-committed and not-activated. The OLT may then send the activate image command. After the ONU sends a positive activate image response, the ONU loads and executes the new software image, but without changing the committed state of either image. The OLT may then send the commit image command, causing the ONU to set the commit state true for the new image, and false for the previous image. The time between the download, activate and commit phases is not specified.

If there is a problem with the newly activated image that causes the ONU to fail (e.g., watchdog timeout), the ONU should do a soft restart on the (other) committed image. Activating prior to committing may thereby allow for automatic failure recovery by the ONU.

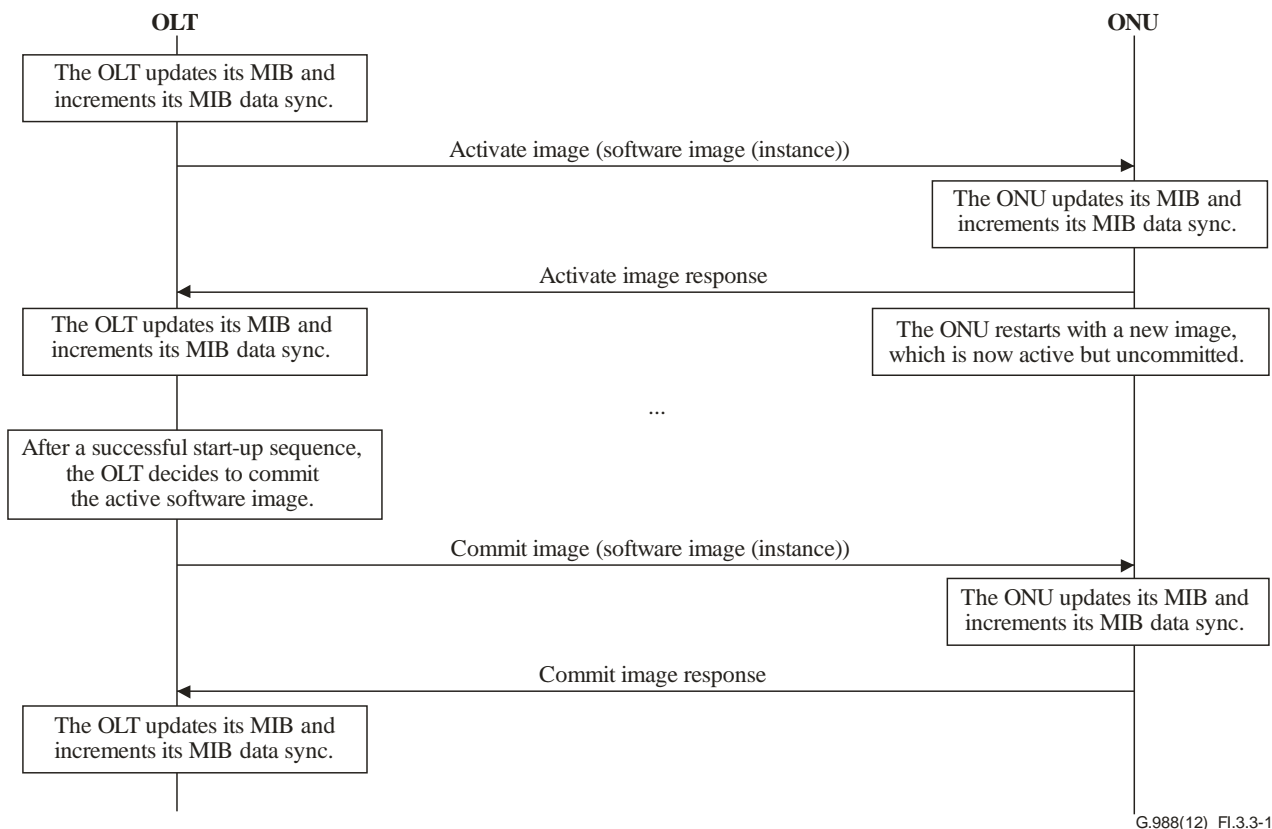

Figure I.3.3-1 – Software activate and commit

I.4 Performance monitoring

The tools used for PM are as follows.

- The PM history data and extended PM MEs. PM is defined in clause 9 for many ONU functions including GEM adaptation, CES, Ethernet service and voice service.
- The synchronize time action on the ONU-G ME. This action synchronizes all PM MEs to a common 15 min collection interval starting point.
- The threshold data 1 and threshold data 2 ME pair. These MEs provide thresholds for the TCA function.
- The TCA notification, which alerts the OLT to a threshold crossing event.

PM MEs share a number of characteristics, as described in this clause. Exceptions to the generic behaviour are defined in the specific ME affected.

Two groups of PM MEs are defined as follows.

- 1) Classical PM, whose members are identified by names containing the string, "performance monitoring history data".
- 2) Extended PM, whose members are identified by names containing the string, "extended PM".

All PM MEs are created and deleted by the OLT.

The remainder of this parent clause describes behaviour common to the two classes of PM MEs. Aspects unique to each PM ME class are discussed in the following subclauses.

PM collection intervals

Classical PM, and optionally extended PM, are based on the assumption of a continuing sequence of 15 min intervals. This sequence of 15 min intervals is coordinated by the synchronize time action, issued by the OLT against the ONU-G ME. The synchronize time action resets all PM attributes,

establishes a 15 min tick boundary and starts numbering the intervals from 0. The interval number is represented by the interval end time attribute of the PM ME, a single byte counter that rolls over from 255 to 0.

The synchronize time action is the only mechanism guaranteed to reset either the phase or the interval number. For example, neither ONU re-boot nor MIB reset can be expected to have these effects (the PM consequence of these events is undefined). In the absence of a synchronize time message, an ONU would be expected to maintain 15 min intervals asynchronously with the outside world, and with an incrementing but arbitrary interval identifier.

No explicit mechanism is provided to synchronize a new PM ME that may be created on a working ONU. Best practice suggests that the ONU run all of its 15 min PM according to a single ONU-wide 15 min timer and interval counter.

The ONU does not perform any calculations upon the collected data nor does it keep an archive of collected data beyond the previous 15 min interval. Archiving and analysis, if required, are performed by a higher order network element such as the OLT or EMS, along with possible accumulation into 24 h statistics.

In 15 min accumulation mode, as distinguished from the optional continuous accumulation mode of the extended PM MEs, the ONU conceptually has only two storage bins for each PM ME instance: a current accumulator and a history bin. At 15 min intervals, they switch roles. History is discarded at age 30 min, when the previous history bin is initialized into its role as the new current accumulator. The previous accumulator, now in its role as the history bin, retains its totals for 15 min, so that the OLT can upload them if desired.

In 15 min accumulation mode, the get action on a PM ME returns the values of attributes in the history bin. An ONU may also support an optional action in 15 min accumulation mode, get current data. The effect of this action is to return the value of attributes in the current accumulator. When a PM attribute is an average or a ratio, it acquires a value only at the end of a 15 min interval. The value returned by a get current data operation is undefined (0xFF in every byte would be reasonable).

Thresholds and alerts

The OMCI supports PM thresholds and TCAs. Not all PM attributes can be thresholded; threshold definition and assignment is part of the specification of each PM attribute.

The PM ME definition includes a pointer to threshold data MEs, a null pointer by default. If the OLT does not require TCAs, it leaves the pointer undefined. To enable thresholds, the OLT creates an instance of the threshold data 1 ME, and if any of the required thresholds is numbered above 7, also an instance of the threshold data 2. The OLT then populates the threshold data attributes with threshold values in accordance with the mapping defined in each type of PM ME.

Any number of PM ME instances may subscribe to a given set of thresholds.

Most performance attributes are counters. During the accumulation interval, the PM ME collects counter statistics in accordance with each PM attribute definition, and continuously compares the accumulated values with any thresholds that may exist. When an accumulated value first equals or exceeds the threshold, the ONU originates a TCA.

If a counter PM attribute should fill up during the interval, it remains at its maximum possible value, rather than rolling over.

The threshold for a given counter attribute may be disabled by setting it either to 0 or to 0xFFFF. It may also be effectively disabled by setting it to a value greater than the range of the counter, e.g., a value greater than 900 when used for an ES PM attribute.

The OLT may modify a threshold attribute at any time. If the modification lowers the threshold such that it has already been passed, the TCA is reported when the current value is next compared with the

threshold value. This comparison is specific to the ONU's architecture, so that the timing or even the existence of a TCA during the current interval cannot be guaranteed.

Regardless of the origin of a given TCA, the ONU issues a second TCA at the end of the current 15 min interval, cancelling the first. That is, each 15 min interval begins with all previous TCAs explicitly cleared via notifications to the OLT.

When a PM attribute is an average or a ratio, its value is computed only at the end of the interval. A TCA on such an attribute can therefore be declared only at the end of the interval. The TCA is then immediately cleared as the accumulator is reset for the next interval. The definition of a given PM attribute may specify different or more detailed behaviour.

When a PM attribute is a high-water-mark, a TCA is declared when the monitored parameter equals or exceeds the threshold value from below; conversely for a low-water-mark attribute. There is no general definition of the mechanism to clear the TCA, nor specification of delay or hysteresis to avoid TCA storms for a parameter fluctuating near the threshold value. These should be defined in the specification of each PM attribute.

TCAs are reported in OMCI alarm messages. There is no overlap between TCA code points and alarm code points, because a given ME class declares either alarms or TCAs, but not both.

MIB sync

The control block of a PM ME contains persistent data that can be set by the OLT. Setting the value of a control block attribute therefore increments the MIB data sync attribute of the ONU data ME. In addition, the control block attribute of a PM ME is included in an MIB upload. Other PM attributes are transient and are not included in MIB uploads.

Template for the definition of a PM ME

Existing PM generally follows the following outline. Significant exceptions are discussed here; an implementation is advised to be aware that the definitions of individual MEs and attributes may contain other exceptions.

<Description>

Relationships

<Relationships>

Attributes

Managed entity ID: This attribute is discussed further in separate subsequent clauses.

Interval end time: This attribute identifies the most recently finished 15 min interval. (R) (mandatory) (1 byte)

Control block: This attribute is discussed further in separate subsequent clauses. In classical PM, it is just a pointer to threshold data MEs.

PM1: Definition of the first PM accumulation attribute, in most cases a counter, in other cases, an average, a high water-mark or a low water-mark. The recommended size of a PM accumulation attribute is 4 bytes, but definitions vary. (R) (mandatory) (4 bytes)

PM2:

... Definition of additional PM accumulation attributes, maximum not to exceed 14. There is no particular preference on the order in which parameters are defined.

Actions

Create, delete, get, set

Get current data (optional)

Notifications

The TCA table lists thresholded attributes in order. It is not required that all attributes be thresholdable. The alarm number column identifies a bit in the alarm bit map field of the OMCI alarm message that is used to report TCAs. Alarm numbering starts at 0.

The threshold data counter column assigns threshold attributes of the threshold data 1 and if required, the threshold data 2 MEs. In all cases, the assignment is monotonic, but existing PM definitions may or may not skip a threshold attribute for each PM attribute that is to be thresholded. In future PM definitions, it is recommended that threshold attributes be assigned sequentially, without gaps. If, for example, the only thresholded PM attributes were the first, third and sixth in order of PM ME definition, they would still be assigned threshold attributes 1, 2, 3.

Threshold crossing alert

Alarm number	Threshold crossing alert	Threshold data counter No. (Note)
0	PM1	1
1	PM2	2
2	...	3
3		4

NOTE – This number associates the TCA with the specified threshold value attribute of the threshold data 1 managed entity.

I.4.1 Classical PM

Unneeded PM accumulation may impose an unnecessary load on the ONU host processor and should be avoided. In classical PM, parameter collection can be disabled only by deleting the PM ME.

In classical PM, the ME ID attribute takes the same value as the parent ME's ID, so that no explicit pointer to the parent ME is required. The ME class of the parent is fixed in the definition of the classical PM ME.

Managed entity ID: This attribute uniquely identifies each instance of this ME. Through an identical ID, this ME is implicitly linked to an instance of a <parent managed entity class>. (R, set-by-create) (mandatory) (2 bytes)

In classical PM, the control block attribute is always a simple pointer to a threshold data ME, and is designated as such. The attribute value may be set to a null pointer if no thresholding is desired. If no assigned threshold number exceeds 7, it is the OLT's option whether to create a threshold data 2 ME or not. The template text reads as follows, depending on the highest threshold attribute assigned:

Threshold data 1/2 ID: This attribute points to an instance of the threshold data 1 and 2 MEs that contains PM threshold values. (R, W, set-by-create) (mandatory) (2 bytes)

Or:

Threshold data 1/2 ID: This attribute points to an instance of the threshold data 1 ME that contains PM threshold values. Since no threshold value attribute number exceeds 7, a threshold data 2 ME is optional. (R, W, set-by-create) (mandatory) (2 bytes)

I.4.2 Extended PM

In extended PM, the control block attribute is defined to be (R, W, set-by-create) (mandatory) (16 bytes). The template for these 16 bytes is as follows:

Threshold data 1/2 ID: (2 bytes). The definition of this field is the same as for that in classical PM.

NOTE – When PM is collected on a continuously running basis, rather than in 15 min intervals, counter thresholds should not be established. There is no mechanism to clear a TCA, and any counter parameter may eventually be expected to cross any given threshold value.

Parent ME class: (2 bytes). This field contains the enumerated value of the ME class of the PM ME's parent, as defined in Table 11.2.4-1. Together with the parent ME instance field, this permits a given PM ME to be associated with any OMCI ME. The definition of an extended PM ME should list the allowed parent ME classes.

Parent ME instance: (2 bytes). This field identifies the specific parent ME instance to which the PM ME is attached.

Accumulation disable: (2 bytes). This bit field allows PM accumulation to be disabled; refer to Table I.7.2-1. Bit value 0 enables PM collection. If bit 15 is set to 1, no PM is collected by this ME instance. If bit 15 = 0 and any of bits 14..1 are set to 1, PM collection is inhibited for the attributes indicated by the 1 bits. Inhibiting PM collection does not change the value of a PM attribute, but if PM is accumulated in 15 min intervals, the value is lost at the next 15 min interval boundary.

Bit 16 is an action bit that always reads back as 0. When written to 1, it resets all PM attributes in the ME, and clears any TCAs that may be outstanding.

TCA disable: (2 bytes) Also clarified in Table I.4.2-1, this field permits TCAs to be inhibited, either individually or for the complete ME instance. As with the accumulation disable field, bit value 0 enables TCAs, and setting the global disable bit overrides the settings of the individual thresholds. Unlike the accumulation disable field, the bits are mapped to the thresholds defined in the associated threshold data 1 and 2 ME instances. When the global or attribute-specific value changes from 0 to 1, outstanding TCAs are cleared, either for the ME instance globally or for the individual disabled threshold. These bits affect only notifications, not the underlying parameter accumulation or storage.

If the threshold data 1/2 ID attribute does not contain a valid pointer, this field is not meaningful, since no TCAs are possible.

Table I.4.2-1 – Bit assignments in extended PM control block

Bit	16	15	14	13	3	2	1 (LSB)
Accumulation disable	Global clear	Global disable	PM14	PM2	PM1
TCA disable		Global disable	Th14	Th2	Th1

Control fields: (2 bytes). This field is a bit map whose values govern the behaviour of the extended PM ME. Bits are assigned as follows:

- Bit 1 (LSB) The value 1 specifies continuous accumulation, regardless of 15 min intervals. There is no concept of current and historical accumulators; get and get current data (if supported) both return current values. Accumulated values are only reset by the clear flags, not by any timed or other action. The value 0 specifies 15 min accumulators exactly like those of classical PM.
- Bit 2 The value 0 specifies directionality, for example upstream or downstream, or up/down in an [IEEE 802.1ag] sense with respect to a bridge port. If this bit is meaningful, the details are part of the definition of the extended PM ME.
- Bits 3..16 Reserved. Starting from bit 16, and working downwards, these bits may be used in the definition of individual extended PM MEs. Continuing upwards from bit 3, these bits may be used for additional purposes that pertain to all extended PM MEs.

For example, in a VLAN extended PM ME, bits 16-15 could be used to match P bits, VID or both.

Reserved: (4 bytes). These bytes are available for customization in the definition of each extended PM ME.

For example, in a VLAN extended PM ME, two of these bytes could be used to specify TCI.

The other template boiler plate fields are revised in extended PM to read as follows:

Managed entity ID: This attribute uniquely identifies each instance of this ME. To facilitate discovery, the identification of instances sequentially starting with 1 is encouraged. (R, set-by-create) (mandatory) (2 bytes)

Interval end time: This attribute identifies the most recently finished 15 min interval. If continuous accumulation is enabled in the control block, this attribute is not used and has the fixed value 0. (R) (mandatory) (1 byte)

Threshold data 1/2 ID: <same textual options as in classical PM>. Thresholding is not advised for counter attributes if PM is accumulated continuously. (R, W, set-by-create) (mandatory) (2 bytes)

It is not expected that the PM accumulation policy will be changed in actual deployment practice, and the behaviour of intervals, TCAs and accumulated history across a transition between continuous and interval accumulation is not specified. It may be desirable to disable and clear PM at such a transition.

The synchronize time action has no observable effect on PM that is accumulated continuously.

Counter PM attributes do not roll over in interval PM mode, but do roll over from maximum to zero in continuous accumulation mode. PM attributes that record averages or ratios are undefined in continuous accumulation mode. Both of these behaviours may be overridden by explicit specification in the definition of a given extended PM ME.

Appendix II

G-PON mechanisms and services

(This appendix does not form an integral part of this Recommendation.)

NOTE – When text in this clause refers to the IP host config data ME, or to an IP stack, it is understood to include the IPv6 host config data ME, or an IPv6 stack, as modified suitably by the differences between IPv4 and IPv6.

This appendix describes mechanisms and services that are common to G-PON systems, as described in the relevant TC layer specification.

II.1 Layer 2 data service according to [b-BBF TR-156]

II.1.1 Requirements base

[b-BBF TR-156] provides Broadband Forum's core set of requirements for layer 2 data service functionality within a G-PON access node. [b-BBF TR-156] addresses three network service architectures as follows.

- 1) 1:1 VLANs – Indicates a one-to-one mapping between user port and VLAN. The uniqueness of the mapping is maintained in the G-PON access node and across the aggregation network.
- 2) N:1 VLANs – Many-to-one mapping between user ports and VLAN. The user ports may be located in the same or different G-PON access nodes.
- 3) VLANs for business Ethernet services (VBES, also known as TLS) – Transparent transport of incoming frames as they arrive at the UNIs regardless of whether they are VLAN tagged, priority tagged or untagged.

It is desirable to implement G-PON systems with at least the layer 2 OMCI common model (L2-OCM) defined in this appendix, which supports the requirements of [b-BBF TR-156]. A system may also support additional OMCI layer 2 models or extend the common model.

This appendix describes recommended provisioning models and message sequences to support [b-BBF TR-156]. However, it is important to recognize that the OLT and ONU have a master-slave relationship, with the OLT as master. Therefore, the OLT may choose to provision the ONU with only a subset of the models described in this appendix or a subset of the functionality defined in [b-BBF TR-156], and the ONU should act as commanded by the OLT. Only if the OLT requests ONU actions that are beyond the capabilities represented here, is the OLT considered to be performing outside of the scope of this appendix.

II.1.2 Layer 2 unicast data services

II.1.2.1 Single UNI OMCI provisioning model

The L2-OCM is the minimum that should be supported by all G-PON systems. It is based on the 1:MP model of Figure 8.2.2-7. This model combines MAC bridging and IEEE 802.1p mapping functionality for a single UNI. Figure II.1.2.1-1 illustrates L2-OCM applied to a single UNI ONU. Figure II.1.2.1-1 assumes an Ethernet UNI, but the same provisioning model can be used for other UNI types.

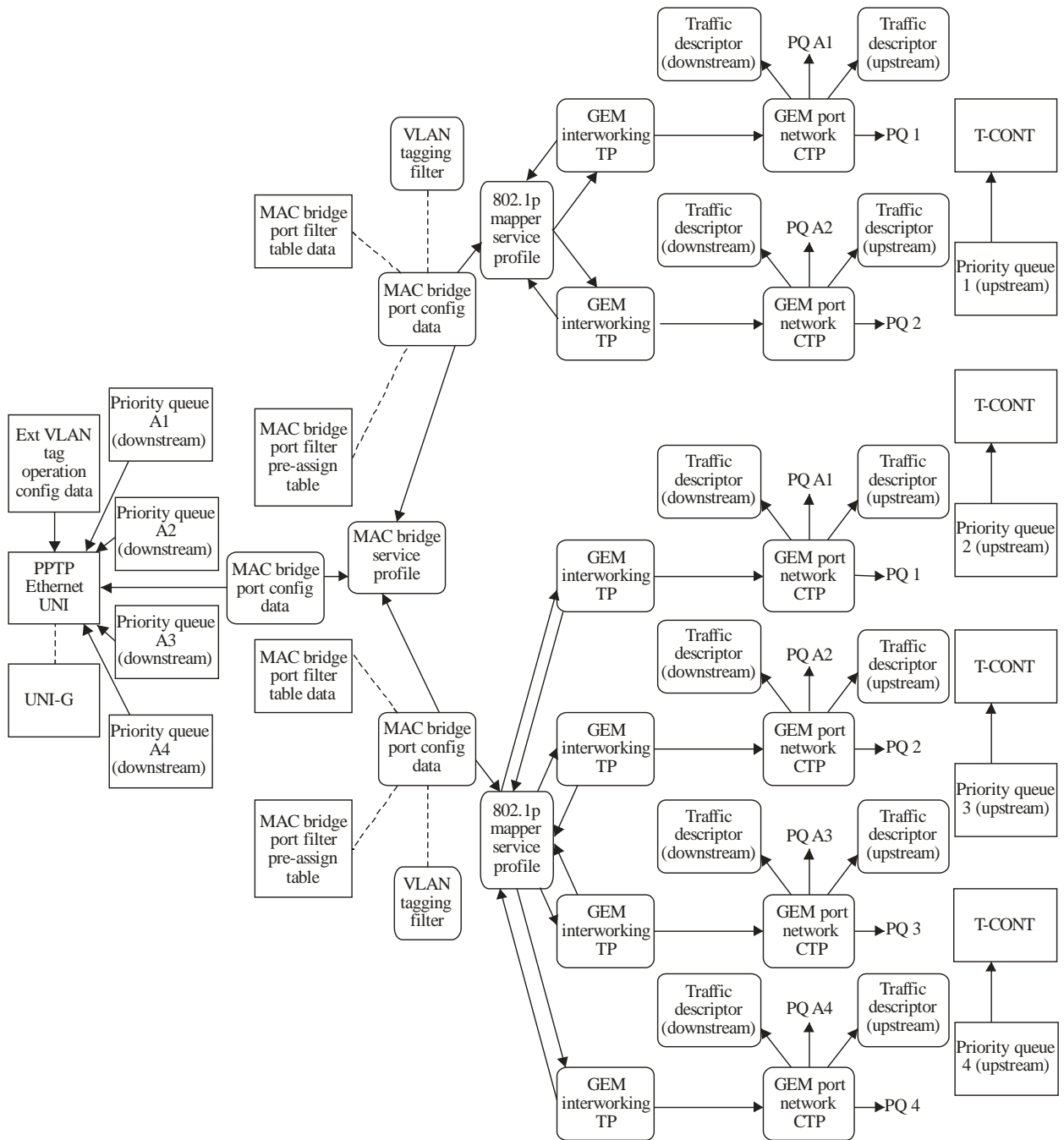

G.988(12)_FIL.1.2.1-1

Figure II.1.2.1-1 – Single UNI, two VLANs with common priorities

Figure II.1.2.1-1 shows provisioning to provide upstream mapping of two VIDs and the IEEE 802.1p priorities within those VIDs. With the VID selected by a VLAN tagging filter, the upper part of Figure II.1.2.1-1 provisions IEEE 802.1p priorities to two GEM ports, each going to a single priority queue. In the lower part of Figure II.1.2.1-1, the other VID is provisioned to map IEEE 802.1p priorities to four GEM ports, each going to a single priority queue.

Figure II.1.2.1-1 shows only four priority queues because this is the minimum requirement of [b-BBF TR-156]. Figure II.1.2.1-1 can easily be extended to six classes of traffic, the objective of [b-BBF TR-156], by adding GEM port network CTPs, GEM IW TPs, priority queues and T-CONTs.

NOTE – This clause is specific to [b-BBF TR-156], which contemplates only a single queue per T-CONT. Multiple queues per T-CONT are discussed further in clause II.3.

Figure II.1.2.1-2 depicts another provisioning option using the L2-OCM. This provisioning treats each of the two VLANs as having an implied priority that is beyond the scope of the IEEE 802.1p priority bits; i.e., the P-bit space of one VLAN does not correspond to the same P-bit priorities of the other. The P bits of each VLAN are mapped separately to different queues, thence to different T-CONTs. VID1 is mapped to one bridge port and IEEE 802.1p mapper, while VID2 is mapped to another bridge port and mapper. Each IEEE 802.1p mapper maps P-bit values 2 and 3 (for example) to separate priority queues, resulting in four distinct priority flows, both upstream and down. By grooming traffic into separate T-CONTs, the option is available for the OLT to provide different service levels, even for traffic with the same P-bit values.

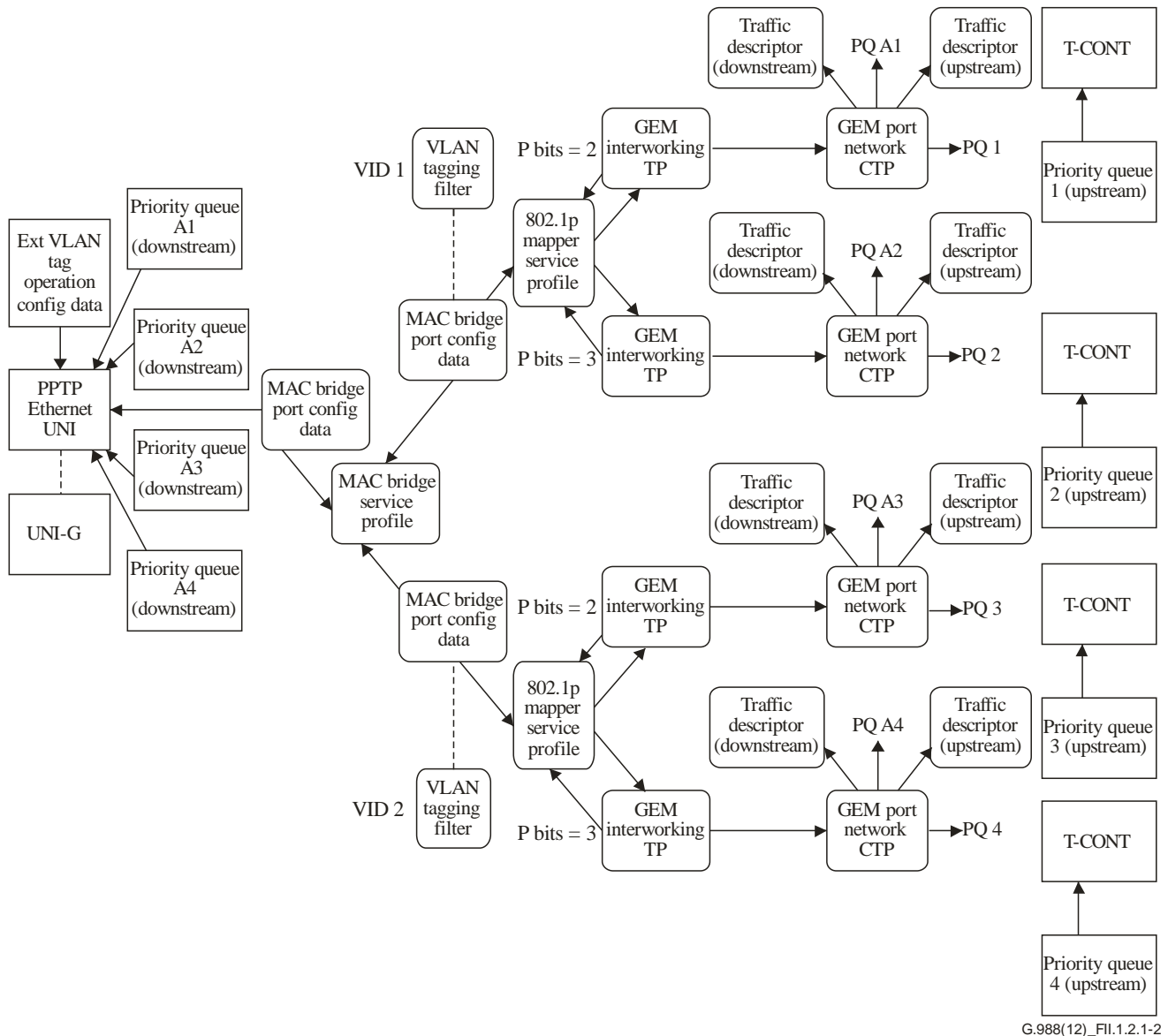

Figure II.1.2.1-2 – Single UNI, two VLANs, VID-based priorities

II.1.2.1.1 T-CONT and GEM port usage

The common OMCI model uses four T-CONTs, each representing a single logical connection group associated with an alloc-ID. To meet [b-BBF TR-156] requirements, each T-CONT transports a single traffic class, and with only one priority queue. One queue per T-CONT relieves the ONU of most of its upstream QoS responsibilities; the bandwidth allocation algorithm in the OLT governs QoS in fine detail.

Each T-CONT ME is instantiated with its policy attribute set to the ONU's default; since only one priority queue is associated with the T-CONT, the policy attribute should be treated as a "don't care" by the OLT. Clause II.3 discusses QoS management when a T-CONT is served by more than one queue.

Each T-CONT is associated with 1 to N GEM ports by way of its upstream priority queue. Each GEM port is represented in the model by a GEM IW TP and a GEM port network CTP. The following provisioning considerations pertain to these MEs:

GEM interworking TP

- The GEM port network CTP connectivity pointer attribute is set to point to the partner GEM port network CTP ME.
- The IW option, service profile pointer, and GAL profile pointer attributes should all be set according to the IEEE 802.1p mapper service option.
- The IW TP pointer attribute is set to 0 and not used.

GEM port network CTP

- The direction attribute is set to 3 to indicate a bidirectional GEM port.
- The priority queue pointer for the downstream attribute should point to the desired downstream priority queue. However, downstream frames arriving at the GEM port are conceptually routed through the IEEE 802.1p mapper and MAC bridge, where tagging and filtering operations may be performed, rather than directly transferred to the downstream priority queue. Therefore, it is important that the provisioning of the MAC bridge and the priority queue pointer attribute agree on the destination UNI for downstream frames. The consequences of inconsistent provisioning are not defined.
- The traffic management pointer for upstream, traffic descriptor profile pointer for upstream, and traffic descriptor profile pointer for downstream attributes should be supported. For detailed information on the use of the traffic attributes, refer to clause II.3.

II.1.2.1.2 Classification and marking

The extended VLAN tagging operation data ME provides classification and marking of ingress frames at the UNI. This includes the ability to add tags based on Ethertype and to set IEEE 802.1p P-bit values based on DSCP.

II.1.2.1.3 MAC address filtering

Figure II.1.2.1-1 depicts a MAC bridge port filter pre-assign table ME and a MAC bridge port filter table data ME associated with the ANI side MAC bridge port configuration data MEs. While these MEs are automatically created by the ONU upon creation of all MAC bridge port configuration data MEs, the diagram is simplified by showing only the ANI side MEs. These MEs are used in the following manner (filtering applies to frames exiting the MAC bridge port):

- The MAC bridge port filter pre-assign table ME filters frames based on predefined addresses or Ethertype. The list of filter options is defined in clause 9.3.7.
- The MAC bridge port filter table data ME filters frames based on specific MAC addresses. MAC address learning should be disabled prior to the setting of table entries. [b-BBF TR-156] requires support only for upstream MAC address filtering.

NOTE – MAC address filtering is supported in all models (single UNI, multiple UNI, single and multiple UNI with multicast) but is only shown in Figure II.1.2.1-1 to minimize the complexity of figures depicting the more complex models.

II.1.2.1.4 Flow routing

Flow routing within the ONU is provisioned using a combination of the MAC bridge ME group and the IEEE 802.1p mapper service profile.

The MAC bridge ME group supports flow routing based on VID, with the following provisioning considerations.

- With the exception of the MAC bridge port filter MEs, the L2-OCM diagram in Figure II.1.2.1-1 is simplified to show only MAC bridge MEs that are created by the OLT. The ONU automatically instantiates several additional MEs when a MAC bridge service profile or MAC bridge port config data ME is created by the OLT. The ONU should support these MEs for completeness of overall MAC bridge functionality.
- The VLAN tagging filter data ME implements VID-based flow mapping. In cases where VID flow mapping is not required, this ME need not be created, and only a single ANI side MAC bridge port config datum and a single IEEE 802.1p mapper are needed.
- The MAC bridge model does not map subscriber data flows based on P-bits. This functionality resides in the IEEE 802.1p mapper.

The IEEE 802.1p mapper service profile supports upstream flow routing based on IEEE 802.1p priority bits, with the following provisioning considerations.

- The TP pointer attribute should be set to null, as required for a bridging-mapping model.
- The TP type attribute should be set to 0, to indicate that a bridging-mapping model is being used.

II.1.2.1.5 Message flows

Figures II.1.2.1.5-1 to II.1.2.1.5-6 depict the core message flow used to create the L2-OCM. Each figure represents a step within the flow. Each step may be performed multiple times to produce multiple ME instances. It is recommended that the depicted ordering of steps and the ordering of messages within those steps be followed to ensure that no ME pointer attribute is populated prior to the creation of its target ME. Since the GEM IW TP ME and the IEEE 802.1p mapper service profile ME point to each other, it is particularly important to create the IEEE 802.1p mapper service profile ME with null interwork TP pointers for P-bit priority attributes. Only in step 5, after the GEM IW TP MEs have been created, are the mapper's attributes populated with pointers to the MEs.

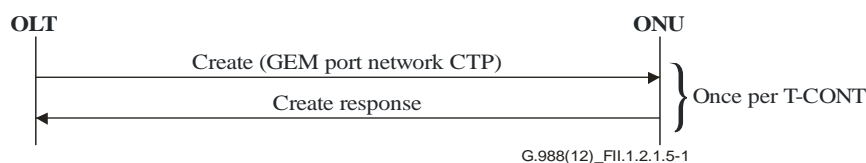

Figure II.1.2.1.5-1 – L2-OCM message flow – Step 1

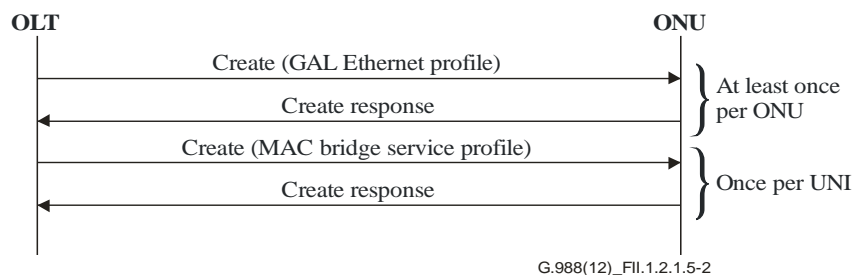

Figure II.1.2.1.5-2 – L2-OCM message flow – Step 2

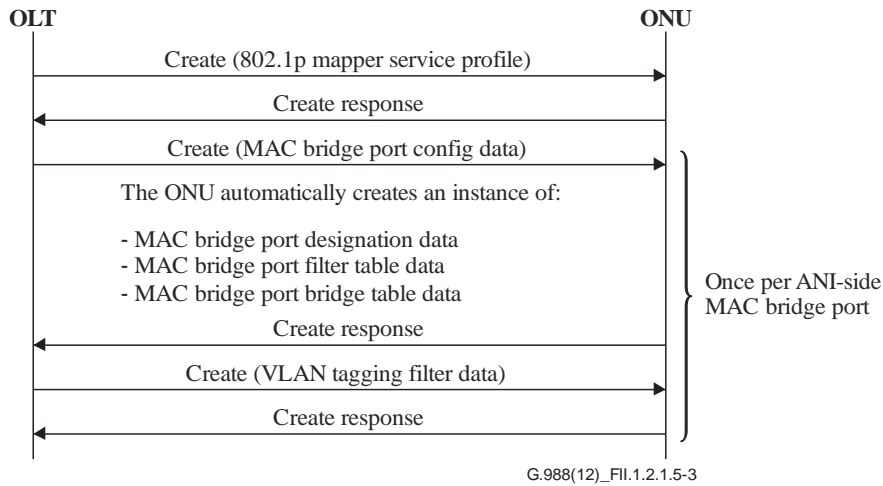

Figure II.1.2.1.5-3 – L2-OCM message flow – Step 3

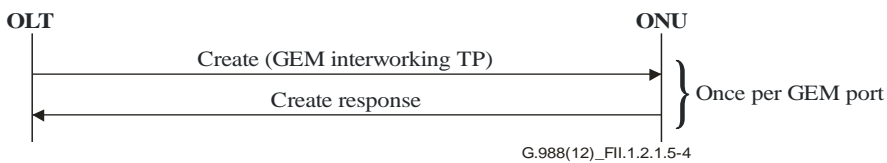

Figure II.1.2.1.5-4 – L2-OCM message flow – Step 4

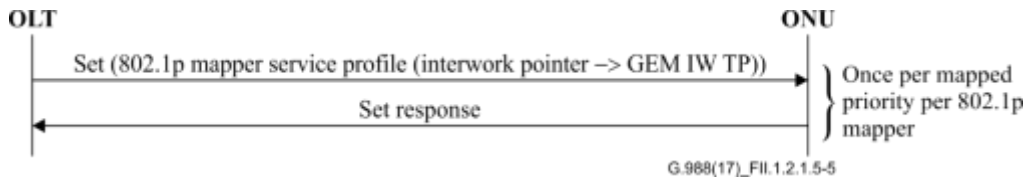

Figure II.1.2.1.5-5 – L2-OCM message flow – Step 5

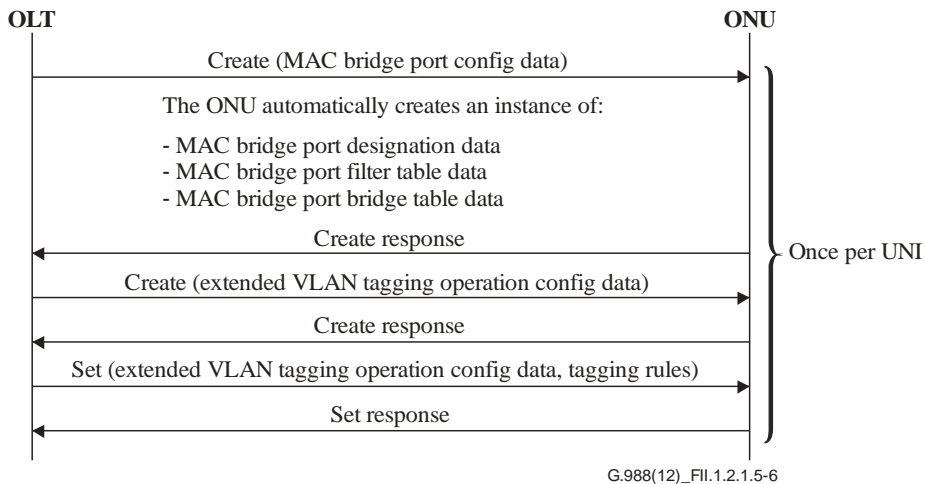
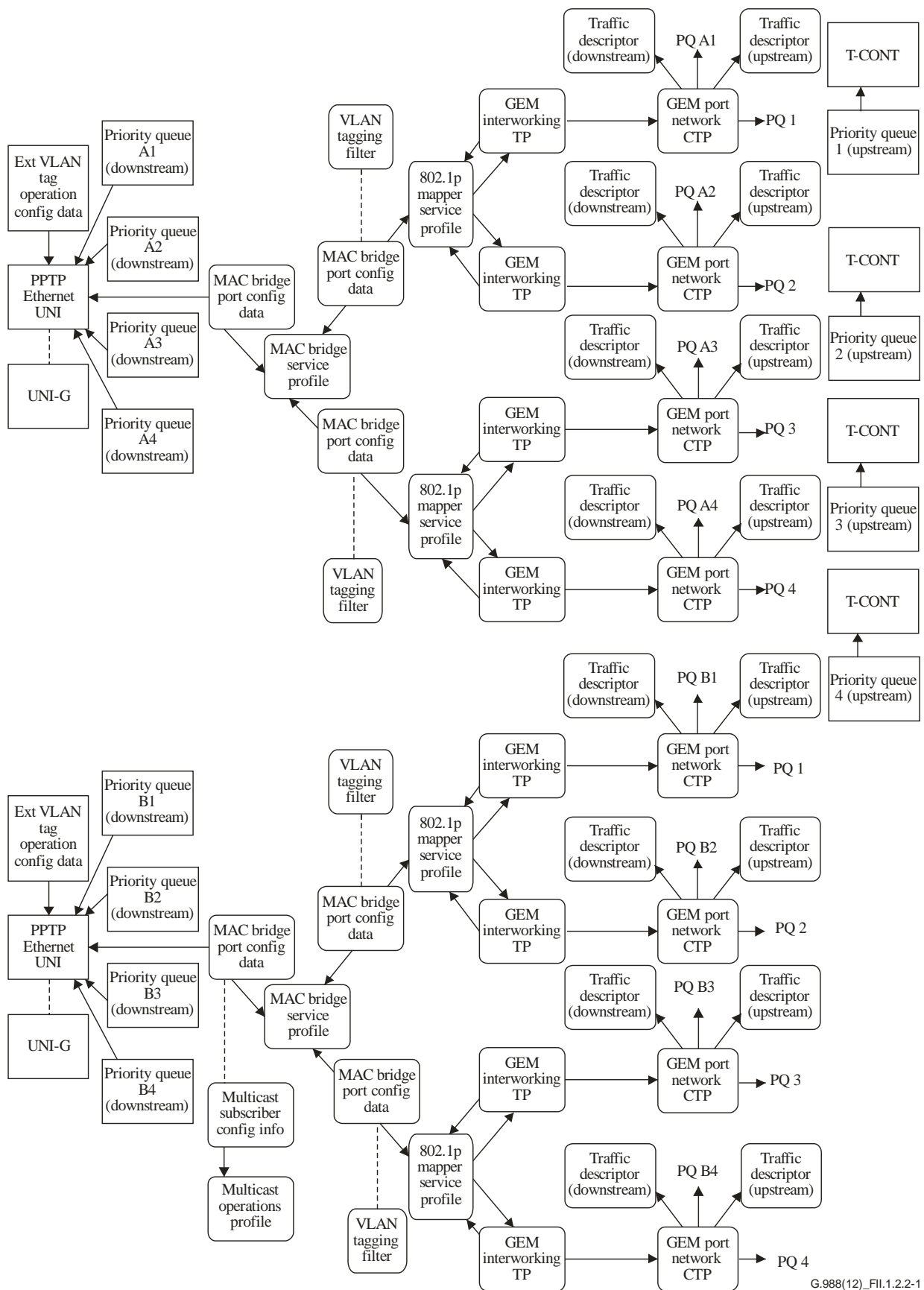

Figure II.1.2.1.5-6 – L2-OCM message flow – Step 6

II.1.2.2 Multiple UNI OMCI provisioning model

The multiple UNI L2-OCM is an extension to the single UNI model shown in Figure II.1.2.1-1. As illustrated in Figure II.1.2.2-1, the extension is accomplished by adding another instance of the single UNI L2-OCM for each UNI. It is important to note that there are still the same number of upstream queues and T-CONTs as in the single-UNI diagram.

For clarity of presentation, Figure II.1.2.2-1 does not include as many GEM ports per UNI as does Figure II.1.2.1-1. However, the underlying functionality associated with each UNI is the same.



G.988(12)_Fl1.1.2.2-1

Figure II.1.2.2-1 – Multi-UNI L2-OCM

II.1.2.2.1 T-CONT and GEM port usage

Multiple UNI L2-OCM adds support for additional UNIs without increasing the number of T-CONTs used by a single UNI L2-OCM. However, an additional set of GEM ports distinguishes the separate flows and allows per-UNI service level agreement (SLA) capability in the ONU. GEM ports are provisioned in the same manner as described in clause II.1.2.1.1.

II.1.2.2.2 Classification and marking

Classification and marking are provisioned on a per-UNI basis in the same manner as described in clause II.1.2.1.2.

II.1.2.2.3 Flow routing

Flow routing is provisioned for each UNI through the use of a distinct MAC bridge ME group and set of IEEE 802.1p mappers, as described in clause II.1.2.1.4.

II.1.2.2.4 Message flows

Provisioning of multiple UNI ONUs is accomplished through additional iterations of the message flow described in clause II.1.2.1.5.

II.1.3 Layer 2 multicast data services

Within a G-PON ONU, multicast and broadcast capabilities have two applications. The first application is traditional IGMP-controlled (or unconditional) downstream multicast traffic. The second is the transport of infrequent downstream broadcast frames arriving at the network-facing interface of the OLT. This is sometimes referred to as incidental broadcast.

Both applications require provisioning of data plane functionality. In addition, traditional multicast requires provisioning of control plane functionality. This clause describes provisioning of both data and control planes.

II.1.3.1 Data plane

A G-PON ONU can support both upstream and downstream broadcast or multicast frames. However, the OMCI has no special provision to support upstream broadcast or multicast.

In contrast, the OMCI accommodates downstream multicast and broadcast provisioning. This accommodation takes into account the point-to-multipoint nature of G-PON, which shares a GEM port across all ONUs on the PON for multicast, and another GEM port for broadcast. The sharing of GEM ports increases the downstream efficiency of the PON by avoiding the need to replicate frames destined for different ONUs. Likewise, multicast and broadcast GEM ports are common to the UNIs of a given ONU.

Traffic sent over either of these GEM ports may be contained in a VLAN, and more than one VLAN may be present. Multicast or broadcast VLANs may be segregated to different UNIs by filtering at the ANI side MAC bridge port.

NOTE – The MC operations profile includes the specification of VLANs, which may, in some cases, make ANI-side filtering unnecessary.

II.1.3.1.1 Single UNI OMCI provisioning model

Figure II.1.3.1.1-1 is the relationship diagram for L2-OCM with the addition of the MEs required for multicast/broadcast provisioning. As indicated by the dotted box in this diagram, multicast/broadcast support is built upon the model for unicast provisioning through the addition of two specialized GEM ports. One GEM port is used for multicast traffic and the other is used for incidental broadcast traffic. These are both unidirectional downstream GEM ports.

In the OMCI provisioning model, the multicast GEM port is represented by a GEM port network CTP ME connected to a multicast GEM IW TP. The multicast GEM IW TP is then connected into the

unicast model through a MAC bridge config data ME. Since no upstream traffic flows through this GEM port, there is no need for an IEEE 802.1p mapper between the MAC bridge port config data ME and the multicast GEM IW TP.

In the OMCI model, the incidental broadcast GEM port is represented by a GEM network CTP ME connected to a GEM IW TP. The GEM IW TP is then connected into the unicast model through a MAC bridge port config data ME. Since no upstream traffic flows through this GEM port, there is no need for an IEEE 802.1p mapper between the MAC bridge port and the GEM IW TP.

Associated with the MAC bridge port config data MEs connected to each GEM port are VLAN tagging filters. These MEs filter downstream broadcast frames so that only frames destined for the affected UNIs are allowed into the bridge. Since no upstream frames are delivered over the multicast GEM port, MAC address filtering is not needed on the MAC bridge port associated with the multicast GEM IW TP.

Because the multicast operations profile lists the VLANs accepted by the UNI, best practice in a [b-BBF TR-156] environment is to omit the possible VLAN tagging filter on the multicast GEM IW TP.

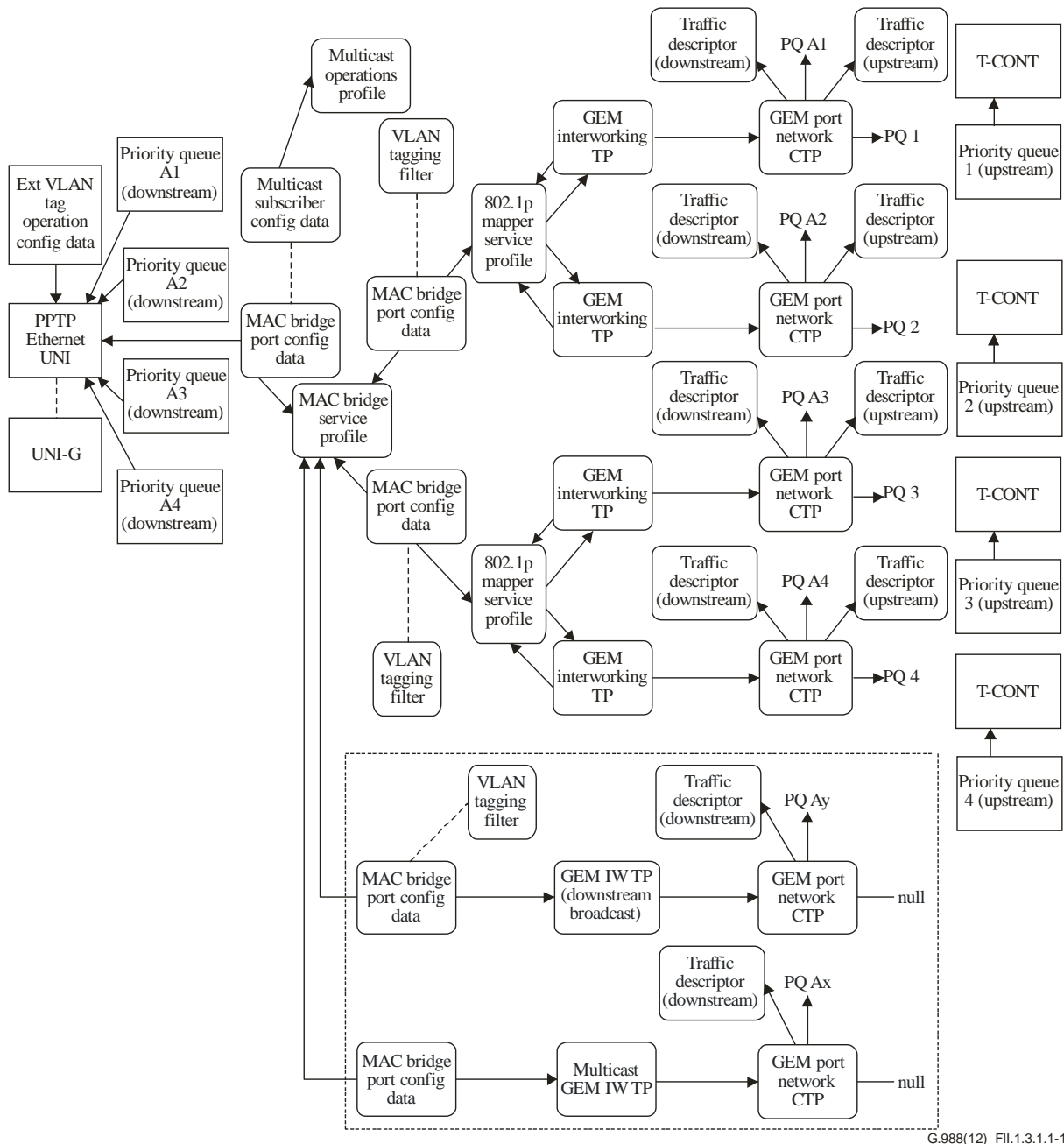

Figure II.1.3.1.1-1 – L2-OCM with multicast

II.1.3.1.1.1 Provisioning considerations

Both GEM port network CTP MEs are provisioned with the following considerations.

- The direction attribute should be set to 2, indicating that the associated GEM port is unidirectional downstream.
- The T-CONT pointer attribute is not meaningful.
- The traffic management pointer for the upstream attribute is not meaningful.
- The traffic descriptor profile pointer for the upstream attribute is not meaningful.
- The priority queue pointer for the downstream attribute is used as a template for all UNIs that subscribe to this GEM port. Specifically, if this attribute points to priority queue 1 for UNI *N*, then it implicitly refers to priority queue 1 for all affected UNIs.

The multicast GEM IW TP ME is provisioned with the following considerations.

- The IW option attribute should be set to zero, indicating a "don't care".

- The service profile pointer attribute is set to zero and not used.
- The IW TP pointer attribute is set to zero and not used.
- The PPTP counter attribute is set to 0xFF and not used.
- The GAL profile pointer and GAL loopback configuration attributes are set to zero and not used.

The GEM IW TP ME that is used for incidental broadcast is provisioned with the following considerations.

- The IW option attribute should be set to 6 to indicate broadcast.
- The service profile pointer attribute should be set to zero.
- The IW TP pointer attribute should be set to zero.
- The GAL profile pointer attribute should be set to zero.
- The GAL loopback configuration attribute should be ignored.

II.1.3.1.1.2 Message flows

Figure II.1.3.1.1.2-1 shows the message flow used to add multicast or incidental broadcast to the model.

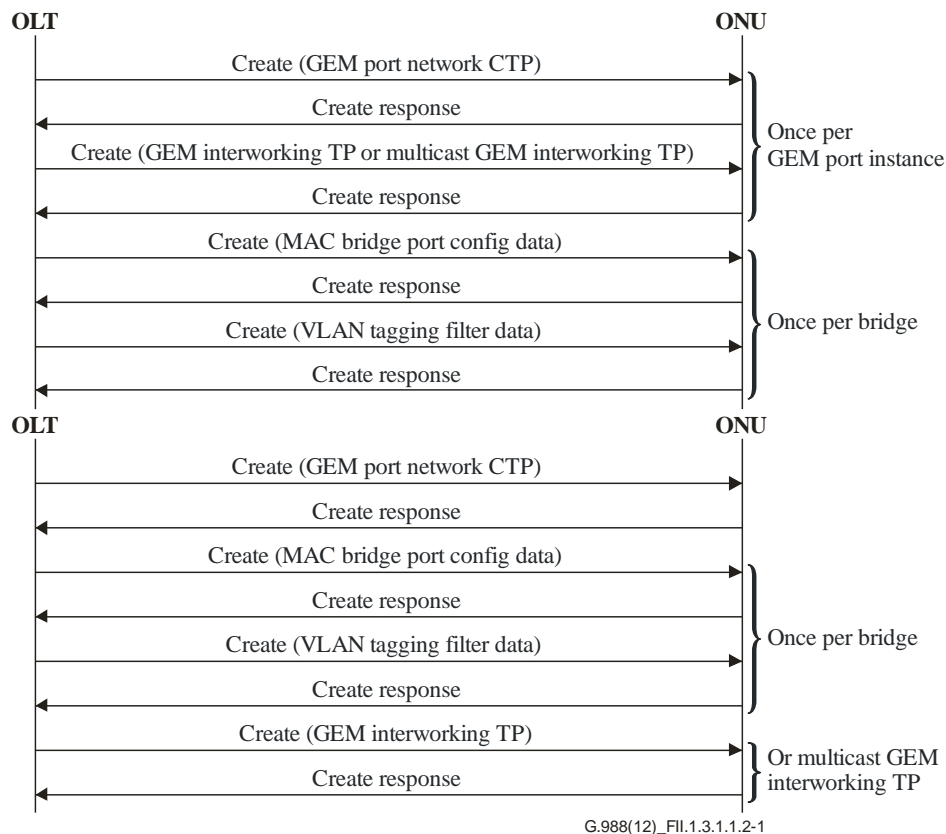

G.988(12)_FII.1.3.1.1.2-1

Figure II.1.3.1.1.2-1 – Data plane provisioning

II.1.3.1.2 Multiple UNI OMCI provisioning model

Figure II.1.3.1.2-1 is the relationship diagram for multicast and incidental broadcast in an ONU with multiple UNIs. The only notable difference between Figure II.1.3.1.2-1 and the model of Figure II.1.3.1.1-1 is that the multicast GEM port and the incidental broadcast GEM port are associated with multiple bridges, thereby sharing a single multicast or broadcast flow across multiple UNIs.

The operation of the model is functionally identical to that described in clause II.1.3.1.1.

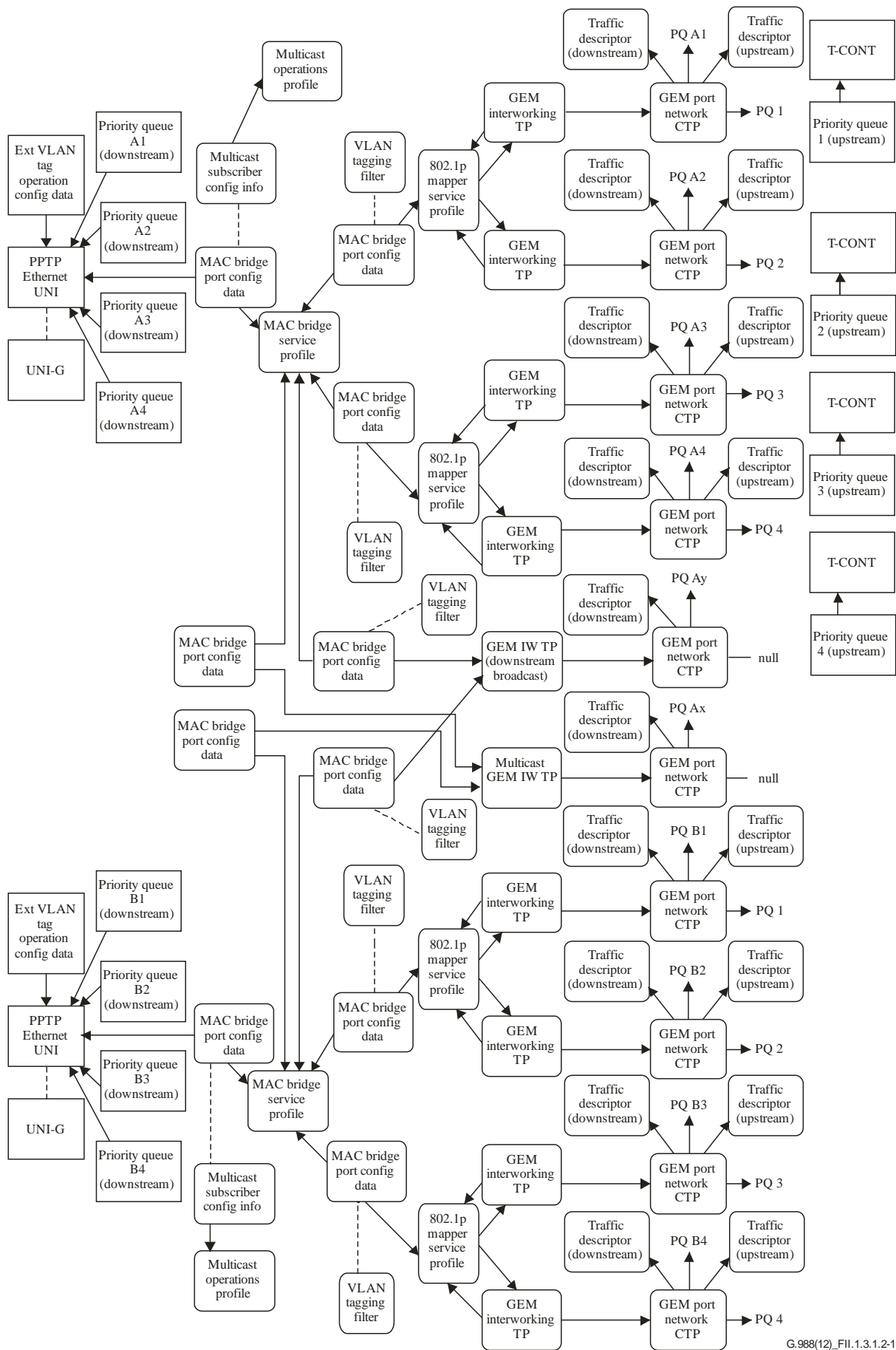

G.988(12)_FII.1.3.1.2-1

Figure II.1.3.1.2-1 – Multi-UNI L2-OCM with multicast

II.1.3.2 Control plane

Implementation of traditional multicast services also requires support for IGMP on the control plane. The multicast subscriber config info ME and the multicast operations profile ME are used to provision this support. As shown in Figure II.1.3.1.1-1, these MEs are associated with the MAC bridge port config data ME on the UNI side of the OMCI model. The following considerations should be used when provisioning these MEs.

- Permitting multicast on a subscriber UNI does not require the existence of a multicast subscriber config info ME. The default action for a bridge port and associated UNI is to allow the forwarding of frames in the multicast address range. If desired, the blocking of frames in the multicast address range is achieved through the use of the MAC bridge port filter table data ME or MAC bridge port filter pre-assign table ME.
- The dynamic access control list table and static access control list table attributes of the multicast operations profile ME include fields for GEM port and VLAN. These should be provisioned consistently with the multicast flow through its GEM port network CTP and possible VLAN tagging filters. The consequence of inconsistent provisioning is undefined.
- The ME type attribute of the multicast subscriber config info ME should be set to zero to indicate an association with a MAC bridge port config data ME.
- The IGMP version attribute of the multicast operations profile ME should be set to 3 to indicate that the ONU will be using IGMP v3, as required by [b-BBF TR-156].
- A bandwidth-based multicast SLA can be implemented using the max multicast bandwidth and bandwidth enforcement attributes in the multicast subscriber config info ME in conjunction with the imputed group bandwidth field of the dynamic access control list table in the multicast operations profile ME.

Support of multicast preview or paid preview functions also requires configuration in the control plane. The multicast subscriber config info ME is used to provision this support, including the forwarding of preview groups to UNIs when allowed, and otherwise blocking them.

II.2 Dual-managed ONUs

In many cases, the ONU is physically separated from the equipment connected at the ultimate UNI, and the ONU is managed via the OMCI, while the UNI equipment is managed by other means. For example, the ONU may be connected to an RG via an Ethernet or xDSL interface, with the ONU managed by the OMCI and the RG managed by [BBF TR-069]/[BBF TR-369]. As another example, the ONU in a PON-fed digital subscriber line access multiplexer (DSLAM) may be connected to the DSLAM via an Ethernet interface, with the ONU managed by the OMCI and the DSLAM managed by the SNMP. In these examples, the demarcation point between the two management domains is clear: it is the Ethernet interface.

However, there are cases where the ONU and the UNI equipment are physically integrated into the same device, and there may not be a physical interface between the two. A dual-managed ONU is defined as two management domains that may control the same physical device. The VEIP ME is the data plane demarcation point between the two management domains, with the OMCI managing everything from the VEIP to the ANI. The management protocol on the other side is not specified.

Figure II.2-1 shows an OMCI model for a dual-managed ONU/RG, which is an extension of the layer 2 service in clause II.1. There are several important features of this model as follows.

- 1) As with a physical Ethernet, multiple traffic classes can flow across the virtual Ethernet interface, and each traffic class has an associated priority queue. One implication of this is that extra work may be involved to multiplex/de-multiplex data on both sides of the VEIP. For example, in the upstream direction, the RG conceptually separates traffic by class for queueing and scheduling, then merges all classes into a single stream to pass through the VEIP; the ONU again separates traffic by class to direct to the appropriate upstream queue.

- 2) The same number of virtual Ethernet interfaces are used as there would be physical Ethernet interfaces between the OMCI domain and the non-OMCI domain if the domains existed on separate devices. For example, there is typically one virtual Ethernet interface per RG.
- 3) The virtual Ethernet interface represents the termination of the ONU data plane, whereas the associated IP host config (IPHC) data ME represents the termination of the ONU management plane. The IPHC is the container for the IP address, mask, gateway and DNS information in the OMCI domain, and in the dual-managed ONU, it may also be used to establish or determine the same information in the non-OMCI domain. For a detailed discussion of IPHC provisioning, refer to clause II.4.

The IPHC is conditionally required for the dual-managed ONU, depending on the IP stack configuration in the integrated device. Three configurations are possible as follows.

- a) Dual stack, where each management domain contains a unique IP stack. An IPHC is present for OMCI use if the ONU supports native IP-based services such as VoIP or IP pseudo-wire. A separate IPHC exists for the non-OMCI management domain if IP connectivity is to be provided by the OMCI.
 - b) Single stack, shared between the two domains. An IPHC exists if either the OMCI domain provides native IP-based services or if the non-OMCI domain requires the OMCI to set up its IP connectivity.
 - c) A single stack, used only by the non-OMCI domain. This case requires an IPHC only if the non-OMCI domain needs the OMCI to establish its IP connectivity.
- 4) The presence of the virtual Ethernet interface ME provides an unambiguous way for the ONU to represent its nature to the OLT during the OMCI MIB discovery process.
 - 5) Not more than one GSP may be created by the OLT per VEIP. The GSP provides a way for the OLT to discover the status and configuration information of a non-OMCI management domain within an ONU. This ME contains two table attributes: status document table and configuration document table. The OLT reads these tables to obtain an XML representation of the non-OMCI management domain status and configuration. Whenever the text in this table changes, and after a soak interval, the ONU issues an AVC to the OLT. The rate at which AVCs are issued is controlled by the AVC rate control attribute.
 - 6) The ONU automatically creates a UNI-G for each VEIP.
 - 7) The ONU automatically creates physical ports (PPTPs) and their associated UNI-Gs that are visible and manageable only via the OMCI. As an option, the ONU may also create PPTP/UNI-G pairs that are either dedicated to a non-OMCI domain or that may flexibly be assigned to either management domain by the OLT. If the ONU does not automatically create such MEs, they must be created by other means, which lie beyond the scope of this Recommendation. The OLT cannot create them via the OMCI.

The capability of the UNI-G/PPTP is advertised by the ONU in the management capability attribute of the UNI-G ME. If a UNI-G/PPTP is assignable to a specific domain, the OLT can set the UNI-G non-OMCI management identifier to assign the PPTP/UNI-G to a non-OMCI domain.

The dual-managed ONU OMCI data plane model is provisioned in the same way as exemplified in clause II.1.2.

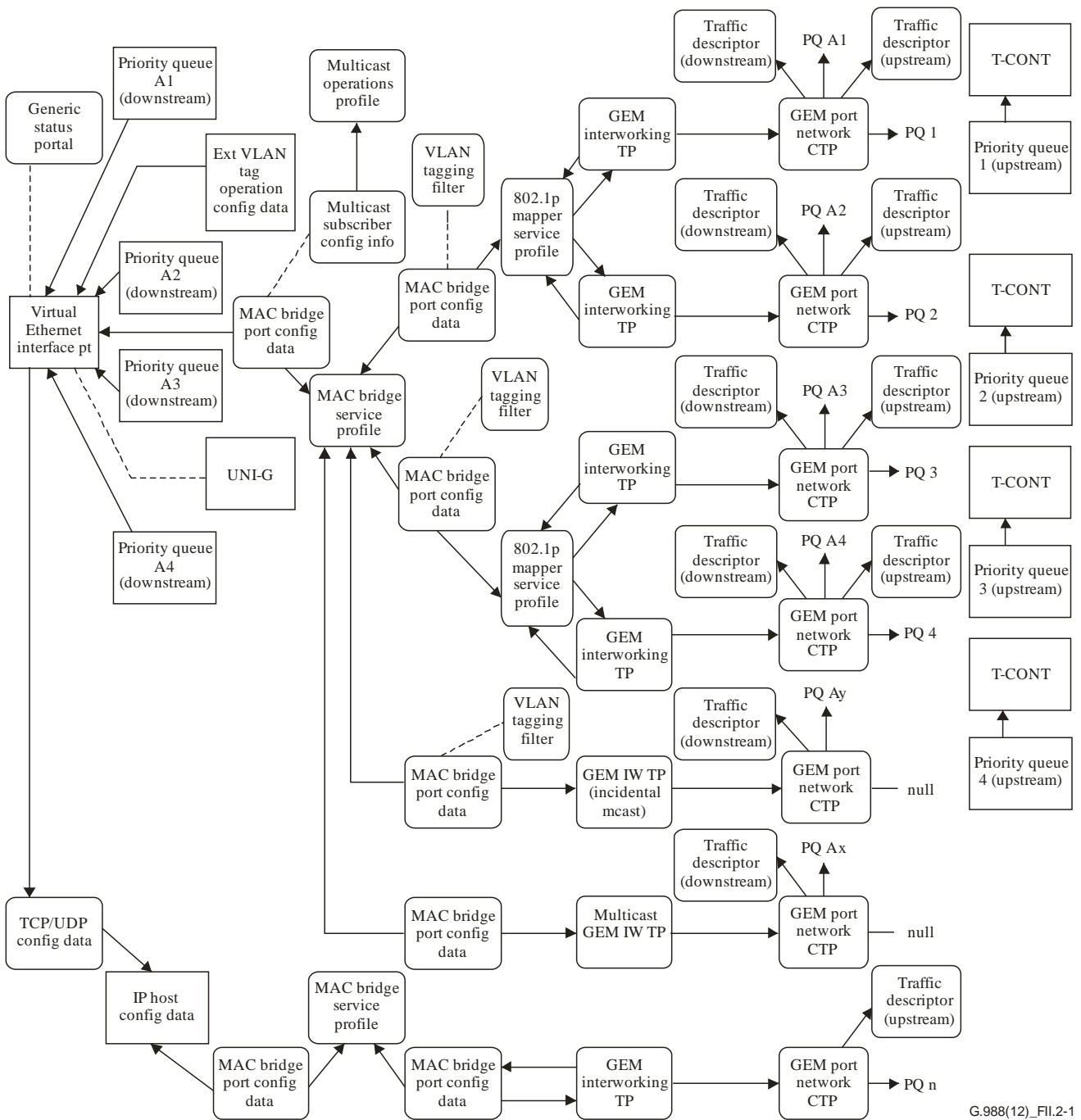

Figure II.2-1 – Dual-managed ONU model

II.3 Traffic management

II.3.1 Requirements and techniques

II.3.1.1 Introduction

G-PON contains a number of features related to QoS, such as policing, shaping, queuing and scheduling. These features can be applied to a variety of different QoS architectures such as diffserv, metro Ethernet and [b-BBF TR-101]. This clause exemplifies how to map G-PON QoS features to diffserv or metro Ethernet services.

II.3.1.2 Diffserv over G-PON

[b-IETF RFC 2475] outlines the diffserv, or differentiated services, model for providing QoS. The diffserv model specifies that traffic is classified and conditioned (metered, shaped, policed or re-

marked) at the edge of the QoS domain and then queued and scheduled for forwarding at each node in the interior of the QoS domain based on the per-hop behaviour of the class. This relative QoS on a per-hop basis instead of a network-wide basis is a fundamental property of the diffserv model.

[b-IETF RFC 2475] defines the basic framework for diffserv; additional RFCs define the behaviour of the most commonly used traffic classes, EF in [IETF RFC 3246] and [b-IETF RFC 3247], and AF in [IETF RFC 2597].

AF includes the concept of drop precedence, by which traffic can be admitted and marked in such a way that traffic will be dropped in a prescribed precedence within a class when congestion occurs. AF defines four classes, each with three drop precedence levels. With AF, it is important that packets within a class not be reordered.

To implement diffserv, traffic must be classified and policed/marked at the ingress and egress of the QoS domain. A marker function that can be used for diffserv is specified in [b-IETF RFC 4115], the two-rate three colour marker system (trTCM). The trTCM marker function has two associated rates, the CIR and the EIR. A dual token bucket algorithm is used for this colour marking. If the packet length is less than the number of tokens in the committed token bucket, the packet is declared green; else if the packet length is less than the number of tokens in the excess token bucket, the packet is declared yellow; otherwise, the packet is declared red. These three colours are mapped to the three drop precedences – as an example, green traffic could be marked with drop precedence 1, with yellow traffic marked with either drop precedence 2 or 3. During times of congestion, the ONU drops yellow packets with a higher probability than green packets. In G-PON, the PIR is equal to the sum of the CIR and EIR.

EF is intended for constructing low-latency and low-loss services, in that it is assumed that packets marked with the EF class can pre-empt other traffic within limits. EF can be implemented with a simple priority queue, where the output of the EF priority queue is given priority over other queues, but where the input to the EF priority queue is governed by a token bucket to prevent starvation of the other queues. As with AF, it is important that EF class packets not be reordered.

Assuming the domain edge is the ONU, each diffserv CoS should be assigned its own T-CONT. In this way, the OLT can schedule grants to provide fair access to the shared G-PON bandwidth. For a given ONU, flows from different users but within the same CoS should be policed separately and then placed in the same queue. OLTs should assign bandwidth using the extended bandwidth assignment model for DBA as described in the respective TC layer specification. T-CONTs containing flows from the same class but from different ONUs should be assigned the same priority at the OLT, but should be assigned weights proportional to the cumulative data rate of those flows.

Figure II.3.1.2-1 shows an example of the distribution of upstream functionality between the ONU and the OLT for a diffserv architecture.

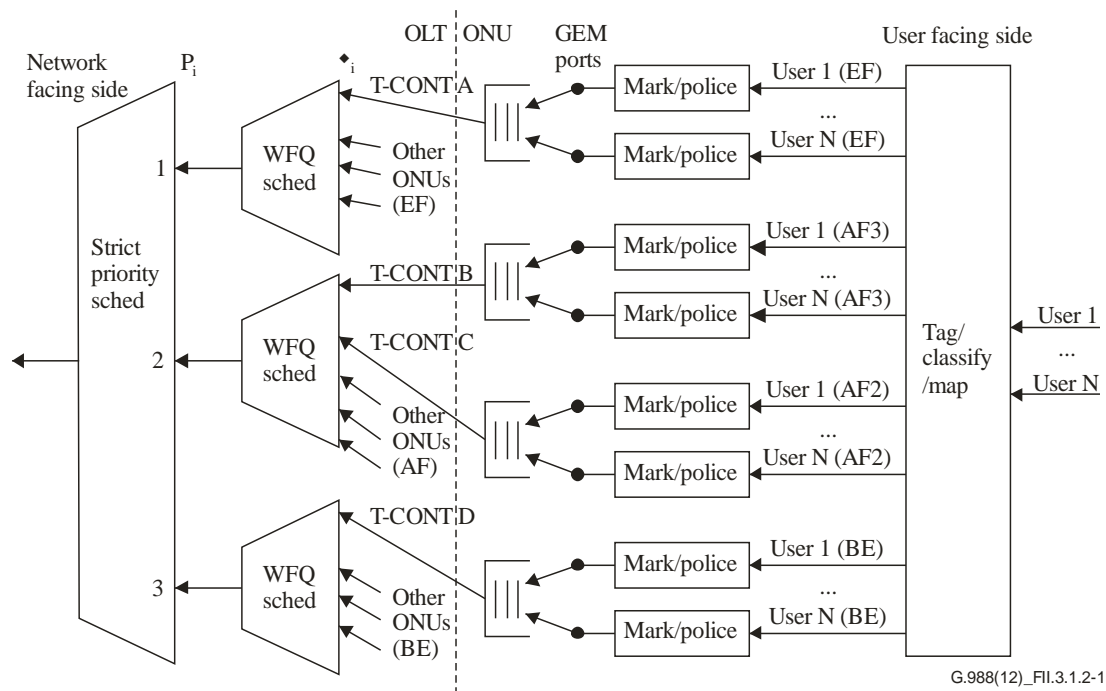

NOTE 1 – Weighted fair queueing (WFQ) weights should be configurable.

NOTE 2 – WFQ and strict scheduling implemented with extended bandwidth assignment DBA.

Figure II.3.1.2-1 – Block diagram example of diffserv upstream QoS for G-PON

The L2-OCM provisioning model defined in clause II.1 supports diffserv. In this model, the traffic descriptor ME is used to specify the treatment of each traffic class in the ONU. The following considerations should be used when provisioning the traffic descriptor.

- For EF traffic, the CIR and PIR attributes should be set to the CIR of the EF traffic profile.
- For AF traffic, the CIR attribute should be set to the CIR of the AF traffic profile. The PIR attribute should be set to the sum of the CIR and EIR of the AF traffic profile.
- For BE traffic, the CIR attribute should be set to the CIR of the BE traffic. The PIR attribute should be set to the sum of the CIR and EIR of the BE traffic profile.
- The colour mode attribute should be set to 1 to indicate a colour aware traffic flow.
- The ingress colour marking and egress colour marking attributes should be set to 7 to indicate DSCP AF drop precedence marking.

II.3.1.3 Metro Ethernet over G-PON

[b-MEF 10.2] describes an Ethernet virtual service (EVS), which is a layer 2 connection between customer edge devices. In the MEF model, the edge of the QoS domain is defined at the ONU UNI, where the marking/policing function is carried out. [b-MEF 10.2] does not define any specific per-hop behaviour. Instead, it focuses on end-to-end service level specifications in terms of delay, delay variation and packet delivery ratio. In this architecture, it is assumed that the UNI is a customer-facing [IEEE 802.3] (Ethernet) interface on the ONU.

The traffic management defined by [b-MEF 10.2] employs a two-rate, three-colour policer, which is identical to [b-IETF RFC 4115] if the MEF 10.2 variable CF is set to 0. The two rates are CIR and EIR, and are defined for both ingress frames and egress frames. If the frame (ingress or egress) length is less than the number of tokens in the committed token bucket, the frame is declared green; else if the frame length is less than the number of tokens in the excess token bucket, the frame is declared yellow; otherwise, the frame is declared red. This policing takes place at the UNI.

According to [b-MEF 10.2], traffic marked green is to be delivered according to the service level specification, traffic marked yellow may be delivered, but is not bound to the service level specification, and traffic marked red is to be dropped.

[b-MEF 10.2] does not specify the means by which an Ethernet virtual connection (EVC) is designated within a service provider's network. However, this appendix recommends using [IEEE 802.1ad] double VLAN tags: C tags for customer use and S tags for service provider use.

At the UNI, a VLAN S-tag is added to or translated on ingress frames (from the customer) and P bits are set appropriately. The S tag is removed or translated from egress frames (towards the customer). The mapping to S tags should be one per EVC.

II.3.1.3.1 Provisioning considerations

Each S-tag P-bit value (CoS) should be assigned its own T-CONT. In this way, the OLT can schedule grants to provide fair access to the shared G-PON bandwidth. For a given ONU, flows from different users but within the same CoS should be policed separately and then placed in the same queue. OLTs should assign bandwidth using the extended bandwidth assignment model for DBA (Ref: Respective TC layer specification). At the OLT, T-CONTs containing flows from the same class but from different ONUs should be assigned the same priority, but should be assigned weights proportional to the cumulative data rate of those flows.

The DEI bit should indicate that yellow frames are eligible for discard. Red frames should be dropped in the ONU and never forwarded to the OLT. It is important that frames not be reordered. Therefore, all traffic for a given CoS (both green and yellow) must be kept in a single logical queue. During times of congestion, the ONU will drop yellow packets with a higher probability than green packets.

The L2-OCM provisioning model defined in clause II.1 supports [b-MEF 10.2]. In this model, the traffic descriptor ME is used to describe the behaviour of each traffic class in the ONU. The following considerations should be used when provisioning the traffic descriptor.

- For each EVC, the CIR and PIR attributes should be set to the appropriate values for that EVC.
- The colour mode attribute should be set to 1 to indicate a colour-aware traffic flow.
- The ingress colour marking and egress colour marking attributes should be set to 2 to indicate DEI drop precedence marking.

II.3.2 Traffic management in [b-BBF TR-156]

This clause is a high-level mapping from the traffic management text of [b-BBF TR-156] to the OMCI. In this clause, numbers in brackets (e.g., [R-x]) indicate the corresponding requirement number in [b-BBF TR-156].

NOTE 1 – The [b-BBF TR-156] text is paraphrased in this clause. In the case of inconsistencies between this clause and [b-BBF TR-156], [b-BBF TR-156] takes precedence.

NOTE 2 – The details in [b-BBF TR-156] refer to [ITU-T G.984.x]. The same requirements largely pertain to subsequent systems.

In this clause, traffic management is defined to comprise the following components: 1) traffic classification; 2) rate limiting; 3) queueing; 4) scheduling; and 5) T-CONT assignment. [b-BBF TR-156] assumes that there will always be a broadband network gateway (BNG) and possibly an Ethernet aggregation node on the network side of an OLT, and an RG on the user side of an ONU. Although the models are similar, this clause does not consider G-PON-fed DSLAMs.

The high-level architectural view considered in this clause is given in Figure II.3.2-1 (from [b-BBF TR-156]). The OLT and ONU are regarded as a distributed access node. It is possible for the ONU and RG to be integrated.

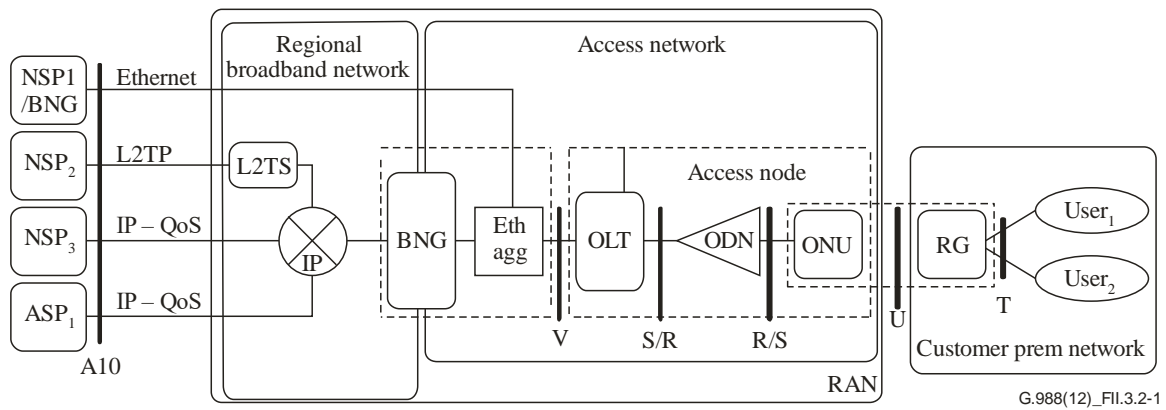

Figure II.3.2-1 – High-level architecture

II.3.2.1 Traffic classification

Downstream, GEM ports are used to differentiate between traffic classes for a particular user port. Each GEM port identifies a specific traffic class going to a specific UNI on a specific ONU. Therefore, a given GEM port carries no more than one traffic class [R-6, R-7].

In the upstream direction, the ONU must support deriving VLAN priority (P-bit) markings based on the user port, VID, received P-bits and Ethertype [R-48], and the ONU should support deriving P bits based on user port, VID and received DSCP value [R-49]. The ONU must support mapping traffic flows into GEM ports based on the user port, VLAN ID or VLAN priority [R-51].

The OLT and ONU must support at least four traffic classes [R-46], and should support at least six [R-47].

II.3.2.2 Rate limiting

The ONU and OLT must support rate limiting of IGMP messages received from user ports on a multicast VLAN [R-87].

The ONU and OLT must support rate limiting of CFM (connectivity fault management) Ethernet OAM messages arriving on a user port; the rate must be configurable per port [b-BBF TR-101] [R-268]. CFM provisioning is symmetric: the expected message receive rate is equal to the message transmit rate. High message rates may interfere with traffic or overload the ONU processor and are to be used judiciously.

II.3.2.3 Queueing

During periods of queue congestion, the ONU and OLT must be capable of dropping (not queueing) packets marked as drop eligible, with a probability higher than that of packets not marked as drop eligible. Drop eligibility (drop precedence) can be indicated either by VLAN priority bits [R-54], or by the DEI bit (802.1ad) [R-55]. These packets may have drop eligibility marked externally (e.g., by the BNG or RG).

The OLT must support one downstream queue per traffic class per PON, and at least four traffic classes [R-58]. Likewise, the OLT must provide one upstream queue per network-facing port for each of at least four traffic classes [R-66]. The OLT should support six traffic classes in each direction [R-62], [R-68].

The ONU must support a downstream queue per user-facing port for each of at least four traffic classes [R-56]. The ONU must provide an upstream queue for each of at least four traffic classes [R-57]. The ONU should support at least six traffic classes [R-60], [R-61].

The OLT must and the ONU should support setting the maximum size/depth of all queues [R-73].

II.3.2.4 Scheduling

At a minimum, [b-BBF TR-156] requires strict priority scheduling among queues. In the downstream direction, the OLT must support strict priority scheduling among at least four queues for each PON [R-63], and the ONU must support strict priority scheduling among at least four queues for each user-facing port [R-63]. In the upstream direction, the OLT must support strict priority scheduling among at least four queues for each network-facing port [R-70].

Weighted scheduling among queues is an objective. The OLT and ONU should support scheduling of queues according to their assigned priority and weight, with the following conditions: 1) multiple queues may be assigned to the same priority; 2) queues assigned the same priority must be scheduled according to a weighted algorithm; and 3) weights must be assigned through provisioning [R-65], [R-72]. Non-empty queues at the same priority receive capacity in proportion to their weights.

The OLT must support the basic traffic descriptor parameters RF, RA, RM, and χ_{AB} as specified in [ITU-T G.984.3] [R-44]. The OLT must support the extended traffic descriptor parameters P_i and ω_i as specified in [ITU-T G.984.3] [R-45], which are used to implement the strict priority and weighted scheduling of T-CONTs. These parameters must be configurable [R-44], [R-45]. The OLT must support T-CONT types 1, 2, 3 and 4 [R-59].

NOTE – T-CONT type numbering is purely a documentation convenience. In actual use, the T-CONT type is not represented by any provisioned attribute on the PON.

The ONU-G ME must at least support traffic management option 0 (priority controlled).

II.3.2.5 T-CONT support

By providing a T-CONT for each traffic class, the ONU must support four upstream traffic classes [R-67], and should support six [R-69].

II.3.2.6 OMCI model

The following OMCI MEs and attributes support the functionality of this clause.

Priority queue

- Related port: For upstream, the first 2 bytes point to the associated T-CONT, and the last 2 bytes are "don't care" ([b-BBF TR-156] specifies only one priority queue for each T-CONT, which performs no scheduling). For downstream, the first 2 bytes point to the slot and port of the specific downstream port, and the last 2 bytes indicate the strict priority associated with this priority queue.
- Traffic scheduler pointer: Set to the default null pointer.
- Weight: For upstream, this attribute should remain at the default value of 1 ([b-BBF TR-156] specifies only one priority queue for each T-CONT, which performs no scheduling). For downstream, this attribute should be set to the weight associated with this priority queue, or set to 1 if weighted scheduling is not used.
- Packet drop queue thresholds: These are used to implement the BBF TR-156 drop eligibility (drop precedence) requirements.

Packet drop max_p

Queue drop w_q

- Drop precedence colour marking: Must be set either to one of the PCP modes or to DEI.

ONU-G

- Traffic management option: Read-only, defined by the ONU architecture. 0 indicates priority-controlled mode. Even if the value is 2, indicating the ability to perform in either priority or rate-controlled mode, [b-BBF TR-156] uses only the priority-controlled mode.

T-CONT

- Policy: This value is a "don't care." [b-BBF TR-156] specifies only one priority queue for each T-CONT, which performs no scheduling.

Figures II.3.2.6-1 and II.3.2.6-2 give examples of the downstream and upstream traffic management functionality.

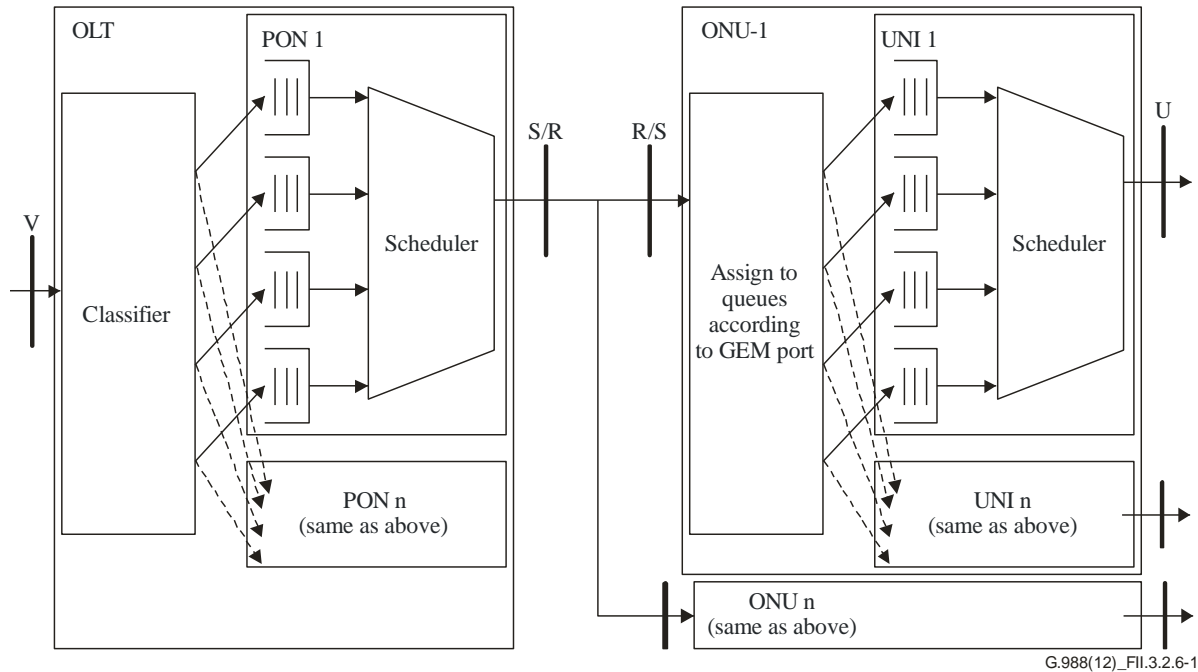

Figure II.3.2.6-1 – Downstream functionality example

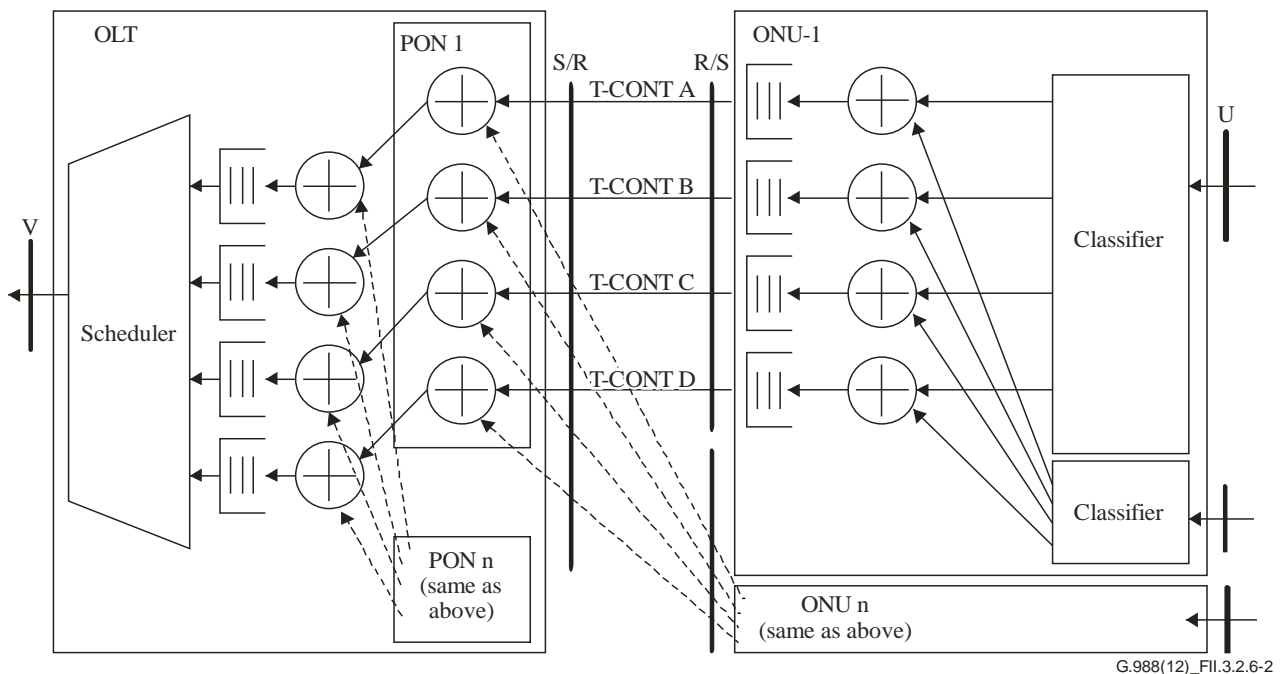

Figure II.3.2.6-2 – Upstream functionality example

II.3.3 Beyond [b-BBF TR-156]

There are non-BBF TR-156 applications where it is desirable to have multiple queues per T-CONT and to have scheduling between these queues. One example would be the multiple dwelling unit (MDU) ONU, where there are multiple UNIs, each of which serves a different subscriber. The service

provider may wish to configure the ONU such that no single UNI within the ONU consumes more than its fair share of the bandwidth assigned to a given traffic class. This could be done for a given traffic class by giving each UNI a separate queue, then using some form of weighted scheduling (like WRR) to schedule traffic from the queues into the T-CONT for that traffic class.

Another example would be where the service provider assigns a VLAN to a T-CONT, but wishes to give a different priority to different flows within that T-CONT. This could be done by mapping specific P-bit values within that VLAN to different queues, then using strict priority to schedule traffic from the queues into the T-CONT for that VLAN. As a specific example, P-bits value 1 could be mapped to one queue, P-bits value 3 could be mapped to another queue, and strict priority could be used to schedule between the two queues. From the OLT's point of view, all traffic in this T-CONT would be a single traffic class that could be governed by a VLAN-level SLA.

This clause describes the best practice for implementing scheduling among multiple queues associated with a given T-CONT. Only a single level of scheduling is considered; hierarchical scheduling is not considered. The clause considers only two scheduling disciplines for each multi-queue T-CONT.

- 1) Strict priority scheduling: The queues are served in the specified priority order. This corresponds to the strict priority value of the scheduling policy attribute.
- 2) Weighted scheduling: Back-logged (non-empty) queues are served in proportion to their specified weights. This corresponds to the WRR value of the scheduling policy attribute.

Prior to 2009, the OMCI specified a fixed set of priority queue MEs and traffic scheduler MEs associated with each T-CONT ME, assuming these resources were fixed in the ONU's architecture. In 2009, a flexible means of mapping between queues, schedulers and T-CONTs was added, allowing a pool of queues to be attached to any scheduler and T-CONT in the same slot. Clause II.3.3.1 describes the best practice for using the fixed method. Clause II.3.3.2 describes the flexible alternative.

For legacy reasons, the fixed method is the default – the ONU must have a factory default configuration of queues/schedulers/T-CONTs that would be usable by an OLT that only supports the fixed method, and the OLT must work with ONUs that only support the fixed method. The flexible method is considered an extension of the fixed method, and may be used when supported by both the ONU (as indicated by the QoS configuration flexibility attribute in the ONU2-G ME) and the OLT.

II.3.3.1 Default practice – Fixed queue/scheduler/T-CONT

The default ONU architecture assumes a fixed set of priority queue MEs and traffic scheduler MEs associated with each T-CONT ME. The pointers between traffic scheduler MEs and T-CONT MEs are fixed, but the priority queue MEs can be provisioned to point either to the associated T-CONT or to one of the associated traffic schedulers. The scheduling policy of each T-CONT ME and each traffic scheduler ME is fixed. It is not assumed that all T-CONTs have the same number of priority queue MEs and traffic scheduler MEs. The OLT must determine the ONU's queue configuration and connect the GEM port network CTP MEs accordingly.

Not all T-CONTs in an ONU must support these scheduling capabilities. However, in order to be interoperable, any T-CONT that supports the scheduling capabilities of this clause must have at least two priority queue MEs and one of the two following configurations.

- 1) Traffic scheduler not present: Only a single scheduling discipline is supported, as determined by the T-CONT policy attribute. The priority queue MEs are connected directly to the T-CONT ME.

- 2) Traffic scheduler present: The traffic scheduler ME and T-CONT ME must have opposite policy attributes, meaning that one has the strict priority policy and the other has WRR. Both scheduling disciplines are therefore supported. Priority queue MEs can be connected to either the traffic scheduler ME or directly to the T-CONT ME to determine the scheduling discipline.

Furthermore, to be interoperable, the read-only parameter values described in clauses II.3.3.1.1 and II.3.3.1.2 are required.

II.3.3.1.1 ONU provisioning considerations

The MEs used in this clause for traffic scheduling are the priority queue, traffic scheduler and T-CONT.

Figure II.3.3.1.1-1 shows an example of a T-CONT with three queues and no traffic scheduler. Each queue is directly connected to the T-CONT ME. The scheduling discipline is determined from the policy attribute of the T-CONT ME, in this case weighted (policy = WRR).

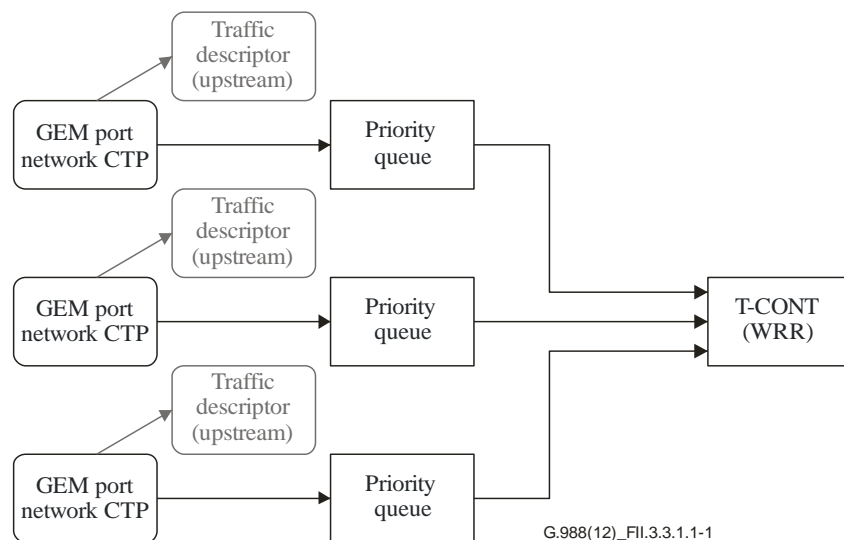

Figure II.3.3.1.1-1 – Example of weighted scheduling with three queues per T-CONT and no traffic scheduler, queues connected directly to T-CONT

Figure II.3.3.1.1-2 shows an example of a T-CONT with four queues and a traffic scheduler. Because each queue is connected to the traffic scheduler, the scheduling discipline is determined from the policy attribute of the traffic scheduler ME, in this case weighted (policy = WRR).

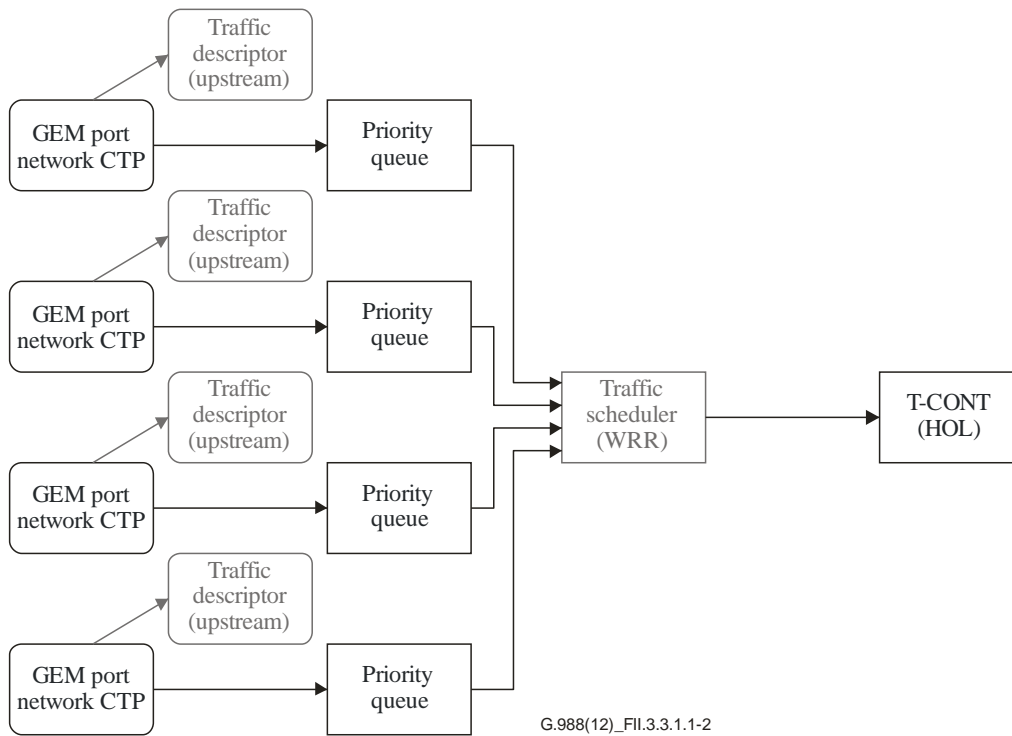
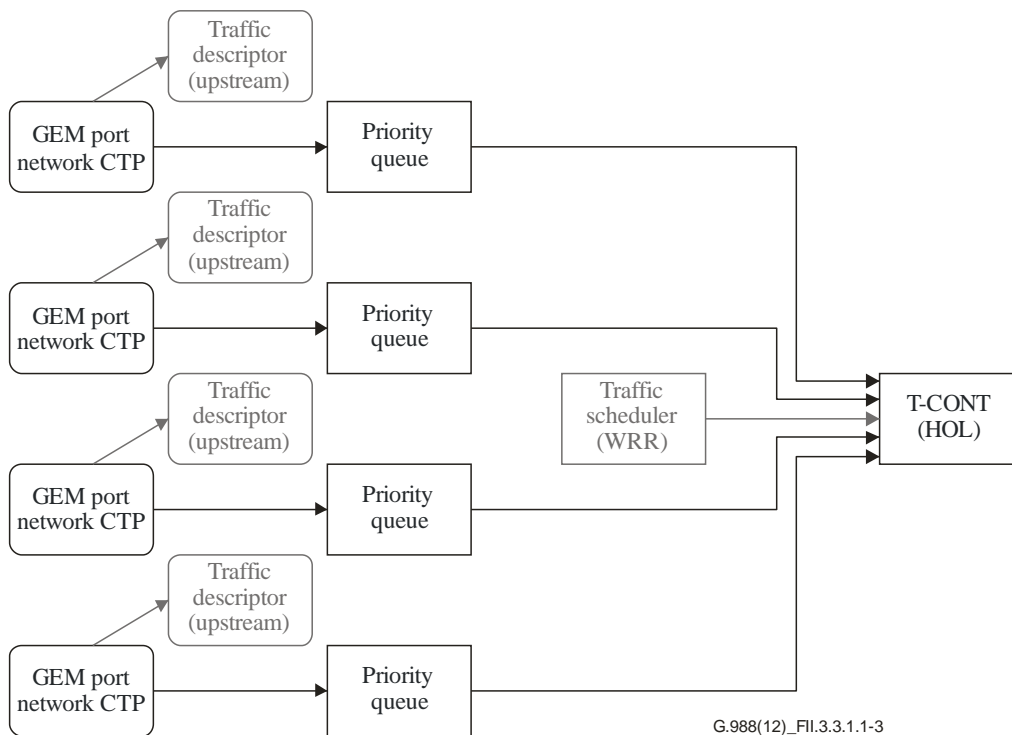

Figure II.3.3.1.1-2 – Example of weighted scheduling with four queues per T-CONT and traffic scheduler, queues connected to traffic scheduler

Figure II.3.3.1.1-3 shows an example of a T-CONT with four queues and a traffic scheduler ME. Because each queue is directly connected to the T-CONT ME, the scheduling discipline is determined from the policy attribute of the T-CONT ME, in this case strict priority.



NOTE – The traffic scheduler performs no function in this example. It is shown to illustrate components that may be present as inbuilt features of the ONU architecture.

Figure II.3.3.1.1-3 – Example of strict priority scheduling with four queues per T-CONT and traffic scheduler, queues connected directly to T-CONT

Priority queue ME

Each priority queue ME has a fixed priority and a configurable weight. The OLT can configure each priority queue ME to either point to the associated traffic scheduler ME or to point directly to the associated T-CONT ME.

For an upstream queue, the related port attribute is read-only by default and is divided into two parts: 1) the ME ID of the associated T-CONT, and 2) the priority of the queue. To support strict priority scheduling between multiple queues associated with a T-CONT, each queue must have a different priority.

The weight attribute is RW, and is used to provide weighted scheduling between the queues associated with a T-CONT. Non-empty queues at a given priority receive capacity in proportion to their weights.

The traffic scheduler pointer attribute is RW and is provisioned to either point to the associated traffic scheduler ME (if present) or to the associated T-CONT ME (null pointer value). The value of this attribute as a function of the desired scheduling discipline is shown in Table II.3.3.1.1-1. During normal operation, either all priority queues associated with a T-CONT should be mapped to the traffic scheduler ME (if present) or all should be mapped to the T-CONT ME. During provisioning, there may be a temporary period where some of the priority queues associated with a T-CONT are mapped to the traffic scheduler and some are mapped to the T-CONT, in which case the ONU's behaviour is undefined.

The traffic scheduler pointer attribute value is a "don't care" for priority queues that are not in use, i.e., that are not connected to GEM port network CTP MEs.

Table II.3.3.1.1-1 – Value of priority queue traffic scheduler pointer attribute to achieve desired scheduling discipline

Desired scheduling discipline	T-CONT policy	Traffic scheduler present?	Traffic scheduler policy	Priority queue traffic scheduler pointer attribute
Strict	Strict priority	Don't care	Don't care	T-CONT (null)
Strict	WRR	Yes	Strict priority	Traffic scheduler
Weighted	WRR	Don't care	Don't care	T-CONT (null)
Weighted	Strict priority	Yes	WRR	Traffic scheduler

Traffic scheduler ME

By default, the traffic scheduler ME has a fixed scheduling policy and fixed pointers and a configurable priority/weight. If the traffic scheduler is present, the following are its attribute settings. Flexible configuration is discussed in clause II.3.3.2.

- The T-CONT pointer attribute is read-only, and always points to the associated T-CONT.
- The traffic scheduler pointer attribute is read-only and within the scope of this clause is always null, because hierarchical scheduling is out of scope.
- The policy attribute is read-only, and within the scope of this clause is always the "opposite" of the T-CONT ME, i.e., one must be WRR and the other must be strict priority.
- The priority/weight attribute is RW, and within the scope of this clause its value is a "don't care," with a suggested value of zero.

T-CONT ME

The policy attribute is read-only and is always either WRR or strict priority.

II.3.3.1.2 OLT provisioning considerations

In the default case, the OLT must learn the priority of each queue and the association between each queue and a T-CONT – priorities and associations cannot be provisioned. If it wishes to support the policy option opposite to that built into the T-CONT itself, the OLT must determine whether a traffic scheduler ME is associated with this T-CONT. The OLT must provision the ONU such that the priority queue/traffic scheduler (if present)/T-CONT ME group is properly connected (via a GEM IW TP and GEM port network CTP) to the appropriate IEEE 802.1p mapper service profile and MAC bridge port config data MEs, and that the queues are connected to the scheduler providing the desired policy.

Strict priority scheduling

If the service requires strict priority scheduling between queues, the OLT must discover a T-CONT ME that has a sufficient number of associated priority queue MEs and either supports the strict priority scheduling policy itself or has a traffic scheduler ME that supports such a policy. For this T-CONT, each required priority queue ME is connected, according to its read-only priority attribute, to the GEM port network CTP associated with that priority. Each required priority queue ME is also connected to the associated T-CONT ME or traffic scheduler ME with strict priority policy, as shown in Table II.3.3.1.1-1. Any unused queues are left unconnected.

Weighted scheduling

If the service requires weighted scheduling between queues, then the OLT must discover a T-CONT ME that has a sufficient number of associated priority queue MEs and either supports the WRR scheduling policy itself or has a traffic scheduler ME that supports such a policy. For this T-CONT, the OLT provisions the weight of each required priority queue ME. Each required priority queue ME is connected to the GEM port network CTP associated with that weight. Each required priority queue ME is connected to the associated T-CONT ME or traffic scheduler ME with WRR policy, as shown in Table II.3.3.1.1-1. Any unused queues are left unconnected.

II.3.3.2 Alternative practice – Flexible queue/scheduler/T-CONT

In this alternative method, the QoS configuration flexibility attribute in the ONU2-G ME allows simplification of the provisioning of single-level scheduling. The queues are no longer fixed to a particular T-CONT and set of traffic scheduler MEs, but rather can be flexibly associated with any T-CONT or traffic scheduler ME in the same slot. Furthermore, the scheduling policy for the T-CONT and traffic scheduler MEs is no longer fixed but can be modified during provisioning. Finally, the priority of priority queues may be provisionable.

II.3.3.2.1 ONU provisioning considerations

The MEs used in this clause for traffic scheduling are the ONU2-G, priority queue and the T-CONT. The traffic scheduler ME is not used.

Figure II.3.3.2.1-1 shows an example of a T-CONT with four flexible queues, each directly connected to the T-CONT ME. As a function of the QoS configuration flexibility attribute in the ONU2-G ME, these queues are assumed to be taken from a pool of queues with flexible pointers, meaning they can point to any traffic scheduler or T-CONT ME in the same slot. The scheduling discipline is selected from the policy attribute of the T-CONT ME, in this example, weighted (policy = WRR).

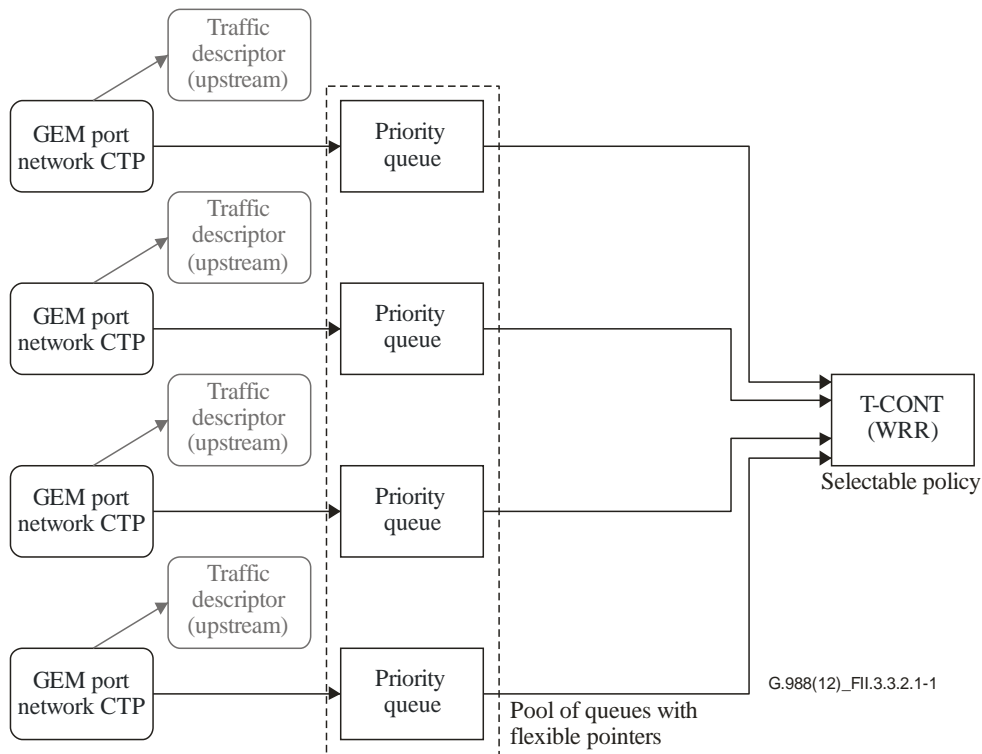

Figure II.3.3.2.1-1 – Example system of weighted scheduling with four flexible queues

ONU2-G ME

The QoS configuration flexibility attribute of the ONU2-G ME indicates whether the ONU supports flexible priority queue and traffic scheduler pointers, flexible traffic scheduler and T-CONT scheduling policies, or flexible queue priority. Specifically, as follows.

- 1) If bit 1 is set, the priority queue ME may point to any T-CONT ME in the same slot.
- 2) If bit 2 is set, the priority queue ME may point to any traffic scheduler ME in the same slot.
- 3) If bit 3 is set, the traffic scheduler ME can point to any T-CONT in the same slot.
- 4) If bit 4 is set, the traffic scheduler ME policy attribute is RW.
- 5) If bit 5 is set, the T-CONT ME policy attribute is RW.
- 6) If bit 6 is set, the priority queue ME priority field is RW.

For the single-level scheduling in the rest of this clause, it is assumed that bits 1, 5 and 6 are set, and bits 2, 3 and 4 are "don't care".

Priority queue ME

Each priority queue ME has a configurable priority and weight. The OLT can configure each priority queue ME to point to any traffic scheduler ME or any T-CONT ME in the same slot.

The related port attribute is divided into two parts for upstream traffic: 1) the ME ID of the associated T-CONT, which should be set to the desired T-CONT in a given slot; and 2) the priority of the queue. To support strict priority scheduling between multiple queues, each queue must have a different priority.

The weight attribute is RW, and is used to provide weighted scheduling between the queues associated with a T-CONT.

The traffic scheduler pointer attribute is RW and is provisioned to either point to the associated traffic scheduler ME or to the associated T-CONT ME (null pointer value). The value of this attribute should be set to zero (null), indicating that this queue is mapped to the T-CONT indicated by the related port

attribute. During provisioning, there may be a temporary period where some of the priority queues associated with a T-CONT are mapped to a traffic scheduler and some are mapped to the T-CONT, in which case the ONU's behaviour is undefined. The traffic scheduler pointer attribute value is a "don't care" for priority queues that are not in use, i.e., that are not connected to GEM port network CTP MEs.

T-CONT ME

The policy attribute is RW and must be either WRR or strict priority according to the required service.

II.3.3.2.2 OLT provisioning considerations

The OLT selects the desired priority queue MEs from the pool, and connects them to the desired T-CONT. It also sets the policy of this T-CONT to conform to the scheduling policy required by the service. The OLT provisions the ONU such that the priority queue/T-CONT ME group is properly connected (via a GEM IW TP and GEM port network CTP) to the appropriate IEEE 802.1p mapper service profile and MAC bridge port config data MEs.

Strict priority scheduling

If the service requires strict priority scheduling between queues, the OLT selects a T-CONT ME and sets its policy attribute to strict priority. The OLT also selects the required number of priority queues from the pool, and provisions each with a different priority. Each required priority queue ME is connected to the GEM port network CTP associated with that priority. Each required priority queue ME is also connected to the associated T-CONT ME. Any unused queues are left unconnected.

Weighted scheduling

If the service requires weighted scheduling between queues, the OLT selects a T-CONT ME and sets its policy attribute to WRR. The OLT also selects the required number of priority queues from the pool, and provisions the weight of each required priority queue. Each required priority queue is connected to the GEM port network CTP associated with that weight. Each priority queue ME is also connected to the associated T-CONT ME. Any unused queues are left unconnected.

II.3.4 ONU architectural considerations

Depending on the trade-off between the complexity and the number of supported features, the ONU can have various traffic management options. Examples of traffic management implementation in the ONU are described in this clause. This clause also indicates how the MIB defined in clause 9 is used for each implementation.

It should be pointed out that the ONU traffic management is not limited to these examples. ONU traffic management is likely a place where every vendor searches for a proprietary feature to give it a competitive advantage. However, every proprietary feature requires some kind of management that affects the OMCI. In fact, it is difficult for the specification given in this Recommendation to keep up with technological and feature innovations. It is envisioned that vendor-specific MEs will be needed to manage the traffic management related functions in the ONU.

II.3.4.1 Priority queue configuration

When the focus is on low complexity implementation, the ONU uses the priority-controlled upstream traffic method. This configuration is used when the traffic management option attribute in the ONU-G ME is 0 (priority controlled). In this case, the ONU has no traffic contract or QoS awareness. The ONU is configured by the OLT with a priority for each connection for both directions.

Theoretically, policing is needed at every multiplexing point, including the ONU. A system with the policing function has to monitor the traffic volume entering the network from all active connections to ensure that the agreed parameters are not violated and to deploy a frame discard or tag policy. In the priority queue implementation, the policing function is moved to the OLT, where it protects the

core network. The PON is protected by the PON MAC via the DBA process. The PON MAC manages all connections from a T-CONT as a whole. Essentially, the PON MAC isolates T-CONTs from each other.

As such, CPEs sharing one T-CONT may have to regulate their own connection streams to maintain quality. A CPE sending out more traffic on one connection will do so at the expense of other connections established via the same T-CONT. In single-user ONUs, this may well be appropriate.

II.3.4.2 Explicit traffic scheduler configuration

In slightly more complex implementations, ONUs may implement some level of traffic scheduling within each T-CONT. These are described using priority queues and one or more levels of traffic scheduler MEs. The arrangement of priority queues and traffic schedulers is determined by the ONU architecture, and is by default not controllable by the OLT. Flexible scheduler configuration is one of the options that may be indicated by the ONU2-G ME.

Figure II.3.4.2-1 exemplifies one possible configuration of traffic schedulers. Two diffserv groups are shown, each with all three classes of traffic. Within each group, two AF queues share weighted access to upstream bandwidth. Traffic in each diffserv group is then strictly prioritized, and finally offered to a weighted scheduler for arbitration across groups.

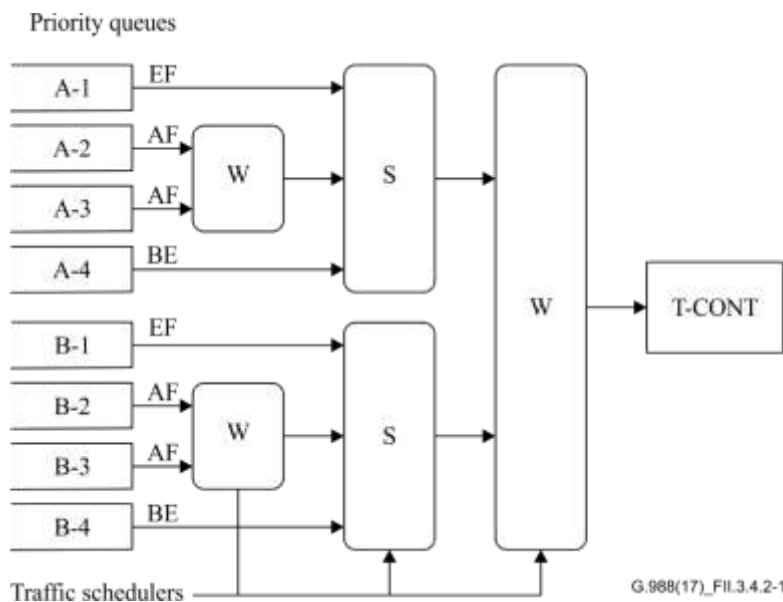

Figure II.3.4.2-1 – Hierarchical scheduling example

II.3.4.3 Traffic descriptor configuration

An alternative method of controlling traffic in ONUs is to provide traffic descriptors to the ONU, and leave the details of honouring and enforcing these contracts to the ONU implementation. This is controlled using traffic descriptor MEs. This method makes the theoretical assumption that a work-conserving scheduling methodology is used. In this configuration, traffic is shaped to conform to PIR and PBS in the traffic descriptor ME. This configuration is used when the traffic management option attribute in the ONU-G ME is 1 (rate controlled).

II.3.4.4 Priority and rate controlled configuration

Another method of controlling traffic in ONUs is to provide not only priority control with traffic scheduling, but also traffic descriptors. This is controlled using traffic descriptor, priority queue and traffic scheduler MEs. This method makes the theoretical assumption that a work-conserving scheduling methodology is used. In this configuration, traffic is policed to conform to PIR and PBS, and may be marked green or yellow according to CIR/CBS/PIR/PBS in the traffic descriptor ME.

This configuration is used when the traffic management option attribute in the ONU-G ME is 2 (priority and rate controlled).

[ITU-T G.987.1] and newer PON specifications require that a multi-UNI ONU be able to serve some UNIs with strict priority and others with rate-based control scheduling.

II.3.4.5 Flexible assignment

By default, priority queues and traffic schedulers are assigned to T-CONTs by the ONU architecture in a fixed configuration, which may not be altered. It is also possible that the ONU implements its QoS components in such a way that they may be flexibly reassigned (Note). ONU flexibility is signalled to the OLT by means of the QoS configuration flexibility bit map attribute of the ONU2-G ME.

NOTE – Given the slot-port model of ONU equipment, which appears among other places in the ME identifiers of T-CONT, PPTPs, the traffic scheduler and the related port attribute of the priority queue ME, it is not anticipated that implementation flexibility would extend across slots. Accordingly, the OMCI restricts flexibility to be only within a slot, and does not permit flexible assignment across slots.

II.4 Voice services

Provisioning of native voice services on an ONU is accomplished through the use of a common set of MEs along with the MEs specific to a particular VoIP signalling protocol. These MEs are grouped as follows.

- Common VoIP MEs
 - IP host config data
 - TCP/UDP config data
 - VoIP config data
 - VoIP voice CTP
 - VoIP media profile
 - RTP profile data
 - Voice service profile
 - PPTP POTS UNI
- SIP specific MEs
 - SIP user data
 - SIP agent data
 - Network dial plan table
 - VoIP feature access codes
 - VoIP app service profile
- ITU-T H.248 specific MEs
 - MGC config data.

The OMCI VoIP MIB allows for one or multiple subscribers per SIP UA. It is also possible to provision one or multiple UAs per IP address. The extended VLAN tagging operation configuration data ME is used to provision layer 2 tag operations for a MAC bridge port config data ME. If multiple UAs using the same IP address are provisioned, all such UAs must share the same VLAN because there is a one-to-one relationship between a MAC bridge port config ME and an IP host config data ME.

II.4.1 VoIP capability discovery

The OLT discovers support of VoIP capabilities by interrogating the ONU's MIB. Support of VoIP in general is indicated by the existence of a VoIP config data ME. Further interrogation of attributes contained in the VoIP config data ME will lead to the discovery of the specific signalling protocols and provisioning methods supported by the ONU. The number of voice ports available on an ONU is indicated by the number of PPTP POTS UNI MEs that exist.

II.4.2 VoIP common provisioning

The following considerations pertain to provisioning the common VoIP MEs.

- IP host config data – The ONU creates one IP host config data ME for each IP stack instance. A single IP address is supported with each instance. The IP host config data ME contains a group of IP parameter attributes (IP address, mask, etc.) that are set by the OLT if these parameters are statically provisioned. The parameters may also be obtained dynamically via DHCP.

The IP host config data ME contains a read-only group of current IP parameter attributes, which display the IP parameters that are actually used by the IP stack.

The IP options attribute is used to control the behaviour of the IP stack and IP parameter provisioning. The OLT may set the IP address, mask, gateway, primary or secondary DNS attributes only when the enable DHCP bit is set to disable. If the OLT sets one of these attributes when DHCP is enabled, the ONU accepts and stores the attribute value, but the IP stack does not use those values until the DHCP option is disabled. Likewise, the value is not reflected in the associated current attribute until the DHCP option is disabled. To determine the parameter values actually in use by the IP stack, the OLT should get the current IP parameter attributes, not the writable IP parameter attributes.

It is considered best practice to disable the IP stack prior to modifying the IP parameters with the OMCI. In this manner, the IP stack will have a complete coherent set of IP parameters when it is re-enabled.

- TCP/UDP config data – The OLT creates a TCP/UDP config data ME for each TCP or UDP port associated with an IP host config data ME. The OLT may choose to use the port number as the ME ID, but the OLT must ensure that overlapping TCP and UDP port number assignments create no naming conflict. The IP host pointer attribute must be set to point to the IP host config data ME that is associated with this TCP/UDP port. The TOS/diffserv field attribute is used in conjunction with an extended VLAN tagging operation configuration data ME to mark IP frames with the desired VID and P bits. The extended VLAN tagging operation configuration data ME is associated with the MAC bridge port config data ME that points to the IP host config data ME. Since the extended VLAN tagging operation configuration data ME only supports mapping DSCP to P bits, only a single VID can be used for VoIP frames. This means that signalling frames and bearer frames must share a VLAN, although they can have different P bits.
- VoIP config data – The VoIP config data ME is automatically created by the ONU. The OLT reads the available signalling protocols attribute to determine the signalling protocols supported by the ONU. The OLT performs a set on the signalling protocol used attribute to select one of the available signalling protocols. The available VoIP configuration methods attribute is read by the OLT to determine the provisioning methods that are supported by the ONU. The OLT performs a set on the VoIP configuration method used attribute to select one of the available configuration methods. If [\[BBF TR-069\]](#)/[\[BBF TR-369\]](#) or IETF sipping are selected, the OLT need not perform any further actions to provision voice services. If the configuration file retrieval method is selected, the OLT must set the VoIP configuration address pointer to point to a network address ME that provides a retrieval address for the

configuration file. Actions required when a proprietary provisioning method is selected are beyond the scope of this Recommendation.

- VoIP voice CTP – The OLT creates the VoIP voice CTP as the last step in basic voice services provisioning. The VoIP voice CTP uses three pointer attributes to tie a POTS port (PPTP POTS UNI) to a signalling protocol (SIP user data ME or MGC config data ME) and bearer channel (VoIP media profile ME). In addition, the OLT may set the signalling code attribute to select the POTS line type.
- VoIP media profile – The OLT creates the VoIP media profile ME to provision the parameters used for voice encoding. The voice service profile pointer and RTP profile pointer attributes must point to the MEs associated with this set of encoding parameters.
- RTP profile data – The OLT creates the RTP profile data ME to provision parameters defining the RTP streams used to carry encoded voice. Since RTP ports are assigned dynamically, no TCP/UDP port config data ME is associated with the RTP streams. The MAC bridge port config data ME associated with the IP host config data used by the signalling stack is the L2-L3 IW point for RTP streams. Any L2 marking of RTP frames should be provisioned using the extended VLAN tagging operation configuration data ME associated with the MAC bridge port config data ME. The DSCP mark attribute of the RTP profile data ME is used in conjunction with the tagging ME to arrive at unique tags for RTP frames. The DTMF events attribute is only meaningful if the OOB DTMF attribute of the VoIP media profile ME is enabled.
- Voice service profile – This ME is created by the OLT to define parameters associated with the carrying of voice over a packet network. It includes the capability to define tone and ringing patterns of considerable complexity, including the playback of files such as verbal announcements and ring tones.
- PPTP POTS UNI – This ME is automatically created by the ONU for each POTS port. The IW TP pointer attribute is not meaningful in the context of VoIP and is left as a null pointer.

II.4.3 SIP provisioning

The following considerations apply to provisioning the SIP MEs:

- SIP user data – The SIP user data ME is created by the OLT to define the parameters associated with a single subscriber. The username/password attribute points to the data used for subscriber authentication, not SIP agent authentication. The release timer attribute has a default value of 10 s. If the release timer attribute is set to zero, the ONU uses its internal default release timer value. This may or may not be the same as the attribute default of 10 s and is not discoverable by the OLT.
- SIP agent config data – The SIP agent config data ME defines parameters associated with a SIP UA. The proxy server address pointer attribute points to a large string ME; no authentication is associated with this address. Proxy server authentication is performed through the use of the SIP registrar attribute that may or may not point to the same address as the proxy server address pointer attribute. The TCP/UDP pointer attribute points to the TCP/UDP config data ME that defines the port to be used by the SIP signalling protocol.
- Network dial plan table – The network dial plan table ME is optionally created by the OLT if a dial plan other than the ONU's default is required. When it receives the create command, the ONU returns an unknown ME result-reason code if it does not support dial plans beyond the default. There is no mechanism for the OLT to discover the default dial plan of an ONU.
- VoIP feature access codes – The VoIP feature access codes ME is optionally created by the OLT if feature access codes other than the ONU's default are required. When it receives the create command, the ONU returns an unknown ME result-reason code if it does not support VoIP feature access codes beyond the default. There is no mechanism for the OLT to discover the default feature access codes of an ONU.

- VoIP application service profile – The VoIP application service profile ME is optionally created by the OLT if provisioning of VoIP features is required. When it receives the create command, the ONU returns an unknown ME result-reason code if it does not support VoIP feature provisioning. There is no mechanism for the OLT to discover the default VoIP features of an ONU.

II.4.4 ITU-T H.248 provisioning

The following considerations apply to provisioning the ITU-T H.248 MEs:

- MGC config data – The MGC config data ME is created by the OLT to provision the parameters associated with an ITU-T H.248 media gateway. The primary MGC and secondary MGC attributes point to network address MEs that contain IP addresses and may contain port numbers for the MGC. These port numbers are not necessarily the same as the media gateway port number defined in the TCP/UDP port config data ME. The default port used for the MGC depends on the value contained in the message format attribute.

II.4.5 Message flows

II.4.5.1 SIP provisioning flow

Figure II.4.5.1-1 depicts the provisioning flow for a basic SIP service. To assist in overall clarity, the provisioning of optional MEs is not included, nor is the provisioning of the various ME pointers.

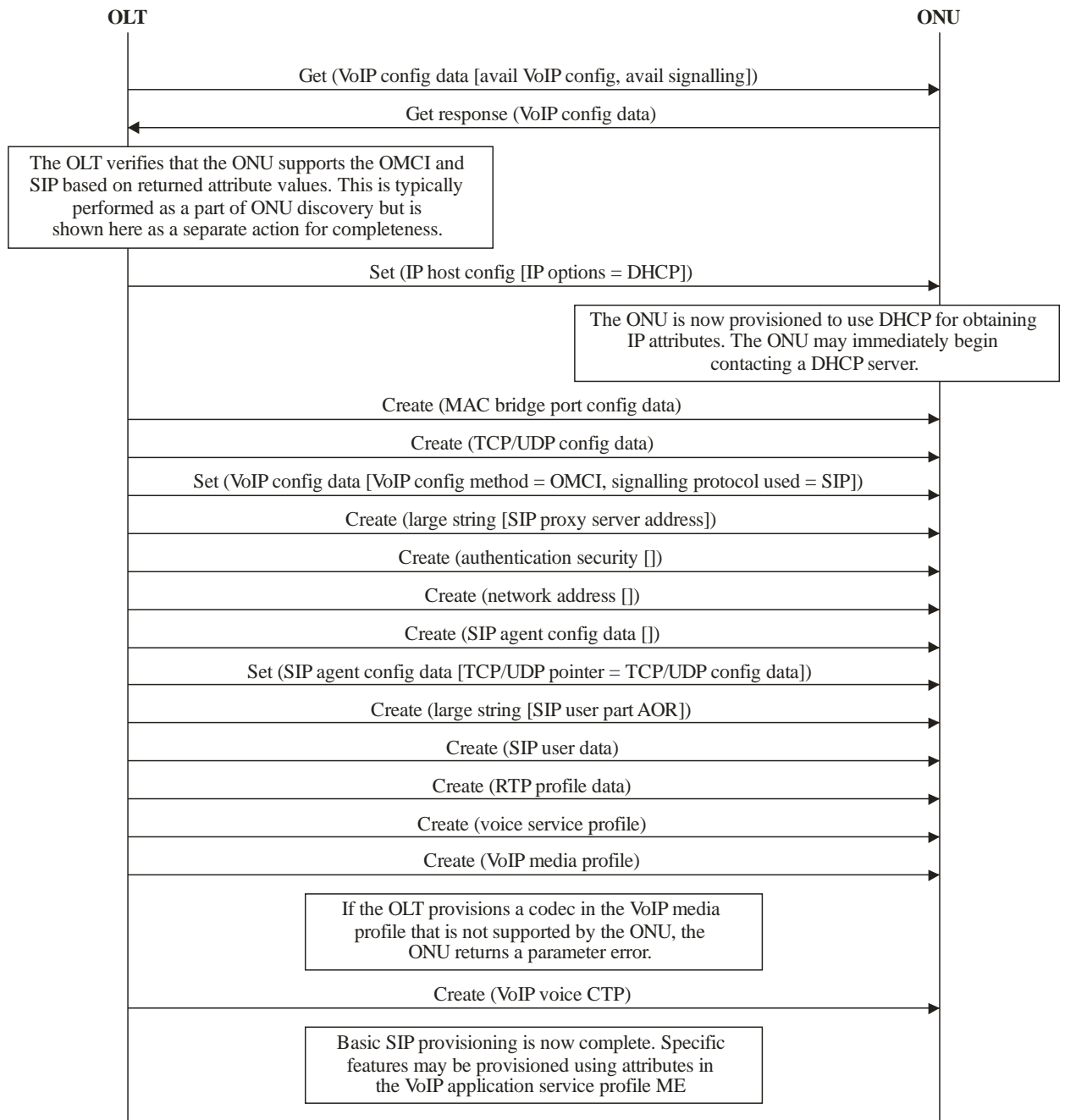

G.988(12)_FII.4.5.1-1

Figure II.4.5.1-1 – SIP provisioning flow

II.4.5.2 ITU-T H.248 message flow

Figure II.4.5.2-1 depicts the provisioning flow for ITU-T H.248 service. To assist in overall clarity, the explicit provisioning of the various ME pointers is not included.

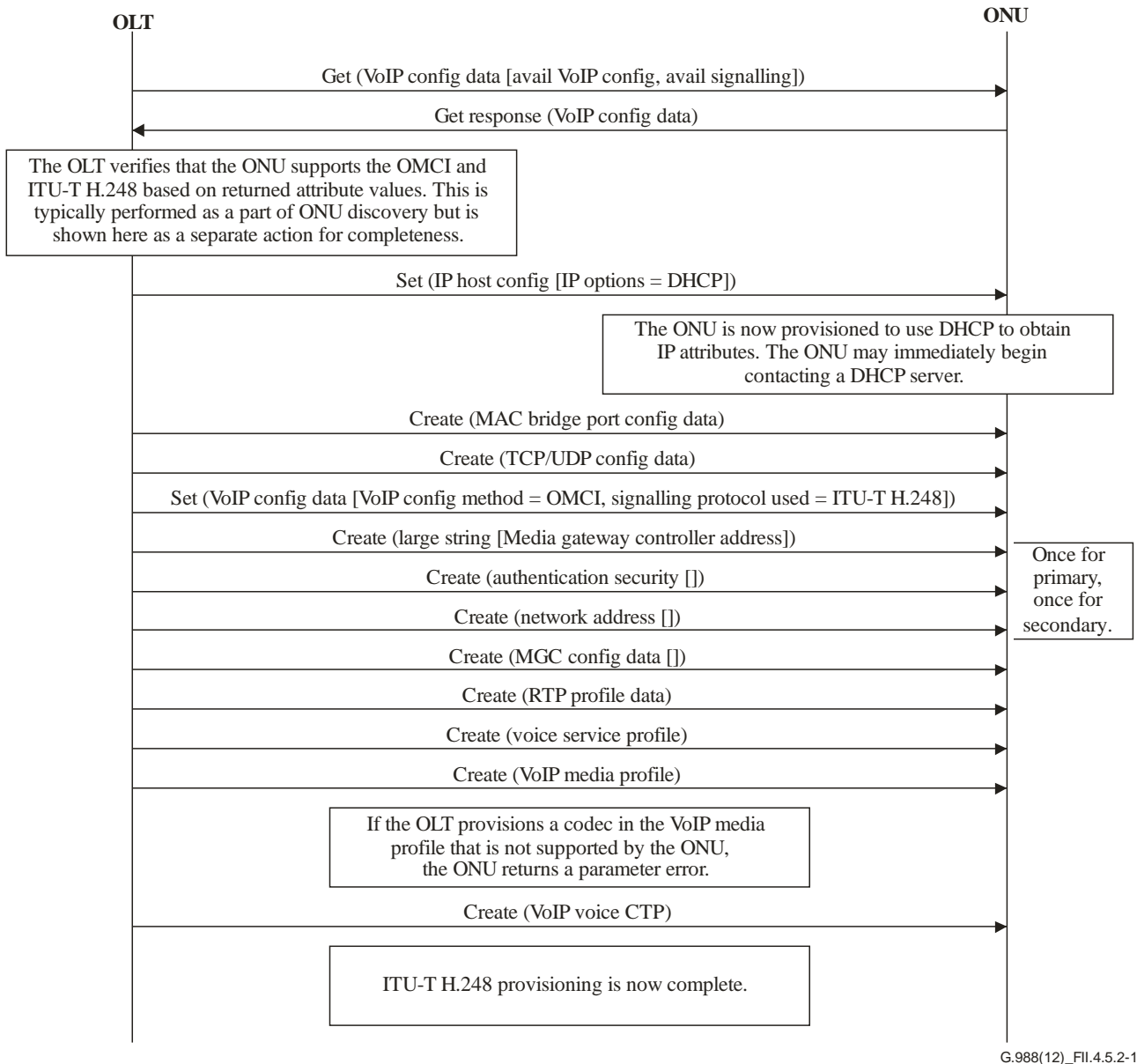

Figure II.4.5.2-1 – ITU-T H.248 provisioning flow

II.4.6 Voice service in a dual-managed ONU

In addition to supporting full voice service provisioning, the OMCI also supports ONUs that use a method other than the OMCI to manage voice services. This clause describes the techniques that are used for supporting a non-OMCI managed voice service.

II.4.6.1 Common provisioning

The following considerations apply to provisioning the common VoIP MEs for a non-OMCI managed voice service.

- IP host config data – The ONU creates the IP host config data ME for each IP stack instance. Attributes in this ME provide the IP parameters used for the non-OMCI management interface. There is no direct relation between this ME and VoIP provisioning.

- TCP/UDP config data – The OLT creates a TCP/UDP config data ME for the port used by the non-OMCI management interface. There is no direct relation between this ME and VoIP provisioning.
- VoIP config data – The VoIP config data ME is automatically created by the ONU when it supports a native voice service. The OLT reads the available VoIP configuration methods attribute to discover the voice service management methods supported by this ONU. The OLT performs a set on the VoIP configuration method used attribute to select the non-OMCI method to be used by the ONU. The OLT may optionally set the VoIP configuration address pointer attribute to a network location from which the ONU will receive its voice provisioning parameters. The OLT also optionally sets the retrieve profile attribute to indicate to the ONU that it must retrieve the provisioning parameters for the voice service. The ONU uses the VoIP configuration state attribute to indicate the state of voice service provisioning. The ONU uses the profile version attribute to indicate the version of the voice service parameter set that it is currently using.
- VoIP voice CTP – Not used.
- VoIP media profile – Not used.
- RTP profile data – Not used.
- Voice service profile – Not used.
- PPTP POTS UNI – Used in the same manner as described in clause II.4.2.

II.4.6.2 SIP provisioning

When an ONU supports non-OMCI provisioning of SIP, it automatically creates a SIP config portal ME. This ME contains a single table attribute: the configuration text table. The OLT reads this table to obtain a textual representation of the SIP configuration in use on the ONU. Whenever the text in this table changes, the ONU issues an AVC to the OLT. The format of the text contained within the table is not defined but should be human-readable.

II.4.6.3 ITU-T H.248 provisioning

When an ONU supports non-OMCI provisioning of ITU-T H.248, it automatically creates an ITU-T H.248 config portal ME. This ME contains a single table attribute: the configuration text table. The OLT reads this table to obtain a textual representation of the ITU-T H.248 configuration in use on the ONU. Whenever the text in this table changes, the ONU issues an AVC to the OLT. The format of the text contained within the table is not defined but should be human-readable.

II.5 Extended layer 2 data service model

The L2-OCM is the minimum that should be supported by all G-PON systems. It is based on the 1:MP model of ITU-T G.988 Figure 8.2.2-7. This model combines MAC bridging and IEEE 802.1p mapping functionality for a single UNI. ITU-T G.988 Figure II.1.2.1-1 illustrates L2-OCM applied to a single UNI ONU.

Figure II.5-1 shows the system level diagram of a LAG-based channel bonding example. It extends the single UNI ONU model in ITU-T G.988 Appendix II with LAG-based channel bonding. This ONU contains a single UNI and two ANIs. It supports both unicast and multicast transmission. It also supports bonded and unbonded upstream transmission. The two ANIs are connected to two OLT CTs at the OLT side. The OLT would aggregate them into a single SNI by using a LAG bridge. In most cases the two OLT CTs are in the same PON. It is possible the two OLT CTs belong to two different PON systems (e.g., TWDM-PON1 and TWDM-PON2), or even two different PON technologies (e.g., XGS-PON and TWDM-PON).

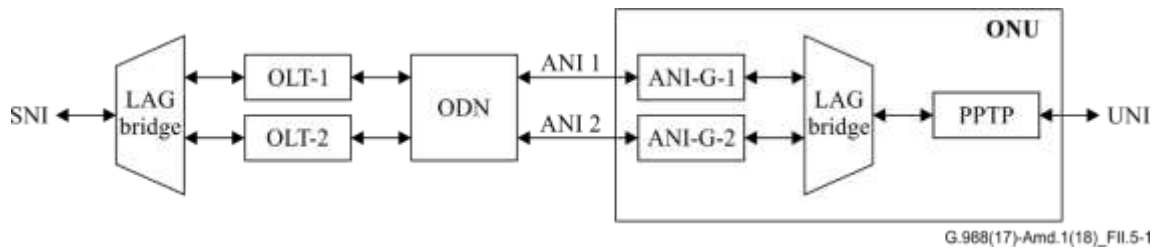

Figure II.5-1 – LAG-based channel bonding

Figure II.5-2 illustrates the OMCI model of the ONU in Figure II.5-1. ANI-G interface 1 and ANI-G interface 2 are bonded via the LASP ME in the upstream. In ANI-G interface 1, the bonded traffic is configured by the MAC bridge port configuration data 1 ME, and managed by priority queue 1-1 (PQ1-1) and priority queue 1-2 (PQ1-2). The unbonded traffic is configured by the MAC bridge port configuration data 2 ME, and the priority queues are PQ1-3 and PQ1-4. The mixed bonded and unbonded traffic management in ANI-G interface 1 is shown in Figure II.5-2 with a box of blue dashed outline.

In ANI-G interface 2, the bonded traffic is configured by the MAC bridge port configuration data 3 ME, and managed by priority queue 2-1 (PQ2-1) and priority queue 2-2 (PQ2-2). Its unbonded traffic is configured by the MAC bridge port configuration data 4 ME, and the priority queues are PQ2-3 and PQ2-4. The mixed bonded and unbonded traffic management in ANI-G interface 2 is shown in Figure II.5-2 with a box of red dashed outline.

Bonded traffic in ANI-G interface 1 and ANI-G interface 2 belongs to the same LAG. This LAG is represented by the LASP ME in Figure II.5-2 and both the MAC bridge port configuration data 1 ME and the MAC bridge port configuration data 3 ME contain a pointer to the LASP ME.

The QoS attributes on all bonded MAC bridge ports in a LAG should be similarly configured. In the example of Figure II.5-2, the VLAN tagging filter ME, the 802.1p mapper service profile ME, the GEM interworking TP ME, the GEM port network CTP ME, the traffic descriptor ME, and the priority queue ME should be similarly configured for the bonded MAC bridge ports (i.e., Port 1 and Port 3 in Figure II.5-2). This ensures equal treatment on all bonded MAC bridge ports in the same LAG.

The downstream multicast traffic is managed via two MAC bridge port configurations data MEs in the yellow dashed outline box. The upper one is represented by an instance of the GEM interworking termination point ME. It carries the incidental downstream broadcast traffic. The lower one is represented by an instance of the multicast GEM interworking termination point ME. It carries the general multicast traffic.

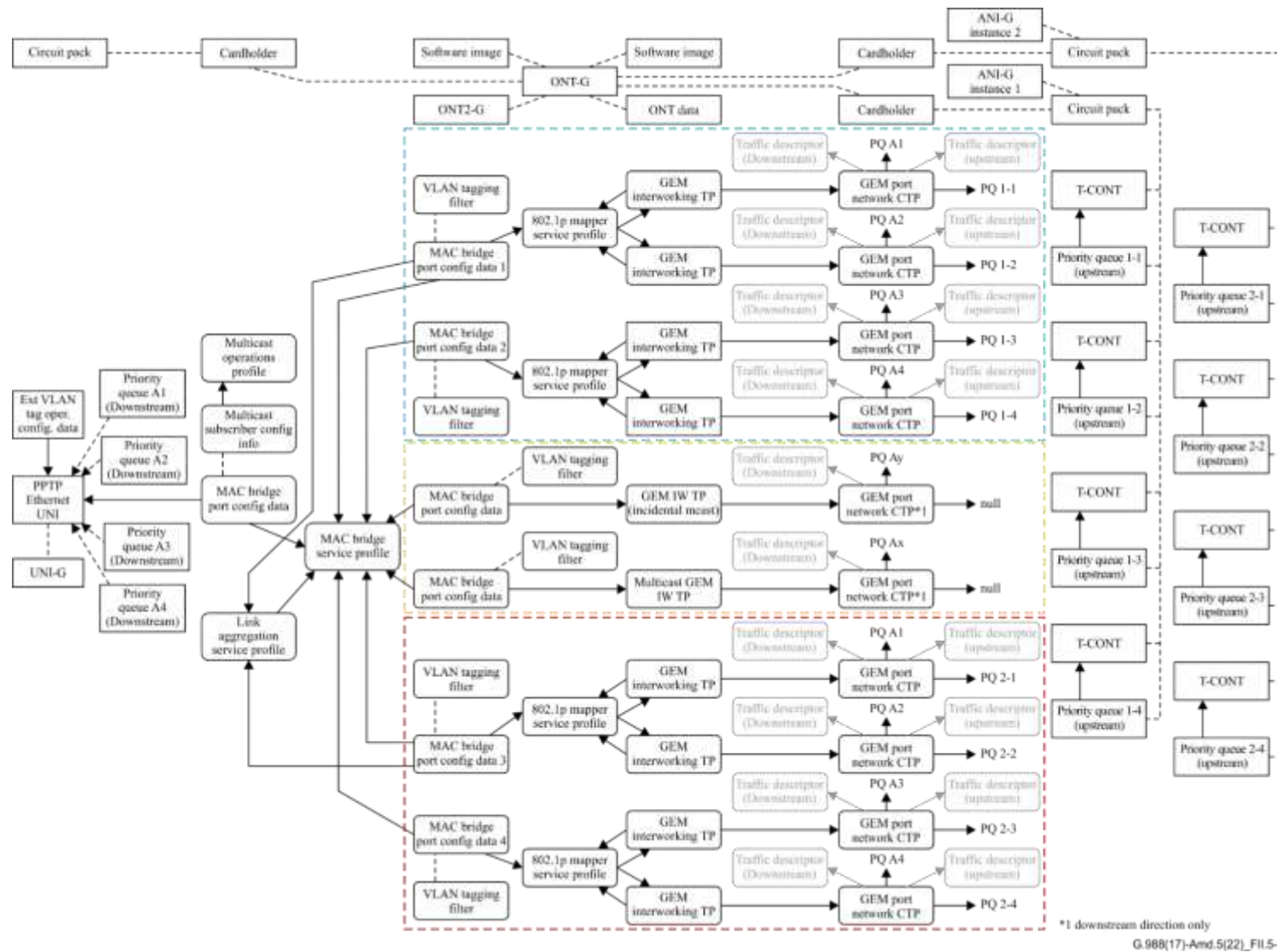

Figure II.5-2 – Supporting LAG-based channel bonding in an ONU (based on ITU-T G.988 Figure II.1.2.1-1 – Single UNI, VLANs with common priorities)

Appendix III

This appendix is intentionally left blank

Bibliography

- [b-ATIS-0300231] ATIS-0300231:2013, *Layer 1 in-service transmission performance monitoring*.
- [b-ATIS-0600403] ATIS-0600403:1999 (R2012), *Network and customer installation interfaces – DS1 electrical interfaces*.
- [b-ATIS-0600413] ATIS-0600413.2009, *Network to customer installation interfaces – Asymmetric digital subscriber line (ADSL) metallic interface*.
- [b-BBF TR-101] Digital Subscriber Line Forum Technical Report TR-101 (2006), *Migration to Ethernet based DSL aggregation*. Available [viewed 2018-01-05] at <https://www.broadband-forum.org/technical/download/TR-101.pdf>
- [b-BBF TR-156] Broadband Forum Technical Report TR-156 (2012), *Using GPON access in the context of TR-101*. Available [viewed 2018-01-05] at http://www.broadband-forum.org/technical/download/TR-156_Issue-3.pdf
- [b-IANA] *Internet Assigned Numbers Authority*. Available [viewed 2018-01-03] at www.iana.org
- [b-IETF RFC 2460] IETF RFC 2460 (1998), *Internet protocol, version 6 (IPv6): Specification*.
- [b-IETF RFC 2463] IETF RFC 2463 (1998), *Internet control message protocol (ICMPv6) for the Internet protocol version 6 (IPv6): Specification*.
- [b-IETF RFC 2475] IETF RFC 2475 (1998), *An architecture for differentiated services*.
- [b-IETF RFC 2516] IETF RFC 2516 (1999), *A method for transmitting PPP over Ethernet (PPPoE)*.
- [b-IETF RFC 2543] IETF RFC 2543 (1999), *SIP: Session Initiation Protocol*.
- [b-IETF RFC 2571] IETF RFC 2571 (1999), *An architecture for describing SNMP management frameworks*.
- [b-IETF RFC 2698] IETF RFC 2698 (1999), *A two rate three color marker*.
- [b-IETF RFC 2710] IETF RFC 2710 (1999), *Multicast listener discovery (MLD) for IPv6*.
- [b-IETF RFC 3232] IETF RFC 3232 (2002), *Assigned numbers: RFC 1700 is replaced by an on-line database*.
- [b-IETF RFC 3247] IETF RFC 3247 (2002), *Supplemental information for the new definition of the EF PHB (expedited forwarding per-hop behavior)*.
- [b-IETF RFC 3264] IETF RFC 3264 (2002), *An offer/answer model with the session description protocol (SDP)*.
- [b-IETF RFC 3315] IETF RFC 3315 (2003), *Dynamic host configuration protocol for IPv6 (DHCPv6)*.
- [b-IETF RFC 3339] IETF RFC 3339 (2002), *Date and Time on the Internet: Timestamps*.
- [b-IETF RFC 3418] IETF RFC 3418 (2002), *Management information base (MIB) for the simple network management protocol (SNMP)*.
- [b-IETF RFC 3621] IETF RFC 3621 (2003), *Power Ethernet MIB*.
- [b-IETF RFC 3926] IETF RFC 3926 (2004), *FLUTE – File delivery over unidirectional transport*.

- [b-IETF RFC 4115] IETF RFC 4115 (2005), *A differentiated service two-rate, three-color marker with efficient handling of in-profile traffic.*
- [b-IETF RFC 4291] IETF RFC 4291 (2006), *IP version 6 addressing architecture.*
- [b-IETF RFC 4541] IETF RFC 4541 (2006), *Considerations for Internet group management protocol (IGMP) and multicast listener discovery (MLD) snooping switches.*
- [b-IETF RFC 4861] IETF RFC 4861 (2007), *Neighbor discovery for IP version 6 (IPv6).*
- [b-IETF RFC 4862] IETF RFC 4862 (2007), *IPv6 stateless address autoconfiguration.*
- [b-IETF RFC 5462] IETF RFC 5462 (2009), *Multiprotocol label switching (MPLS) label stack entry: "EXP" field renamed to "Traffic Class" field.*
- [b-IETF RFC 5942] IETF RFC 5942 (2010), *IPv6 subnet model: The relationship between links and subnet prefixes.*
- [b-IETF RFC 6106] IETF RFC 6106 (2010), *IPv6 router advertisement options for DNS configuration.*
- [b-MEF 10.2] Metro Ethernet Forum Technical Specification MEF10.2 (2009), [Ethernet services attributes phase 2](https://mef.net/PDF_Documents/technical-specifications/MEF10.2.pdf). Available [viewed 2018-01-05] at: https://mef.net/PDF_Documents/technical-specifications/MEF10.2.pdf
- [b-PKT-SP-NCS] CableLabs, PKT-SP-NCS1.5-I04-120412 (2012), *PacketCable network-based call signaling protocol specification.*
- [b-Floyd] Floyd, S., Jacobson, V. (1993). Random early detection gateways for congestion avoidance. *IEEE/ACM Transactions on Networking*, 1(4), pp. 397-413.

SERIES OF ITU-T RECOMMENDATIONS

Series A	Organization of the work of ITU-T
Series D	Tariff and accounting principles and international telecommunication/ICT economic and policy issues
Series E	Overall network operation, telephone service, service operation and human factors
Series F	Non-telephone telecommunication services
Series G	Transmission systems and media, digital systems and networks
Series H	Audiovisual and multimedia systems
Series I	Integrated services digital network
Series J	Cable networks and transmission of television, sound programme and other multimedia signals
Series K	Protection against interference
Series L	Environment and ICTs, climate change, e-waste, energy efficiency; construction, installation and protection of cables and other elements of outside plant
Series M	Telecommunication management, including TMN and network maintenance
Series N	Maintenance: international sound programme and television transmission circuits
Series O	Specifications of measuring equipment
Series P	Telephone transmission quality, telephone installations, local line networks
Series Q	Switching and signalling, and associated measurements and tests
Series R	Telegraph transmission
Series S	Telegraph services terminal equipment
Series T	Terminals for telematic services
Series U	Telegraph switching
Series V	Data communication over the telephone network
Series X	Data networks, open system communications and security
Series Y	Global information infrastructure, Internet protocol aspects, next-generation networks, Internet of Things and smart cities
Series Z	Languages and general software aspects for telecommunication systems