

Recommendation

ITU-T G.9963 (06/2023)

SERIES G: Transmission systems and media, digital systems and networks

Access networks – In premises networks

Unified high-speed wireline-based home networking transceivers – Multiple input/multiple output specification



ITU-T G-SERIES RECOMMENDATIONS

Transmission systems and media, digital systems and networks

INTERNATIONAL TELEPHONE CONNECTIONS AND CIRCUITS	G.100-G.199
GENERAL CHARACTERISTICS COMMON TO ALL ANALOGUE CARRIER-TRANSMISSION SYSTEMS	G.200-G.299
INDIVIDUAL CHARACTERISTICS OF INTERNATIONAL CARRIER TELEPHONE SYSTEMS ON METALLIC LINES	G.300-G.399
GENERAL CHARACTERISTICS OF INTERNATIONAL CARRIER TELEPHONE SYSTEMS ON RADIO-RELAY OR SATELLITE LINKS AND INTERCONNECTION WITH METALLIC LINES	G.400-G.449
COORDINATION OF RADIOTELEPHONY AND LINE TELEPHONY	G.450-G.499
TRANSMISSION MEDIA AND OPTICAL SYSTEMS CHARACTERISTICS	G.600-G.699
DIGITAL TERMINAL EQUIPMENTS	G.700-G.799
DIGITAL NETWORKS	G.800-G.899
DIGITAL SECTIONS AND DIGITAL LINE SYSTEM	G.900-G.999
MULTIMEDIA QUALITY OF SERVICE AND PERFORMANCE – GENERIC AND USER-RELATED ASPECTS	G.1000-G.1999
TRANSMISSION MEDIA CHARACTERISTICS	G.6000-G.6999
DATA OVER TRANSPORT – GENERIC ASPECTS	G.7000-G.7999
PACKET OVER TRANSPORT ASPECTS	G.8000-G.8999
ACCESS NETWORKS	G.9000-G.9999
Metallic access networks	G.9700-G.9799
Optical line systems for local and access networks	G.9800-G.9899
In premises networks	G.9900-G.9999

For further details, please refer to the list of ITU-T Recommendations.

Recommendation ITU-T G.9963

Unified high-speed wireline-based home networking transceivers – Multiple input/multiple output specification

Summary

Recommendation ITU-T G.9963 belongs to the family of ITU-T G.996x Recommendations. Recommendation ITU-T G.9963 specifies the additions and modifications to Recommendations ITU-T G.9960 and ITU-T G.9961 that are needed for a multiple input multiple output (MIMO) home networking transceiver capable of operating over premises power-line wiring. MIMO transceivers are able to transmit and receive over three power-line conductors (phase, neutral and ground). This Recommendation also specifies the means by which transceivers that comply with ITU-T G.9960, ITU-T G.9961 and ITU-T G.9963 interoperate when used on the same wires.

History *

Edition	Recommendation	Approval	Study Group	Unique ID
1.0	ITU-T G.9963	2011-12-16	15	11.1002/1000/11404
1.1	ITU-T G.9963 (2011) Amd. 1	2014-01-13	15	11.1002/1000/12083
1.2	ITU-T G.9963 (2011) Cor. 1	2014-04-04	15	11.1002/1000/12082
2.0	ITU-T G.9963	2015-07-03	15	11.1002/1000/12402
2.1	ITU-T G.9963 (2015) Cor. 1	2016-04-13	15	11.1002/1000/12819
2.2	ITU-T G.9963 (2015) Amd. 1	2016-07-22	15	11.1002/1000/12820
3.0	ITU-T G.9963	2018-11-29	15	11.1002/1000/13778
3.1	ITU-T G.9963 (2018) Amd. 1	2021-04-23	15	11.1002/1000/14533
4.0	ITU-T G.9963	2023-06-13	15	11.1002/1000/15557

Keywords

Architecture, DLL layer, G.hn, MIMO, phoneline, PHY layer, powerline.

* To access the Recommendation, type the URL <https://handle.itu.int/> in the address field of your web browser, followed by the Recommendation's unique ID.

FOREWORD

The International Telecommunication Union (ITU) is the United Nations specialized agency in the field of telecommunications, information and communication technologies (ICTs). The ITU Telecommunication Standardization Sector (ITU-T) is a permanent organ of ITU. ITU-T is responsible for studying technical, operating and tariff questions and issuing Recommendations on them with a view to standardizing telecommunications on a worldwide basis.

The World Telecommunication Standardization Assembly (WTSA), which meets every four years, establishes the topics for study by the ITU-T study groups which, in turn, produce Recommendations on these topics.

The approval of ITU-T Recommendations is covered by the procedure laid down in WTSA Resolution 1.

In some areas of information technology which fall within ITU-T's purview, the necessary standards are prepared on a collaborative basis with ISO and IEC.

NOTE

In this Recommendation, the expression "Administration" is used for conciseness to indicate both a telecommunication administration and a recognized operating agency.

Compliance with this Recommendation is voluntary. However, the Recommendation may contain certain mandatory provisions (to ensure, e.g., interoperability or applicability) and compliance with the Recommendation is achieved when all of these mandatory provisions are met. The words "shall" or some other obligatory language such as "must" and the negative equivalents are used to express requirements. The use of such words does not suggest that compliance with the Recommendation is required of any party.

INTELLECTUAL PROPERTY RIGHTS

ITU draws attention to the possibility that the practice or implementation of this Recommendation may involve the use of a claimed Intellectual Property Right. ITU takes no position concerning the evidence, validity or applicability of claimed Intellectual Property Rights, whether asserted by ITU members or others outside of the Recommendation development process.

As of the date of approval of this Recommendation, ITU had received notice of intellectual property, protected by patents/software copyrights, which may be required to implement this Recommendation. However, implementers are cautioned that this may not represent the latest information and are therefore strongly urged to consult the appropriate ITU-T databases available via the ITU-T website at <http://www.itu.int/ITU-T/ipr/>.

© ITU 2023

All rights reserved. No part of this publication may be reproduced, by any means whatsoever, without the prior written permission of ITU.

Table of Contents

		Page
1	Scope	1
2	References.....	1
3	Definitions	2
	3.1 Terms defined elsewhere	2
	3.2 Terms defined in this Recommendation.....	2
4	Abbreviations and acronyms	2
5	Home network architecture and reference models	4
6	Profiles.....	4
7	Physical layer specification (PHY layer).....	4
	7.1 Medium independent specification.....	4
	7.2 Medium dependent specification.....	49
8	Data link layer specification of the MIMO transceiver	49
	8.1 Functional model and frame formats.....	49
	8.2 MAP controlled medium access.....	49
	8.3 Transmission opportunities (TXOPs) and time slots (TSs).....	49
	8.4 Control parameters for APC, LLC and MAC	50
	8.5 Functions of the endpoint node	50
	8.6 Domain master node functional capabilities	50
	8.7 Addressing scheme	51
	8.8 Medium access plan (MAP) frame.....	51
	8.9 Retransmission and acknowledgement protocol	52
	8.10 Management and control message format.....	52
	8.11 Channel estimation protocol.....	54
	8.12 Connection management	85
	8.13 Message flooding.....	85
	8.14 Operation in the presence of neighbouring domains – Distributed domain coordination (NDIM).....	85
	8.15 Coexistence with alien power-line networks.....	85
	8.16 PHY multicast binding protocol.....	85
	8.17 DLL multicast stream	86
	8.18 Inter-OFB interoperability	86
	8.19 Node information and capabilities exchange	86
	8.20 Metrics acquisition	86
	8.21 Operation in power saving modes	86
	8.22 Layer 2 configuration and management protocol (LCMP)	86
	8.23 MIMO transmission.....	86
	8.24 Run-length compression of fields of management messages.....	88
	8.25 Payload compression in management messages	88

	Page
8.26 TLV pool	88
9 Security	88
Annex A – Regional requirements for North America	89
Annex B	89
Annex C – Regional requirements for Japan	89
Annex D – International amateur radio bands	89
Annex E – Impact of ITU-T G.9960 on VDSL2 service	89
Annex F	90
Annex G – Test vectors.....	90
Annex H – Application protocol convergence sublayer	90
Annex I – Interoperability between Profile 1 and Profile 2 OFB transmissions	90
Annex J – IEEE 802.1X port-based network access control	90
Annex K to Annex Q	91
Annex R – Use of reverse power feeding techniques for G.hn over coaxial media	91
Annex S to Annex W	91
Annex X – Test vectors.....	91

Recommendation ITU-T G.9963

Unified high-speed wireline-based home networking transceivers – Multiple input/multiple output specification

1 Scope

This Recommendation describes the modifications to [ITU-T G.9960] and [ITU-T G.9961] that are needed to define MIMO home networking transceivers for operation over power-line or telephone wiring. More specifically, this Recommendation includes the following:

- the PHY functional models of the MIMO transceivers;
- detailed descriptions of the modifications (changes and additions) needed in the PHY and DLL sections relative to [ITU-T G.9960] and [ITU-T G.9961];
- the means by which transceivers that comply with [ITU-T G.9960], [ITU-T G.9961] and this Recommendation interoperate when operating on the same wires; and
- the means by which transmissions from ITU-T G.9963 transceivers do not degrade the performance of transceivers that comply with [ITU-T G.9960] and [ITU-T G.9961] when operating on the same wires.

An ITU-T G.9963 transceiver shall be fully compliant with [ITU-T G.9960] and [ITU-T G.9961].

NOTE – In those regions, or particular installations, where only two conductors are used for mains sockets in the case of powerline or a single pair of wires is used in the case of telephone cable, a modem equipped with a MIMO transceiver will behave as an [ITU-T G.9960] transceiver.

2 References

The following ITU-T Recommendations and other references contain provisions which, through reference in this text, constitute provisions of this Recommendation. At the time of publication, the editions indicated were valid. All Recommendations and other references are subject to revision; users of this Recommendation are therefore encouraged to investigate the possibility of applying the most recent edition of the Recommendations and other references listed below. A list of the currently valid ITU-T Recommendations is regularly published. The reference to a document within this Recommendation does not give it, as a stand-alone document, the status of a Recommendation.

[ITU-T G.9960] Recommendation ITU-T G.9960 (2019), *Unified high-speed wireline-based home networking transceivers – System architecture and physical layer specification*.

[ITU-T G.9961] Recommendation ITU-T G.9961 (2018), *Unified high-speed wireline-based home networking transceivers – Data link layer specification*.

[ITU-T G.9962] Recommendation ITU-T G.9962 (2018), *Unified high-speed wireline-based home networking transceivers – Management specification*.

[ITU-T G.9964] Recommendation ITU-T G.9964 (2011), *Unified high-speed wireline-based home networking transceivers – Power spectral density specification*.

[ITU-T G.9991] Recommendation ITU-T G.9991 (2019), *High-speed indoor visible light communication transceiver – System architecture, physical layer and data link layer specification*.

3 Definitions

3.1 Terms defined elsewhere

Unless otherwise noted, the definitions in [ITU-T G.9960] and [ITU-T G.9961] shall apply.

3.2 Terms defined in this Recommendation

This Recommendation defines the following terms:

3.2.1 ground conductor (G): A conductor in an electrical branch circuit that does not carry mains current under normal operation. It provides a low-impedance return path for ground-fault current back to the service entrance panel for the purposes of protecting personnel and equipment and ensuring circuit breaker trip. At the service entrance panel, this conductor is bonded to an earthing (grounding) electrode. In regulations in some regions this is commonly referred to as the equipment grounding conductor (EGC).

NOTE 1 – Some electrical appliances do not connect to the ground conductor.

NOTE 2 – The neutral and ground conductors are commonly bonded together in the service entrance panel and nowhere else, by virtue of their common bonding to the earthing electrode.

3.2.2 MIMO channel: A channel that has multiple input ports (Tx ports) and multiple output ports (Rx ports). A "2 X 2" MIMO channel has 2 Tx ports and 2 Rx ports.

3.2.3 MIMO transmission: Transmission where one or two spatial streams are converted into two transmit streams.

3.2.4 neutral conductor (N): A conductor in an electrical branch circuit that serves as the reference conductor and return path for current supplied by the circuit's phase conductor(s). At the service entrance panel, this conductor may be bonded to an earthing (ground) electrode. In such cases, regulations in some regions refer to it as the "grounded conductor".

NOTE – Not all branch circuits include a neutral conductor. The term "grounded conductor" should not be confused with the term "ground conductor" or EGC.

3.2.5 phase conductor (P): A conductor in an electrical branch circuit that is energized with mains' voltage with respect to the circuit's reference conductor. In regulations in some regions, this is commonly referred to as a "line conductor".

3.2.6 spatial stream: A stream of data that may be mapped for transmission over one or more ports.

3.2.7 transmit stream: A stream of symbols created by the Tx port mapper. Each transmit stream is assigned for transmission over a specific Tx port.

3.2.8 Tx (or Rx) port: In powerline, a physical connection to the power-line medium using a combination of the available three conductors (phase (P), neutral (N), and ground (G)) for transmitting and receiving signals. An example of a port is a pair of conductors, such as P-N, N-G or P-G. In a telephone cable, a physical connection to a pair of conductors. A port used for transmission is called a "Tx port". A port used for reception is called an "Rx port".

3.2.9 Tx port mapper: A function that maps pairs of constellation points assigned to the two spatial streams on the same sub-carrier, to a modified pair of signals that (after orthogonal frequency division multiplexing (OFDM) modulation, i.e., inverse discrete Fourier transform (IDFT) are connected to Tx ports.

4 Abbreviations and acronyms

This Recommendation uses the following abbreviations and acronyms:

ACE Additional Channel Estimation

APC	Application Protocol Convergence
BAT	Bit Allocation Table
BMAT	Bit and Tx port Mapping Allocation Table
DLL	Data Link Layer
DOD	Domain identifier
DSL	Digital Subscriber Line
EGC	Equipment Grounding Conductor
FEC	Forward Error Correction
IDFT	Inverse Discrete Fourier Transform
IDPS	Inter-Domain Presence Signal
ISC	Inactive Sub-Carrier
LFSR	Linear Feedback Shift Register
LSB	Least Significant Bit
MAC	Medium Access Control
MAP	Medium Access Plan
MAT	Mapping Allocation Table
MDI	Medium-Dependent Interface
MIMO	Multiple Input/Multiple Output
MPDU	Media access control Protocol Data Unit
MSC	Masked Sub-Carrier
OFB	Operational Frequency Band
OFDM	Orthogonal Frequency Division Multiplexing
PCS	Physical Coding Sub-layer
PG	Precoding Grouping
PHY	Physical layer
PMA	Physical Medium Attachment
PMD	Physical Medium Dependent
PMI	Physical Medium-independent Interface
PMSC	Permanently Masked Sub-Carrier
PR	Priority Resolution
PSD	Power Spectral Density
QoS	Quality of Service
RMAP	Relayed Medium Access Plan
RMSC	Regionally Masked Sub-Carrier
SM	Sub-carrier Mark
SS	Spatial Stream
SSC	Supported Sub-Carrier

TPM	Tx Port Mapping
TS	Time Slot
TXOP	Transmission Opportunity

5 Home network architecture and reference models

See clause 5 of [ITU-T G.9960].

6 Profiles

See clause 6 of [ITU-T G.9960].

7 Physical layer specification (PHY layer)

7.1 Medium independent specification

7.1.1 Functional model of the PHY

As stated in clause 1, an ITU-T G.9963 compliant transceiver (i.e., a MIMO transceiver) shall be fully compliant with [ITU-T G.9960] and [ITU-T G.9961]. As such, a MIMO transceiver is able to operate based upon the functional models described in clause 7.1.1 (general PHY model), clause 7.1.2 (PCS), clause 7.1.3 (PMA) and clause 7.1.4 (PMD) of [ITU-T G.9960]. Such an operation, resulting in ITU-T G.9960 transmission, may be used for certain transmission cases, as described in clause 7.1.2.1.

The functional model of the PHY layer of a MIMO transceiver, for cases of MIMO transmission, is presented in Figure 7-1. The physical medium-independent interface (PMI) and the medium-dependent interface MDI are, respectively, two demarcation reference points between the PHY and the medium access control (MAC), and between the PHY and transmission medium. Internal reference points δ and α show separation between the physical medium dependent (PMD) and physical medium attachment (PMA), and between the physical coding sub-layer (PCS) and PMA, respectively.

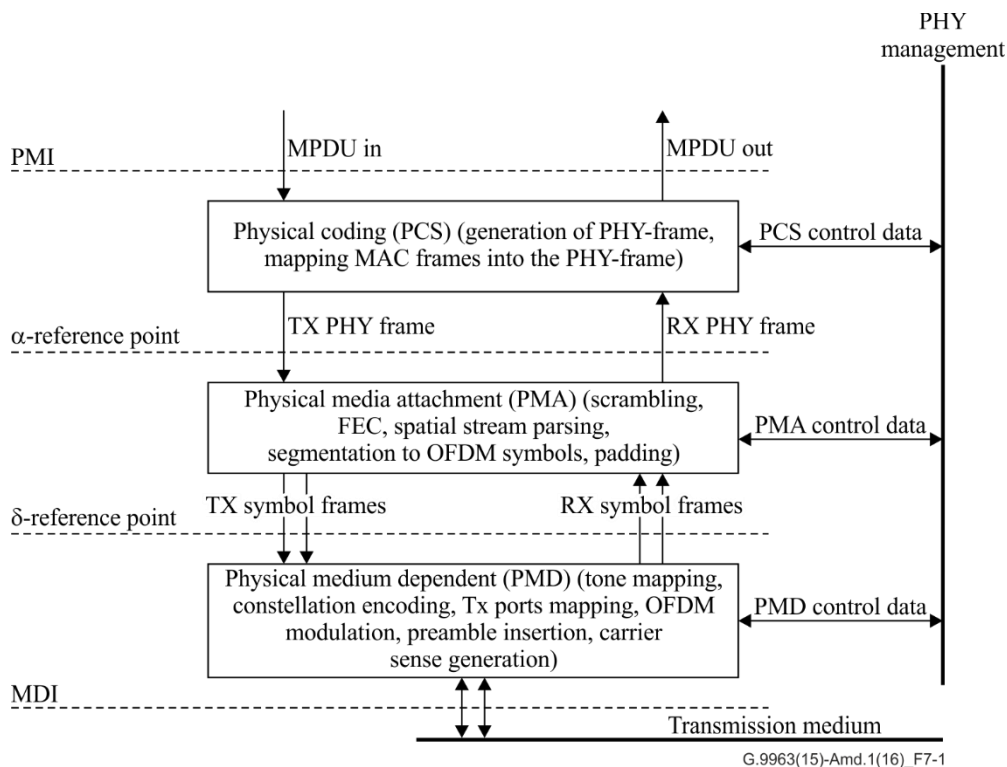

Figure 7-1 – PHY functional model of the MIMO transceiver

In the transmit direction, data enters the PHY from the MAC via the PMI in blocks of bytes called MAC protocol data units (MPDUs). The incoming MPDU is mapped into a PHY frame in the PCS. The PHY frame is scrambled, encoded and parsed into spatial streams (SS), which are then segmented into orthogonal frequency division multiplexing (OFDM) symbol frames in the PMA. The symbol frames of each of the spatial streams is mapped to OFDM sub-carriers, modulated and mapped to Tx ports in the PMD and transmitted over the medium using OFDM modulation with relevant parameters. In the PMD, a preamble is added to assist synchronization and channel estimation in the receiver.

In the receive direction, frames entering from the medium (reception is also done via multiple Rx ports) via the MDI are demodulated and decoded. The recovered MPDUs are forwarded to the MAC via the PMI. The recovered PHY-frame headers (PFH) are processed in the PHY to extract the relevant frame parameters specified in clause 7.1.2.3.

7.1.2 Physical coding sublayer (PCS)

The functional model of the PCS is presented in Figure 7-2. It is intended to describe in more detail the PCS functional block presented in Figure 7-1.

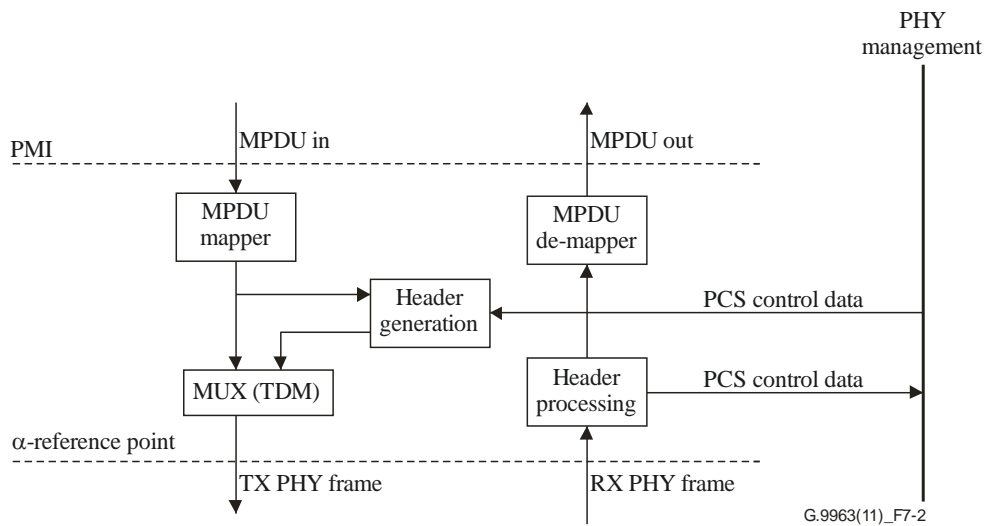

Figure 7-2 – Functional model of PCS

In the transmit direction, the incoming MPDU is mapped into a payload field of a PHY frame (clause 7.1.2.1) as described in clause 7.1.2.2. The PHY-frame header (clause 7.1.2.3) is then added to form a TX PHY frame. The TX PHY frame is passed across the α -reference point for further processing in the PMA.

In the receive direction, the decoded PHY-frame payload and header are processed and originally transmitted MPDUs are recovered from the payloads of received PHY frames and submitted to the PMI. Relevant control information conveyed in the PHY-frame header is processed and submitted to the PHY management entity.

7.1.2.1 PHY frame

As stated in clause 7.1.1, a MIMO transceiver shall be capable of transmitting using the following two transmission schemes:

- ITU-T G.9960 transmission based on the reference models and PHY frame format defined in [ITU-T G.9960].
- MIMO transmission based on the reference models and PHY frame format defined in this Recommendation.

The format of the PHY frame for ITU-T G.9960 transmission is presented in clause 7.1.2.1 of [ITU-T G.9960]. The format of the PHY frame for MIMO transmission is presented in this section.

Table 7-1 specifies the transmission rule (PHY frame format) that shall be used by an ITU-T G.9963 node when it transmits to an ITU-T G.9960/G.9961 node or to an ITU-T G.9963 node, or both.

Table 7-1 – Transmission rule (PHY frame format) for an ITU-T G.9963 node depending on the type of intended receiver

	Source devices	Destination devices	Number of spatial streams for payload	MIMO_IND	Transmission details	Transmission scheme
1	ITU-T G.9963	ITU-T G.9963	N/A	N/A	Frames without payload intended for ITU-T G.9963 receivers (e.g., RTS, CTS, ACK, ACKRQ)	MIMO transmission or ITU-T G.9960 transmission (Note)
2	ITU-T G.9963	[ITU-T G.9960]	N/A	N/A	Frames without payload intended for ITU-T G.9960 receivers	MIMO transmission or ITU-T G.9960 transmission (Note)
3	ITU-T G.9963	ITU-T G.9963 and [ITU-T G.9960]	N/A	N/A	Frames without payload intended for ITU-T G.9963 and ITU-T G.9960 receivers (no such frame type exists)	N/A
4a	ITU-T G.9963	ITU-T G.9963	2	1	Frames with payload intended for ITU-T G.9963 receivers (e.g., MSG, BMSG, BACK, PROBE)	MIMO transmission
4b			1	0		MIMO transmission or ITU-T G.9960 transmission (Note)
5	ITU-T G.9963	[ITU-T G.9960]	1	0	Frames with payload intended for ITU-T G.9960 receivers	MIMO transmission or ITU-T G.9960 transmission (Note)
6	ITU-T G.9963	ITU-T G.9963 and [ITU-T G.9960]	1	0	Frames with payload intended for ITU-T G.9963 and ITU-T G.9960 receivers (e.g., broadcast, MAP)	MIMO transmission or ITU-T G.9960 transmission (Note)
7	ITU-T G.9963	ITU-T G.9963 and [ITU-T G.9960]	N/A	N/A	Signals (e.g., INUSE, PR, NACK, IDPS)	MIMO transmission or ITU-T G.9960 transmission (Note)
NOTE – The decision concerning which scheme to use shall be made by the source device at the time of registration and shall not change as long as the device is still registered, regardless of the type of destination device it is communicating with.						

The format of the PHY frame for MIMO transmission is presented in Figure 7-3. The PHY frame at the α -reference point includes a header and a payload. The preamble and additional channel estimation (ACE) symbols are added to the PHY frame in the PMD. Both the preamble and ACE symbols do not carry any user or management data and are intended for synchronization and channel

estimation. At the MDI interface the transmission shall adhere to the following (as described in detail in clause 7.1.4):

- The preamble/header/ACE symbol(s)/payload shall be transmitted simultaneously on both Tx ports.
- The preamble and header symbol(s) to be transmitted on the second Tx port shall be copies of the preamble and header symbol(s) to be transmitted on the first Tx port.
- The payload may be created as either two spatial streams (indicated by setting the field MIMO_IND in the PFH to one) or a single spatial stream (indicated by setting the field MIMO_IND in the PFH to zero).
- ACE symbols:
 - For the case where the transmission is created as two spatial streams (i.e., case "4a" in Table 7-1):
 - The odd numbered ACE symbols (starting from the first ACE symbol, which is odd numbered) to be transmitted on the second Tx port shall be inverted versions of the same numbered ACE symbols to be transmitted on the first Tx port.
 - The even numbered ACE symbols to be transmitted on the second Tx port shall be identical to the same numbered ACE symbols to be transmitted on the first Tx port.
 For this case one ACE symbol is mandatory. Additional ACE symbols are optional.
 - In all other cases where the transmission includes payload created as a single spatial stream (i.e., cases "4b", "5" and "6" in Table 7-1), the ACE symbols to be transmitted on the second Tx port shall be identical to the same numbered ACE symbols to be transmitted on the first Tx port. In these cases all ACE symbols are optional.
- Transmission on the second Tx port shall be done with a cyclic shift with respect to the transmission on the first TX port.

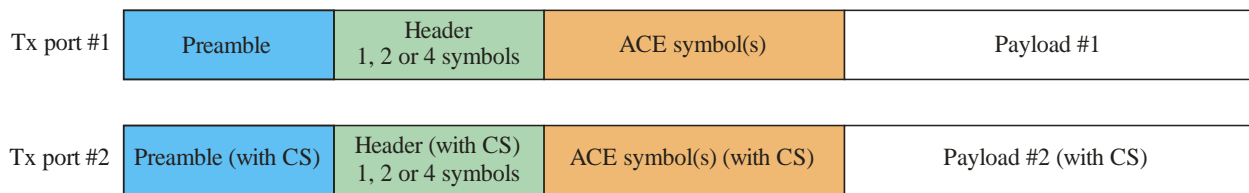

G.9963(11)_F7-3

Figure 7-3 – Format of the PHY frame in a MIMO transmission

The PHY-frame header and payload shall each contain an integer number of OFDM symbols.

The PHY-frame header always fits into an integer number of OFDM symbols and is transmitted using a single predefined set of modulation and coding parameters (see clause 7.1.3.4).

The presence of ACE symbols is frame type dependent (e.g., see clause 7.1.2.3.2.2.17).

The length of the payload may vary from frame to frame; the payload may be of zero length. For the payload, different coding parameters and bit loading can be used in different frames, depending on the channel/noise characteristics and QoS requirements.

For all of the cases shown in Table 7-1 where a node can choose either ITU-T G.9960 transmission or MIMO transmission, the node shall select one transmission rule at the time of registration and shall not change this decision as long as it is still registered. For example, if a node decides to use ITU-T G.9960 transmission rule, it shall use ITU-T G.9960 transmission rule for cases 1, 2, 4b, 5, 6 and 7. A node may select a different transmission rule if it resigns from a domain and re-registers to the domain.

NOTE – Since the transmission rule for a given node for a single spatial stream does not change from frame to frame, the channels perceived by other nodes in the domain are consistent from frame to frame.

The types of PHY frames used in this Recommendation are summarized in Table 7-1 of [ITU-T G.9960].

7.1.2.2 MPDU mapping

See clause 7.1.2.2 of [ITU-T G.9960].

7.1.2.3 PHY-frame header

See clause 7.1.2.3 of [ITU-T G.9960].

7.1.2.3.1 Common part fields

See clause 7.1.2.3.1 of [ITU-T G.9960].

7.1.2.3.2 Variable part fields

See clause 7.1.2.3.2 of [ITU-T G.9960].

7.1.2.3.2.1 MAP and RMAP PHY-frame type specific fields

See clause 7.1.2.3.2.1 of [ITU-T G.9960].

7.1.2.3.2.2 MSG PHY-frame type specific fields

Table 7-2 lists the PHY-frame header fields specific to the MSG frame type.

Table 7-2 – MSG PHY-frame type specific fields

Field	Octet	Bits	Description	Reference
MSG_DUR	0 and 1	[15:0]	Duration for MSG frame	Clause 7.1.2.3.2.2.1
BLKSZ	2	[1:0]	Block size of FEC codeword for MSG frame payload	Clause 7.1.2.3.2.2.2
FEC_RATE		[4:2]	FEC coding rate for MSG frame payload	Clause 7.1.2.3.2.2.3
REP		[7:5]	Number of repetitions used for encoding the MSG frame payload	Clause 7.1.2.3.2.2.4
FCF	3	[2:0]	FEC concatenation factor	Clause 7.1.2.3.2.2.5
SI		[6:3]	Scrambler initialization	Clause 7.1.2.3.2.2.6
MDET		[7]	Master is detected	Clause 7.1.2.3.2.2.7
BAT_ID/BMAT_ID	4	[4:0]	Bit allocation table identifier/Bit and Tx port mapping allocation table identifier for MIMO	Clause 7.1.2.3.2.2.8
OFB/GRP_ID		[7:5]	OFB identifier/sub-carrier grouping identifier	Clause 7.1.2.3.2.2.9
GI_ID	5	[2:0]	Guard interval identifier	Clause 7.1.2.3.2.2.10
APSD_MAX-M		[7:3]	APSD_MAX-M of a MSG frame	Clause 7.1.2.3.2.2.11
CONNECTION_ID	6	[7:0]	Connection identifier	Clause 7.1.2.3.2.2.12
RPRQ	7	[1:0]	Reply required	Clause 7.1.2.3.2.2.13
BRSTCnt		[3:2]	Burst frame count	Clause 7.1.2.3.2.2.14

Table 7-2 – MSG PHY-frame type specific fields

Field	Octet	Bits	Description	Reference
BEF		[4]	Burst end flag	Clause 7.1.2.3.2.2.15
AIFG_IND		[5]	AIFG indication	clause 7.1.2.3.2.2.16
MIMO_IND		[6]	MIMO indication	Clause 7.1.2.3.2.2.24
APSD_MAX_M_EXT		[7]	APSD_MAX-M extension	Clause 7.1.2.3.2.2.26
ACE_SYM	8	[2:0]	Number of ACE symbols	Clause 7.1.2.3.2.2.17
CNN_MNGMT		[6:3]	Connection management	Clause 7.1.2.3.2.2.18
Reserved		[7]	Reserved	Reserved by ITU-T (Note 1)
BRURQ	9 and 10	[15:0]	Bandwidth reservation update request	Clause 7.1.2.3.2.2.19 (Note 2)
START_SSN	9 and 10	[15:0]	Start segment sequence number	Clause 7.1.2.3.2.2.20 (Note 3)
CURRTS	11	[6:0]	Current TS	Clause 7.1.2.3.2.2.21
BTXRQ		[7]	Request for bidirectional transmission	Clause 7.1.2.3.2.2.22
NUM_MACK_SLOTS	12	[2:0]	Number of Mc-ACK slots	Clause 7.1.2.3.2.2.23
ADVISED_WIN_SIZE		[7:3]	In connection establishment this field may specify advised window size	Clause 7.1.2.3.2.2.25 (Note 4)
Reserved	13	[0]	Reserved	Reserved for use by ITU-T G.9991
Reserved		[7:1]	Reserved	Reserved by ITU-T (Note 1)
Reserved	14	[7:0]	Reserved	Reserved by ITU-T (Note 1)

NOTE 1 – Bits that are reserved by ITU-T shall be set to zero by the transmitter and ignored by the receiver.
NOTE 2 – The BRURQ field is defined when the START_SSN field is not defined (see Note 3).
NOTE 3 – The START_SSN field is defined only when CNN_MNGMT = 0001, CNN_MNGMT = 0011, CNN_MNGMT = 0101 or CNN_MNGMT = 0111. Otherwise, the meaning of this field is BRURQ.
NOTE 4 – The ADVISED_WIN_SIZE field is defined only when CNN_MNGMT = 0101, otherwise these bits are reserved by ITU-T and shall be set to zero by the transmitter and ignored by the receiver.

7.1.2.3.2.2.1 Duration for MSG frame (MSG_DUR)

See clause 7.1.2.3.2.2.1 of [ITU-T G.9960].

7.1.2.3.2.2.2 Block size (BLKSZ)

See clause 7.1.2.3.2.2.2 of [ITU-T G.9960].

7.1.2.3.2.2.3 FEC coding rate (FEC_RATE)

See clause 7.1.2.3.2.2.3 of [ITU-T G.9960].

7.1.2.3.2.2.4 Repetitions (REP)

See clause 7.1.2.3.2.2.4 of [ITU-T G.9960].

7.1.2.3.2.2.5 FEC concatenation factor (FCF)

See clause 7.1.2.3.2.2.5 of [ITU-T G.9960].

7.1.2.3.2.2.6 Scrambler initialization (SI)

See clause 7.1.2.3.2.2.6 of [ITU-T G.9960].

7.1.2.3.2.2.7 Master is detected indication (MDET)

See clause 7.1.2.3.2.2.7 of [ITU-T G.9960].

7.1.2.3.2.2.8 Bit allocation table identifier / Bit and Tx port mapping allocation table for MIMO (BAT_ID/BMAT_ID)

When this field is interpreted as BAT_ID (i.e., when MIMO_IND = 0), see clause 7.1.2.3.2.2.8 of [ITU-T G.9960].

When this field is interpreted as BMAT_ID (i.e., when MIMO_IND = 1), the BMAT_ID field shall identify the BMAT, which is composed of the following elements:

- The bit allocation tables (BATs) of the two spatial streams of the PHY frame (i.e., the BAT of spatial stream 1, BAT⁽¹⁾ and the BAT of spatial stream 2, BAT⁽²⁾).
- The Tx port mapping allocation table (MAT) of the PHY frame.

The BMAT_ID shall be represented as a 5-bit unsigned integer with valid values assigned as shown in Table 7-3.

Table 7-3 – Assignment of BMAT_ID

BMAT_ID	Type of MAT	Type of BAT⁽¹⁾	Type of BAT⁽²⁾	Description
0	Predefined MAT, Type 0	Predefined-BAT, Type 0	Note 1	Predefined BMAT, single port transmission on Tx port 1
1	Predefined MAT, Type 0	Predefined-BAT, Type 1		
2	Predefined MAT, Type 0	Predefined-BAT, Type 3	Note 2	
3	Predefined MAT, Type 0	Predefined-BAT, Type 2		
4	Predefined MAT, Type 1	Note 1	Predefined-BAT, Type 0	Predefined BMAT, single port transmission on Tx port 2
5	Predefined MAT, Type 1		Predefined-BAT, Type 1	
6	Predefined MAT, Type 1	Note 2	Predefined-BAT, Type 3	
7	Predefined MAT, Type 1		Predefined-BAT, Type 2	
8	Predefined MAT, Type 2	Predefined-BAT, Type 0	Predefined-BAT, Type 0	Predefined BMAT, MIMO, direct mapping (<i>TPM</i> #0)
9	Predefined MAT, Type 2	Predefined-BAT, Type 1	Predefined-BAT, Type 1	
10	Predefined MAT, Type 2	Predefined-BAT, Type 3	Predefined-BAT, Type 3	
11	Predefined MAT, Type 2	Predefined-BAT, Type 2	Predefined-BAT, Type 2	

Table 7-3 – Assignment of BMAT_ID

BMAT_ID	Type of MAT	Type of BAT⁽¹⁾	Type of BAT⁽²⁾	Description
12 to 15	Reserved by ITU-T for predefined MATs	Reserved by ITU-T for predefined BATs	Reserved by ITU-T for predefined BATs	Reserved by ITU-T for predefined BMATs
16 to 27	Runtime MATs	Runtime BATs	Runtime BATs	Runtime BMATs, Runtime MATs and BATs
28 to 31	Reserved by ITU-T	Reserved by ITU-T	Reserved by ITU-T	Reserved by ITU-T

NOTE 1 – The BAT is a uniform 0-bit loading on all sub-carriers except the PMSC set (i.e., no data bits are loaded on this spatial stream).
 NOTE 2 – The BAT is uniform 0-bit loading on all sub-carriers except the PMSC set and the RMSC sets (a complete SSC set) (i.e., no data bits are loaded on this spatial stream).

One or more BMAT_IDs can be assigned for each destination (per unicast DID, see clause 7.1.2.3.1.5 of [ITU-T G.9960]).

7.1.2.3.2.2.9 OFB identifier/sub-carrier grouping identifier (OFB_ID/GRP_ID)

If MIMO_IND is set to zero, see clause 7.1.2.3.2.2.9 of [ITU-T G.9960].

If MIMO_IND is set to one, the following applies.

For predefined BMATs with uniform loading (using predefined BATs of type 0, type 1, type 2 or type 3), the OFB_ID field shall contain the identifier for the operational frequency band used by the node and shall be coded as shown in Table 7-10 of [ITU-T G.9960].

For Runtime BMATs, this field shall be set at 0 by the transmitter and ignored by the receiver.

7.1.2.3.2.2.10 Guard interval identifier (GI_ID)

See clause 7.1.2.3.2.2.10 of [ITU-T G.9960].

7.1.2.3.2.2.11 Maximum Actual PSD of MSG frame (APSD_MAX-M)

See clause 7.1.2.3.2.2.11 of [ITU-T G.9960].

7.1.2.3.2.2.12 Connection identifier (CONNECTION_ID)

See clause 7.1.2.3.2.2.12 of [ITU-T G.9960].

7.1.2.3.2.2.13 Reply required (RPRQ)

See clause 7.1.2.3.2.2.13 of [ITU-T G.9960].

7.1.2.3.2.2.14 Burst frame count (BRSTCnt)

See clause 7.1.2.3.2.2.14 of [ITU-T G.9960].

7.1.2.3.2.2.15 Burst end flag (BEF)

See clause 7.1.2.3.2.2.15 of [ITU-T G.9960].

7.1.2.3.2.2.16 AIFG indication (AIFG_IND)

See clause 7.1.2.3.2.2.16 of [ITU-T G.9960].

7.1.2.3.2.2.17 ACE symbols (ACE_SYM)

See clause 7.1.2.3.2.2.17 of [ITU-T G.9960].

If MIMO_IND is set to one, ACE_SYM shall not be set to 000₂.

7.1.2.3.2.2.18 Connection management (CNN_MNGMT)

See clause 7.1.2.3.2.2.18 of [ITU-T G.9960].

7.1.2.3.2.2.19 Bandwidth reservation update request (BRURQ)

See clause 7.1.2.3.2.2.19 of [ITU-T G.9960].

7.1.2.3.2.2.20 Start segment sequence number (START_SSN)

See clause 7.1.2.3.2.2.20 of [ITU-T G.9960].

7.1.2.3.2.2.21 Current TS (CURRTS)

See clause 7.1.2.3.2.2.21 of [ITU-T G.9960].

7.1.2.3.2.2.22 Request for bidirectional transmission (BTRQ)

See clause 7.1.2.3.2.2.22 of [ITU-T G.9960].

7.1.2.3.2.2.23 Number of Mc-ACK slots (NUM_MACK_SLOTS)

See clause 7.1.2.3.2.2.23 of [ITU-T G.9960].

7.1.2.3.2.2.24 MIMO indication (MIMO_IND)

The MIMO_IND field indicates a MIMO transmission with the payload created as 2 spatial streams intended for ITU-T G.9963 receivers (i.e., case "4a" in Table 7-1). This requires at least one additional channel estimation (ACE) symbol after the PHY-frame header (PFH).

It is a 1-bit field. It shall be set to one for case "4a" in Table 7-1. It shall be set to zero for all other applicable cases (i.e., cases "4b", "5" and "6" in Table 7-1).

7.1.2.3.2.2.25 Advised window size (ADVISED_WIN_SIZE)

See clause 7.1.2.3.2.2.25 of [ITU-T G.9960].

7.1.2.3.2.2.26 APSD_MAX-M extension

See clause 7.1.2.3.2.2.26 of [ITU-T G.9960].

7.1.2.3.2.3 ACK PHY-frame type specific fields

Table 7-4 lists the PHY-frame header fields specific to the core part of the PHY-frame header of the ACK frame type.

Table 7-4 – ACK PHY frame type specific fields

Field	Octet	Bits	Description	Reference
FLCTRL_CONN	0	[0]	Flow control connection flag	Clause 7.1.2.3.2.3.1 of [ITU-T G.9960]
FLCTRLT		[1]	Flow control type	Clause 7.1.2.3.2.3.2 of [ITU-T G.9960]
FLCTRL		[6:2]	Flow control	Clause 7.1.2.3.2.3.3 of [ITU-T G.9960]
FLCTRL_EXT		[7]	Flow control extension	Clause 7.1.2.3.2.3.11 of [ITU-T G.9960]
RXRST_DATA	1	[0]	Data RX reset flag	Clause 7.1.2.3.2.3.5 of [ITU-T G.9960]

Table 7-4 – ACK PHY frame type specific fields

Field	Octet	Bits	Description	Reference
RXRST_MNGMT		[1]	Management RX reset flag	Clause 7.1.2.3.2.3.6 of [ITU-T G.9960]
BAD_BURST		[2]	Bad burst indication	Clause 7.1.2.3.2.3.7 of [ITU-T G.9960]
BTXRQ		[3]	Request for bidirectional transmission	Clause 7.1.2.3.2.3.4 of [ITU-T G.9960]
EXTACKRQ		[4]	Request for extended acknowledgement	Clause 7.1.2.3.2.3.10 of [ITU-T G.9960]
Reserved		[7:5]	Reserved	Reserved for use by [ITU-T G.9991]
ACK_CE_CTRL/RX_CONN_WIN_SIZE	2	[7:0]	ACK channel estimation control/Receiver window size for the connection (Note 1)	Clause 7.1.2.3.2.3.1
ACKDATA/MACK_D	3 to 14	[90:0]	Acknowledgement data and Mc-ACK descriptor	Clause 7.1.2.3.2.3.9 of [ITU-T G.9960]
Reserved		[95:91]	Reserved	Reserved by ITU-T (Note 2)
<p>NOTE 1 – This field is interpreted as RX_CONN_WIN_SIZE only when the ACK frame is sent as a reply for MSG frame requesting setup or reset of either a data or a management connection (i.e., when CNN_MNGMT in the MSG frame is 0101₂, 0001₂, 0011₂ or 0111₂).</p> <p>NOTE 2 – Bits that are reserved by ITU-T shall be set to zero by the transmitter and ignored by the receiver.</p>				

7.1.2.3.2.3.1 ACK channel estimation control/Receiver window size for the connection (ACK_CE_CTRL/RX_CONN_WIN_SIZE)

In case of an ACK frame sent in response to a MSG frame requesting setup or reset of a data or management connection with acknowledgements (i.e., when CNN_MNGMT in the MSG frame for connection setup is 0101₂, 0001₂, 0011₂ or 0111₂ see Table 7-17 of [ITU-T G.9960]), this parameter is called RX_CONN_WIN_SIZE and the value of this parameter shall indicate the maximum acknowledge window size (i.e., ACK_RX_CONF_WINDOW_SIZE in clause 8.9.4.3 in [ITU-T G.9961]) that the receiver can support for the connection being setup. The maximum acknowledge window size shall be 8 times the value of (RX_CONN_WIN_SIZE+1) LPDUs. The valid values for the maximum acknowledge window size shall be 8, 16, 24 ... 1024 LPDUs. The indicated value of maximum acknowledge window size shall be less than or equal to ACK_MAX_WINDOW_SIZE (1024 for data connections, 32 for management connections – see clause 8.9.4.1 in [ITU-T G.9961]).

For all other ACK frames, this field is called, ACK_CE_CTRL and is used for channel estimation control. It is an 8-bit field that consists of the ACK_CE_CTRL_TYPE, the RUNTIME_BAT_ID/RUNTIME_BMAT_ID and the RUNTIME_BMAT_ID fields as shown in Table 7-5.

Table 7-5 – Interpretation of the ACK_CE_CTRL field

Field	Octet	Bits
ACK_CE_CTRL_TYPE	0	[1:0]
RUNTIME_BAT_ID/RUNTIME_BMAT_ID		[6:2]
BMAT_ID_IND		[7]

7.1.2.3.2.3.1.1 ACK channel estimation control type (ACK_CE_CTRL_TYPE)

When BMAT_ID_IND equals 0, ACK_CE_CTRL_TYPE shall be coded as shown in Table 7-25 of [ITU-T G.9960] as specified in clause 7.1.2.3.2.3.8.1 of [ITU-T G.9960].

When BMAT_ID_IND equals 1, ACK_CE_CTRL_TYPE shall be coded as shown in Table 7-6.

Table 7-6 – ACK_CE_CTRL_TYPE field values when BMAT_ID_IND = 1

ACK_CE_CTRL_TYPE value (b ₁ b ₀)	Interpretation
00	No ACK_CE_CTRL information is transmitted
01	RUNTIME_BMAT_ID is invalid
10	Request PROBE frame transmission.
11	Reserved by ITU-T

If the BMAT_ID_IND field equals 1 and the ACK_CE_CTRL_TYPE field is set to 01₂, the runtime BMAT associated with the RUNTIME_BMAT_ID shall not be used for transmission, as specified in clause 8.11.1.5.

If the BMAT_ID_IND field equals 1 and the ACK_CE_CTRL_TYPE field is set to 10₂, transmission of a 2 SS channel estimation PROBE frame is requested.

Otherwise, the ACK_CE_CTRL_TYPE field shall be set to 00₂.

7.1.2.3.2.3.1.2 Runtime BAT_ID (RUNTIME_BAT_ID)/Runtime BMAT ID (RUNTIME_BMAT_ID)

When this field is interpreted as RUNTIME_BAT_ID (i.e., when BMAT_ID_IND = 0), see clause 7.1.2.3.2.3.8.2 of [ITU-T G.9960].

When this field is interpreted as RUNTIME_BMAT_ID (i.e., when BMAT_ID_IND = 1), the following applies.

If the ACK_CE_CTRL_TYPE field is set to 01₂, this field shall contain a RUNTIME_BMAT_ID (see Table 7-3). Otherwise, it shall be set to 00000₂.

7.1.2.3.2.3.1.3 BMAT_ID indication (BMAT_ID_IND)

If the BMAT_ID_IND field is set to 0, the interpretation of the other subfields in the ACK_CE_CTRL shall be as described in [ITU-T G.9960].

If the BMAT_ID_IND field is set to 1, the interpretation of the other subfields in the ACK_CE_CTRL shall be as described in this Recommendation.

7.1.2.3.2.4 RTS PHY-frame type specific fields

See clause 7.1.2.3.2.4 of [ITU-T G.9960].

7.1.2.3.2.5 CTS PHY-frame type specific fields

See clause 7.1.2.3.2.5 of [ITU-T G.9960].

7.1.2.3.2.6 CTMG PHY-frame type specific fields

See clause 7.1.2.3.2.6 of [ITU-T G.9960].

7.1.2.3.2.7 PROBE PHY-frame type specific fields

The PROBE PHY-frame type specific field is composed of a common part and a variable part. The common part contains fields that are common for all PROBE PHY-frame types (PRBTYPEs). The variable part contains fields that are specific to each PRBTYPE.

The fields of the common part of the PROBE PHY-frame specific field are defined in Table 7-7.

Table 7-7 – PROBE PHY-frame type specific fields

Field	Octet	Bits	Description	Reference
Common part				
PRB_DUR	0 and 1	[15:0]	Duration for PROBE frame	Clause 7.1.2.3.2.7.1.1
PRBTYPE	2	[3:0]	PROBE frame type	Clause 7.1.2.3.2.7.1.2
PRBSYM		[7:4]	Probe symbols	Clause 7.1.2.3.2.7.1.3
APSD_MAX-P	3	[4:0]	APSD_MAX-P of a PROBE frame	Clause 7.1.2.3.2.7.1.4
PRBGI		[7:5]	Probe symbol guard interval	Clause 7.1.2.3.2.7.1.5
CURRTS	4	[6:0]	Current TS	Clause 7.1.2.3.2.7.1.6
MIMO_IND		[7]	MIMO indication	Clause 7.1.2.3.2.7.1.7
APSD_MAX-P_EXT	5	[0]	APSD_MAX-P Extension	Clause 7.1.2.3.2.7.1.8
Reserved		[7:1]	Reserved	Reserved by ITU-T (Note)
Variable part				
PFTSF	6 to 14	[71:0]	PROBE frame type specific field	Clause 7.1.2.3.2.7.2
NOTE – Bits that are reserved by ITU-T shall be set to zero by the transmitter and ignored by the receiver.				

7.1.2.3.2.7.1 Common part fields

7.1.2.3.2.7.1.1 Duration for PROBE frame (PRB_DUR)

See clause 7.1.2.3.2.7.1.1 of [ITU-T G.9960].

7.1.2.3.2.7.1.2 PROBE frame type (PRBTYPE)

The PRBTYPE field shall contain the type of the PROBE frame. It is a 4-bit field that shall be coded as shown in Table 7-8.

Table 7-8 – PRBTYPE field values

PRBTYPE value (b₃b₂b₁b₀)	Interpretation	Reference	MIMO_IND
0000	Silent PROBE frame – a PHY frame in which the probe symbols composing the payload shall all be silent symbols, as specified in clause 7.1.3.7.	Clause 7.1.2.3.2.7.2.1	0
0001	1 SS channel estimation PROBE frame – a PHY frame in which the probe symbols composing the payload shall all be 1 SS channel estimation probe symbols, as specified in clause 7.1.3.7.	Clause 7.1.2.3.2.7.2.2	0
0010 to 0111	Reserved by ITU-T.		Reserved
1000	2 SS channel estimation PROBE frame – a PHY frame in which the probe symbols composing the payload shall all be 2 SS channel estimation probe symbols, as specified in clause 7.1.3.7.	Clause 7.1.2.3.2.7.2.3	1
1001 to 1111	Reserved by ITU-T.		Reserved

7.1.2.3.2.7.1.3 Probe symbols (PRBSYM)

See clause 7.1.2.3.2.7.1.3 of [ITU-T G.9960].

7.1.2.3.2.7.1.4 Maximum Actual PSD of PROBE frame (APSD_MAX-P)

See clause 7.1.2.3.2.7.1.4 of [ITU-T G.9960].

7.1.2.3.2.7.1.5 PROBE symbol guard interval (PRBGI)

See clause 7.1.2.3.2.7.1.5 of [ITU-T G.9960].

7.1.2.3.2.7.1.6 Current TS (CURRTS)

See clause 7.1.2.3.2.7.6 of [ITU-T G.9960].

7.1.2.3.2.7.1.7 MIMO indication (MIMO_IND)

See clause 7.1.2.3.2.2.24.

7.1.2.3.2.7.1.8 APSD_MAX-P Extension

See clause 7.1.2.3.2.7.1.7 of [ITU-T G.9960].

7.1.2.3.2.7.2 PROBE frame type specific fields

7.1.2.3.2.7.2.1 Silent PROBE frame specific fields

See clause 7.1.2.3.2.7.2.1 of [ITU-T G.9960].

7.1.2.3.2.7.2.2 1 SS channel estimation PROBE frame specific fields

See clause 7.1.2.3.2.7.2.2 of [ITU-T G.9960].

7.1.2.3.2.7.2.3 2 SS channel estimation PROBE frame specific fields

The fields of the specific part of the 2 SS channel estimation PROBE frame are defined in Table 7-9.

Table 7-9 – 2 SS channel estimation PROBE frame specific field values

Field	Octet	Bits	Description	Reference
PRB_BMAT_ID	0	[4:0]	BMAT_ID used to generate the PROBE	Clause 7.1.2.3.2.7.2.3.1
ACE_SYM	0	[7:5]	Number of ACE symbols	Clause 7.1.2.3.2.7.2.3.2
NUM_SILENT_SYM	1	[5:0]	Number of silent symbols	Clause 7.1.2.3.2.7.2.3.3
Reserved	1	[7:6]	Reserved by ITU-T (Note)	
Reserved	2 to 8	[55:0]	Reserved by ITU-T (Note)	
NOTE – Bits that are reserved by ITU-T shall be set to zero by the transmitter and ignored by the receiver.				

7.1.2.3.2.7.2.3.1 PROBE frame BMAT_ID (PRB_BMAT_ID)

This field indicates the BMAT_ID (predefined or runtime) whose mapping allocation table (MAT) is used in the Tx port mapper to generate this 2 SS channel estimation PROBE frame. The bit allocation tables (BATs) associated with the BMAT_ID are only relevant to infer the Tx port mapping (TPMs) used per sub-carrier (see Table 8-27) for 2 SS channel estimation probe symbol generation (see clause 7.1.4.2.4.3). Therefore, if the PRB_BMAT_ID conveys a predefined BMAT_ID, the valid values for channel estimation shall be 3, 7 and 11.

NOTE – The PRB_BMAT_ID field allows transmitting PROBES using the precoding parameters associated with a given runtime BMAT_ID.

7.1.2.3.2.7.2.3.2 ACE symbols (ACE_SYM)

See clause 7.1.2.3.2.2.17 of [ITU-T G.9960].

If MIMO_IND is set to one, ACE_SYM shall not be set to 000₂.

7.1.2.3.2.7.2.3.3 Number of silent symbols (NUM_SILENT_SYM)

This field indicates the number of silent symbols that shall be transmitted instead of probe symbols at the end of the 2 SS channel estimation PROBE frame. The valid range is from 0 (no silent symbol) to 63 (63 silent symbols). NUM_SILENT_SYM shall be less than or equal to PRBSYM. First (PRBSYM – NUM_SILENT_SYM) symbols of the 2 SS channel estimation PROBE frame are normal (non-silent) probe symbols.

7.1.2.3.2.8 ACKRQ PHY frame type specific fields

See clause 7.1.2.3.2.8 of [ITU-T G.9960].

7.1.2.3.2.9 BMSG PHY-frame type specific fields

Table 7-10 lists the fields specific to the core part of the PHY-frame header of the BMSG frame type.

Table 7-10 – BMSG PHY-frame type specific fields – core part

Field	Octet	Bits	Description	Reference
BMSG_DUR	0 and 1	[15:0]	Duration for BMSG frame	Clause 7.1.2.3.2.9.1
BLKSZ	2	[1:0]	Block size of FEC codeword for BMSG frame payload	Clause 7.1.2.3.2.9.2
FEC_RATE		[4:2]	FEC coding rate for BMSG frame payload	Clause 7.1.2.3.2.9.3

Table 7-10 – BMSG PHY-frame type specific fields – core part

Field	Octet	Bits	Description	Reference
REP		[7:5]	Number of repetitions used for encoding the BMSG frame payload	Clause 7.1.2.3.2.9.4
FCF	3	[2:0]	FEC concatenation factor	Clause 7.1.2.3.2.9.5
SI		[6:3]	Scrambler initialization	Clause 7.1.2.3.2.9.6
MDET		[7]	Master is detected	Clause 7.1.2.3.2.9.7
BAT_ID/ BMAT_ID	4	[4:0]	Bit allocation table identifier/Bit allocation and Tx port mapping allocation table identifier for MIMO	Clause 7.1.2.3.2.9.8
OFB_ID/GRP_ID		[7:5]	Operational frequency band identifier/sub-carrier grouping identifier	Clause 7.1.2.3.2.9.9
GI_ID	5	[2:0]	Guard interval identifier	Clause 7.1.2.3.2.9.10
APSD_MAX-M		[7:3]	APSD_MAX-M of a BMSG frame	Clause 7.1.2.3.2.9.11
CONNECTION_ID	6	[7:0]	Connection identifier	Clause 7.1.2.3.2.9.12
RPRQ	7	[1:0]	Reply required	Clause 7.1.2.3.2.9.13
BRSTCnt		[3:2]	Burst frame count	Clause 7.1.2.3.2.9.14
BEF		[4]	Burst end flag	Clause 7.1.2.3.2.9.15
AIFG_IND		[5]	AIFG indication	Clause 7.1.2.3.2.9.16
MIMO_IND		[6]	MIMO indication	Clause 7.1.2.3.2.9.25
EXTACKGR		[7]	Extended ACK granted	Clause 7.1.2.3.2.9.26
ACE_SYM	8	[2:0]	Number of ACE symbols	Clause 7.1.2.3.2.9.17
CNN_MNGMT		[6:3]	Connection management	Clause 7.1.2.3.2.9.18
APSD_MAX-M_EXT		[7]	APSD_MAX-M Extension	Clause 7.1.2.3.2.9.28
BRURQ	9 and 10	[15:0]	Bandwidth reservation update request	Clause 7.1.2.3.2.9.19 (Note 2)
START_SSN	9 and 10	[15:0]	Start segment sequence number	Clause 7.1.2.3.2.9.20 (Note 3)
CURRTS	11	[6:0]	Current TS	Clause 7.1.2.3.2.9.21
Reserved		[7]	Reserved	Reserved by ITU-T (Note 1)
Reserved	12 and 13	[0]	Reserved	Reserved by ITU-T (Note 1)
BTXGL		[8:1]	Bidirectional transmission grant length	Clause 7.1.2.3.2.9.22
BTXEF		[9]	Bidirectional transmission end flag	Clause 7.1.2.3.2.9.23
P-DACK		[10]	Piggybacked delayed acknowledgement	Clause 7.1.2.3.2.9.27
Reserved		[15:11]	Reserved	Reserved by ITU-T (Note 1)

Table 7-10 – BMSG PHY-frame type specific fields – core part

Field	Octet	Bits	Description	Reference
ACK_CE_CTRL	14	[7:0]	ACK channel estimation control	Clause 7.1.2.3.2.9.24
<p>NOTE 1 – Bits that are reserved by ITU-T shall be set to zero by the transmitter and ignored by the receiver.</p> <p>NOTE 2 – The BRURQ field is defined when the START_SSN field is not defined.</p> <p>NOTE 3 – The START_SSN field is defined only when CNN_MNGMT = 0001, CNN_MNGMT = 0011, CNN_MNGMT = 0101 or CNN_MNGMT = 0111. Otherwise the meaning of this field is BRURQ.</p>				

The PHY-frame header fields specific to the extended part of the header of the BMSG frame type are listed in Table 7-54 of [ITU-T G.9960].

7.1.2.3.2.9.1 Duration for BMSG frame (BMSG_DUR)

See clause 7.1.2.3.2.9.1 of [ITU-T G.9960].

7.1.2.3.2.9.2 Block size (BLKSZ)

See clause 7.1.2.3.2.9.2 of [ITU-T G.9960].

7.1.2.3.2.9.3 FEC coding rate (FEC_RATE)

See clause 7.1.2.3.2.9.3 of [ITU-T G.9960].

7.1.2.3.2.9.4 Repetitions (REP)

See clause 7.1.2.3.2.9.4 of [ITU-T G.9960].

7.1.2.3.2.9.5 FEC concatenation factor (FCF)

See clause 7.1.2.3.2.9.5 of [ITU-T G.9960].

7.1.2.3.2.9.6 Scrambler initialization (SI)

See clause 7.1.2.3.2.9.6 of [ITU-T G.9960].

7.1.2.3.2.9.7 Master is detected indication (MDET)

See clause 7.1.2.3.2.9.7 of [ITU-T G.9960].

7.1.2.3.2.9.8 Bit allocation table identifier / Bit and Tx port mapping allocation table for MIMO (BAT_ID/BMAT_ID)

See clause 7.1.2.3.2.2.8.

7.1.2.3.2.9.9 OFB identifier/sub-carrier grouping identifier (OFB_ID/GRP_ID)

See clause 7.1.2.3.2.2.9.

7.1.2.3.2.9.10 Guard interval identifier (GI_ID)

See clause 7.1.2.3.2.9.10 of [ITU-T G.9960].

7.1.2.3.2.9.11 Maximum Actual PSD of BMSG frame (APSD_MAX-M)

See clause 7.1.2.3.2.9.11 of [ITU-T G.9960].

7.1.2.3.2.9.12 Connection identifier (CONNECTION_ID)

See clause 7.1.2.3.2.9.12 of [ITU-T G.9960].

7.1.2.3.2.9.13 Reply required (RPRQ)

See clause 7.1.2.3.2.9.13 of [ITU-T G.9960].

7.1.2.3.2.9.14 Burst frame count (BRSTCnt)

See clause 7.1.2.3.2.9.14 of [ITU-T G.9960].

7.1.2.3.2.9.15 Burst end flag (BEF)

See clause 7.1.2.3.2.9.15 of [ITU-T G.9960].

7.1.2.3.2.9.16 AIFG indication (AIFG_IND)

See clause 7.1.2.3.2.9.16 of [ITU-T G.9960].

7.1.2.3.2.9.17 ACE symbols (ACE_SYM)

See clause 7.1.2.3.2.9.17 of [ITU-T G.9960].

7.1.2.3.2.9.18 Connection management (CNN_MNGMT)

See clause 7.1.2.3.2.9.18 of [ITU-T G.9960].

7.1.2.3.2.9.19 Bandwidth reservation update request (BRURQ)

See clause 7.1.2.3.2.9.19 of [ITU-T G.9960].

7.1.2.3.2.9.20 Start segment sequence number (START_SSN)

See clause 7.1.2.3.2.9.20 of [ITU-T G.9960].

7.1.2.3.2.9.21 Current TS (CURRTS)

See clause 7.1.2.3.2.9.21 of [ITU-T G.9960].

7.1.2.3.2.9.22 Bidirectional transmission grant length (BTXGL)

See clause 7.1.2.3.2.9.22 of [ITU-T G.9960].

7.1.2.3.2.9.23 Bidirectional transmission end flag (BTXEF)

See clause 7.1.2.3.2.9.23 of [ITU-T G.9960].

7.1.2.3.2.9.24 ACK channel estimation control (ACK_CE_CTRL)

The interpretation of this field shall be as specified for the ACK_CE_CTRL field of the ACK frame in clause 7.1.2.3.2.3.1.

7.1.2.3.2.9.25 MIMO indication (MIMO_IND)

See clause 7.1.2.3.2.2.24.

7.1.2.3.2.9.26 Extended ACK Granted (EXTACKGR)

See clause 7.1.2.3.2.9.25 of [ITU-T G.9960].

7.1.2.3.2.9.27 Piggybacked delayed acknowledgement (P-DACK)

See clause 7.1.2.3.2.9.26 of [ITU-T G.9960].

7.1.2.3.2.9.28 APSD_MAX-M extension

See clause 7.1.2.3.2.9.27 of [ITU-T G.9960].

7.1.2.3.2.10 BACK PHY-frame type specific fields

Table 7-11 lists the fields specific to the core part of the PHY-frame header of the BACK frame type.

Table 7-11 – BACK PHY-frame type specific fields – core part

Field	Octet	Bits	Description	Reference
BACK_DUR	0 and 1	[15:0]	Duration for BACK frame	Clause 7.1.2.3.2.10.1
BLKSZ	2	[1:0]	Block size of FEC codeword for BACK frame payload	Clause 7.1.2.3.2.10.2
FEC_RATE		[4:2]	FEC coding rate for BACK frame payload	Clause 7.1.2.3.2.10.3
REP		[7:5]	Number of repetitions used for encoding the BACK frame payload	Clause 7.1.2.3.2.10.4
FCF	3	[2:0]	FEC concatenation factor	Clause 7.1.2.3.2.10.5
SI		[6:3]	Scrambler initialization	Clause 7.1.2.3.2.10.6
MDET		[7]	Master is detected	Clause 7.1.2.3.2.10.7
BAT_ID/BMAT_ID	4	[4:0]	Bit allocation table identifier/Bit allocation and Tx port mapping allocation table identifier for MIMO	Clause 7.1.2.3.2.10.8
OFB_ID/GRP_ID		[7:5]	Operational frequency band identifier/sub-carrier grouping identifier	Clause 7.1.2.3.2.10.9
GI_ID	5	[2:0]	Guard interval identifier	Clause 7.1.2.3.2.10.10
APSD_MAX-M		[7:3]	APSD_MAX-M of a BACK frame	Clause 7.1.2.3.2.10.11
CONNECTION_ID	6	[7:0]	Connection identifier	Clause 7.1.2.3.2.10.12
RPRQ	7	[1:0]	Reply required	Clause 7.1.2.3.2.10.13
BRSTCnt		[3:2]	Burst frame count	Clause 7.1.2.3.2.10.14
BEF		[4]	Burst end flag	Clause 7.1.2.3.2.10.15
AIFG_IND		[5]	AIFG indication	Clause 7.1.2.3.2.10.16
MIMO_IND		[6]	MIMO indication	Clause 7.1.2.3.2.10.21
APSD_MAX-M_EXT		[7]	APSD_MAX-M extension	Clause 7.1.2.3.2.10.22
ACE_SYM		8	[2:0]	Number of ACE symbols
CNN_MNGMT	[6:3]		Connection management	Clause 7.1.2.3.2.10.18
Reserved	[7]		Reserved	Reserved by ITU-T (Note)
BTXRL	9	[7:0]	Bidirectional transmission request length	Clause 7.1.2.3.2.10.19
ACK_CE_CTRL	10	[7:0]	ACK channel estimation control	Clause 7.1.2.3.2.10.20
Reserved	11 to 14	[31:0]	Reserved	Reserved by ITU-T (Note)

NOTE – Bits that are reserved by ITU-T shall be set to zero by the transmitter and ignored by the receiver.

The PHY-frame header fields specific to the extended part of the header of the BACK frame type are listed in Table 7-54 of [ITU-T G.9960].

7.1.2.3.2.10.1 Duration for BACK frame (BACK_DUR)

See clause 7.1.2.3.2.10.1 of [ITU-T G.9960].

7.1.2.3.2.10.2 Block size (BLKSZ)

See clause 7.1.2.3.2.10.2 of [ITU-T G.9960].

7.1.2.3.2.10.3 FEC coding rate (FEC_RATE)

See clause 7.1.2.3.2.10.3 of [ITU-T G.9960].

7.1.2.3.2.10.4 Repetitions (REP)

See clause 7.1.2.3.2.10.4 of [ITU-T G.9960].

7.1.2.3.2.10.5 FEC concatenation factor (FCF)

See clause 7.1.2.3.2.10.5 of [ITU-T G.9960].

7.1.2.3.2.10.6 Scrambler initialization (SI)

See clause 7.1.2.3.2.10.6 of [ITU-T G.9960].

7.1.2.3.2.10.7 Master is detected indication (MDET)

See clause 7.1.2.3.2.10.7 of [ITU-T G.9960].

7.1.2.3.2.10.8 Bit allocation table identifier / Bit and Tx port mapping allocation table for MIMO (BAT_ID/BMAT_ID)

See clause 7.1.2.3.2.2.8.

7.1.2.3.2.10.9 OFB identifier/sub-carrier grouping identifier (OFB_ID/GRP_ID)

See clause 7.1.2.3.2.2.9.

7.1.2.3.2.10.10 Guard interval identifier (GI_ID)

See clause 7.1.2.3.2.10.10 of [ITU-T G.9960].

7.1.2.3.2.10.11 Maximum Actual PSD of BACK frame (APSD_MAX-M)

See clause 7.1.2.3.2.10.11 of [ITU-T G.9960].

7.1.2.3.2.10.12 Connection identifier (CONNECTION_ID)

See clause 7.1.2.3.2.10.12 of [ITU-T G.9960].

7.1.2.3.2.10.13 Reply required (RPRQ)

See clause 7.1.2.3.2.10.13 of [ITU-T G.9960].

7.1.2.3.2.10.14 Burst frame count (BRSTCnt)

See clause 7.1.2.3.2.10.14 of [ITU-T G.9960].

7.1.2.3.2.10.15 Burst end flag (BEF)

See clause 7.1.2.3.2.10.15 of [ITU-T G.9960].

7.1.2.3.2.10.16 AIFG indication (AIFG_IND)

See clause 7.1.2.3.2.10.16 of [ITU-T G.9960].

7.1.2.3.2.10.17 ACE symbols (ACE_SYM)

See clause 7.1.2.3.2.10.17 of [ITU-T G.9960].

7.1.2.3.2.10.18 Connection management (CNN_MNGMT)

See clause 7.1.2.3.2.10.18 of [ITU-T G.9960].

7.1.2.3.2.10.19 Bidirectional transmission request length (BTXRL)

See clause 7.1.2.3.2.10.19 of [ITU-T G.9960].

7.1.2.3.2.10.20 ACK channel estimation control (ACK_CE_CTRL)

The interpretation of this field shall be as specified for the ACK_CE_CTRL field of the ACK frame in clause 7.1.2.3.2.3.1.

7.1.2.3.2.10.21 MIMO indication (MIMO_IND)

See clause 7.1.2.3.2.2.24.

7.1.2.3.2.10.22 APSD_MAX-M extension

See clause 7.1.2.3.2.10.21 of [ITU-T G.9960].

7.1.2.3.2.11 ACTMG PHY-frame type specific fields

See clause 7.1.2.3.2.11 of [ITU-T G.9960].

7.1.2.3.2.12 Reserved

Reserved by ITU-T.

7.1.2.3.2.13 Reserved

Reserved by ITU-T.

7.1.2.3.2.14 Reserved

Reserved by ITU-T.

7.1.2.3.2.15 Reserved

Reserved by ITU-T.

7.1.2.3.2.16 FTE PHY-frame type specific fields

See clause 7.1.2.3.2.16 of [ITU-T G.9960].

7.1.2.3.2.17 Maximum actual PSD of MAP frame (APSD_MAX-MAP_LSB and APSD_MAX-MAP_MSB)

See clause 7.1.2.3.2.17 of [ITU-T G.9960].

7.1.2.3.3 Extended header fields

See clause 7.1.2.3.3 of [ITU-T G.9960].

7.1.3 Physical medium attachment (PMA) sublayer

The functional model of the PMA is presented in Figure 7-4. It is intended to describe in more detail the PMA functional block presented in Figure 7-1.

In the transmit direction, the incoming PHY frame (except for the preamble and the channel estimation symbols) at the α -reference point has a format as defined in clause 7.1.2. Both the header bits and the payload bits of the incoming frame are scrambled as described in clause 7.1.3.1. The header bits of the incoming frame are encoded as described in clause 7.1.3.4. The payload bits are

encoded, as described in clause 7.1.3.3. The parameters of the payload encoder are controlled by the PHY management entity.

After encoding, the payload is parsed into multiple spatial streams as described in clause 7.1.3.5. The header and payload are then each segmented into an integer number of symbol frames as described in clause 7.1.3.6. The obtained symbol frames of the header and the payload are submitted to the PMD (at the δ -reference point) for modulation and transmission over the medium.

In the receive direction, all necessary inverse operations of payload spatial streams de-parsing, decoding and de-scrambling are performed on the received symbol frames. The recovered PHY-frame header and payload are submitted to the α -reference point for further processing in the PCS.

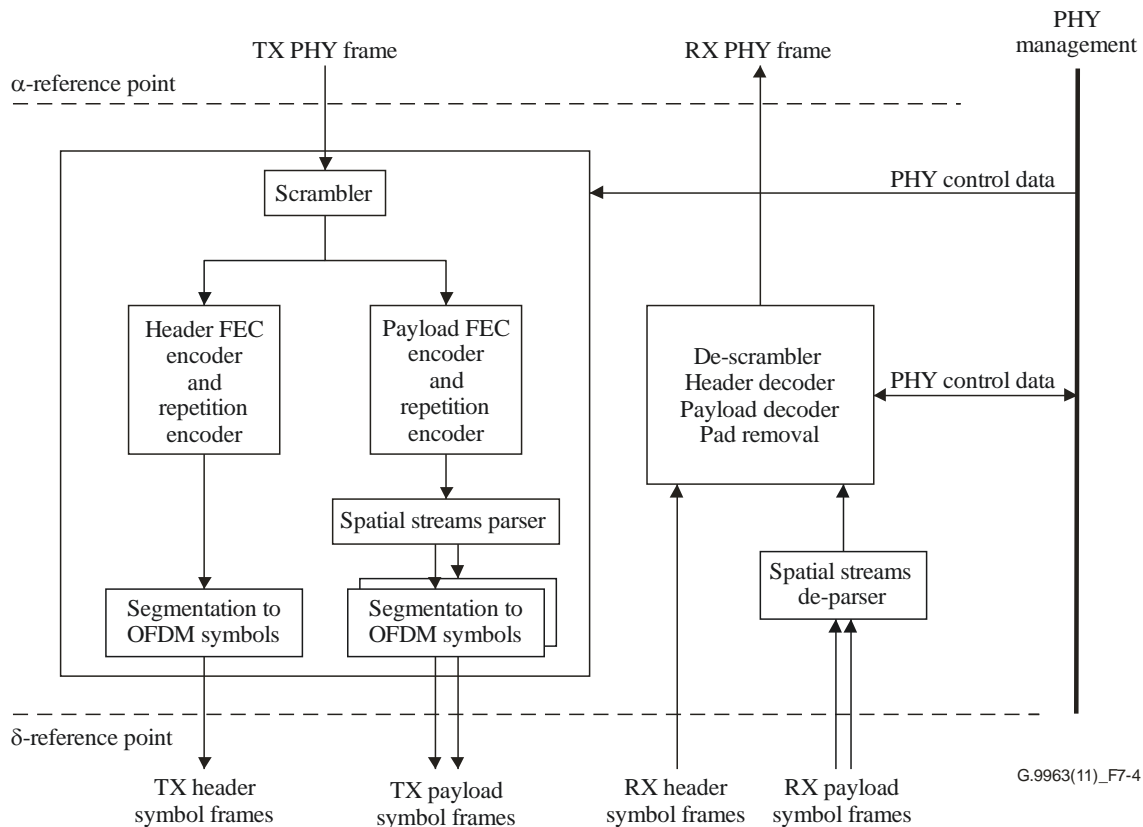

Figure 7-4 – Functional model of PMA

7.1.3.1 Scrambling

See clause 7.1.3.1 of [ITU-T G.9960].

7.1.3.2 FEC encoding

See clause 7.1.3.2 of [ITU-T G.9960].

7.1.3.3 Payload encoding

See clause 7.1.3.3 of [ITU-T G.9960]. Whenever an ITU-T G.9963 node uses RCM, the payload is created as a single spatial stream, using the RCM scheme described in clause 7.1.3.3 of [ITU-T G.9960].

7.1.3.4 Header encoding

See clause 7.1.3.4 of [ITU-T G.9960]. The PHY-frame header shall be created as a single spatial stream.

7.1.3.5 Spatial stream parser

The encoded payload block is the input of the spatial stream parser. Whenever the payload is to be created as two spatial streams, this block shall output the two spatial streams that will later be segmented into OFDM symbols. Whenever the payload is to be created as a single spatial stream, the encoded payload block is delivered to the output of this block as is (i.e., the stream parser is not operating in this case).

The parsing operation shall assign bits alternatively to each stream at the sub-carrier level. Defining $b_j^{(i)}$ as the number of data bits to be loaded to the sub-carrier j of spatial stream i , the spatial stream parser shall:

- Assign the first $b_0^{(1)}$ bits at its input to spatial stream 1
- Assign the next $b_0^{(2)}$ bits at its input to spatial stream 2
- Assign the next $b_1^{(1)}$ bits at its input to spatial stream 1
- Assign the next $b_1^{(2)}$ bits at its input to spatial stream 2
- And so on ...

NOTE – If $b_j^{(i)}$ is zero, no data bits are assigned to sub-carrier j of spatial stream i .

7.1.3.6 Segmentation into symbol frames

The parsed payload blocks for spatial streams 1 and 2 and the encoded header block from the output of the header encoder shall be segmented into symbol frames. The maximum number of bits in the payload symbol frame of spatial stream 1 shall not exceed the value of $k_P^{(1)}$. In a similar way, the maximum number of bits in the payload symbol frame of spatial stream 2 shall not exceed the value of $k_P^{(2)}$. $k_P^{(i)}$ is the total number of bits that can be loaded onto the payload OFDM symbol of spatial stream i according to the current BAT of this spatial stream. The number of bits in the header symbol frame shall be k_H . Payload and header symbol frames shall be passed to the PMD, as described in Figure 7-4.

7.1.3.6.1 Payload segmentation

After parsing the encoded payload block, the set of bits assigned to spatial stream 1 and the set of bits assigned to spatial stream 2 shall each be segmented into one or more symbol frames, denoted hereafter as "symbol frames of spatial stream 1" and "symbol frames of spatial stream 2".

In normal mode (see Figure 7-8 of [ITU-T G.9960]) and for each spatial stream, the first symbol frame of spatial stream i (i , is the number of the spatial stream and is either 1 or 2) shall contain the first $k_P^{(i)}$ bits of the payload block of spatial stream i . The second symbol frame of spatial stream i shall contain the second $k_P^{(i)}$ bits of the payload block of spatial stream i and so on, until the last symbol frame of spatial stream i . If the number of bits in the last symbol frame is less than $k_P^{(i)}$, the unloaded supported sub-carriers of the OFDM symbol for the last symbol frame shall be modulated by a pseudo-random sequence of bits, as described in clause 7.1.4.2.5. Payload segmentation is illustrated in Figure 7-5.

In RCM the payload is created as a single spatial stream. In this case, the payload segmentation shall be as described for RCM in clause 7.1.3.5.1 of [ITU-T G.9960].

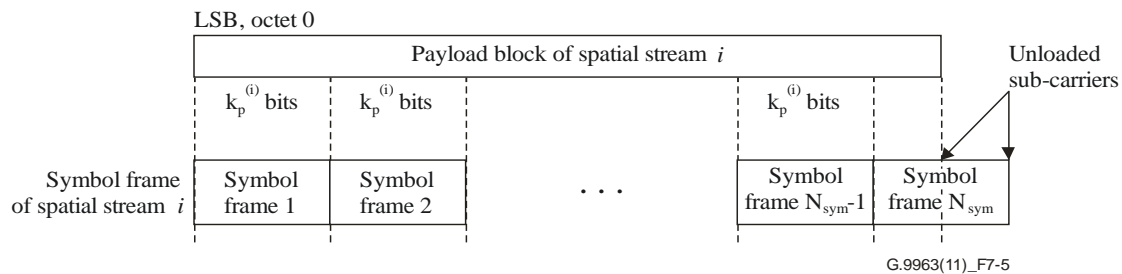

Figure 7-5 – Payload segmentation of the payload block of spatial stream i ($i = 1,2$)

7.1.3.6.2 Header segmentation

See clause 7.1.3.5.2 of [ITU-T G.9960].

7.1.3.7 PROBE frame

The PROBE frame is intended for the channel estimation procedure. The header of the PROBE frame shall be as defined in clause 7.1.2.3. Following the PFH, the PROBE frame may include ACE symbols as defined in clauses 7.1.4.2.4.4 (tone mapping) and 7.1.4.4.2 (Tx port mapping). The payload of the PROBE frame shall contain a number of probe symbols, i.e., symbol frames with no data, which can be of three types:

- Silent symbols, which are symbols for which all sub-carriers are considered masked sub-carriers (MSCs).
- 1 SS channel estimation probe symbols, which are created as a single SS and for which all supported sub-carriers (SSCs) are considered inactive sub-carriers (ISCs) and are modulated by a pseudo-random sequence.
- 2 SS channel estimation probe symbols, which are created as two SSs and for which, for both SSs, all supported sub-carriers (SSCs) are considered inactive sub-carriers (ISCs) and are modulated by a pseudo-random sequence.

The total number of probe symbols in each frame is indicated via the PRBSYM field in clause 7.1.2.3.2.7.1.3.

Three PROBE frame types are identified by the PRBTYPE field as specified in clause 7.1.2.3.2.7.1.2 (Table 7-8):

- The "Silent PROBE frame" (PRBTYPE 0000₂). The payload of this frame type shall be composed of silent symbols.
- The "1 SS channel estimation PROBE frame" (PRBTYPE 0001₂). The payload of this frame type shall be composed of channel estimation probe symbols.
- The "2 SS channel estimation PROBE frame" (PRBTYPE 1000₂). The payload of this frame type shall be composed of 2 SS channel estimation probe symbols followed by silent symbols (the number of silent symbols in the frame is between 0 and PRBSYM as identified by the NUM_SILENT_SYM field, specified in clause 7.1.2.3.2.7.2.3.3).

These PROBE frame types can be categorized into two categories:

- PROBE frame types which include probe symbols created as a single spatial stream (i.e., when MIMO_IND=0). These frame types are intended for the channel estimation procedure for links with ITU-T G.9960/G.9961 nodes and links with ITU-T G.9963 nodes using a single SS (see clause 8.11). This category includes the "Silent PROBE frame" (PRBTYPE 0000₂) and the "1 SS channel estimation PROBE frame" (PRBTYPE 0001₂) PROBE frame types. The payload of these PROBE frame types includes probe symbols which can be generated in two ways:

- When the PROBE frame is transmitted using the ITU-T G.9960 transmission, the probe symbols shall be generated as defined in clauses 7.1.4.2.5.3 of [ITU-T G.9960].
- When the PROBE frame is transmitted using the MIMO transmission scheme (with the payload created as a single SS), the probe symbols shall be generated as defined in clauses 7.1.4.2.4.3 and 7.1.4.2.5 (tone mapping) and clause 7.1.4.4.3 (Tx port mapping).
- PROBE frame types which include probe symbols created as two spatial streams (i.e., when MIMO_IND=1). These frame types are intended for the channel estimation procedure for links with ITU-T G.9963 nodes using two SSs described in clause 8.11.1. This category includes the "2 SS channel estimation PROBE frame" (PRBTYPE 1000₂) PROBE frame type. The payload of this PROBE frame type may include both 2 SS channel estimation symbols and silent symbols, which are generated as defined in clauses 7.1.4.2.4.3 and 7.1.4.2.5 (tone mapping) and 7.1.4.4.3 (Tx port mapping).

7.1.4 Physical medium dependent (PMD) sublayer

The functional model of the PMD is presented in Figure 7-6. In the transmit direction, the tone mapper divides the incoming symbol frames (per each spatial stream) of the header and payload into groups of bits and associates each group of bits with a specific sub-carrier onto which this group shall be loaded, as specified in clause 7.1.4.2. The constellation encoder converts each incoming group of bits into a complex number that represents the constellation point for this sub-carrier. The constellation mapping process is described in clause 7.1.4.3.1. The unloaded supported sub-carriers are modulated by a pseudo-random bit sequence generated as described in clause 7.1.4.2.5.

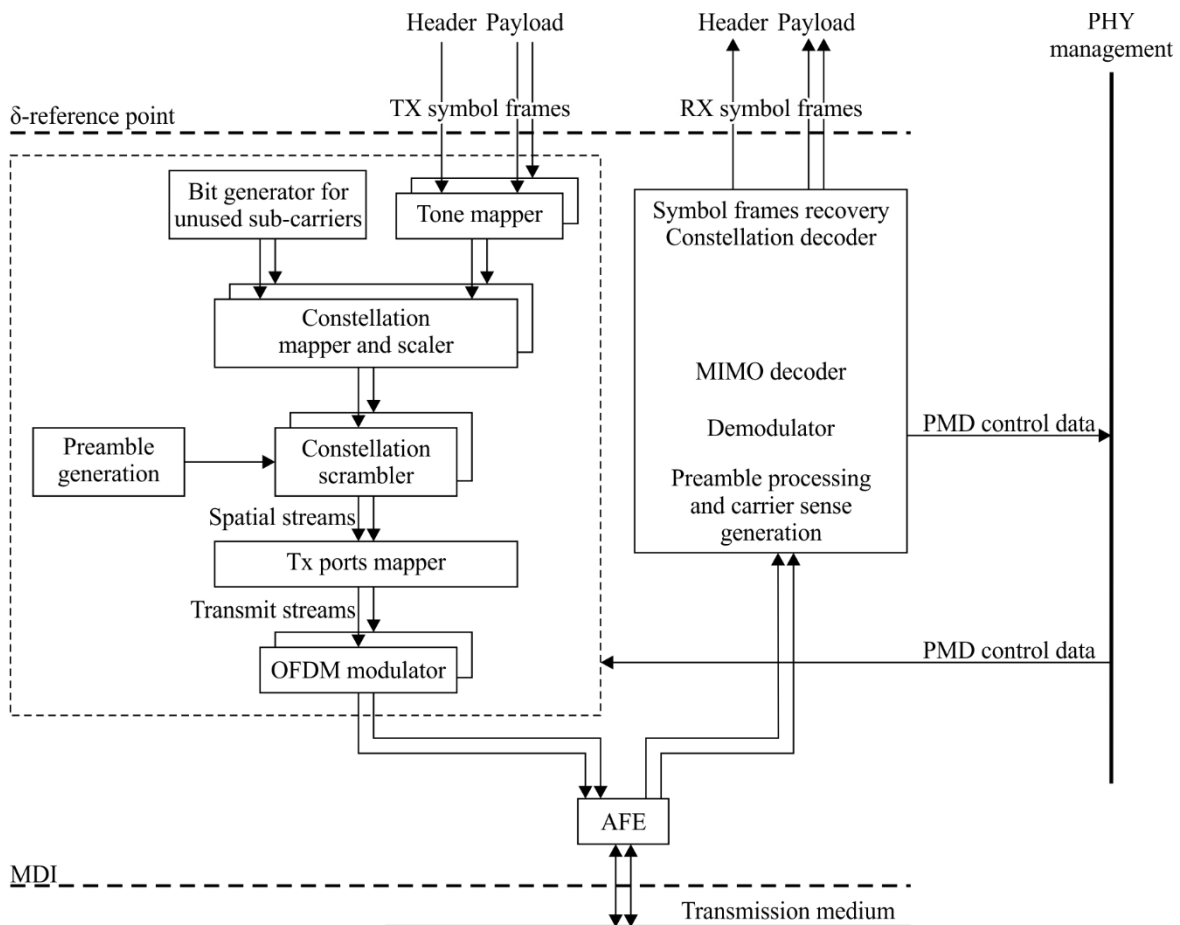

G.9963(15)-Amd.1(16)_F7-6

Figure 7-6 – Functional model of the PMD

The Tx port mapper, described in clause 7.1.4.4, maps the spatial streams, to transmit streams that are assigned for transmission in each of the Tx ports. Each of the OFDM modulators, described in clause 7.1.4.5, assigned to each Tx port, converts the stream of the N complex numbers at its input into the stream of N complex valued time-domain samples. After adding the preamble, the transmit signal of each Tx port is up-shifted by F_{US} . The real part of the resultant signal assigned to each Tx port is transmitted onto the medium over a specific Tx port. Parameters of the preamble (clause 7.1.4.5) are determined by the PHY management and depend on the type of the transmitted PHY frame.

Frames are output onto the medium with inter-frame gaps described in [ITU-T G.9961].

In the receive direction, the frames incoming from the medium are demodulated and decoded. The recovered symbol frames are transferred to the PMA via δ -reference point. The preamble is processed and preamble data are passed to the PHY management entity.

7.1.4.1 Sub-carrier spacing and logical indexing

See clause 7.1.4.1 of [ITU-T G.9960]. Indexing rule #1 shall be used to relate the physical index and logical index. Indexing rule #2 shall not be used.

7.1.4.2 Tone mapper

The tone mapper operates independently on each one of the incoming spatial streams. The tone mapper divides the incoming symbol frames of the header and payload (of each spatial stream) into groups of bits (according to the BATs and sub-carrier grouping being used for that spatial stream) and associates each group of bits with specific sub-carriers onto which these groups shall be loaded. This information, along with sub-carrier-specific gain scaling values (as described in clause 7.1.4.3.2.3 of [ITU-T G.9960]), is passed to the constellation encoder.

7.1.4.2.1 Summary of sub-carrier types

For the purpose of tone mapping, the following types of sub-carriers are defined.

- 1) Masked sub-carriers (MSC) are those on which transmission is not allowed, i.e., the gain on this sub-carrier shall be set to zero. Two types of MSC are defined:
 - Permanently masked sub-carriers (PMSC) – those that are never allowed for transmission. The list of PMSC forms a PMSC mask, which depends on the type of medium and is defined in clause 7.2. Data bits are never mapped on PMSC.
 - Regionally masked sub-carriers (RMSC) – those that are not allowed for data transmission in some regions, while may be allowed in other regions. The list of RMSC forms a RMSC mask, which depends on the type of media and on the region/application. The RMSC set consists of the sub-carriers corresponding to sub-carrier masks defined in SM descriptor and masked amateur radio bands defined in amateur radio band descriptor (see clause 8.8.5.5). The number of RMSC, $\#RMSC = \#MSC - \#PMSC$.
- 2) Supported sub-carriers (SSC) are those on which transmission is allowed under restrictions of the relevant PSD mask. The number of SSC, $\#SSC = N - \#MSC$. The following types of SSC are defined, per spatial stream:
 - Active sub-carriers (ASC) of spatial stream i (denoted $ASC^{(i)}$, where $i = 1,2$) – those that have loaded bits ($b \geq 1$) for data transmission. ASC are subject to constellation point mapping, constellation scaling and constellation scrambling as described in clause 7.1.4.3. Data bits shall be mapped on ASC as described in clause 7.1.4.2.2.
 - Inactive sub-carriers (ISC) of spatial stream i (denoted $ISC^{(i)}$, where $i = 1,2$) – those that do not have any data bits loaded (e.g., because SNR is low). The number of ISC of spatial stream i ($i = 1,2$), $\#ISC^{(i)} = \#SSC - \#ASC^{(i)}$. ISC can be used for measurement purposes

or other auxiliary purposes. ISC are subject to transmit power shaping. The signals transmitted on ISC are defined in clause 7.1.4.2.5.

NOTE – Even though the MSC and SSC are the same for both spatial streams, the ASC and ISC of different spatial streams may be different.

7.1.4.2.2 Bit allocation tables (BATs)

Tone mapping is defined by a bit allocation table (BAT) that associates sub-carrier indices with the number of bits to be loaded on the sub-carrier. This mapping is defined independently per each spatial stream. The order of sub-carrier indices in a BAT (per spatial stream) shall be in ascending order, from the smallest index to the largest index. Bits of the TX symbol frame shall be loaded on the sub-carriers in the order of indices in the BAT, according to sub-carrier indexing defined in clause 7.1.4.1.

The BATs used by the node in the particular PHY frame, for each spatial stream, are part of the BMAT (specified in clause 7.1.4.4.3) and shall be indicated to the receiving node(s) in the BMAT_ID field of the MSG/BMSG/BACK/PROBE PHY-frame type specific fields of the PHY-frame header, as described in clause 7.1.2.3.2.2.8.

7.1.4.2.2.1 Predefined BATs

See clause 7.1.4.2.2.1 of [ITU-T G.9960].

7.1.4.2.2.2 Runtime BATs

A runtime BAT associates indices of SSCs with the number of bits to be loaded on each sub-carrier. When the payload is composed of two spatial streams and runtime BATs are used, each spatial stream is associated with its own runtime BAT. The subset of indices in the BAT associated with spatial stream i with the number of loaded bits $b > 0$ identifies the ASC^(i) (i.e., active sub-carriers of spatial stream i). In a MIMO transmission, the two BATs are selected together with the Tx port mapping allocation table (MAT), described in clause 7.1.4.4.2. This combination is called the BMAT (bit and Tx port mapping allocation table) and is described in clause 7.1.4.4.3.

The number of bits loaded on any sub-carrier shall not exceed the maximum number of bits allowed (see clause 7.1.4.3). The number of bits shall also meet the bit loading capabilities of the communicating nodes, as advertised by them prior to communication.

7.1.4.2.3 BATs with sub-carrier grouping

A node shall be capable of defining runtime BATs using sub-carrier grouping of $G = 1$ (no grouping), 2, 4, 8 and 16 sub-carriers with subsequent frequencies. The grouping, G , applies to both spatial streams (i.e., both spatial streams use the same grouping). The default value of G is 1. If grouping is used ($G > 1$), all sub-carriers of the same group shall use the same bit loading. However, the bit loading for that group for different spatial streams may be different). The first group shall include G sub-carriers in ascending order of sub-carrier indices defined in clause 7.1.4.1. If a group includes sub-carriers that are masked (e.g., MSC) or extends beyond the applicable sub-carrier set, the node shall apply the bit loading assigned for this group only to the applicable sub-carrier set.

The group index G shall be indicated when BATs are communicated (see clause 8.11).

7.1.4.2.4 Special mappings

7.1.4.2.4.1 Tone mapping for PHY-frame header

See clause 7.1.4.2.5.1 of [ITU-T G.9960].

7.1.4.2.4.2 Tone mapping for RCM

See clause 7.1.4.2.5.2 of [ITU-T G.9960].

7.1.4.2.4.3 Tone mapping for probe symbols

The 1 SS channel estimation probe symbols shall be created as a single SS and modulated using a uniform loading of 2 bits per sub-carrier on the entire SSC set. For these symbols, the ISC set shall be equal to the SSC set. All ISC sub-carriers shall be modulated by a pseudo-random sequence of bits, as described in clause 7.1.4.2.5.

The 2 SS channel estimation probe symbols shall be created as two SSs and modulated using a uniform loading of 2 bits per sub-carrier on the entire SSC set of each SS. For these symbols, the ISC set shall be equal to the SSC set. All ISC sub-carriers shall be modulated by a pseudo-random sequence of bits, as described in clause 7.1.4.2.5

For silent symbols, all sub-carriers shall be considered as MSCs (masked sub-carriers).

7.1.4.2.4.4 Tone mapping for ACE symbols

The ACE symbol shall be modulated using a uniform loading of 2 bits per sub-carrier on the entire SSC set. ACE symbols shall be created as a single spatial stream. For the ACE, the ISC set shall be equal to the SSC set. All ISC sub-carriers shall be modulated by a pseudo-random sequence of bits, as described in clause 7.1.4.2.5.

7.1.4.2.5 Modulation of unloaded supported sub-carriers

Supported sub-carriers (SSC) that are not loaded with encoded payload bits or that are partially loaded with encoded payload bits for spatial stream i ($i = 1, 2$) – that is, $ISC^{(i)}$ and unloaded or partially loaded $ASC^{(i)}$ (herein referred to as unloaded SSCs of spatial stream i , $USSC^{(i)}$) – shall be loaded with a pseudo-random sequence defined by the linear feedback shift register (LFSR) generator with the polynomial $p(x) = x^{23} + x^{18} + 1$ shown in Figure 7-7. The LFSR shall operate on the sub-carriers of each spatial stream separately. In other words, the LFSR shall be initialized differently for each spatial stream as described hereafter and shall produce bits to load the sub-carriers of each spatial stream separately. The LFSR generator shall be initialized at the beginning of each OFDM symbol with a DM-generated seed received during registration of the node into the domain through the UnloadedSubcarrierInitialSeedStream1 and UnloadedSubcarrierInitialSeedStream2 fields of the additional MIMO domain information auxiliary information sub-field (see clause 8.8.7) for spatial streams 1 and 2, respectively. The i -th payload symbol shall use the seed S_k where k is equal to $(i - 1, \text{ modulo } 64) + 1$, where $i = 1, 2, 3, 4, \dots$. S_k is generated by advancing the LFSR by $8192 * (k - 1)$ from the original DM-generated seed. An example of LFSR seeds for an initial seed of $7FFFFFFF_{16}$ (stream 1) and $7FFFFFFC_{16}$ (spatial stream 2) is provided in Tables 7-14 and 7-15.

NOTE – Seeds S_1 to S_{64} are used to initialize the LFSR for payload symbols 1-64, 65-128 and so on. The LSB of the seed S_k corresponds to c_1 .

The DM-generated seeds shall be chosen among the pool of allowed seeds described in Tables 7-12 and 7-13, depending on the value of the domain identifier (DOD) of the domain and the spatial stream.

Table 7-12 – Pool of allowed DM-generated seeds for unloaded supported sub-carriers LFSR generator for spatial stream 1

DOD	Allowed seeds
0	7FFFFFFF ₁₆ ; 003FE0 ₁₆ ; 7FC060 ₁₆ ; 7803F9 ₁₆ ; 0FF813 ₁₆ ; 7EFE80 ₁₆ ; 01FCFC ₁₆ ; 40202F ₁₆ ; 038638 ₁₆
1	7FFFFFFF ₁₆ ; 7DC2E0 ₁₆ ; 70874D ₁₆ ; 401FB7 ₁₆ ; 61F327 ₁₆ ; 0F78B3 ₁₆ ; 3FD7D7 ₁₆ ; 0DC513 ₁₆ ; 1E73E7 ₁₆
2	7FFFFFFF ₁₆ ; 1EB138 ₁₆ ; 731F9B ₁₆ ; 057B41 ₁₆ ; 4DE53C ₁₆ ; 7099A3 ₁₆ ; 0080A6 ₁₆ ; 07BC5A ₁₆ ; 0399C8 ₁₆
3	7FFFFFFF ₁₆ ; 3027C4 ₁₆ ; 1F8F1B ₁₆ ; 30A762 ₁₆ ; 1D8A1F ₁₆ ; 6FB79B ₁₆ ; 6E3675 ₁₆ ; 78B9A1 ₁₆ ; 65F92E ₁₆
4	7FFFFFFF ₁₆ ; 5EED10 ₁₆ ; 7F3F09 ₁₆ ; 16E6B5 ₁₆ ; 5FD0FF ₁₆ ; 1EB13C ₁₆ ; 6B8DD5 ₁₆ ; 7795D2 ₁₆ ; 3D222E ₁₆
5	7FFFFFFF ₁₆ ; 0174B0 ₁₆ ; 79903D ₁₆ ; 604F7B ₁₆ ; 38638D ₁₆ ; 698A2D ₁₆ ; 7CE688 ₁₆ ; 50281F ₁₆ ; 48E4C4 ₁₆

Table 7-12 – Pool of allowed DM-generated seeds for unloaded supported sub-carriers LFSR generator for spatial stream 1

DOD	Allowed seeds
6	7FFFFFF ₁₆ ; 7ABE59 ₁₆ ; 785321 ₁₆ ; 26D2B1 ₁₆ ; 0207F8 ₁₆ ; 0B6CAA ₁₆ ; 306764 ₁₆ ; 096B52 ₁₆ ; 12757B ₁₆
7	7FFFFFF ₁₆ ; 734122 ₁₆ ; 1D29EE ₁₆ ; 4D67BC ₁₆ ; 073961 ₁₆ ; 763502 ₁₆ ; 7C58CE ₁₆ ; 7B4816 ₁₆ ; 5E6F90 ₁₆
8	7FFFFFF ₁₆ ; 0AFC72 ₁₆ ; 198299 ₁₆ ; 5AABBE ₁₆ ; 1E8EDC ₁₆ ; 618E01 ₁₆ ; 6E289F ₁₆ ; 5B22F8 ₁₆ ; 416B07 ₁₆
9	7FFFFFF ₁₆ ; 771574 ₁₆ ; 779791 ₁₆ ; 5D54B7 ₁₆ ; 479BCE ₁₆ ; 1EBBF8 ₁₆ ; 09EBF4 ₁₆ ; 6926AD ₁₆ ; 3B5461 ₁₆
10	7FFFFFF ₁₆ ; 06764F ₁₆ ; 2EC96F ₁₆ ; 3BFA45 ₁₆ ; 316B09 ₁₆ ; 6876D1 ₁₆ ; 7FEF7B ₁₆ ; 0ABF31 ₁₆ ; 600E3B ₁₆
11	7FFFFFF ₁₆ ; 5295BF ₁₆ ; 3C064C ₁₆ ; 48FB34 ₁₆ ; 272E4D ₁₆ ; 32203C ₁₆ ; 478CF6 ₁₆ ; 7330FC ₁₆ ; 098416 ₁₆
12	7FFFFFF ₁₆ ; 40E0C4 ₁₆ ; 6A49F1 ₁₆ ; 620823 ₁₆ ; 44153E ₁₆ ; 3BD438 ₁₆ ; 0878EA ₁₆ ; 57EB86 ₁₆ ; 3DA277 ₁₆
13	7FFFFFF ₁₆ ; 12CF23 ₁₆ ; 730171 ₁₆ ; 164544 ₁₆ ; 1AB7C9 ₁₆ ; 74191A ₁₆ ; 33A4AA ₁₆ ; 68843A ₁₆ ; 3CC639 ₁₆
14	7FFFFFF ₁₆ ; 1A6FB3 ₁₆ ; 068AF6 ₁₆ ; 79DC09 ₁₆ ; 2E8D44 ₁₆ ; 0733A1 ₁₆ ; 24E0D0 ₁₆ ; 3F4001 ₁₆ ; 1D56D2 ₁₆
15	7FFFFFF ₁₆ ; 68BC83 ₁₆ ; 612F91 ₁₆ ; 6E76A9 ₁₆ ; 51F4FC ₁₆ ; 2B2C4D ₁₆ ; 2C2B62 ₁₆ ; 05A54A ₁₆ ; 28476E ₁₆

Table 7-13 – Pool of allowed DM-generated seeds for unloaded supported sub-carriers LFSR generator for spatial stream 2

DOD	Allowed Seeds
0	7FFFFC ₁₆ ; 23AA37 ₁₆ ; 7DEB20 ₁₆ ; 0E7807 ₁₆ ; 422436 ₁₆ ; 300E1C ₁₆ ; 605098 ₁₆ ; 7FF53C ₁₆ ; 0862AD ₁₆ ;
1	7FFFFC ₁₆ ; 18BC69 ₁₆ ; 09ABAB ₁₆ ; 07F1C5 ₁₆ ; 09E865 ₁₆ ; 2DFE39 ₁₆ ; 718D3B ₁₆ ; 78861D ₁₆ ; 6F8AD8 ₁₆ ;
2	7FFFFC ₁₆ ; 575445 ₁₆ ; 02C263 ₁₆ ; 1A717B ₁₆ ; 40DCAB ₁₆ ; 48F445 ₁₆ ; 65B11B ₁₆ ; 4A639A ₁₆ ; 411C38 ₁₆ ;
3	7FFFFC ₁₆ ; 35F937 ₁₆ ; 718D5C ₁₆ ; 65F51E ₁₆ ; 361B92 ₁₆ ; 121AD0 ₁₆ ; 2D4A2F ₁₆ ; 1A4B85 ₁₆ ; 663275 ₁₆ ;
4	7FFFFC ₁₆ ; 2B63B6 ₁₆ ; 50C875 ₁₆ ; 57D522 ₁₆ ; 37E76E ₁₆ ; 22E7A0 ₁₆ ; 6BC6D9 ₁₆ ; 638DB4 ₁₆ ; 577E3A ₁₆ ;
5	7FFFFC ₁₆ ; 1E2A46 ₁₆ ; 28F7F3 ₁₆ ; 1597A0 ₁₆ ; 30FEA3 ₁₆ ; 7B6B6F ₁₆ ; 5C5971 ₁₆ ; 733A55 ₁₆ ; 676D31 ₁₆ ;
6	7FFFFC ₁₆ ; 5979CF ₁₆ ; 36D313 ₁₆ ; 47AD56 ₁₆ ; 5A00C9 ₁₆ ; 4636C2 ₁₆ ; 6D49B2 ₁₆ ; 4282E1 ₁₆ ; 1B35FF ₁₆ ;
7	7FFFFC ₁₆ ; 4DBB71 ₁₆ ; 21C06E ₁₆ ; 187B99 ₁₆ ; 3CE540 ₁₆ ; 49CED1 ₁₆ ; 43C4F6 ₁₆ ; 1CED71 ₁₆ ; 7CC353 ₁₆ ;
8	7FFFFC ₁₆ ; 56B9EE ₁₆ ; 6DC0FF ₁₆ ; 1143BD ₁₆ ; 6DA9B9 ₁₆ ; 3D1B0B ₁₆ ; 3C8027 ₁₆ ; 6878D1 ₁₆ ; 796EE2 ₁₆ ;
9	7FFFFC ₁₆ ; 5730B7 ₁₆ ; 07A508 ₁₆ ; 5C950A ₁₆ ; 5AC4D5 ₁₆ ; 332E0B ₁₆ ; 04B478 ₁₆ ; 068575 ₁₆ ; 276853 ₁₆ ;
10	7FFFFC ₁₆ ; 32BC04 ₁₆ ; 718EAA ₁₆ ; 2D7E9F ₁₆ ; 348B03 ₁₆ ; 7FFD87 ₁₆ ; 0CD6D5 ₁₆ ; 411EBB ₁₆ ; 3FD43A ₁₆ ;
11	7FFFFC ₁₆ ; 4225A7 ₁₆ ; 782501 ₁₆ ; 33C567 ₁₆ ; 337AC6 ₁₆ ; 07C3D0 ₁₆ ; 7615E2 ₁₆ ; 053D21 ₁₆ ; 1E0459 ₁₆ ;
12	7FFFFC ₁₆ ; 2C72B3 ₁₆ ; 161AE5 ₁₆ ; 495760 ₁₆ ; 11EE60 ₁₆ ; 5F4D85 ₁₆ ; 156B20 ₁₆ ; 42F91A ₁₆ ; 78D261 ₁₆ ;
13	7FFFFC ₁₆ ; 753D0D ₁₆ ; 2F8603 ₁₆ ; 29751B ₁₆ ; 29DE16 ₁₆ ; 26AC1C ₁₆ ; 3193F4 ₁₆ ; 1C5B5D ₁₆ ; 0D3447 ₁₆ ;
14	7FFFFC ₁₆ ; 34D324 ₁₆ ; 7586CA ₁₆ ; 6F43D9 ₁₆ ; 77FB03 ₁₆ ; 1170EA ₁₆ ; 5D9297 ₁₆ ; 249A77 ₁₆ ; 1A76ED ₁₆ ;
15	7FFFFC ₁₆ ; 127C77 ₁₆ ; 532AD6 ₁₆ ; 5ED02D ₁₆ ; 40C4AC ₁₆ ; 3CA7A7 ₁₆ ; 589E59 ₁₆ ; 41C05B ₁₆ ; 0881D6 ₁₆ ;

The first allowed value for each spatial stream is common for all DODs and is called the default seed for unloaded supported sub-carrier LFSR generators for that spatial stream. The tuple composed of the two default seeds is called the default value for MIMO unloaded supported sub-carrier LFSR generators.

The LFSR, for each spatial stream i , shall be advanced by two bits for each sub-carrier (for both SSC and MSC) of each symbol of the payload. The two LFSR bits corresponding to the sub-carrier index 0, of each spatial stream, are (c_1, c_2) of the initialization seed. The two LFSR bits corresponding to the sub-carrier index 1, of each spatial stream, are (c_1, c_2) after two shifts and so on. For modulation of unloaded sub-carriers, ACE symbols shall be treated in the same manner as payload symbols with

one difference compared to other payload symbols: ACE symbols are created as a single spatial stream, rather than two spatial streams. This means that only the LFSR operating on spatial stream 1 shall operate on the ACE symbols.

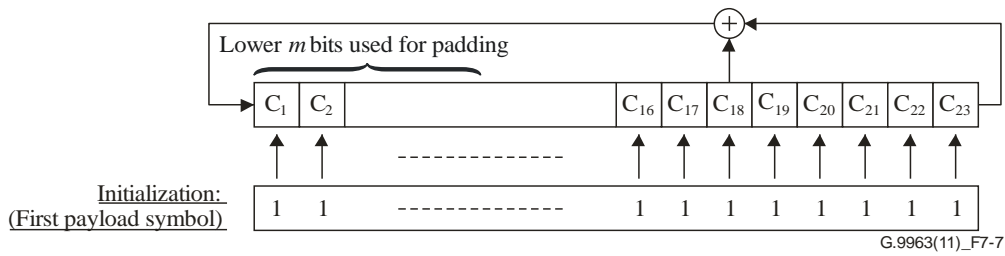

Figure 7-7 – LFSR for modulation of unloaded and partially loaded sub-carriers for each of the two spatial streams

Table 7-14 – Example LFSR seeds for an initial DM-generated seed of 7FFFFFF₁₆ for spatial stream 1

Seed index k	Seed (S_k)
1	7FFFFFF ₁₆
2	26B489 ₁₆
3	278A91 ₁₆
4	15F4ED ₁₆
5	5B4CB1 ₁₆
6	2F021F ₁₆
7	7A64C1 ₁₆
8	414CD7 ₁₆
9	649D5E ₁₆
10	134826 ₁₆
11	2A3DFC ₁₆
12	2B9570 ₁₆
13	3C6777 ₁₆
14	757986 ₁₆
15	103962 ₁₆
16	0DB87B ₁₆
17	076287 ₁₆
18	3E1A31 ₁₆
19	05DE6D ₁₆
20	5C5B4E ₁₆
21	596413 ₁₆
22	0613D9 ₁₆
23	19504A ₁₆
24	50FDE0 ₁₆
25	5CD048 ₁₆
26	66C646 ₁₆

Table 7-14 – Example LFSR seeds for an initial DM-generated seed of 7FFFFFF₁₆ for spatial stream 1

Seed index k	Seed (S_k)
27	7169B3 ₁₆
28	480497 ₁₆
29	053FE3 ₁₆
30	51F1B1 ₁₆
31	7D2BA0 ₁₆
32	11E4D8 ₁₆
33	037144 ₁₆
34	278587 ₁₆
35	2CF7F7 ₁₆
36	027D46 ₁₆
37	70A7EB ₁₆
38	4C622C ₁₆
39	54DC68 ₁₆
40	01715E ₁₆
41	274A7B ₁₆
42	55238D ₁₆
43	008B06 ₁₆
44	3FA255 ₁₆
45	777A6A ₁₆
46	5154DD ₁₆
47	55C203 ₁₆
48	0D21F9 ₁₆
49	1BEDE6 ₁₆
50	608D6B ₁₆
51	4B75D3 ₁₆
52	22BA64 ₁₆
53	7D0646 ₁₆
54	7F56E6 ₁₆
55	614333 ₁₆
56	4F1368 ₁₆
57	7359EF ₁₆
58	2D86A9 ₁₆
59	25373D ₁₆
60	258466 ₁₆
61	4CE92A ₁₆
62	6B7E3D ₁₆
63	760B34 ₁₆
64	761EA6 ₁₆

Table 7-15 – Example LFSR seeds for an initial DM-generated seed of 7FFFFC₁₆ for spatial stream 2

Seed index k	Seed (S _k)
1	7FFFFC ₁₆
2	1AD227 ₁₆
3	1E2A46 ₁₆
4	57D3B5 ₁₆
5	6D32C5 ₁₆
6	3C087E ₁₆
7	699305 ₁₆
8	05335F ₁₆
9	12757B ₁₆
10	4D209B ₁₆
11	28F7F3 ₁₆
12	2E55C2 ₁₆
13	719DDD ₁₆
14	55E61A ₁₆
15	40E588 ₁₆
16	36E1ED ₁₆
17	1D8A1F ₁₆
18	7868C7 ₁₆
19	1779B5 ₁₆
20	716D3A ₁₆
21	65904F ₁₆
22	184F66 ₁₆
23	654129 ₁₆
24	43F782 ₁₆
25	734122 ₁₆
26	1B1919 ₁₆
27	45A6CE ₁₆
28	20125E ₁₆
29	14FF8D ₁₆
30	47C6C7 ₁₆
31	74AE82 ₁₆
32	479361 ₁₆
33	0DC513 ₁₆
34	1E161E ₁₆
35	33DFDD ₁₆
36	09F51A ₁₆
37	429FAF ₁₆

Table 7-15 – Example LFSR seeds for an initial DM-generated seed of 7FFFFC₁₆ for spatial stream 2

Seed index k	Seed (S _k)
38	3188B2 ₁₆
39	5371A2 ₁₆
40	05C579 ₁₆
41	1D29EE ₁₆
42	548E37 ₁₆
43	022C18 ₁₆
44	7E8956 ₁₆
45	5DE9A8 ₁₆
46	455377 ₁₆
47	57080F ₁₆
48	3487E5 ₁₆
49	6FB79B ₁₆
50	0235AF ₁₆
51	2DD74D ₁₆
52	0AE993 ₁₆
53	74191A ₁₆
54	7D5B98 ₁₆
55	050CCE ₁₆
56	3C4DA1 ₁₆
57	4D67BC ₁₆
58	361AA4 ₁₆
59	14DCF4 ₁₆
60	161198 ₁₆
61	33A4AA ₁₆
62	2DF8F4 ₁₆
63	582CD1 ₁₆
64	587A99 ₁₆

For each spatial stream i , the modulation of sub-carriers that are not loaded with encoded payload bits shall be as follows:

- 1) Starting at the beginning of the first payload OFDM symbol, each sub-carrier from the ISC⁽ⁱ⁾ set (i.e., inactive sub-carriers of spatial stream i , $i = 1,2$) shall be modulated with two bits which are the LSBs of the LFSR, c_1 and c_2 using 2-bits constellation mapping defined in clause 7.1.4.3.1 (c_1 is transmitted first).
- 2) In every OFDM symbol of payload, if the number of bits of spatial stream i , in the symbol frame does not fill the entire symbol, the bits from the LFSR shall be used to fill the remainder of the symbol frame of that spatial stream i , by taking groups of $m^{(i)}$ LSBs of the LFSR (bits c_1 to $c_{m^{(i)}}$ of the LFSR, c_1 is transmitted first) and mapping them onto the remaining sub-carriers, where $m^{(i)}$ is the number of bits allocated for a sub-carrier of spatial stream i as defined by the BAT of this spatial stream. For the first padded sub-carrier of spatial stream i ,

if $n^{(i)}$ bits of the $m^{(i)}$ loaded bits are data bits ($n^{(i)} < m^{(i)}$), these $n^{(i)}$ data bits shall be loaded as the LSBs of the group of bits mapped on the constellation point and the $m^{(i)} - n^{(i)}$ bits of the LFSR (bits c_1 to $c_{m^{(i)}-n^{(i)}}$ of the LFSR, c_1 is transmitted first) shall be used as the MSBs of the group of bits mapped on the constellation point starting from LSB of LFSR.

- 3) In the case of either the 1 SS channel estimation probe symbols or the 2 SS channel estimation probe symbols, starting at the beginning of the first payload OFDM symbol, each sub-carrier from the ISC⁽ⁱ⁾ set (i.e., inactive sub-carriers of spatial stream i , $i = 1, 2$) shall be modulated with two bits, which are the LSBs of the LFSR, c_1 and c_2 , using 2-bit constellation mapping defined in clause 7.1.4.3.1 (c_1 is transmitted first).

For each spatial stream i , bits from the LFSR are loaded on sub-carriers in the order of logical indices (i.e., in the same way as data is loaded over payload symbols), according to sub-carrier indexing defined in clause 7.1.4.1. Modulation of unloaded sub-carriers shall start from the unloaded SSC of spatial stream i , USSC⁽ⁱ⁾, with the lowest logical index of the first payload symbol, continue in ascending order of logical indices till the unloaded SSC of spatial stream i , USSC⁽ⁱ⁾, with the highest logical index of the first payload symbol, continue with the unloaded SSC of spatial stream i , USSC⁽ⁱ⁾, with the lowest logical index of the second payload symbol, continue in ascending order of logical indices till the unloaded SSC of spatial stream i , USSC⁽ⁱ⁾, with the highest logical index of the second payload symbol and continue till the unloaded SSC of spatial stream i , USSC⁽ⁱ⁾, with the highest logical index of the last payload symbol.

The ASCs of each spatial stream i , ASC⁽ⁱ⁾, from the SSC set are loaded according to the corresponding BAT of spatial stream i as defined in clause 7.1.4.2.2.

7.1.4.3 Constellation encoder

7.1.4.3.1 Constellation mapping

Constellation mapping is performed independently on each spatial stream. Constellation mapping associates every group of bits loaded onto a sub-carrier of a specific spatial stream, with the values of I (in-phase component) and Q (quadrature-phase component) of a constellation diagram. Each incoming group of b bits $\{d_{b-1}, d_{b-2}, \dots, d_0\}$ shall be associated with a specific value of I and Q computed as described in this section.

Each group of bits $\{d_{b-1}, d_{b-2}, \dots, d_0\}$ shall be mapped onto the constellation mapper with the LSB bit, d_0 , first.

7.1.4.3.1.1 Constellations for even number of bits

See clause 7.1.4.3.1.1 of [ITU-T G.9960].

7.1.4.3.1.2 Constellations for odd number of bits

See clause 7.1.4.3.1.2 of [ITU-T G.9960].

7.1.4.3.2 Constellation point scaling

See clause 7.1.4.3.2 of [ITU-T G.9960].

7.1.4.3.3 Constellation scrambler

The phase of constellation points generated by the constellation mapper shall be shifted in accordance with the pseudo-random sequence generated by a linear feedback shift register (LFSR) generator, as shown in Figure 7-8.

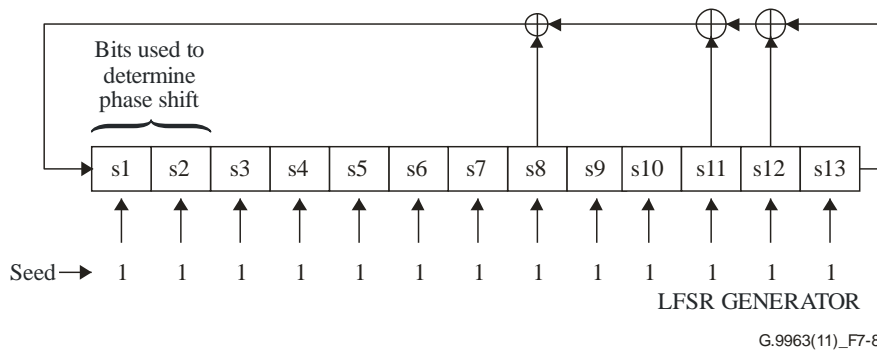

Figure 7-8 – Constellation scrambler

The LFSR generator shall implement the polynomial $g(x) = x^{13} + x^{12} + x^{11} + x^8 + 1$.

The LFSR shall be advanced by 2 bits for each sub-carrier. For the header, ACE and payload, bits shall be assigned to sub-carriers of spatial streams in the following order:

- Starting from the sub-carrier with the lowest logical index, the following shall be performed:
 - The two LSBs, s1 and s2, of the register shall be taken to determine the phase shift applied to the constellation point of spatial stream 1 associated with this sub-carrier, according to Table 7-16.
 - If the symbol comprises two spatial streams, the same two bits, s1 and s2, shall be used to determine the phase shift applied to the constellation point of spatial stream 2 associated with this sub-carrier, according to Table 7-16; otherwise this step shall be skipped.
 - The LFSR shall then be advanced by two bits.
- Continue to the next sub-carrier in order of logical index (see clause 7.1.4.1). For this sub-carrier the same operations described in the previous bullet shall be performed.
- Continue till the sub-carrier with the highest logical index. Again, for this sub-carrier the same operations described in the previous bullet shall be performed.

Table 7-16 – Constellation phase shift versus LFSR output

LFSR output		Phase shift (rad)
s2	s1	
0	0	0
0	1	$\pi/2$
1	0	π
1	1	$3\pi/2$

For header, ACE and payload, the shift of the LFSR for sub-carrier index i shall be $2i$ (for both SSC and MSC). Two LFSR bits corresponding to the sub-carrier index 0 are (s_1, s_2) of the initialization seed. Two LFSR bits corresponding to the sub-carrier index 1 are (s_1, s_2) after two shifts and so on.

For preamble, INUSE, PR, NACK and IDPS signals, the shift of the LFSR for sub-carrier index $(i \times k_m)$ shall be $2i$ where k_m denotes the sub-carrier spacing multiplier for preamble section m (see clause 7.1.4.6.3).

The LFSR generator shall be initialized with the seed 1FFF₁₆ for each OFDM symbol. The LSB of the seed corresponds to s_1 . The constellation scrambling shall be applied to the PHY-frame header, ACE and all payload symbols by rotating the originally mapped constellation point $Z_{i,l}^0$ by the phase shift θ to obtain the complex value for the $Z_{i,l}$ for input to the IDFT (see clause 7.1.4.5.1).

$$Z_{i,l} = Z_{i,l}^0 \cdot \exp(j\theta).$$

7.1.4.4 Tx port mapper

The Tx port mapper inputs are the spatial streams at the outputs of the constellation encoder. The outputs are the transmit streams which are transformed to time-domain samples by the OFDM modulator and connected to Tx ports. The Tx port mapper operates on a per sub-carrier basis. It maps pairs of constellation points assigned to the two spatial streams on the same sub-carrier, to modified pair of signals which are connected (after OFDM modulation, i.e., IDFT) to Tx ports, according to a Tx port mapping allocation table (MAT). The operation of the Tx port mapper is described hereafter.

Let us denote:

$S_{in,i}^{(j)}$ – the input signal point, associated with sub-carrier i ($i = 0, \dots, N - 1$), of spatial stream j ($j = 1, 2$)

$S_{out,i}^{(k)}$ – the output signal point, associated with sub-carrier i ($i = 0, \dots, N - 1$), of transmit stream k ($k = 1, 2$)

In cases where only a single spatial stream is used, $S_{in,i}^{(2)} = 0$.

The "Tx port mapping matrix" for sub-carrier i is denoted:

$$TPM_i = \begin{bmatrix} TPM_{11,i} & TPM_{12,i} \\ TPM_{21,i} & TPM_{22,i} \end{bmatrix}, i = 0, \dots, N - 1,$$

where $TPM_{kj,i}$ denotes the mapping from spatial stream j to transmit stream k for sub-carrier i .

The Tx port mapping operation, per sub-carrier i , shall be performed according to the following:

$$\begin{bmatrix} S_{out,i}^{(1)} \\ S_{out,i}^{(2)} \end{bmatrix} = \begin{bmatrix} TPM_{11,i} & TPM_{12,i} \\ TPM_{21,i} & TPM_{22,i} \end{bmatrix} \cdot \begin{bmatrix} S_{in,i}^{(1)} \\ S_{in,i}^{(2)} \end{bmatrix}, i = 0, \dots, N - 1$$

The specific mapping is described by specific mapping matrices, defined in clause 7.1.4.4.1 and the MAT, as defined in clause 7.1.4.4.2.

Mapping of Tx port (i.e., transmit stream) to an actual combination of conductors (e.g., In the powerline case, Tx port 1 connects to P-N terminal) is vendor discretionary. However, this mapping shall not change once a node is registered to a domain.

7.1.4.4.1 Specific Tx port mapping matrices

7.1.4.4.1.1 The "direct" mapping, TPM #0

The matrix for the "direct" Tx port mapping for two spatial streams shall be the identity matrix:

$$TPM \#0 = \frac{1}{\sqrt{2}} \begin{bmatrix} 1 & 0 \\ 0 & 1 \end{bmatrix}$$

7.1.4.4.1.2 The "duplication" mapping, TPM #1

The matrix for the "duplication" Tx port mapping for a single spatial stream shall be:

$$TPM \#1 = \frac{1}{\sqrt{2}} \begin{bmatrix} 1 & 0 \\ 1 & 0 \end{bmatrix}$$

7.1.4.4.1.3 The "duplicate and negate" mapping, TPM #2

The matrix for the "duplicate and negate" Tx port mapping for a single spatial stream shall be:

$$TPM \#2 = \frac{1}{\sqrt{2}} \begin{bmatrix} 1 & 0 \\ -1 & 0 \end{bmatrix}$$

7.1.4.4.1.4 The "Tx port 1" mapping, TPM #3

The matrix for the "Tx port 1" Tx port mapping for two spatial streams shall be:

$$TPM \#3 = \begin{bmatrix} 1 & 0 \\ 0 & 0 \end{bmatrix}$$

7.1.4.4.1.5 The "Tx port 2" mapping, TPM #4

The matrix for the "Tx port 2" Tx port mapping for two spatial streams shall be:

$$TPM \#4 = \begin{bmatrix} 0 & 0 \\ 0 & 1 \end{bmatrix}$$

7.1.4.4.1.6 The "precoding" mapping, TPM #5

The matrix for the "precoding" Tx port mapping for two spatial streams is defined by the angles θ and φ , $0 \leq \theta \leq \pi/2$; $0 \leq \varphi < 2\pi$. This matrix shall be:

$$TPM \#5 = \frac{1}{\sqrt{2}} \begin{bmatrix} e^{j\varphi} \cos \theta & -e^{j\varphi} \sin \theta \\ \sin \theta & \cos \theta \end{bmatrix}; \quad 0 \leq \theta \leq \frac{\pi}{2}; \quad 0 \leq \varphi < 2\pi$$

The angles θ and φ are quantized to B_1 and B_2 bits, respectively. These values are either $B_1 = B_2 = 4$ bit or $B_1 = B_2 = 8$ bit, as described in clauses 8.11.1.7.3 and 8.11.1.7.5. The communication of the angle indices is described in clause 8.11. Given phase indices P_1 and P_2 for θ and φ , respectively, $0 \leq P_1 \leq 2^{B_1} - 1$; $0 \leq P_2 \leq 2^{B_2} - 1$, for some sub-carrier, the transmitter shall use the Tx port mapping TPM#5, in which:

$$\theta = \frac{\pi \cdot (2P_1 + 1)}{2^{B_1+2}} \quad \text{and} \quad \varphi = \frac{\pi \cdot (2P_2 + 1)}{2^{B_2}}$$

NOTE – The transmitter EVM requirements need to be taken into account when regenerating the precoding mapping matrix in the transmitter.

7.1.4.4.1.7 The "precoding without SS 2 input" mapping, TPM #6

The matrix for the "precoding without SS 2 input" Tx port mapping for two spatial streams is defined by the angles θ and φ , $0 \leq \theta \leq \pi/2$; $0 \leq \varphi < 2\pi$. This matrix shall be:

$$TPM \#6 = \begin{bmatrix} e^{j\varphi} \cos \theta & 0 \\ \sin \theta & 0 \end{bmatrix}; \quad 0 \leq \theta \leq \frac{\pi}{2}; \quad 0 \leq \varphi < 2\pi$$

The quantization of the angles θ and φ is described in clause 7.1.4.4.1.6.

7.1.4.4.1.8 The "precoding without SS 1 input" mapping, TPM #7

The Tx port mapping matrix for use with precoding with spatial stream 2 transmission is defined by the angles θ and φ , $0 \leq \theta \leq \pi/2$; $0 \leq \varphi < 2\pi$. This matrix shall be:

$$TPM \#7 = \begin{bmatrix} 0 & -e^{j\varphi} \sin \theta \\ 0 & \cos \theta \end{bmatrix}; \quad 0 \leq \theta \leq \frac{\pi}{2}; \quad 0 \leq \varphi < 2\pi$$

The quantization of the angles θ and φ is described in clause 7.1.4.4.1.6.

7.1.4.4.2 Tx port mapping allocation table (MAT)

Tx port mapping is defined by a Tx port mapping allocation table (MAT) that associates sub-carrier indices with specific Tx port mapping matrices applied to those sub-carriers. The order of sub-carrier indices in a MAT shall be in ascending order, from the smallest index to the largest index, according to sub-carrier indexing defined in clause 7.1.4.1 (same as in the BATs).

The MAT used by the node in a particular PHY frame is part of the BMAT (specified in clause 7.1.4.4.3) and shall be indicated to the receiving node(s) in the BMAT_ID field of the MSG/BMSG/BACK/PROBE PHY-frame type specific fields of the PHY-frame header, as described in clause 7.1.2.3.2.2.8.

The MAT shall only be used for mapping two spatial streams and only with Tx port mapping matrices TPM#0, TPM#3, TPM#4, TPM#5, TPM#6 and TPM#7. Tx port mapping matrices TPM#1 and TPM#2 are defined for specifying port mapping for transmissions using a single spatial stream. In this case, the same Tx port mapping matrix applies to all sub-carriers.

7.1.4.4.2.1 Predefined MATs

The following predefined MATs are defined:

- 1) Predefined MAT Type 0: Uniform Tx port mapping using the "Tx port 1" mapping matrix (TPM#3), defined in clause 7.1.4.4.1.4 on the sub-carriers set used by the corresponding BATs of the two spatial streams (i.e., on all sub-carriers except for either the PMSC set or the PMSC and RMSC sets).
- 2) Predefined MAT Type 1: Uniform Tx port mapping using the "Tx port 2" mapping matrix (TPM#4), defined in clause 7.1.4.4.1.5 on the sub-carriers set used by the corresponding BATs of the two spatial streams (i.e., on all sub-carriers except for either the PMSC set or the PMSC and RMSC sets).
- 3) Predefined MAT Type 2: Uniform Tx port mapping using the direct mapping matrix (TPM#0), defined in clause 7.1.4.4.1.1 on the sub-carriers set used by the corresponding BATs of the two spatial streams (i.e., on all sub-carriers except for either the PMSC set or the PMSC and RMSC sets).

Every node shall support predefined MATs of Type 0, 1 and 2.

7.1.4.4.2.2 Runtime MATs

A runtime MAT associates indices of SSCs with the Tx port mapping associated with each sub-carrier. In a MIMO transmission, the MAT is selected together with the two BATs. This combined allocation is called the BMAT (bit and Tx port mapping allocation table) and is described in clause 7.1.4.4.3.

7.1.4.4.2.3 MAT with sub-carrier precoding grouping

Whenever MIMO mode 1 or 2 is used (see clause 8.11), the receiver may use sub-carrier precoding grouping of $PG = 1$ (no grouping), 2, 4, 8 and 16 sub-carriers with subsequent frequencies for communicating the quantized precoding parameters (angles) to the transmitter. If precoding grouping is used ($PG > 1$), all sub-carriers of the same group (the number of sub-carriers in a group is PG) shall use the same precoding parameters (angles). The first group shall include PG sub-carriers in ascending order of sub-carrier indices defined in clause 7.1.4.1. If a group includes sub-carriers that are masked (e.g., MSC) or extends beyond the applicable sub-carrier set, the node shall apply the precoding parameters (angles) assigned for this group only to the applicable sub-carrier set. The default value is $PG = 1$.

The precoding grouping (PG) can be negotiated during channel estimation initiation using the MCE_Initiation.req and MCE_Initiation.cnf messages, as specified in clause 8.11.1.1.1. In addition

to these messages, *PG* shall also be indicated in the MCE_ParamUpdate.req message, when the BMAT is communicated (if this BMAT contains the precoding parameters), as described in clause 8.11.1.

7.1.4.4.3 Bit and Tx port mapping allocation tables (BMAT)

The BMAT is the combination of the following elements:

- The bit allocation tables (BATs) for the payload of the PHY frame (see clause 7.1.4.2.2):
 - The BAT of spatial stream 1, BAT⁽¹⁾.
 - The BAT of spatial stream 2, BAT⁽²⁾.
- The Tx port mapping allocation table (MAT) for the payload of the PHY frame (specified in clause 7.1.4.4.2).

The BMAT used by the node in a particular PHY frame shall be indicated to the receiving node(s) in the BMAT_ID field of the MSG/BMSG/BACK/PROBE PHY-frame type specific fields of the PHY-frame header, as described in clause 7.1.2.3.2.2.8.

7.1.4.4.3.1 Predefined and runtime BMATs

Table 7-3 describes the various combinations of the two BATs and MAT composing the BMAT. The BMAT is composed of predefined allocations (BMAT_IDs values in the range 0 to 11) and of runtime allocations (BMAT_IDs values in the range 16 to 27).

Runtime BMATs can be defined by the receiving node (receiver-defined BMAT) for a specific unicast channel or selected by the transmitting node (transmitter-determined BMAT) for a specific multicast channel. Runtime BMATs shall be communicated from the node that generates the BMAT to the peer (e.g., a node sourcing multicast transmission to several other nodes will communicate the BMAT to all receiving nodes prior to sending data) (see clause 8.11 and clause 8.16).

Runtime BMATs shall be created such that the coding of the two BATs composing this BMAT conveys the Tx port mapping information as well as bit-loading information for each sub-carrier. Values either in the range 0 to 12 or a special value of 15 shall be assigned per sub-carrier for each spatial stream as per the following rules (see also Table 8-27):

- For cases in which, for a specific sub-carrier, either a single Tx port mapping (i.e., *TPM#3* or *TPM#4*) or a precoding with single spatial stream mapping (i.e., *TPM#6* or *TPM#7*) is to be assigned, the value of 15 is assigned to the spatial stream that is not mapped to a Tx port. This stream is allocated with zero bit loading and is not loaded by pseudo-randomly LFSR-generated bits (although the LFSR is advanced for this stream and sub-carrier). The other spatial stream shall be assigned a value in the range 0 to 12. The value 0 indicates that bits are taken from the LFSR (the LFSR used to load "unloaded sub-carriers", see clause 7.1.4.2.5) and loaded onto this spatial stream.
- For cases in which, for a specific sub-carrier, mappings of two spatial streams to two Tx ports (i.e., *TPM#0* or *TPM#5*) is to be assigned, the values in the range 0 to 12 are assigned to the two spatial streams. The value 0 indicates that bits are taken from the LFSR used to load "unloaded sub-carriers" (see clause 7.1.4.2.5) and loaded onto the specific spatial stream and sub-carrier. Other values in the range 1 to 12 indicate the number of bits loaded on the sub-carrier.

7.1.4.4.3.2 Transmitter-determined and receiver-determined BMATs

Two types of mapping are defined: transmitter-determined and receiver-determined. With transmitter-determined mapping, the BMAT is defined by the transmitter and shall be either a predefined BMAT or it shall be communicated to all destination nodes prior to transmission using the channel estimation protocol for unicast transmission (see clause 8.11) and in addition using the multicast binding protocol for multicast transmission (see clause 8.16). With receiver-determined

mapping, the BMAT is defined by the receiver of the destination node and communicated to the transmitter using the channel estimation protocol.

For unicast transmission, the node shall use either one of the predefined BMATs or a runtime BMAT determined by the receiver.

PHY multicast transmissions from an ITU-T G.9963 node may use either of the following two transmission schemes (as specified in clause 8.16):

- ITU-T G.9960 transmission.
- MIMO transmission with the payload created as a single SS.

For multicast transmission using either of these schemes, only BATs are defined (and not BMATs). Both predefined BATs (transmitter determined) and runtime BATs can be used. If a runtime BAT is used, it shall be defined by the node sourcing the multicast (transmitter-determined); this node shall generate the BAT and communicate it to all multicast destinations (see clause 8.16).

Both transmitter-determined and receiver-determined BMATs may be defined, that are valid for only specific portions of the MAC cycle. The portion of the MAC cycle for which a specific BMAT is valid for is called a BMAT region. In the case of receiver-determined BMATs the applicable BMAT region(s) including the starting point and ending point of each of the BMAT regions with respect to the MAC cycle are conveyed to the transmitter as a part of the channel estimation protocol.

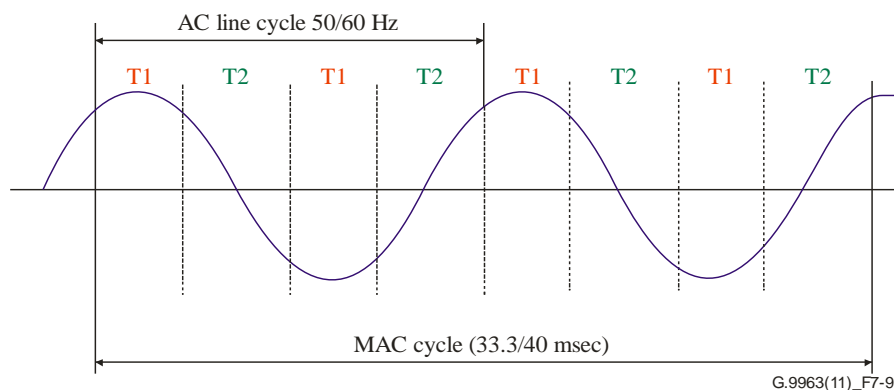

Figure 7-9 – An example of BMAT regions in a MAC cycle for a power line

Figure 7-9 illustrates multiple BMAT regions for a power line. In this example, the BMAT regions are periodic about half an AC line cycle and it has two BMATs. BMAT T1 is used around the peaks of the AC line cycle and BMAT T2 is used around the zero crossings of the AC line cycle. The receiver shall inform the transmitter about the starting point and the ending point of each of the BMAT regions with respect to the MAC cycle as a part of the channel estimation protocol.

A node shall support both transmitter-determined and receiver-determined types of mapping.

7.1.4.4.4 Specific Tx port mappings of PHY-frame elements

7.1.4.4.4.1 Tx port mapping of the PHY-frame header

When an ITU-T G.9963 node uses MIMO transmission, the Tx port mapping of all header symbols shall be done using the "duplication" mapping matrix (i.e., *TPM#1*), defined in clause 7.1.4.4.1.2, on all sub-carriers except the PMSC set.

7.1.4.4.4.2 Tx port mapping of ACE symbols

When an ITU-T G.9963 node uses MIMO transmission, the Tx port mapping of ACE symbols shall be done in the following way:

- For the case where the transmission includes payload intended for an ITU-T G.9963 node and this payload is created as two spatial streams (i.e., MIMO_IND = 1, case "4a" in Table 7-1):
 - The odd numbered ACE symbols shall use the "duplicate and negate" mapping matrix (i.e., $TPM\#2$), defined in clause 7.1.4.4.1.3, on the entire SSC set.
 - The even numbered ACE symbols shall use the "duplication" mapping matrix (i.e., $TPM\#1$), defined in clause 7.1.4.4.1.2, on the entire SSC set.
 For this case, one ACE symbol following the header shall be mandatory, additional ACE symbols are optional.
- For all other cases where the transmission includes payload (i.e., MIMO_IND = 0, cases "4b", "5" and "6" in Table 7-1):
 - The ACE symbols shall use the "duplication" mapping matrix (i.e., $TPM\#1$), defined in clause 7.1.4.4.1.2, on the entire SSC set.

For these cases, all ACE symbols are optional.

7.1.4.4.3 Tx port mapping of probe symbols

The Tx port mapping of the 1 SS channel estimation probe symbols shall be done using the "duplication" mapping matrix (i.e., $TPM\#1$), defined in clause 7.1.4.4.1.2, on the entire SSC set.

The Tx port mapping of the 2 SS channel estimation probe symbols shall be done using the MAT corresponding to the BMAT_ID indicated in the field PRB_BMAT_ID of the PROBE frame.

7.1.4.4.4 Mappings of payload symbols for RCM

When an ITU-T G.9963 node uses MIMO transmission in RCM, the Tx port mapping for the payload shall be done using the "duplication" mapping matrix (i.e., $TPM\#1$), defined in clause 7.1.4.4.1.2, on all of the payload sub-carriers.

7.1.4.5 OFDM modulator

A MIMO transceiver comprises two OFDM modulators, one for each one of the two Tx ports. An OFDM modulator of an individual Tx port consists of the following major parts: IDFT, cyclic shift, cyclic extension, windowing, overlap and add and frequency up-shift. The incoming signal to the modulator of the q -th Tx port at the l -th OFDM symbol in the present frame for a single sub-carrier, with index i , is the complex value $Z_{i,l}^{(q)}$ generated by the Tx port mapper as described in clause 7.1.4.4 (for symbols of the header and the payload) or by the preamble generator as described in clause 7.1.4.6.3 (for symbols of the preamble).

Time-domain samples generated by the IDFT ($y_{n,l}^{(q)}$) are input to the cyclic shift. The output of the cyclic shift ($x_{n,l}^{(q)}$) is input to the cyclic prefix. The output of the cyclic prefix ($v_{n,l}^{(q)}$) is input to the windowing, overlap and add. The output of the windowing, overlap and add ($u_n^{(q)}$) is then frequency up-shifted by F_{US} to generate $s_n^{(q)}$. The functional diagram of the OFDM modulator is presented in Figure 7-10.

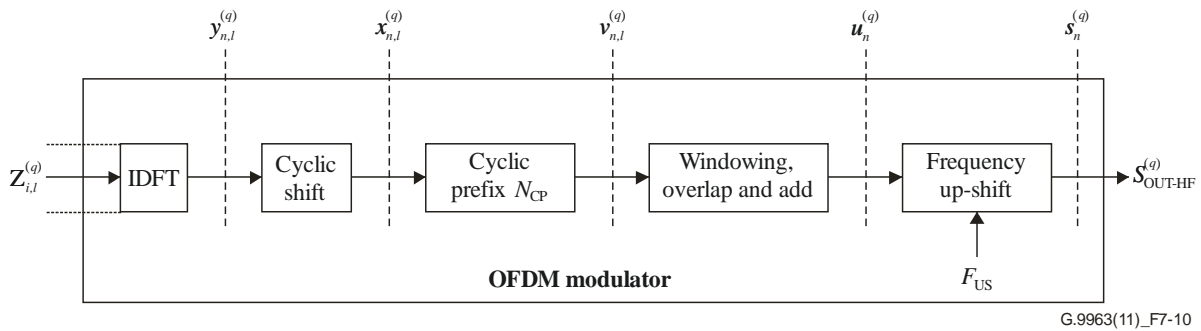

Figure 7-10 – Functional model of the OFDM modulator

The functional diagram presented above and other figures presented in this section do not imply any specific implementation. All aspects of signal processing used in the modulator shall comply with equations and textual descriptions.

7.1.4.5.1 IDFT

The IDFT converts the stream of the N complex numbers $Z_{i,l}^{(q)}$ at its input into the stream of N complex time-domain samples $y_{n,l}^{(q)}$. The input numbers represent the N mapped blocks of data, where the i -th block of data represents the complex value $Z_{i,l}^{(q)}$ of the i -th modulated sub-carrier of the OFDM signal, where $i = 0, 1, \dots, N-1$ is the sub-carrier index, l is the sequential number of the OFDM symbol within the current frame, excluding the preamble and $q = 1$ or 2 is the Tx port index. The conversion shall be performed in accordance with the equation:

$$y_{n,l}^{(q)} = \sum_{i=0}^{N-1} \exp\left(j \cdot 2\pi \cdot i \frac{n}{N}\right) \cdot Z_{i,l}^{(q)} \quad \text{for } n = 0 \text{ to } N-1, \quad l = 0 \text{ to } M_F - 1, \quad q = 1, 2$$

where M_F denotes the total number of OFDM symbols in the current frame excluding the preamble symbols and the value of N represents the maximum number of possibly modulated sub-carriers in the OFDM spectrum and shall be a power of 2: $N = 2^k$, where k shall be an integer. The value of $Z_{i,l}^{(q)}$ for all masked sub-carriers shall be set to 0. If some non-masked sub-carriers with indices $i < N$ are not loaded with data bits, the corresponding values of $Z_{i,l}^{(q)}$ shall be generated as described in clause 7.1.4.2.5.

7.1.4.5.2 Cyclic shift

The cyclic shift cyclically shifts the samples of an OFDM symbol at the output of the IDFT, $y_{n,l}^{(q)}$, to generate a shifted-version of this sequence, $x_{n,l}^{(q)}$. This shift depends on both the Tx port index and symbol type (preamble, PHY frame header, ACE and payload). This operation is defined by the following equation:

$$x_{n,l}^{(q)} = y_{(n - CS_l^{(q)}) \bmod N, l}^{(q)} = \sum_{i=0}^{N-1} Z_{i,l}^{(q)} \times \exp\left(j \cdot 2\pi \cdot i \frac{n - CS_l^{(q)}}{N}\right), \quad \text{for } n = 0, 1, \dots, N-1 \text{ and } q = 1, 2.$$

where $CS_l^{(q)}$ is the cyclic shift for power lines used for the l -th OFDM symbol of the q -th Tx port. The values of the cyclic shift for the two Tx ports and the different OFDM symbols are listed in Table 7-17.

Table 7-17 – Cyclic shift values for power lines (OFB Profile 1)

Symbol type	Number of sub-carriers–(<i>N</i>)			Cyclic shift for Tx Port 1 (<i>q</i> = 1) [samples]	Cyclic shift for Tx Port 2 (<i>q</i> = 2) [samples]
	25 MHz	50 MHz	100 MHz		
Preamble	128	256	512	0	<i>N</i> /8
INUSE, PR, NACK and IDPS signals	128	256	512	0	<i>N</i> /8
Header	1024	2048	4096	0	<i>N</i> /64
ACE symbol	1024	2048	4096	0	<i>N</i> /64
Payload	1024	2048	4096	0	<i>N</i> /64

In the phoneline cable case, a cyclic shift shall not be applied to either Tx port.

NOTE – The cyclic shift is not needed in phoneline cables since the crosstalk between the two pairs is low compared to the direct signal.

The use of MIMO for OFB Profile 2 is for further study.

7.1.4.5.3 Cyclic extension

The cyclic extension provides a guard interval between adjacent OFDM symbols. This guard interval is intended to protect against inter-symbol interference (ISI). Symbols at Tx port #1 and Tx port #2 with the same number (as defined in clause 7.1.4.5.1) use the same GI value.

In OFDM, the cyclic prefix of the *l*-th OFDM symbol in the frame shall be implemented by pre-pending the last $N_{CP}(l)$ samples of the IDFT output to its output *N* samples to create a pre-overlapped OFDM symbol, as presented in Figure 7-11. The order of samples in the symbol shall be as follows:

- The first sample of the symbol is the cyclic shift output sample $N - N_{CP}(l)$;
- The last sample of the cyclic prefix is the cyclic shift output sample $N - 1$; the next sample is the cyclic shift output sample 0.

The *l*-th pre-overlapped OFDM symbol consists of *N* IDFT samples and $N_{CP}(l)$ cyclic extension, samples, in total:

$$N_w(l) = N + N_{CP}(l) \text{ [samples].}$$

After cyclic extension as described above, time-domain samples at the reference point $v_{n,l}^{(q)}$ in Figure 7-23 shall comply with the following equations:

$$v_{n,l}^{(q)} = x_{n-N_{CP}(l),l}^{(q)} = \sum_{i=0}^{N-1} Z_{i,l}^{(q)} \times \exp\left(j \cdot 2\pi \cdot i \frac{n - CS_l^{(q)} - N_{CP}(l)}{N}\right). \quad \text{for } n = 0 \text{ to } N_w(l) - 1 = N + N_{CP}(l) - 1$$

The number of IDFT samples, *N* and the number of windowed samples, β , shall be the same for all symbols of the same frame. The value of $N_{CP}(l)$ (and the duration of the pre-overlapped OFDM symbol $N_w(l)$, accordingly) may change during the course of the frame, as follows:

- All symbols of the header shall have the value of $N_{GI-HD} + \beta$ defined in clause 7.1.4.7;
- The first two symbols following the header shall have the default value $N_{GI-DF} + \beta$, defined in clause 7.1.4.7;
- All the rest of the payload symbols shall have the same value $N_{GI} + \beta$, where N_{GI} is selected from the valid values defined in clause 7.1.4.7 and indicated in the header, as described in clause 7.1.2.1.

7.1.4.5.4 Symbol timing

The PHY frame consists of a preamble followed by an integer number, M_F , of OFDM symbols. The first symbol following the preamble (the first symbol of the PHY-header) shall have symbol count 0 and the last symbol of the frame shall have symbol count $M_F - 1$. The time position of each symbol in the frame is defined by sample count. The first sample of the symbol with symbol count 0 shall have sample count $M(0) = N_{pr} - \beta$, where N_{pr} is the number of samples in the preamble. The count of the first sample of the l -th symbol ($l = 1, 2, \dots, M_F - 1$) in the frame shall be:

$$M(l) = N_{pr} - \beta + \sum_{k=0}^{l-1} N_S(k),$$

where $N_S(k) = N + N_{CP}(k) - \beta$ and $N_S(k)$ may be different for symbols of the header and payload, as described in clause 7.1.4.7.

7.1.4.5.5 Windowing, overlap and add

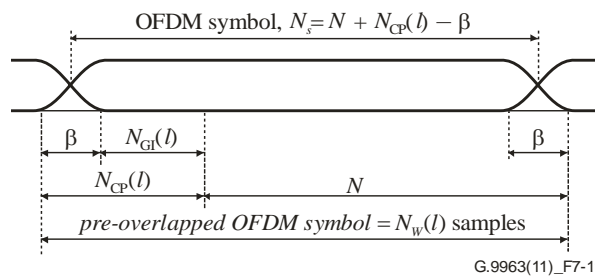

Figure 7-11 – Structure of an OFDM symbol with cyclic extension and overlapped windowing

The first β samples of the cyclic prefix and last β samples of the cyclic shift output shall be used for shaping the envelope of the transmitted signal (windowing). The window function facilitates PSD shaping: it allows sharp PSD roll-offs used to create deep spectral notches and reduction of the out-of-band PSD. The number of windowed samples, β , shall be the same for all of the payload symbols of the same frame, as well as the PHY-header and preamble.

To reduce the modulation overhead, the windowed samples of adjacent symbols shall overlap, as shown in Figure 7-11. The value of $N_{CP}(l) - \beta = N_{GL}(l)$ forms the guard interval. The duration of the l -th OFDM symbol after overlap is thus $N_S(l) = N + N_{CP}(l) - \beta$.

After applying the windowing and the overlap and add functions, the time-domain samples at the reference point $u_n^{(q)}$ in Figure 7-10 shall comply with the following equations:

$$u_n^{(q)} = u_n^{(pr,q)} + \sum_{l=0}^{M_F-1} w(n - M(l), l) \times u_{n-M(l),l}^{(q)} \quad \text{for } n = 0 \text{ to } M(M_F - 1) + N_W(M_F - 1) - 1,$$

where $u_n^{(pr,q)}$ is the n -th sample of the preamble of the q -th Tx port, as defined in clause 7.1.4.6 (the signal $u_n^{(pr,q)}$ already includes windowing as necessary), $w(n, l)$ is the windowing function defined on $N_W(l)$ samples of the pre-overlapped OFDM symbol in the following way:

$$w(n, l) = \begin{cases} w_\beta(n) & 0 \leq n < \beta \\ 1 & \beta \leq n < N_W(l) - \beta \\ w_\beta(N_W(l) - 1 - n) & N_W(l) - \beta \leq n < N_W(l) \\ 0 & \text{otherwise} \end{cases},$$

where $w_\beta(n)$ is the function describing the roll-off section of the window. The roll-off function $w_\beta(n)$ shall be vendor discretionary.

However, $w_\beta(n)$ shall comply with the following rules:

- $w_\beta(n) + w_\beta(\beta-n-1) = 1$ for $0 \leq n < \beta$.
- $0 \leq w_\beta(n) \leq 1$.

The symbol rate f_{OFDM} (number of symbols per second) and symbol period T_{OFDM} for the given value of N_{CP} and β shall be computed, respectively, as:

$$f_{OFDM} = \frac{N \times F_{SC}}{N + N_{CP} - \beta},$$

and $T_{OFDM} = 1/f_{OFDM}$.

7.1.4.5.6 Frequency up-shift

The frequency up-shift offsets the spectrum of the transmit signal shifting it by F_{US} . The value of F_{US} shall be a multiple of the sub-carrier frequency F_{SC} :

$$F_{US} = N/2 * F_{SC}$$

The real and imaginary components of the signal after frequency up-shift (reference point $s_n^{(q)}$ in Figure 7-10) shall be as follows:

$$s_n^{(q)} = u_{n/p}^{(q)} \times \exp\left(j \frac{\pi n}{p}\right) = \text{Re}(s_n^{(q)}) + j \text{Im}(s_n^{(q)}) \quad \text{for } n = 0 \text{ to } [M(M_F - 1) + N_W(M_F - 1)] \times p - 1;$$

$$\text{Re}(s_n^{(q)}) = \text{Re}(u_{n/p}^{(q)}) \cos\left(\frac{\pi n}{p}\right) - \text{Im}(u_{n/p}^{(q)}) \sin\left(\frac{\pi n}{p}\right)$$

$$\text{Im}(s_n^{(q)}) = \text{Re}(u_{n/p}^{(q)}) \sin\left(\frac{\pi n}{p}\right) + \text{Im}(u_{n/p}^{(q)}) \cos\left(\frac{\pi n}{p}\right)$$

where $u_{n/p}^{(q)}$ is $u_n^{(q)}$ after interpolation with factor p . The interpolation factor p is vendor discretionary and shall be equal to or higher than 2.

NOTE 1 – The minimum value of p sufficient to avoid distortions depends on the ratio between the up-shift frequency F_{US} and the bandwidth of the transmit signal $BW = N * F_{SC}$. It is assumed that an appropriate low-pass filter is included to reduce imaging.

NOTE 2 – The phase of the up-shift should be initialized to zero at the first sample of the preamble and be advanced by $\frac{\pi}{p}$ per each sample (after interpolation).

7.1.4.5.7 Output signal

The output signal of the modulator shall be the real component of $s_n^{(q)}$:

$$S_{\text{OUT-HF}}^{(q)} = \text{Re}(s_n^{(q)}).$$

7.1.4.6 Preamble, INUSE, PR, NACK and IDPS signals

7.1.4.6.1 General preamble structure

See clause 7.1.4.5.1 of [ITU-T G.9960].

7.1.4.6.2 INUSE, PR, NACK and IDPS signals general structure

See clause 7.1.4.5.2 of [ITU-T G.9960].

7.1.4.6.3 Preamble, INUSE, PR, NACK and IDPS signal generation

See clause 7.1.4.5.3 of [ITU-T G.9960] and its subclauses. When an ITU-T G.9963 node uses MIMO transmission, the preamble, INUSE, PR, NACK and IDPS signals shall each be created as a single spatial stream. In this case, the Tx port mapping shall be done using the "duplication" mapping matrix (i.e., *TPM#1*), defined in clause 7.1.4.4.1.2, on all of the signal's sub-carriers.

7.1.4.7 PMD control parameters

See clause 7.1.4.6 of [ITU-T G.9960].

7.1.4.8 Symbol boost

See clause 7.1.4.7 of [ITU-T G.9960].

7.1.5 Transmit PSD mask

See clause 7.1.5 of [ITU-T G.9960].

7.1.6 Electrical specifications

See clause 7.1.6 of [ITU-T G.9960].

7.2 Medium dependent specification

7.2.1 Physical layer specification

See clause 7.2.1 of [ITU-T G.9960] and clause 6.1 of [ITU-T G.9964] for phoneline cables.

See clause 7.2.2 of [ITU-T G.9960] and clause 6.2 of [ITU-T G.9964] for power lines.

7.2.2 Transmitter EVM requirements

See clause 7.2.4 of [ITU-T G.9960].

7.2.3 Termination impedance

See clause 6.4 of [ITU-T G.9964].

7.2.4 Total transmit power

See clause 6.5 of [ITU-T G.9964].

7.2.5 Receiver input impedance

See clause 6.6 of [ITU-T G.9964].

7.2.6 Longitudinal conversion loss

See clause 7.2.8 of [ITU-T G.9960].

8 Data link layer specification of the MIMO transceiver

8.1 Functional model and frame formats

See clause 8.1 of [ITU-T G.9961].

8.2 MAP controlled medium access

See clause 8.2 of [ITU-T G.9961].

8.3 Transmission opportunities (TXOPs) and time slots (TSs)

See clause 8.3 of [ITU-T G.9961].

8.4 Control parameters for APC, LLC and MAC

See clause 8.4 of [ITU-T G.9961] but with the following exceptions for power-line and phoneline cable baseband:

- For transmissions using 2 spatial streams (i.e., MIMO_IND = 1), the value of MIN_SYM_VAR_AIFG_DEFAULT shall be 3.
- For transmissions using 1 spatial stream, the value of MIN_SYM_VAR_AIFG_DEFAULT shall be 2.

8.5 Functions of the endpoint node

See clause 8.5 of [ITU-T G.9961].

8.6 Domain master node functional capabilities

See clause 8.6 of [ITU-T G.9961].

8.6.1 Network admission

See clause 8.6.1 of [ITU-T G.9961].

8.6.1.1 Network admission protocol

8.6.1.1.1 Registration into the domain

See clause 8.6.1.1.1 of [ITU-T G.9961].

8.6.1.1.2 Periodic re-registrations

See clause 8.6.1.1.2 of [ITU-T G.9961].

8.6.1.1.3 Resignation from the domain

See clause 8.6.1.1.3 of [ITU-T G.9961].

8.6.1.1.4 Registration and resignation messages

See clause 8.6.1.1.4 of [ITU-T G.9961] and its subclauses.

Additionally, see clause 8.6.1.1.4.1 of [ITU-T G.9961] after replacing the references to Tables 8-16.8 by the following Table 8-0.

Table 8-0 – Run-length compression support

Field	Octet	Bits	Description
BAT compression	0	[0]	See Table 8-16.8 in [ITU-T G.9961]
BMAT compression	0	[1]	If set to one, it indicates the capability of the node to compress and decompress BMAT fields (BAT and Precoding parameters) of MCE_ParamUpdate.req messages making use of the run-length compression mechanism described in clause 8.24 of ITU-T G.9963, zero otherwise. If this bit is set to one, the BAT compression field shall also be set to one.
Reserved	0	[7:2]	See Table 8-16.8 in [ITU-T G.9961]

8.6.1.2 Admission via proxy

See clause 8.6.1.2 of [ITU-T G.9961].

8.6.1.3 Domain information maintenance after node admission

In addition to the actions specified in clause 8.6.1.3 of [ITU-T G.9961], when a new node is admitted into the domain, the DM shall update the related MIMO domain wide information in order to take into account backward compatibility issues.

If any of the information included in the additional domain information auxiliary information sub-field of the MAP needs to be updated based on the node-information of the registering node (see Table 8-16.1 of [ITU-T G.9961]), the DM shall send a MAP-A with an updated additional MIMO domain information auxiliary information sub-field. The domain master shall use the validity counter-based update (AUX_VALID = 3 and ModificationFlag = 1).

Whenever a registering node indicates in its node-information during registration that it does not support a DM-defined initial seed (see clause 7.1.4.2.6 of [ITU-T G.9960]) the DM shall update the UnloadedSubcarrierInitialSeedStream1 and UnloadedSubcarrierInitialSeedStream2 fields of the additional MIMO domain information auxiliary information sub-field to the default value.

8.6.2 Bandwidth management

See clause 8.6.2 of [ITU-T G.9961].

8.6.3 Synchronization to an external source

See clause 8.6.3 of [ITU-T G.9961].

8.6.4 Routing and topology management

See clause 8.6.4 of [ITU-T G.9961].

8.6.5 Backup domain master

See clause 8.6.5 of [ITU-T G.9961].

8.6.6 Domain master selection

See clause 8.6.6 of [ITU-T G.9961].

8.7 Addressing scheme

See clause 8.7 of [ITU-T G.9961].

8.8 Medium access plan (MAP) frame

See clause 8.8 of [ITU-T G.9961].

8.8.1 MAP generation and distribution

See clause 8.8.1 of [ITU-T G.9961].

8.8.2 MAP frame transmission

See clause 8.8.2 of [ITU-T G.9961].

8.8.3 MAP header

See clause 8.8.3 of [ITU-T G.9961].

8.8.4 TXOP descriptor

See clause 8.8.4 of [ITU-T G.9961] and all its subclauses.

8.8.5 Auxiliary information field

See clause 8.8.5 of [ITU-T G.9961].

Additionally, Table 8-1 provides additional types of auxiliary information sub-fields, valid for MIMO nodes.

Table 8-1 – Types of auxiliary information sub-fields

Type	Value	Description
Additional MIMO Domain Information	11 ₁₆	A sub-field indicating additional MIMO domain information. See clause 8.8.7

8.8.6 MAP schedule persistence publication

See clause 8.8.6 of [ITU-T G.9961].

8.8.7 Additional MIMO domain information sub-field

The format of the Domain Info sub-field shall be as presented in Table 8-2. The length of the sub-field data is 8 octets.

Table 8-2 – Format of additional MIMO domain information sub-field

Field	Octet	Bits	Description
Type	0	[6:0]	Set to 11 ₁₆ .
ModificationFlag		[7]	This flag shall be set to one.
Length	1	[7:0]	Set to the length of the MIMO domain information sub-field (excluding the Type, ModificationFlag and Length) in octets (See Table 8-72 of [ITU-T G.9961])
UnloadedSubcarrierInitialSeedStream1	2 to 5	[22:0]	Value of the DM-generated seed to be used during modulation of unloaded supported sub-carriers for spatial stream 1(see clause 7.1.4.2.5)
Reserved		[31:23]	Reserved by ITU-T (Note).
UnloadedSubcarrierInitialSeedStream2	6 to 9	[22:0]	Value of the DM-generated seed to be used during modulation of unloaded supported sub-carriers for spatial stream 2(see clause 7.1.4.2.5)
Reserved		[31:23]	Reserved by ITU-T (Note).

NOTE – Bits that are reserved by ITU-T shall be set to zero by the transmitter and ignored by the receiver.

8.9 Retransmission and acknowledgement protocol

See clause 8.9 of [ITU-T G.9961].

8.10 Management and control message format

8.10.1 Management message format

See clause 8.10.1 of [ITU-T G.9961].

8.10.1.1 Management message OPCODEs

Management message OPCODEs are formatted as 12-bit unsigned integers. Valid values of OPCODEs are presented in Table 8-3 as well as Table 8-88 of [ITU-T G.9961]. OPCODEs are categorized (typically by their associated protocol or procedure) according to the value of their 8 MSBs.

Table 8-3 – OPCODEs of management messages

Category	Message name	OPCODE (hex)	Description	MMPL reference
MIMO Channel Estimation (80X-89X)	MCE_ProbeSlotAssign.req	800	MIMO channel estimation bandwidth assignment request	Clause 8.11.7.1
	MCE_ProbeSlotRelease.req	801	MIMO channel estimation bandwidth release request	Clause 8.11.7.2
	MCE_ParamUpdate.req	802	MIMO channel estimation parameters update request	Clause 8.11.7.3
	MCE_ParamUpdateRequest.ind	803	Request for MIMO channel estimation parameter update	Clause 8.11.7.4
	MCE_PartialBmatUpdate.req	804	Partial BMAT update request	Clause 8.11.7.5
	MCE_ACESymbols.ind	805	Request for an ACE symbol attachment	Clause 8.11.7.6
	MCE_ProbeSlotAssign.cnf	806	MIMO channel estimation bandwidth assignment confirmation	Clause 8.11.7.7
	MCE_ProbeSlotRelease.cnf	807	MIMO channel estimation bandwidth release confirmation	Clause 8.11.7.8
	MCE_ParamUpdate.cnf	808	MIMO channel estimation parameters update confirmation	Clause 8.11.7.9
	MCE_PartialBmatUpdate.cnf	809	Partial BMAT update confirmation	Clause 8.11.7.10
	MCE_Request.ind	80A	MIMO channel estimation trigger	Clause 8.11.7.11
	MCE_Initiation.req	80B	MIMO channel estimation initiation request	Clause 8.11.7.12
	MCE_Initiation.cnf	80C	MIMO channel estimation initiation confirmation	Clause 8.11.7.13
	MCE_ProbeRequest.ind	80D	Request for PROBE frame transmission	Clause 8.11.7.14

Table 8-3 – OPCODEs of management messages

Category	Message name	OPCODE (hex)	Description	MMPL reference
	MCE_Cancellation.req	80E	MIMO channel estimation cancellation request	Clause 8.11.7.15
	MCE_BmatIdMaintain.ind	80F	BMAT ID maintenance	Clause 8.11.7.16
	MCE_Cancellation.cnf	810	MIMO channel estimation cancellation confirmation	Clause 8.11.7.17
Reserved	Reserved	820-9FF	Reserved by ITU-T	

8.10.1.2 Management of message sequence numbers and segmentation

See clause 8.10.1.2 of [ITU-T G.9961].

8.10.2 Control message format

See clause 8.10.2 of [ITU-T G.9961].

8.11 Channel estimation protocol

ITU-T G.9963 nodes shall use the channel estimation protocol specified in clause 8.11 of [ITU-T G.9961] for links with ITU-T G.9960/G.9961 nodes and links with ITU-T G.9963 nodes using a single SS.

ITU-T G.9963 nodes shall use the channel estimation protocol specified in clause 8.11.1 for links with ITU-T G.9963 nodes using two SSs.

8.11.1 Channel estimation with ITU-T G.9963 transceivers using two spatial streams

The channel estimation protocol describes the procedure of measuring the characteristics of the channel between the transmitter (source) and the receiver (destination) nodes. The procedure involves initiation of channel estimation, transmissions of PROBE frames and selection of parameters.

Channel estimation can be done in two phases:

- Channel discovery – initial channel estimation.
- Channel adaptation – subsequent channel estimation to adapt to a changing channel.

The protocols used for channel discovery and channel adaptation can be started either by the transmitter or by the receiver. The core part of the channel estimation protocol is identical in these two cases and is always initiated by the receiver (receiver-initiated channel estimation). The transmitter can request the receiver to initiate channel estimation (transmitter-requested channel estimation).

During the initiation process, the transmitter and receiver jointly determine input parameters for channel estimation such as channel estimation window (a fraction of a MAC cycle over which channel estimation should be executed), the value of G (see clause 7.1.4.2.3 of [ITU-T G.9960]), the value of PG (see clause 7.1.4.4.2.3) and parameters for the PROBE frame. The receiver selects the `BMAT_ID` associated with the triplet of the two BATs (each associated with a different spatial stream) and `MAT`, termed `BMAT`, to be updated. This `BMAT_ID` is used as an identifier for a particular channel estimation process throughout the rest of the process. The receiver shall consider its own frequency information (namely the `StartSubCarrier` & `StopSubCarrier`) and that of the transmitter when

calculating the BMAT. More specifically, the range of sub-carriers of the BMAT sent in the MCE_ParamUpdate.req message shall be within the intersection of the sub-carrier ranges determined by the StartSubCarrier & StopSubCarrier of both the receiver and transmitter.

Once the channel estimation process is initiated, the receiver may request the transmitter to send one or more PROBE frames. The receiver can change parameters of a PROBE frame at each request. If the receiver requests a PROBE frame without specifying its parameters (e.g., request for PROBE frame transmission via ACK_CE_CTRL as described in clause 8.11.1.4), the transmitter transmits the PROBE frame using parameters previously selected by the receiver. The receiver is not required to request PROBE frames if it chooses other means such as MSG frames or PROBE frames transmitted to other nodes to estimate the channel.

The receiver terminates the channel estimation process by sending the outcome of channel estimation to the transmitter. This may include, but is not limited to, the following parameters:

- Bit allocation tables (BATs). A BAT for each one of the two possible spatial streams.
- MIMO mode indicator, indicating the MIMO mode used (see Table 8-6).
- Precoding feedback quantization indicator.
- Precoding parameters.
- FEC coding rate and block size.
- Guard interval for payload.
- PSD ceiling.

The receiver may cancel the channel estimation process without generating new channel estimation parameters.

The protocol provides several options to expedite the channel estimation process for faster channel adaptation. For example, the channel estimation initiation process (clause 8.11.1.1.1) can be omitted in case of channel adaptation where no new input parameter negotiation is necessary. The receiver can create a new BMAT by sending an unsolicited MCE_ParamUpdate.req (clause 8.11.1.3.1) or update the existing BMAT by sending an MCE_PartialBmatUpdate.req (clause 8.11.1.3.2). The receiver can request PROBE frame transmission without going through the channel estimation initiation process (clause 8.11.1.4).

8.11.1.1 Receiver-initiated channel estimation

The following procedure describes the receiver-initiated channel estimation process:

- 1) The receiver initiates the channel estimation process by sending the transmitter an MCE_Initiation.req message. The receiver may request a PROBE frame transmission in this message (channel estimation initiation, see clause 8.11.1.1.1).
- 2) Upon reception of the channel estimation initiation request, if the transmitter does not have transmit opportunities for a given channel estimation window, it shall request the domain master to allocate bandwidth for PROBE frame transmission by sending an MCE_ProbeSlotAssign.req message. The domain master shall confirm that it received the bandwidth request by replying with the MCE_ProbeSlotAssign.cnf message (bandwidth request, see clause 8.11.1.1.2).
- 3) Depending on the availability of bandwidth, the transmitter may grant or reject the channel estimation initiation request by sending the receiver an MCE_Initiation.cnf message (channel estimation initiation confirmation, see clause 8.11.1.1.3).

- 4) Upon reception of the MCE_Initiation.cnf message indicating channel estimation initiation confirmation, the receiver may request the transmitter to send additional PROBE frames by sending an MCE_ProbeRequest.ind message or through the ACK_CE_CTRL field in the PFH of an ACK frame (request for PROBE frame transmission, see clause 8.11.1.1.4).
- 5) Upon reception of the request for PROBE frame transmission, the transmitter shall transmit the PROBE frame as the receiver requested (PROBE frame transmission, see clause 8.11.1.1.5).
- 6) Steps 4 and 5 can repeat until the receiver sends the transmitter the final outcome of channel estimation using the MCE_ParamUpdate.req message. The transmitter shall confirm reception of the new parameters by sending an MCE_ParamUpdate.cnf message (channel estimation completion, see clause 8.11.1.1.6). Steps 4 and 5 may be skipped altogether if the receiver does not need additional PROBE frames.
- 7) The receiver may cancel the channel estimation process any time after it receives the channel estimation initiation confirmation by sending an MCE_Cancellation.req message (channel estimation cancellation, see clause 8.11.1.1.7).
- 8) Upon reception of an MCE_ParamUpdate.req message, if the transmitter has been allocated extra bandwidth for the PROBE frame transmission, it shall send an MCE_ProbeSlotRelease.req message to the domain master to release the bandwidth used for PROBE frame transmission. The domain master shall confirm the bandwidth release request by replying with an MCE_ProbeSlotRelease.cnf message (bandwidth release, see clause 8.11.1.1.8).

The transmitter may send frames carrying payload with the existing settings (e.g., any valid runtime BMAT or predefined BMAT) at any time during this process.

The receiver-initiated channel estimation process is illustrated in Figure 8-1.

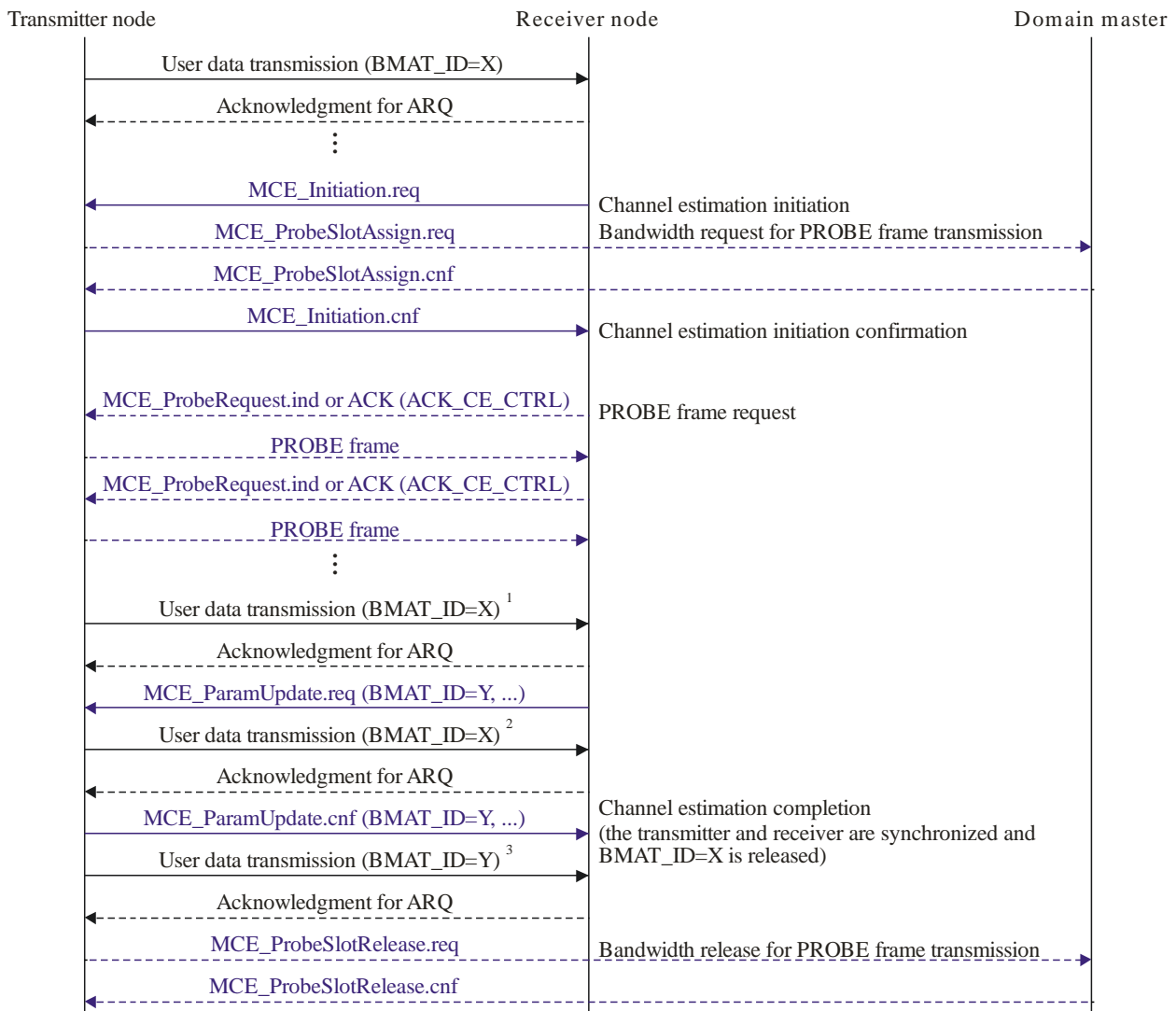

G.9963(11)_F8-1

Dotted-lines indicate optional communications.

¹The transmitter can transmit data using the existing BMAT anytime during channel estimation process .

²1st user data transmission after MCE_ParamUpdate.req may not use updated channel estimation parameters.

³The transmitter decides when to apply updated channel estimation parameters within a given constraint.

Figure 8-1 – Receiver-initiated channel estimation

8.11.1.1.1 Channel estimation initiation

The receiver initiates the channel estimation process by sending the transmitter an MCE_Initiation.req message.

The receiver shall select CE_BAT_GRP (G), which indicates the value of GRP_ID (G) associated with the BATs to be updated (whenever two spatial streams are used, the same grouping applies to both streams). The receiver shall also select CE_PR_GRP, which indicates the value of precoding grouping (PG) associated with the precoding parameters to be updated. The receiver shall select CE_STIME and CE_ETIME, which determines the start and end time of the channel estimation window. During the rest of channel estimation process, the transmitter shall send PROBE frames inside this window. The receiver shall select CE_BMAT_ID from ones that are currently invalid. This value shall be used to differentiate multiple channel estimation processes being executed at the same time. The receiver may request PROBE frame transmission by setting CE_PRB_RQST field. The MCE_PRB_PARM field specifies parameters for the default PROBE frame. If the CE_PRB_RQST field is not set to one, parameters for the default PROBE frame shall be as follows:

CE_PR_PRBTYPE = 1000₂; CE_PR_PRBFN = 0000₂; CE_PR_PRBSYM = 0011₂; CE_PR_PRBGI = 111₂, CE_PR_APSD_MAX = 31, CE_PR_APSD_MAX_EXT=0 and PRB_BMAT_ID = 11.

The receiver may resend the MCE_Initiation.req message, if it does not receive the MCE_Initiation.cnf message within 200 ms.

8.11.1.1.2 Channel estimation bandwidth request

If the transmitter does not have transmit opportunities inside a given channel estimation window, it shall request the domain master to allocate bandwidth for PROBE frame transmission by sending MCE_ProbeSlotAssign.req message.

The transmitter shall provide the domain master the channel estimation identifier (i.e., CE_BMAT_ID, Transmitter_ID and Receiver_ID), channel estimation window (CE_STIME and CE_ETIME) and PROBE frame parameters (CE_PRB_PARM) as provided by MCE_Initiation.req message.

The transmitter shall provide the priority of the bandwidth request in the MCE_ProbeSlotAssign.req message by setting the CE_PRIORITY field to the highest priority of the user data traffic that the transmitter has to send to the specified receiver.

The domain master shall confirm the bandwidth request by replying to the transmitter with an MCE_ProbeSlotAssign.cnf indicating whether or not the request is granted within 100 ms after it receives the MCE_ProbeSlotAssign.req message.

The domain master should allocate bandwidth so that at least one PROBE frame with requested parameters can be transmitted during the channel estimation window. The additional TSs or TXOPs shall only be used for PROBE frame transmissions (see clause 8.8.4.1.1 of [ITU-T G.9961]). If the domain master has granted extra bandwidth for PROBE frame transmission, it should keep this bandwidth until it receives the bandwidth release request from the transmitter (see clause 8.11.1.1.8).

If the transmitter does not receive the MCE_ProbeSlotAssign.cnf message, it may resend the MCE_ProbeSlotAssign.req message multiple times before it transmits the channel estimation initiation confirmation.

8.11.1.1.3 Channel estimation initiation confirmation

The transmitter shall confirm the channel estimation initiation request by sending the receiver an MCE_Initiation.cnf message.

The transmitter shall indicate whether it grants or rejects the channel estimation initiation request. The transmitter shall set CE_BMAT_ID to the value selected by the receiver in the MCE_Initiation.req message. The transmitter shall finalize CE_BAT_GRP, which shall be equal to the one indicated by the receiver via channel estimation initiation request and CE_PG_GRP, which shall be larger than or equal to the one indicated by the receiver via channel estimation initiation request.

The transmitter shall send an MCE_Initiation.cnf message within 100 ms after it receives the MCE_Initiation.req message. If the transmitter needs to request the bandwidth for PROBE frame transmission, the transmitter shall send an MCE_Initiation.cnf message within 200 ms.

8.11.1.1.4 Request for PROBE frame transmission

Once a channel estimation initiation request has been confirmed, the receiver may request the transmitter to send additional PROBE frames by sending MCE_ProbeRequest.ind message.

The receiver can request specific parameters of the PROBE frame via the CE_PRB_PARM field of the MCE_ProbeRequest.ind message.

Alternatively, the receiver may request PROBE frames by using the ACK_CE_CTRL field in the PHY-frame header of an ACK frame addressed to the transmitter node (see clause 8.11.1.4).

The receiver may not request PROBE frames at all if it uses other frames carrying payload (e.g., MSG, BMSG, BACK) to estimate the channel.

8.11.1.1.5 PROBE frame transmission

Upon reception of the request for PROBE frame transmission, the transmitter shall transmit PROBE frames as soon as possible as described in clause 8.11.1.4.

8.11.1.1.6 Channel estimation completion

At any time after channel estimation initiation request has been confirmed, the receiver may send the transmitter the outcome of channel estimation using the MCE_ParamUpdate.req message. The transmitter shall confirm reception of the new parameters by replying with the MCE_ParamUpdate.cnf message within 100 ms.

Upon reception of the MCE_ParamUpdate.req message, the transmitter shall incorporate the new channel estimation parameters (new BMATs, etc.) as soon as possible.

If the transmitter does not receive a message that is related to channel estimation (i.e., MCE_ProbeRequest.ind or MCE_ParamUpdate.req), or does not receive a request for PROBE frame transmission via an ACK frame, within 200 ms after the channel estimation initiation request has been confirmed, it may send the receiver an MCE_ParamUpdateRequest.ind message to request the receiver to resend the result of the specified channel estimation.

If the transmitter does not receive either MCE_ParamUpdate.req or MCE_Cancellation.req within 400 ms after the channel estimation initiation request has been confirmed, it shall abort the channel estimation process.

8.11.1.1.7 Channel estimation cancellation

At any time after channel estimation initiation request has been confirmed, the receiver may cancel the channel estimation process using the MCE_Cancellation.req message. The transmitter shall confirm receiving the cancellation request within 100 ms by replying with the MCE_Cancellation.cnf message. If the receiver does not receive the MCE_Cancellation.cnf message within 200 ms, it may resend the MCE_Cancellation.req message.

If the receiver does not receive either MCE_ParamUpdate.cnf or MCE_Cancellation.cnf within 400 ms after the channel estimation initiation request has been confirmed, it shall abort the channel estimation process and consider the CE_BMAT ID as invalid (see clause 8.11.1.5).

In this case, the channel estimation is finished without generating a new BMAT (i.e., new BATs and MAT).

8.11.1.1.8 Channel estimation bandwidth release

Upon reception of the MCE_ParamUpdate.req or MCE_Cancellation.req message, the transmitter shall request the domain master to release any bandwidth previously assigned for PROBE frame transmission by sending MCE_ProbeSlotRelease.req message.

The transmitter shall provide the domain master with the channel estimation identifier (i.e., CE_BMAT_ID, Transmitter_ID and Receiver_ID) and channel estimation window (CE_STIME and CE_ETIME) associated with the channel estimation process.

The domain master shall confirm receiving the MCE_ProbeSlotRelease.req message within 100 ms by replying with the MCE_ProbeSlotRelease.cnf message. If the domain master does not receive a CE_ProbeSlotRelease.req message from the transmitter within 800 ms after the bandwidth was assigned, it shall release the bandwidth allocated to the transmitter for PROBE frames. The domain master shall only release bandwidth additionally assigned to the transmitter for PROBE frame transmission for the associated channel estimation identifier.

8.11.1.2 Transmitter-requested channel estimation

The following procedure describes the transmitter-requested channel estimation process:

- 1) The transmitter requests channel estimation by sending the receiver MCE_Request.ind message (channel estimation request, see clause 8.11.1.2.1).
- 2) The rest of the procedure is the same as described in clause 8.11.1.1 (step 1 through step 8).

The transmitter may send frames carrying payload with the existing settings (e.g., any valid runtime BMAT or predefined BMAT) any time during this process.

8.11.1.2.1 Channel estimation request

The transmitter triggers the channel estimation process by sending the receiver MCE_Request.ind message.

The transmitter can specify the channel estimation window (CE_STIME and CE_ETIME). In this case the receiver shall use the same channel estimation window as the transmitter requested in the MCE_Initiation.req message. Otherwise, the receiver can determine the channel estimation window at its own discretion.

The receiver shall respond to a MCE_Request.ind message from the transmitter within 100 ms with either a MCE_Initiation.req message or a MCE_ParamUpdate.req message.

If the transmitter does not receive either the MCE_Initiation.req message or the MC_ParamUpdate.req message within 200 ms after MCE_Request.ind is sent, it may resend the channel estimation request message.

8.11.1.3 Shortened channel estimation processes

8.11.1.3.1 Unsolicited MCE_ParamUpdate.req

It is not required to exchange PROBE frames between transmitter and receiver in order to exchange a new BMAT between them. The receiver may send a new BMAT at any time to the transmitter by sending an MCE_ParamUpdate.req message, provided that the BMAT_ID is invalid at the time of sending the new BMAT. The receiver may use PROBE frames or other frames carrying payload (e.g., MSG, BMSG, BACK) transmitted to other nodes to estimate the channel.

Upon receiving the MCE_ParamUpdate.req message, the transmitter shall reply by sending the MCE_ParamUpdate.cnf message within 100 ms indicating whether the transmitter adopts the new BMAT or rejects the new BMAT due to lack of resources.

If the receiver does not receive MCE_ParamUpdate.cnf within 200 ms, it may retry with the same or a different MCE_ParamUpdate.req message.

8.11.1.3.2 Partial BMAT update

The transmitter and receiver that communicate with each other by establishing a common runtime BMAT may update a portion of the BMAT at any time during its usage. The receiver may initiate the partial BMAT update (PBMU) by sending PBMU information in the management message.

The process of partial BMAT update is described as follows:

- 1) At any time during communication, the receiver may send the PBMU request for any valid BMAT used by the transmitter. The PBMU request contains the new valid BMAT_ID (N_BMAT_ID), old BMAT_ID (O_BMAT_ID) associated with the BMAT to be updated and bit allocation changes (see clause 8.11.1.3.2.1).
- 2) Upon reception of the PBMU request, the transmitter shall update the BMAT associated with the O_BMAT_ID and assign N_BMAT_ID to the updated BMAT and reply with the PBMU confirmation. After receiving the first frame carrying payload using the N_BMAT_ID, the receiver shall consider O_BMAT_ID as invalid (see clause 8.11.1.5).

- 3) The receiver may send another PBMU request after confirming that the transmitter incorporated the previous PBMU request or after inferring that the previous PBMU request was lost.

8.11.1.3.2.1 PBMU request

The receiver may send the PBMU request using the MCE_PartialBmatUpdate.req message in which the receiver can request bit allocations, Tx port mapping allocations and precoding parameter changes for up to 1024 sub-carriers. Figure 8-2 illustrates an example of partial BAT update using this approach. Note that acknowledgement is disabled in this example.

If the receiver does not receive MCE_PartialBmatUpdate.cnf within 200 ms, it may retry with the same or a different MCE_PartialBmatUpdate.req message.

8.11.1.3.2.2 PBMU confirmation

Upon reception of the MCE_PartialBmatUpdate.req message, the transmitter should incorporate the new channel estimation parameters as soon as possible and then send the MCE_PartialBmatUpdate.cnf message to confirm the received MCE_PartialBmatUpdate.req message within 100 ms. The receiver shall infer loss of the PBMU request if the PBMU confirmation is not received within 200 ms after it transmits MCE_PartialBmatUpdate.req. The transmitter may switch to N_BMAT_ID before sending the MCE_PartialBmatUpdate.cnf message.

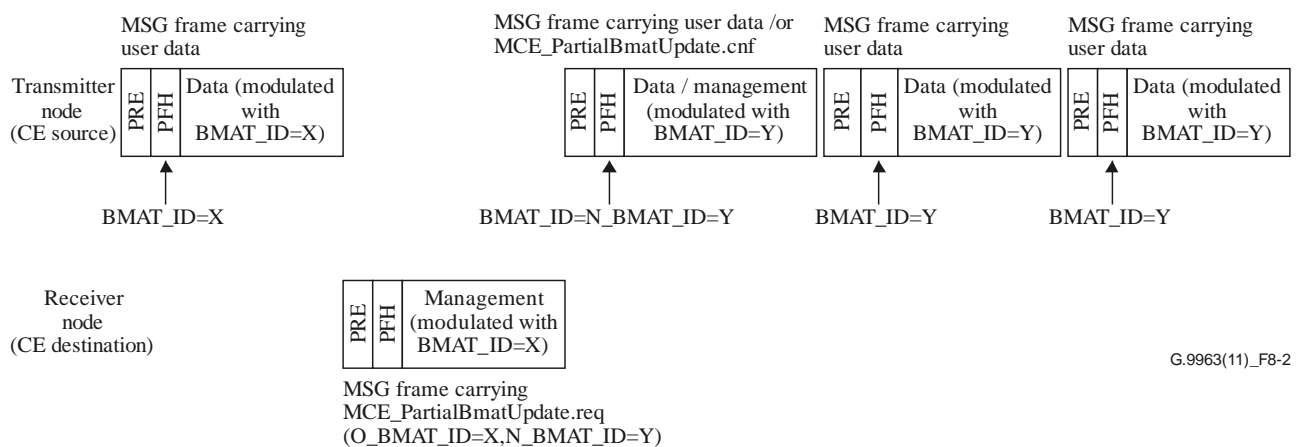

Figure 8-2 – Example of partial BMAT update using management message

8.11.1.4 Channel estimation using PROBE frames

The receiver can request the transmitter for PROBE frame transmission at any time after registration without going through the channel estimation initiation process.

To request PROBE frames, the receiver may use MCE_ProbeRequest.ind messages or the ACK_CE_CTRL field in the PFH of an ACK frame (see clause 7.1.2.3.2.3.1). Upon reception of a request for PROBE frame transmission, the transmitter should transmit PROBE frames as soon as possible.

If the receiver requests a PROBE frame through a specific management message, the transmitter shall transmit the PROBE frame using parameters selected by the receiver, that is, the parameters selected in the latest request for PROBE frame transmission (MCE_ProbeRequest.ind) or channel estimation initiation (MCE_Initiation.req).

If the receiver requests a PROBE frame through an ACK frame, the transmitter shall use the default PROBE frame. The transmitter shall use the default PROBE frame for all ACK frame-based requests for PROBE frame transmission by the receiver regardless of the BAT_ID. In this case, the transmitter may transmit PROBE frames anywhere in a MAC cycle, regardless of a particular channel estimation window associated with the BMAT_ID under channel estimation.

The parameters for the default PROBE frame are determined by the receiver through the MCE_Initiation.req message as described in clause 8.11.2.1.1. Alternatively, they can be updated by setting a bit in the MCE_ProbeRequest.ind message as described in Table 8-19.

When a transmitter receives a request for PROBE frame transmission from a receiver while handling previous requests for PROBE frame transmission from the same receiver, it should ignore the new request if the requested parameters are the same as the old ones, regardless of the value of the BMAT_ID under estimation.

NOTE – The transmitter should try to cover as much of the channel estimation window as possible when generating PROBE frames.

When the receiver requests a PROBE frame via ACK frames, it may request multiple times by sending multiple ACK frames by setting ACK_CE_CTRL until it receives the PROBE frame. The transmitter should ignore new requests for PROBE frame transmission coming from the receiver in order to avoid unnecessary PROBE frame transmissions.

After PROBE frame transmissions, the receiver may send the outcome of channel estimation to the transmitter in case it is needed, using an unsolicited MCE_ParamUpdate.req (clause 8.11.1.3.1) or a partial BMAT update (clause 8.11.1.3.2).

A PROBE frame should be considered as having an MPDU priority equal to 7.

8.11.1.4.1 Channel estimation using PROBE frames transmitted by a node as requested by the domain master

Since the domain master (DM) is in charge of the scheduling and is also aware of the routes between any two nodes of the domain, DM may allocate a special CFTXOP assigned to a single source node and a minimum user priority identified by the tuple (SID, PRI) (see clause 8.3.4 of [ITU-T G.9961]) with the value of PRI set by the DM where the assigned node shall transmit PROBE frames (if it has no data to transmit), which the neighbouring nodes can then use to estimate the SNR and measure throughput. This information can be useful for diagnostics. This allows measurement of SNRs and throughput even on the links that are not used for delivering traffic, where there is no need to generate and exchange BATs.

This special CFTXOP is indicated by the DM setting the "TXOP Limitations" field in the "Additional TXOP attributes" descriptor set to 2 (see Table 8-65.1 of [ITU-T G.9961]) and the "Traffic Limitation" field in the "TXOP attributes" descriptor set to 0 (see Table 8-65 of [ITU-T G.9961]).

The DM may allocate bandwidth to specific nodes (in the form of special TXOPs for probe transmissions, see clause 8.8.4.1.1 of [ITU-T G.9961]) so that at least one PROBE frame with default parameters can be transmitted during the channel estimation window of interest. These special TXOPs shall be used for PROBE frame transmissions unless there is data that needs to be transmitted by the node that is assigned the special TXOP. The node that is assigned this special TXOP shall:

- transmit regular data traffic during the TXOP, if the node has data to transmit, or
- transmit PROBE frames if the node has no data to transmit.

Probe frames shall be transmitted at the maximum power level that the node uses for data transmission. The DID in the PHY frame header of the probe frame shall be set to FF₁₆.

8.11.1.5 BMAT_ID maintenance

The receiver is responsible for tracking the list of valid and invalid BMAT_IDs. The receiver informs the transmitter of the valid BMAT_IDs in the VALID_BMAT_ID field by sending an MCE_BmatIdMaintain.ind message. The transmitter shall stop using BMAT_IDs that are marked as invalid by the receiver as soon as possible. If all the BMAT_IDs are marked as invalid, the transmitter may use RCM mode. In this case, the transmitter should use the parameters indicated in the MCE_BmatIdMaintain.ind message.

If a BMAT_ID is marked as valid by the receiver but the transmitter does not have a BMAT (BATs and MAT) associated with it (e.g., the transmitter fails to receive MCE_ParamUpdate.req), the transmitter shall send an MCE_ParamUpdateRequest.ind message requesting the transmission of the BMAT.

The receiver may instruct the transmitter to stop using a BMAT_ID via the ACK_CE_CTRL field in the ACK frame (see clause 7.1.2.3.2.3.1). The transmitter shall then consider the BMAT_ID as invalid.

The receiver may invalidate a BMAT_ID as part of the channel estimation cancellation process (see clause 8.11.1.1.7).

8.11.1.6 ACE symbol insertion

MIMO transmission of MSG, BMSG and BACK PHY frame types where the payload is intended for ITU-T G.9963 receivers (i.e., case 4a in Table 7-1, indicated by the MIMO_IND flag in the PFH set to one) and MIMO transmission of PROBE frames (PRBTYPE 1000₂) shall always include at least one ACE symbol in the frame. In this case, in addition to this ACE symbol, up to 6 additional ACE symbols may be attached. In all other MIMO transmission cases where the transmission includes payload (i.e., cases 4b, 5 and 6 in Table 7-1), up to 7 ACE symbols may be attached.

The receiver may request the transmitter to attach up to 7 ACE symbols (see clause 7.1.2.1) at any time after registration by sending an MCE_ACESymbols.ind message for case 4a in Table 7-1 (indicated by the MIMO_IND flag in the PFH set to one) and a CE_ACESymbols.ind message for cases 4b, 5 and 6 in Table 7-1. Within 100 ms after receiving this message, the transmitter shall attach ACE symbols as requested by the receiver to all frames sent to the receiver that are allowed to carry ACE symbols. The receiver may use the same procedure to change the number of ACE symbols.

8.11.1.7 Management message formats for channel estimation

8.11.1.7.1 Format of MCE_ProbeSlotAssign.req

The format of the MMPL of the MCE_ProbeSlotAssign.req message shall be as shown in Table 8-4.

Table 8-4 – Format of the MMPL of the MCE_ProbeSlotAssign.req message

Field	Octet	Bits	Description
Transmitter ID	0	[7:0]	The DEVICE_ID of the node requesting the bandwidth allocation for PROBE frame transmissions.
Receiver ID	1	[7:0]	The DEVICE ID of the receiver node in the channel estimation procedure.
CE_BMAT_ID	2	[4:0]	This field indicates the BMAT_ID associated with the runtime BMAT to be updated by channel estimation. It shall be formatted as shown in Table 7-3.
Reserved		[7:5]	Reserved by ITU-T (Note).
CE_STIME	3	[7:0]	This field indicates time at which the transmitter can start PROBE frame transmissions and it shall be coded as shown in Table 8-98 of [ITU-T G.9961].
CE_ETIME	4	[7:0]	This field indicates time at which the transmitter shall end PROBE frame transmissions and it shall be coded as shown in Table 8-99 of [ITU-T G.9961].
CE_PRB_PARM	5 to 9	[39:0]	This field specifies a set of parameters for PROBE frame. It shall be coded as shown in Table 8-23.

Table 8-4 – Format of the MMPL of the MCE_ProbeSlotAssign.req message

Field	Octet	Bits	Description
CE_PRIORITY	10	[2:0]	This field specifies the highest user priority of the traffic the transmitter has to transmit to the specified receiver.
Reserved		[7:3]	Reserved by ITU-T (Note).
NOTE – Bits that are reserved by ITU-T shall be set to zero by the transmitter and ignored by the receiver.			

8.11.1.7.2 Format of MCE_ProbeSlotRelease.req

The format of the MMPL of the MCE_ProbeSlotRelease.req message shall be as shown in Table 8-5.

Table 8-5 – Format of the MMPL of the MCE_ProbeSlotRelease.req message

Field	Octet	Bits	Description
Transmitter ID	0	[7:0]	The DEVICE_ID of the node requesting the bandwidth allocation for PROBE frame transmissions.
Receiver ID	1	[7:0]	The DEVICE_ID of the receiver who initiated the channel estimation.
CE_BMAT_ID	2	[4:0]	This field indicates the BMAT_ID associated with the runtime BMAT to be updated by channel estimation. It shall be formatted as shown in Table 7-3.
Reserved		[7:5]	Reserved by ITU-T (Note).
CE_STIME	3	[7:0]	This field indicates time at which the transmitter can start PROBE frame transmissions and it shall be coded as shown in Table 8-98 of [ITU-T G.9961].
CE_ETIME	4	[7:0]	This field indicates time at which the transmitter shall end PROBE frame transmissions and it shall be coded as shown in Table 8-99 of [ITU-T G.9961].
NOTE – Bits that are reserved by ITU-T shall be set to zero by the transmitter and ignored by the receiver.			

8.11.1.7.3 Format of MCE_ParamUpdate.req

The format of the MMPL of the MCE_ParamUpdate.req message shall be as shown in Table 8-6.

Table 8-6 – Format of the MMPL of the MCE_ParamUpdate.req message

Field	Octet	Bits	Description
New BMAT ID	0 and 1	[4:0]	This field indicates the BMAT_ID associated with a new BMAT (CE_BMAT_ID). It shall be formatted as shown in Table 7-3.
Frequency range		[7:5]	This field indicates the type of frequency range based on which the subsequent BAT entries are defined. It shall be formatted as shown in Table 7-10 of [ITU-T G.9960].
CE_BAT_GRP		[10:8]	This field indicates the BAT grouping (G) associated with the new BATs, and determined at the channel estimation initiation confirmation. It shall be formatted as shown in Table 8-7.

Table 8-6 – Format of the MMPL of the MCE_ParamUpdate.req message

Field	Octet	Bits	Description
MIMO mode indicator		[12:11]	This field indicates the usage of one of the following MIMO modes, for the BMAT_ID associated with the new BMAT (CE_BMAT_ID) (Note 10): 0 – Mode 0 1 – Mode 1 2 – Mode 2 3 – Reserved by ITU-T See clause 8.23.2.2 for a description of the above modes.
BAT update indicator		[13]	0, when the BATs of SS 1 and SS 2 are not updated in the message, i.e., when the BAT fields, $B_1^{(1)}, \dots, B_Z^{(1)}$ and $B_1^{(2)}, \dots, B_Z^{(2)}$ are not present in the message. 1, when the BATs of SS 1 and SS 2 are updated in the message, i.e., when the BAT fields are present in the message. Z is defined in the $TIDX_{MAX}$ field.
Precoding feedback update indicator		[14]	0, when the precoding parameters are not updated in the message, i.e., when the precoding parameters fields, $P_{1,\theta}, P_{1,\phi}, \dots, P_{K,\theta}$ and $P_{K,\phi}$ are not present in the message. 1, the precoding parameters are updated in the message, i.e., when the precoding parameters fields are present in the message. This field shall be set to 0 in case the "MIMO mode indicator" field is set to 0. K is defined in the $TIDX_{max}$ field.
Precoding feedback quantization indicator		[15]	0, when $P_{i,\theta}$ and $P_{i,\phi}$ are quantized as 4-bit values. 1, when $P_{i,\theta}$ and $P_{i,\phi}$ are quantized as 8-bit values. Whenever the "Precoding feedback update indicator" field is set to 0 this field shall be ignored by the receiver of the message.
CE_PR_GRP	2	[2:0]	This field indicates the precoding grouping (PG) associated with the precoding feedback update indicator and the feedback parameters $P_{i,j}$, and determined at the channel estimation initiation confirmation. It shall be formatted as shown in Table 8-7 – Format of the CE_PR_GRP. Whenever the "Precoding feedback update indicator" field is set to 0 this field shall be ignored by the receiver of the message.
BAT_COMPRESSION		3	This bit indicates if a run-length compression mechanism is used for conveying the BAT information (fields $B_1^{(1)}$ to $B_Z^{(1)}$ and fields $B_1^{(2)}$ to $B_Z^{(2)}$). When this bit is set to zero, no run-length compression mechanism is used for BAT compression. When this bit is set to one, a run-length compression mechanism is used for BAT compression. This bit shall only be set to one if the BMAT compression field (see Table 8-0) is also set to one.

Table 8-6 – Format of the MMPL of the MCE_ParamUpdate.req message

Field	Octet	Bits	Description
PRECODING_COMPRESSION		4	This bit indicates if a run-length compression mechanism is used for conveying the precoding information (fields $P_{1,\theta}$ to $P_{K,\theta}$, and fields $P_{1,\varphi}$ to $P_{K,\varphi}$). When this bit is set to zero, no run-length compression mechanism is used for precoding compression. When this bit is set to one, a run-length compression mechanism is used for precoding compression. This bit shall only be set to one if the BMAT compression field (see Table 8-0) is also set to one.
NUM_VALID_DUR_EXT		[6:5]	This field contains the extended bits of NUM_VALID_DUR, and they are appended and used for the MSB of NUM_VALID_DUR. With this extension, the valid range of values for NUM_VALID_DUR is from 0 ($V=1$) to 31 ($V=32$) (Note 16).
APSD_MAX_EXT		[7]	This field is the value of APSD_MAX_EXT in the PHY-frame header associated with the new BMAT. This field shall be formatted as shown in clause 7.1.2.3.2.2.25 of [ITU-T G.9960] (Note 15).
VALID_BMAT_ID	3 and 4	[15:0]	This field contains a bitmap indicating which runtime BMATs are valid (including the New BMAT ID) for this node (SID) when receiving from the destination node (DID). Each bit is associated with one runtime BMAT. Bit 0 of the VALID_BMAT_ID shall be set to one if runtime BMAT_ID 16 is valid. Bit 11 of the VALID_BMAT_ID shall be set to one if runtime BMAT_ID 27 is valid.
NUM_TX_AVAIL_BMATs_NO_PREC	5	[3:0]	This field contains the number of available runtime BMATs, assuming $G = 1$ and no precoding, that this node (SID) can support when transmitting to the destination node (DID). Valid values are from 0 to 12.
NUM_TX_AVAIL_BMATs_PREC		[7:4]	This field contains the number of available runtime BMATs, assuming $G = 1$ and $PG = 1$ (with the precoding parameters quantized to 8 bits), that this node (SID) can support when transmitting to the destination node (DID). Valid values are from 0 to 12.
New block size	6	[1:0]	This field indicates the proposed BLKSZ associated with the new BMAT. It shall be formatted as shown in Table 7-7 of [ITU-T G.9960] (Note 2).
New FEC rate		[4:2]	This field indicates the proposed FEC_RATE associated with the new BMAT. It shall be formatted as shown in Table 7-12 of [ITU-T G.9960] (Note 3).
New GI		[7:5]	This field indicates the proposed GI_ID associated with the new BMAT. It shall be formatted as shown in Table 7-14 of [ITU-T G.9960] (Note 4).

Table 8-6 – Format of the MMPL of the MCE_ParamUpdate.req message

Field	Octet	Bits	Description
APSD_MAX	7	[4:0]	This field is the value of APSD_MAX in the PHY-frame header associated with the new BMAT. This field shall be formatted as shown in clause 7.1.2.3.2.2.11 (Note 15).
NUM_VALID_DURATION		[7:5]	This field indicates the number of valid durations specified for the new BMAT (V). The valid range of values for this field is from 0 ($V=1$) to 7 ($V=8$) without extension (Note 5).
CE_STIME ₁	8	[7:0]	This field indicates the start time of the first duration in which the new BMAT is valid. It shall be formatted as shown in Table 8-98 of [ITU-T G.9961].
CE_ETIME ₁	9	[7:0]	This field indicates the end time of the first duration in which the new BMAT is valid. It shall be formatted as shown in Table 8-99 of [ITU-T G.9961].
...
CE_STIME _v	$2V+6$	[7:0]	This field indicates the start time of the last duration in which the new BAT is valid. It shall be formatted as shown in Table 8-98 of [ITU-T G.9961].
CE_ETIME _v	$2V+7$	[7:0]	This field indicates the end time of the last duration in which the new BMAT is valid. It shall be formatted as shown in Table 8-99 of [ITU-T G.9961].
TIDX _{MIN} for Profile 1 OFBs	$(2V+8)$ to $(2V+10)$	[11:0]	12-bit unsigned integer indicating the minimum of: 1) the first sub-carrier index of the first BAT group to which non-zero bits are assigned in spatial stream 1, and 2) the first sub-carrier index of the first BAT group to which non-zero bits are assigned in spatial stream 2. It shall be an integer multiple of G (Note 6). The value of this field shall be associated with the BMAT and shall be used during partial BMAT updates (see Table 8-9).
TIDX _{MAX} for Profile 1 OFBs		[23:11]	12-bit unsigned integer indicating the maximum of: 1) the first sub-carrier index of the last BAT group to which non-zero bits are assigned in spatial stream 1, and 2) the first sub-carrier index of the last BAT group to which non-zero bits are assigned in spatial stream 2. It shall be an integer multiple of G (Note 6) and if bit-loading grouping is used ($G>1$) shall meet: $TIDX_{MAX}+G-1 \leq \text{StopSubCarrier}$, where StopSubCarrier is specified in Table 8-16.6 ("Bandplan Info Capability Value field) of [ITU-T G.9961]. Let W denote the number of BAT entries, which is $(TIDX_{MAX} - TIDX_{MIN})/G + 1$. Let Z denote the smallest integer larger than or equal to $W/2$. Let K denote the number of precoding entries (i.e., the number of precoding groups), which is the smallest integer larger than or equal to $(TIDX_{MAX} + G - TIDX_{MIN})/PG$.

Table 8-6 – Format of the MMPL of the MCE_ParamUpdate.req message

Field	Octet	Bits	Description
$B_1^{(1)}$	2V+11	[3:0]	This field shall be present if and only if the "BAT update indicator" field is set to one. It shall be represented as a 4-bit unsigned integer indicating the number of bits assigned to spatial stream 1 for sub-carrier indices from $TIDX_{MIN}$ to $TIDX_{MIN} + G - 1$ (Notes 6, 7). This field only exists if BAT_COMPRESSION field is set to 0.
		[7:4]	This field shall be present if and only if the "BAT update indicator" field is set to one. It shall be represented as a 4-bit unsigned integer indicating the number of bits assigned to spatial stream 1 for sub-carrier indices from $TIDX_{MIN} + G$ to $TIDX_{MIN} + 2G - 1$ (Notes 6, 7, 8). This field only exists if BAT_COMPRESSION field is set to 0.
...
$B_Z^{(1)}$	2V+10 + Z	[3:0]	This field shall be present if and only if the "BAT update indicator" field is set to one. It shall be represented as a 4-bit unsigned integer indicating the number of bits assigned to spatial stream 1 for sub-carrier indices from $TIDX_{MAX} - G$ to $TIDX_{MAX} - 1$ if W is even, or to sub-carrier indices $TIDX_{MAX}$ to $TIDX_{MAX} + G - 1$ if W is odd (Notes 6, 7). This field only exists if BAT_COMPRESSION field is set to 0.
		[7:4]	This field shall be present if and only if the "BAT update indicator" field is set to one. It shall be represented as a 4-bit unsigned integer indicating the number of bits assigned to spatial stream 1 for sub-carrier indices from $TIDX_{MAX}$ to $TIDX_{MAX} + G - 1$ if W is even (Notes 6, 7, 9). This field only exists if BMAT_COMPRESSION field is set to 0.
COMPRESSED_BAT ⁽¹⁾	variable	variable	Compressed information that includes the Z fields $B_i^{(1)}$. This field shall be filled using the mechanism described in clause 8.23 of [ITU-T G.9961] with a Pattern field formatted as field $B_i^{(1)}$ of this message (N=8). This field only exists if BAT_COMPRESSION field is set to one.
$B_1^{(2)}$	variable	[3:0]	This field shall be present if and only if the "BAT update indicator" field is set to one. It shall be represented as a 4-bit unsigned integer indicating the number of bits assigned to spatial stream 2 for sub-carrier indices from $TIDX_{MIN}$ to $TIDX_{MIN} + G - 1$ (Notes 6, 7). This field only exists if BAT_COMPRESSION field is set to 0.

Table 8-6 – Format of the MMPL of the MCE_ParamUpdate.req message

Field	Octet	Bits	Description
		[7:4]	This field shall be present if and only if the "BAT update indicator" field is set to one. It shall be represented as a 4-bit unsigned integer indicating the number of bits assigned to spatial stream 2 for sub-carrier indices from $TIDX_{MIN} + G$ to $TIDX_{MIN} + 2G - 1$ (Notes 6, 7, 8). This field only exists if BAT_COMPRESSION field is set to 0.
...
$B_Z^{(2)}$	variable	[3:0]	This field shall be present if and only if the "BAT update indicator" field is set to one. It shall be represented as a 4-bit unsigned integer indicating the number of bits assigned to spatial stream 2 for sub-carrier indices from $TIDX_{MAX} - G$ to $TIDX_{MAX} - 1$ if W is even, or to sub-carrier indices $TIDX_{MAX}$ to $TIDX_{MAX} + G - 1$ if W is odd (Notes 6, 7). This field only exists if BAT_COMPRESSION field is set to 0.
		[7:4]	This field shall be present if and only if the "BAT update indicator" field is set to one. It shall be represented as a 4-bit unsigned integer indicating the number of bits assigned to spatial stream 2 for sub-carrier indices from $TIDX_{MAX}$ to $TIDX_{MAX} + G - 1$ if W is even (Notes 6, 7, 9). This field only exists if BAT_COMPRESSION field is set to 0.
COMPRESSED_BAT ⁽²⁾	variable	variable	Compressed information that includes the Z fields $B_i^{(2)}$. This field shall be filled using the mechanism described in clause 8.23 of [ITU-T G.9961] with a Pattern field formatted as field $B_i^{(2)}$ of this message ($N=8$). This field only exists if BAT_COMPRESSION field is set to one.
$P_{1,\theta}$	variable	variable	This field shall be present if and only if the "precoding parameters update indicator" field is set to one (Note 13). It shall be represented as a 4-bit (Note 12) or 8-bit unsigned integer indicating the angle θ which is one of the parameters of the precoding matrix assigned to the first group of PG sub-carriers, having sub-carrier indices $TIDX_{MIN}$ to $TIDX_{MIN} + PG - 1$. The value of θ , in units of radians, is equal to either (based on the Precoding feedback quantization indicator field): $\theta = \pi(2P_\theta + 1)/64$ where: $P_\theta = P_{1,\theta} = 0 \dots 15$ (4-bit quantization), or $\theta = \pi(2P_\theta + 1)/1024$ where: $P_\theta = P_{1,\theta} = 0 \dots 255$ (8-bit quantization). This field only exists if PRECODING_COMPRESSION field is set to 0.
...

Table 8-6 – Format of the MMPL of the MCE_ParamUpdate.req message

Field	Octet	Bits	Description
$P_{K,\theta}$	variable	variable	<p>This field shall be present if and only if the "precoding parameters update indicator" field is set to one (Note 13). It shall be represented as a 4-bit (Note 12) or 8-bit unsigned integer indicating the angle θ which is one of the parameters of the precoding matrix assigned to the last group of PG sub-carriers, having sub-carrier indices $TIDX_{MIN} + PG \times (K-1)$ to $TIDX_{MIN} + PG - 1 + PG \times (K-1)$. The value of θ, in units of radians, is equal to either (based on the Precoding feedback quantization indicator field):</p> <ul style="list-style-type: none"> $\theta = \pi(2P_\theta + 1)/64$ where: $P_\theta = P_{K,\theta} = 0 \dots 15$ (4-bit quantization), or $\theta = \pi(2P_\theta + 1)/1024$ where: $P_\theta = P_{K,\theta} = 0 \dots 255$ (8-bit quantization). <p>This field only exists if PRECODING_COMPRESSION field is set to 0.</p>
COMPRESSED_ θ	variable	variable	<p>Compressed information that includes the K fields $P_{i,\theta}$. This field shall be filled using the mechanism described in clause 8.23 of [ITU-T G.9961] with a Pattern field formatted as field $P_{i,\theta}$ of this message ($N=4$ or $N=8$, depending on the value of the field Precoding feedback quantization indicator).</p> <p>This field only exists if PRECODING_COMPRESSION field is set to one.</p>
$P_{1,\phi}$	variable	variable	<p>This field shall be present if and only if the "precoding parameters update indicator" field is set to one (Note 13). It shall be represented as a 4-bit (Note 12) or 8-bit unsigned integer indicating the angle ϕ which is one of the parameters of the precoding matrix assigned to the first group of PG sub-carriers, having sub-carrier indices $TIDX_{MIN}$ to $TIDX_{MIN} + PG - 1$. The value of ϕ, in units of radians, is equal to either (based on the Precoding feedback quantization indicator field) (Note 11):</p> <ul style="list-style-type: none"> $\phi = \pi(2P_\phi + 1)/16$ where: $P_\phi = P_{1,\phi} = 0 \dots 15$ (4-bit quantization), or $\phi = \pi(2P_\phi + 1)/256$ where: $P_\phi = P_{1,\phi} = 0 \dots 255$ (8-bit quantization). <p>This field only exists if PRECODING_COMPRESSION field is set to 0.</p>
...
$P_{K,\phi}$	variable	variable	<p>This field shall be present if and only if the "precoding parameters update indicator" field is set to one (Note 13). It shall be represented as a 4-bit (Note 12) or 8-bit unsigned integer indicating the angle ϕ which is one of the parameters of the precoding matrix assigned to the last group of PG sub-carriers, having sub-carrier indices $TIDX_{MIN} + PG \times (K-1)$ to $TIDX_{MIN} + PG - 1 + PG \times (K-1)$. The value of ϕ, in units of radians, is equal to either (based on the Precoding feedback quantization indicator field) (Note 11):</p>

Table 8-6 – Format of the MMPL of the MCE_ParamUpdate.req message

Field	Octet	Bits	Description
			<ul style="list-style-type: none"> $\phi = \pi(2P_\phi + 1)/16$ where: $P_\phi = P_{K,\phi} = 0 \dots 15$ (4-bit quantization), or $\phi = \pi(2P_\phi + 1)/256$ where: $P_\phi = P_{K,\phi} = 0 \dots 255$ (8-bit quantization). <p>This field only exists if PRECODING_COMPRESSION field is set to 0.</p>
COMPRESSED_φ	variable	variable	<p>Compressed information that includes the K fields $P_{i,\phi}$. This field shall be filled using the mechanism described in clause 8.23 of [ITU-T G.9961] with a Pattern field formatted as field $P_{i,\phi}$ of this message ($N=4$ or $N=8$, depending on the value of the field Precoding feedback quantization indicator).</p> <p>This field only exists if PRECODING_COMPRESSION field is set to one.</p>

NOTE 1 – Bits that are reserved by ITU-T shall be set to zero by the transmitter and ignored by the receiver.

NOTE 2 – The transmitter shall use the proposed block size or larger block size for a new connection. Once the block size is selected for a connection, it shall not be changed throughout the lifetime of the connection (clause 8.1.3.2 of [ITU-T G.9960]).

NOTE 3 – The transmitter shall use the proposed FEC rate or lower FEC rate.

NOTE 4 – The transmitter shall use the proposed GI or longer GI value.

NOTE 5 – A new BMAT shall only be used over specified non-overlapping durations (up to 8) within a MAC cycle, defined by CE_STIME_{*i*} and CE_ETIME_{*i*} without extension.

NOTE 6 – Sub-carrier index represents the physical index (clause 7.1.4.1). All BMATs entries outside [TIDX_{MIN}, TIDX_{MAX} + G – 1] shall be considered as unloaded.

NOTE 7 – If a sub-carrier is not loaded, the field shall be set to 0 or 15.

NOTE 8 – If $W = 1$, this field shall be set to zero.

NOTE 9 – If W is an odd number, this field shall be set to zero.

NOTE 10 – The Tx port mapping matrix (TPM) that shall be used by each sub-carrier is indicated by the coding of bits in the BATs assigned to the two spatial streams of the sub-carrier, and the MIMO mode indicator, according to Table 8-2.

NOTE 11 – In the powerline medium, the cyclic shift introduces a decrement of $2 \cdot \pi \cdot T_{CS} \cdot F_{SC} = 0.098175$ radians (approximation of $\pi/32$ radians) to the angle ϕ from one sub-carrier to the next. When $PG > 1$ the value of P_ϕ shall be referred to the lowest frequency sub-carrier in the group. The transmitter shall calculate the value of ϕ for each sub-carrier of the group i ($i = 0 \dots PG - 1$) as:

- $\phi = \pi(2P'_\phi + 1)/16$, where $P'_\phi = (4P_\phi - i)/4$ for the case of 4 bit quantization
- $\phi = \pi(2P'_\phi + 1)/256$, where $P'_\phi = P_\phi - 4i$ for the case of 8 bit quantization.

NOTE 12 – For 4-bit values, 2 values are packed into each octet with 4 LSBs corresponding to the lower sub-carrier index. If K is odd, the 4 MSBs of the octet containing $P_{K,\theta}$ and $P_{K,\phi}$ shall be set to zero.

NOTE 13 – Precoding parameters are reported for all of the precoding groups, even those that include sub-carriers that are associated with Tx port mapping with no precoding.

NOTE 14 – The constant phase rotation (see Note 11) from a group to the next group shall be removed from the field $P_{i,\phi}$ before applying the compression mechanism. The first group (of the K groups) is considered as the reference (no constant phase removal needed).

NOTE 15 – It is the responsibility of the receiver to set APSD_MAX and APSD_MAX_EXT taking into account the PSD limitations and capabilities of the transmitter that are known to the receiver (see clause 7.1.5 of [ITU-T G.9960]).

Table 8-6 – Format of the MMPL of the MCE_ParamUpdate.req message

Field	Octet	Bits	Description
NOTE 16 – A new BAT shall only be used over specified non-overlapping durations (up to 32) within a MAC cycle, defined by CE_STIME _i and CE_ETIME _i with extension of NUM_VALID_DUR.			

Table 8-7 – Format of the CE_BAT_GRP

BAT_GRP_ID value (b ₁₀ b ₉ b ₈)	Description
000	Default – No BAT sub-carrier grouping ($G = 1$)
001	BAT sub-carrier grouping of 2 sub-carriers ($G = 2$)
010	BAT sub-carrier grouping of 4 sub-carriers ($G = 4$)
011	BAT sub-carrier grouping of 8 sub-carriers ($G = 8$)
100	BAT sub-carrier grouping of 16 sub-carriers ($G = 16$)
101 to 111	Reserved by ITU-T

Table 8-8 – Format of the CE_PR_GRP

PR_GRP_ID value (b ₂ b ₁ b ₀)	Description
000	Default – No precoding sub-carrier grouping ($PG = 1$)
001	Precoding sub-carrier grouping of 2 sub-carriers ($PG = 2$)
010	Precoding sub-carrier grouping of 4 sub-carriers ($PG = 4$)
011	Precoding sub-carrier grouping of 8 sub-carriers ($PG = 8$)
100	Precoding sub-carrier grouping of 16 sub-carriers ($PG = 16$)
101 to 111	Reserved by ITU-T

8.11.1.7.4 Format of MCE_ParamUpdateRequest.ind

The format of the MMPL of the MCE_ParamUpdateRequest.ind message shall be as shown in Table 8-9.

Table 8-9 – Format of the MMPL of the MCE_ParamUpdateRequest.ind message

Field	Octet	Bits	Description
Requested BMAT ID	0	[4:0]	This field indicates the BMAT_ID for which the transmitter requests retransmission of the channel estimation result. It shall be formatted as shown in Table 7-3.
Reserved		[7:5]	Reserved by ITU-T (Note).
NOTE – Bits that are reserved by ITU-T shall be set to zero by the transmitter and ignored by the receiver.			

8.11.1.7.5 Format of MCE_PartialBmatUpdate.req

The format of the MMPL of the MCE_PartialBmatUpdate.req message shall be as shown in Table 8-10.

Table 8-10 – Format of the MMPL of the MCE_PartialBmatUpdate.req message

Field	Octet	Bits	Description
O_BMAT_ID	0	[4:0]	This field indicates the BMAT_ID associated with the BMAT to be updated by the PBMU request. It shall be formatted as shown in Table 7-3.
Reserved		[7:5]	Reserved by ITU-T (Note).
N_BMAT_ID	1	[4:0]	This field indicates the BMAT_ID associated with the BMAT updated by the PBMU request. It shall be formatted as shown in Table 7-3.
Reserved		[7:5]	Reserved by ITU-T (Note).
NUM_BAT_ENT for Profile 1 OFBs	2 and 3	[9:0]	This field indicates the number of BAT entries to be updated (V). The valid range of this field is from 0 ($V=1$) to 1023 ($V=1024$). For Profile 2 OFBs, this field shall be set to zero.
Reserved		[15:10]	Reserved by ITU-T (Note).
NUM_PG_ENT	4 and 5	[9:0]	This field indicates the number of precoding group entries to be updated (Q). The valid range of this field is from 0 ($Q=1$) to 1023 ($Q=1024$). Whenever the "Precoding feedback update indicator" field is set to 0 this field shall be ignored by the receiver of the message.
BAT SS 1 update indicator		[10]	0, when the BAT of SS 1 is not updated in the message, i.e., the BAT fields, $B_{T1}^{(1)}, \dots, B_{Tv}^{(1)}$ (including the reserved fields in the relevant octets) are not present in the message 1, when the BAT of SS 1 is updated in the message, i.e., the BAT fields are present in the message.
BAT SS 2 update indicator		[11]	0, when the BAT of SS 2 is not updated in the message, i.e., the BAT fields, $B_{T1}^{(2)}, \dots, B_{Tv}^{(2)}$ (including the reserved fields in the relevant octets) are not present in the message 1, when the BAT of SS 2 is updated in the message, i.e., the BAT fields are present in the message.
Precoding feedback update indicator		[12]	0, when the precoding parameters are not updated in the message, i.e., the precoding parameters fields, $PT_1, P_{\theta, PT1}, P_{\phi, PT1}, \dots, PT_Q, P_{\theta, PTQ}, P_{\phi, PTQ}$ are not present in the message 1, when the precoding parameters are updated in the message, i.e., the precoding parameters fields are present in the message This field shall be set to 0 in case the "MIMO mode indicator" field associated with the O_BMAT_ID is set to 0.
Precoding feedback quantization indicator		[13]	0, when $P_{i,\theta}$ and $P_{i,\phi}$ are quantized as 4-bit values 1, when $P_{i,\theta}$ and $P_{i,\phi}$ are quantized as 8-bit values Whenever the "Precoding feedback update indicator" field is set to 0 this field shall be ignored by the receiver of the message. The quantization value shall be the same as one associated with O_BMAT_ID.
Reserved		[15:14]	Reserved by ITU-T (Note).

Table 8-10 – Format of the MMPL of the MCE_PartialBmatUpdate.req message

Field	Octet	Bits	Description
2SS BAT entry descriptor[V]	variable	[23:0]	This field shall be present if and only if both the fields "BAT SS 1 update indicator" and "BAT SS 2 update indicator" are set to one. It shall be formatted as shown in Table 8-10.
1SS BAT entry descriptor[V]	variable	[15:0]	This field shall be present if and only if exactly one of the fields "BAT SS 1 update indicator" and "BAT SS 2 update indicator" is set to one. It shall be formatted as shown in Table 8-11.
Precoding entry descriptor[Q]	variable	variable	This field shall be present if and only if the "precoding parameters update indicator" field is set to one. It shall be formatted as shown in Table 8-12.
NOTE – Bits that are reserved by ITU-T shall be set to zero by the transmitter and ignored by the receiver.			

Table 8-11 – Format of the 2SS BAT entry descriptor

Field	Octet	Bits	Description
T_i	0 to 2	[11:0]	This field shall be represented as a 12-bit unsigned integer indicating the sub-carrier index (Note 1). It shall be an integer multiple of G . $T_i = TIDXmin + \max(G, PG) * I$; where I is an integer (Note 2) and $TIDXmin$ is the value associated with the O_BMAT_ID (see Table 8-9).
$B_{T_i}^{(1)}$		[15:12]	This field shall be represented as a 4-bit unsigned integer indicating the number of bits assigned to spatial stream 1 for sub-carrier indices from T_i to $T_i + G - 1$.
$B_{T_i}^{(2)}$		[19:16]	This field shall be represented as a 4-bit unsigned integer indicating the number of bits assigned to spatial stream 2 for sub-carrier indices from T_i to $T_i + G - 1$.
Reserved		[23:20]	Reserved by ITU-T (Note 3).
<p>NOTE 1 – Sub-carrier index represents the physical index (see clause 7.1.4.1). NOTE 2 – Values of T_i less than $TIDXmin$ may be selected by using a negative value of I. NOTE 3 – Bits that are reserved by ITU-T shall be set to zero by the transmitter and ignored by the receiver.</p>			

Table 8-12 – Format of the 1SS BAT entry descriptor

Field	Octet	Bits	Description
T_i	0 to 1	[11:0]	This field shall be represented as a 12-bit unsigned integer indicating the sub-carrier index (Note 1). $T_i = TIDXmin + \max(G, PG) * I$; where I is an integer (Note 2) and $TIDXmin$ is the value associated with the O_BMAT_ID (see Table 8-5).
$B_{T_i}^{(k)}$		[15:12]	This field shall be represented as a 4-bit unsigned integer indicating the number of bits assigned to spatial stream k for sub-carrier indices from T_i to $T_i + G - 1$. The value of k is: 1 if the field "BAT SS 1 update indicator" is set to one. 2 if the field "BAT SS 2 update indicator" is set to one.
<p>NOTE 1 – Sub-carrier index represents the physical index (see clause 7.1.4.1). NOTE 2 – Values of T_i less than $TIDXmin$ may be selected by using a negative value of I.</p>			

Table 8-13 – Format of the Precoding entry descriptor

Field	Octet	Bits	Description
PT _i	0 and 1	[11:0]	This field shall represent 12-bit unsigned integer indicating the sub-carrier index (Note 1). PT _i =TIDXmin+PG*I; where I is an integer (Note 2) and TIDXmin is the value associated with the O_BMAT_ID (see Table 8-5).
Reserved		[15:12]	Reserved by ITU-T.
P _{θ, PTi}	Variable	variable	This field shall represent a 4-bit or 8-bit unsigned integer indicating the angle θ, which is one of the parameters of the precoding matrix assigned to a group of PG sub-carriers with indices PT ₁ to PT _i +PG-1. The value of θ, in units of radians, is equal to either (based on the Precoding feedback quantization indicator field) (Note 3): <ul style="list-style-type: none"> • $\theta = \pi(2P_{\theta} + 1)/64$ where: P_θ = P_{θ, PTi} = 0...15 (4-bit quantization), or • $\theta = \pi(2P_{\theta} + 1)/1024$ where: P_θ = P_{θ, PTi} = 0...255 (8-bit quantization).
P _{φ, PTi}	Variable	Variable	This field shall represent a 4-bit or 8-bit unsigned integer indicating the angle φ, which is one of the parameters of the precoding matrix assigned to a group of PG sub-carriers with indices PT ₁ to PT _i +PG-1. The value of φ, in units of radians, is equal to either (based on the Precoding feedback quantization indicator field) (Notes 3, 4): <ul style="list-style-type: none"> • $\phi = \pi(2P_{\phi} + 1)/16$ where: P_φ = P_{φ, PTi} = 0...15 (4-bit quantization), or • $\phi = \pi(2P_{\phi} + 1)/256$ where: P_φ = P_{φ, PTi} = 0...255 (8-bit quantization).

NOTE 1 – Sub-carrier index represents the physical index (see clause 7.1.4.1).

NOTE 2 – Values of PT less than TIDXmin may be selected by using a negative value of I.

NOTE 3 – For 4-bit quantization, the size of precoding entry descriptor is 3 bytes. For 8-bit quantization, the size of precoding entry descriptor is 4 bytes.

NOTE 4 – In the powerline medium, the cyclic shift introduces a decrement of $2*\pi*T_{CS}*F_{SC} = 0.098175$ radians (approximation of $\pi/32$ radians) to the angle φ from one sub-carrier to the next. When PG > 1 the value of P_φ shall be referred to the lowest frequency sub-carrier in the group. The transmitter shall calculate the value of φ for each sub-carrier of the group *i* (*i* = 0 ... PG-1) as:

- $\phi = \pi(2P'_{\phi} + 1)/16$, where $P'_{\phi} = (4P_{\phi} - i)/4$ for the case of 4 bit quantization.
- $\phi = \pi(2P'_{\phi} + 1)/256$, where $P'_{\phi} = P_{\phi} - 4i$ for the case of 8 bit quantization.

8.11.1.7.6 Format of MCE_ACESymbols.ind

The format of the MMPL of the MCE_ACESymbols.ind message shall be as shown in Table 8-13.

Table 8-14 – Format of the MMPL of the MCE_ACESymbols.ind message

Field	Octet	Bits	Description
ACE symbols	0	[2:0]	This field indicates the number of ACE symbols added to the beginning of the payload of all frames that are allowed to carry ACE symbols where the MIMO_IND flag in the PFH is set to one. It shall be formatted as shown in Table 7-16 of [ITU-T G.9960]. For MIMO transmission, the valid range is 1 to 7 (in MIMO transmission at least one ACE symbol is attached, as described in clause 7.1.4.4.4.3).
Reserved		[7:3]	Reserved by ITU-T (Note).
NOTE – Bits that are reserved by ITU-T shall be set to zero by the transmitter and ignored by the receiver.			

8.11.1.7.7 Format of MCE_ProbeSlotAssign.cnf

The format of the MMPL of the MCE_ProbeSlotAssign.cnf message shall be as shown in Table 8-15.

Table 8-15 – Format of the MMPL of the MCE_ProbeSlotAssign.cnf message

Field	Octet	Bits	Description
Transmitter ID	0	[7:0]	The DEVICE_ID of the node requesting the bandwidth allocation for PROBE frame transmissions.
Receiver ID		[7:0]	The DEVICE_ID of the receiver that initiated the channel estimation procedure.
CE_BMAT_ID	2	[4:0]	This field indicates the BMAT_ID associated with the runtime BMAT to which bandwidth was required for probing.
Request Status		[7:5]	0 – Bandwidth request is confirmed (Note) 1 – Request is rejected 2 to 7 – Reserved by ITU-T.
NOTE – Bandwidth allocation will be identified in the MAP using the transmitter ID (SID), receiver ID (DID) and channel estimation only indication set in the TXOP attributes extension (see clause 8.8.4.1.1).			

8.11.1.7.8 Format of MCE_ProbeSlotRelease.cnf

The format of the MMPL of the MCE_ProbeSlotRelease.cnf message shall be as shown in Table 8-16.

Table 8-16 – Format of the MMPL of the MCE_ProbeSlotRelease.cnf message

Field	Octet	Bits	Description
Transmitter ID	0	[7:0]	The DEVICE_ID of the node requesting the bandwidth allocation for PROBE frame transmissions.
Receiver ID	1	[7:0]	The DEVICE_ID of the receiver node in the channel estimation procedure.
CE_BMAT_ID	2	[4:0]	This field indicates the BMAT_ID associated with the runtime BMAT for which the bandwidth has to be released.
Request Status		[7:5]	0 – Request is confirmed 1 – Request is rejected (unknown BMAT identity) (Note) 2 to 7 – Reserved by ITU-T.
NOTE – There is no bandwidth allocated for the identified channel estimation procedure. The identification is defined by the Transmitter_ID, Receiver_ID, CE_BMAT_ID.			

8.11.1.7.9 Format of MCE_ParamUpdate.cnf

The format of the MMPL of the MCE_ParamUpdate.cnf message shall be as shown in Table 8-17.

Table 8-17 – Format of the MMPL of the MCE_ParamUpdate.cnf message

Field	Octet	Bits	Description
New BMAT ID	0	[4:0]	This field indicates the BMAT_ID specified in the received MCE_ParamUpdate.req message.
Reserved		[7:5]	Reserved by ITU-T (Note).
NUM_AVAIL_BM ATS_NO_PREC	1	[3:0]	This field contains the number of available runtime BMATs, assuming $G = 1$ and no precoding, that this node (SID) can support when transmitting to the destination node (DID). It excludes the BMAT associated with the CE_BMAT_ID. Valid values are from 0 to 12.
NUM_AVAIL_BM ATS_PREC		[7:4]	This field contains the number of available runtime BMATs, assuming $G = 1$ and $PG = 1$ (with the precoding parameters quantized to 8 bits), that this node (SID) can support when transmitting to the destination node (DID). It excludes the BMAT associated with the New BMAT ID. Valid values are from 0 to 12.
Request Status	2	[2:0]	0 – BMAT successfully updated 1 – Update is rejected (no more resources) 2 – Update is rejected (New BMAT ID already exists) 3 to 7 – Reserved by ITU-T.
Reserved		[7:3]	Reserved by ITU-T (Note).
NOTE – Bits that are reserved by ITU-T shall be set to zero by the transmitter and ignored by the receiver.			

8.11.1.7.10 Format of MCE_PartialBmatUpdate.cnf

The format of the MMPL of the MCE_PartialBmatUpdate.cnf message shall be as shown in Table 8-18.

Table 8-18 – Format of the MMPL of the MCE_PartialBmatUpdate.cnf message

Field	Octet	Bits	Description
CE_BMAT_ID	0	[4:0]	This field indicates the CE_BMAT_ID specified in the MCE_PartialBmatUpdate.req message.
Reserved		[7:5]	Reserved by ITU-T (Note).
NUM_AVAIL_BMAT_NO_PREC	1	[3:0]	This field contains the number of available runtime BMATs, assuming $G = 1$ and no precoding, that this node (SID) can support when transmitting to the destination node (DID). It excludes the BMAT associated with the CE_BMAT_ID. Valid values are from 0 to 12.
NUM_AVAIL_BMAT_PREC		[7:4]	This field contains the number of available runtime BMATs, assuming $G = 1$ and $PG = 1$ (with the precoding parameters quantized to 8 bits), that this node (SID) can support when transmitting to the destination node (DID). It excludes the BMAT associated with the CE_BMAT_ID. Valid values are from 0 to 12.
Request Status	2	[2:0]	0 – BMAT successfully updated 1 – Request rejected (no more resources) 2 – Request rejected (O_BMAT_ID does not exist) 3 – Request rejected (N_BMAT ID already exist) 4 to 7 – Reserved by ITU-T.
Reserved		[7:3]	Reserved by ITU-T (Note).
NOTE – Bits that are reserved by ITU-T shall be set to zero by the transmitter and ignored by the receiver.			

8.11.1.7.11 Format of MCE_Request.ind

The format of the MMPL of the MCE_Request.ind message shall be as shown in Table 8-19.

Table 8-19 – Format of the MMPL of the MCE_Request.ind message

Field	Octet	Bits	Description
CE_WINDOW_SEL	0	[0]	This field shall be set to one if the transmitter selects the channel estimation window. It shall be set to zero, otherwise. If this field is set to zero, then CE_STIME and CE_ETIME shall be set to 00 ₁₆ and these values shall be ignored by the receiver.
Reserved		[7:1]	Reserved by ITU-T (Note).
CE_STIME	1	[7:0]	This field indicates time at which the transmitter can start PROBE frame transmissions and it shall be coded as shown in Table 8-98 of [ITU-T G.9961].
CE_ETIME	2	[7:0]	This field indicates time at which the transmitter shall end PROBE frame transmissions and it shall be coded as shown in Table 8-99 of [ITU-T G.9961].
NOTE – Bits that are reserved by ITU-T shall be set to zero by the transmitter and ignored by the receiver.			

8.11.1.7.12 Format of MCE_Initiation.req

The format of the MMPL of the MCE_Initiation.req message shall be as shown in Table 8-20.

Table 8-20 – Format of the MMPL of the MCE_Initiation.req message

Field	Octet	Bits	Description
CE_BMAT_ID	0 and 1	[4:0]	This field indicates the BMAT_ID associated with the runtime BMAT to be created by channel estimation. It shall be formatted as shown in Table 7-3.
CE_BAT_GRP		[7:5]	This field indicates the value of BAT sub-carrier grouping. It shall be formatted as shown in Table 8-7.
CE_PR_GRP		[10:8]	This field indicates the value of precoding sub-carrier grouping. It shall be formatted as shown in Table 8-8.
Reserved		[15:11]	Reserved by ITU-T (Note).
CE_STIME	2	[7:0]	This field indicates time at which the transmitter can start PROBE frame transmissions and it shall be coded as shown in Table 8-98 of [ITU-T G.9961].
CE_ETIME	3	[7:0]	This field indicates time at which the transmitter shall end PROBE frame transmissions and it shall be coded as shown in Table 8-99 of [ITU-T G.9961].
CE_PRB_RQST	4	[0]	This field shall be set to one if the receiver wants PROBE frames along with channel estimation initiation confirmation. It shall be set to zero otherwise.
Reserved		[7:1]	Reserved by ITU-T (Note).
CE_PRB_PARM	5 to 9	[39:0]	This field specifies a set of parameters for PROBE frame. It shall be coded as shown in Table 8-23. This field shall be set to 000000 ₁₆ if CE_PRB_RQST is set to zero.
NOTE – Bits that are reserved by ITU-T shall be set to zero by the transmitter and ignored by the receiver.			

8.11.1.7.13 Format of MCE_Initiation.cnf

The format of the MMPL of the MCE_Initiation.cnf message is shown in Table 8-21.

Table 8-21 – Format of the MMPL of the MCE_Initiation.cnf message

Field	Octet	Bits	Description
CE_BMAT_ID	0 and 1	[4:0]	This field indicates the BMAT_ID associated with the runtime BAT to be created by channel estimation. It shall be formatted as shown in Table 7-3.
CE_BAT_GRP		[7:5]	This field indicates the value of BAT sub-carrier grouping. It shall be formatted as shown in Table 8-7.
CE_PR_GRP		[10:8]	This field indicates the value of precoding sub-carrier grouping. It shall be formatted as shown in Table 8-8.
Reserved		[15:11]	Reserved by ITU-T (Note).
NUM_AVAIL_B MATS_NO_PREC	2	[3:0]	This field contains the number of available runtime BMATs, assuming $G = 1$ and no precoding, that this node (SID) can support when transmitting to the destination node (DID). It excludes the BMAT associated with the CE_BMAT_ID. Valid values are from 0 to 12.

Table 8-21 – Format of the MMPL of the MCE_Initiation.cnf message

Field	Octet	Bits	Description
NUM_AVAIL_B MATS_PREC		[7:4]	This field contains the number of available runtime BMATs, assuming $G = 1$ and $PG = 1$ (with the precoding parameters quantized to 8 bits), that this node (SID) can support when transmitting to the destination node (DID). It excludes the BMAT associated with the CE_BMAT_ID. Valid values are from 0 to 12.
Request Status	3	[2:0]	0 – Channel estimation initiation is confirmed 1 – Rejected (CE_BMAT_ID is valid and currently in use) 2 – Rejected (Bandwidth for PROBE frame transmission is not available) 3 – Rejected (Bandwidth request for probe frame transmission is pending) 4 – Rejected (Channel estimation window is currently not available) 5 to 7 – Reserved by ITU-T (Note).
Reserved		[7:3]	Reserved by ITU-T (Note).
NOTE – Bits that are reserved by ITU-T shall be set to zero by the transmitter and ignored by the receiver.			

8.11.1.7.14 Format of MCE_ProbeRequest.ind

The format of the MMPL of the MCE_ProbeRequest.ind message shall be as shown in Table 8-22.

Table 8-22 – Format of the MMPL of the MCE_ProbeRequest.ind message

Field	Octet	Bits	Description
CE_BMAT_ID	0	[4:0]	This field indicates the BMAT_ID associated with the runtime BMAT to be created by channel estimation. It shall be formatted as shown in Table 7-3.
CE_PRB_DEFAULT _IND		[5]	When this field is set to one, the parameters provided in this message (CE_PRB_PARM) replace the existing parameters for the default PROBE frame for this node (SID) when receiving from the destination node (DID).
Reserved		[7:6]	Reserved by ITU-T (Note).
CE_PRB_PARM	1 to 5	[39:0]	See Table 8-23.
NOTE – Bits that are reserved by ITU-T shall be set to zero by the transmitter and ignored by the receiver.			

Table 8-23 – Format of the CE_PRB_PARM field

Field	Octet	Bits	Description
CE_PR_PRBTYPE	0	[3:0]	This field indicates the PRBTYPE requested by the receiver. It shall be formatted as shown in Table 7-8.
CE_PR_PRBFN		[7:4]	This field indicates the number of PROBE frames that shall be sent by the transmitter at each request for PROBE frame transmission. The field shall be coded as shown in Table 8-103 of [ITU-T G.9961]. The transmitter may send multiple PROBE frames within a single channel estimation window.
CE_PR_PRBSYM	1	[3:0]	This field indicates the PRBSYM requested by the receiver. It shall be formatted as shown in Table 7-41 of [ITU-T G.9960].
CE_PR_PRBGI		[6:4]	This field indicates the PRBGI requested by the receiver. It shall be formatted as shown in Table 7-14 of [ITU-T G.9960].
Reserved		[7]	Reserved by ITU-T (Note 1).
CE_PR_APSD_MAX	2	[4:0]	This field indicates the APSD_MAX-P requested by the receiver. It shall be formatted as described in clause 7.1.2.3.2.7.4. (Note 3)
CE_PR_APSD_MAX_EXT		[5]	This field indicates the APSD_MAX_EXT-P requested by the receiver. It shall be formatted as described in clause 7.1.2.3.2.7.1.7 of [ITU-T G.9960]. (Note 3)
Reserved		[7:6]	Reserved by ITU-T (Note 1).
PRB_BMAT_ID	3	[4:0]	This field indicates the BMAT_ID (predefined or runtime) whose MAT shall be used by the transmitter of the PROBE frame in the Tx port mapper in case a 2 SS channel estimation PROBE frame is requested in the CE_PR_PRBTYPE field. The BMAT_ID indicated in this field shall be a valid BMAT_ID. If this field conveys a predefined BMAT_ID, the valid values for channel estimation shall be 3, 7 and 11. This field is only valid if 2 SS channel estimation PROBE is requested in the CE_PR_PRBTYPE field (PRBTYPE = 1000 ₂). Otherwise, this field shall be set to 0 and ignored by the receiver.
Reserved		[7:5]	Reserved by ITU-T (Note).
CE_PR_NUM_SILENT_SYM	4	[5:0]	This field indicates the number of silent symbols requested by the receiver. It shall be formatted as described in clause 7.1.2.3.2.7.2.3.3. This field is only valid if 2 SS channel estimation PROBE is requested in the CE_PR_PRBTYPE field (PRBTYPE = 1000 ₂). Otherwise, this field shall be set to 0 and ignored by the receiver (Note 2).

Table 8-23 – Format of the CE_PRB_PARM field

Field	Octet	Bits	Description
Reserved		[7:6]	Reserved by ITU-T (Note 1).
NOTE 1 – Bits that are reserved by ITU-T shall be set to zero by the transmitter and ignored by the receiver.			
NOTE 2 – First (CE_PR_PRBSYM – CE_PR_NUM_SILENT_SYM) symbols of the 2 SS channel estimation PROBE frame are normal (non-silent) probe symbols.			
NOTE 3 – It is the responsibility of the receiver to set CE_PR_APSD_MAX and CE_PR_APSD_MAX_EXT taking into account the PSD limitations and capabilities of the transmitter that are known to the receiver (see clause 7.1.5).			

8.11.1.7.15 Format of MCE_Cancellation.req

The format of the MMPL of the MCE_Cancellation.req message shall be as shown in Table 8-24.

Table 8-24 – Format of the MMPL of the MCE_Cancellation.req message

Field	Octet	Bits	Description
CE_BMAT_ID	0	[4:0]	This field indicates the channel estimation identifier that is cancelled. It shall be formatted as shown in Table 7-3.
USE_RCM		[5]	When set to one it means the transmitter may use RCM with parameters communicated in the New block size, New FEC rate, Bandplan ID and Repetitions fields. It shall be set to zero otherwise.
Reserved		[7:6]	Reserved by ITU-T (Note).
New block size	1	[1:0]	When USE_RCM is set to one this field indicates the proposed BLKSZ associated to RCM. It shall be formatted as shown in Table 7-7 of [ITU-T G.9960]. It shall be set to 00 ₂ otherwise.
New FEC rate		[4:2]	When USE_RCM is set to one this field indicates the proposed FEC_RATE associated to RCM. It shall be formatted as shown in Table 7-12 of [ITU-T G.9960]. It shall be set to 000 ₂ otherwise.
OFB ID		[7:5]	When USE_RCM is set to one this field indicates the OFB based on which the RCM parameters are proposed. It shall be formatted as shown in Table 7-11 of [ITU-T G.9960]. It shall be set to 000 ₂ otherwise.
Repetitions	2	[2:0]	When USE_RCM is set to one this field indicates the proposed number of repetitions associated with RCM. It shall be formatted as shown in Table 7-9 of [ITU-T G.9960]. It shall be set to 000 ₂ otherwise.
RCM_BAT_ID		[3]	When USE_RCM is set to one, this field indicates the predefined BAT associated with RCM. It shall be set to the following value: zero, when predefined BAT Type 1 is used one, when predefined BAT Type 2 is used.
Reserved		[7:4]	Reserved by ITU-T (Note).

Table 8-24 – Format of the MMPL of the MCE_Cancellation.req message

Field	Octet	Bits	Description
RCM_GI_ID	3	[2:0]	When USE_RCM is set to one, this field indicates the GI_ID associated with RCM. It shall be formatted as shown in Table 7-14 of [ITU-T G.9960].
Reserved		[7:3]	Reserved by ITU-T (Note).
NOTE – Bits that are reserved by ITU-T shall be set to zero by the transmitter and ignored by the receiver.			

8.11.1.7.16 Format of MCE_BmatIdMaintain.ind

The format of the MMPL of the MCE_BmatIdMaintain.ind message shall be as shown in Table 8-25.

Table 8-25 – Format of the MMPL of the MCE_BmatIdMaintain.ind message

Field	Octet	Bits	Description
VALID_BMAT_ID	0 and 1	[15:0]	This field contains a bitmap indicating which runtime BMATs are valid for this node (SID) when receiving from the destination node (DID). Each bit is associated with one runtime BMAT. Bit 0 of the VALID_BMAT_ID shall be set if runtime BMAT_ID 16 is valid. Bit 11 of the VALID_BMAT_ID shall be set if runtime BMAT_ID 27 is valid.
NUM_TX_AVAIL_BMATS_NO_PREC	2	[3:0]	This field contains the number of available runtime BMATs, assuming $G = 1$ and no precoding, that this node (SID) can support when transmitting to the destination node (DID). Valid values are from 0 to 12.
NUM_TX_AVAIL_BMATS_PREC		[7:4]	This field contains the number of available runtime BMATs, assuming $G = 1$ and $PG = 1$ (with the precoding parameters quantized to 8 bits), that this node (SID) can support when transmitting to the destination node (DID). Valid values are from 0 to 12.
New block size	3	[1:0]	This field indicates the proposed BLKSZ associated with RCM, if there is no available runtime BAT (Note 2). It shall be formatted as shown in Table 7-7 of [ITU-T G.9960]. It shall be set to 0 otherwise.
New FEC rate		[4:2]	This field indicates the proposed FEC_RATE associated with RCM, if there is no available runtime BAT (Note 2). It shall be formatted as shown in Table 7-12 of [ITU-T G.9960]. It shall be set to 0 otherwise.
OFB ID		[7:5]	This field indicates the OFB based on which the RCM parameters are proposed, if there is no available runtime BAT (Note 2). It shall be formatted as shown in Table 7-11 of [ITU-T G.9960]. It shall be set to 0 otherwise.
Repetitions	4	[2:0]	This field indicates the proposed number of repetitions associated with RCM, if there is no available runtime BAT (Note 2). It shall be formatted as shown in Table 7-9 of [ITU-T G.9960]. It shall be set to 0 otherwise.

Table 8-25 – Format of the MMPL of the MCE_BmatIdMaintain.ind message

Field	Octet	Bits	Description
RCM_BAT_ID		[3]	This field indicates the predefined BAT associated with RCM, if there is no available runtime BAT (Note 2). It shall be set to the following value: zero, when predefined BAT Type 1 is used one, when predefined BAT Type 2 is used.
Reserved		[7:4]	Reserved by ITU-T (Note 1).
RCM_GI_ID	5	[2:0]	This field indicates the GI_ID associated with RCM, if there is no available runtime BAT (Note 2). It shall be formatted as shown in Table 7-14 of [ITU-T G.9960].
Reserved		[7:3]	Reserved by ITU-T (Note 1).
NOTE 1 – Bits that are reserved by ITU-T shall be set to zero by the transmitter and ignored by the receiver.			
NOTE 2 – Runtime BATs might only be available for specified time periods (see Table 8-93).			

8.11.1.7.17 Format of MCE_Cancellation.cnf

The format of the MMPL of the MCE_Cancellation.cnf message shall be as shown in Table 8-26.

Table 8-26 – Format of the MMPL of the MCE_Cancellation.cnf message

Field	Octet	Bits	Description
CE_BMAT_ID	0	[4:0]	This field indicates the BMAT_ID specified in the received MCE_Cancellation.req message.
Request Status		[7:5]	0 – Channel estimation is successfully cancelled. 1 – No ongoing channel estimation for this CE_BMAT_ID. 2 to 7 – Reserved by ITU-T (Note).
NOTE – Bits that are reserved by ITU-T shall be set to zero by the transmitter and ignored by the receiver.			

8.12 Connection management

See clause 8.12 of [ITU-T G.9961].

8.13 Message flooding

See clause 8.13 of [ITU-T G.9961].

8.14 Operation in the presence of neighbouring domains – Distributed domain coordination (NDIM)

See clause 8.14 of [ITU-T G.9961].

8.15 Coexistence with alien power-line networks

See clause 8.15 of [ITU-T G.9961].

8.16 PHY multicast binding protocol

PHY multicast binding is specified for the case of a single SS. The transmitter may use either of the following two transmission schemes when transmitting to the PHY multicast group (see Note in Table 7-1):

- ITU-T G.9960 transmission
- MIMO transmission with the payload created as a single SS

Transmissions to a PHY multicast group using two spatial streams (i.e., MIMO modes 0, 1 and 2) are for further study.

See clause 8.16 of [ITU-T G.9961].

8.17 DLL multicast stream

See clause 8.17 of [ITU-T G.9961].

8.18 Inter-OFB interoperability

See clause 8.18 of [ITU-T G.9961].

8.19 Node information and capabilities exchange

See clause 8.19 of [ITU-T G.9961].

8.20 Metrics acquisition

See clause 8.20 of [ITU-T G.9961].

8.21 Operation in power saving modes

See clause 8.21 of [ITU-T G.9961].

8.22 Layer 2 configuration and management protocol (LCMP)

See clause 8.22 of [ITU-T G.9961].

8.23 MIMO transmission

As stated in previous clauses, a MIMO transceiver shall be capable of transmitting using the following two transmission schemes:

- ITU-T G.9960 transmission based on the reference models and PHY frame format defined in [ITU-T G.9960].
- MIMO transmission based on the reference models and PHY frame format defined in ITU-T G.9963.

The following subclauses deal with MIMO transmission only and describe the different operation modes in the two cases of MIMO transmission: the case where the payload is created as a single spatial stream (SS), and the case in which the payload is created as two SSs.

8.23.1 MIMO transmission, payload created as one spatial stream

MIMO transmission with the payload created as a single SS (cases 4b, 5, 6, 7 in Table 7-1) can be done either by using predefined BATs or using runtime BATs. These transmissions are done using the MIMO transmission scheme with a single spatial stream as described in clause 7.1.2.1 and using *TPM#1* as defined in clause 7.1.4.4.1.2.

8.23.2 MIMO transmission, payload created as two spatial streams

MIMO transmission with the payload created as two SSs can be done in one of two ways: either using predefined BMATs (which use a predefined BAT and a predefined Tx port mapping), or using runtime BMATs, as described in clause 7.1.2.3.2.2.8.

The various options of MIMO transmission with the payload created as two SSs using predefined BMATs are specified in Table 7-3 of clause 7.1.2.3.2.2.8. This includes:

- Single port transmissions, with *TPM#3* (for transmissions through Tx port 1) or *TPM#4* (for transmissions through Tx port 2), BMAT_IDs 0 to 7.
- Transmissions over the two Tx ports, with *TPM#0*, BMAT_IDs 8 to 11.

MIMO transmission with the payload created as two SSs using runtime BMATs, is done using one of three modes of operation specified hereafter. These modes of operation specify the transmission parameters used to generate the transmitted signal. These modes refer to the entire set of sub-carriers and not a specific sub-carrier. Two of the specified modes require feedback from the receiver to the transmitter, hence are referred to as "closed loop" modes, while one mode does not require such a feedback, hence is referred to as an "open loop" mode.

The following modes of operation are defined:

- 1) Mode 0:
 - Open loop
 - Tx port mapping: In this case no precoding is applied. For sub-carriers with bits from either the encoded payload block or the LFSR loaded on two SSs,
 - if both BATs use values in the range 0 to 12 for both spatial streams, *TPM#0* is used; or
 - if the BAT for SS 1 uses the special value 15, *TPM #4* is used; or
 - if the BAT for SS 2 uses the special value 15, *TPM #3* is used.
- 2) Mode 1:
 - Closed loop
 - Tx port mapping: For sub-carriers with bits from either the encoded payload block or the LFSR loaded on two SSs,
 - if both BATs use values in the range 0 to 12 for both spatial streams, *TPM#5* is used; or
 - if the BAT for SS 1 uses the special value 15, *TPM #7* is used; or
 - if the BAT for SS 2 uses the special value 15, *TPM #6* is used.
- 3) Mode 2:
 - Closed loop
 - Tx port mapping: For sub-carriers with bits from either the encoded payload block or the LFSR loaded on two SSs,
 - if both BATs use values in the range 0 to 12 for both spatial streams, *TPM#5* is used; or
 - if the BAT for SS 1 uses the special value 15, *TPM #4* is used; or
 - if the BAT for SS 2 uses the special value 15, *TPM #3* is used.

The mode of operation, which is associated with a specific BMAT_ID, is indicated by the "MIMO mode indicator" field in the MCE_ParamUpdate.req message (see Table 8-6).

The BATs for all of these modes are used to code the Tx port information for each sub-carrier, described above, for the three operational modes, in the way described in the following table:

Table 8-27 – Tx port mapping matrix for a specific sub-carrier

Coding of the bit loading in the BAT		MIMO mode		
Spatial stream 1	Spatial stream 2	Mode 0	Mode 1	Mode 2
$0 \leq x_1 \leq 12$	$0 \leq x_2 \leq 12$	<i>TPM</i> #0	<i>TPM</i> #5	<i>TPM</i> #5
15	$0 \leq x_2 \leq 12$	<i>TPM</i> #4	<i>TPM</i> #7	<i>TPM</i> #4
$0 \leq x_1 \leq 12$	15	<i>TPM</i> #3	<i>TPM</i> #6	<i>TPM</i> #3

NOTE – Combinations of x_1 and x_2 not listed in the table are not valid.

The receiver determines the mode of operation. This mode is associated with a specific *BMAT_ID*.

When operating in Mode 0, the receiver sends to the transmitter an *MCE_ParamUpdate.req* or *MCE_PartialBmatUpdate.req* message (as part of the channel estimation procedure, see clause 8.11.1), which includes, the following parameters:

- The "MIMO mode indicator" (included only in the *MCE_ParamUpdate.req* message).
- BATs for the two SSs.
- BAT grouping (*G*).

When operating in Mode 1 or Mode 2, the receiver sends to the transmitter an *MCE_ParamUpdate.req* or *MCE_PartialBmatUpdate.req* message, which includes the following parameters in addition to the parameters mentioned previously for Mode 0:

- Precoding angles.
- Precoding grouping (*PG*).

8.24 Run-length compression of fields of management messages

See clause 8.23 of [ITU-T G.9961].

8.25 Payload compression in management messages

See clause 8.24 of [ITU-T G.9961].

8.26 TLV pool

See clause 8.25 of [ITU-T G.9961].

9 Security

See clause 9 of [ITU-T G.9961].

Annex A

Regional requirements for North America

(This annex forms an integral part of this Recommendation.)

See Annex A of [ITU-T G.9960].

Annex B

(This annex forms an integral part of this Recommendation.)

See Annex B of [ITU-T G.9960].

NOTE – Annex B of [ITU-T G.9960] was intentionally left blank.

Annex C

Regional requirements for Japan

(This annex forms an integral part of this Recommendation.)

See Annex C of [ITU-T G.9960].

Annex D

International amateur radio bands

(This annex forms an integral part of this Recommendation.)

See Annex D of [ITU-T G.9964].

Annex E

Impact of ITU-T G.9960 on VDSL2 service

(This annex forms an integral part of this Recommendation.)

See Annex E of [ITU-T G.9964].

Annex F

(This annex has been intentionally left blank.)

Annex G

Test vectors

(This annex forms an integral part of this Recommendation.)

See Annex G of [ITU-T G.9960].

NOTE – Test vectors for OFB Profile 2 is for further study.

Annex H

Application protocol convergence sublayer

(This annex forms an integral part of this Recommendation.)

See Annex A of [ITU-T G.9961].

Annex I

Interoperability between Profile 1 and Profile 2 OFB transmissions

(This annex forms an integral part of this Recommendation.)

See Annex J of [ITU-T G.9960].

Annex J

IEEE 802.1X port-based network access control

(This annex forms an integral part of this Recommendation.)

See Annex D of [ITU-T G.9961].

Annex K to Annex Q

Annexes K to Q have been intentionally left blank.

Annex R

Use of reverse power feeding techniques for G.hn over coaxial media

(This annex forms an integral part of this Recommendation.)

See Annex R of [ITU-T G.9961].

Annex S to Annex W

Annexes S to W have been intentionally left blank.

Annex X

Test vectors

(This annex forms an integral part of this Recommendation.)

See Annex X of [ITU-T G.9961].

SERIES OF ITU-T RECOMMENDATIONS

Series A	Organization of the work of ITU-T
Series D	Tariff and accounting principles and international telecommunication/ICT economic and policy issues
Series E	Overall network operation, telephone service, service operation and human factors
Series F	Non-telephone telecommunication services
Series G	Transmission systems and media, digital systems and networks
Series H	Audiovisual and multimedia systems
Series I	Integrated services digital network
Series J	Cable networks and transmission of television, sound programme and other multimedia signals
Series K	Protection against interference
Series L	Environment and ICTs, climate change, e-waste, energy efficiency; construction, installation and protection of cables and other elements of outside plant
Series M	Telecommunication management, including TMN and network maintenance
Series N	Maintenance: international sound programme and television transmission circuits
Series O	Specifications of measuring equipment
Series P	Telephone transmission quality, telephone installations, local line networks
Series Q	Switching and signalling, and associated measurements and tests
Series R	Telegraph transmission
Series S	Telegraph services terminal equipment
Series T	Terminals for telematic services
Series U	Telegraph switching
Series V	Data communication over the telephone network
Series X	Data networks, open system communications and security
Series Y	Global information infrastructure, Internet protocol aspects, next-generation networks, Internet of Things and smart cities
Series Z	Languages and general software aspects for telecommunication systems