

International Telecommunication Union

ITU-T

TELECOMMUNICATION
STANDARDIZATION SECTOR
OF ITU

G.997.1

(04/2009)

SERIES G: TRANSMISSION SYSTEMS AND MEDIA,
DIGITAL SYSTEMS AND NETWORKS

Digital sections and digital line system – Access networks

**Physical layer management for digital
subscriber line (DSL) transceivers**

Recommendation ITU-T G.997.1



ITU-T G-SERIES RECOMMENDATIONS
TRANSMISSION SYSTEMS AND MEDIA, DIGITAL SYSTEMS AND NETWORKS

INTERNATIONAL TELEPHONE CONNECTIONS AND CIRCUITS	G.100–G.199
GENERAL CHARACTERISTICS COMMON TO ALL ANALOGUE CARRIER-TRANSMISSION SYSTEMS	G.200–G.299
INDIVIDUAL CHARACTERISTICS OF INTERNATIONAL CARRIER TELEPHONE SYSTEMS ON METALLIC LINES	G.300–G.399
GENERAL CHARACTERISTICS OF INTERNATIONAL CARRIER TELEPHONE SYSTEMS ON RADIO-RELAY OR SATELLITE LINKS AND INTERCONNECTION WITH METALLIC LINES	G.400–G.449
COORDINATION OF RADIOTELEPHONY AND LINE TELEPHONY	G.450–G.499
TRANSMISSION MEDIA AND OPTICAL SYSTEMS CHARACTERISTICS	G.600–G.699
DIGITAL TERMINAL EQUIPMENTS	G.700–G.799
DIGITAL NETWORKS	G.800–G.899
DIGITAL SECTIONS AND DIGITAL LINE SYSTEM	G.900–G.999
General	G.900–G.909
Parameters for optical fibre cable systems	G.910–G.919
Digital sections at hierarchical bit rates based on a bit rate of 2048 kbit/s	G.920–G.929
Digital line transmission systems on cable at non-hierarchical bit rates	G.930–G.939
Digital line systems provided by FDM transmission bearers	G.940–G.949
Digital line systems	G.950–G.959
Digital section and digital transmission systems for customer access to ISDN	G.960–G.969
Optical fibre submarine cable systems	G.970–G.979
Optical line systems for local and access networks	G.980–G.989
Access networks	G.990–G.999
MULTIMEDIA QUALITY OF SERVICE AND PERFORMANCE – GENERIC AND USER-RELATED ASPECTS	G.1000–G.1999
TRANSMISSION MEDIA CHARACTERISTICS	G.6000–G.6999
DATA OVER TRANSPORT – GENERIC ASPECTS	G.7000–G.7999
PACKET OVER TRANSPORT ASPECTS	G.8000–G.8999
ACCESS NETWORKS	G.9000–G.9999

For further details, please refer to the list of ITU-T Recommendations.

Recommendation ITU-T G.997.1

Physical layer management for digital subscriber line (DSL) transceivers

Summary

Recommendation ITU-T G.997.1 specifies the physical layer management for asymmetric digital subscriber line (ADSL) and very high speed digital subscriber line 2 (VDSL2) transmission systems. It specifies means of communication on a transport transmission channel defined in the physical layer Recommendations ITU-T G.992.1, ITU-T G.992.2, ITU-T G.992.3, ITU-T G.992.4, ITU-T G.992.5 and ITU-T G.993.2. It specifies Network Elements content and syntax for configuration, fault and performance management.

The revision of this Recommendation includes the MIB elements for the physical layer management of Recommendation ITU-T G.993.2 and additional MIB elements for the physical layer management of Recommendations ITU-T G.992.3 and ITU-T G.992.5.

Source

Recommendation ITU-T G.997.1 was approved on 22 April 2009 by ITU-T Study Group 15 (2009-2012) under Recommendation ITU-T A.8 procedures.

FOREWORD

The International Telecommunication Union (ITU) is the United Nations specialized agency in the field of telecommunications, information and communication technologies (ICTs). The ITU Telecommunication Standardization Sector (ITU-T) is a permanent organ of ITU. ITU-T is responsible for studying technical, operating and tariff questions and issuing Recommendations on them with a view to standardizing telecommunications on a worldwide basis.

The World Telecommunication Standardization Assembly (WTSA), which meets every four years, establishes the topics for study by the ITU-T study groups which, in turn, produce Recommendations on these topics.

The approval of ITU-T Recommendations is covered by the procedure laid down in WTSA Resolution 1.

In some areas of information technology which fall within ITU-T's purview, the necessary standards are prepared on a collaborative basis with ISO and IEC.

NOTE

In this Recommendation, the expression "Administration" is used for conciseness to indicate both a telecommunication administration and a recognized operating agency.

Compliance with this Recommendation is voluntary. However, the Recommendation may contain certain mandatory provisions (to ensure e.g. interoperability or applicability) and compliance with the Recommendation is achieved when all of these mandatory provisions are met. The words "shall" or some other obligatory language such as "must" and the negative equivalents are used to express requirements. The use of such words does not suggest that compliance with the Recommendation is required of any party.

INTELLECTUAL PROPERTY RIGHTS

ITU draws attention to the possibility that the practice or implementation of this Recommendation may involve the use of a claimed Intellectual Property Right. ITU takes no position concerning the evidence, validity or applicability of claimed Intellectual Property Rights, whether asserted by ITU members or others outside of the Recommendation development process.

As of the date of approval of this Recommendation, ITU had received notice of intellectual property, protected by patents, which may be required to implement this Recommendation. However, implementers are cautioned that this may not represent the latest information and are therefore strongly urged to consult the TSB patent database at <http://www.itu.int/ITU-T/ipr/>.

© ITU 2010

All rights reserved. No part of this publication may be reproduced, by any means whatsoever, without the prior written permission of ITU.

CONTENTS

	Page
1 Scope	1
2 References.....	1
3 Definitions	2
4 Abbreviations.....	3
5 Overview	5
5.1 Physical layer management mechanisms	6
6 OAM communications channel	8
6.1 Requirements on the PMD layer for the bit-oriented clear EOC	9
6.2 Requirements on the PMD layer for the message-oriented clear EOC	10
6.3 Data link layer	10
6.4 The SNMP protocol.....	13
7 Management information base (MIB) elements	15
7.1 Failures	18
7.2 Performance monitoring functions	20
7.3 Configuration functions.....	30
7.4 Inventory information.....	58
7.5 Test, diagnostic and status parameters	60
7.6 Network management elements partitioning.....	77
Appendix I – Processing examples	113
I.1 Illustration of transmitter processing.....	113
I.2 Illustration of receiver processing	114
Appendix II – Downstream power back-off	115
II.1 Introduction	115
II.2 Description of the DPBO method.....	116
Bibliography.....	119

Recommendation ITU-T G.997.1

Physical layer management for digital subscriber line (DSL) transceivers

1 Scope

This Recommendation specifies the physical layer management for ADSL and VDSL2 transmission systems based on the usage of indicator bits and embedded operations channel (EOC) messages defined in the ITU-T G.992.x series of ITU-T Recommendations and in [ITU-T G.993.2], and the clear embedded operations channel defined in this Recommendation.

It specifies network management elements content for configuration, fault and performance management.

The mechanisms to provide operations, administration and maintenance (OAM) functions and to generate OAM flows F1, F2 and F3 will depend on the transport mechanism of the physical layer transmission system as well as on the supervision functions contained within the physical layer termination functions of equipment. This Recommendation only specifies flow F3 – transmission path level.

For interrelationships of this Recommendation with other G.99x-series ITU-T Recommendations, see [ITU-T G.995.1].

2 References

The following ITU-T Recommendations and other references contain provisions which, through reference in this text, constitute provisions of this Recommendation. At the time of publication, the editions indicated were valid. All Recommendations and other references are subject to revision; users of this Recommendation are therefore encouraged to investigate the possibility of applying the most recent edition of the Recommendations and other references listed below. A list of the currently valid ITU-T Recommendations is regularly published. The reference to a document within this Recommendation does not give it, as a stand-alone document, the status of a Recommendation.

- [ITU-T G.992.1] Recommendation ITU-T G.992.1 (1999), *Asymmetric digital subscriber line (ADSL) transceivers*.
- [ITU-T G.992.2] Recommendation ITU-T G.992.2 (1999), *Splitterless asymmetric digital subscriber line (ADSL) transceivers*.
- [ITU-T G.992.3] Recommendation ITU-T G.992.3 (2005), *Asymmetric digital subscriber line transceivers 2 (ADSL2)*.
- [ITU-T G.992.4] Recommendation ITU-T G.992.4 (2002), *Splitterless asymmetric digital subscriber line transceivers 2 (splitterless ADSL2)*.
- [ITU-T G.992.5] Recommendation ITU-T G.992.5 (2005), *Asymmetric digital subscriber line (ADSL) transceivers – Extended bandwidth ADSL2 (ADSL2plus)*.
- [ITU-T G.993.2] Recommendation ITU-T G.993.2 (2006), *Very high speed digital subscriber line transceivers 2 (VDSL2)*.
- [ITU-T G.994.1] Recommendation ITU-T G.994.1 (2003), *Handshake procedures for digital subscriber line (DSL) transceivers*.
- [ITU-T G.995.1] Recommendation ITU-T G.995.1 (2001), *Overview of digital subscriber line (DSL) Recommendations*.
- [ITU-T I.432.x] Recommendations ITU-T I.432.x-series, *B-ISDN user-network interface – Physical layer specification*.

- [ITU-T I.610] Recommendation ITU-T I.610 (1999), *B-ISDN operation and maintenance principles and functions*.
- [ITU-T T.35] Recommendation ITU-T T.35 (2000), *Procedure for the allocation of ITU-T defined codes for non-standard facilities*.
- [IETF RFC 1157] IETF RFC 1157 (1990), *A Simple Network Management Protocol (SNMP)*.

3 Definitions

This Recommendation defines the following terms:

3.1 accumulation period: Period of time used by the NMS to accumulate sufficient number of parameter samples.

3.2 anomaly: An anomaly is a discrepancy between the actual and desired characteristics of an item.

The desired characteristic may be expressed in the form of a specification.

An anomaly may or may not affect the ability of an item to perform a required function.

3.3 bearer channel: As defined in the respective Recommendation (also referred to as "frame bearer" in various DSL Recommendations).

3.4 clear EOC: An octet oriented data channel multiplexed in the physical layer transmission frame structure.

3.5 defect: A defect is a limited interruption in the ability of an item to perform a required function. It may or may not lead to maintenance action depending on the results of additional analysis.

Successive anomalies causing a decrease in the ability of an item to perform a required function are considered a defect.

3.6 failure: A failure is the termination of the ability of an item to perform a required function.

NOTE – After failure, the item has a fault. Analysis of successive anomalies or defects affecting the same item can lead to the item being considered as "failed".

3.7 full initialization: Any type of initialization procedure defined in respective Recommendations, except Short initialization.

3.8 masked subcarrier: A subcarrier that is not transmitted during initialization and showtime.

3.9 MEDLEY set: A set of subcarriers used during the DSL initialization. This set is defined in the respective Recommendations.

3.10 net data rate: Net data rate is defined in the G.992.x-series of ITU-T Recommendations and in [ITU-T G.993.2].

3.11 short initialization: Shortened type of initialization procedure, as specified in 7.2.1.3.3. Short initialization includes Fast Retrain, as specified in [ITU-T G.992.2], and Short Initialization, as specified in [ITU-T G.992.3] and [ITU-T G.992.4].

3.12 showtime: As defined in the respective Recommendations.

3.13 xDSL: Any of the various types of digital subscriber line technologies.

3.14 α -interface, β -interface: Interface between the PMS-TC and TPS-TC sub-layers of the xTU, as defined in [ITU-T G.995.1] and the respective Recommendations.

3.15 γ -interface: Application interface of the xTU, as defined in [ITU-T G.995.1] and the respective Recommendations.

4 Abbreviations

This Recommendation uses the following abbreviations:

ADSL	Asymmetric Digital Subscriber Line
ADSL2	Asymmetric Digital Subscriber Line 2
AME	ADSL Management Entity
AN	Access Node
ATM	Asynchronous Transfer Mode
ATU-C	ADSL Transceiver Unit – Central office end (i.e., network operator)
ATU-R	ADSL Transceiver Unit – Remote side (i.e., subscriber end of the loop)
CRC	Cyclic Redundancy Check
CV	Code Violation
DMT	Discrete MultiTone
DSL	Digital Subscriber Line
EOC	Embedded Operations Channel
ES	Errored Second
FEBE	Far-End Block Error
FEC	Forward Error Correction
FEXT	Far End Crosstalk
FFEC	Far-end Forward Error Correction
HDLC	High-level Data Link Control
HEC	Header Error Control
IMA	Inverse Multiplexing over ATM
INM	Impulse Noise Monitoring
ISDN	Integrated Services Digital Network
LCD	Loss of Cell Delineation
LFE	Line Far End
LOF	Loss of Frame
LOS	Loss of Signal
LOSS-L	LOS Second-line
LSB	Least Significant Bit
ME	Management Entity
MIB	Management Information Base
MSB	Most Significant Bit
NCD	No Cell Delineation
NE	Network Element
NEXT	Near End Crosstalk
NMS	Network Management System

NT	Network Termination
OAM	Operations, Administration and Maintenance
OLR	On-Line Reconfiguration
PDU	Protocol Data Unit
PM	Performance Monitoring
PMD	Physical Media Dependent
POTS	Plain Old Telephone Service; one of the services using the voiceband; sometimes used as a descriptor for all voiceband services.
PSD	Power Spectral Density
PSTN	Public Switched Telephone Network
PTM	Packet Transfer Mode
RDI	Remote Defect Indication
RFI	Remote Failure Indication
SEF	Severely Errored Frame
SES	Severely Errored Second
SNMP	Simple Network Management Protocol
STM	Synchronous Transfer Mode
T/S	Interface(s) between ADSL network termination and Customer Installation or home network
TC	Transmission Convergence (layer)
TCM	Time Compression Multiplex
TE	Terminal Equipment
TR	Threshold Reports
T-R	Interface(s) between ATU-R and switching layer (ATM, STM or PTM)
UAS	UnAvailable Seconds
U-C	Loop interface-Central office end
U-R	Loop interface-Remote side (i.e., subscriber end of the loop)
V-C	Logical interface between ATU-C and a digital network element, such as one or more switching systems
VDSL2	Very high speed Digital Subscriber Line 2
VME	VDSL2 Management Entity
VTU	VDSL2 Transceiver Unit
VTU-O	VDSL2 Transceiver Unit – central Office or network element end (in the 'ONU' optical network unit per [ITU-T G.993.2] – i.e., network operator.)
VTU-R	VTU at the Remote site (i.e., subscriber end of the loop)
xTU-C	xDSL Transceiver Unit – Central office end (i.e., at the network operator), used as a generic term referring to both the ATU-C of the ITU-T G.992.x series of Recommendations and the VTU-O of [ITU-T G.993.2].

xTU-R xDSL Transceiver Unit at the remote side (i.e., at the subscriber end of the loop), used as a generic term referring to both the ATU-R of the ITU-T G.992.x series of Recommendations and the VTU-R of [ITU-T G.993.2].

5 Overview

Figure 5-1 shows the system reference model for this Recommendation.

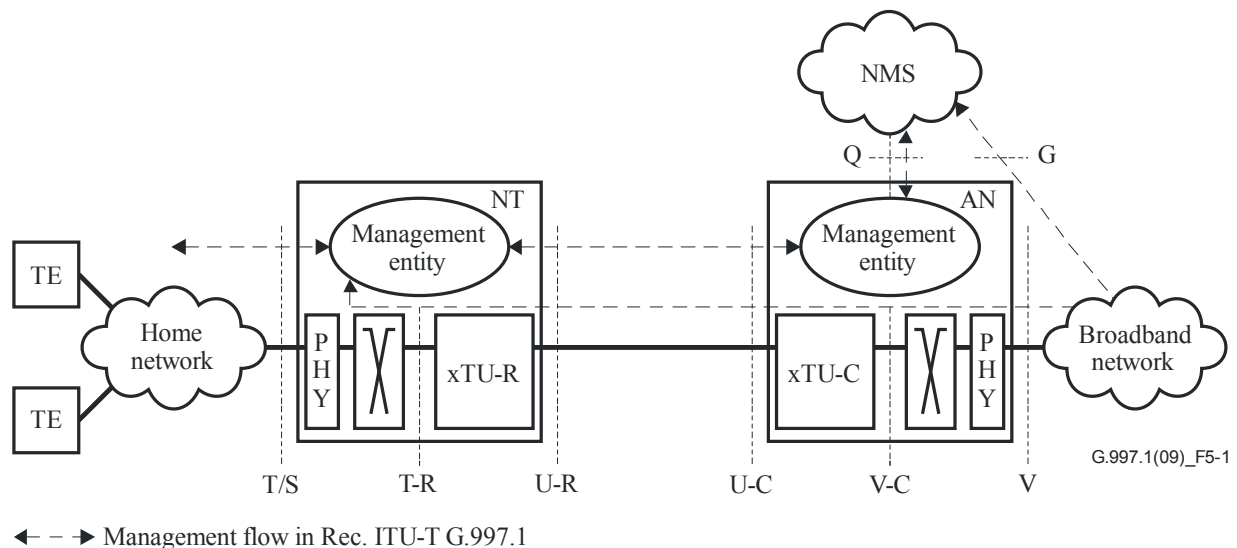

Figure 5-1 – System reference model

There are four management interfaces defined in this Recommendation.

The Q-interface is at the access node (AN) for network management systems (NMS). All the parameters specified in this Recommendation apply at the Q-interface. The Q-interface provides the interface between the NMS of the operator and the management entity (ME) in the access node.

The near-end parameters supported in the ME at the AN are derived from the xTU-C while the far-end parameters (from the xTU-R) can be derived by either of two mechanisms over the U-interface:

- Indicator bits and EOC messages can be used to generate the required xTU-R parameters in the ME of the AN.
- The OAM channel and protocol (specified in clause 6) can be used to retrieve the parameters from the xTU-R, when requested by the ME of the AN.

The definition of the transport of the management instrumentation over the Q-interface is outside the scope of this Recommendation. The coding of the management information transferred over the Q-interface is beyond the scope of this Recommendation.

Two management interfaces U-C at the xTU-C and U-R at the xTU-R, are defined. Their main purposes are to provide:

- At the xTU-C: the xTU-C near-end parameters for the xTU-R to retrieve over the U-interface.
- At the xTU-R: the xTU-R near-end parameters for the xTU-C to retrieve over the U-interface.

This Recommendation defines (see clause 6) a method for the communication of the xTU parameters defined in clause 7 over the U-interface.

NOTE 1 – In this Recommendation, U-C and U-R refer to the management interfaces that apply to the respective physical reference points defined in respective Recommendations. In Rec. ITU-T G.993.2, the reference point U-C is referred to as U-O.

At the T-/S-interface a subset of the parameters specified in this Recommendation may apply. The purpose is to indicate the ADSL or VDSL2 link status to the TE. These parameters are maintained by the ME of the NT and are made available over the T-/S-interface.

The G-interface is defined and refers to the management flows from the ME on the NT directly to the NMS when that flow crosses the 'U-C' and 'U-R' interface, but the management flow is not mediated by the ME on the AN. The specification of the protocols to support flows that cross the G-interface is outside the scope of this Recommendation. The parameters supported at the G-interface are a superset of those supported at the S/T interface and they are maintained by the ME of the network termination (NT).

The far-end parameters (from the xTU-C) can be derived by either of two mechanisms over the U-interface:

- Indicator bits and EOC messages, which are provided at the PMD layer, can be used to generate the required xTU-C parameters in the ME of the NT.
- The OAM channel and protocol (specified in clause 6) can be used to retrieve the parameters from the xTU-C, when requested by the ME of the NT.

The definition of the transport of this management information over the T-/S-interfaces is outside the scope of this Recommendation. The coding of the management information transferred over the T-S-interface is beyond the scope of this Recommendation.

Depending on the transceiver Recommendation (e.g., [ITU-T G.992.1] or [ITU-T G.992.2]), some of the parameters may not apply (i.e., fast data stream parameters for [ITU-T G.992.2]).

Specific Parameters may be applicable to specific transceiver Recommendations. Tables in clause 7.6 provide the applicability of any specific parameter to any particular Recommendation in the ITU-T G.992.x series of Recommendations and/or to [ITU-T G.993.2].

NOTE 2 – Throughout this Recommendation, the use of the term xTU-C refers to both ATU-C and VTU-O, while the term xTU-R refers to both ATU-R and VTU-R.

5.1 Physical layer management mechanisms

The general definition of OAM for ATM networks is defined in [ITU-T I.610]. This Recommendation uses this model for both ATM and PTM. The physical layer contains the three lowest OAM levels as outlined in Figure 5-2. The allocation of the OAM flows is as follows:

- F1: regenerator section level;
- F2: digital section level;
- F3: transmission path level.

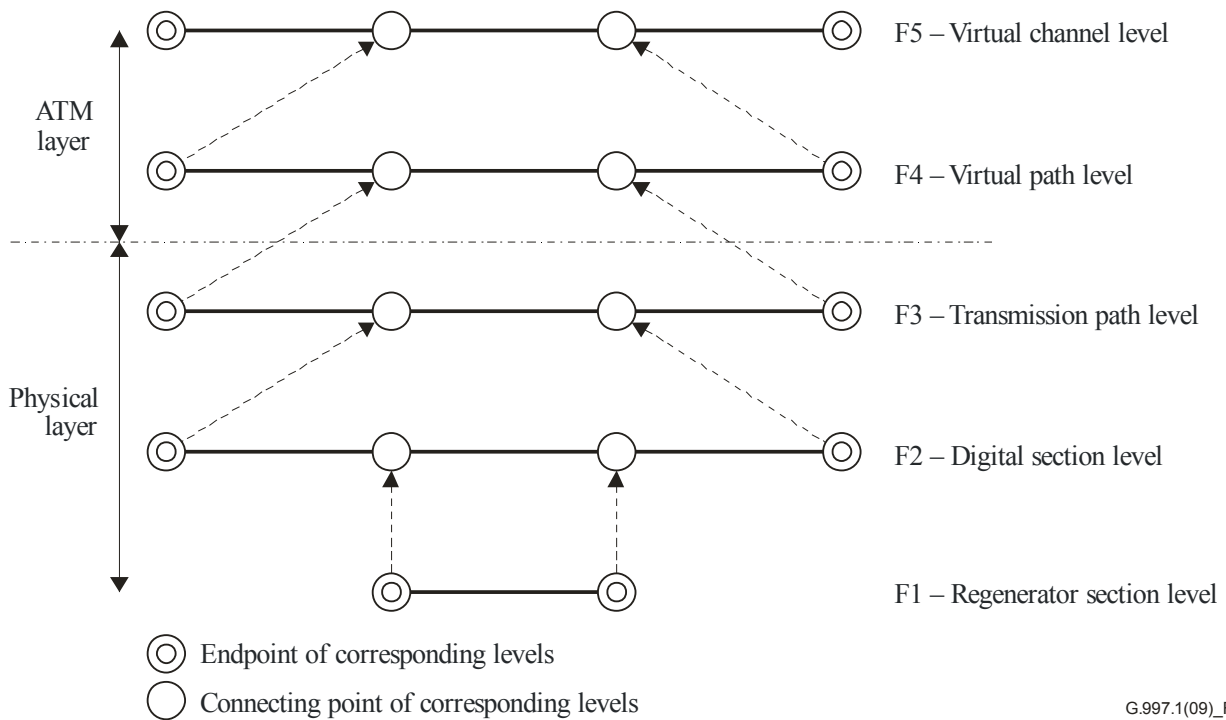

Figure 5-2 – OAM hierarchical levels and their relationship with the ATM layer and physical layer

The physical levels F1-F3 in this Recommendation are coupled with upper levels F4, F5 from the fault management perspective. When a F3 fault (e.g., LOS) is detected, it is reported to the NMS, but a F4/F5, as defined in [ITU-T I.610], fault is generated as well.

The OAM levels F1-F3 cover the part of the system referred as "xDSL LINE" in Figure 5-3. This part includes analogue processing and digital processing for the metallic transmission medium. Levels F1-F3 provide performance monitoring of both analogue and digital line-related entities. The xDSL LINE is delimited by the two end points V-D (or α) and T-D (or β) as presented in Figure 5-3. The xDSL LINE is defined between the V-D (or α) and the T-D (or β) reference points.

The xDSL ATM PATH is defined between the V-C (or γ_c) and T-R (or γ_r) reference points.

The xDSL PTM PATH is defined between the V-C (or γ_c) and T-R (or γ_r) reference points.

The xDSL STM PATH is for further study.

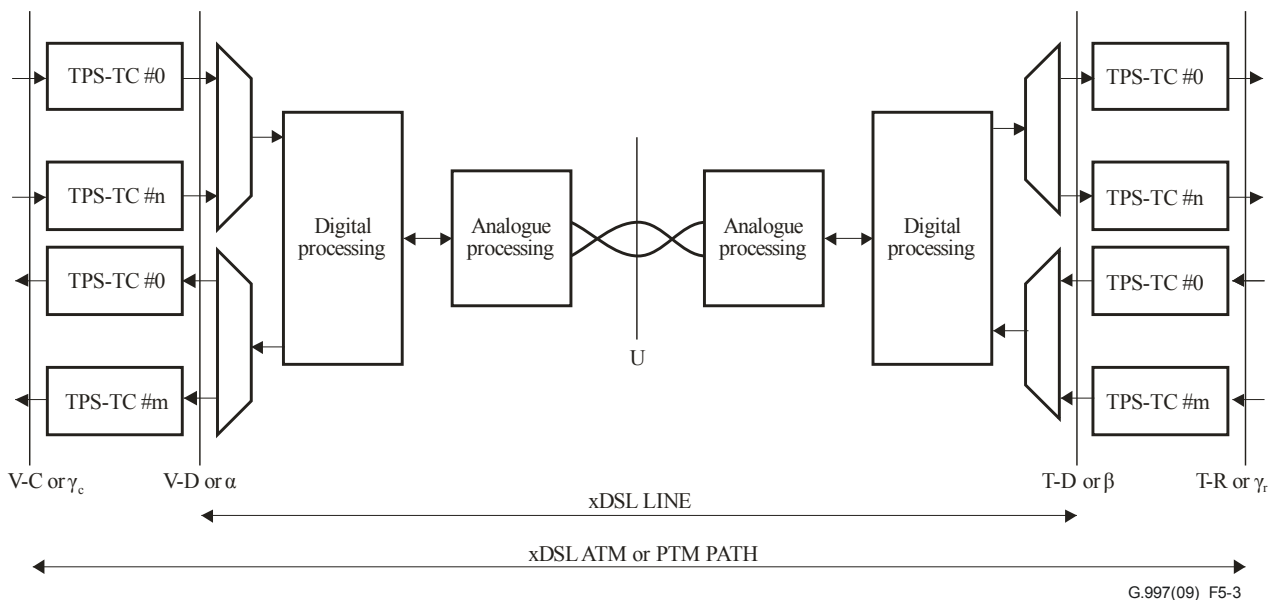

Figure 5-3 – xDSL LINE and xDSL ATM or PTM PATH definition

6 OAM communications channel

This clause specifies an optional OAM communication channel across the U-interface (see Figure 6-1). If this channel is implemented, the xTU-C and the xTU-R may use it for transporting physical layer OAM messages. If either the xTU-C or the xTU-R does not have the capability of this OAM channel, the far-end parameters, defined in clause 7, at the xTU-C shall be derived from the indicator bits and EOC messages defined in the ITU-T G.992.x-series of Recommendations and in [ITU-T G.993.2]. Support for the OAM communication channel defined in this clause will be indicated during initialization by messages defined in [ITU-T G.994.1] for G.992.1 and G.992.2.

NOTE 1 – In those cases where neither the xTU-R nor the xTU-C implements this communication channel, there are some reduced physical layer OAM capabilities (see clause 7).

The ITU-T G.992.x-series of Recommendations and [ITU-T G.993.2] may provide one of two mechanisms to transport physical layer OAM messages.

- For [ITU-T G.992.1] and [ITU-T G.992.2], the mechanism is a bit-oriented clear EOC. For these Recommendations, the channel shall meet the requirements specified in clause 6.1. The data link layer shall be as specified in clause 6.3.
- For [ITU-T G.992.3], [ITU-T G.992.4], [ITU-T G.992.5] and [ITU-T G.993.2], the mechanism is a message-oriented clear EOC. For these Recommendations, the channel shall meet the requirements specified in clause 6.2. The data link layer shall be as specified in clauses 7.8.2.3, 7.8.2.4 and 9.4.1.8 of [ITU-T G.992.3] for [ITU-T G.992.3], [ITU-T G.992.4] and [ITU-T G.992.5]; and as specified in clauses 8.2 and 11.2.3 of [ITU-T G.993.2] for [ITU-T G.993.2].

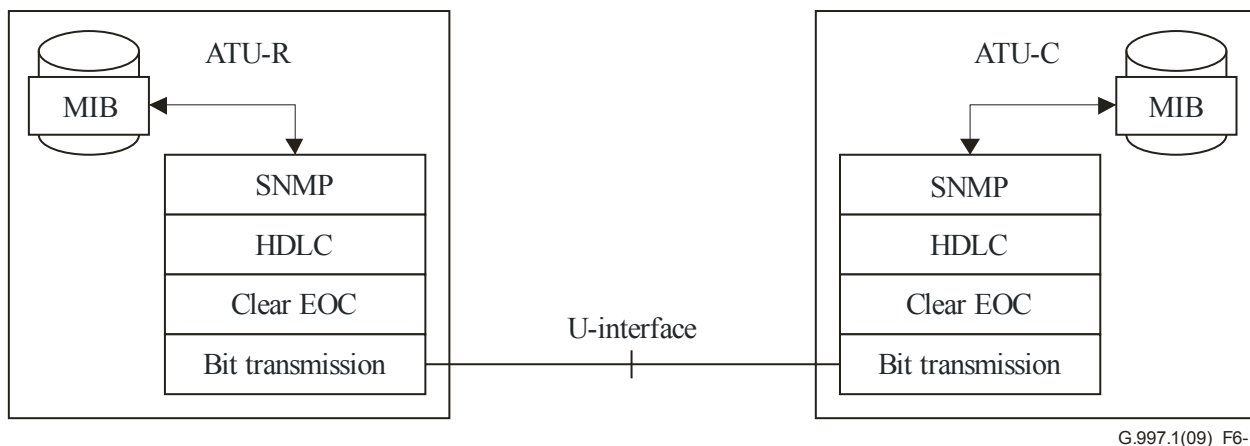

Figure 6-1 – OAM communication channel layers for bit-oriented clear EOC

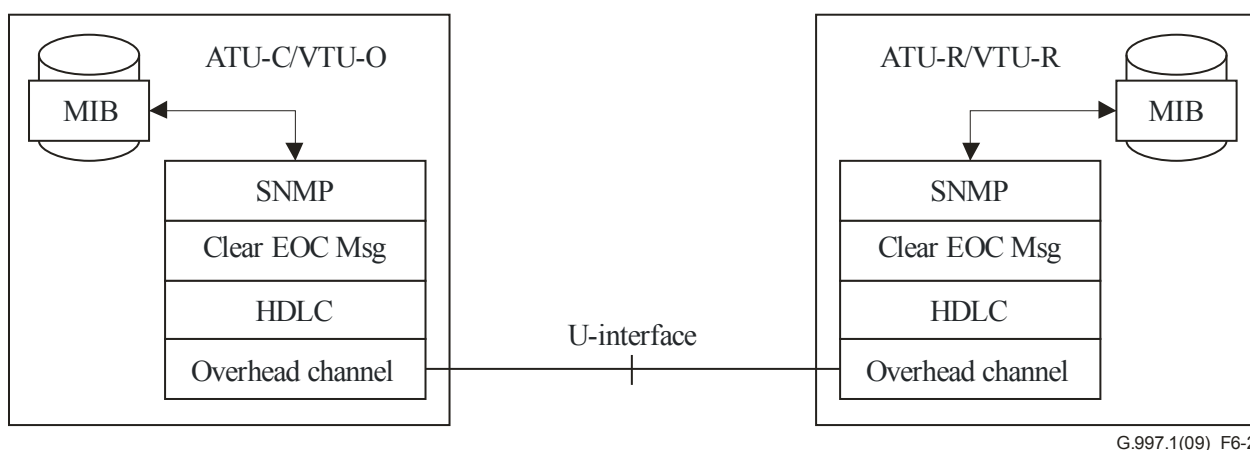

Figure 6-2 – OAM communication channel layers for message-oriented clear EOC

NOTE 2 – In Figures 6-1 and 6-2, MIB represents management information base related to the xTU.

6.1 Requirements on the PMD layer for the bit-oriented clear EOC

In order to support the physical layer OAM protocols defined in this Recommendation, a physical layer Recommendation shall provide a full duplex data channel for support of the data link layer defined in clause 6.3.

The clear EOC serves the function of a physical layer of the protocol stack defined in this Recommendation for [ITU-T G.992.2] and [ITU-T G.992.1].

- 1) The clear EOC shall be a part of the protocol overhead for the particular xDSL Recommendation.
- 2) The clear EOC shall be available to carry traffic whenever the xDSL protocol is in a normal transmission mode (e.g., "showtime").
- 3) The clear EOC shall be available regardless of the specific configuration options or run time adaptation of an ATU-C and ATU-R that are communicating.
- 4) The clear EOC shall be terminated in the ATU-R and the ATU-C.
- 5) The clear EOC shall support traffic of at least 4 kbit/s.
- 6) The clear EOC shall support delineation of individual octets in order to support the link level protocol defined in clause 7.1.

- 7) The clear EOC should not support error correction or detection. Error correction and detection is supported by use of the OAM stack defined in this Recommendation.
- 8) The clear EOC should not guarantee the delivery of data carried over the channel.
- 9) The clear EOC should not support retransmission of data upon error.
- 10) The clear EOC should not acknowledge the receipt of data by the far end of the link.
- 11) The clear EOC should not require a specific initialization procedure. It can be assumed to be operational whenever the two modems are in synchronization for "showtime" transport of data.

6.2 Requirements on the PMD layer for the message-oriented clear EOC

In order to support the physical layer OAM protocols defined in this Recommendation, a physical layer Recommendation shall provide a full duplex data channel for support of the SNMP protocol defined in clause 6.4.

- 1) The clear EOC shall be a part of the protocol overhead for the particular xDSL Recommendation.
- 2) The clear EOC shall be available to carry traffic whenever the xDSL protocol is in a normal transmission mode (e.g., "showtime").
- 3) The clear EOC shall be available regardless of the specific configuration of an xTU-C and xTU-R that are communicating.
- 4) The clear EOC shall be terminated in the xTU-R and the xTU-C.
- 5) The clear EOC shall support a bit rate of at least 4 kbit/s.
- 6) The clear EOC shall support delineation of messages through HDLC in order to support the link level protocol defined in clause 7.1.
- 7) The clear EOC should not support retransmission of data upon error.
- 8) The clear EOC should not require a specific initialization procedure. It can be assumed to be operational whenever the two modems are in synchronization for "showtime" transport of data.

6.3 Data link layer

For the transport mechanism, an HDLC-like mechanism is defined with the characteristics detailed in the following clauses. The defined method is based on [b-ISO/IEC 13239]. The requirements in the following clauses apply only to the bit-oriented clear EOC.

NOTE – For [ITU-T G.992.3], [ITU-T G.992.4] and [ITU-T G.992.5], the data link layer uses the clear EOC messages embedded in the overhead channel as defined in clauses 7.8.2.3, 7.8.2.4 and 9.4.1.8 of [ITU-T G.992.3]. For [ITU-T G.993.2], the data link layer uses the clear EOC messages embedded in the overhead channel as defined in clauses 8.2 and 11.2.3 of [ITU-T G.993.2].

The main differences between the G.997.1 data link layer and the G.992.3/G.993.2 clear EOC protocol are:

- The address field and control field is defined in clause 7.8.2.4 of [ITU-T G.992.3] or clause 8.2.4.1 of [ITU-T G.993.2].
- The two first bytes of the payload are always 08₁₆ and 01₁₆ to indicate a clear EOC command.
- Each clear EOC command is acknowledged by the far end xTU.

6.3.1 Format convention

The basic format convention used for messages is illustrated in Figure 6-3. Bits are grouped into octets. The bits of each octet are shown horizontally and are numbered from 1 to 8. Octets are displayed vertically and are numbered from 1 to N.

The octets are transmitted in ascending numerical order.

The frame check sequence (FCS) field spans two octets: Bit 1 of the first octet is the MSB and bit 8 of the second octet is the LSB (see Figure 6-4).

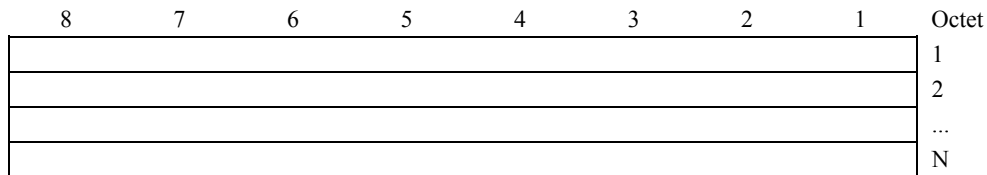

Figure 6-3 – Format convention

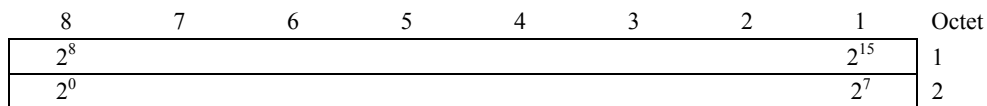

Figure 6-4 – FCS mapping convention

6.3.2 OAM frame structure

The frame structure is as depicted in Figure 6-5.

$7E_{16}$	Opening flag
FF_{16}	Address field
03_{16}	Control field
Information payload	Max 510 bytes
FCS	Frame check sequence (first octet)
FCS	Frame check sequence (second octet)
$7E_{16}$	Closing flag

Figure 6-5 – OAM frame structure

The opening and closing flag sequence shall be the octet $7E_{16}$. The address and control field of the frame shall be coded as FF_{16} and 03_{16} , respectively.

Transparency of the information payload to the flag sequence and the frame check sequence are described below.

6.3.3 Octet transparency

In this approach, any data that is equal to $7E_{16}$ (01111110_2) (flag sequence) or $7D_{16}$ (control escape) shall be escaped as described below.

After frame check sequence (FCS) computation, the transmitter examines the entire frame between the two flag sequences. Any data octets which are equal to the flag sequence ($7E_{16}$) or the control escape ($7D_{16}$) are replaced by a two-octet sequence consisting of the control escape octet followed by the original octet Exclusive-OR'ed with hexadecimal $0x20$ (this is bit 5 complemented, where the bit positions are numbered 76543210). In summary, the following substitutions are made:

- a data octet of $7E_{16}$ is encoded as two octets $7D_{16}$, $5E_{16}$;
- a data octet of $7D_{16}$ is encoded as two octets $7D_{16}$, $5D_{16}$.

On reception, prior to FCS computation, each control escape octet (7D₁₆) is removed, and the subsequent octet is exclusive-OR'ed with hexadecimal 20₁₆ (unless the following octet is 7E₁₆, which is the flag, and indicates the end of frame, and therefore an abort has occurred). In summary, the subsequent substitutions are made:

- a sequence of 7D₁₆, 5E₁₆ is replaced by the data octet 7E₁₆;
- a sequence of 7D₁₆, 5D₁₆ is replaced by the data octet 7D₁₆;
- a sequence of 7D₁₆, 7E₁₆ aborts the frame.

Note that since octet stuffing is used, the data frame is guaranteed to have an integer number of octets.

6.3.4 Frame check sequence

The FCS field is 16 bits (2 octets) in length. As defined in [b-ISO/IEC 13239], it shall be the one's complement of the sum (modulo 2) of:

- a) the remainder of $x^k (x^{15} + x^{14} + x^{13} + x^{12} + x^{11} + x^{10} + x^9 + x^8 + x^7 + x^6 + x^5 + x^4 + x^3 + x^2 + x + 1)$ divided (modulo 2) by the generator polynomial $x^{16} + x^{12} + x^5 + 1$, where k is the number of bits in the frame existing between, but not including, the last bit of the final opening flag and the first bit of the FCS, excluding octets inserted for transparency; and
- b) the remainder of the division (modulo 2) by the generator polynomial $x^{16} + x^{12} + x^5 + 1$, of the product of x^{16} by the content of the frame existing between, but not including, the last bit of the final opening flag and the first bit of the FCS, excluding octets inserted for transparency.

As a typical implementation at the transmitter, the initial content of the register of the device computing the remainder of the division is preset to all binary ONES and is then modified by division by the generator polynomial (as described above) on the information field. The one's complement of the resulting remainder is transmitted as the 16-bit FCS.

As a typical implementation at the receiver, the initial content of the register of the device computing the remainder of the division is preset to all binary ONES. The final remainder, after multiplication by 16 and then division (modulo 2) by the generator polynomial $x^{16} + x^{12} + x^5 + 1$ of the serial incoming protected bits after removal of the transparency octets and the FCS, will be 0001110100001111₂ (x^{15} through x^0 , respectively) in the absence of transmission errors.

The FCS is calculated over all bits of the Address, Control, and Information payload fields of the frame.

The register used to calculate the CRC shall be initialized to the value FFFF₁₆, both at the transmitter and the receiver.

The LSB of the FCS is sent first, followed by the MSB.

On the receiver a message received without errors results in a CRC calculation of F0B8₁₆.

6.3.5 Invalid frames

The following conditions result in an invalid frame:

- Frames which are too short (less than 4 octets in between flags, not including transparency octets).
- Frames which contain a control escape octet followed immediately by a flag (i.e., 7D₁₆, 7E₁₆).
- Frames which contain control escape sequences other than 7D₁₆, 5E₁₆ and 7D₁₆, 5D₁₆.

Invalid frames shall be discarded. The receiver shall immediately start looking for the beginning flag of a subsequent frame.

6.3.6 Synchronism

The OAM frame structure transport is octet synchronous. Octet transport and synchronism for this transport is defined in accordance with the TC layer.

6.3.7 Time fill

Inter-frame time fill shall be accomplished by inserting additional flag octets (7E₁₆) between the closing and the subsequent opening flag on the EOC transport channel. Inter-octet time fill is not supported.

6.4 The SNMP protocol

If implemented, SNMP messages shall be used as the message encoding over the HDLC data link channel defined in clause 6.2, for [ITU-T G.992.1] and [ITU-T G.992.2]; or over the clear EOC message embedded in the overhead channel for [ITU-T G.992.3], [ITU-T G.992.4], [ITU-T G.992.5] and [ITU-T G.993.2].

6.4.1 SNMP message mapping in HDLC frames

This clause applies only to Recommendations defining a bit-oriented clear EOC (e.g., [ITU-T G.992.1] and [ITU-T G.992.2]).

The SNMP messages are placed directly in HDLC frames together with the protocol identifier (see Figure 6-6). The protocol identifier is two bytes ahead of the SNMP message. The two bytes contain the ethertype SNMP value 814C₁₆ as defined in [b-IETF RFC 1700]. A single HDLC frame is used to transport each SNMP message.

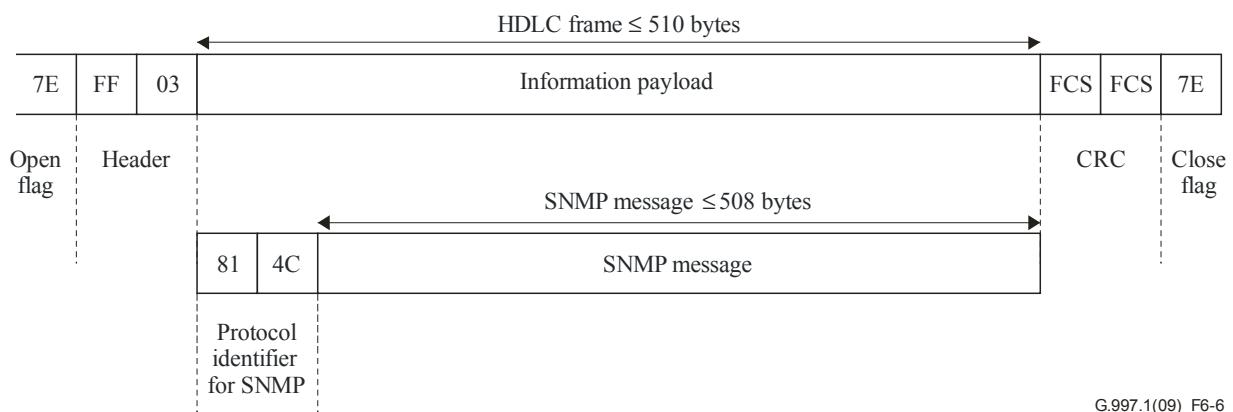

Figure 6-6 – OAM communication channel protocol over the U-interface

The length of an SNMP message shall be less than or equal to 508 bytes.

Due to the transparency mechanism described in clause 6.3.3, the number of bytes actually transmitted between opening and closing flags may be higher than 514.

6.4.2 SNMP message mapping in clear EOC messages

This clause applies only to Recommendations defining message-oriented clear EOC (e.g., [ITU-T G.992.3], [ITU-T G.992.4], [ITU-T G.992.5] and [ITU-T G.993.2]).

The SNMP messages are placed directly in the clear EOC messages together with the protocol identifier (see Figure 6-7). The protocol identifier is two bytes prepended to the SNMP message. The two bytes contain the ethertype SNMP value 814C₁₆ as defined in [b-IETF RFC 1700]. A single HDLC frame is used to transport each SNMP message.

In all SNMP Traps, the time-stamp field in the Trap-PDU shall contain the value of an AME or VME MIB object at the time of trap generation.

In any standard SNMP Trap, the enterprise field in the Trap-PDU shall contain the value of the agent's sysObjectID MIB object (sysObjectID is defined in the system group of MIB-II).

6.4.3.3 Message sizes

All ADSL and VDSL2 OAM implementations shall be able to support SNMP messages of size up to and including 508 octets.

6.4.3.4 Message response time

Response time refers to the elapsed time from the submission of an SNMP message (e.g., GetRequest, GetNextRequest or SetRequest message) by an AME or VME across an ADSL or VDSL2 Interface to the receipt of the corresponding SNMP message (e.g., GetResponse message) from the adjacent AME or VME. An SNMP GetRequest, GetNextRequest, or SetRequest message is defined in this context as a request concerning a single object.

The AME and VME shall support maximum response times of 1 s for 95% of all SNMP GetRequests, GetNextRequests or SetRequests containing a single object received from an adjacent AME or VME independent of the ADSL or VDSL2 interface's physical line rate.

6.4.3.5 Object value data correctness

Data correctness refers to the maximum elapsed time since an object value in the ADSL or VDSL2 interface MIB was known to be current. The following specifies the requirements on the data correctness of the ADSL or VDSL2 OAM objects and the event notifications.

The ADSL and VDSL2 interface MIB objects shall have the data correctness of a maximum of 30 s.

The AME and VME shall support event notifications (i.e., SNMP Traps) for generic SNMP events within 2 s of the event detection by the AME.

7 Management information base (MIB) elements

The management information base (MIB) contains six types of information:

- Fault monitoring – Failures (alarm indications);
- Fault monitoring – Threshold crossing (alert messages);
- Performance monitoring parameters (counters);
- Configuration parameters;
- Inventory parameters;
- Test, diagnostic and status parameters.

Figure 7-1 shows the in-service performance monitoring process. The primitives are specified in the physical layer of the ITU-T G.992.x-series of ITU-T Recommendations and [ITU-T G.993.2].

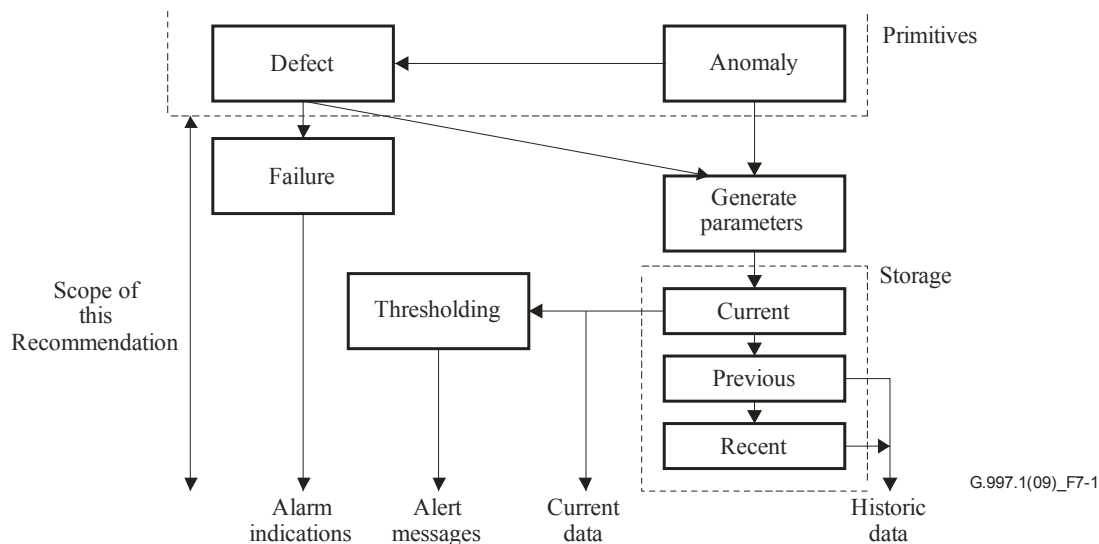

Figure 7-1 – In-service performance monitoring process

As an access node can handle a large number of xTU-Cs (e.g., hundreds or perhaps thousands of ADSL or VDSL2 lines), provisioning every parameter on every xTU-C may become burdensome. In response, two modes have been created to define ADSL and VDSL2 equipment configuration data profiles, as well as a mechanism to associate these profiles to the equipment. Profile tables may be implemented in one of two ways, but not simultaneously:

- **MODE-I: Dynamic Profiles** – profiles used by one or multiple ADSL/VDSL2 lines.
Implementations using this mode will enable the operator of the system to dynamically create and delete profiles as needed. One or more ADSL/VDSL2 lines may be configured to share parameters of a single profile (e.g., `adslLineConfProfileName = 'silver'`) by setting its `adslLineConfProfile` object to the index value of this profile. If a change is made to the profile, all lines that refer to it will be reconfigured to the changed parameters. Before a profile can be deleted or taken out of service, it shall be first unreferenced from all associated lines.
- **MODE-II: Static profiles** – one profile per ADSL/VDSL2 physical line.
Implementations with this mode will automatically create a profile one-for-one with each ADSL/VDSL2 line. The name of this profile is a system generated read-only object whose value is equivalent to the index of the line. The management agent in the access node will not allow the operator of the system to create/delete profiles in this mode.

NOTE 1 – For more details on the use of profiles, refer to [b-IETF RFC 2662].

NOTE 2 – The 'data profiles' discussed in this clause are not the 'Profiles' discussed in clause 6 of [ITU-T G.993.2]. This clause discusses the use of a 'profile' for simplifying the configuration of an xDSL transceiver in the field. Clause 6 of [ITU-T G.993.2] is a discussion of a technique for defining the native capabilities (e.g., the particular subset of [ITU-T G.993.2]) supported by a particular VDSL2 transceiver.

At the Q-interface, a line is configured by linking the following information to the line (see Figure 7-2):

- one line configuration profile (see Table 7-14) for the line;
- one channel configuration profile (see Table 7-16) for each downstream and each upstream bearer channel;
- one data path configuration profile (see Table 7-18) for each downstream and each upstream bearer channel.

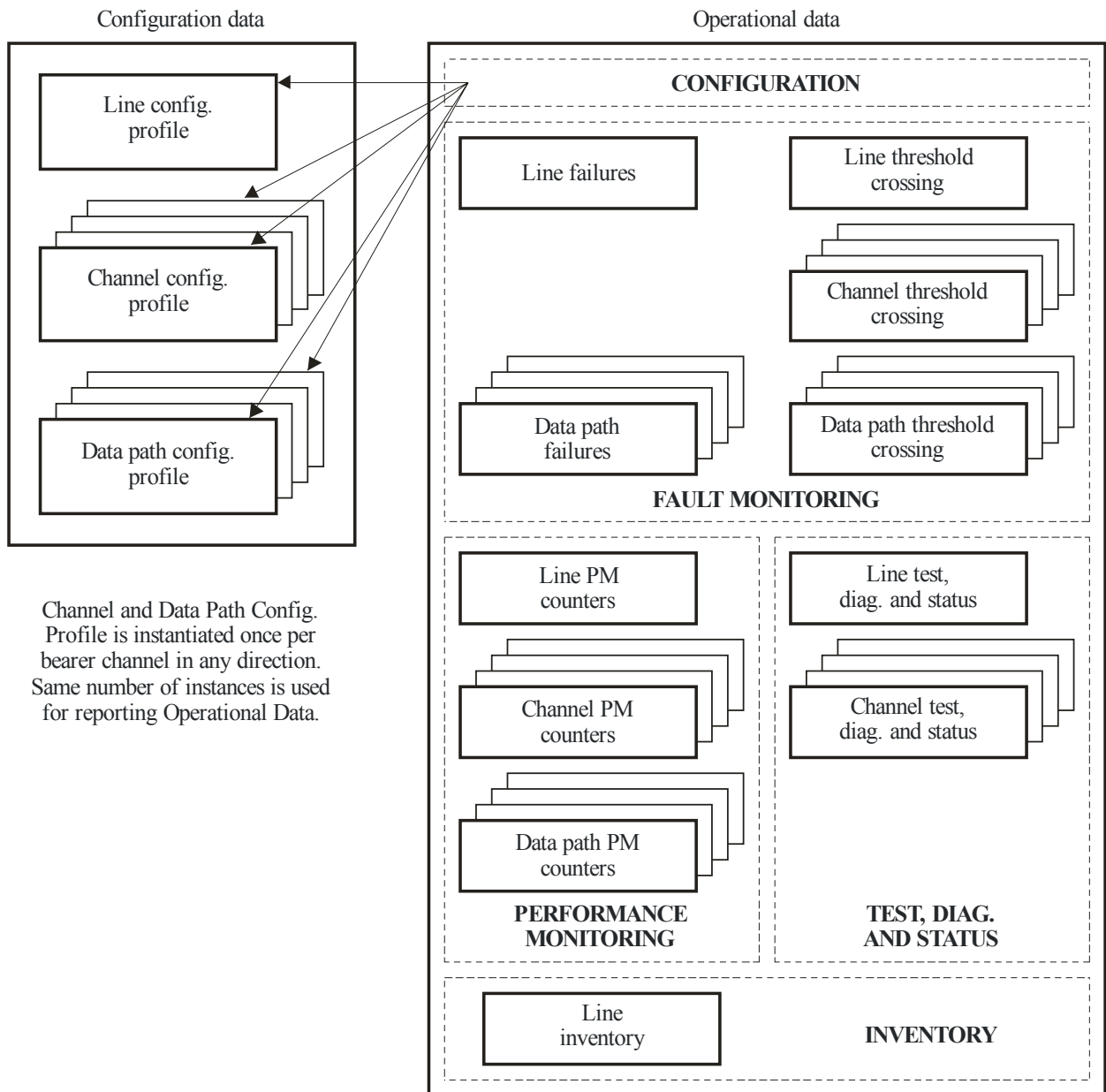

G.997.1(09)_F7-2

Figure 7-2 – Overview of the MIB elements provided for each line

Some or all of the configuration parameters contained in the line, channel and data path configuration profiles linked to the line may be written and/or read, depending on the interface under consideration:

Q interface: Management interface towards the xTU-C, from the network side perspective.

U-C interface: Management interface towards the xTU-C, from the xTU-R's perspective.

U-R interface: Management interface towards the xTU-R, from the xTU-C's perspective.

T/S interface: Management interface towards the xTU-R, from the premises side perspective.

In clause 7.6, a detailed list is given of the management elements applying to each of these interfaces, with indication whether they are mandatory or optional and whether they can be read, written or both.

As an access node can handle a large number of lines (e.g., hundreds or perhaps thousands of ADSL or VDSL2 lines), maintaining the performance monitoring and the test, diagnostic and status information (see Figure 7-2) for every line may become burdensome. Although access to all mandatory management elements shall be supported at all times for all ports on the access node at the Q interface (see Figure 5-1), the elements may not be maintained within the management entity of the access node simultaneously for all lines at all times. Although reasonable performance shall be provided at the Q interface for access to the management elements of any line, this Recommendation does not define specific performance requirements at this interface.

7.1 Failures

Any failure defined in this clause shall be conveyed to the NMS by the xTU-C (over the Q-interface) and may be conveyed by the xTU-R over the T-/S-interface after it is detected.

The near-end failure detections shall be provided at the xTU-C and shall be provided at the xTU-R.

The far-end failure detections shall be provided at the xTU-C (xTU-R is at the far-end), and may be provided at the xTU-R (xTU-C is at the far-end).

7.1.1 Line failures

7.1.1.1 Line near-end failures

7.1.1.1.1 Loss-of-signal (LOS) failure

A LOS failure is declared after 2.5 ± 0.5 s of contiguous LOS defect, or, if LOS defect is present when the criteria for LOF failure declaration have been met (see LOF definition below). A LOS failure is cleared after 10 ± 0.5 s of no LOS defect.

7.1.1.1.2 Loss-of-frame (LOF) failure

A LOF failure is declared after 2.5 ± 0.5 s of contiguous SEF defect, except when an LOS defect or failure is present (see LOS definition above). A LOF failure is cleared when LOS failure is declared, or after 10 ± 0.5 s of no SEF defect.

7.1.1.1.3 Loss-of-power (LPR) failure

A LPR failure is declared after 2.5 ± 0.5 s of contiguous near-end LPR primitive presence. An LPR failure is cleared after 10 ± 0.5 s of no near-end LPR primitive presence.

7.1.1.2 Line far-end failures

7.1.1.2.1 Far-end loss-of-signal (LOS-FE) failure

A far-end loss-of-signal – LOS-FE failure is declared after 2.5 ± 0.5 s of contiguous far-end LOS defects, or, if far-end LOS defect is present when the criteria for LOF failure declaration have been met (see LOF definition below). A far-end LOS failure is cleared after 10 ± 0.5 s of no far-end LOS defect.

7.1.1.2.2 Far-end loss-of-frame (LOF-FE) failure

A far-end loss-of-frame – LOF-FE failure is declared after 2.5 ± 0.5 s of contiguous RDI defects, except when a far-end LOS defect or failure is present (see LOS definition above). A far-end LOF failure is cleared when far-end LOS failure is declared, or after 10 ± 0.5 s of no RDI defect.

7.1.1.2.3 Far-end loss-of-power (LPR-FE) failure

A far-end loss-of-power – LPR-FE failure is declared after the occurrence of a far-end LPR primitive followed by 2.5 ± 0.5 s of contiguous near-end LOS defects. A far-end LPR failure is cleared after 10 ± 0.5 s of no near-end LOS defect.

7.1.1.3 Line initialization (LINIT) failure

If the line is forced to the L0 state (or into loop diagnostic mode) and an attempt to reach the L0 state (or to successfully complete the loop diagnostic procedures) fails (after a vendor discretionary number of retries and/or within a vendor discretionary timeout), then an initialization failure occurs. An initialization failure cause and last successful transmitted state are given by the line initialization failure (see clause 7.5.1.6). A line initialization failure shall be conveyed to the NMS by the xTU-C (over the Q-interface) and should be conveyed to the NMS by the xTU-R (over the T-/S-interface) after it is detected.

7.1.2 Channel failures

No channel failures are defined.

7.1.3 STM data path failures

The STM data path failures are for further study.

7.1.4 ATM data path failures

7.1.4.1 ATM data path near-end failures

7.1.4.1.1 No cell delineation (NCD) failure

A NCD failure is declared when a NCD anomaly persists for more than 2.5 ± 0.5 s after the start of showtime. A NCD failure terminates when no NCD anomaly is present for more than 10 ± 0.5 s.

7.1.4.1.2 Loss of cell delineation (LCD) failure

A LCD failure is declared when a LCD defect persists for more than 2.5 ± 0.5 s. A LCD failure terminates when no LCD defect is present for more than 10 ± 0.5 s.

7.1.4.2 ATM data path far-end failures

7.1.4.2.1 Far-end no cell delineation (NCD-FE) failure

A NCD-FE failure is declared when a NCD-FE anomaly persists for more than 2.5 ± 0.5 s after the start of showtime. A NCD-FE failure terminates when no NCD-FE anomaly is present for more than 10 ± 0.5 s.

7.1.4.2.2 Far-end loss of cell delineation (LCD-FE) failure

A LCD-FE failure is declared when a LCD-FE defect persists for more than 2.5 ± 0.5 s. A LCD-FE failure terminates when no LCD-FE defect is present for more than 10 ± 0.5 s.

7.1.5 PTM data path failures

7.1.5.1 PTM data path near-end failures

7.1.5.1.1 Out of sync (OOS) failure

An OOS failure is declared when an oos-*n* anomaly persists for more than 2.5 ± 0.5 s. An OOS failure terminates when no oos-*n* anomaly is present for more than 10 ± 0.5 s.

7.1.5.2 PTM data path far-end failures

7.1.5.2.1 Far-end out of sync (OOS-FE) failure

An OOS-FE failure is declared when an oos-*f* anomaly persists for more than 2.5 ± 0.5 s. An OOS-FE failure terminates when no oos-*f* anomaly is present for more than 10 ± 0.5 s.

7.2 Performance monitoring functions

Near-end performance monitoring (PM) functions shall be provided at the xTU-C and at the xTU-R. Far-end performance monitoring functions shall be provided at the xTU-C (xTU-R is at the far-end) and are optional at the xTU-R (xTU-C is at the far-end).

If the line is forced to the L0 state (see clause 7.3.1.1.3), then performance monitoring counters shall be active, irrespective of the actual power management state of the line (see clause 7.5.1.5). If the line is forced to the L3 state, then all performance monitoring counters shall be frozen, including the UAS counter.

7.2.1 Line performance monitoring parameters

This clause defines a set of line performance monitoring parameters. Support of the performance parameters in a network element is indicated as mandatory (M) or optional (O) in Table 7-1.

7.2.1.1 Near-end line performance monitoring parameters

7.2.1.1.1 Forward error correction second – Line (FECS-L)

This parameter is a count of 1-second intervals with one or more FEC anomalies summed over all received bearer channels.

7.2.1.1.2 Errored second – Line (ES-L)

This parameter is a count of 1-second intervals with one or more CRC-8 anomalies summed over all received bearer channels, or one or more LOS defects, or one or more SEF defects, or one or more LPR defects.

7.2.1.1.3 Severely errored second – Line (SES-L)

This parameter is a count of severely errored seconds (SES). An SES is declared if, during a 1-second interval, there are 18 or more CRC-8 anomalies in one or more of the received bearer channels, or one or more LOS defects, or one or more SEF defects, or one or more LPR defects.

If the relevant Recommendation (e.g., [ITU-T G.992.3], [ITU-T G.992.5] and [ITU-T G.993.2]) supports one-second normalized CRC-8 anomaly counter increment, the one-second counter used to declare SES shall increment with this value instead of incrementing by one for each CRC-8 anomaly.

If a common CRC is applied over multiple bearer channels, then each related CRC-8 anomaly shall be counted only once for the whole set of bearer channels over which the CRC is applied.

7.2.1.1.4 LOS second – Line (LOSS-L)

This parameter is a count of 1-second intervals containing one or more LOS defects.

7.2.1.1.5 Unavailable second – Line (UAS-L)

This parameter is a count of 1-second intervals for which the xDSL line is unavailable. The xDSL line becomes unavailable at the onset of 10 contiguous SES-Ls. These 10 SES-Ls shall be included in unavailable time. Once unavailable, the xDSL line becomes available at the onset of 10 contiguous seconds with no SES-Ls. These 10 seconds with no SES-Ls shall be excluded from unavailable time. Some parameter counts are inhibited during unavailability – see clause 7.2.7.13.

7.2.1.2 Far-end line performance monitoring parameters

7.2.1.2.1 Forward error correction second – Line far-end (FECS-LFE)

This parameter is a count of 1-second intervals with one or more FFEC anomalies summed over all transmitted bearer channels.

7.2.1.2.2 Errored second – Line far-end (ES-LFE)

This parameter is a count of one-second intervals with one or more FEBE anomalies summed over all transmitted bearer channels, or one or more LOS-FE defects, or one or more RDI defects, or one or more LPR-FE defects.

7.2.1.2.3 Severely errored second – Line far-end (SES-LFE)

This parameter is a count of severely errored seconds (SES). An SES is declared if, during a 1-second interval, there are 18 or more FEBE anomalies in one or more of the transmitted bearer channels, or one or more far-end LOS defects, or one or more RDI defects, or one or more LPR-FE defects.

If the relevant Recommendation (e.g., [ITU-T G.992.3], [ITU-T G.992.5] or [ITU-T G.993.2]) supports 1-second normalized CRC-8 anomaly counter increment, the one-second counter used to declare SES shall increment with this value instead of incrementing by one for each FEBE anomaly.

If a CRC is applied over multiple bearer channels, then each related FEBE anomaly shall be counted only once for the whole set of related bearer channels.

7.2.1.2.4 LOS second – Line far-end (LOSS-LFE)

This parameter is a count of 1-second intervals containing one or more far-end LOS defects.

7.2.1.2.5 Unavailable seconds – Line far-end (UAS-LFE)

This parameter is a count of 1-second intervals for which the far-end xDSL line is unavailable.

The far-end xDSL line becomes unavailable at the onset of 10 contiguous SES-LFEs. These 10 SES-LFEs shall be included in unavailable time. Once unavailable, the far-end xDSL line becomes available at the onset of 10 contiguous seconds with no SES-LFEs. These 10 seconds with no SES-LFEs shall be excluded from unavailable time. Some parameter counts are inhibited during unavailability – see clause 7.2.7.13.

7.2.1.3 Line initialization performance monitoring parameters

7.2.1.3.1 Full initialization count

This parameter is a count of the total number of full initializations attempted on the line (successful and failed) during the accumulation period. Parameter procedures shall be as defined in clause 7.2.7.

7.2.1.3.2 Failed full initialization count

This performance parameter is a count of the total number of failed full initializations during the accumulation period. A failed full initialization is when showtime is not reached at the end of the full initialization procedure.

Parameter procedures shall be as defined in clause 7.2.7.

7.2.1.3.3 Short initialization count

This parameter is a count of the total number of fast retrains or short initializations attempted on the line (successful and failed) during the accumulation period. Parameter procedures shall be as defined in clause 7.2.7.

Fast retrain is defined in [ITU-T G.992.2].

Short initialization is defined in [ITU-T G.992.3] and [ITU-T G.992.4].

7.2.1.3.4 Failed short initialization count

This performance parameter is a count of the total number of failed fast retrains or short initializations during the accumulation period. A failed fast retrain or short initialization is when showtime is not reached at the end of the fast retrain or short initialization procedure, e.g., when:

- A CRC error is detected.
- A time-out occurs.
- A fast retrain profile is unknown.

Parameter procedures shall be as defined in clause 7.2.7.

7.2.1.4 Near-end impulse noise performance monitoring parameters

7.2.1.4.1 INM INPEQ histogram 1..17 (INMINPEQ_{1..17}-L)

This parameter is a count of the near-end INMAINPEQ_i anomalies occurring on the line during the accumulation period. This parameter is subject to inhibiting – see clause 7.2.7.13.

7.2.1.4.2 INM total measurement (INMME-L)

This parameter is a count of the near-end INMAME anomalies occurring on the line during the accumulation period. This parameter is subject to inhibiting – see clause 7.2.7.13.

7.2.1.4.3 INM IAT histogram 0..7 (INMIAT_{0..7}-L)

This parameter is a count of the near-end INMAIAT_i anomalies occurring on the line during the accumulation period. This parameter is subject to inhibiting – see clause 7.2.7.13.

7.2.1.5 Far-end impulse noise performance monitoring parameters

7.2.1.5.1 INM INPEQ histogram 1..17 (INMINPEQ_{1..17}-LFE)

This parameter is a count of the far-end INMAINPEQ_i anomalies occurring on the line during the accumulation period. This parameter is subject to inhibiting – see clause 7.2.7.13.

7.2.1.5.2 INM total measurement (INMME-LFE)

This parameter is a count of the far-end INMAME anomalies occurring on the line during the accumulation period. This parameter is subject to inhibiting – see clause 7.2.7.13.

7.2.1.5.3 INM IAT histogram 0..7 (INMIAT_{0..7}-LFE)

This parameter is a count of the far-end INMAIAT_i anomalies occurring on the line during the accumulation period. This parameter is subject to inhibiting – see clause 7.2.7.13.

7.2.1.6 Near-end SOS performance monitoring parameters

7.2.1.6.1 Near-end successful SOS count (SOS-SUCCESS-NE)

This parameter is a count of the total number of successful SOS procedures initiated by the near-end xTU on the line during the accumulation period. Parameter procedures shall be as defined in clause 7.2.7.

Successful SOS is defined in clause 12.1.4 of [ITU-T G.993.2].

7.2.1.7 Far-end SOS performance monitoring parameters

7.2.1.7.1 Far-end successful SOS count (SOS-SUCCESS-FE)

This parameter is a count of the total number of successful SOS procedures initiated by the far-end xTU on the line during the accumulation period. Parameter procedures shall be as defined in clause 7.2.7.

Successful SOS is defined in clause 12.1.4 of [ITU-T G.993.2].

7.2.2 Channel performance monitoring parameters

This clause defines a set of channel performance monitoring parameters. Support of the performance parameters in a network element is indicated as mandatory (M) or optional (O) in Table 7-2.

7.2.2.1 Channel near-end performance monitoring parameters

7.2.2.1.1 Code violation – Channel (CV-C)

This parameter is a count of CRC-8 anomalies (the number of incorrect CRC) occurring in the bearer channel during the accumulation period. This parameter is subject to inhibiting – see clause 7.2.7.13.

If the CRC is applied over multiple bearer channels, then each related CRC-8 anomaly shall increment each of the counters related to the individual bearer channels.

7.2.2.1.2 Forward error correction – Channel (FEC-C)

This parameter is a count of FEC anomalies (the number of corrected code words) occurring in the bearer channel during the accumulation period. This parameter is subject to inhibiting – see clause 7.2.7.13.

If FEC is applied over multiple bearer channels, then each related FEC anomaly shall increment each of the counters related to the individual bearer channels.

7.2.2.2 Channel far-end performance monitoring parameters

7.2.2.2.1 Code violation – Channel far-end (CV-CFE)

This parameter is a count of FEBE anomalies occurring in the bearer channel during the accumulation period. This parameter is subject to inhibiting – see clause 7.2.7.13.

If the CRC is applied over multiple bearer channels, then each related FEBE anomaly shall increment each of the counters related to the individual bearer channels.

7.2.2.2.2 Forward error correction – Channel far-end (FEC-CFE)

This parameter is a count of FFEC anomalies occurring in the bearer channel during the accumulation period. This parameter is subject to inhibiting – see clause 7.2.7.13.

If FEC is applied over multiple bearer channels, then each related FFEC anomaly shall increment each of the counters related to the individual bearer channels.

7.2.3 STM data path performance monitoring parameters

The STM channel performance monitoring parameters are for further study.

7.2.4 ATM data path performance monitoring parameters

This clause defines a set of ATM data path performance monitoring parameters using the cell transfer outcomes. Support of the performance parameters in a network element is indicated as mandatory (M) or optional (O) in Table 7-3.

NOTE – The far-end parameters cannot be supported using only the indicator bits or EOC messages specified in [ITU-T G.992.1] or [ITU-T G.992.2]. They may be provided using the OAM communication channel specified in clause 6.

7.2.4.1 ATM data path near-end performance monitoring parameters

7.2.4.1.1 Near-end HEC violation count (HEC-P)

The near-end HEC_violation_count performance parameter is a count of the number of occurrences of a near-end HEC anomaly in the ATM Data Path.

7.2.4.1.2 Near-end delineated total cell count (CD-P)

The near-end delineated_total_cell_count performance parameter is a count of the total number of cells passed through the cell delineation and HEC function process operating on the ATM data path while in the SYNC state.

7.2.4.1.3 Near-end user total cell count (CU-P)

The near-end User_total_cell_count performance parameter is a count of the total number of cells in the ATM data path delivered at the V-C (for the xTU-C) or T-R (for the xTU-R) interface.

7.2.4.1.4 Near-end idle cell bit error count (IBE-P)

The near-end idle_bit_error_count performance parameter is a count of the number of bit errors in the idle cell payload received in the ATM Data Path at the near-end.

NOTE – The idle cell payload is defined in [b-ITU-T I.361] and [ITU-T I.432.x].

7.2.4.2 ATM data path far-end performance monitoring parameters

7.2.4.2.1 Far-end HEC violation count (HEC-PFE)

The far-end HEC_violation_count performance parameter is a count of the number of occurrences of a far-end HEC anomaly in the ATM data path.

7.2.4.2.2 Far-end delineated total cell count (CD-PFE)

The far-end delineated_total_cell_count performance parameter is a count of the total number of cells passed through the cell delineation process and HEC function operating on the ATM data path while in the SYNC state.

7.2.4.2.3 Far-end user total cell count (CU-PFE)

The far-end user_total_cell_count performance parameter is a count of the total number of cells in the ATM data path delivered at the V-C (for the xTU-C) or T-R (for the xTU-R) interface.

7.2.4.2.4 Far-end idle cell bit error count (IBE-PFE)

The far-end idle_bit_error_count performance parameter is a count of the number of bit errors in the idle cell payload received in the ATM data path at the far-end.

7.2.5 PTM data path performance monitoring parameters

This clause defines a set of PTM data path performance monitoring parameters. Support of the performance parameters in a network element is indicated as mandatory (M) or optional (O) in Table 7-4.

7.2.5.1 PTM data path near-end performance monitoring parameters

7.2.5.1.1 Near-end CRC error count (CRC-P)

The CRC-P performance parameter is a count of the number of occurrences of a CRC-*n* anomaly in the PTM data path at the near-end.

The CRCP-P performance parameter is a count of the number of occurrences of a CRC-*np* anomaly in the PTM data path at the near-end.

7.2.5.1.2 Near-end coding violations Count (CV-P)

The CV-P performance parameter is a count of the number of occurrences of a *cv-n* anomaly in the PTM data path at the near-end.

The CVP-P performance parameter is a count of the number of occurrences of a *cv-np* anomaly in the PTM data path at the near-end.

7.2.5.2 PTM data path far-end performance monitoring parameters

NOTE 1 – The far-end counters are not supported by the indicator bits or EOC messages specified in the ITU-T G.992.x-series of Recommendations or in [ITU-T G.993.2]. They may be provided if the higher layer protocol running over this PTM-TC provides means (outside the scope of this Recommendation) to retrieve far-end PTM-TC surveillance primitives from the far-end, or through the OAM communication channel specified in clause 6.

NOTE 2 – In [b-IEEE 802.3], the Ethernet management function (residing above the γ reference point) maps the near-end surveillance primitives and counters (obtained over the γ -interface through access to clause 45 MDIO registers) into MIB objects defined in clause 30. MIB objects are exchanged with the far-end using the Ethernet OAM PDU format and protocol defined in clause 57.

7.2.5.2.1 Far-end CRC error count count (CRC-PFE)

The far-end CRC-PFE performance parameter is a count at the far-end of the number of occurrences of a *CRC-n* anomaly (as observed by the far-end) in the PTM data path.

The far-end CRCP-PFE performance parameter is a count at the far-end of the number of occurrences of a *CRC-np* anomaly (as observed by the far-end) in the PTM data path.

7.2.5.2.2 Far-end coding violations count (CV-PFE)

The far-end CV-PFE performance parameter is a count at the far-end of the number of occurrences of a *cv-n* anomaly (as observed by the far-end) in the PTM data path.

The far-end CVP-PFE performance parameter is a count of the number of occurrences of a *cv-np* anomaly (as observed by the far-end) in the PTM data path.

7.2.6 Performance monitoring data collection

Parameter definitions, failure definitions, and other indications, parameters, and signals are defined above and in Tables 7-1, 7-2, 7-3 and 7-4. Functions are indicated as mandatory (M) or optional (O). Mandatory functions shall be met for performance monitoring. Optional functions should be provided according to the needs of the users.

Table 7-1 – Line performance monitoring parameter definitions

Name	End	Use at xTU-C	Use at xTU-R	Definition
FECS-L	Near	M	M	FEC \geq 1 for one or more bearer channels.
FECS-LFE	Far	M	O	FFEC \geq 1 for one or more bearer channels.
ES-L	Near	M	M	CRC-8 \geq 1 for one or more bearer channels OR LOS \geq 1 OR SEF \geq 1 OR LPR \geq 1
ES-LFE	Far	M	O	FEBE \geq 1 for one or more bearer channels OR LOS-FE \geq 1 OR RDI \geq 1 OR LPR-FE \geq 1
SES-L	Near	M	M	CRC-8 \geq 18 for one or more bearer channels OR LOS \geq 1 OR SEF \geq 1 OR LPR \geq 1
SES-LFE	Far	M	O	FEBE \geq 18 for one or more bearer channels OR LOS-FE \geq 1 OR RDI \geq 1 OR LPR-FE \geq 1
LOSS-L	Near	O	O	LOS \geq 1
LOSS-LFE	Far	O	O	LOS-FE \geq 1
UAS-L	Near	M	M	A second of unavailability.
UAS-LFE	Far	M	O	A second of unavailability.
INMINPEQ _i -L	Near	O		Count of INMAINPEQ _i -L anomalies on the line.
INMINPEQ _i -LFE	Far	O		Count of INMAINPEQ _i -LFE anomalies on the line.
INMIAT _i -L	Near	O		Count of INMAIAT _i -L anomalies on the line.
INMIAT _i -LFE	Far	O		Count of INMAIAT _i -LFE anomalies on the line.
INMME-L	Near	O		Count of INMAME-L anomalies on the line.
INMME-LFE	Far	O		Count of INMAME-LFE anomalies on the line.

NOTE 1 – Note that **OR** represents a logical OR of two conditions.
NOTE 2 – Unavailability begins at the onset of 10 contiguous severely errored seconds, and ends at the onset of 10 contiguous seconds with no severely errored seconds.
NOTE 3 – If a common CRC or FEC is applied over multiple bearer channels, then each related CRC-8 or FEC anomaly shall be counted only once for the whole set of bearer channels over which the CRC or FEC is applied.
NOTE 4 – If the relevant Recommendation supports one-second normalized CRC counter increments, these increments shall be used instead of an increment of one for each CRC-8 and FEBE anomaly to declare SES.

Table 7-2 – Channel performance monitoring parameter definitions

Name	End	Use at xTU-C	Use at xTU-R	Definition
CV-C	Near	M	M	Count of CRC-8 anomalies in the bearer channel.
CV-CFE	Far	M	O	Count of FEBE anomalies in the bearer channel.
EC-C	Near	M	M	Count of FEC anomalies in the bearer channel.
EC-CFE	Far	M	O	Count of FFEC anomalies in the bearer channel.

Table 7-3 – ATM data path performance monitoring parameter definitions

Name	End	Use at xTU-C	Use at xTU-R	Definition
HEC-P	Near	M	M	Count of HEC anomalies in the bearer channel.
HEC-PFE	Far	M	O	Count of FHEC anomalies in the bearer channel.
CD-P	Near	M	M	Count of delineated cells in the bearer channel.
CD-PFE	Far	M	O	Count of delineated cells in the bearer channel.
CU-P	Near	M	M	Count of cells to user in the bearer channel.
CU-PFE	Far	M	O	Count of cells to user in the bearer channel.
IBE-P	Near	M	M	Count of idle cell payload bit errors in the bearer channel.
IBE-PFE	Far	M	O	Count of idle cell payload bit errors in the bearer channel.

Table 7-4 – PTM data path performance monitoring parameter definitions

Name	End	Use at xTU-C	Use at xTU-R	Definition
CRC-P	Near	M	M	Count of non pre-emptive packets with CRC error in the bearer channel.
CRC-PFE	Far	M	O	Count of non pre-emptive packets with CRC error in the bearer channel.
CRCP-P	Near	M	M	Count of pre-emptive packets with CRC error in the bearer channel.
CRCP-PFE	Far	M	O	Count of pre-emptive packets with CRC error in the bearer channel.
CV-P	Near	M	M	Count of non pre-emptive packets with coding violation in the bearer channel.
CV-PFE	Far	M	O	Count of non pre-emptive packets with coding violation in the bearer channel.
CVP-P	Near	M	M	Count of pre-emptive packets with coding violation in the bearer channel.
CVP-PFE	Far	M	O	Count of pre-emptive packets with coding violation in the bearer channel.

The line performance monitoring parameters (Table 7-1) are observed for the downstream and upstream directions. In the downstream direction, the near-end line performance monitoring parameters are observed by the xTU-R and far-end line performance monitoring parameters are observed by the xTU-C. In the upstream direction, near-end line performance monitoring parameters are observed by the xTU-C and far-end line performance monitoring parameters are observed by the xTU-R.

For a downstream bearer channel, near-end channel (Table 7-2), ATM data path (Table 7-3, if applicable), and PTM data path (Table 7-4, if applicable) performance monitoring parameters are observed by the xTU-R and far-end performance monitoring parameters are observed by the xTU-C. For an upstream bearer channel, near-end channel and ATM data path performance monitoring parameters are observed by the xTU-C and far-end performance monitoring parameters are observed by the xTU-R.

7.2.7 Procedures for performance monitoring functions

The functions described in this clause can be performed inside or outside the network element.

7.2.7.1 Line transmission states

A line can be in one of two transmission states:

- unavailable state;
- available state.

The transmission state is determined from filtered SES/non-SES data. The definition of unavailable state is defined in clause 7.2.1.1.5. An xDSL Line is in the available state when it is not in the unavailable state.

7.2.7.2 Threshold reports

A threshold report (TR) is an unsolicited error performance report from a ME over the Q-interface and from the xTU-R over the U-interface with respect to either a 15-minute or 24-hour evaluation period. TRs can only occur when the concerned direction is in the available state. At the Q-interface, TRs for near-end and far-end ES, SES and UAS parameters are mandatory and TRs for the other defined parameters are optional except for INM parameters, for which TRs are not defined. Threshold reports are not provided at the T-/S-interface.

TR1s shall occur within 10 seconds after the 15-minute threshold is reached or exceeded.

TR2s shall occur within 10 seconds after the 24-hour threshold is reached or exceeded.

7.2.7.3 Unavailable and available state filters

The unavailable state filter is a 10-second rectangular sliding window with a 1-second granularity of the slide.

The available state filter is also a 10-second rectangular sliding window with a 1-second granularity of the slide.

7.2.7.4 TR1 filter

The TR1 filter is a 15-minute rectangular fixed window. The start and end times for the 15-minute rectangular fixed windows shall fall on the hour and at 15, 30 and 45 minutes after the hour.

7.2.7.5 TR2 filter

The TR2 filter is a 24-hour rectangular fixed window. The start and end times for the 24-hour rectangular fixed windows shall fall on a 15-minute window boundary.

7.2.7.6 Evaluation of TR1

The parameters are counted separately, second by second, over each 15-minute rectangular fixed window period. The threshold values should be programmable over the range 0 to 900 with default values. The default values are given in [b-ITU-T M.2100] and [b-ITU-T M.2101].

A threshold can be crossed at any second within the 15-minute rectangular fixed window. As soon as a threshold is crossed, a TR1 as appropriate should be sent to the NMS together with a date/time-stamp. Moreover, performance events should continue to be counted to the end of the current 15-minute period, at which time the current parameter counts are stored in the history registers and the current parameter registers are reset to zero.

7.2.7.7 Evaluation of TR2

The parameters are counted separately over each 24-hour period. The threshold values should be programmable over the range 0 to 86400 with default values.

The network element shall recognize a 24-hour threshold crossing within 15 minutes of its occurrence. The threshold crossing shall be given the date/time-stamp of the moment of recognition. A TR2 as appropriate should be sent to the NMS with the date/time-stamp. Moreover, performance events should continue to be counted to the end of the current 24-hour period, at which time the parameter counts are stored in the history registers and the current parameter registers are reset to zero.

7.2.7.8 Threshold report evaluation during transmission state changes

Care should be taken to ensure that threshold reports are correctly generated and parameter counters are correctly processed during changes in the transmission state. This implies that all threshold reports should be delayed by 10 seconds (see [b-ITU-T M.2120]).

7.2.7.9 Performance history storage in network elements

The parameters for ME performance history storage at the Q-interface that shall be supported are ES, SES and UAS. Performance history storage for the other defined parameters is optional.

There shall be a current 15-minute register (which can also facilitate the TR1 filter) plus a further N 15-minute history registers for each parameter in each ME. The N 15-minute history registers are used as a stack, i.e., the value held in each register is pushed down the stack one place at the end of each 15-minute period, and the oldest register value at the bottom of the stack is discarded.

The value of N for the parameters ES, SES and UAS shall be at least 16. For the other parameters, the value of N shall be at least 1 (i.e., only current and previous values are required). If INM parameters are supported, the value of N for those parameters shall be 1.

There shall be a current 24-hour register (which can also facilitate the TR2 filter) plus one previous 24-hour register for each parameter.

As a minimum, an invalid data flag shall be provided for each stored interval for each direction for each monitored transmission entity. For example:

An invalid data flag is set to indicate that the data stored is incomplete or otherwise invalid when:

- The data in the previous and recent intervals has been accumulated over a period of time that is greater or less than the nominal accumulation period duration.
- The data in the current interval is suspect because a terminal is restarted or a register is reset in the middle of an accumulation period.
- The data is incomplete in an accumulation period. For example, an incoming transmission failure or defect may prevent complete collection of far-end performance reports.

The invalid data flag is not set as a result of register saturation.

7.2.7.10 Register size

The minimum register size is 16 bits. The maximum register sizes are vendor discretionary. When the maximum value of a register is reached, the register shall remain at that maximum value until it is reset, or the value is transferred or discarded, as described in this clause.

7.2.7.11 Parameter counts

All parameter counts shall be actual counts for the 15-minute filtering period.

Although all parameter counts should (ideally) also be actual for the 24-hour filtering periods, it is recognized that it might be desirable to limit register sizes. In such cases register overflow may occur. Should register overflow occur, the registers shall hold their maximum value for the parameter considered until the registers are read and reset at the end of the 24-hour period. An implementation involving setting and resetting an overflow bit may be used.

7.2.7.12 Date/time-stamping of reports

The date/time-stamping accuracy of reports, together with the method of maintaining the accuracy, is under study.

The format for date/time-stamps is as follows:

- 15-minute window will be stamped Year, Month, Day, Hour, Minute;
- 24-hour window will be stamped Year, Month, Day, Hour;
- Unavailable Time events will be stamped Year, Month, Day, Hour, Minute, Second;
- Alarms will be stamped either at the declaration of the alarm by the equipment or at the exact time of the event (to be decided) with Year, Month, Day, Hour, Minute, Second.

Equipment clock accuracy requirements are for further study.

7.2.7.13 Inhibiting performance monitoring parameters

For a given monitored entity, the accumulation of certain performance parameters is inhibited during periods of unavailability, during SESs or during seconds containing defects on that monitored entity. Inhibiting on a given monitored entity (e.g., ADSL ATM data path) is not explicitly affected by conditions on any other monitored entity (xDSL line). The inhibiting rules are as follows:

- UAS and failure count parameters shall not be inhibited.
- INM parameters shall be inhibited during a 1-second interval, if it contains one or more LOS defects, or one or more SEF defects, or one or more LPR defects.
- All other performance parameter counts shall be inhibited during UAS and SES. Inhibiting shall be retroactive to the onset of unavailable time and shall end retroactively to the end of unavailable time.

7.3 Configuration functions

7.3.1 Line configuration parameters

7.3.1.1 State configuration parameters

7.3.1.1.1 xTU transmission system enabling (XTSE)

This configuration parameter defines the transmission system types to be allowed by the near-end xTU on this line. This parameter only applies to the Q-interface. It is coded in a bit-map representation (0 if not allowed, 1 if allowed), with following definition:

Bit Representation

Octet 1

- | | |
|---|--|
| 1 | Regional standards (see Note). |
| 2 | Regional standards (see Note). |
| 3 | G.992.1 operation over POTS non-overlapped spectrum (Annex A of [ITU-T G.992.1]). |
| 4 | G.992.1 operation over POTS overlapped spectrum (Annex A of [ITU-T G.992.1]). |
| 5 | G.992.1 operation over ISDN non-overlapped spectrum (Annex B of [ITU-T G.992.1]). |
| 6 | G.992.1 operation over ISDN overlapped spectrum (Annex B of [ITU-T G.992.1]). |
| 7 | G.992.1 operation in conjunction with TCM-ISDN non-overlapped spectrum (Annex C of [ITU-T G.992.1]). |
| 8 | G.992.1 operation in conjunction with TCM-ISDN overlapped spectrum (Annex C of [ITU-T G.992.1]). |

Octet 2

- 9 G.992.2 operation over POTS non-overlapped spectrum (Annex A of [ITU-T G.992.2]).
- 10 G.992.2 operation over POTS overlapped spectrum (Annex B of [ITU-T G.992.2]).
- 11 G.992.2 operation in conjunction with TCM-ISDN non-overlapped spectrum (Annex C of [ITU-T G.992.2]).
- 12 G.992.2 operation in conjunction with TCM-ISDN overlapped spectrum (Annex C of [ITU-T G.992.2]).
- 13 Reserved.
- 14 Reserved.
- 15 Reserved.
- 16 Reserved.

Octet 3

- 17 Reserved.
- 18 Reserved.
- 19 G.992.3 operation over POTS non-overlapped spectrum (Annex A of [ITU-T G.992.3]).
- 20 G.992.3 operation over POTS overlapped spectrum (Annex A of [ITU-T G.992.3]).
- 21 G.992.3 operation over ISDN non-overlapped spectrum (Annex B of [ITU-T G.992.3]).
- 22 G.992.3 operation over ISDN overlapped spectrum (Annex B of [ITU-T G.992.3]).
- 23 G.992.3 operation in conjunction with TCM-ISDN non-overlapped spectrum (Annex C of [ITU-T G.992.3]).
- 24 G.992.3 operation in conjunction with TCM-ISDN overlapped spectrum (Annex C of [ITU-T G.992.3]).

Octet 4

- 25 G.992.4 operation over POTS non-overlapped spectrum (Annex A of [ITU-T G.992.4]).
- 26 G.992.4 operation over POTS overlapped spectrum (Annex A of [ITU-T G.992.4]).
- 27 Reserved.
- 28 Reserved.
- 29 G.992.3 all digital mode operation with non-overlapped spectrum (Annex I of [ITU-T G.992.3]).
- 30 G.992.3 all digital mode operation with overlapped spectrum (Annex I of [ITU-T G.992.3]).
- 31 G.992.3 all digital mode operation with non-overlapped spectrum (Annex J of [ITU-T G.992.3]).
- 32 G.992.3 all digital mode operation with overlapped spectrum (Annex J of [ITU-T G.992.3]).

Octet 5

- 33 G.992.4 all digital mode operation with non-overlapped spectrum (Annex I of [ITU-T G.992.4]).
- 34 G.992.4 all digital mode operation with overlapped spectrum (Annex I of [ITU-T G.992.4]).
- 35 G.992.3 reach extended operation over POTS, Mode 1 (non-overlapped, wide upstream) (Annex L of [ITU-T G.992.3]).

- 36 G.992.3 reach extended operation over POTS, Mode 2 (non-overlapped, narrow upstream) (Annex L of [ITU-T G.992.3]).
- 37 G.992.3 reach extended operation over POTS, Mode 3 (overlapped, wide upstream) (Annex L of [ITU-T G.992.3]).
- 38 G.992.3 reach extended operation over POTS, Mode 4 (overlapped, narrow upstream) (Annex L of [ITU-T G.992.3]).
- 39 G.992.3 extended upstream operation over POTS non-overlapped spectrum (Annex M of [ITU-T G.992.3]).
- 40 G.992.3 extended upstream operation over POTS overlapped spectrum (Annex M of [ITU-T G.992.3]).

Octet 6

- 41 G.992.5 operation over POTS non-overlapped spectrum (Annex A of [ITU-T G.992.5]).
- 42 G.992.5 operation over POTS overlapped spectrum (Annex A of [ITU-T G.992.5]).
- 43 G.992.5 operation over ISDN non-overlapped spectrum (Annex B of [ITU-T G.992.5]).
- 44 G.992.5 operation over ISDN overlapped spectrum (Annex B of [ITU-T G.992.5]).
- 45 G.992.5 operation in conjunction with TCM-ISDN non-overlapped spectrum (Annex C of [ITU-T G.992.5]).
- 46 G.992.5 operation in conjunction with TCM-ISDN overlapped spectrum (Annex C of [ITU-T G.992.5]).
- 47 G.992.5 all digital mode operation with non-overlapped spectrum (Annex I of [ITU-T G.992.5]).
- 48 G.992.5 all digital mode operation with overlapped spectrum (Annex I of [ITU-T G.992.5]).

Octet 7

- 49 G.992.5 all digital mode operation with non-overlapped spectrum (Annex J of [ITU-T G.992.5]).
- 50 G.992.5 all digital mode operation with overlapped spectrum (Annex J of [ITU-T G.992.5]).
- 51 G.992.5 extended upstream operation over POTS non-overlapped spectrum (Annex M of [ITU-T G.992.5]).
- 52 G.992.5 extended upstream operation over POTS overlapped spectrum (Annex M of [ITU-T G.992.5]).
- 53 Reserved.
- 54 Reserved.
- 55 Reserved.
- 56 Reserved.

Octet 8

- 49 G.993.2 Region A (North America) (Annex A of [ITU-T G.993.2]).
- 50 G.993.2 Region B (Europe) (Annex B of [ITU-T G.993.2]).
- 51 G.993.2 Region C (Japan) (Annex C of [ITU-T G.993.2]).
- 52 Reserved.
- 53 Reserved.
- 54 Reserved.

55 Reserved.

56 Reserved.

NOTE – It is recommended that bit 1 be used for [b-ATIS 0600413]. It is recommended that bit 2 be used for Annex C of [b-ETSI TS 101 388].

7.3.1.1.2 ATU impedance state forced (AISF)

This configuration parameter defines the impedance state to be forced on the near-end ATU. It applies only to the T-/S-interface. It is coded as an integer value with the following definition:

- 1 Force the near-end ATU to the disabled state.
- 2 Force the near-end ATU to the inactive state.
- 3 Force the near-end ATU to the active state.

Impedance states apply only to Annex A of [ITU-T G.992.3] operation mode and are defined in clause A.4.1 of [ITU-T G.992.3].

7.3.1.1.3 Power management state forced (PMSF)

This configuration parameter defines the line states to be forced by the near-end xTU on this line. It is coded as an integer value with the following definition:

- 0 Force the line to transition from the L3 idle state to the L0 full-on state (i.e., both xTUs are in showtime). This transition requires the (short or full) initialization procedures. After reaching the L0 state, the line may transition into or exit from the L2 low power state (if L2 state is defined and enabled). If the L0 state is not reached (after a vendor discretionary number of retries and/or within a vendor discretionary timeout), then an Initialization failure occurs. Whenever the line is in the L3 state, attempts shall be made to transition to the L0 state until it is forced into another state through this configuration parameter.
- 2 Force the line to transition from L0 full on to L2 low power state. This transition requires the entry into L2 mode. This is an out-of-service test value for triggering the L2 mode and is valid only for Recommendations supporting L2 mode.
- 3 Force the line to transition from the L0 full-on or L2 low power state to the L3 idle state. This transition requires the (orderly) shutdown procedure. After reaching the L3 state, the line shall remain in the L3 idle state until it is forced into another state through this configuration parameter.

Forced line state transitions require the line to enter or exit the L3 idle state. These transitions are not restricted by the power management state enabling parameter value.

NOTE – This configuration parameter maps to the AdminStatus of the line, which is part of the GeneralInformationGroup object group specified in [b-IETF RFC 2233], and may not need to be duplicated in the ADSL MIB. See also [b-IETF RFC 2662]. The administrative status of the line is UP when the line is forced to the L0 state and is DOWN when the line is forced to the L3 state.

7.3.1.1.4 Power management state enabling (PMMode)

This configuration parameter defines the line states the xTU-C or xTU-R may autonomously transition to on this line. It is coded in a bit-map representation (0 if not allowed, 1 if allowed) with following definition:

Bit 0 L3 state (idle state)

Bit 1 L1/L2 state (low power state)

NOTE – L1/L2 state may not be defined in some ITU-T Recommendations.

7.3.1.1.5 Minimum L0 time interval between L2 exit and next L2 entry (L0-TIME)

This parameter represents the minimum time (in seconds) between an exit from the L2 state and the next entry into the L2 state. It ranges from 0 to 255 seconds.

7.3.1.1.6 Minimum L2 time interval between L2 entry and first L2 trim (L2-TIME)

This parameter represents the minimum time (in seconds) between an entry into the L2 state and the first power trim in the L2 state and between two consecutive power trims in the L2 state. It ranges from 0 to 255 seconds.

7.3.1.1.7 Maximum aggregate transmit power reduction per L2 request or L2 power trim (L2-ATPR)

This parameter represents the maximum aggregate transmit power reduction (in dB) that can be performed in the L2 request (i.e., at transition of L0 to L2 state) or through a single power trim in the L2 state. It ranges from 0 dB to 31 dB in steps of 1 dB.

7.3.1.1.8 Loop diagnostic mode forced (LDSF)

This configuration parameter defines whether the line should be forced into the loop diagnostic mode by the near-end xTU on this line. It is coded as an integer value with the following definition:

- 0 Inhibits the near-end xTU from performing loop diagnostic mode procedures on the line. Loop diagnostic mode procedures may still be initiated by the far-end xTU.
- 1 Forces the near-end xTU to perform the loop diagnostic procedures.

The line needs to be forced to the L3 state (see clause 7.3.1.1.3) before it can be forced to the loop diagnostic mode. Only while the line power management state is the L3 state (see clause 7.5.1.5) can the line be forced into the loop diagnostic mode procedures. Upon successful completion of the loop diagnostic mode procedures, the access node shall set the LDSF MIB element to 0, and the xTUs shall return to the L3 state. The loop diagnostic data shall be available at least until the line is forced to the L0 state (see clause 7.3.1.1.3). If the loop diagnostic procedures cannot be completed successfully (after a vendor discretionary number of retries and/or within a vendor discretionary timeout), then an initialization failure occurs. As long as loop diagnostic procedures are not completed successfully, attempts shall be made to do so, until the loop diagnostic mode is no longer forced on the line through this configuration parameter.

7.3.1.1.9 Total maximum aggregate transmit power reduction in L2 (L2-ATPRT)

This parameter represents the total maximum aggregate transmit power reduction (in dB) that can be performed in an L2 state. This is the sum of all reductions of L2 Request (i.e., at transition of L0 to L2 state) and power trims. It ranges from 0 dB to 31 dB in steps of 1 dB.

7.3.1.1.10 Automode cold start forced

This parameter is defined in order to improve testing of the performance of xTUs supporting automode when it is enabled in the MIB. The valid values are 0 and 1. A change in value of this parameter indicates a change in loop conditions applied to the devices under test. The xTUs shall reset any historical information used for automode, for shortening G.994.1 handshake, or for shortening the initialization procedure.

Automode is defined as the case where multiple operation-modes are enabled in the MIB in the G.997.1 "xTU Transmission System Enabling (XTSE)" table and where the selection of the operation-mode to be used for transmission does not only depend on the common capabilities of both xTUs (as exchanged in [ITU-T G.994.1]), but depends also on achievable data rates under given loop conditions.

This parameter is mandatory at the Q interface for modems supporting automode.

7.3.1.1.11 VDSL2 profiles enabling (PROFILES)

This configuration parameter contains the ITU-T G.993.2 profiles to be allowed by the near-end xTU on this line. It is coded in a bit-map representation (0 if not allowed, 1 if allowed) with the following definition:

Bit	Representation
-----	----------------

Octet 1

1	G.993.2 profile 8a.
2	G.993.2 profile 8b.
3	G.993.2 profile 8c.
4	G.993.2 profile 8d.
5	G.993.2 profile 12a.
6	G.993.2 profile 12b.
7	G.993.2 profile 17a.
8	G.993.2 profile 30a.

7.3.1.2 Power/PSD configuration parameters

7.3.1.2.1 Downstream maximum nominal power spectral density (MAXNOMPSDds)

This parameter represents the maximum nominal transmit PSD in the downstream direction during initialization and showtime (in dBm/Hz). A single MAXNOMPSDds parameter is defined per mode enabled in the XTSE line configuration parameter. It ranges from -60 to -30 dBm/Hz, with 0.1 dB steps.

7.3.1.2.2 Upstream maximum nominal power spectral density (MAXNOMPSDus)

This parameter represents the maximum nominal transmit PSD in the upstream direction during initialization and showtime (in dBm/Hz). A single MAXNOMPSDus parameter is defined per mode enabled in the XTSE line configuration parameter. It ranges from -60 to -30 dBm/Hz, with 0.1 dB steps.

7.3.1.2.3 Downstream maximum nominal aggregate transmit power (MAXNOMATPDs)

This parameter represents the maximum nominal aggregate transmit power in the downstream direction during initialization and showtime (in dBm). It ranges from 0 to 25.5 dBm, with 0.1 dB steps.

7.3.1.2.4 Upstream maximum nominal aggregate transmit power (MAXNOMATPus)

This parameter represents the maximum nominal aggregate transmit power in the upstream direction during initialization and showtime (in dBm). It ranges from 0 to 25.5 dBm, with 0.1 dB steps.

7.3.1.2.5 Upstream maximum aggregate receive power (MAXRXPWRus)

This parameter represents the maximum upstream aggregate receive power over a set of subcarriers (in dBm) as specified in the relevant Recommendation. The xTU-C shall request an upstream power cutback such that the upstream aggregate receive power over that set of subcarriers is at or below the configured maximum value. It ranges from -25.5 to 25.5 dBm, with 0.1 dB steps. A special value is used to indicate that no upstream maximum aggregate receive power limit is to be applied (i.e., the maximum value is infinite).

7.3.1.2.6 Downstream subcarrier masking (CARMASKDs)

This configuration parameter is an array of boolean values $sc(i)$. Each entry $sc(i)$ defines whether subcarrier with index i is masked on this line in the downstream direction, for i ranging from 0 to NSCds-1. It is coded as 1 if the subcarrier is masked and 0 if the subcarrier is not masked.

NSCds is the highest subcarrier index that can be transmitted in the downstream direction. For [ITU-T G.992.3], [ITU-T G.992.4], and [ITU-T G.992.5], it is defined in the corresponding Recommendations. For [ITU-T G.992.1], NSCds = 256 and for [ITU-T G.992.2], NSCds = 128.

7.3.1.2.7 Upstream subcarrier masking (CARMASKUs)

This configuration parameter is an array of Boolean values $sc(i)$. Each entry $sc(i)$ defines whether transmission of subcarrier with index i is masked on this line in the upstream direction, for i ranging from 0 to NSCUs-1. It is coded as 1 if subcarrier is masked and 0 if the subcarrier is not masked.

NSCUs is the highest subcarrier index that can be transmitted in the upstream direction. For [ITU-T G.992.3], [ITU-T G.992.4] and [ITU-T G.992.5], it is defined in the corresponding Recommendation. For Annex A of [ITU-T G.992.1] and [ITU-T G.992.2], NSCUs = 32 and for Annex B of [ITU-T G.992.1], NSCUs = 64.

7.3.1.2.8 VDSL2 subcarrier masking (VDSL2-CARMASK)

This configuration parameter defines the restrictions, additional to the band plan, to determine the set of subcarriers allowed for transmission in both upstream and downstream directions.

The VDSL2-CARMASK shall describe the not masked subcarriers as one or more frequency bands. Each band is represented by start and stop subcarrier indices with a subcarrier spacing of 4.3125 kHz. The valid range of subcarrier indices specifying the VDSL2-CARMASK is from 0 to at least the index of the highest allowed subcarrier in both transmission directions among all profiles enabled by the parameter PROFILES (see clause 7.3.1.1.11). Up to 32 bands may be specified. Other subcarriers shall be masked.

For profiles using 8.625 kHz tone spacing, the odd subcarrier indices $i_{4.3125}$ in VDSL2-CARMASK shall be transformed into actual subcarrier indices $i_{8.625}$ using the following rule:

- for the start frequency of each band: $i_{8.625} = (i_{4.3125} + 1)/2$
- for the stop frequency of each band: $i_{8.625} = (i_{4.3125} - 1)/2$.

7.3.1.2.9 Downstream PSD Mask (PSDMASKDs)

This configuration parameter defines the downstream PSD mask applicable at the U-C2 reference point as defined in the respective Recommendation. A modified PSD mask, as defined in clause 7.3.1.2.13, may apply at the U-C2 reference point. This MIB PSD mask may impose PSD restrictions in addition to the Limit PSD mask defined in the relevant Recommendation (e.g., [ITU-T G.992.5] and [ITU-T G.993.2]).

NOTE – In [ITU-T G.993.2], the PSDMASKDs parameter is referred to as MIBMASKDs.

The downstream PSD mask in the CO-MIB shall be specified through a set of breakpoints. Each breakpoint shall consist of a subcarrier index t , with a subcarrier spacing of 4.3125 kHz, and a MIB PSD mask level (expressed in dBm/Hz) at that subcarrier. The set of breakpoints can then be represented as $[(t_1, PSD_1), (t_2, PSD_2), \dots, (t_N, PSD_N)]$. The subcarrier index shall be coded as an unsigned integer. The MIB PSD mask level shall be coded as an unsigned integer representing the MIB PSD mask levels 0 dBm/Hz to -127.5 dBm/Hz, in steps of 0.5 dBm/Hz, with valid range from 0 to -95 dBm/Hz. The maximum number of breakpoints is 32.

The requirements for a valid set of breakpoints are defined in the relevant Recommendations (e.g., [ITU-T G.992.5] and [ITU-T G.993.2]).

7.3.1.2.10 RFI bands (RFIBANDS)

For [ITU-T G.992.5], this configuration parameter defines the subset of downstream PSD mask breakpoints, as specified in PSDMASKds, that shall be used to notch an RFI band. This subset consists of couples of consecutive subcarrier indices belonging to breakpoints: $[t_i; t_i + 1]$, corresponding to the low level of the notch. The specific interpolation around these points is defined in the relevant Recommendations (e.g., [ITU-T G.992.5]). The CO-MIB shall define the RFI notches using breakpoints in PSDMASKds as specified in the relevant Recommendations (e.g., [ITU-T G.992.5]).

For [ITU-T G.993.2], this configuration parameter defines the bands where the PSD shall be reduced as specified in clause 7.2.1.2 of [ITU-T G.993.2]. Each band shall be represented by a start and stop subcarrier indices with a subcarrier spacing of 4.3125 kHz. Up to 16 bands may be specified. This parameter defines the RFI bands for both upstream and downstream directions.

7.3.1.2.11 Upstream PSD mask selection

This configuration parameter defines which upstream PSD mask is enabled. This parameter is used only for Annexes J and M of [ITU-T G.992.3] and [ITU-T G.992.5]. As only one selection parameter is defined in the MIB, the same selection value applies to all relevant modes enabled in the XTSE line configuration parameter. It ranges from 1 to 9 and selects the mask with the definitions of Table 7-5.

Table 7-5 – Definitions of values of upstream PSD mask selection parameter for Annexes J and M of [ITU-T G.992.3] and [ITU-T G.992.5]

Upstream PSD mask selection value	Selected mask	
	Annex J of ITU-T G.992.3 and ITU-T G.992.5	Annex M of ITU-T G.992.3 and ITU-T G.992.5
1	ADLU-32	EU-32
2	ADLU-36	EU-36
3	ADLU-40	EU-40
4	ADLU-44	EU-44
5	ADLU-48	EU-48
6	ADLU-52	EU-52
7	ADLU-56	EU-56
8	ADLU-60	EU-60
9	ADLU-64	EU-64

7.3.1.2.12 Upstream PSD mask (PSDMASKus)

This configuration parameter defines the upstream PSD mask applicable at the U-R2 reference point as defined in the respective Recommendation. This MIB PSD mask may impose PSD restrictions in addition to the Limit PSD mask defined in the relevant Recommendations (e.g., [ITU-T G.992.3], [ITU-T G.993.2]).

NOTE – In [ITU-T G.993.2], the PSDMASKus parameter is referred to as MIBMASKus and does not include breakpoints to shape US0.

The upstream PSD mask in the CO-MIB shall be specified through a set of breakpoints. Each breakpoint shall consist of a subcarrier index t_i , with a subcarrier spacing of 4.3125 kHz, and a MIB PSD mask level (expressed in dBm/Hz) at that subcarrier. The set of breakpoints can then be represented as $[(t_1, PSD_1), (t_2, PSD_2), \dots, (t_N, PSD_N)]$. The subcarrier index shall be coded as an unsigned integer. The MIB PSD mask level shall be coded as an unsigned integer representing the

MIB PSD mask levels 0 dBm/Hz to –127.5 dBm/Hz, in steps of 0.5 dBm/Hz, with valid range from 0 to –95 dBm/Hz. The maximum number of breakpoints is 4 for [ITU-T G.992.3] and 16 for [ITU-T G.993.2].

The requirements for a valid set of breakpoints are defined in the relevant Recommendations (e.g., [ITU-T G.992.3] or [ITU-T G.993.2]).

7.3.1.2.13 Downstream power back-off – Shaped (DPBOSHAPED)

This clause provides a set of line configuration parameters and a procedure to generate a modified downstream MIB PSD mask. The modified PSD mask shall be used instead of PSDMASKds to configure the downstream PSD mask applicable at the U-C2 reference point. An example of application of this method is described in Appendix II.

a) Downstream power back-off configuration parameters

a.1) Assumed exchange PSD mask (DPBOEPSD)

This parameter defines the PSD mask that is assumed to be permitted at the exchange. This parameter shall use the same format as PSDMASKds.

The maximum number of breakpoints for DPBOEPSD is 16.

a.2) E-side electrical length (DPBOESEL)

This configuration parameter defines the assumed electrical length of cables (E-side cables) connecting exchange based DSL services to a remote flexibility point (cabinet), that hosts the xTU-C that is subject to spectrally shaped downstream power back-off depending on this length. For this parameter the electrical length is defined as the loss (in dB) of an equivalent length of hypothetical cable at a reference frequency defined by the network operator or in spectrum management regulations. DPBOESEL shall be coded as an unsigned integer representing an electrical length from 0 dB to 255.5 dB in steps of 0.5 dB. All values in the range are valid.

If DPBOESEL is set to zero, the DPBO in this clause shall be disabled.

a.3) E-side cable model (DPBOESCM)

This configuration parameter defines a cable model in terms of three scalars DPBOESCMA, DPBOESCMB and DPBOESCMC that shall be used to describe the frequency dependent loss of E-side cables using the formula:

$$ESCM(f) = (DPBOESCMA + DPBOESCMB \cdot \sqrt{f} + DPBOESCMC \cdot f) \cdot DPBOESEL$$

where ESCM is expressed in dB and f is expressed in MHz. Parameters DPBOESCMA, DPBOESCMB, DPBOESCMC shall be coded as unsigned integers representing a scalar value from –1 to 1.5 in steps of 2^{-8} . All values in the range are valid.

a.4) Minimum usable signal (DPBOMUS)

DPBOMUS defines the assumed minimum usable receive PSD mask (in dBm/Hz) for exchange based services, used to modify parameter DPBOFMAX defined below. It shall be coded as an unsigned integer representing a PSD mask level from 0 dBm/Hz to –127.5 dBm/Hz in steps of 0.5 dB. All values in the range are valid.

NOTE – The PSD mask level is 3.5 dB above the signal PSD level.

a.5) DPBO span minimum frequency (DPBOFMIN)

DPBOFMIN defines the minimum frequency from which the DPBO shall be applied. It ranges from 0 kHz to 8832 kHz in steps of 4.3125 kHz.

a.6) *DPBO span maximum frequency (DPBOFMAX)*

DPBOFMAX defines the maximum frequency at which DPBO may be applied. It ranges from 138 kHz to 29997.75 kHz in steps of 4.3125 kHz.

b) **Downstream power back-off variables derived from PSDMASKds**

These variables are not directly accessible through the Q interface and shall be derived in the AN from the PSDMASKds parameter.

b1) *DPBO maximum PSD mask (DPBOPSDMASKds)*

If the set of breakpoint defining PSDMASKds (t_i, PSD_i) are monotonic in frequency, i.e., $t_i \leq t_{i+1}$ for $0 < i \leq 32$, then DPBOPSDMASKds = PSDMASKds.

If there exists in the set of breakpoints PSDMASKds (t_i, PSD_i) a single violation of monotonic frequency sequence, i.e., $t_d > t_{d+1}$, then DPBOPSDMASKds = PSDMASKds (t_i, PSD_i), $0 < i \leq d$.

b2) *DPBO low frequency override (DPBOLFO)*

This parameter defines the PSD mask that overrides DPBO at low frequencies. If there exists in the set of breakpoints PSDMASKds (t_i, PSD_i) a single violation of monotonic frequency sequence, i.e., $t_d > t_{d+1}$, then DPBOLFO = PSDMASKds (t_i, PSD_i), $d < i \leq 32$. Otherwise, DPBOLFO shall be assumed to be -91.5 dBm/Hz or less everywhere.

c) **Procedure to derive the modified downstream PSD mask**

From the parameters defined in the above section and the PSDMASKds, a modified PSD mask after downstream power back-off shall be derived using the following method:

- The "Predicted Attenuated Exchange PSD Mask" (PEPSD(f)) is defined as:

$$PEPSD(f) = DPBOEPSD(f) - (DPBOESCMA + DPBOESCMB \cdot \sqrt{f} + DPBOESCMC \cdot f) \cdot DPBOESEL$$

- The maximum usable frequency (MUF) is defined as the highest frequency for which the PEPSD(f) is greater than DPBOMUS.
- The minimum PSD mask, DPBOMPSD(f), is defined between frequencies DPBOFMIN and $F_1 = \min(DPBOFMAX, MUF)$ as:

$$DPBOMPSD(f) = \begin{cases} \max[DPBOLFO(f), -91.5] \text{ dBm/Hz} & \text{for } f \leq F_1 - 175 \text{ kHz} \\ \max[DPBOLFO(f), \frac{11.5}{175}(f - F_1) - 80] \text{ dBm/Hz} & \text{for } F_1 - 175 \text{ kHz} < f < F_1 \end{cases}$$

where f is expressed in kHz.

- The downstream power back-off is applied so that at each frequency the resultant PSD mask is equal to:

$$RESULTMASKds(f) = \begin{cases} \max[\min(DPBOPSDMASKds(f), PEPSD(f)), DPBOMPSD(f)] & DPBOFMIN \leq f \leq F_1 \\ DPBOPSDMASKds(f) & \text{Otherwise} \end{cases}$$

- Finally, a modified PSD mask shall be set as close as possible to, but everywhere less than the RESULTMASKds. This mask shall comply with the constraints of the relevant Recommendations. Its computation is vendor discretionary. This modified mask is applied to the xTU-C.

7.3.1.2.14 Upstream power back-off shaped (UPBOSHAPED)

Upstream power back-off (UPBO) is specified in [ITU-T G.993.2] to provide spectral compatibility between loops of different lengths deployed in the same binder. The upstream transmit PSD mask, UPBOMASKus is defined in clause 7.2.1.3.2 of [ITU-T G.993.2].

The ITU-T G.993.2 UPBO configuration parameters a , b , and the reference electrical lengths kl_{0_REF} shall be set by the NMS in the CO-MIB. The parameter kl_0 may be determined during initialization by the VTUs or forced by the CO-MIB.

a) Upstream power back-off configuration parameters

a.1) Upstream power back-off reference PSD per band (UPBOPSD-pb)

This parameter defines the UPBO reference PSD used to compute the upstream power back-off for each upstream band except US0. A UPBOPSD defined for each band shall consist of two parameters [a , b]. Parameter a ranges from 40 dBm/Hz to 80.95 dBm/Hz in steps of 0.01 dBm/Hz; and parameter b ranges from 0 to 40.95 dBm/Hz in steps of 0.01 dBm/Hz. The UPBO reference PSD at the frequency f expressed in MHz shall be equal to $-a-b\sqrt{f}$. The set of parameter values $a = 40$ dBm/Hz, $b = 0$ dBm/Hz is a special configuration to disable UPBO in the respective upstream band.

a.2) Upstream electrical length (UPBOKL)

This parameter defines the electrical length expressed in dB at 1 MHz, kl_0 , configured by the CO-MIB. The value ranges from 0 to 128 dB in steps of 0.1 dB.

a.3) Force CO-MIB electrical length (UPBOKLF)

This parameter is a flag that forces the VTU-R to use the electrical length of the CO-MIB (UPBOKL) to compute the UPBO. The value shall be forced if the flag is set to 1. Otherwise, the VTUs shall determine the electrical length.

a.4) UPBO reference electrical length per band (UPBOKLREF-pb)

This parameter defines the UPBO reference electrical length used to compute the upstream power back-off for each upstream band except US0, for the optional Equalized FEXT UPBO method. The value ranges from 1.8 to 63.5 dB in steps of 0.1 dB with special value 0. The use of the special value 0 is described in clause 7.2.1.3.2 of [ITU-T G.993.2].

7.3.1.2.15 VDSL2 PSD mask class selection (CLASSMASK)

In order to reduce the number of configuration possibilities, the limit power spectral density masks (limit PSD masks) are grouped in the following PSD mask classes:

- Class 998 Annex A of [ITU-T G.993.2]: D-32, D-48, D-64, D-128.
- Class 997-M1c Annex B of [ITU-T G.993.2]: 997-M1c-A-7.
- Class 997-M1x Annex B of [ITU-T G.993.2]: 997-M1x-M-8, 997-M1x-M.
- Class 997-M2x Annex B of [ITU-T G.993.2]: 997-M2x-M-8, 997-M2x-A, 997-M2x-M, 997E17-M2x-NUS0, 997E30-M2x-NUS0.
- Class 998-M1x Annex B of [ITU-T G.993.2]: 998-M1x-A, 998-M1x-B, 998-M1x-NUS0.
- Class 998-M2x Annex B of [ITU-T G.993.2]: 998-M2x-A, 998-M2x-M, 998-M2x-B, 998-M2x-NUS0, 998E17-M2x-NUS0, 998E17-M2x-NUS0-M, 998E30-M2x-NUS0, 998E30-M2x-NUS0-M.
- Class 998ADE-M2x Annex B of [ITU-T G.993.2]: 998-M2x-A, 998-M2x-M, 998-M2x-B, 998-M2x-NUS0, 998ADE17-M2x-A, 998ADE17-M2x-B, 998ADE17-M2x-NUS0-M, 998ADE30-M2x-NUS0-A, 998ADE30-M2x-NUS0-M.
- Class 998-B Annex C: POTS-138b, POTS-276b (clause C.2.1.1 of [ITU-T G.993.2]), TCM-ISDN (C.2.1.2/G.993.2).
- Class 998-CO Annex C of [ITU-T G.993.2]: POTS-138co, POTS-276co (clause C.2.1.1 of [ITU-T G.993.2]).
- Class HPE-M1 Annex B of [ITU-T G.993.2]: HPE17-M1-NUS0, HPE30-M1-NUS0.

Each class is designed such that the PSD levels of each limit PSD mask of a specific class are equal in their respective passband above 552 kHz.

One CLASSMASK parameter is defined per the G.993.2 Annex enabled in the XTSE. It selects a single PSD mask class per the G.993.2 Annex that is activated at the VTU-O. The coding is as indicated in Table 7-6.

Table 7-6 – Definition of values of CLASSMASK per G.993.2 Annex

Parameter value	ITU-T G.993.2 Annex A	ITU-T G.993.2 Annex B	ITU-T G.993.2 Annex C
1	998	997-M1c	998-B
2		997-M1x	998-CO
3		997-M2x	
4		998-M1x	
5		998-M2x	
6		998ADE-M2x	
7		HPE	
NOTE – A single PSD mask class shall be selected per G.993.2 Annex.			

7.3.1.2.16 VDSL2 limit PSD masks and band plans enabling (LIMITMASK)

This configuration parameter contains the G.993.2 limit PSD masks of the selected PSD mask class, enabled by the near-end xTU on this line for each class of profiles. One LIMITMASK parameter is defined per the G.993.2 Annex enabled in the XTSE.

The profiles are grouped in the following profile classes:

- Class 8: Profiles 8a, 8b, 8c, 8d
- Class 12: Profiles 12a, 12b
- Class 17: Profile 17a
- Class 30: Profile 30a

For each profile class, several limit PSD masks of the selected PSD mask class (CLASSMASK) may be enabled. The enabling parameter is coded in a bit-map representation (0 if the associated mask is not allowed, 1 if it is allowed).

The parameter has the bit definitions for each PSD mask class as indicated in Table 7-7.

Table 7-7 – Definition of bits of LIMITMASK for each CLASSMASK

Bit number	Profile class	PSD mask classes									
		Annex A	Annex B							Annex C	
		998 Annex A	998-M1x Annex B	998-M2x Annex B	998ADE-M2x Annex B	997-M1x Annex B	997-M1c Annex B	997-M2x Annex B	HPE-M1 Annex B	998-B Annex C	998-CO Annex C
<i>Octet 1</i>											
1	8	D-32	M1x-A	M2x-A	M2x-A		M1c-A-7	M2x-A		POTS-138b	POTS_138co
2	8	D-48	M1x-B	M2x-B	M2x-B	M1x-M-8		M2x-M-8		TCM-ISDN	POTS_276co
3	8			M2x-M	M2x-M	M1x-M		M2x-M		POTS_276b	
4	8		M1x-NUS0	M2x-NUS0	M2x-NUS0						
5	8										
6	8										
7	8										
8	8										
<i>Octet 2</i>											
1	8	D-64									
2	8	D-128									
3	8										
4	8										
5	8										
6	8										
7	8										
8	8										

Table 7-7 – Definition of bits of LIMITMASK for each CLASSMASK

Bit number	Profile class	PSD mask classes									
		Annex A	Annex B							Annex C	
		998 Annex A	998-M1x Annex B	998-M2x Annex B	998ADE-M2x Annex B	997-M1x Annex B	997-M1c Annex B	997-M2x Annex B	HPE-M1 Annex B	998-B Annex C	998-CO Annex C
<i>Octet 3</i>											
1	12	D-32	M1x-A	M2x-A	M2x-A			M2x-A		POTS-138b	POTS_138co
2	12	D-48	M1x-B	M2x-B	M2x-B					TCM-ISDN	POTS_276co
3	12			M2x-M	M2x-M	M1x-M		M2x-M		POTS_276b	
4	12		M1x-NUS0	M2x-NUS0	M2x-NUS0						
5	12										
6	12										
7	12										
8	12										
<i>Octet 4</i>											
1	12	D-64									
2	12	D-128									
3	12										
4	12										
5	12										
6	12										
7	12										
8	12										

Table 7-7 – Definition of bits of LIMITMASK for each CLASSMASK

Bit number	Profile class	PSD mask classes									
		Annex A	Annex B							Annex C	
		998 Annex A	998-M1x Annex B	998-M2x Annex B	998ADE-M2x Annex B	997-M1x Annex B	997-M1c Annex B	997-M2x Annex B	HPE-M1 Annex B	998-B Annex C	998-CO Annex C
<i>Octet 5</i>											
1	17	D-32		E17-M2x-NUS0	ADE17-M2x-A			E17-M2x-NUS0	17-M1-NUS0	POTS-138b	
2	17	D-48		E17-M2x-NUS0-M	ADE17-M2x-B					TCM-ISDN	
3	17				ADE17-M2x-NUS0-M					POTS_276b	
4	17										
5	17										
6	17										
7	17										
8	17										
<i>Octet 6</i>											
1	17	D-64									
2	17	D-128									
3	17										
4	17										
5	17										
6	17										
7	17										
8	17										

Table 7-7 – Definition of bits of LIMITMASK for each CLASSMASK

Bit number	Profile class	PSD mask classes									
		Annex A	Annex B							Annex C	
		998 Annex A	998-M1x Annex B	998-M2x Annex B	998ADE-M2x Annex B	997-M1x Annex B	997-M1c Annex B	997-M2x Annex B	HPE-M1 Annex B	998-B Annex C	998-CO Annex C
<i>Octet 7</i>											
1	30	D-32		E30-M2x-NUS0	ADE30-M2x-NUS0-A			E30-M2x-NUS0	30-M1-NUS0	POTS-138b	
2	30	D-48		E30-M2x-NUS0-M	ADE30-M2x-NUS0-M					TCM-ISDN	
3	30									POTS_276b	
4	30										
5	30										
6	30										
7	30										
8	30										
<i>Octet 8</i>											
1	30	D-64									
2	30	D-128									
3	30										
4	30										
5	30										
6	30										
7	30										
8	30										
NOTE – All unassigned bits are reserved by ITU.											

7.3.1.2.17 VDSL2 US0 disabling (US0DISABLE)

This configuration parameter indicates if the use of US0 is disabled for each limit PSD mask enabled in the LIMITMASK parameter. One US0DISABLE parameter is defined per the G.993.2 Annex enabled in the XTSE.

For each limit PSD mask enabled in the LIMITMASK parameter, a bit shall indicate if US0 is disabled. The disabling parameter is coded as a bit-map. The bit is set to 1 if US0 is disabled for the associated limit mask. The bit-map has the same structure as the LIMITMASK parameter.

7.3.1.2.18 VDSL2 US0 PSD masks (US0MASK)

This parameter contains the US0 PSD masks to be allowed by the near-end xTU on the line. This parameter is only defined for Annex A of [ITU-T G.993.2]. It is represented as a bitmap (0 if not allowed and 1 if allowed) with the definitions of Table 7-8.

Table 7-8 – Definition of bits of US0MASK for Annex A of [ITU-T G.993.2]

Bit	Annex A of [ITU-T G.993.2] US0MASK
<i>Octet 1</i>	
1	EU-32
2	EU-36
3	EU-40
4	EU-44
5	EU-48
6	EU-52
7	EU-56
8	EU-60
<i>Octet 2</i>	
1	EU-64
2	EU-128
3	reserved by ITU
4	reserved by ITU
5	reserved by ITU
6	reserved by ITU
7	reserved by ITU
8	reserved by ITU
<i>Octet 3</i>	
1	ADLU-32
2	ADLU-36
3	ADLU-40
4	ADLU-44
5	ADLU-48
6	ADLU-52

**Table 7-8 – Definition of bits of US0MASK
for Annex A of [ITU-T G.993.2]**

Bit	Annex A of [ITU-T G.993.2] US0MASK
7	ADLU-56
8	ADLU-60
<i>Octet 4</i>	
9	ADLU-64
10	ADLU-128
11	reserved by ITU
12	reserved by ITU
13	reserved by ITU
14	reserved by ITU
15	reserved by ITU
16	reserved by ITU
NOTE 1 – Valid combinations of US0MASK and LIMITMASK are described in [ITU-T G.993.2].	
NOTE 2 – More than one mask may be enabled simultaneously. If no US0 PSD masks are enabled, the line is configured without US0 support.	

7.3.1.3 Noise margin configuration parameters

The following configuration parameters are defined to control the noise margin in the receive direction in the xTU. A downstream noise margin applies to the xTU-R, an upstream noise margin applies to the xTU-C.

NOTE – The noise margin should be controlled to ensure operation at the target BER (bit error ratio) for each of the received bearer channels, or better. Figure 7-3 shows the relationship between these parameters. They will be described in detail in the following clauses.

Maximum noise margin	Reduce transmit power ----- Increase data rate if noise margin > Upshift noise margin for upshift interval
Upshift noise margin	----- Steady state operation
Target noise margin	----- Steady state operation
Downshift noise margin	----- Decrease data rate if noise margin < Downshift noise margin for downshift interval
Minimum noise margin	----- Increase transmit power. If not possible – reinitialize

NOTE 1 – Upshift noise margin, and downshift noise margin are only supported for rate adaptive mode.

NOTE 2 – Minimum noise margin ≤ Downshift noise margin ≤ Target noise margin ≤ Upshift noise margin ≤ Maximum noise margin.

Figure 7-3 – Noise margins

7.3.1.3.1 Downstream target noise margin (TARSNRMds)

This is the noise margin that the xTU-R receiver shall achieve, relative to the BER requirement for each of the downstream bearer channels, or better, to successfully complete initialization. The target noise margin ranges from 0 to 31 dB, with 0.1 dB steps.

7.3.1.3.2 Upstream target noise margin (TARSNRMus)

This is the noise margin that the xTU-C receiver shall achieve, relative to the BER requirement for each of the upstream bearer channels, or better, to successfully complete initialization. The target noise margin ranges from 0 to 31 dB, with 0.1 dB steps.

7.3.1.3.3 Downstream maximum noise margin (MAXSNRMds)

This is the maximum noise margin the xTU-R receiver shall try to sustain. If the noise margin is above this level, the xTU-R shall request the xTU-C to reduce the xTU-C transmit power to get a noise margin below this limit (if this functionality is supported by the relevant DSL Recommendation – see Note 1). The maximum noise margin ranges from 0 to 31 dB with 0.1 dB steps. A special value is used to indicate that reduction in transmit power is not required for the purpose of reducing the noise margin below the maximum noise margin limit (i.e., the maximum noise margin value is infinite).

NOTE 1 – This functionality should be supported by ADSL transmission systems. This functionality is supported by ADSL2 transmission systems.

NOTE 2 – The transmit power may be reduced for other reasons.

7.3.1.3.4 Upstream maximum noise margin (MAXSNRMus)

This is the maximum noise margin the xTU-C receiver shall try to sustain. If the noise margin is above this level, the xTU-C shall request the xTU-R to reduce the xTU-R transmit power to get a noise margin that is below this limit (if this functionality is supported by the relevant DSL Recommendation – see Note 1). The maximum noise margin ranges from 0 to 31 dB, with 0.1 dB steps. A special value is used to indicate that reduction in transmit power is not required for the purpose of reducing the noise margin below the maximum noise margin limit (i.e., the maximum noise margin value is infinite).

NOTE 1 – This functionality should be supported by ADSL transmission systems. This functionality is supported by ADSL2 transmission systems.

NOTE 2 – The transmit power may be reduced for other reasons.

7.3.1.3.5 Downstream minimum noise margin (MINSNRMds)

This is the minimum noise margin the xTU-R receiver shall tolerate. If the noise margin falls below this level, the xTU-R shall request the xTU-C to increase the xTU-C transmit power. If an increase to xTU-C transmit power is not possible, a loss-of-margin (LOM) defect occurs, the xTU-R shall fail and attempt to re-initialize and the NMS shall be notified. The minimum noise margin ranges from 0 to 31 dB, with 0.1 dB steps.

7.3.1.3.6 Upstream minimum noise margin (MINSNRMus)

This is the minimum noise margin the xTU-C receiver shall tolerate. If the noise margin falls below this level, the xTU-C shall request the xTU-R to increase the xTU-R transmit power. If an increase of xTU-R transmit power is not possible, a loss-of-margin (LOM) defect occurs, the xTU-C shall fail and attempt to re-initialize and the NMS shall be notified. The minimum noise margin ranges from 0 to 31 dB, with 0.1 dB steps.

7.3.1.4 Rate adaptation configuration parameters

The following configuration parameters are defined to manage the rate-adaptive behaviour in the transmit direction for both the xTU-C and the xTU-R. An xTU-C rate adaptation mode applies to the upstream direction. An xTU-R rate adaptation mode applies to the downstream direction.

7.3.1.4.1 Downstream rate adaptation mode (RA-MODEs)

This parameter specifies the mode of operation of a rate-adaptive xTU-C in the transmit direction. The parameter can take three values.

Mode 1: MANUAL – Rate changed manually.

At startup

The downstream minimum data rate parameter specifies the exact data rate the xTU-C transmitter shall operate at for each of the bearer channels, with a downstream noise margin which is at least as large as the specified downstream target noise margin, relative to the required BER for each of the downstream bearer channels, or better. If the xTU-C fails to achieve the downstream minimum data rate for one of the bearer channels, the xTU-C will fail to initialize, and the NMS will be notified. Although the xTU-C and the line might be able to support a higher data rate, the xTU-C shall not transmit a higher data rate than what is requested for each of the bearer channels.

At showtime

The xTU-C transmitter shall maintain the specified downstream minimum data rate for each of the bearer channels.

Mode 2: AT_INIT – Rate automatically selected at startup only and does not change after that.

At startup

The downstream minimum data rate parameter specifies the minimum data rate the xTU-C transmitter shall operate at for each of the bearer channels, with a downstream noise margin which is at least as large as the specified downstream target noise margin, relative to the required BER for each of the bearer channels, or better. If the xTU-C fails to achieve the downstream minimum data rate for one of the bearer channels, the xTU-C will fail to initialize, and the NMS will be notified. If the xTU-C transmitter is able to support a higher downstream data rate at initialization, the excess data rate will be distributed amongst the downstream bearer channels according to the ratio (0 to 100%) specified by the rate adaptation ratio parameter for each bearer channel (adding up to 100% over all bearer channels). When the downstream maximum data rate is achieved in one of the bearer channels, then the remaining excess bit rate is assigned to the other bearer channels, still according to their relative rate adaptation ratio parameters. As long as the downstream data rate is below the downstream maximum data rate for one of the bearer channels, data rate increase shall take priority over transmit power reduction.

At showtime

During showtime, no downstream data rate adaptation is allowed. The downstream data rate, which has been selected during initialization for each of the bearer channels, shall be maintained.

Mode 3: DYNAMIC – Data rate is automatically selected at initialization and is continuously adapted during operation (showtime). The DYNAMIC rate adaptation mode is optional. All related configuration parameters are also optional.

At startup

In Mode 3, the xTU-C shall start up as in Mode 2.

At showtime

During showtime, rate adaptation is allowed with respect to the rate adaptation ratio for distributing the excess data rate amongst the bearer channels (see Mode 2), and assuring that the downstream minimum data rate remains available at the required BER for each of the bearer channels or better. The downstream data rate can vary between the downstream minimum data rate, and the downstream maximum data rate. Downstream rate adaptation is performed when the conditions specified for downstream upshift noise margin and downstream upshift interval – or for downstream downshift noise margin and downstream downshift interval – are satisfied. This means:

- For an upshift action: Allowed when the downstream noise margin is above the downstream upshift noise margin during downstream minimum time interval for upshift rate adaptation (i.e., upon RAU anomaly – see [ITU-T G.992.3]).
- For a downshift action: Allowed when the downstream noise margin is below the downstream downshift noise margin during downstream minimum time interval for downshift rate adaptation (i.e., upon RAD anomaly – see [ITU-T G.992.3]).

As long as the downstream data rate is below the downstream maximum data rate for one of the bearer channels, data rate increase shall take priority over transmit power reduction.

If in [ITU-T G.993.2], it is detected at startup that SRA is not supported in the downstream direction by either XTU, the XTUs shall fallback to Mode 2.

Mode 4: DYNAMIC with SOS – Data rate is automatically selected at initialization and may be continuously adapted during operation (showtime) by SOS and SRA. The rate adaptation Mode 4 is optional. In this mode, enabling of SOS and SRA is mandatory.

At startup

In Mode 4, the xTU-C shall start up as in Mode 2.

At showtime

SRA behaviour shall be identical as described for Mode 3, unless the actual net data rate is below the minimum net data rate as a result of an SOS procedure.

Additionally, SOS may be performed, when the conditions specified by the SOS trigger parameters are satisfied. The detailed specification of SOS OLR procedure is in [ITU-T G.993.2].

If at startup it is detected that SOS is not supported in the downstream direction by either XTU, but SRA is supported by both XTUs, the XTUs shall fallback to Mode 3.

If at startup it is detected that SOS is not supported in the downstream direction by either XTU, and SRA is not supported by either XTU, the XTUs shall fallback to Mode 2.

7.3.1.4.2 Upstream rate adaptation mode (RA-MODEus)

This parameter specifies the mode of operation of a rate-adaptive xTU-R in the transmit direction. The parameter is used only if the rate-adaptive functionality is supported, and can take four values (Mode 1 = MANUAL, Mode 2 = AT_INIT, Mode 3 = DYNAMIC, Mode 4 = DYNAMIC with SOS). The definition of each of the values is identical to its definition in the downstream rate adaptation mode (with xTU-C replaced by xTU-R and downstream replaced by upstream).

7.3.1.4.3 Downstream upshift noise margin (RA-USNRMds)

If the downstream noise margin is above the downstream upshift noise margin and stays above that for more than the time specified by the downstream minimum upshift rate adaptation interval, the xTU-R shall attempt to increase the downstream net data rate. The downstream upshift noise margin ranges from 0 to 31 dB, with 0.1 dB steps.

7.3.1.4.4 Upstream upshift noise margin (RA-USNRMus)

If the upstream noise margin is above the upstream upshift noise margin and stays above that for more than the time specified by the upstream minimum upshift rate adaptation interval, the xTU-C shall attempt to increase the upstream net data rate. The upstream upshift noise margin ranges from 0 to 31 dB, with 0.1 dB steps.

7.3.1.4.5 Downstream minimum time interval for upshift rate adaptation (RA-UTIMEds)

This parameter defines the interval of time the downstream noise margin should stay above the downstream upshift noise margin before the xTU-R shall attempt to increase the downstream net data rate. The time interval ranges from 0 to 16'383 s with steps of one second.

7.3.1.4.6 Upstream minimum time interval for upshift rate adaptation (RA-UTIMEus)

This parameter defines the interval of time the upstream noise margin should stay above the upstream upshift noise margin before the xTU-C shall attempt to increase the upstream net data rate. The time interval ranges from 0 to 16'383 s with steps of one second.

7.3.1.4.7 Downstream downshift noise margin (RA-DSNRMds)

If the downstream noise margin is below the downstream downshift noise margin and stays below that for more than the time specified by the downstream minimum downshift rate adaptation interval, the xTU-R shall attempt to decrease the downstream net data rate. The downstream downshift noise margin ranges from 0 to 31 dB, with 0.1 dB steps.

7.3.1.4.8 Upstream downshift noise margin (RA-DSNRMus)

If the upstream noise margin is below the upstream downshift noise margin and stays below that for more than the time specified by the upstream minimum downshift rate adaptation interval, the xTU-C shall attempt to decrease the upstream net data rate. The upstream downshift noise margin ranges from 0 to 31 dB, with 0.1 dB steps.

7.3.1.4.9 Downstream minimum time interval for downshift rate adaptation (RA-DTIMEds)

This parameter defines the interval of time the downstream noise margin should stay below the downstream downshift noise margin before the xTU-R shall attempt to decrease the downstream net data rate. The time interval ranges from 0 to 16'383 s with steps of one second.

7.3.1.4.10 Upstream minimum time interval for downshift rate adaptation (RA-DTIMEus)

This parameter defines the interval of time the upstream noise margin should stay below the upstream downshift noise margin before the xTU-C shall attempt to decrease the upstream net data rate. The time interval ranges from 0 to 16'383 s with steps of one second.

7.3.1.5 Line overhead configuration parameters

These parameters are used for testing purposes.

7.3.1.5.1 Minimum overhead rate upstream (MSGMINus)

This parameter defines the minimum rate of the message based overhead that shall be maintained by the xTU in the upstream direction. MSGMINus is expressed in bits per second and ranges from 4'000 to 248'000 bit/s with 1'000 bit/s steps. Valid values are specified in the relevant ITU-T Recommendation, e.g., [ITU-T G.992.3] and [ITU-T G.993.2].

7.3.1.5.2 Minimum overhead rate downstream (MSGMINds)

This parameter defines the minimum rate of the message based overhead that shall be maintained by the xTU in the downstream direction. MSGMINds is expressed in bits per second and ranges from 4'000 to 248'000 bit/s with 1'000 bit/s steps. Valid values are specified in the relevant ITU-T Recommendation, e.g., [ITU-T G.992.3] and [ITU-T G.993.2].

7.3.1.6 Cyclic extension configuration parameter

7.3.1.6.1 Optional cyclic extension flag (CEFLAG)

This parameter is a bit that enables the use of the optional cyclic extension values. If the bit is set to 1, the optional cyclic extension values may be used. Otherwise, the cyclic extension shall be forced to the mandatory length ($5N/32$).

7.3.1.7 Transmitter referred virtual noise configuration parameters

7.3.1.7.1 Downstream signal-to-noise ratio mode (SNRMODE_{ds})

This parameter enables the transmitter referred virtual noise in the downstream direction. If set to 1, the virtual noise is disabled. If set to 2, the virtual noise is enabled.

7.3.1.7.2 Upstream signal-to-noise ratio mode (SNRMODE_{us})

This parameter enables the transmitter referred virtual noise in the upstream direction. If set to 1, the virtual noise is disabled. If set to 2, the virtual noise is enabled.

7.3.1.7.3 Downstream transmitter referred virtual noise (TXREFVN_{ds})

This configuration parameter defines the downstream transmitter referred virtual noise (TXREFVN_{ds}). The TXREFVN_{ds} shall be specified through a set of breakpoints. Each breakpoint shall consist of a subcarrier index t , with a subcarrier spacing of 4.3125 kHz, and a noise PSD level (expressed in dBm/Hz) at that subcarrier. The set of breakpoints can then be represented as $[(t_1, PSD_1), (t_2, PSD_2), \dots, (t_N, PSD_N)]$. The subcarrier index shall be coded as an unsigned integer. The noise level ranges from -40 dBm/Hz to -140 dBm/Hz in steps of 0.5 dBm/Hz. A special value indicates a noise level of 0 W/Hz. The maximum number of breakpoints is 32. The same TXREFVN_{ds} format shall be applied to G.992.3 and G.992.5 Annex C FEXT TXREFVN_{ds} and NEXT TXREFVN_{ds}.

For ITU-T G.992.3 or ITU-T G.992.5, no more than 15 breakpoints shall be configured below the upper edge of the passband of every mode enabled for ITU-T G.992.3 and ITU-T G.992.5.

7.3.1.7.3.1 FEXT downstream transmitter referred virtual noise (FEXT TXREFVN_{ds})

For ITU-T G.992.3 (ADSL2) Annex C and ITU-T G.992.5 (ADSL2plus) Annex C, the downstream transmitter referred virtual noise (see clause 7.3.1.7.3) specified for FEXT_R duration is defined as FEXT downstream transmitter referred virtual noise (FEXT TXREFVN_{ds}).

7.3.1.7.3.2 NEXT downstream transmitter referred virtual noise (NEXT TXREFVN_{ds})

For ITU-T G.992.3 (ADSL2) Annex C and ITU-T G.992.5 (ADSL2plus) Annex C, the downstream transmitter referred virtual noise (see clause 7.3.1.7.3) specified for NEXT_R duration is defined as NEXT downstream transmitter referred virtual noise (NEXT TXREFVN_{ds}).

7.3.1.7.4 Upstream transmitter referred virtual noise (TXREFVN_{us})

This configuration parameter defines the upstream transmitter referred virtual noise (TXREFVN_{us}). The TXREFVN_{us} shall be specified through a set of breakpoints. Each breakpoint shall consist of a subcarrier index t , with a subcarrier spacing of 4.3125 kHz, and a noise PSD level (expressed in dBm/Hz) at that subcarrier. The set of breakpoints can then be represented as $[(t_1, PSD_1), (t_2, PSD_2), \dots, (t_N, PSD_N)]$. The subcarrier index shall be coded as an unsigned integer. The noise level ranges from -40 dBm/Hz to -140 dBm/Hz in steps of 0.5 dBm/Hz. A special value indicates a noise level of 0 W/Hz. The maximum number of breakpoints is 16.

For ITU-T G.992.3 or ITU-T G.992.5, no more than 3 breakpoints shall be configured below the upper edge of the passband of every mode enabled for ITU-T G.992.3 and ITU-T G.992.5.

7.3.1.8 Line performance monitoring parameter thresholds

All supported line performance monitoring parameters (counters, see Table 7-1) shall have an individual 15-minute and 24-hour threshold parameter.

7.3.1.9 INM configuration parameters

The following configuration parameters are defined to control the impulse noise monitor in the receive direction in the xTU. A downstream impulse noise monitor applies to the xTU-R, an upstream impulse noise monitor applies to the xTU-C.

7.3.1.9.1 INM inter arrival time offset (INMIATO)

This is the inter arrival time offset that the xTU receiver shall use to determine in which bin of the inter arrival time histogram the IAT is reported. The valid values for INMIATO ranges from 3 to 511 DMT symbols in steps of 1 DMT symbol.

7.3.1.9.2 INM inter arrival time step (INMIATS)

This is the inter arrival time step that the xTU receiver shall use to determine in which bin of the inter arrival time histogram the IAT is reported. The valid values for INMIATS ranges from 0 to 7 in steps of 1.

7.3.1.9.3 INM cluster continuation value (INMCC)

This is the cluster continuation value that the xTU receiver shall use in the cluster indication process described in the relevant ITU-T Recommendation. The valid values for INMCC range from 0 to 64 DMT symbols in steps of one DMT symbol.

7.3.1.9.4 INM equivalent INP mode (INM_INPEQ_MODE)

This is the INM equivalent INP mode that the xTU receiver shall use in the computation of the Equivalent INP, as defined in the relevant ITU-T Recommendation. The valid values for INM_INPEQ_MODE are 0, 1, 2, 3, and 4.

7.3.1.10 SOS line related configuration parameters

7.3.1.10.1 Downstream SOS time window (SOS-TIME-ds)

The parameter SOS-TIME-ds is used in the specification of the receiver initiated SOS (see [ITU-T G.993.2], clause 13.4.3). If the value of this parameter is not zero, the standard SOS triggering criteria are enabled, and the value corresponds with duration of the time window used in the standard SOS triggering criteria in the downstream direction. See [ITU-T G.993.2] for detailed usage rules.

The special value zero indicates that the standard SOS triggering criteria are disabled, i.e., vendor discretionary values may be used instead of the values configured in the MIB for the following parameters: SOS-NTONES-ds, SOS-CRC-ds, SOS-TIME-ds.

This parameter applies in the downstream direction. The valid range of non-zero values is from 64 ms to 16'320 ms in steps of 64 ms.

7.3.1.10.2 Upstream SOS time window (SOS-TIME-us)

The parameter SOS-TIME-us is used in the specification of the receiver initiated SOS (see [ITU-T G.993.2], clause 13.4.3). If the value of this parameter is not zero, the standard SOS triggering criteria are enabled, and the value corresponds with duration of the time window used in the standard SOS triggering criteria in the upstream direction. See [ITU-T G.993.2] for detailed usage rules.

The special value zero indicates that the standard SOS triggering criteria are disabled, i.e., vendor discretionary values may be used instead of the values configured in the MIB for the following parameters: SOS-NTONES-us, SOS-CRC-us, SOS-TIME-us.

This parameter applies in the upstream direction. The valid range of non-zero values is from 64 ms to 16'320 ms in steps of 64 ms.

7.3.1.10.3 Downstream minimum percentage of degraded tones (SOS-NTONES-ds)

This parameter is defined as the minimum percentage of tones in the downstream MEDLEY SET that must be degraded in order to arm the first sub-condition of the standard SOS triggering criteria (see clause 13.4.3.2 of [ITU-T G.993.2]) in the downstream direction. The parameter SOS-NTONES-ds is defined as a percentage of tones. See [ITU-T G.993.2] for detailed usage rules. The valid range of values is from 1 to 100 in steps of 1. Use of the special value 0 is described in clause 13.4.3.2 of [ITU-T G.993.2].

7.3.1.10.4 Upstream minimum percentage of degraded tones (SOS-NTONES-us)

The minimum percentage of tones in the upstream MEDLEY SET that must be degraded in order to arm the first sub-condition of the standard SOS triggering criteria (see clause 13.4.3.2 of [ITU-T G.993.2]) in the upstream direction. The parameter SOS-NTONES-us is defined as a percentage of tones. See [ITU-T G.993.2] for detailed usage rules. The valid range of values is from 1 to 100 in steps of 1. Use of the special value 0 is described in clause 13.4.3.2 of [ITU-T G.993.2].

7.3.1.10.5 Downstream minimum number of normalized CRC anomalies (SOS-CRC-ds)

This parameter is defined as the minimum number of normalized CRC anomalies received in SOS-TIME-ds seconds in order to arm the second sub-condition of the standard SOS triggering criteria (see clause 13.4.3.2 of [ITU-T G.993.2]) in the downstream direction. See [ITU-T G.993.2] for detailed usage rules. The valid range of SOS-CRC values is 0.02 to $(2^{16}-1)*0.02$, in steps of 0.02.

7.3.1.10.6 Upstream minimum number of normalized CRC anomalies (SOS-CRC-us)

This parameter is defined as the minimum number of normalized CRC anomalies received in SOS-TIME-us seconds in order to arm the second sub-condition of the standard SOS triggering criteria (see clause 13.4.3.2 of [ITU-T G.993.2]) in the upstream direction. See [ITU-T G.993.2] for detailed usage rules. The valid range of SOS-CRC values is 0.02 to $(2^{16}-1)*0.02$, in steps of 0.02.

7.3.1.10.7 Downstream maximum number of SOS (MAX-SOS-ds)

This parameter is used in G.993.2 de-activation (see [ITU-T G.993.2], clause 12.1.4). If the number of successful SOS procedures in the downstream direction performed within a 120-second interval exceeds MAX-SOS-ds, the modem shall transition to the L3 state. See [ITU-T G.993.2] for detailed usage rules (see clause 12.1.4 of [ITU-T G.993.2]). The valid range of values is 1 to 15. Use of the special value 0 is described in clause 12.1 of [ITU-T G.993.2].

7.3.1.10.8 Upstream Maximum Number of SOS (MAX-SOS-us)

This parameter is used in G.993.2 de-activation (see [ITU-T G.993.2], clause 12.1.4). If the number of successful SOS procedures in the upstream direction performed within a 120-second interval exceeds MAX-SOS-us, the modem shall transition to the L3 state. See [ITU-T G.993.2] for detailed usage rules (see clause 12.1.4 of [ITU-T G.993.2]). The valid range of values is 1 to 15. Use of the special value 0 is described in clause 12.1 of [ITU-T G.993.2].

7.3.1.10.9 Downstream SNR margin offset of ROC (SNRMOFFSET-ROC-ds)

The parameter is defined as the SNR Margin offset for the ROC channel in the downstream direction. The parameter is used in the specification of the channel initialization policy (see clause 12.3.7.1 of [ITU-T G.993.2]).

The valid range of SNR margin offset values is from 0 to 31 dB, with 0.1 dB steps.

7.3.1.10.10 Upstream SNR margin offset of ROC (SNRMOFFSET-ROC-us)

The parameter is defined as the SNR margin offset for the ROC channel in the upstream direction. The parameter is used in the specification of the channel initialization policy (see [ITU-T G.993.2], clause 12.3.7.1).

The valid range of SNR margin offset values is from 0 to 31 dB, with 0.1 dB steps.

7.3.1.10.11 Downstream minimum INP of ROC (INPMIN-ROC-ds)

This parameter contains the minimum impulse noise protection to apply on the ROC in the downstream direction. The minimum impulse noise protection is an integer ranging from 0 to 16.

7.3.1.10.12 Upstream minimum INP of ROC (INPMIN-ROC-us)

This parameter contains the minimum impulse noise protection to apply on the robust ROC in the upstream direction. The minimum impulse noise protection is an integer ranging from 0 to 16.

7.3.2 Channel configuration parameters

7.3.2.1 Data rate configuration parameters

These data rate parameters refer to the transmit direction for both the xTU-C and the xTU-R and apply to the configuration of an individual upstream or downstream bearer channel. The two data rate parameters define the data rate minimum and maximum bounds as specified by the operator of the system (the operator of the xTU-C). It is assumed that the xTU-C and the xTU-R will interpret the value set by the operator as appropriate for the specific implementation of xDSL between the xTU-C and the xTU-R in setting the line rates. The ranges of the data rate configuration parameters are not specified. The NMS used by the operator to manage the xTU-R and the xTU-C may implement its own limits on the allowed values for the desired bit rate parameters based on the particulars of the system managed. The definition of such a system is outside the scope of this model.

7.3.2.1.1 Minimum data rate

This parameter specifies the minimum net data rate for the bearer channel as desired by the operator of the system. The rate is coded in steps of 1'000 bit/s.

7.3.2.1.2 Minimum reserved data rate

This parameter specifies the minimum reserved net data rate for the bearer channel as desired by the operator of the system. The rate is coded in steps of 1'000 bit/s.

This parameter is optional. It is used only if the rate adaptation mode is set to DYNAMIC.

7.3.2.1.3 Maximum data rate

This parameter specifies the maximum net data rate for the bearer channel as desired by the operator of the system. The data rate is coded in steps of 1'000 bit/s.

7.3.2.1.4 Rate adaptation ratio

This parameter (expressed in %) specifies the ratio that shall be taken into account for the bearer channel when performing rate adaptation in the transmission direction of the bearer channel. The ratio is defined as a percentage in the 0 to 100 range. A ratio of 20% means that 20% of the available data rate (in excess of the minimum data rate summed over all bearer channels) will be assigned to this bearer channel and 80% to the other bearer channels.

The sum of rate adaptation ratios over all bearers in one direction shall be equal to 100%.

7.3.2.1.5 Minimum data rate in low power state

This parameter specifies the minimum net data rate for the bearer channel as desired by the operator of the system during the low power state (L1/L2). The power management low power states L1 and L2 are defined in [ITU-T G.992.2] and [ITU-T G.992.3], respectively. The data rate is coded in steps of 1'000 bit/s.

7.3.2.1.6 Downstream minimum SOS bit rate (MIN-SOS-BR-ds)

This parameter specifies the minimum net data rate required for a valid SOS request in the downstream direction. The value shall be coded as an unsigned integer representing the data rate as a multiple of 8 kbit/s.

7.3.2.1.7 Upstream minimum SOS bit rate (MIN-SOS-BR-us)

This parameter specifies the minimum net data rate required for a valid SOS request in the upstream direction. The value shall be coded as an unsigned integer representing the data rate as a multiple of 8 kbit/s.

7.3.2.2 Maximum interleaving delay

This parameter is the maximum one-way interleaving delay introduced by the PMS-TC between the alfa and the beta reference points, in the direction of the bearer channel. The one-way interleaving delay is defined in individual ADSL Recommendations as $\lceil S \cdot D \rceil / 4$ ms, where "S" is the S-factor and "D" is the "Interleaving Depth" and $\lceil x \rceil$ denotes rounding to the higher integer.

The xTUs shall choose the S and D values such that the actual one-way interleaving delay (see actual interleaving delay status parameter in clause 7.5.2.3) is less than or equal to the configured maximum interleaving delay. The delay ranges from 2 to 63 ms by steps of 1 ms. Three special values, S0, S1 and S2, are specified. The value S0 indicates no delay bound is being imposed. The value S1 indicates the fast latency path shall be used in the G.992.1 operating mode and S and D shall be selected such that $S \leq 1$ and $D = 1$ in [ITU-T G.992.2], [ITU-T G.992.3], [ITU-T G.992.4], [ITU-T G.992.5] and [ITU-T G.993.2] operating modes. The value S2 indicates a delay bound of 1 ms in [ITU-T G.993.2].

NOTE – A single maximum delay value is configured. As a consequence, xTUs supporting multiple xDSL Recommendations will use the configured value regardless of the operating mode actually being selected at line initialization.

7.3.2.3 Minimum impulse noise protection (INPMIN)

This parameter specifies the minimum impulse noise protection for the bearer channel if it is transported over DMT symbols with a subcarrier spacing of 4.3125 kHz. The impulse noise protection is expressed in DMT symbols with a subcarrier spacing of 4.3125 kHz and can take the values $\frac{1}{2}$ and any integer from 0 to 16, inclusive.

If the xTU does not support the configured INPMIN value, it shall use the nearest supported impulse noise protection greater than INPMIN.

7.3.2.3.1 Special requirements for [ITU-T G.992.1]

It is optional to apply the INPMIN parameter in the case of [ITU-T G.992.1]. If INPMIN is supported, the ATU-C shall offer to the ATU-R a range of combinations of framing parameters (C-RATES-1 and C-RATES-RA options) during initialization, which provide an ACTINP value equal to or greater than the INPMIN value specified over the Q interface. The ACTINP value for [ITU-T G.992.1] is defined in clause 7.5.2.4.

7.3.2.4 Minimum impulse noise protection for system using 8.625 kHz subcarrier spacing (INPMIN8)

This parameter specifies the minimum impulse noise protection for the bearer channel if it is transported over DMT symbols with a subcarrier spacing of 8.625 kHz. The impulse noise protection is expressed in DMT symbols with a subcarrier spacing of 8.625 kHz and can take any integer value from 0 to 16, inclusive.

7.3.2.5 Force framer setting for impulse noise protection (FORCEINP)

This parameter indicates that the framer settings of the bearer shall be selected such that the impulse noise protection computed according to the formula specified in the relevant Recommendation is greater than or equal to the minimal impulse noise protection requirement.

This flag shall have the same value for all the bearers of one line in the same direction.

7.3.2.6 Maximum bit error ratio

This parameter specifies the maximum bit error ratio for the bearer channel as desired by the operator of the system. The bit error ratio can take the values 10^{-3} , 10^{-5} or 10^{-7} .

NOTE – ATUs supporting multiple ADSL Recommendations may use or ignore the configured value depending on the operating mode actually being selected at line initialization. In [ITU-T G.992.3], [ITU-T G.992.4] and [ITU-T G.992.5], the ATUs will use the configured value. In [ITU-T G.992.1] and [ITU-T G.992.2], ATUs operate with the maximum bit error ratio fixed to 10^{-7} , regardless of the configured value.

7.3.2.7 Channel performance monitoring parameter thresholds

All supported channel performance monitoring parameters (counters, see Table 7-2) shall have an individual 15-minute and 24-hour threshold parameter.

7.3.2.8 Channel data rate thresholds

The data rate threshold parameter procedures shall be as defined in clause 7.2.7.

7.3.2.8.1 Data rate threshold upshift

This parameter is a threshold on the net data rate upshift achieved over one or more bearer channel data rate adaptations. An upshift rate change alarm (event) is triggered when the actual data rate exceeds the data rate at the last entry into showtime by more than the threshold. The data rate threshold is coded in bit/s.

7.3.2.8.2 Data rate threshold downshift

This parameter is a threshold on the net data rate downshift achieved over one or more bearer channel data rate adaptations. A downshift rate change alarm (event) is triggered when the actual data rate is below the data rate at the last entry into showtime by more than the threshold. The data rate threshold is coded in bit/s.

7.3.2.9 Maximum delay variation (DVMAX)

This parameter specifies the maximum value for the delay variation allowed in an OLR procedure.

It ranges from 0.1 to 25.4 in steps of 0.1 ms.

A special value indicates that no delay variation bound is imposed.

7.3.2.10 Channel initialization policy selection (CIPOLICY)

The channel initialization policy selection is a parameter that indicates which policy shall be applied to determine the transceiver configuration parameters at initialization. The valid values for CIPOLICY are 0 and 1. They are defined in the respective Recommendations.

7.3.3 STM data path configuration parameters

No STM data path configuration parameters are defined.

7.3.4 ATM data path configuration parameters

7.3.4.1 IMA operation mode enable parameter

This parameter enables the IMA operation mode in the ATM data path. It indicates that the ATM data path shall comply with the requirements for IMA transmission, i.e., minimum amount of idle cells shall be inserted and no cell discard shall be enabled at the receiver.

7.3.4.2 ATM data path performance monitoring parameter thresholds

All supported ATM data path performance monitoring parameters (counters, see Table 7-3) shall have an individual 15-minute and 24-hour threshold parameter.

7.3.5 PTM data path configuration parameters

7.3.5.1 PTM data path performance monitoring parameter thresholds

All supported PTM data path performance monitoring parameters (counters, see Table 7-4) shall have an individual 15-minute and 24-hour threshold parameter.

7.4 Inventory information

7.4.1 xTU-C G.994.1 vendor ID

The xTU-C G.994.1 vendor ID is the vendor ID as inserted by the xTU-C in the G.994.1 CL message. It consists of 8 binary octets, including a country code followed by a (regionally allocated) provider code, as defined in [ITU-T T.35].

Table 7-9 – Vendor ID information block (8 octets)

T.35 country code (2 octets)
T.35 provider code (vendor identification) (4 octets)
T.35 provider oriented code (vendor revision number) (2 octets)

The G.994.1 vendor ID should typically identify the vendor of the xTU-C G.994.1 functionality, whether implemented in hardware or software. It is not intended to indicate the system integrator. Further details are defined in [ITU-T G.994.1].

7.4.2 xTU-R G.994.1 vendor ID

The xTU-R G.994.1 vendor ID is the vendor ID as inserted by the xTU-R in the G.994.1 CLR message. It consists of 8 binary octets, with same format as the xTU-C G.994.1 vendor ID.

The G.994.1 vendor ID should typically identify the vendor of the xTU-R G.994.1 functionality, whether implemented in hardware or software. It is not intended to indicate the system integrator. Further details are defined in [ITU-T G.994.1].

7.4.3 xTU-C system vendor ID

The xTU-C system vendor ID is the vendor ID as inserted by the xTU-C in the overhead messages ([ITU-T G.992.3], [ITU-T G.992.4], [ITU-T G.992.5] and [ITU-T G.993.2]). It consists of 8 binary octets, with same format as the xTU-C G.994.1 vendor ID.

The xTU-C system vendor ID should typically identify the xTU-C system integrator. In this context, the system integrator usually refers to the vendor of the smallest field-replaceable unit. As such, the xTU-C system vendor ID may not be the same as the xTU-C G.994.1 vendor ID.

7.4.4 xTU-R system vendor ID

The xTU-R system vendor ID is the vendor ID as inserted by the xTU-R in the embedded operations channel ([ITU-T G.992.1] and [ITU-T G.992.2]) and the overhead messages ([ITU-T G.992.3], [ITU-T G.992.4], [ITU-T G.992.5] and [ITU-T G.993.2]). It consists of 8 binary octets, with same format as the xTU-C G.994.1 vendor ID.

The xTU-R system vendor ID should typically identify the xTU-R system integrator. In this context, the system integrator usually refers to the vendor of the smallest field-replaceable unit. As such, the xTU-R system vendor ID may not be the same as the xTU-R G.994.1 vendor ID.

7.4.5 xTU-C version number

The xTU-C version number is the version number as inserted by the xTU-C in the overhead messages ([ITU-T G.992.3], [ITU-T G.992.4], [ITU-T G.992.5] and [ITU-T G.993.2]). It is for version control and is vendor specific information. It consists of up to 16 binary octets.

7.4.6 xTU-R version number

The xTU-R version number is the version number as inserted by the xTU-R in the embedded operations channel ([ITU-T G.992.1] and [ITU-T G.992.2]) or overhead messages ([ITU-T G.992.3], [ITU-T G.992.4], [ITU-T G.992.5] and [ITU-T G.993.2]). It is for version control. It consists of up to 16 ASCII characters. It shall contain the xTU-R firmware version and the xTU-R model. Both shall be encoded in this order and separated by a space character, i.e., "<xTU-R firmware version> <xTU-R model>".

The xTU-R version number of equipment prior to this Recommendation may contain up to 16 vendor specific binary octets. These should be replaced by the information specified above at the time of the next firmware or hardware update.

NOTE – This field is intended to contain information about the firmware and model of the xTU-R physical layer interface (chipset).

7.4.7 xTU-C serial number

The xTU-C serial number is the serial number as inserted by the xTU-C in the overhead messages ([ITU-T G.992.3], [ITU-T G.992.4], [ITU-T G.992.5] and [ITU-T G.993.2]). It is vendor specific information. It consists of up to 32 ASCII characters.

Note that the combination of system vendor ID and serial number creates a unique number for each xTU-C.

7.4.8 xTU-R serial number

The xTU-R serial number is the serial number as inserted by the xTU-R in the embedded operations channel ([ITU-T G.992.1] and [ITU-T G.992.2]) or overhead messages ([ITU-T G.992.3], [ITU-T G.992.4], [ITU-T G.992.5] and [ITU-T G.993.2]). It consists of up to 32 ASCII characters. It shall contain the equipment serial number, the equipment model and the equipment firmware version. All shall be encoded in this order and separated by space characters, i.e., "<equipment serial number> <equipment model> <equipment firmware version>".

The xTU-R serial number of equipment prior to this Recommendation may contain up to 32 vendor specific ASCII characters. These should be replaced by the information specified above at the time of the next firmware or hardware update.

Note that the combination of system vendor ID and serial number creates a unique number for each xTU-R.

7.4.9 xTU-C self-test result

This parameter defines the xTU-C self-test result. It is coded as a 32-bit integer. The most significant octet of the self-test result is 00_{hex} if the self-test passed and 01_{hex} if the self-test failed. The interpretation of the other octets is vendor discretionary and can be interpreted in combination with G.994.1 and system vendor IDs.

7.4.10 xTU-R self-test result

This parameter defines the xTU-R self-test result. It is coded as a 32-bit integer. The most significant octet of the self-test result is 00_{hex} if the self-test passed and 01_{hex} if the self-test failed. The interpretation of the other octets is vendor discretionary and can be interpreted in combination with G.994.1 and system vendor IDs.

7.4.11 xTU-C transmission system capabilities

This parameter defines the xTU-C capability list of the different transmission system types. It is coded in a bit-map representation with the bits defined in clause 7.3.1.1.1. This parameter may be derived from the handshaking procedures defined in [ITU-T G.994.1].

7.4.12 xTU-R transmission system capabilities

This parameter defines the xTU-R capability list of the different transmission system types. It is coded in a bit-map representation with the bits defined in clause 7.3.1.1.1. This parameter may be derived from the handshaking procedures defined in [ITU-T G.994.1].

7.5 Test, diagnostic and status parameters

NOTE – The requirement on how recent the AN MIB data are and on the update time for test parameters does not include the transfer time between the transceiver and the AN MIB. The transfer time is implementation specific.

7.5.1 Line test, diagnostic and status parameters

7.5.1.1 xDSL transmission system

This parameter defines the transmission system in use. It is coded in a bit-map representation with the bits defined in clause 7.3.1.1.1. This parameter may be derived from the handshaking procedures defined in [ITU-T G.994.1].

7.5.1.2 VDSL2 profile

This parameter defines the profile in use. It is coded in a bit-map representation with the bits defined in clause 7.3.1.1.11. This parameter may be derived from the handshaking procedures defined in [ITU-T G.994.1].

7.5.1.3 VDSL2 limit PSD mask and band plan

This parameter defines the limit PSD mask and band plan in use. It is coded in a bit-map representation with the bits defined in clause 7.3.1.2.16.

7.5.1.4 VDSL2 US0 PSD mask

This parameter defines the US0 PSD mask in use. It is coded in a bit-map representation with the bits defined in clause 7.3.1.2.18. This parameter may be derived from the handshaking procedures defined in [ITU-T G.994.1].

7.5.1.5 Line power management state

The Line has four possible power management states, numbered 0 to 3 and corresponding to respectively:

L0 – Synchronized – This line state (L0) is when the line has full transmission (i.e., showtime).

L1 – Power down data transmission – This line state (L1) is when there is transmission on the line but the net data rate is reduced (e.g., only for OAM and higher layer connection and session control). This state applies to [ITU-T G.992.2] only.

L2 – Power down data transmission – This line state (L2) is when there is transmission on the line but the net data rate is reduced (e.g., only for OAM and higher layer connection and session control). This state applies to [ITU-T G.992.3] and [ITU-T G.992.4] only.

L3 – No-power – This line state (L3) is when there is no power transmitted on the line at all.

NOTE – This configuration parameter maps to the OperStatus of the line, which is part of the GeneralInformationGroup object group specified in [b-IETF RFC 2233], and may not need to be duplicated in the ADSL MIB. See also [b-IETF RFC 2662] and [b-IETF RFC 3440]. The operational status of the line is UP in the L0, L1 or L2 state (i.e., during showtime) and is DOWN in the L3 state (e.g., during (short) initialization and loop diagnostic mode).

7.5.1.6 Initialization success/failure cause

This parameter indicates whether the last full initialization procedure was successful. If the last initialization procedure was not successful, this parameter provides the reason. It is coded as an integer in the 0 to 5 range, as follows:

0 Successful.

1 Configuration error.

This error occurs with inconsistencies in configuration parameters. For example, when the line is initialized in an xDSL transmission system where an xTU does not support the configured maximum delay or the configured minimum or maximum data rate for one or more bearer channels.

2 Configuration not feasible on the line.

This error occurs if the minimum data rate cannot be reached on the line with the minimum noise margin, maximum PSD level, maximum delay and maximum bit error ratio for one or more bearer channels.

3 Communication problem.

This error occurs, for example, due to corrupted messages or bad syntax messages or if no common mode can be selected in the G.994.1 handshaking procedure or due to a timeout.

4 No peer xTU detected.

This error occurs if the peer xTU is not powered or not connected or if the line is too long to allow detection of a peer xTU.

5 Any other or unknown initialization failure cause.

7.5.1.7 Downstream last transmitted state

This parameter represents the last successful transmitted initialization state in the downstream direction in the last full initialization performed on the line. Initialization states are defined in the

individual xDSL Recommendations and are counted from 0 (if [ITU-T G.994.1] is used) or 1 (if [ITU-T G.994.1] is not used) up to showtime. This parameter must be interpreted along with the xDSL transmission system.

This parameter is available only when, after a failed full initialization, the loop diagnostic procedures are activated on the line. Loop diagnostic procedures can be activated by the operator of the system (through the line state forced line configuration parameter) or autonomously by the xTU-C or xTU-R.

7.5.1.8 Upstream last transmitted state

This parameter represents the last successful transmitted initialization state in the upstream direction in the last full initialization performed on the line. Initialization states are defined in the individual xDSL Recommendations and are counted from 0 ([if ITU-T G.994.1] is used) or 1 (if [ITU-T G.994.1] is not used) up to showtime. This parameter must be interpreted along with the xDSL Transmission System.

This parameter is available only when, after a failed full initialization, the loop diagnostic procedures are activated on the line. Loop diagnostic procedures can be activated by the operator of the system (through the line state forced line configuration parameter) or autonomously by the xTU-C or xTU-R.

7.5.1.9 Downstream line attenuation per band (LATNds)

This parameter is defined per usable band. It is the measured difference between the total power transmitted in this band by the xTU-C and the total power received in this band by the xTU-R over all subcarriers of this band during loop diagnostic mode and initialization. The downstream line attenuation ranges per band from 0 to +127 dB, with 0.1 dB steps. A special value indicates the line attenuation per band is out of range to be represented.

For ADSL systems, a single parameter is defined as a single downstream band is usable.

7.5.1.10 Upstream line attenuation per band (LATNus)

This parameter is defined per usable band. It is the measured difference, in dB, between the total power transmitted in this band by the xTU-R and the total power received in this band by the xTU-C over all subcarriers of this band during loop diagnostic mode and initialization. The upstream line attenuation ranges per band from 0 to +127 dB, with 0.1 dB steps. A special value indicates the line attenuation per band is out of range to be represented.

For ADSL systems, a single parameter is defined as a single upstream band is usable.

7.5.1.11 Downstream signal attenuation per band (SATNds)

This parameter is defined per usable band. It is the measured difference between the total power transmitted in this band by the xTU-C and the total power received in this band by the xTU-R over all subcarriers of this band during showtime. The downstream signal attenuation per band ranges from 0 to +127 dB, with 0.1 dB steps. A special value indicates the signal attenuation per band is out of range to be represented.

For ADSL systems, a single parameter is defined as a single downstream band is usable.

NOTE – During showtime, only a subset of the subcarriers may be transmitted by the xTU-C, as compared to loop diagnostic mode and initialization. Therefore, the downstream signal attenuation may be significantly lower than the downstream line attenuation.

7.5.1.12 Upstream signal attenuation per band (SATNus)

This parameter is defined per usable band. It is the measured difference, in dB, between the total power transmitted in this band by the xTU-R and the total power received in this band by the xTU-C over all subcarriers of this band during showtime. The upstream signal attenuation per band

ranges from 0 to +127 dB, with 0.1 dB steps. A special value indicates the signal attenuation per band is out of range to be represented.

For ADSL systems, a single parameter is defined as a single upstream band is usable.

NOTE – During showtime, only a subset of the subcarriers may be transmitted by the xTU-R, as compared to loop diagnostic mode and initialization. Therefore, the upstream signal attenuation may be significantly lower than the upstream line attenuation.

7.5.1.13 Downstream signal-to-noise ratio margin (SNRMds)

The downstream signal-to-noise ratio margin is the maximum increase, in dB, of the noise power received at the xTU-R, such that the BER requirements are met for all downstream bearer channels. The downstream SNR margin ranges from –64 dB to +63 dB, with 0.1 dB steps. A special value indicates the parameter is out of range to be represented. The same SNRMds format shall be applied to G.992.3 and G.992.5 Annex C FEXT SNRMds and NEXT SNRMds.

NOTE – The downstream SNR margin measurement at the xTU-R may take up to 10 s.

7.5.1.13.1 FEXT downstream signal-to-noise ratio margin (FEXT SNRMds)

For G.992.3 (ADSL2) Annex C and G.992.5 (ADSL2plus) Annex C, downstream signal-to-noise ratio margin (see clause 7.5.1.13) measured during FEXT_R duration at ATU-R is defined as FEXT downstream signal-to-noise ratio margin (FEXT SNRMds).

7.5.1.13.2 NEXT downstream signal-to-noise ratio margin (NEXT SNRMds)

For G.992.3 (ADSL2) Annex C and G.992.5 (ADSL2plus) Annex C, downstream signal-to-noise ratio margin (see clause 7.5.1.13) measured during NEXT_R duration at ATU-R is defined as NEXT downstream signal-to-noise ratio margin (NEXT SNRMds).

7.5.1.14 Downstream signal-to-noise ratio margin per band (SNRMpbds)

This parameter is defined per usable band. The downstream signal-to-noise ratio margin per band is the maximum increase in dB of the noise power received at the xTU-R, such that the BER requirements are met for all downstream bearer channels. The downstream SNR margin per band ranges from –64 dB to +63 dB, with 0.1 dB steps. A special value indicates the parameter is out of range to be represented.

NOTE – The downstream SNR margin per band measurement at the xTU-R may take up to 10 s.

7.5.1.15 Actual downstream signal-to-noise ratio mode (ACTSNRMODEds)

This parameter indicates if the transmitter referred virtual noise is active on the line in the downstream direction. If ACTSNRMODEds equals 1, the virtual noise is inactive. If ACTSNRMODEds equals 2, the virtual noise is active.

7.5.1.16 Upstream signal-to-noise ratio margin (SNRMus)

The upstream signal-to-noise ratio margin is the maximum increase, in dB, of the noise power received at the xTU-C, such that the BER requirements are met for all upstream bearer channels. The upstream SNR margin ranges from –64 dB to +63 dB, with 0.1 dB steps. A special value indicates the parameter is out of range to be represented. The same SNRMus format shall be applied to G.992.3 and G.992.5 Annex C FEXT SNRMus and NEXT SNRMus.

NOTE – The upstream SNR margin measurement at the xTU-C may take up to 10 s.

7.5.1.16.1 FEXT upstream signal-to-noise ratio margin (FEXT SNRMus)

For G.992.3 (ADSL2) Annex C and G.992.5 (ADSL2plus) Annex C, upstream signal-to-noise ratio margin (see clause 7.5.1.16) measured during FEXT_C duration at ATU-C is defined as FEXT upstream signal-to-noise ratio margin (FEXT SNRMus).

7.5.1.16.2 NEXT Upstream signal-to-noise ratio margin (NEXT SNRMus)

For G.992.3 (ADSL2) Annex C and G.992.5 (ADSL2plus) Annex C, upstream signal-to-noise ratio margin (see clause 7.5.1.16) measured during NEXT_C duration at ATU-C is defined as NEXT upstream signal-to-noise ratio margin (NEXT SNRMus).

7.5.1.17 Upstream signal-to-noise ratio margin per band (SNRMpbus)

This parameter is defined per usable band. The upstream signal-to-noise ratio margin per band is the maximum increase in dB of the noise power received at the xTU-C, such that the BER requirements are met for all upstream bearer channels. The upstream SNR margin per band ranges from –64 dB to +63 dB, with 0.1 dB steps. A special value indicates the parameter is out of range to be represented.

NOTE – The upstream SNR margin measurement at the xTU-C may take up to 10 s.

7.5.1.18 Actual upstream signal-to-noise ratio mode (ACTSNRMODEus)

This parameter indicates if the transmitter referred virtual noise is active on the line in the upstream direction. If ACTSNRMODEus equals 1, the virtual noise is inactive. If ACTSNRMODEus equals 2, the virtual noise is active.

7.5.1.19 Downstream maximum attainable data rate (ATTNDRds)

This parameter indicates the maximum downstream net data rate currently attainable by the xTU-C transmitter and the xTU-R receiver. The rate is coded in steps of 1'000 bit/s. The same ATNDRds format shall be applied to G.992.3 and G.992.5 Annex C FEXT ATNDRds and NEXT ATNDRds.

7.5.1.19.1 FEXT downstream maximum attainable data rate (FEXT ATNDRds)

For G.992.3 (ADSL2) Annex C and G.992.5 (ADSL2plus) Annex C, the maximum downstream net data rate (see clause 7.5.1.19) calculated from FEXT downstream SNR(f) (see clause 7.5.1.28.3.1) is defined as FEXT downstream maximum attainable data rate (FEXT ATNDRds).

7.5.1.19.2 NEXT downstream maximum attainable data rate (NEXT ATNDRds)

For G.992.3 (ADSL2) Annex C and G.992.5 (ADSL2plus) Annex C, the maximum downstream net data rate (see clause 7.5.1.19) calculated from NEXT downstream SNR(f) (see clause 7.5.1.28.3.2) is defined as NEXT downstream maximum attainable data rate (NEXT ATNDRds).

7.5.1.20 Upstream maximum attainable data rate (ATTNDRus)

This parameter indicates the maximum upstream net data rate currently attainable by the xTU-R transmitter and the xTU-C receiver. The rate is coded in steps of 1'000 bit/s. The same ATNDRus format shall be applied to G.992.3 and G.992.5 Annex C FEXT ATNDRus and NEXT ATNDRus.

7.5.1.20.1 FEXT upstream maximum attainable data rate (FEXT ATNDRus)

For G.992.3 (ADSL2) Annex C and G.992.5 (ADSL2plus) Annex C, the maximum upstream net data rate (see clause 7.5.1.20) calculated from FEXT upstream SNR(f) (see clause 7.5.1.28.6.1) is defined as FEXT upstream maximum attainable data rate (FEXT ATNDRus).

7.5.1.20.2 NEXT upstream maximum attainable data rate (NEXT ATNDRus)

For G.992.3 (ADSL2) Annex C and G.992.5 (ADSL2plus) Annex C, the maximum upstream net data rate (see clause 7.5.1.20) calculated from NEXT upstream SNR(f) (see clause 7.5.1.28.6.2) is defined as NEXT upstream maximum attainable data rate (NEXT ATNDRus).

7.5.1.21 Downstream actual power spectral density (ACTPSDds)

This parameter is the average downstream transmit PSD over the used subcarriers (subcarriers to which downstream user data are allocated) delivered by the xTU-C at the U-C reference point, at the instant of measurement. The PSD level ranges from -90 dBm/Hz to 0 dBm/Hz, with 0.1 dB steps. A special value indicates the parameter is out of range to be represented. The same ACTPSDds format shall be applied to G.992.3 and G.992.5 Annex C FEXT ACTPSDds and NEXT ACTPSDds.

NOTE – The downstream actual power spectrum density is the sum (in dB) of the REFPSDds and RMSGIds. See clause 8.5.1 of [ITU-T G.992.3].

7.5.1.21.1 FEXT downstream actual power spectral density (FEXT ACTPSDds)

For G.992.3 (ADSL2) Annex C and G.992.5 (ADSL2plus) Annex C, the average downstream transmit PSD over the used subcarriers (see clause 7.5.1.21) calculated from the REFPSDds and RMSGIds for FEXT_R duration is defined as FEXT downstream actual power spectrum density (FEXT ACTPSDds).

7.5.1.21.2 NEXT downstream actual power spectral density (NEXT ACTPSDds)

For G.992.3 (ADSL2) Annex C and G.992.5 (ADSL2plus) Annex C, the average downstream transmit PSD over the used subcarriers (see clause 7.5.1.21) calculated from the REFPSDds and RMSGIds for NEXT_R duration is defined as NEXT downstream actual power spectrum density (NEXT ACTPSDds).

7.5.1.22 Upstream actual power spectral density (ACTPSDus)

This parameter is the average upstream transmit PSD over the used subcarriers (subcarriers to which upstream user data are allocated) delivered by the xTU-R at the U-R reference point, at the instant of measurement. The PSD level ranges from -90 dBm/Hz to 0 dBm/Hz, with 0.1 dB steps. A special value indicates the parameter is out of range to be represented. The same ACTPSDus format shall be applied to G.992.3 and G.992.5 Annex C FEXT ACTPSDus and NEXT ACTPSDus.

NOTE – The upstream actual power spectrum density is the sum (in dB) of the REFPSDus and RMSGIus. See clause 8.5.1 of [ITU-T G.992.3].

7.5.1.22.1 FEXT upstream actual power spectral density (FEXT ACTPSDus)

For G.992.3 (ADSL2) Annex C and G.992.5 (ADSL2plus) Annex C, the average upstream transmit PSD over the used subcarriers (see clause 7.5.1.22) calculated from the REFPSDus and RMSGIus for FEXT_C duration is defined as FEXT upstream actual power spectrum density (FEXT ACTPSDus).

7.5.1.22.2 NEXT upstream actual power spectral density (NEXT ACTPSDus)

For G.992.3 (ADSL2) Annex C and G.992.5 (ADSL2plus) Annex C, the average downstream transmit PSD over the used subcarriers (see clause 7.5.1.22) calculated from the REFPSDus and RMSGIus for NEXT_C duration is defined as NEXT upstream actual power spectrum density (NEXT ACTPSDus).

7.5.1.23 Estimated upstream power back-off electrical length

7.5.1.23.1 VTU-O estimated upstream power back-off electrical length (UPBOKLE)

This parameter contains the estimated electrical length expressed in dB at 1 MHz, kl_0 (see O-UPDATE in clause 12.3.3.2.1.2 of [ITU-T G.993.2]). This is the final electrical length that would have been sent from the VTU-O to the VTU-R if the electrical length was not forced by the CO-MIB. The value ranges from 0 to 128 dB, in steps of 0.1 dB.

7.5.1.23.2 VTU-R estimated upstream power back-off electrical length (UPBOKLE-R)

This parameter contains the electrical length estimated by the VTU-R expressed in dB at 1 MHz. This is the value contained in the message R-MSG1 (see clause 12.3.3.2.2.1 of [ITU-T G.993.2]). The value ranges from 0 to 128 dB, in steps of 0.1 dB.

7.5.1.24 Downstream actual aggregate transmit power (ACTATPDs)

This parameter is the total amount of transmit power delivered by the xTU-C at the U-C reference point, at the instant of measurement. The total output power level ranges from -31 dBm to +31 dBm, with 0.1 dB steps. A special value indicates the parameter is out of range to be represented. The same ACTATPDs format shall be applied to G.992.3 and G.992.5 Annex C FEXT ACTATPDs and NEXT ACTATPDs.

NOTE – The downstream nominal aggregate transmit power may be taken as a best estimate of the parameter. See clause 8.12.3.8 of [ITU-T G.992.3] and clause 10.3.4.2.1 of [ITU-T G.993.2].

7.5.1.24.1 FEXT downstream actual aggregate transmit power (FEXT ACTATPDs)

For G.992.3 (ADSL2) Annex C and G.992.5 (ADSL2plus) Annex C, the total amount of transmit power (see clause 7.5.1.24) calculated from PSDs measured during FEXT_R duration at ATU-R is defined as FEXT downstream actual aggregate transmit power (FEXT ACTATPDs).

7.5.1.24.2 NEXT downstream actual aggregate transmit power (NEXT ACTATPDs)

For G.992.3 (ADSL2) Annex C and G.992.5 (ADSL2plus) Annex C, the total amount of transmit power (see clause 7.5.1.24) calculated from PSDs measured during NEXT_R duration at ATU-R is defined as NEXT downstream actual aggregate transmit power (NEXT ACTATPDs).

7.5.1.25 Upstream actual aggregate transmit power (ACTATPus)

This parameter is the total amount of transmit power delivered by the xTU-R at the U-R reference point, at the instant of measurement. The total output power level ranges from -31 dBm to +31 dBm, with 0.1 dB steps. A special value indicates the parameter is out of range to be represented. The same ACTATPus format shall be applied to G.992.3 and G.992.5 Annex C FEXT ACTATPus and NEXT ACTATPus.

NOTE – The upstream nominal aggregate transmit power may be taken as a best estimate of the parameter. See clause 8.12.3.8 of [ITU-T G.992.3] and clause 10.3.4.2.1 of [ITU-T G.993.2].

7.5.1.25.1 FEXT upstream actual aggregate transmit power (FEXT ACTATPus)

For G.992.3 (ADSL2) Annex C and G.992.5 (ADSL2plus) Annex C, the total amount of transmit power (see clause 7.5.1.25) calculated from PSDus measured during FEXT_C duration at ATU-C is defined as FEXT upstream actual aggregate transmit power (FEXT ACTATPus).

7.5.1.25.2 NEXT upstream actual aggregate transmit power (NEXT ACTATPus)

For G.992.3 (ADSL2) Annex C and G.992.5 (ADSL2plus) Annex C, the total amount of transmit power (see clause 7.5.1.25) calculated from PSDus measured during NEXT_C duration at ATU-C is defined as NEXT upstream actual aggregate transmit power (NEXT ACTATPus).

7.5.1.26 Channel characteristics function per subcarrier

This function is defined in clauses 8.12.3.1 of [ITU-T G.992.3] and clause 11.4.1.1.1 of [ITU-T G.993.2].

NOTE – In case of G.992.3 (ADSL2) Annex C and G.992.5 (ADSL2plus) Annex C, see clause C.8.12.3.1 of [ITU-T G.992.3], in addition to clause 8.12.3.1 of [ITU-T G.992.3].

For [ITU-T G.993.2], the value of NSus and NSds are respectively the indices of the highest supported upstream and downstream subcarriers according to the selected profile (see clause 6 of [ITU-T G.993.2]). For ADSL, NSus is equal to NScus-1 and NSds is equal to NScds-1.

7.5.1.26.1 Downstream H(f) linear representation scale (HLINSCds)

This parameter is the scale factor to be applied to the downstream Hlin(f) values. It is represented as an unsigned integer in the range from 1 to $2^{16} - 1$. This parameter is only available after a loop diagnostic procedure.

7.5.1.26.2 Downstream H(f) linear subcarrier group size (HLINGds)

This parameter is the number of subcarriers per group used to report HLINpsds. The valid values are 1, 2, 4 and 8. For ADSL, this parameter is equal to one and, for VDSL2, it is equal to the size of a subcarrier group used to compute these parameters (see clause 11.4.1 of [ITU-T G.993.2]).

NOTE – The values of the subcarrier group size parameters (HLING, HLOGG, QLNG and SNRG) may not all be independent.

7.5.1.26.3 Downstream H(f) linear representation (HLINpsds)

This parameter is an array of complex values in linear scale for downstream Hlin(f). Each array entry represents the Hlin($f = i * \text{HLINGds} * \Delta f$) value for a particular subcarrier group index i , ranging from 0 to $\text{MIN}(\text{NSds}, 511)$. The Hlin(f) is represented as $((\text{HLINSCds} / 2^{15}) * ((a(i) + j * b(i)) / 2^{15}))$, where $a(i)$ and $b(i)$ are signed integers in the $(-2^{15} + 1)$ to $(+2^{15} - 1)$ range. A special value indicates that no measurement could be done for this subcarrier group because it is out of the passband or that the attenuation is out of range to be represented. This parameter is only available after a loop diagnostic procedure.

7.5.1.26.4 Downstream H(f) logarithmic measurement time (HLOGMTds)

This parameter contains the number of symbols used to measure the downstream Hlog(f) values. It is represented as an unsigned integer in the range from 1 to $2^{16} - 1$.

After a loop diagnostic procedure, this parameter shall contain the number of symbols used to measure the downstream Hlog(f). It should correspond to the value specified in the Recommendation (e.g., the number of symbols in 1 s time interval for [ITU-T G.992.3]).

7.5.1.26.5 Downstream H(f) logarithmic subcarrier group size (HLOGGds)

This parameter is the number of subcarriers per group used to report HLOGpsds. The valid values are 1, 2, 4 and 8. For ADSL, this parameter is equal to one and, for VDSL2, it is equal to the size of a subcarrier group used to compute these parameters (see clause 11.4.1 of [ITU-T G.993.2]).

7.5.1.26.6 Downstream H(f) logarithmic representation (HLOGpsds)

This parameter is an array of real values in dB for downstream Hlog(f). Each array entry represents the real Hlog($f = i * \text{HLOGGds} * \Delta f$) value for a particular subcarrier group subcarrier index i , ranging from 0 to $\text{MIN}(\text{NSds}, 511)$. The real Hlog(f) value is represented as $(6 - m(i)/10)$, where $m(i)$ is an unsigned integer in the range from 0 to 1022. A special value indicates that no measurement could be done for this subcarrier group because it is out of the passband or that the attenuation is out of range to be represented.

7.5.1.26.7 Upstream H(f) linear representation scale (HLINSCus)

This parameter is the scale factor to be applied to the upstream Hlin(f) values. It is coded in the same way as the related downstream parameter. This parameter is only available after a loop diagnostic procedure.

7.5.1.26.8 Upstream H(f) linear subcarrier group size (HLINGus)

This parameter is the number of subcarriers per group used to report HLINpsus. The valid values are 1, 2, 4 and 8. For ADSL, this parameter is equal to one and, for VDSL2, it is equal to the size of a subcarrier group used to compute these parameters (see clause 11.4.1 of [ITU-T G.993.2]).

7.5.1.26.9 Upstream H(f) linear representation (HLINpsus)

This parameter is an array of complex values in linear scale for upstream Hlin(f). It is coded in the same way as the related downstream parameter. This parameter is only available after a loop diagnostic procedure.

7.5.1.26.10 Upstream H(f) logarithmic measurement time (HLOGMTus)

This parameter contains the number of symbols used to measure the upstream Hlog(f) values. It is an unsigned integer in the range from 1 to $2^{16} - 1$.

After a loop diagnostic procedure, this parameter shall contain the number of symbols used to measure the upstream Hlog(f). It should correspond to the value specified in the Recommendation (e.g., the number of symbols in 1 s time interval for [ITU-T G.992.3]).

7.5.1.26.11 Upstream H(f) logarithmic subcarrier group size (HLOGGus)

This parameter is the number of subcarriers per group used to report HLOGpsus. The valid values are 1, 2, 4 and 8. For ADSL, this parameter is equal to one and, for VDSL2, it is equal to the size of a subcarrier group used to compute these parameters (see clause 11.4.1 of [ITU-T G.993.2]).

7.5.1.26.12 Upstream H(f) logarithmic representation (HLOGpsus)

This parameter is an array of real values in dB for upstream Hlog(f). It is coded in the same way as the related downstream parameter.

7.5.1.27 Quiet line noise PSD per subcarrier

This function is defined in clauses 8.12.3.2 of [ITU-T G.992.3] and 11.4.1.1.2 of [ITU-T G.993.2].

NOTE – In case of G.992.3 (ADSL2) Annex C and G.992.5 (ADSL2plus) Annex C, see clause C.8.12.3.2 of [ITU-T G.992.3], in addition to clause 8.12.3.2 of [ITU-T G.992.3].

7.5.1.27.1 Downstream quiet line noise PSD measurement time (QLNMTds)

This parameter contains the number of symbols used to measure the downstream QLN(f) values. It is an unsigned integer in the range from 1 to $2^{16} - 1$. The same QLNMTds format shall be applied to G.992.3 and G.992.5 Annex C FEXT QLNMTds and NEXT QLNMTds.

After a loop diagnostic procedure, this parameter shall contain the number of symbols used to measure the downstream QLN(f). It should correspond to the value specified in the Recommendation (e.g., the number of symbols in 1 s time interval for [ITU-T G.992.3]).

7.5.1.27.1.1 FEXT downstream quiet line noise PSD measurement time (FEXT QLNMTds)

For G.992.3 (ADSL2) Annex C and G.992.5 (ADSL2plus) Annex C, the number of symbols used to measured FEXT downstream QLN(f) (see clause 7.5.1.27.3.1) is defined as FEXT downstream quiet line noise PSD measurement time (FEXT QLNMTds).

7.5.1.27.1.2 NEXT downstream quiet line noise PSD measurement time (NEXT QLNMTds)

For G.992.3 (ADSL2) Annex C and G.992.5 (ADSL2plus) Annex C, the number of symbols used to measured NEXT downstream QLN(f) (see clause 7.5.1.27.3.2) is defined as NEXT downstream quiet line noise PSD measurement time (NEXT QLNMTds).

7.5.1.27.2 Downstream QLN(f) subcarrier group size (QLNGds)

This parameter is the number of subcarriers per group used to report QLNpsds. The valid values are 1, 2, 4 and 8. For ADSL, this parameter is equal to one and, for VDSL2, it is equal to the size of a subcarrier group used to compute these parameters (see clause 11.4.1 of [ITU-T G.993.2]).

7.5.1.27.3 Downstream QLN(f) (QLNpsds)

This parameter is an array of real values in dBm/Hz for downstream QLN(f). Each array entry represents the $QLN(f=i * QLNGds * \Delta f)$ value for a particular subcarrier group index i , ranging from 0 to $MIN(NSds, 511)$. The QLN(f) is represented as $(-23 - n(i)/2)$, where $n(i)$ is an unsigned integer in the range from 0 to 254. A special value indicates that no measurement could be done for this subcarrier group because it is out of the passband or that the noise PSD is out of range to be represented. The same QLNpsds format shall be applied to G.992.3 and G.992.5 Annex C FEXT QLNpsds and NEXT QLNpsds.

7.5.1.27.3.1 FEXT downstream QLN(f) (FEXT QLNpsds)

For G.992.3 (ADSL2) Annex C and G.992.5 (ADSL2plus) Annex C, downstream QLN(f) (see clause 7.5.1.27.3) measured during $FEXT_R$ duration at ATU-R is defined as FEXT downstream QLN(f) (FEXT QLNpsds).

7.5.1.27.3.2 NEXT downstream QLN(f) (NEXT QLNpsds)

For G.992.3 (ADSL2) Annex C and G.992.5 (ADSL2plus) Annex C, downstream QLN(f) (see clause 7.5.1.27.3) measured during $NEXT_R$ duration at ATU-R is defined as NEXT downstream QLN(f) (NEXT QLNpsds).

7.5.1.27.4 Upstream quiet line noise PSD measurement time (QLNMTus)

This parameter contains the number of symbols used to measure the upstream QLN(f) values. It is an unsigned integer in the range from 1 to $2^{16} - 1$. The same QLNMTus format shall be applied to G.992.3 and G.992.5 Annex C FEXT QLNMTus and NEXT QLNMTus.

After a loop diagnostic procedure, this parameter shall contain the number of symbols used to measure the upstream QLN(f). It should correspond to the value specified in the Recommendation (e.g., the number of symbols in 1 s time interval for [ITU-T G.992.3]).

7.5.1.27.4.1 FEXT upstream quiet line noise PSD measurement time (FEXT QLNMTus)

For G.992.3 (ADSL2) Annex C and G.992.5 (ADSL2plus) Annex C, the number of symbols used to measure FEXT upstream QLN(f) (see clause 7.5.1.27.6.1) is defined as FEXT upstream quiet line noise PSD measurement time (FEXT QLNMTus).

7.5.1.27.4.2 NEXT upstream quiet line noise PSD measurement time (NEXT QLNMTus)

For G.992.3 (ADSL2) Annex C and G.992.5 (ADSL2plus) Annex C, the number of symbols used to measure NEXT upstream QLN(f) (see clause 7.5.1.27.6.2) is defined as NEXT upstream quiet line noise PSD measurement time (NEXT QLNMTus).

7.5.1.27.5 Upstream QLN(f) subcarrier group size (QLNGus)

This parameter is the number of subcarriers per group used to report QLNpsus. The valid values are 1, 2, 4 and 8. For ADSL, this parameter is equal to one and, for VDSL2, it is equal to the size of a subcarrier group used to compute these parameters (see clause 11.4.1 of [ITU-T G.993.2]).

7.5.1.27.6 Upstream QLN(f) (QLNpsus)

This parameter is an array of real values in dBm/Hz for upstream QLN(f). It is coded in the same way as the related downstream parameter. The same QLNpsus format shall be applied to G.992.3 and G.992.5 Annex C FEXT QLNpsus and NEXT QLNpsus.

7.5.1.27.6.1 FEXT upstream QLN(f) (FEXT QLNpsus)

For G.992.3 (ADSL2) Annex C and G.992.5 (ADSL2plus) Annex C, upstream QLN(f) (see clause 7.5.1.27.6) measured during $FEXT_C$ duration at ATU-C is defined as FEXT upstream QLN(f) (FEXT QLNpsus).

7.5.1.27.6.2 NEXT upstream QLN(f) (NEXT QLNpsus)

For G.992.3 (ADSL2) Annex C and G.992.5 (ADSL2plus) Annex C, upstream QLN(f) (see clause 7.5.1.27.6) measured during NEXT_C duration at ATU-C is defined as NEXT upstream QLN(f) (NEXT QLNpsus).

7.5.1.28 Signal-to-noise ratio per subcarrier

This function is defined in clauses 8.12.3.3 of [ITU-T G.992.3] and 11.4.1.1.3 of [ITU-T G.993.2].

NOTE – In case of G.992.3 (ADSL2) Annex C and G.992.5 (ADSL2plus) Annex C, see clause C.8.12.3.3 of [ITU-T G.992.3], in addition to clause 8.12.3.3 of [ITU-T G.992.3].

7.5.1.28.1 Downstream SNR measurement time (SNRMTds)

This parameter contains the number of symbols used to measure the downstream SNR(f) values. It is an unsigned integer in the range from 1 to $2^{16} - 1$. The same SNRMTds format shall be applied to G.992.3 and G.992.5 Annex C FEXT SNRMTds and NEXT SNRMTds.

After a loop diagnostic procedure, this parameter shall contain the number of symbols used to measure the downstream SNR(f). It should correspond to the value specified in the Recommendation (e.g., the number of symbols in 1 s time interval for [ITU-T G.992.3]).

7.5.1.28.1.1 FEXT downstream SNR measurement time (FEXT SNRMTds)

For G.992.3 (ADSL2) Annex C and G.992.5 (ADSL2plus) Annex C, the number of symbols used to measure FEXT downstream SNR(f) values (see clause 7.5.1.28.3.1) is defined as FEXT downstream SNR measurement time (FEXT SNRMTds).

7.5.1.28.1.2 NEXT downstream SNR measurement time (NEXT SNRMTds)

For G.992.3 (ADSL2) Annex C and G.992.5 (ADSL2plus) Annex C, the number of symbols used to measure NEXT Downstream SNR(f) values (see clause 7.5.1.28.3.2) is defined as NEXT downstream SNR measurement time (NEXT SNRMTds).

7.5.1.28.2 Downstream SNR(f) subcarrier group size (SNRGds)

This parameter is the number of subcarriers per group used to report SNRpsds. The valid values are 1, 2, 4 and 8. For ADSL, this parameter is equal to one and, for VDSL2, it is equal to the size of a subcarrier group used to compute these parameters (see clause 11.4.1 of [ITU-T G.993.2]).

7.5.1.28.3 Downstream SNR(f) (SNRpsds)

This parameter is an array of real values in dB for downstream SNR(f). Each array entry represents the SNR($f=i * \text{SNRGds} * \Delta f$) value for a particular subcarrier group index i , ranging from 0 to MIN(NSds,511). The SNR(f) is represented as $(-32 + \text{snr}(i)/2)$, where snr(i) is an unsigned integer in the range from 0 to 254. A special value indicates that no measurement could be done for this subcarrier group because it is out of the passband or that the SNR is out of range to be represented. The same SNRpsds format shall be applied to G.992.3 and G.992.5 Annex C FEXT SNRpsds and NEXT SNRpsds.

7.5.1.28.3.1 FEXT downstream SNR(f) (FEXT SNRpsds)

For G.992.3 (ADSL2) Annex C and G.992.5 (ADSL2plus) Annex C, downstream SNR(f) (see clause 7.5.1.28.3) measured during FEXT_R duration at ATU-R is defined as FEXT downstream SNR(f) (FEXT SNRpsds).

7.5.1.28.3.2 NEXT downstream SNR(f) (NEXT SNRpsds)

For G.992.3 (ADSL2) Annex C and G.992.5 (ADSL2plus) Annex C, downstream SNR(f) (see clause 7.5.1.28.3) measured during NEXT_R duration at ATU-R is defined as NEXT downstream SNR(f) (NEXT SNRpsds).

7.5.1.28.4 Upstream SNR measurement time (SNRMT_{us})

This parameter contains the number of symbols used to measure the upstream SNR(f) values. It is an unsigned integer in the range from 1 to $2^{16} - 1$. The same SNRMT_{us} format shall be applied to G.992.3 and G.992.5 Annex C FEXT SNRMT_{us} and NEXT SNRMT_{us}.

After a loop diagnostic procedure, this parameter shall contain the number of symbols used to measure the upstream SNR(f). It should correspond to the value specified in the Recommendation (e.g., the number of symbols in 1 s time interval for [ITU-T G.992.3]).

7.5.1.28.4.1 FEXT upstream SNR measurement time (FEXT SNRMT_{us})

For G.992.3 (ADSL2) Annex C and G.992.5 (ADSL2plus) Annex C, the number of symbols used to measure FEXT upstream SNR(f) values (see clause 7.5.1.28.6.1) is defined as FEXT upstream SNR measurement time (FEXT SNRMT_{us}).

7.5.1.28.4.2 NEXT upstream SNR measurement time (NEXT SNRMT_{us})

For G.992.3 (ADSL2) Annex C and G.992.5 (ADSL2plus) Annex C, the number of symbols used to measure NEXT upstream SNR(f) values (see clause 7.5.1.28.6.2) is defined as NEXT upstream SNR measurement time (NEXT SNRMT_{us}).

7.5.1.28.5 Upstream SNR(f) subcarrier group size (SNRG_{us})

This parameter is the number of subcarriers per group used to report SNR_{psus}. The valid values are 1, 2, 4 and 8. For ADSL, this parameter is equal to one and, for VDSL2, it is equal to the size of a subcarrier group used to compute these parameters (see clause 11.4.1 of [ITU-T G.993.2]).

7.5.1.28.6 Upstream SNR(f) (SNR_{psus})

This parameter is an array of real values in dB for upstream SNR(f). It is coded in the same way as the related downstream parameter. The same SNR_{psus} format shall be applied to G.992.3 and G.992.5 Annex C FEXT SNR_{psus} and NEXT SNR_{psus}.

7.5.1.28.6.1 FEXT upstream SNR(f) (FEXT SNR_{psus})

For G.992.3 (ADSL2) Annex C and G.992.5 (ADSL2plus) Annex C, upstream SNR(f) (see clause 7.5.1.28.6) measured during FEXT_C duration at ATU-C is defined as FEXT upstream SNR(f) (FEXT SNR_{psus}).

7.5.1.28.6.2 NEXT upstream SNR(f) (NEXT SNR_{psus})

For G.992.3 (ADSL2) Annex C and G.992.5 (ADSL2plus) Annex C, upstream SNR(f) (see clause 7.5.1.28.6) measured during NEXT_C duration at ATU-C is defined as NEXT upstream SNR(f) (NEXT SNR_{psus}).

7.5.1.29 Bits and gains allocation per subcarrier

7.5.1.29.1 Downstream bits allocation (BITS_{psds})

This parameter defines the downstream bits allocation table per subcarrier. It is an array of integer values in the 0 to 15 range for subcarriers 0 to NS_ds. The same BITS_{psds} format shall be applied to G.992.3 and G.992.5 Annex C FEXT BITS_{psds} and NEXT BITS_{psds}.

The reported bits of subcarriers out of the downstream MEDLEY set shall be set to 0.

This parameter shall be reported with the most recent values when read over the Q-interface.

7.5.1.29.1.1 FEXT downstream bits allocation (FEXT BITS_{psds})

For G.992.3 (ADSL2) Annex C and G.992.5 (ADSL2plus) Annex C, the downstream bits allocation table per subcarrier (see clause 7.5.1.29.1) used during FEXT_R duration is defined as FEXT downstream bits allocation (FEXT BITS_{psds}).

7.5.1.29.1.2 NEXT downstream bits allocation (NEXT BITSpsds)

For G.992.3 (ADSL2) Annex C and G.992.5 (ADSL2plus) Annex C, the downstream bits allocation table per subcarrier (see clause 7.5.1.29.1) used during NEXT_R duration is defined as NEXT downstream bits allocation (NEXT BITSpsds).

7.5.1.29.2 Upstream bits allocation (BITSpsus)

This parameter defines the upstream bits allocation table per subcarrier. It is an array of integer values in the 0 to 15 range for subcarriers 0 to NSus. The same BITSpsus format shall be applied to G.992.3 and G.992.5 Annex C FEXT BITSpsus and NEXT BITSpsus.

The reported bits of subcarriers out of the upstream MEDLEY set shall be set to 0.

This parameter shall be reported with the most recent values when read over the Q-interface.

7.5.1.29.2.1 FEXT upstream bits allocation (FEXT BITSpsus)

For G.992.3 (ADSL2) Annex C and G.992.5 (ADSL2plus) Annex C, the upstream bits allocation table per subcarrier (see clause 7.5.1.29.2) used during FEXT_C duration is defined as FEXT upstream bits allocation (FEXT BITSpsus).

7.5.1.29.2.1 NEXT upstream bits allocation (NEXT BITSpsus)

For G.992.3 (ADSL2) Annex C and G.992.5 (ADSL2plus) Annex C, the upstream bits allocation table per subcarrier (see clause 7.5.1.29.2) used during NEXT_C duration is defined as NEXT upstream bits allocation (NEXT BITSpsus).

7.5.1.29.3 Downstream gains allocation (GAINSpsds)

This parameter defines the downstream gains allocation table per subcarrier. It is an array of integer values in the 0 to 4093 range for subcarriers 0 to NSds. The gain value is represented as a multiple of 1/512 on linear scale. The same GAINSpsds format shall be applied to G.992.3 and G.992.5 Annex C FEXT GAINSpsds and NEXT GAINSpsds.

The reported gains of subcarriers out of the downstream MEDLEY set shall be set to 0.

This parameter shall be reported with the most recent values when read over the Q interface.

7.5.1.29.3.1 FEXT downstream gains allocation (FEXT GAINSpsds)

For G.992.3 (ADSL2) Annex C and G.992.5 (ADSL2plus) Annex C, the downstream gains allocation table per subcarrier (see clause 7.5.1.29.3) used during FEXT_R duration is defined as FEXT downstream gains allocation (FEXT GAINSpsds).

7.5.1.29.3.2 NEXT downstream gains allocation (NEXT GAINSpsds)

For G.992.3 (ADSL2) Annex C and G.992.5 (ADSL2plus) Annex C, the downstream gains allocation table per subcarrier (see clause 7.5.1.29.3) used during NEXT_R duration is defined as NEXT downstream gains allocation (NEXT GAINSpsds).

7.5.1.29.4 Upstream gains allocation (GAINSpsus)

This parameter defines the upstream gains allocation table per subcarrier. It is an array of integer values in the 0 to 4093 range for subcarriers 0 to NSus. The gain value is represented as a multiple of 1/512 on linear scale. The same GAINSpsus format shall be applied to G.992.3 and G.992.5 Annex C FEXT GAINSpsus and NEXT GAINSpsus.

The reported gains of subcarriers out of the upstream MEDLEY set shall be set to 0.

This parameter shall be reported with the most recent values when read over the Q interface.

7.5.1.29.4.1 FEXT upstream gains allocation (FEXT GAINSpus)

For G.992.3 (ADSL2) Annex C and G.992.5 (ADSL2plus) Annex C, the upstream gains allocation table per subcarrier (see clause 7.5.1.29.4) used during FEXT_C duration is defined as FEXT upstream gains allocation (FEXT GAINSpus).

7.5.1.29.4.2 NEXT upstream gains allocation (NEXT GAINSpus)

For G.992.3 (ADSL2) Annex C and G.992.5 (ADSL2plus) Annex C, the upstream gains allocation table per subcarrier (see clause 7.5.1.29.4) used during NEXT_C duration is defined as NEXT upstream gains allocation (NEXT GAINSpus).

7.5.1.29.5 Downstream transmit spectrum shaping (TSSpsds)

This parameter contains the downstream transmit spectrum shaping parameters expressed as the set of breakpoints exchanged during G.994.1. Each breakpoint consists of a subcarrier index and the associated shaping parameter. The shaping parameter is an integer value in the 0 to 126 range. It is represented as a multiple of –0.5 dB. A special value indicates that the subcarrier is not transmitted. The same TSSpsds format shall be applied to G.992.3 and G.992.5 Annex C FEXT TSSpsds and NEXT TSSpsds.

7.5.1.29.5.1 FEXT downstream transmit spectrum shaping (FEXT TSSpsds)

For G.992.3 (ADSL2) Annex C and G.992.5 (ADSL2plus) Annex C, the downstream transmit spectrum shaping parameter set per subcarrier (see clause 7.5.1.29.5) used during FEXT_R duration is defined as FEXT downstream transmit spectrum shaping (FEXT TSSpsds).

7.5.1.29.5.2 NEXT downstream transmit spectrum shaping (NEXT TSSpsds)

For G.992.3 (ADSL2) Annex C and G.992.5 (ADSL2plus) Annex C, the downstream transmit spectrum shaping parameter set per subcarrier (see clause 7.5.1.29.5) used during NEXT_R duration is defined as NEXT downstream transmit spectrum shaping (NEXT TSSpsds).

7.5.1.29.6 Upstream transmit spectrum shaping (TSSpsus)

This parameter contains the upstream transmit spectrum shaping parameters expressed as the set of breakpoints exchanged during G.994.1. Each breakpoint consists of a subcarrier index and the associated shaping parameter. The shaping parameter is an integer value in the 0 to 126 range. It is represented as a multiple of –0.5 dB. A special value indicates that the subcarrier is not transmitted. The same TSSpsus format shall be applied to G.992.3 and G.992.5 Annex C FEXT TSSpsus and NEXT TSSpsus.

7.5.1.29.6.1 FEXT upstream transmit spectrum shaping (FEXT TSSpsus)

For G.992.3 (ADSL2) Annex C and G.992.5 (ADSL2plus) Annex C, the upstream transmit spectrum shaping parameter set per subcarrier (see clause 7.5.1.29.6) used during FEXT_C duration is defined as FEXT upstream transmit spectrum shaping (FEXT TSSpsus).

7.5.1.29.6.2 NEXT upstream transmit spectrum shaping (NEXT TSSpsus)

For G.992.3 (ADSL2) Annex C and G.992.5 (ADSL2plus) Annex C, the upstream transmit spectrum shaping parameter set per subcarrier (see clause 7.5.1.29.6) used during NEXT_C duration is defined as NEXT upstream transmit spectrum shaping (NEXT TSSpsus).

7.5.1.29.7 Downstream MEDLEY reference PSD (MREFPSDs)

This parameter shall contain the set of breakpoints exchanged in the MREFPSDs fields of the O-PRM message of ITU-T G.993.2. The format shall be as specified in [ITU-T G.993.2].

7.5.1.29.8 Upstream MEDLEY reference PSD (MREFPSDus)

This parameter shall contain the set of breakpoints exchanged in the MREFPSDus fields of the R-PRM message of ITU-T G.993.2. The format shall be as specified in [ITU-T G.993.2].

7.5.1.30 Downstream trellis use (TRELLISds)

This parameter reports whether trellis coding is in use in the downstream direction. It is represented as one bit coded as 0 if the trellis is not used and as 1 if the trellis is used.

7.5.1.31 Upstream trellis use (TRELLISus)

This parameter reports whether trellis coding is in use in the upstream direction. It is represented as one bit coded as 0 if the trellis is not used and as 1 if the trellis is used.

7.5.1.32 Actual cyclic extension (ACTUALCE)

This parameter reports the cyclic extension used on the line. It is coded as an unsigned integer from 2 to 16 in units of $N/32$ samples, where $2N$ is the IDFT size.

7.5.1.33 Actual rate adaptation mode

7.5.1.33.1 Actual downstream rate adaptation mode (ACT-RA-MODEds)

This parameter indicates the actual active RA-MODE in the downstream direction.

If ACT-RA-MODEds equals 1, the link is operating in RA-MODE 1 (MANUAL).

If ACT-RA-MODEds equals 2, the link is operating in RA-MODE 2 (AT_INIT).

If ACT-RA-MODEds equals 3, the link is operating in RA-MODE 3 (DYNAMIC).

NOTE 1 – In [ITU-T G.992.3] ACT-RA-MODEds=3 corresponds to SRA supported. In [ITU-T G.993.2] ACT-RA-MODEds=3 corresponds to SRA supported by both XTUs in the downstream direction, but SOS not supported by both XTUs in the downstream direction.

If ACT-RA-MODEds equals 4, the link is operating in RA-MODE 4 (DYNAMIC with SOS).

NOTE 2 – In [ITU-T G.992.3] ACT-RA-MODEds=4 is not defined. In [ITU-T G.993.2] ACT-RA-MODEds=4 corresponds to SOS and SRA supported by both XTUs in the downstream direction.

7.5.1.33.2 Actual upstream rate adaptation mode (ACT-RA-MODEus)

This parameter indicates the actual active RA-MODE in the upstream direction.

If ACT-RA-MODEus equals 1, the link is operating in RA-MODE 1 (MANUAL).

If ACT-RA-MODEus equals 2, the link is operating in RA-MODE 2 (AT_INIT).

If ACT-RA-MODEus equals 3, the link is operating in RA-MODE 3 (DYNAMIC).

NOTE 1 – In [ITU-T G.992.3] ACT-RA-MODEus=3 corresponds to SRA supported. In [ITU-T G.993.2] ACT-RA-MODEus=3 corresponds to SRA supported by both XTUs in the upstream direction, but SOS not supported by both XTUs in the upstream direction.

If ACT-RA-MODEus equals 4, the link is operating in RA-MODE 4 (DYNAMIC with SOS).

NOTE 2 – In [ITU-T G.992.3] ACT-RA-MODEus=4 is not defined. In [ITU-T G.993.2] ACT-RA-MODEus=4 corresponds to SOS and SRA supported by both XTUs in the upstream direction.

7.5.1.34 Actual impulse noise protection of ROC

7.5.1.34.1 Downstream actual impulse noise protection of ROC (ACTINP-ROC-ds)

This parameter reports the actual impulse noise protection (INP) of the ROC in the downstream direction. The format and usage is identical to the channel status parameter ACTINP (see clause 7.5.2.4).

7.5.1.34.2 Upstream actual impulse noise protection of ROC (ACTINP-ROC-us)

This parameter reports the actual impulse noise protection (INP) of the ROC in the upstream direction. The format and usage is identical to the channel status parameter ACTINP (see clause 7.5.2.4).

7.5.1.35 Actual SNR margin of ROC

7.5.1.35.1 Downstream actual SNR margin of ROC (SNRM-ROC-ds)

This parameter reports the actual signal-to-noise margin of the ROC in the downstream direction. The format is identical to the format of the line status parameter SNRM (see clause 7.5.1.13).

7.5.1.35.2 Upstream actual SNR margin of ROC (SNRM-ROC-us)

This parameter reports the actual signal-to-noise margin of the ROC in the upstream direction. The format is identical to the format of the line status parameter SNRM (see clause 7.5.1.16).

7.5.1.36 Update request flags and time stamps of test parameters

7.5.1.36.1 Update request flag for near-end test parameters (UPDATE-TEST-NE)

This parameter is defined to force an update of the near-end test parameters that can be updated during showtime. The parameter is configurable over the Q-interface and the valid values are 0 and 1. When this parameter is set (its value is changed from 0 to 1), the near-end test parameters shall be updated in the AN MIB within 10 seconds. The update request flag for the near-end test parameters is defined in the AN MIB and is independent of any autonomous update process in the system. The parameter shall be reset (its value changed back to 0) by the AN after a period shorter than 3 minutes to allow reception of another update request. The 3-minute period starts since the last time the flag was set (externally or by an autonomous process in the system). This applies only to the elements maintained in the AN (see the last paragraph of clause 7).

7.5.1.36.2 Update request flag for far-end test parameters (UPDATE-TEST-FE)

This parameter is defined to force an update of the far-end test parameters that can be updated during showtime. The parameter is configurable over the Q-interface and the valid values are 0 and 1. When this parameter is set (its value is changed from 0 to 1), the far-end test parameters shall be updated in the AN MIB within 30 seconds. The update request flag for the far-end test parameters is defined in the AN MIB and is independent of any autonomous update process in the system. The parameter shall be reset (its value changed back to 0) by the AN after a period shorter than 3 minutes to allow reception of another update request. The 3-minute period starts since the last time the flag was set (externally or by an autonomous process in the system). This applies only to the elements maintained in the AN (see the last paragraph of clause 7).

7.5.1.36.3 Date/time-stamping of near-end test parameters (STAMP-TEST-NE)

This parameter is defined in the AN MIB and indicates the date/time when the near-end test parameters that can change during showtime were last updated. This date/time-stamp shall include information on the Year, Month, Day, Hour, Minute and Second of the last update.

7.5.1.36.4 Date/time-stamping of far-end test parameters (STAMP-TEST-FE)

This parameter is defined in the AN MIB and indicates the date/time when the far-end test parameters that can change during showtime were last updated. This date/time-stamp shall include information on the Year, Month, Day, Hour, Minute and Second of the last update.

7.5.1.37 On-line reconfiguration (OLR) time stamps

7.5.1.37.1 Date/time-stamping of last successful downstream OLR operation (STAMP-OLR-ds)

This parameter indicates the date/time of the last successful OLR execution in the downstream direction that has modified the bits or gains. This date/time-stamp shall include information on the Year, Month, Day, Hour, Minute and Second of the last OLR.

7.5.1.37.2 Date/time-stamping of last successful upstream OLR operation (STAMP-OLR-us)

This parameter indicates the date/time of the last successful OLR execution in the upstream direction that has modified the bits or gains. This date/time-stamp shall include information on the Year, Month, Day, Hour, Minute and Second of the last OLR.

7.5.2 Channel status parameters

7.5.2.1 Actual data rate

In L0 state, this parameter reports the actual net data rate the bearer channel is operating at. In L1 or L2 states, the parameter contains the net data rate in the previous L0 state. The data rate is coded in steps of 1000 bit/s.

This parameter shall be reported with the most recent values when read over the Q interface.

7.5.2.2 Previous data rate

This parameter reports the previous net data rate the bearer channel was operating at just before the latest net data rate change event occurred, excluding all transitions between L0 state and L1 or L2 states. A net data rate change can occur at a power management state transition, e.g., at full or short initialization, fast retrain or power down or at a dynamic rate adaptation. The rate is coded in steps of 1000 bit/s.

7.5.2.3 Actual interleaving delay

This parameter is the actual one-way interleaving delay introduced by the PMS-TC between the alpha and beta reference points excluding delay in L1 and L2 state. In L1 and L2 state, the parameter contains the interleaving delay in the previous L0 state. For ADSL, this parameter is derived from the S and D parameters as $\lceil S \cdot D \rceil / 4$ ms, where "S" is the symbols per codeword, and "D" is the "Interleaving Depth" and $\lceil x \rceil$ denotes rounding to the higher integer. For [ITU-T G.993.2], this parameter shall be computed according to the formula in clause 9.7 of [ITU-T G.993.2]. The actual interleaving delay is coded in ms (rounded to the nearest ms).

7.5.2.4 Actual impulse noise protection (ACTINP)

This parameter reports the actual impulse noise protection (INP) on the bearer channel in the L0 state. In the L1 or L2 state, the parameter contains the INP in the previous L0 state.

For [ITU-T G.992.1], this value is computed according to the formula specified in this Recommendation based on the actual framing parameters. For [ITU-T G.992.3] and [ITU-T G.992.5], this value is estimated by the xTU receiver. It is identical to the INP_{act_n} for the corresponding bearer channel as defined in these Recommendations (clauses K.1.7, K.2.7 and K.3.7 of [ITU-T G.992.3]). For [ITU-T G.993.2], the method to report this value is according to the INPREPORT parameter.

The value is coded in fractions of DMT symbols with a granularity of 0.1 symbols. The range is from 0 to 25.4. A special value indicates an ACTINP higher than 25.4.

7.5.2.4.1 Special requirements for [ITU-T G.992.1]

For [ITU-T G.992.1], the reporting of ACTINP is optional. If reported, the ACTINP value of a bearer mapped in the interleaved path shall be computed by the formula:

$$ACTINP = \left(\frac{1}{2}\right) \times (S \times D) \times \left(\frac{R_I}{N_I}\right)$$

where S, D, R_I and N_I are defined in [ITU-T G.992.1]. The ACTINP value of a bearer mapped in the fast path shall be 0.

7.5.2.5 Impulse noise protection reporting mode (INPREPORT)

This parameter reports the method used to compute the ACTINP. If set to 0, the ACTINP is computed according to the INP_no_erasure formula (see clause 9.6 of [ITU-T G.993.2]). If set to 1, the ACTINP is the value estimated by the xTU receiver.

7.5.2.6 Actual framer settings

7.5.2.6.1 Actual size of Reed-Solomon codeword (NFEC)

This parameter reports the actual Reed-Solomon codeword size used in the latency path in which the bearer channel is transported. The value is coded in bytes. It ranges from 0 to 255.

7.5.2.6.2 Actual number of Reed-Solomon redundancy bytes (RFEC)

This parameter reports the actual number of Reed-Solomon redundancy bytes per codeword used in the latency path in which the bearer channel is transported. The value is coded in bytes. It ranges from 0 to 16. The value 0 indicates no Reed-Solomon coding.

7.5.2.6.3 Actual number of bits per symbol (LSYMB)

This parameter reports the actual number of bits per symbol assigned to the latency path in which the bearer channel is transported. This value does not include trellis overhead. The value is coded in bits. It ranges from 0 to 65535.

7.5.2.6.4 Actual interleaving depth (INTLVDEPTH)

This parameter reports the actual depth of the interleaver used in the latency path in which the bearer channel is transported. The value ranges from 1 to 4096 in steps of 1. The value 1 indicates no interleaving.

7.5.2.6.5 Actual interleaving block length (INTLVBLOCK)

This parameter reports the actual block length of the interleaver used in the latency path in which the bearer channel is transported. The value ranges from 4 to 255 in steps of 1.

7.5.2.7 Actual latency path (LPATH)

This parameter reports the index of the actual latency path in which the bearer is transported. The valid values are 0, 1, 2, 3. For [ITU-T G.992.1], the FAST path shall be mapped to the latency index 0, and the INTERLEAVED path shall be mapped to the latency index 1.

7.6 Network management elements partitioning

This clause defines the network management elements which correspond to the specific management interfaces:

Q-interface: Management interface towards the xTU-C, from the network side perspective. The xTU-C provides its near-end (at xTU-C) and far-end (at xTU-R) parameters for the system operator to read and write.

U-C interface:	Management interface towards the xTU-C, from the xTU-R's perspective. The xTU-C provides its near-end parameters (xTU-R far-end) for the xTU-R to read.
U-R interface:	Management interface towards the xTU-R, from the xTU-C's perspective. The xTU-R provides its near-end parameters (xTU-C far-end) for the xTU-C to read.
T-/S-interface:	Management interface towards the xTU-R, from the premises side perspective. The xTU-R provides its near-end (at xTU-R) and far-end (at xTU-C) parameters for the subscriber to read and write.
G-interface:	Management interface towards the xTU-R, from the NMS perspective. The xTU-R provides its near-end (at xTU-R) and far-end (at xTU-C) parameters for the NMS to read.

The U-C and U-R management interfaces represent the network management elements to be supported through the OAM communications channel specified in this Recommendation (see clause 6). The exchange between the xTU-C and xTU-R of some or all of these network management elements may already be obtained by the EOC commands defined in the respective Recommendations.

The parameters at the management interfaces are described in two categories. Each category is presented by two tables. The first table (e.g., Table 7-10 for "Line failures") indicates the status of the parameter at the corresponding management interface as:

- R: Read only.
- W: Write only.
- R/W: Read and write.
- (M): Mandatory.
- (O): Optional.

If the status of the parameter over the G-interface is not explicitly stated, it is identical to the status of the same parameter over the T-/S-interface.

NOTE – Some management elements are useful only when optional features of the physical layer Recommendation are supported by the xTUs.

The far-end fault and performance monitoring over the Q-interface is equivalent to the near-end fault and performance monitoring over the T-/S-interface. The near-end fault and performance monitoring over the Q-interface is equivalent to the far-end fault and performance monitoring over the T-/S-interface. Over the Q-interface, near-end fault and performance monitoring applies to the upstream direction only and far-end performance monitoring applies to the downstream direction only. Over the T-/S-interface, near-end fault and performance monitoring applies to the downstream direction only and far-end performance monitoring applies to the upstream direction only.

The second table for each category (e.g., Table 7-11 for "Line failures") indicates for which Recommendations the management element is relevant. A "Y" in a column means that this MIB element is relevant for the specified Recommendation over at least one of the interfaces.

Table 7-10 – Line failures

Category/Element	Defined in:	Q-Interface	U-C Interface	U-R Interface	T-/S-Interface
<i>Near-end (xTU-C) failures</i>					
Loss-of-signal (LOS)	7.1.1.1.1	R (M)	R (O)		R (O)
Loss-of-frame (LOF)	7.1.1.1.2	R (M)	R (O)		R (O)
Loss-of-power (LPR)	7.1.1.1.3	R (M)	R (O)		R (O)
<i>Far-end (xTU-R) failures</i>					
Loss-of-signal (LOS-FE) failure	7.1.1.2.1	R (M)		R (O)	R (O)
Loss-of-frame (LOF-FE) failure	7.1.1.2.2	R (M)		R (O)	R (O)
Loss-of-power (LPR-FE) failure	7.1.1.2.3	R (M)		R (O)	R (O)
<i>Initialization failures</i>					
Line init (LINIT) failure	7.1.1.3	R (M)			R (O)

Table 7-11 – Support of line failures per Recommendation

Category/Element	G.992.1	G.992.2	G.992.3	G.992.4	G.992.5	G.993.2
<i>Near-end failures</i>						
Loss-of-signal (LOS)	Y	Y	Y	Y	Y	Y
Loss-of-frame (LOF)	Y	Y	Y	Y	Y	Y
Loss-of-power (LPR)	Y	Y	Y	Y	Y	Y
<i>Far-end failures</i>						
Loss-of-signal (LOS-FE) failure	Y	Y	Y	Y	Y	Y
Loss-of-frame (LOF-FE) failure	Y	Y	Y	Y	Y	Y
Loss-of-power (LPR-FE) failure	Y	Y	Y	Y	Y	Y
<i>Initialization failures</i>						
Line init (LINIT) failure	Y	Y	Y	Y	Y	Y

Table 7-12 – ATM data path failures

Category/Element	Defined in:	Q-Interface	U-C Interface	U-R Interface	T-/S-Interface
<i>Near-end (xTU-C) failures</i>					
No cell delineation (NCD) failure	7.1.4.1.1	R (M)	R (O)		
Loss of cell delineation (LCD) failure	7.1.4.1.2	R (M)	R (O)		
<i>Far-end (xTU-R) failures</i>					
No cell delineation (NCD-FE) failure	7.1.4.2.1	R (M)		R (O)	
Loss of cell delineation (LCD-FE) failure	7.1.4.2.2	R (M)		R (O)	

Table 7-13 – Support of ATM data path failures per Recommendation

Category/Element	G.992.1	G.992.2	G.992.3	G.992.4	G.992.5	G.993.2
<i>Near-end failures</i>						
No cell delineation (NCD) failure	Y	Y	Y	Y	Y	Y
Loss of cell delineation (LCD) failure	Y	Y	Y	Y	Y	Y
<i>Far-end failures</i>						
No cell delineation (NCD-FE) failure	Y	Y	Y	Y	Y	Y
Loss of cell delineation (LCD-FE) failure	Y	Y	Y	Y	Y	Y

Table 7-14 – Line configuration profile

Category/Element	Defined in:	Q-Interface	U-C Interface	U-R Interface	T-/S-Interface
<i>Line/xTU state</i>					
xTU transmission system enabling (XTSE)	7.3.1.1.1	R/W (M)			R (O)
ATU impedance state forced (AISF)	7.3.1.1.2				R/W (M)
Power management state forced (PMSF)	7.3.1.1.3	R/W (M)			R/W (M)
Power management state enabling (PMMODE)	7.3.1.1.4	R/W (M)			
L0-TIME	7.3.1.1.5	R/W (M)	R (O)		
L2-TIME	7.3.1.1.6	R/W (M)	R (O)		
L2-ATPR	7.3.1.1.7	R/W (M)	R (O)		
L2-ATPRT	7.3.1.1.9	R/W (M)	R (O)		
Loop diagnostic mode forced (LDSF)	7.3.1.1.8	R/W (M)			R/W (M)
Automode cold start forced	7.3.1.1.10	R/W (M)			R/W (O)
VDSL2 profiles enabling (PROFILES)	7.3.1.1.11	R/W (M)			R (O)
<i>Power and spectrum usage</i>					
MAXNOMPSD ds	7.3.1.2.1	R/W (M)	R (O)		
MAXNOMPSD us	7.3.1.2.2	R/W (M)	R (O)		
MAXNOMATP ds	7.3.1.2.3	R/W (M)	R (O)		
MAXNOMATP us	7.3.1.2.4	R/W (M)	R (O)		
MAXRXPWR us	7.3.1.2.5	R/W (M)	R (O)		
CARMASK ds	7.3.1.2.6	R/W (M)	R (O)		
CARMASK us	7.3.1.2.7	R/W (M)	R (O)		
VDSL2-CARMASK	7.3.1.2.8	R/W (M)	R (O)		
PSDMASK ds	7.3.1.2.9	R/W (M)	R (O)		

Table 7-14 – Line configuration profile

Category/Element	Defined in:	Q-Interface	U-C Interface	U-R Interface	T-/S-Interface
RFIBANDS	7.3.1.2.10	R/W (M)	R (O)		
Upstream PSD mask selection	7.3.1.2.11	R/W (M)	R (O)		
PSDMASK us	7.3.1.2.12	R/W (M)	R (O)		
DPBOSHAPED	7.3.1.2.13	R/W (M)	R (O)		
UPBOSHAPED (UPBOPSD-pb, UPBOKL, UPBOKLF)	7.3.1.2.14	R/W (M)	R (O)		
UPBOSHAPED (UPBOKLREF-pb)	7.3.1.2.14	R/W (O)	R (O)		
VDSL2 PSD mask class selection (CLASSMASK)	7.3.1.2.15	R/W (M)			
VDSL2 limit PSD masks and band plans enabling (LIMITMASK)	7.3.1.2.16	R/W (M)			R (O)
VDSL2 US0 disabling (US0DISABLE)	7.3.1.2.17	R/W (M)			
VDSL2 US0 PSD masks (US0MASK)	7.3.1.2.18	R/W (M)			R (O)
Noise margins					
TARSNRM ds	7.3.1.3.1	R/W (M)	R (O)		
TARSNRM us	7.3.1.3.2	R/W (M)	R (O)		
MAXSNRM ds	7.3.1.3.3	R/W (M)	R (O)		
MAXSNRM us	7.3.1.3.4	R/W (M)	R (O)		
MINSNRM ds	7.3.1.3.5	R/W (M)	R (O)		
MINSNRM us	7.3.1.3.6	R/W (M)	R (O)		
Rate adaptation					
RA-MODE ds	7.3.1.4.1	R/W (M)	R (O)		
RA-MODE us	7.3.1.4.2	R/W (M)	R (O)		
RA-USNRM ds	7.3.1.4.3	R/W (O)	R (O)		
RA-USNRM us	7.3.1.4.4	R/W (O)	R (O)		
RA-UTIME ds	7.3.1.4.5	R/W (O)	R (O)		
RA-UTIME us	7.3.1.4.6	R/W (O)	R (O)		
RA-DSNRM ds	7.3.1.4.7	R/W (O)	R (O)		
RA-DSNRM us	7.3.1.4.8	R/W (O)	R (O)		
RA-DTIME ds	7.3.1.4.9	R/W (O)	R (O)		
RA-DTIME us	7.3.1.4.10	R/W (O)	R (O)		
Overhead					
MSGMIN us	7.3.1.5.1	R/W (O)	R (O)		
MSGMIN ds	7.3.1.5.2	R/W (O)	R (O)		
Cyclic extension					
CEFLAG	7.3.1.6.1	R/W (M)	R (O)		

Table 7-14 – Line configuration profile

Category/Element	Defined in:	Q-Interface	U-C Interface	U-R Interface	T-/S-Interface
<i>Transmitter referred virtual noise</i>					
SNRMODEds	7.3.1.7.1	R/W (M)	R (O)		R (M)
SNRMODEus	7.3.1.7.2	R/W (M)	R (O)		
TXREFVNds	7.3.1.7.3	R/W (M)	R (O)		R (M)
FEXT TXREFVNds	7.3.1.7.3.1	R/W (M)	R (O)		R (M)
NEXT TXREFVNds	7.3.1.7.3.2	R/W (M)	R (O)		R (M)
TXREFVNus	7.3.1.7.4	R/W (M)	R (O)		R (M)
<i>Near-end (xTU-C) performance monitoring thresholds (15-minute interval)</i>					
FECS-L threshold 15 minutes	7.3.1.8	R/W (O)	R (O)		
ES-L threshold 15 minutes	7.3.1.8	R/W (M)	R (O)		
SES-L threshold 15 minutes	7.3.1.8	R/W (M)	R (O)		
LOSS-L threshold 15 minutes	7.3.1.8	R/W (O)	R (O)		
UAS-L threshold 15 minutes	7.3.1.8	R/W (M)	R (O)		
<i>Near-end (xTU-C) performance monitoring thresholds (24-hour interval)</i>					
FECS-L threshold 24 hours	7.3.1.8	R/W (O)	R (O)		
ES-L threshold 24 hours	7.3.1.8	R/W (M)	R (O)		
SES-L threshold 24 hours	7.3.1.8	R/W (M)	R (O)		
LOSS-L threshold 24 hours	7.3.1.8	R/W (O)	R (O)		
UAS-L threshold 24 hours	7.3.1.8	R/W (M)	R (O)		
<i>Far-end (xTU-R) performance monitoring thresholds (15-minute interval)</i>					
FECS-LFE threshold 15 minutes	7.3.1.8	R/W (O)	R (O)		
ES-LFE threshold 15 minutes	7.3.1.8	R/W (M)	R (O)		
SES-LFE threshold 15 minutes	7.3.1.8	R/W (M)	R (O)		
LOSS-LFE threshold 15 minutes	7.3.1.8	R/W (O)	R (O)		
UAS-LFE threshold 15 minutes	7.3.1.8	R/W (M)	R (O)		
<i>Far-end (xTU-R) performance monitoring thresholds (24-hour interval)</i>					
FECS-LFE threshold 24 hours	7.3.1.8	R/W (O)	R (O)		
ES-LFE threshold 24 hours	7.3.1.8	R/W (M)	R (O)		
SES-LFE threshold 24 hours	7.3.1.8	R/W (M)	R (O)		
LOSS-LFE threshold 24 hours	7.3.1.8	R/W (O)	R (O)		
UAS-LFE threshold 24 hours	7.3.1.8	R/W (M)	R (O)		
<i>Initialization performance monitoring thresholds (15-minute interval)</i>					
Full inits threshold 15 minutes	7.3.1.8	R (M)	R (O)		
Failed full inits threshold 15 minutes	7.3.1.8	R (M)	R (O)		
Short inits threshold 15 minutes	7.3.1.8	R (O)	R (O)		
Failed short inits threshold 15 minutes	7.3.1.8	R (O)	R (O)		

Table 7-14 – Line configuration profile

Category/Element	Defined in:	Q-Interface	U-C Interface	U-R Interface	T-/S-Interface
<i>Initialization performance monitoring thresholds (24-hour interval)</i>					
Full inits threshold 24 hours	7.3.1.8	R (M)	R (O)		
Failed full inits threshold 24 hours	7.3.1.8	R (M)	R (O)		
Short inits threshold 24 hours	7.3.1.8	R (O)	R (O)		
Failed short inits threshold 24 hours	7.3.1.8	R (O)	R (O)		
<i>INM configuration parameters</i>					
INMIATods	7.3.1.9.1	R/W (O)		R/W (O)	R (O)
INMIATOUS	7.3.1.9.1	R/W (O)			
INMIATSDs	7.3.1.9.2	R/W (O)		R/W (O)	R (O)
INMIATSUS	7.3.1.9.2	R/W (O)			
INMCCds	7.3.1.9.3	R/W (O)		R/W (O)	R (O)
INMCCus	7.3.1.9.3	R/W (O)			
INM_INPEQ_MODEds	7.3.1.9.4	R/W (O)		R/W (O)	R (O)
INM_INPEQ_MODEus	7.3.1.9.4	R/W (O)			
<i>SOS configuration parameters</i>					
SOS-TIME-ds	7.3.1.10.1	R/W (O)	R (O)		
SOS-TIME-us	7.3.1.10.2	R/W (O)			
SOS-NTONES-ds	7.3.1.10.3	R/W (O)	R (O)		
SOS-NTONES-us	7.3.1.10.4	R/W (O)			
SOS-CRC-ds	7.3.1.10.5	R/W (O)	R (O)		
SOS-CRC-us	7.3.1.10.6	R/W (O)			
MAX-SOS-ds	7.3.1.10.7	R/W (O)	R (O)		
MAX-SOS-us	7.3.1.10.8	R/W (O)			
SNRMOFFSET-ROC-ds	7.3.1.10.9	R/W (O)	R (O)		
SNRMOFFSET-ROC-us	7.3.1.10.10	R/W (O)			
INPMIN-ROC-ds	7.3.1.10.11	R/W (O)	R (O)		
INPMIN-ROC-us	7.3.1.10.12	R/W (O)			

Table 7-15 – Support of line configuration parameters per Recommendation

Category/ Element	G.992.1	G.992.2	G.992.3	G.992.4	G.992.5	G.993.2
<i>Line/xTU state</i>						
xTU transmission system enabling (XTSE)	Y	Y	Y	Y	Y	Y
ATU impedance state forced (AISF)			Y (Annex A)	Y (Annex A)	Y (Annex A)	
Power management state forced (PMSF)	Y	Y	Y	Y	Y	Y
Power management state enabling (PMMODE)	Y	Y	Y	Y	Y	Y
L0-TIME			Y	Y	Y	
L2-TIME			Y	Y	Y	
L2-ATPR			Y	Y	Y	
L2-ATPRT			Y	Y	Y	
Loop diagnostic mode forced (LDSF)			Y	Y	Y	Y
Automode cold start forced			Y	Y	Y	Y
VDSL2 profiles enabling (PROFILES)						Y
<i>Power and spectrum usage</i>						
MAXNOMPSD ds			Y	Y	Y	
MAXNOMPSD us			Y	Y	Y	
MAXNOMATP ds			Y	Y	Y	Y
MAXNOMATP us			Y	Y	Y	
MAXRXPWR us			Y	Y	Y	
CARMASK ds			Y	Y	Y	
CARMASK us			Y	Y	Y	
VDSL2-CARMASK						Y
PSDMASK ds					Y	Y
RFIBANDS					Y	Y
Upstream PSD mask selection			Y		Y	
PSDMASK us			Y (Annexes J/ M)		Y (Annexes J/ M)	Y
DPBOSHAPED					Y	Y
UPBOSHAPED (UPBOPSD-pb, UPBOKL, UPBOKLF)						Y
UPBOSHAPED (UPBOKLREF-pb)						Y
VDSL2 PSD mask class selection (CLASSMASK)						Y

Table 7-15 – Support of line configuration parameters per Recommendation

Category/ Element	G.992.1	G.992.2	G.992.3	G.992.4	G.992.5	G.993.2
VDSL2 limit PSD masks and band plans enabling (LIMITMASK)						Y
VDSL2 US0 disabling (US0DISABLE)						Y
VDSL2 US0 masks enabling (US0MASK)						Y (Annex A)
Noise margins						
TARSNRM ds	Y	Y	Y	Y	Y	Y
TARSNRM us	Y	Y	Y	Y	Y	Y
MAXSNRM ds	Y	Y	Y	Y	Y	Y
MAXSNRM us	Y	Y	Y	Y	Y	Y
MINSNRM ds	Y	Y	Y	Y	Y	Y
MINSNRM us	Y	Y	Y	Y	Y	Y
Rate adaptation						
RA-MODE ds		Y	Y	Y	Y	Y
RA-MODE us		Y	Y	Y	Y	Y
RA-USNRM ds		Y	Y	Y	Y	Y
RA-USNRM us		Y	Y	Y	Y	Y
RA-UTIME ds		Y	Y	Y	Y	Y
RA-UTIME us		Y	Y	Y	Y	Y
RA-DSNRM ds		Y	Y	Y	Y	Y
RA-DSNRM us		Y	Y	Y	Y	Y
RA-DTIME ds		Y	Y	Y	Y	Y
RA-DTIME us		Y	Y	Y	Y	Y
Overhead						
MSGMIN us			Y	Y	Y	Y
MSGMIN ds			Y	Y	Y	Y
Cyclic extension						
CEFLAG						Y
Transmitter referred virtual noise						
SNRMODEds			Y		Y	Y
SNRMODEus			Y		Y	Y
TXREFVNds			Y		Y	Y
FEXT TXREFVNds			Y		Y	
NEXT TXREFVNds			Y		Y	
TXREFVNus			Y		Y	Y

Table 7-15 – Support of line configuration parameters per Recommendation

Category/ Element	G.992.1	G.992.2	G.992.3	G.992.4	G.992.5	G.993.2
<i>Near-end performance monitoring thresholds (15-minute interval)</i>						
FECS-L threshold 15 minutes	Y	Y	Y	Y	Y	Y
ES-L threshold 15 minutes	Y	Y	Y	Y	Y	Y
SES-L threshold 15 minutes	Y	Y	Y	Y	Y	Y
LOSS-L threshold 15 minutes	Y	Y	Y	Y	Y	Y
UAS-L threshold 15 minutes	Y	Y	Y	Y	Y	Y
<i>Near-end performance monitoring thresholds (24-hour interval)</i>						
FECS-L threshold 24 hours	Y	Y	Y	Y	Y	Y
ES-L threshold 24 hours	Y	Y	Y	Y	Y	Y
SES-L threshold 24 hours	Y	Y	Y	Y	Y	Y
LOSS-L threshold 24 hours	Y	Y	Y	Y	Y	Y
UAS-L threshold 24 hours	Y	Y	Y	Y	Y	Y
<i>Far-end performance monitoring thresholds (15-minute interval)</i>						
FECS-LFE threshold 15 minutes	Y	Y	Y	Y	Y	Y
ES-LFE threshold 15 minutes	Y	Y	Y	Y	Y	Y
SES-LFE threshold 15 minutes	Y	Y	Y	Y	Y	Y
LOSS-LFE threshold 15 minutes	Y	Y	Y	Y	Y	Y
UAS-LFE threshold 15 minutes	Y	Y	Y	Y	Y	Y
<i>Far-end performance monitoring thresholds (24-hour interval)</i>						
FECS-LFE threshold 24 hours	Y	Y	Y	Y	Y	Y
ES-LFE threshold 24 hours	Y	Y	Y	Y	Y	Y
SES-LFE threshold 24 hours	Y	Y	Y	Y	Y	Y
LOSS-LFE threshold 24 hours	Y	Y	Y	Y	Y	Y
UAS-LFE threshold 24 hours	Y	Y	Y	Y	Y	Y
<i>Initialization performance monitoring thresholds (15-minute interval)</i>						
Full inits threshold 15 minutes	Y	Y	Y	Y	Y	Y
Failed full inits threshold 15 minutes	Y	Y	Y	Y	Y	Y
Short inits threshold 15 minutes		Y	Y	Y	Y	Y
Failed short inits threshold 15 minutes		Y	Y	Y	Y	Y

Table 7-15 – Support of line configuration parameters per Recommendation

Category/ Element	G.992.1	G.992.2	G.992.3	G.992.4	G.992.5	G.993.2
<i>Initialization performance monitoring thresholds (24-hour interval)</i>						
Full inits threshold 24 hours	Y	Y	Y	Y	Y	Y
Failed full inits threshold 24 hours	Y	Y	Y	Y	Y	Y
Short inits threshold 24 hours		Y	Y	Y	Y	Y
Failed short inits threshold 24 hours		Y	Y	Y	Y	Y
<i>INM configuration parameters</i>						
INMIATods			Y		Y	Y
INMIATOUS						Y
INMIATSDs			Y		Y	Y
INMIATSUS						Y
INMCCds			Y		Y	Y
INMCCus						Y
INM_INPEQ_MODEds			Y		Y	Y
INM_INPEQ_MODEus						Y
<i>SOS configuration parameters</i>						
SOS-TIME-ds						Y
SOS-TIME-us						Y
SOS-NTONES-ds						Y
SOS-NTONES-us						Y
SOS-CRC-ds						Y
SOS-CRC-us						Y
MAX-SOS-ds						Y
MAX-SOS-us						Y
SNRMOFFSET-ROC-ds						Y
SNRMOFFSET-ROC-us						Y
INPMIN-ROC-ds						Y
INPMIN-ROC-us						Y

Table 7-16 – Channel configuration profile

Category/Element	Defined in:	Q-Interface	U-C Interface	U-R Interface	T-/S-Interface
<i>Data Rate</i>					
Minimum data rate	7.3.2.1.1	R/W (M)	R (O)		
Minimum reserved data rate	7.3.2.1.2	R/W (O)	R (O)		
Maximum data rate	7.3.2.1.3	R/W (M)	R (O)		
Rate adaptation ratio	7.3.2.1.4	R/W (O)	R (O)		
Minimum data rate in low power state	7.3.2.1.5	R/W (M)	R (O)		
MIN-SOS-BR-ds	7.3.2.1.6	R/W (O)	R (O)		
MIN-SOS-BR-us	7.3.2.1.7	R/W (O)			
Maximum interleaving delay	7.3.2.2	R/W (M)	R (O)		
Minimum impulse noise protection (INPMIN)	7.3.2.3	R/W (M/O) (Note 1)	R (O)		
Minimum impulse noise protection 8 kHz (INPMIN8)	7.3.2.4	R/W (M)	R (O)		
FORCEINP	7.3.2.5	R/W (M/O) (Note 2)			
Maximum bit error ratio	7.3.2.6	R/W (M)	R (O)		
Data rate threshold upshift	7.3.2.8.1	R/W (M)			
Data rate threshold downshift	7.3.2.8.2	R/W (M)			
Maximum delay variation (DVMAX)	7.3.2.9	R/W (O)			
Channel initialization policy selection (CIPOLICY)	7.3.2.10	R/W (O)			
<i>Near-end (xTU-C) performance monitoring thresholds (15-minute interval)</i>					
CV-C threshold 15 minutes	7.3.2.7	R/W (O)	R (O)		
FEC-C threshold 15 minutes	7.3.2.7	R/W (O)	R (O)		
<i>Near-end (xTU-C) performance monitoring thresholds (24-hour interval)</i>					
CV-C threshold 24 hours	7.3.2.7	R/W (O)	R (O)		
FEC-C threshold 24 hours	7.3.2.7	R/W (O)	R (O)		
<i>Far-end (xTU-R) performance monitoring thresholds (15-minute interval)</i>					
CV-CFE threshold 15 minutes	7.3.2.7	R/W (O)	R (O)		
FEC-CFE threshold 15 minutes	7.3.2.7	R/W (O)	R (O)		
<i>Far-end (xTU-R) performance monitoring thresholds (24-hour interval)</i>					
CV-CFE threshold 24 hours	7.3.2.7	R/W (O)	R (O)		
FEC-CFE threshold 24 hours	7.3.2.7	R/W (O)	R (O)		
NOTE 1 – This parameter is R/W (O) on the Q-interface for [ITU-T G.992.1] and R/W (M) for all other ITU-T Recommendations that support it. NOTE 2 – This parameter is R/W (M) on the Q-interface for [ITU-T G.993.2] and R/W (O) for all other ITU-T Recommendations that support it.					

Table 7-17 – Support of channel configuration parameters per Recommendation

Category/Element	G.992.1	G.992.2	G.992.3	G.992.4	G.992.5	G.993.2
<i>Data rate</i>						
Minimum data rate	Y	Y	Y	Y	Y	Y
Minimum reserved data rate		Y	Y	Y	Y	Y
Maximum data rate	Y	Y	Y	Y	Y	Y
Rate adaptation ratio	Y	Y	Y	Y	Y	Y
Minimum data rate in low power state		Y	Y	Y	Y	
MIN-SOS-BR-ds						Y
MIN-SOS-BR-us						Y
Maximum interleaving delay	Y	Y	Y	Y	Y	Y
Minimum impulse noise protection (INPMIN)	Y		Y	Y	Y	Y
Minimum impulse noise protection 8 kHz (INPMIN8)						Y
FORCEINP			Y		Y	Y
Maximum bit error ratio			Y	Y	Y	
Data rate threshold upshift	Y	Y	Y	Y	Y	
Data rate threshold downshift	Y	Y	Y	Y	Y	
Maximum delay variation (DVMAX)						Y
Channel initialization policy selection (CIPOLICY)			Y		Y	Y
<i>Near-end performance monitoring thresholds (15-minute interval)</i>						
CV-C threshold 15 minutes	Y	Y	Y	Y	Y	Y
FEC-C threshold 15 minutes	Y	Y	Y	Y	Y	Y
<i>Near-end performance monitoring thresholds (24-hour interval)</i>						
CV-C threshold 24 hours	Y	Y	Y	Y	Y	Y
FEC-C threshold 24 hours	Y	Y	Y	Y	Y	Y

Table 7-17 – Support of channel configuration parameters per Recommendation

Category/Element	G.992.1	G.992.2	G.992.3	G.992.4	G.992.5	G.993.2
<i>Far-end performance monitoring thresholds (15-minute interval)</i>						
CV-CFE threshold 15 minutes	Y	Y	Y	Y	Y	Y
FEC-CFE threshold 15 minutes	Y	Y	Y	Y	Y	Y
<i>Far-end performance monitoring thresholds (24-hour interval)</i>						
CV-CFE threshold 24 hours	Y	Y	Y	Y	Y	Y
FEC-CFE threshold 24 hours	Y	Y	Y	Y	Y	Y

Table 7-18 – ATM data path configuration profile

Category/Element	Defined in:	Q-Interface	U-C Interface	U-R Interface	T-/S-Interface
<i>IMA configuration</i>					
IMA operation mode enable parameter	7.3.4.1	R/W (M)			
<i>Near-end (xTU-C) performance monitoring thresholds (15-minute interval)</i>					
HEC-P threshold 15 minutes	7.3.4.2	R/W (O)	R (O)		
CD-P threshold 15 minutes	7.3.4.2	R/W (O)	R (O)		
CU-P threshold 15 minutes	7.3.4.2	R/W (O)	R (O)		
IBE-P threshold 15 minutes	7.3.4.2	R/W (O)	R (O)		
<i>Near-end (xTU-C) performance monitoring thresholds (24-hour interval)</i>					
HEC-P threshold 24 hours	7.3.4.2	R/W (O)	R (O)		
CD-P threshold 24 hours	7.3.4.2	R/W (O)	R (O)		
CU-P threshold 24 hours	7.3.4.2	R/W (O)	R (O)		
IBE-P threshold 24 hours	7.3.4.2	R/W (O)	R (O)		
<i>Far-end (xTU-R) performance monitoring thresholds (15-minute interval)</i>					
HEC-PFE threshold 15 minutes	7.3.4.2	R/W (O)	R (O)		
CD-PFE threshold 15 minutes	7.3.4.2	R/W (O)	R (O)		
CU-PFE threshold 15 minutes	7.3.4.2	R/W (O)	R (O)		
IBE-PFE threshold 15 minutes	7.3.4.2	R/W (O)	R (O)		
<i>Far-end (xTU-R) performance monitoring thresholds (24-hour interval)</i>					
HEC-PFE threshold 24 hours	7.3.4.2	R/W (O)	R (O)		
CD-PFE threshold 24 hours	7.3.4.2	R/W (O)	R (O)		
CU-PFE threshold 24 hours	7.3.4.2	R/W (O)	R (O)		
IBE-PFE threshold 24 hours	7.3.4.2	R/W (O)	R (O)		

Table 7-19 – Support of ATM data path configuration parameters per Recommendation

Category/Element	G.992.1	G.992.2	G.992.3	G.992.4	G.992.5	G.993.2
<i>IMA configuration</i>						
IMA operation mode enable parameter			Y	Y	Y	
<i>Near-end performance monitoring thresholds (15-minute interval)</i>						
HEC-P threshold 15 minutes	Y	Y	Y	Y	Y	Y
CD-P threshold 15 minutes	Y	Y	Y	Y	Y	Y
CU-P threshold 15 minutes	Y	Y	Y	Y	Y	Y
IBE-P threshold 15 minutes	Y	Y	Y	Y	Y	Y
<i>Near-end performance monitoring thresholds (24-hour interval)</i>						
HEC-P threshold 24 hours	Y	Y	Y	Y	Y	Y
CD-P threshold 24 hours	Y	Y	Y	Y	Y	Y
CU-P threshold 24 hours	Y	Y	Y	Y	Y	Y
IBE-P threshold 24 hours	Y	Y	Y	Y	Y	Y
<i>Far-end performance monitoring thresholds (15-minute interval)</i>						
HEC-PFE threshold 15 minutes	Y	Y	Y	Y	Y	Y
CD-PFE threshold 15 minutes	Y	Y	Y	Y	Y	Y
CU-PFE threshold 15 minutes	Y	Y	Y	Y	Y	Y
IBE-PFE threshold 15 minutes	Y	Y	Y	Y	Y	Y
<i>Far-end performance monitoring thresholds (24-hour interval)</i>						
HEC-PFE threshold 24 hours	Y	Y	Y	Y	Y	Y
CD-PFE threshold 24 hours	Y	Y	Y	Y	Y	Y
CU-PFE threshold 24 hours	Y	Y	Y	Y	Y	Y
IBE-PFE threshold 24 hours	Y	Y	Y	Y	Y	Y

Table 7-20 – Line inventory

Category/Element	Defined in:	Q-Interface	U-C Interface	U-R Interface	T-/S-Interface
xTU-C G.994.1 vendor ID	7.4.1	R (M)	R (O)		R (O)
xTU-R G.994.1 vendor ID	7.4.2	R (M)		R (O)	R (O)
xTU-C system vendor ID	7.4.3	R (M)	R (O)		R (O)
xTU-R system vendor ID	7.4.4	R (M)		R (O)	R (O)
xTU-C version number	7.4.5	R (M)	R (O)		R (O)
xTU-R version number	7.4.6	R (M)		R (O)	R (O)
xTU-C serial number	7.4.7	R (M)	R (O)		R (O)
xTU-R serial number	7.4.8	R (M)		R (O)	R (O)
xTU-C self-test result	7.4.9	R (M)	R (O)		R (O)
xTU-R self-test result	7.4.10	R (M)		R (O)	R (O)
xTU-C transmission system capabilities	7.4.11	R (M)	R (O)		R (O)
xTU-R transmission system capabilities	7.4.12	R (M)		R (O)	R (O)

Table 7-21 – Support of line inventory information per Recommendation

Category/Element	G.992.1	G.992.2	G.992.3	G.992.4	G.992.5	G.993.2
xTU-C G.994.1 vendor ID	Y	Y	Y	Y	Y	Y
xTU-R G.994.1 vendor ID	Y	Y	Y	Y	Y	Y
xTU-C system vendor ID	Y	Y	Y	Y	Y	Y
xTU-R system vendor ID	Y	Y	Y	Y	Y	Y
xTU-C version number	Y	Y	Y	Y	Y	Y
xTU-R version number	Y	Y	Y	Y	Y	Y
xTU-C serial number	Y	Y	Y	Y	Y	Y
xTU-R serial number	Y	Y	Y	Y	Y	Y
xTU-C self-test result	Y	Y	Y	Y	Y	Y
xTU-R self-test result	Y	Y	Y	Y	Y	Y
xTU-C transmission system capabilities	Y	Y	Y	Y	Y	Y
xTU-R transmission system capabilities	Y	Y	Y	Y	Y	Y

Table 7-22 – Line performance monitoring parameters

Category/Element	Defined in:	Q-Interface	U-C Interface	U-R Interface	T-/S-Interface
<i>Near-end (xTU-C) performance monitoring counters (current and previous 15-minute interval)</i>					
FECS-L counter 15 minutes	7.2.1.1.1	R (M)	R (O)		
ES-L counter 15 minutes	7.2.1.1.2	R (M)	R (O)		R (O)
SES-L counter 15 minutes	7.2.1.1.3	R (M)	R (O)		R (O)
LOSS-L counter 15 minutes	7.2.1.1.4	R (M)	R (O)		
UAS-L counter 15 minutes	7.2.1.1.5	R (M)	R (O)		
<i>Near-end (xTU-C) performance monitoring counters (current and previous 24-hour interval)</i>					
FECS-L counter 24 hours	7.2.1.1.1	R (M)	R (O)		
ES-L counter 24 hours	7.2.1.1.2	R (M)	R (O)		R (O)
SES-L counter 24 hours	7.2.1.1.3	R (M)	R (O)		R (O)
LOSS-L counter 24 hours	7.2.1.1.4	R (M)	R (O)		
UAS-L counter 24 hours	7.2.1.1.5	R (M)	R (O)		
<i>Far-end (xTU-R) performance monitoring counters (current and previous 15-minute interval)</i>					
FECS-LFE counter 15 minutes	7.2.1.2.1	R (M)		R (O)	
ES-LFE counter 15 minutes	7.2.1.2.2	R (M)		R (O)	R (O)
SES-LFE counter 15 minutes	7.2.1.2.3	R (M)		R (O)	R (O)
LOSS-LFE counter 15 minutes	7.2.1.2.4	R (M)		R (O)	
UAS-LFE counter 15 minutes	7.2.1.2.5	R (M)		R (O)	
<i>Far-end (xTU-R) performance monitoring counters (current and previous 24-hour interval)</i>					
FECS-LFE counter 24 hours	7.2.1.2.1	R (M)		R (O)	
ES-LFE counter 24 hours	7.2.1.2.2	R (M)		R (O)	R (O)
SES-LFE counter 24 hours	7.2.1.2.3	R (M)		R (O)	R (O)
LOSS-LFE counter 24 hours	7.2.1.2.4	R (M)		R (O)	
UAS-LFE counter 24 hours	7.2.1.2.5	R (M)		R (O)	
<i>Initialization performance monitoring counters (current and previous 15-minute interval)</i>					
Full inits counter 15 minutes	7.2.1.3.1	R (M)	R (O)		
Failed full inits counter 15 minutes	7.2.1.3.2	R (M)	R (O)		
Short inits counter 15 minutes	7.2.1.3.3	R (O)	R (O)		
Failed short inits counter 15 minutes	7.2.1.3.4	R (O)	R (O)		
<i>Initialization performance monitoring counters (current and previous 24-hour interval)</i>					
Full inits counter 24 hours	7.2.1.3.1	R (M)	R (O)		
Failed full inits counter 24 hours	7.2.1.3.2	R (M)	R (O)		
Short inits counter 24 hours	7.2.1.3.3	R (O)	R (O)		
Failed short inits counter 24 hours	7.2.1.3.4	R (O)	R (O)		

Table 7-22 – Line performance monitoring parameters

Category/Element	Defined in:	Q-Interface	U-C Interface	U-R Interface	T-/S-Interface
<i>Near-end (xTU-C) impulse noise performance monitoring counters (current and previous 15-minute interval)</i>					
INMINPEQ _{1..17} -L counter 15 minutes	7.2.1.4.1	R (O)			
INMIAT _{0..7} -L counter 15 minutes	7.2.1.4.3	R (O)			
INMME-L counter 15 minutes	7.2.1.4.2	R (O)			
<i>Near-end (xTU-C) impulse noise performance monitoring counters (current and previous 24-hour interval)</i>					
INMINPEQ _{1..17} -L counter 24 hours	7.2.1.4.1	R (O)			
INMIAT _{0..7} -L counter 24 hours	7.2.1.4.3	R (O)			
INMME-L counter 24 hours	7.2.1.4.2	R (O)			
<i>Far-end (xTU-R) impulse noise performance monitoring counters (current and previous 15-minute interval)</i>					
INMINPEQ _{1..17} -LFE counter 15 minutes	7.2.1.5.1	R (O)		R (O)	
INMIAT _{0..7} -LFE counter 15 minutes	7.2.1.5.3	R (O)		R (O)	
INMME-LFE counter 15 minutes	7.2.1.5.2	R (O)		R (O)	
<i>Far-end (xTU-R) impulse noise performance monitoring counters (current and previous 24-hour interval)</i>					
INMINPEQ _{1..17} -LFE counter 24 hours	7.2.1.5.1	R (O)		R (O)	
INMIAT _{0..7} -LFE counter 24 hours	7.2.1.5.3	R (O)		R (O)	
INMME-LFE counter 24 hours	7.2.1.5.2	R (O)		R (O)	
<i>Near-end (xTU-C) SOS performance monitoring counters (current and previous 15-minute interval)</i>					
SOS-SUCCESS-NE counter 15 minutes	7.2.1.6.1	R (O)			
<i>Near-end (xTU-C) SOS performance monitoring counters (current and previous 24-hour interval)</i>					
SOS-SUCCESS-NE counter 24 hours	7.2.1.6.1	R (O)			
<i>Far-end (xTU-R) SOS performance monitoring counters (current and previous 15-minute interval)</i>					
SOS-SUCCESS-FE counter 15 minutes	7.2.1.7.1	R (O)			
<i>Far-end (xTU-R) SOS performance monitoring counters (current and previous 24-hour interval)</i>					
SOS-SUCCESS-FE counter 24 hours	7.2.1.7.1	R (O)			

Table 7-23 – Support of line performance monitoring parameters per Recommendation

Category/Element	G.992.1	G.992.2	G.992.3	G.992.4	G.992.5	G.993.2
<i>Near-end performance monitoring counters (current and previous 15-minute interval)</i>						
FECS-L counter 15 minutes	Y	Y	Y	Y	Y	Y
ES-L counter 15 minutes	Y	Y	Y	Y	Y	Y
SES-L counter 15 minutes	Y	Y	Y	Y	Y	Y
LOSS-L counter 15 minutes	Y	Y	Y	Y	Y	Y
UAS-L counter 15 minutes	Y	Y	Y	Y	Y	Y
<i>Near-end performance monitoring counters (current and previous 24-hour interval)</i>						
FECS-L counter 24 hours	Y	Y	Y	Y	Y	Y
ES-L counter 24 hours	Y	Y	Y	Y	Y	Y
SES-L counter 24 hours	Y	Y	Y	Y	Y	Y
LOSS-L counter 24 hours	Y	Y	Y	Y	Y	Y
UAS-L counter 24 hours	Y	Y	Y	Y	Y	Y
<i>Far-end performance monitoring counters (current and previous 15-minute interval)</i>						
FECS-LFE counter 15 minutes	Y	Y	Y	Y	Y	Y
ES-LFE counter 15 minutes	Y	Y	Y	Y	Y	Y
SES-LFE counter 15 minutes	Y	Y	Y	Y	Y	Y
LOSS-LFE counter 15 minutes	Y	Y	Y	Y	Y	Y
UAS-LFE counter 15 minutes	Y	Y	Y	Y	Y	Y
<i>Far-end performance monitoring counters (current and previous 24-hour interval)</i>						
FECS-LFE counter 24 hours	Y	Y	Y	Y	Y	Y
ES-LFE counter 24 hours	Y	Y	Y	Y	Y	Y
SES-LFE counter 24 hours	Y	Y	Y	Y	Y	Y
LOSS-LFE counter 24 hours	Y	Y	Y	Y	Y	Y

Table 7-23 – Support of line performance monitoring parameters per Recommendation

Category/Element	G.992.1	G.992.2	G.992.3	G.992.4	G.992.5	G.993.2
UAS-LFE counter 24 hours	Y	Y	Y	Y	Y	Y
<i>Initialization performance monitoring counters (current and previous 15-minute interval)</i>						
Full inits counter 15 minutes	Y	Y	Y	Y	Y	Y
Failed full inits counter 15 minutes	Y	Y	Y	Y	Y	Y
Short inits counter 15 minutes		Y	Y	Y	Y	Y
Failed short inits counter 15 minutes		Y	Y	Y	Y	Y
<i>Initialization performance monitoring counters (current and previous 24-hour interval)</i>						
Full inits counter 24 hours	Y	Y	Y	Y	Y	Y
Failed full inits counter 24 hours	Y	Y	Y	Y	Y	Y
Short inits counter 24 hours		Y	Y	Y	Y	Y
Failed short inits counter 24 hours		Y	Y	Y	Y	Y
<i>Near-end impulse noise performance monitoring counters (current and previous 15-minute interval)</i>						
INMINPEQ _{1..17} -L counter 15 minutes						Y
INMIAT _{0..7} -L counter 15 minutes						Y
INMME-L counter 15 minutes						Y
<i>Near-end impulse noise performance monitoring counters (current and previous 24-hour interval)</i>						
INMINPEQ _{1..17} -L counter 24 hours						Y
INMIAT _{0..7} -L counter 24 hours						Y
INMME-L counter 24 hours						Y
<i>Far-end impulse noise performance monitoring counters (current and previous 15-minute interval)</i>						
INMINPEQ _{1..17} -LFE counter 15 minutes			Y		Y	Y
INMIAT _{0..7} -LFE counter 15 minutes			Y		Y	Y
INMME-LFE counter 15 minutes			Y		Y	Y

Table 7-23 – Support of line performance monitoring parameters per Recommendation

Category/Element	G.992.1	G.992.2	G.992.3	G.992.4	G.992.5	G.993.2
<i>Far-end impulse noise performance monitoring counters (current and previous 24-hour interval)</i>						
INMINPEQ _{1..17} -LFE counter 24 hours			Y		Y	Y
INMIAT _{0..7} -LFE counter 24 hours			Y		Y	Y
INMME-LFE counter 24 hours			Y		Y	Y
<i>Near-end (xTU-C) SOS performance monitoring counters (current and previous 15-minute interval)</i>						
SOS-SUCCESS-NE counter 15 minutes						Y
<i>Near-end (xTU-C) SOS performance monitoring counters (current and previous 24-hour interval)</i>						
SOS-SUCCESS-NE counter 24 hours						Y
<i>Far-end (xTU-R) SOS performance monitoring counters (current and previous 15-minute interval)</i>						
SOS-SUCCESS-FE counter 15 minutes						Y
<i>Far-end (xTU-R) SOS performance monitoring counters (current and previous 24-hour interval)</i>						
SOS-SUCCESS-FE counter 24 hours						Y

Table 7-24 – Channel performance monitoring parameters

Category/Element	Defined in:	Q-Interface	U-C Interface	U-R Interface	T-/S-Interface
<i>Near-end (xTU-C) performance monitoring counters (current and previous 15-minute interval)</i>					
CV-C counter 15 minutes	7.2.2.1.1	R (M)	R (O)		
FEC-C counter 15 minutes	7.2.2.1.2	R (M)	R (O)		
<i>Near-end (xTU-C) performance monitoring counters (current and previous 24-hour interval)</i>					
CV-C counter 24 hours	7.2.2.1.1	R (M)	R (O)		
FEC-C counter 24 hours	7.2.2.1.2	R (M)	R (O)		
<i>Far-end (xTU-R) performance monitoring counters (current and previous 15-minute interval)</i>					
CV-CFE counter 15 minutes	7.2.2.2.1	R (M)		R (O)	
FEC-CFE counter 15 minutes	7.2.2.2.2	R (M)		R (O)	
<i>Far-end (xTU-R) performance monitoring counters (current and previous 24-hour interval)</i>					
CV-CFE counter 24 hours	7.2.2.2.1	R (M)		R (O)	
FEC-CFE counter 24 hours	7.2.2.2.2	R (M)		R (O)	

Table 7-25 – Support of channel performance monitoring parameters per Recommendation

Category/Element	G.992.1	G.992.2	G.992.3	G.992.4	G.992.5	G.993.2
<i>Near-end performance monitoring counters (current and previous 15-minute interval)</i>						
CV-C counter 15 minutes	Y	Y	Y	Y	Y	Y
FEC-C counter 15 minutes	Y	Y	Y	Y	Y	Y
<i>Near-end performance monitoring counters (current and previous 24-hour interval)</i>						
CV-C counter 24 hours	Y	Y	Y	Y	Y	Y
FEC-C counter 24 hours	Y	Y	Y	Y	Y	Y
<i>Far-end performance monitoring counters (current and previous 15-minute interval)</i>						
CV-CFE counter 15 minutes	Y	Y	Y	Y	Y	Y
FEC-CFE counter 15 minutes	Y	Y	Y	Y	Y	Y
<i>Far-end performance monitoring counters (current and previous 24-hour interval)</i>						
CV-CFE counter 24 hours	Y	Y	Y	Y	Y	Y
FEC-CFE counter 24 hours	Y	Y	Y	Y	Y	Y

Table 7-26 – ATM data path performance monitoring parameters

Category/Element	Defined in:	Q-Interface	U-C Interface	U-R Interface	T-/S-Interface
<i>Near-end (xTU-C) performance monitoring counters (current and previous 15-minute interval)</i>					
HEC-P counter 15 minutes	7.2.4.1.1	R (M)	R (O)		
CD-P counter 15 minutes	7.2.4.1.2	R (M)	R (O)		
CU-P counter 15 minutes	7.2.4.1.3	R (M)	R (O)		
IBE-P counter 15 minutes	7.2.4.1.4	R (M)	R (O)		R (O)
<i>Near-end (xTU-C) performance monitoring counters (current and previous 24-hour interval)</i>					
HEC-P counter 24 hours	7.2.4.1.1	R (M)	R (O)		
CD-P counter 24 hours	7.2.4.1.2	R (M)	R (O)		
CU-P counter 24 hours	7.2.4.1.3	R (M)	R (O)		
IBE-P counter 24 hours	7.2.4.1.4	R (M)	R (O)		R (O)
<i>Far-end (xTU-R) performance monitoring counters (current and previous 15-minute interval)</i>					
HEC-PFE counter 15 minutes	7.2.4.2.1	R (M)		R (O)	
CD-PFE counter 15 minutes	7.2.4.2.2	R (M)		R (O)	
CU-PFE counter 15 minutes	7.2.4.2.3	R (M)		R (O)	
IBE-PFE counter 15 minutes	7.2.4.2.4	R (M)		R (O)	R (O)
<i>Far-end (xTU-R) performance monitoring counters (current and previous 24-hour interval)</i>					
HEC-PFE counter 24 hours	7.2.4.2.1	R (M)		R (O)	
CD-PFE counter 24 hours	7.2.4.2.2	R (M)		R (O)	
CU-PFE counter 24 hours	7.2.4.2.3	R (M)		R (O)	
IBE-PFE counter 24 hours	7.2.4.2.4	R (M)		R (O)	R (O)

Table 7-27 – Support of ATM data path performance monitoring parameters per Recommendation

Category/Element	G.992.1	G.992.2	G.992.3	G.992.4	G.992.5	G.993.2
<i>Near-end performance monitoring counters (current and previous 15-minute interval)</i>						
HEC-P counter 15 minutes	Y	Y	Y	Y	Y	Y
CD-P counter 15 minutes	Y	Y	Y	Y	Y	Y
CU-P counter 15 minutes	Y	Y	Y	Y	Y	Y
IBE-P counter 15 minutes	Y	Y	Y	Y	Y	Y
<i>Near-end performance monitoring counters (current and previous 24-hour interval)</i>						
HEC-P counter 24 hours	Y	Y	Y	Y	Y	Y
CD-P counter 24 hours	Y	Y	Y	Y	Y	Y
CU-P counter 24 hours	Y	Y	Y	Y	Y	Y
IBE-P counter 24 hours	Y	Y	Y	Y	Y	Y
<i>Far-end performance monitoring counters (current and previous 15-minute interval)</i>						
HEC-PFE counter 15 minutes	Y	Y	Y	Y	Y	Y
CD-PFE counter 15 minutes	Y	Y	Y	Y	Y	Y
CU-PFE counter 15 minutes	Y	Y	Y	Y	Y	Y
IBE-PFE counter 15 minutes	Y	Y	Y	Y	Y	Y
<i>Far-end performance monitoring counters (current and previous 24-hour interval)</i>						
HEC-PFE counter 24 hours	Y	Y	Y	Y	Y	Y
CD-PFE counter 24 hours	Y	Y	Y	Y	Y	Y
CU-PFE counter 24 hours	Y	Y	Y	Y	Y	Y
IBE-PFE counter 24 hours	Y	Y	Y	Y	Y	Y

Table 7-28 – Line test, diagnostic and status parameters

Category/Element	Defined in:	Q-Interface	U-C Interface	U-R Interface	T-/S-Interface	G-Interface
xDSL transmission system	7.5.1.1	R (M)			R (O)	R (O)
VDSL2 profile	7.5.1.2	R (M)			R (O)	R (O)
VDSL2 limit PSD mask and band plan	7.5.1.3	R (M)			R (O)	R (O)
VDSL2 US0 PSD mask	7.5.1.4	R (M)			R (O)	R (O)
Power management state	7.5.1.5	R (M)			R (O)	R (O)

Table 7-28 – Line test, diagnostic and status parameters

Category/Element	Defined in:	Q-Interface	U-C Interface	U-R Interface	T-/S-Interface	G-Interface
<i>Initialization</i>						
Success/Failure cause	7.5.1.6	R (M)			R (M)	R (M)
Last state transmitted downstream	7.5.1.7	R (M)			R (M)	R (M)
Last state transmitted upstream	7.5.1.8	R (M)			R (M)	R (M)
<i>Attenuation</i>						
LATNds	7.5.1.9	R (M)		R (O)	R (M)	R (M)
LATNus	7.5.1.10	R (M)	R (O)		R (M)	R (M)
SATNds	7.5.1.11	R (M)		R (O)	R (M)	R (M)
SATNus	7.5.1.12	R (M)	R (O)		R (M)	R (M)
<i>Signal-to-noise ratio margin</i>						
SNRMds	7.5.1.13	R (M)		R (O)	R (M)	R (M)
FEXT SNRMds	7.5.1.13.1	R (M)		R (O)	R (M)	R (M)
NEXT SNRMds	7.5.1.13.2	R (M)		R (O)	R (M)	R (M)
SNRMpbds	7.5.1.14	R (M)		R (O)	R (M)	R (M)
ACTSNRMODEds	7.5.1.15	R (M)		R (O)	R (M)	R (M)
SNRMus	7.5.1.16	R (M)	R (O)		R (M)	R (M)
FEXT SNRMus	7.5.1.16.1	R (M)	R (O)		R (M)	R (M)
NEXT SNRMus	7.5.1.16.2	R (M)	R (O)		R (M)	R (M)
SNRMpbus	7.5.1.17	R (M)	R (O)		R (M)	R (M)
ACTSNRMODEus	7.5.1.18	R (M)	R (O)		R (M)	R (M)
<i>Attainable data rate</i>						
ATTNDRds	7.5.1.19	R (M)	R (O)		R (M)	R (M)
FEXT ATTNDRds	7.5.1.19.1	R (M)	R (O)		R (M)	R (M)
NEXT ATTNDRds	7.5.1.19.2	R (M)	R (O)		R (M)	R (M)
ATTNDRus	7.5.1.20	R (M)		R (O)	R (M)	R (M)
FEXT ATTNDRus	7.5.1.20.1	R (M)		R (O)	R (M)	R (M)
NEXT ATTNDRus	7.5.1.20.2	R (M)		R (O)	R (M)	R (M)
<i>Actual power spectral density</i>						
ACTPSDds	7.5.1.21	R (M)	R (O)			R (O)
FEXT ACTPSDds	7.5.1.21.1	R (M)	R (O)			R (O)
NEXT ACTPSDds	7.5.1.21.2	R (M)	R (O)			R (O)
ACTPSDus	7.5.1.22	R (M)		R (O)		R (O)
FEXT ACTPSDus	7.5.1.22.1	R (M)		R (O)		R (O)
NEXT ACTPSDus	7.5.1.22.2	R (M)		R (O)		R (O)

Table 7-28 – Line test, diagnostic and status parameters

Category/Element	Defined in:	Q-Interface	U-C Interface	U-R Interface	T-/S-Interface	G-Interface
<i>Upstream power back-off</i>						
UPBOKLE	7.5.1.23.1	R (M)	R (O)			R (O)
UPBOKLE-R	7.5.1.23.2	R (O)	R (O)			R (O)
<i>Actual aggregate transmit power</i>						
ACTATPds	7.5.1.24	R (M)		R (O)	R (M)	R (M)
FEXT ACTATPds	7.5.1.24.1	R (M)		R (O)	R (M)	R (M)
NEXT ACTATPds	7.5.1.24.2	R (M)		R (O)	R (M)	R (M)
ACTATPus	7.5.1.25	R (M)	R (O)		R (M)	R (M)
FEXT ACTATPus	7.5.1.25.1	R (M)	R (O)		R (M)	R (M)
NEXT ACTATPus	7.5.1.25.2	R (M)	R (O)		R (M)	R (M)
<i>Channel characteristics per subcarrier</i>						
HLINSCds	7.5.1.26.1	R (M)	R (O)		R (M)	R (M)
HLINGds	7.5.1.26.2	R (M)	R (O)		R (M)	R (M)
HLINpsds	7.5.1.26.3	R (M)	R (O)		R (M)	R (M)
HLOGMTds	7.5.1.26.4	R (M)	R (O)		R (M)	R (M)
HLOGGds	7.5.1.26.5	R (M)	R (O)		R (M)	R (M)
HLOGpsds	7.5.1.26.6	R (M)	R (O)		R (M)	R (M)
HLINSCus	7.5.1.26.7	R (M)		R (O)	R (M)	R (M)
HLINGus	7.5.1.26.8	R (M)		R (O)	R (M)	R (M)
HLINpsus	7.5.1.26.9	R (M)		R (O)	R (M)	R (M)
HLOGMTus	7.5.1.26.10	R (M)		R (O)	R (M)	R (M)
HLOGGus	7.5.1.26.11	R (M)		R (O)	R (M)	R (M)
HLOGpsus	7.5.1.26.12	R (M)		R (O)	R (M)	R (M)
<i>Quiet line noise PSD per subcarrier</i>						
QLNMTds	7.5.1.27.1	R (M)	R (O)		R (M)	R (M)
FEXT QLNMTds	7.5.1.27.1.1	R (M)	R (O)		R (M)	R (M)
NEXT QLNMTds	7.5.1.27.1.2	R (M)	R (O)		R (M)	R (M)
QLNGds	7.5.1.27.2	R (M)	R (O)		R (M)	R (M)
QLNpsds	7.5.1.27.3	R (M)	R (O)		R (M)	R (M)
FEXT QLNpsds	7.5.1.27.3.1	R (M)	R (O)		R (M)	R (M)
NEXT QLNpsds	7.5.1.27.3.2	R (M)	R (O)		R (M)	R (M)
QLNMTus	7.5.1.27.4	R (M)		R (O)	R (M)	R (M)
FEXT QLNMTus	7.5.1.27.4.1	R (M)		R (O)	R (M)	R (M)
NEXT QLNMTus	7.5.1.27.4.2	R (M)		R (O)	R (M)	R (M)
QLNGus	7.5.1.27.5	R (M)		R (O)	R (M)	R (M)

Table 7-28 – Line test, diagnostic and status parameters

Category/Element	Defined in:	Q-Interface	U-C Interface	U-R Interface	T-/S-Interface	G-Interface
QLNpsus	7.5.1.27.6	R (M)		R (O)	R (M)	R (M)
FEXT QLNpsus	7.5.1.27.6.1	R (M)		R (O)	R (M)	R (M)
NEXT QLNpsus	7.5.1.27.6.2	R (M)		R (O)	R (M)	R (M)
<i>Signal-to-noise ratio per subcarrier</i>						
SNRMTds	7.5.1.28.1	R (M)	R (O)		R (M)	R (M)
FEXT SNRMTds	7.5.1.28.1.1	R (M)	R (O)		R (M)	R (M)
NEXT SNRMTds	7.5.1.28.1.2	R (M)	R (O)		R (M)	R (M)
SNRGds	7.5.1.28.2	R (M)	R (O)		R (M)	R (M)
SNRpsds	7.5.1.28.3	R (M)	R (O)		R (M)	R (M)
FEXT SNRpsds	7.5.1.28.3.1	R (M)	R (O)		R (M)	R (M)
NEXT SNRpsds	7.5.1.28.3.2	R (M)	R (O)		R (M)	R (M)
SNRMTus	7.5.1.28.4	R (M)		R (O)	R (M)	R (M)
FEXT SNRMTus	7.5.1.28.4.1	R (M)		R (O)	R (M)	R (M)
NEXT SNRMTus	7.5.1.28.4.2	R (M)		R (O)	R (M)	R (M)
SNRGus	7.5.1.28.5	R (M)		R (O)	R (M)	R (M)
SNRpsus	7.5.1.28.6	R (M)		R (O)	R (M)	R (M)
FEXT SNRpsus	7.5.1.28.6.1	R (M)		R (O)	R (M)	R (M)
NEXT SNRpsus	7.5.1.28.6.2	R (M)		R (O)	R (M)	R (M)
<i>Bit allocation per subcarrier</i>						
BITSpds	7.5.1.29.1	R (M)	R (O)			R (O)
FEXT BITSpds	7.5.1.29.1.1	R (M)	R (O)			R (O)
NEXT BITSpds	7.5.1.29.1.2	R (M)	R (O)			R (O)
BITSpus	7.5.1.29.2	R (M)		R (O)		R (O)
FEXT BITSpus	7.5.1.29.2.1	R (M)		R (O)		R (O)
NEXT BITSpus	7.5.1.29.2.2	R (M)		R (O)		R (O)
<i>Gain scaling per subcarrier</i>						
GAINSpds	7.5.1.29.3	R (M)	R (O)			
FEXT GAINSpds	7.5.1.29.3.1	R (M)	R (O)			
NEXT GAINSpds	7.5.1.29.3.2	R (M)	R (O)			
GAINSpus	7.5.1.29.4	R (M)		R (O)		
FEXT GAINSpus	7.5.1.29.4.1	R (M)		R (O)		
NEXT GAINSpus	7.5.1.29.4.2	R (M)		R (O)		
TSSpds	7.5.1.29.5	R (M)	R (O)			
FEXT TSSpds	7.5.1.29.5.1	R (M)	R (O)			
NEXT TSSpds	7.5.1.29.5.2	R (M)	R (O)			
TSSpsus	7.5.1.29.6	R (M)	R (O)			
FEXT TSSpsus	7.5.1.29.6.1	R (M)	R (O)			

Table 7-28 – Line test, diagnostic and status parameters

Category/Element	Defined in:	Q-Interface	U-C Interface	U-R Interface	T-/S-Interface	G-Interface
NEXT TSSpsus	7.5.1.29.6.2	R (M)	R (O)			
MREFPSDds	7.5.1.29.7	R (M)	R (O)			R (O)
MREFPSDus	7.5.1.29.8	R (M)	R (O)			R (O)
<i>Trellis use</i>						
TRELLISds	7.5.1.30	R (M/O) (Note)		R (O)	R (M/O) (Note)	R (M/O) (Note)
TRELLISus	7.5.1.31	R (M/O) (Note)	R (O)		R (M/O) (Note)	R (M/O) (Note)
<i>Cyclic extension</i>						
ACTUALCE	7.5.1.32	R (M)				R (M)
<i>Actual rate adaptation mode</i>						
ACT-RA-MODEds	7.5.1.33.1	R (O)				R (O)
ACT-RA-MODEus	7.5.1.33.2	R (O)				R (O)
<i>Actual impulse noise protection of ROC</i>						
ACTINP-ROC-ds	7.5.1.34.1	R (O)				R (O)
ACTINP-ROC-us	7.5.1.34.2	R (O)				R (O)
<i>Actual SNR margin of ROC</i>						
SNRM-ROC-ds	7.5.1.35.1	R (O)				R (O)
SNRM-ROC-us	7.5.1.35.2	R (O)				R (O)
<i>Update request flags and time stamps of test parameter</i>						
UPDATE-TEST-NE	7.5.1.36.1	R/W (O)				
UPDATE-TEST-FE	7.5.1.36.2	R/W (O)				
STAMP-TEST-NE	7.5.1.36.3	R (O)				
STAMP-TEST-FE	7.5.1.36.4	R (O)				
<i>OLR time stamps</i>						
STAMP-OLR-ds	7.5.1.37.1	R (O)				
STAMP-OLR-us	7.5.1.37.2	R (O)				
NOTE – These parameters are R (M) on the Q-interface for [ITU-T G.993.2] and R (O) for all other ITU-T Recommendations which support them.						

Table 7-29 – Support of line test, diagnostic and status parameters per Recommendation

Category/Element	G.992.1	G.992.2	G.992.3	G.992.4	G.992.5	G.993.2
xDSL transmission system	Y	Y	Y	Y	Y	Y
VDSL2 profile						Y
VDSL2 limit PSD mask and band plan						Y
VDSL2 US0 PSD mask						Y (Annex A)
Power management state	Y	Y	Y	Y	Y	Y
Initialization						
Success/Failure cause	Y	Y	Y	Y	Y	Y
Last state transmitted downstream			Y	Y	Y	Y
Last state transmitted upstream			Y	Y	Y	Y
Attenuation						
LATNds	Y	Y	Y	Y	Y	Y
LATNus	Y	Y	Y	Y	Y	Y
SATNds			Y	Y	Y	Y
SATNus			Y	Y	Y	Y
Signal-to-noise ratio margin						
SNRMds	Y	Y	Y	Y	Y	Y
FEXT SNRMds			Y		Y	
NEXT SNRMds			Y		Y	
SNRMpbds						Y
ACTSNRMODEds			Y		Y	Y
SNRMus	Y	Y	Y	Y	Y	Y
FEXT SNRMus			Y		Y	
NEXT SNRMus			Y		Y	
SNRMpbus						Y
ACTSNRMODEus						Y
Attainable data rate						
ATTNDRds	Y	Y	Y	Y	Y	Y
FEXT ATTNDRds			Y		Y	
NEXT ATTNDRds			Y		Y	
ATTNDRus	Y	Y	Y	Y	Y	Y
FEXT ATTNDRus			Y		Y	
NEXT ATTNDRus			Y		Y	

Table 7-29 – Support of line test, diagnostic and status parameters per Recommendation

Category/Element	G.992.1	G.992.2	G.992.3	G.992.4	G.992.5	G.993.2
<i>Actual power spectral density</i>						
ACTPSDds			Y	Y	Y	
FEXT ACTPSDds			Y		Y	
NEXT ACTPSDds			Y		Y	
ACTPSDus			Y	Y	Y	
FEXT ACTPSDus			Y		Y	
NEXT ACTPSDus			Y		Y	
<i>Upstream power back-off</i>						
UPBOKLE						Y
UPBOKLE-R						Y
<i>Actual aggregate transmit power</i>						
ACTATPds	Y	Y	Y	Y	Y	Y
FEXT ACTATPds			Y		Y	
NEXT ACTATPds			Y		Y	
ACTATPus	Y	Y	Y	Y	Y	Y
FEXT ACTATPus			Y		Y	
NEXT ACTATPus			Y		Y	
<i>Channel characteristics per subcarrier</i>						
HLINSCds			Y	Y	Y	Y
HLINGds						Y
HLINpsds			Y	Y	Y	Y
HLOGMTds			Y	Y	Y	Y
HLOGGds						Y
HLOGpsds			Y	Y	Y	Y
HLINSCus			Y	Y	Y	Y
HLINGus						Y
HLINpsus			Y	Y	Y	Y
HLOGMTus			Y	Y	Y	Y
HLOGGus						Y
HLOGpsus			Y	Y	Y	Y
<i>Quiet line noise PSD per subcarrier</i>						
QLNMTds			Y	Y	Y	Y
FEXT QLNMTds			Y		Y	
NEXT QLNMTds			Y		Y	
QLNGds						Y
QLNpsds			Y	Y	Y	Y
FEXT QLNpsds			Y		Y	
NEXT QLNpsds			Y		Y	

Table 7-29 – Support of line test, diagnostic and status parameters per Recommendation

Category/Element	G.992.1	G.992.2	G.992.3	G.992.4	G.992.5	G.993.2
QLNMTus			Y	Y	Y	Y
FEXT QLNMTus			Y		Y	
NEXT QLNMTus			Y		Y	
QLNGus						Y
QLNpsus			Y	Y	Y	Y
FEXT QLNpsus			Y		Y	
NEXT QLNpsus			Y		Y	
Signal-to-noise ratio per subcarrier						
SNRMTds			Y	Y	Y	Y
FEXT SNRMTds			Y		Y	
NEXT SNRMTds			Y		Y	
SNRGds						Y
SNRpsds			Y	Y	Y	Y
FEXT SNRpsds			Y		Y	
NEXT SNRpsds			Y		Y	
SNRMTus			Y	Y	Y	Y
FEXT SNRMTus			Y		Y	
NEXT SNRMTus			Y		Y	
SNRGus						Y
SNRpsus			Y	Y	Y	Y
FEXT SNRpsus			Y		Y	
NEXT SNRpsus			Y		Y	
Bit allocation per subcarrier						
BITSpds			Y	Y	Y	Y
FEXT BITSpds			Y		Y	
NEXT BITSpds			Y		Y	
BITSpus			Y	Y	Y	Y
FEXT BITSpus			Y		Y	
NEXT BITSpus			Y		Y	
Gain scaling per subcarrier						
GAINSpds			Y	Y	Y	Y
FEXT GAINSpds			Y		Y	
NEXT GAINSpds			Y		Y	
GAINSpus			Y	Y	Y	Y
FEXT GAINSpus			Y		Y	
NEXT GAINSpus			Y		Y	
TSSpds			Y	Y	Y	
FEXT TSSpds			Y		Y	

Table 7-29 – Support of line test, diagnostic and status parameters per Recommendation

Category/Element	G.992.1	G.992.2	G.992.3	G.992.4	G.992.5	G.993.2
NEXT TSSpsds			Y		Y	
TSSpsus			Y	Y	Y	
FEXT TSSpsus			Y		Y	
NEXT TSSpsus			Y		Y	
MREFPSDDs						Y
MREFPSDus						Y
<i>Trellis use</i>						
TRELLISds	Y		Y	Y	Y	Y
TRELLISus	Y		Y	Y	Y	Y
<i>Cyclic extension</i>						
ACTUALCE						Y
<i>Actual rate adaptation mode</i>						
ACT-RA-MODEds						Y
ACT-RA-MODEus						Y
<i>Actual impulse noise protection of ROC</i>						
ACTINP-ROC-ds						Y
ACTINP-ROC-us						Y
<i>Actual SNR margin of ROC</i>						
SNRM-ROC-ds						Y
SNRM-ROC-us						Y
<i>Update request flags and time stamps of test parameter</i>						
UPDATE-TEST-NE						Y
UPDATE-TEST-FE						Y
STAMP-TEST-NE						Y
STAMP-TEST-FE						Y
<i>OLR time stamps</i>						
STAMP-OLR-ds						Y
STAMP-OLR-us						Y

Table 7-30 – Channel test, diagnostic and status parameters

Category/Element	Defined in:	Q-Interface	U-C Interface	U-R Interface	T-/S-Interface	G-Interface
Actual data rate	7.5.2.1	R (M)			R (O)	R (O)
Previous data rate	7.5.2.2	R (M)			R (O)	R (O)
Actual interleaving delay	7.5.2.3	R (M)		R (O)	R (O)	R (O)
ACTINP	7.5.2.4	R (M/O) (Note 2)		R (O)	R (O)	R (O)
INPREPORT	7.5.2.5	R (M)		R (O)	R (O)	R (O)
<i>Actual framer setting</i>						
NFEC	7.5.2.6.1	R (M/O) (Note 1)		R (O)		R (O)
RFEC	7.5.2.6.2	R (M/O) (Note 1)		R (O)		R (O)
LSYMB	7.5.2.6.3	R (M/O) (Note 1)		R (O)		R (O)
INTLVDEPTH	7.5.2.6.4	R (M/O) (Note 1)		R (O)		R (O)
INTLVBLOCK	7.5.2.6.5	R (M)		R (O)		R (O)
<i>Actual latency path</i>						
LPATH	7.5.2.7	R (M/O) (Note 1)		R (O)		R (O)
NOTE 1 – These parameters are R (M) on the Q-interface for [ITU-T G.993.2] and R (O) for all other ITU-T Recommendations, which support them.						
NOTE 2 – This parameter is R (O) on the Q-interface for [ITU-T G.992.1] and R (M) for all other ITU-T Recommendations that support it.						

Table 7-31 – Support of channel test, diagnostic and status parameters per Recommendation

Category/Element	G.992.1	G.992.2	G.992.3	G.992.4	G.992.5	G.993.2
Actual data rate	Y	Y	Y	Y	Y	Y
Previous data rate	Y	Y	Y	Y	Y	Y
Actual interleaving delay	Y	Y	Y	Y	Y	Y
ACTINP	Y		Y	Y	Y	Y
INPREPORT						Y
<i>Actual framer setting</i>						
NFEC	Y	Y	Y	Y	Y	Y
RFEC	Y	Y	Y	Y	Y	Y
LSYMB	Y	Y	Y	Y	Y	Y
INTLVDEPTH	Y	Y	Y	Y	Y	Y
INTLVBLOCK						Y
<i>Actual latency path</i>						
LPATH	Y	Y	Y	Y	Y	Y

Table 7-32 – PTM data path failures

Category/Element	Defined in:	Q-Interface	U-C Interface	U-R Interface	T-/S-Interface
<i>Near-end (xTU-C) failures</i>					
Out of sync (OOS) failure	7.1.5.1.1	R (M)	R (O)		
<i>Far-end (xTU-R) failures</i>					
Far-end out of sync (OOS-FE) failure	7.1.5.2.1	R (M)		R (O)	

Table 7-33 – Support of PTM data path failures per Recommendation

Category/Element	G.992.1	G.992.2	G.992.3	G.992.4	G.992.5	G.993.2
<i>Near-end failures</i>						
Out of sync (OOS) failure			Y		Y	Y
<i>Far-end failures</i>						
Far-end out of sync (OOS-FE) failure			Y		Y	Y

Table 7-34 – PTM data path performance monitoring parameters

Category/Element	Defined in:	Q-Interface	U-C Interface	U-R Interface	T-/S-Interface
<i>Near-end (xTU-C) performance monitoring counters (current and previous 15-minute interval)</i>					
CRC-P counter 15 minutes	7.2.5.1.1	R (M)	R (O)		
CRCP-P counter 15 minutes	7.2.5.1.1	R (M)	R (O)		
CV-P counter 15 minutes	7.2.5.1.2	R (M)	R (O)		
CVP-P counter 15 minutes	7.2.5.1.2	R (M)	R (O)		
<i>Near-end (xTU-C) performance monitoring counters (current and previous 24-hour interval)</i>					
CRC-P counter 24 hours	7.2.5.1.1	R (M)	R (O)		
CRCP-P counter 24 hours	7.2.5.1.1	R (M)	R (O)		
CV-P counter 24 hours	7.2.5.1.2	R (M)	R (O)		
CVP-P counter 24 hours	7.2.5.1.2	R (M)	R (O)		
<i>Far-end (xTU-R) performance monitoring counters (current and previous 15-minute interval)</i>					
CRC-PFE counter 15 minutes	7.2.5.2.1	R (M)		R (O)	
CRCP-PFE counter 15 minutes	7.2.5.2.1	R (M)		R (O)	
CV-PFE counter 15 minutes	7.2.5.2.2	R (M)		R (O)	
CVP-PFE counter 15 minutes	7.2.5.2.2	R (M)		R (O)	
<i>Far-end (xTU-R) performance monitoring counters (current and previous 24-hour interval)</i>					
CRC-PFE counter 24 hours	7.2.5.2.1	R (M)		R (O)	
CRCP-PFE counter 24 hours	7.2.5.2.1	R (M)		R (O)	
CV-PFE counter 24 hours	7.2.5.2.2	R (M)		R (O)	
CVP-PFE counter 24 hours	7.2.5.2.2	R (M)		R (O)	

Table 7-35 – Support of PTM data path performance monitoring parameters per Recommendation

Category/Element	G.992.1	G.992.2	G.992.3	G.992.4	G.992.5	G.993.2
<i>Near-end performance monitoring counters (current and previous 15-minute interval)</i>						
CRC-P counter 15 minutes			Y		Y	Y
CRCP-P counter 15 minutes			Y		Y	Y
CV-P counter 15 minutes			Y		Y	Y
CVP-P counter 15 minutes			Y		Y	Y
<i>Near-end performance monitoring counters (current and previous 24-hour interval)</i>						
CRC-P counter 24 hours			Y		Y	Y
CRCP-P counter 24 hours			Y		Y	Y
CV-P counter 24 hours			Y		Y	Y
CVP-P counter 24 hours			Y		Y	Y
<i>Far-end performance monitoring counters (current and previous 15-minute interval)</i>						
CRC-PFE counter 15 minutes			Y		Y	Y
CRCP-PFE counter 15 minutes			Y		Y	Y
CV-PFE counter 15 minutes			Y		Y	Y
CVP-PFE counter 15 minutes			Y		Y	Y
<i>Far-end performance monitoring counters (current and previous 24-hour interval)</i>						
CRC-PFE counter 24 hours			Y		Y	Y
CRCP-PFE counter 24 hours			Y		Y	Y
CV-PFE counter 24 hours			Y		Y	Y
CVP-PFE counter 24 hours			Y		Y	Y

Table 7-36 – PTM data path configuration profile

Category/Element	Defined in:	Q-Interface	U-C Interface	U-R Interface	T-/S-Interface
<i>Near-end (xTU-C) performance monitoring thresholds (15-minute interval)</i>					
CRC-P threshold 15 minutes	7.3.5.1	R/W (O)	R (O)		
CRCP-P threshold 15 minutes	7.3.5.1	R/W (O)	R (O)		
CV-P threshold 15 minutes	7.3.5.1	R/W (O)	R (O)		
CVP-P threshold 15 minutes	7.3.5.1	R/W (O)	R (O)		
<i>Near-end (xTU-C) performance monitoring thresholds (24-hour interval)</i>					
CRC-P threshold 24 hours	7.3.5.1	R/W (O)	R (O)		
CRCP-P threshold 24 hours	7.3.5.1	R/W (O)	R (O)		
CV-P threshold 24 hours	7.3.5.1	R/W (O)	R (O)		
CVP-P threshold 24 hours	7.3.5.1	R/W (O)	R (O)		
<i>Far-end (xTU-R) performance monitoring thresholds (15-minute interval)</i>					
CRC-PFE threshold 15 minutes	7.3.5.1	R/W (O)	R (O)		
CRCP-PFE threshold 15 minutes	7.3.5.1	R/W (O)	R (O)		
CV-PFE threshold 15 minutes	7.3.5.1	R/W (O)	R (O)		
CVP-PFE threshold 15 minutes	7.3.5.1	R/W (O)	R (O)		
<i>Far-end (xTU-R) performance monitoring thresholds (24-hour interval)</i>					
CRC-PFE threshold 24 hours	7.3.5.1	R/W (O)	R (O)		
CRCP-PFE threshold 24 hours	7.3.5.1	R/W (O)	R (O)		
CV-PFE threshold 24 hours	7.3.5.1	R/W (O)	R (O)		
CVP-PFE threshold 24 hours	7.3.5.1	R/W (O)	R (O)		

Table 7-37 – Support PTM data path configuration parameters per Recommendation

Category/Element	G.992.1	G.992.2	G.992.3	G.992.4	G.992.5	G.993.2
<i>Near-end performance monitoring thresholds (15-minute interval)</i>						
CRC-P threshold 15 minutes			Y		Y	Y
CRCP-P threshold 15 minutes			Y		Y	Y
CV-P threshold 15 minutes			Y		Y	Y
CVP-P threshold 15 minutes			Y		Y	Y
<i>Near-end performance monitoring thresholds (24-hour interval)</i>						
CRC-P threshold 24 hours			Y		Y	Y
CRCP-P threshold 24 hours			Y		Y	Y
CV-P threshold 24 hours			Y		Y	Y

Table 7-37 – Support PTM data path configuration parameters per Recommendation

Category/Element	G.992.1	G.992.2	G.992.3	G.992.4	G.992.5	G.993.2
CVP-P threshold 24 hours			Y		Y	Y
<i>Far-end performance monitoring thresholds (15-minute interval)</i>						
CRC-PFE threshold 15 minutes			Y		Y	Y
CRCP-PFE threshold 15 minutes			Y		Y	Y
CV-PFE threshold 15 minutes			Y		Y	Y
CVP-PFE threshold 15 minutes			Y		Y	Y
<i>Far-end performance monitoring thresholds (24-hour interval)</i>						
CRC-PFE threshold 24 hours			Y		Y	Y
CRCP-PFE threshold 24 hours			Y		Y	Y
CV-PFE threshold 24 hours			Y		Y	Y
CVP-PFE threshold 24 hours			Y		Y	Y

Appendix I

Processing examples

(This appendix does not form an integral part of this Recommendation)

I.1 Illustration of transmitter processing

```
#define      INIT      0xFFFF
#define      FLAG      0x7E
#define      ESC       0x7D
#define      INV       0x20
#define      GENPOL    0x8408
unsigned char      msg[1024], temp; /* 8 bit unsigned char */
unsigned short int      crc; /* 16 bit unsigned integer */
int      N, j, msglen;
{
    crc = INIT;
    msg[0] = 0xFF;
    crc = update_crc(msg[0], crc);
    msg[1] = 0x03;
    crc = update_crc(msg[1], crc);
    N = 2;
    j = 0;
    while (j < msglen)
    {
        temp = xmit_msg_byte(j++);
        crc = update_crc(temp, crc);
        if ( (temp = FLAG) || (temp = ESC) )
        {
            msg[N] = ESC;
            msg[N+1] = temp ^ INV;
            N = N + 2;
        }
        else
        {
            msg[N] = temp;
            N = N + 1;
        }
    }
    crc = ~crc;
    msg [N] = crc & 0x00FF;
    msg[N+1] = (crc >> 8) & 0x00FF;
    xmit_msg();
}

unsigned short int update_crc(unsigned char new_byte, unsigned short int
crc_reg)
{
int i;
    crc_reg = crc_reg ^ new_byte;
    for (i=0; i<8; i++)
        if (crc_reg & 0x0001)
            crc_reg = (crc_reg>>1) ^ GENPOL;
        else
            crc_reg = crc_reg >> 1;
    return (crc_reg);
}
```

Appendix II

Downstream power back-off

(This appendix does not form an integral part of this Recommendation)

II.1 Introduction

Figure II.1 shows a physical layer reference model that illustrates the application of downstream power back-off (DPBO). The objective of the method is to reduce the downstream power injected by the xTU-C at a flexibility point (remote node, cabinet) to the same level as would be expected to be found at the same point in the cable if the signal was injected at the exchange. So the degree of DPBO is controlled by a frequency dependent function of the electrical length of the cable (E-side length) from the exchange to the flexibility point. The method applies power back-off over a range of frequencies, but excludes higher frequencies that the exchange-hosted systems cannot reliably exploit.

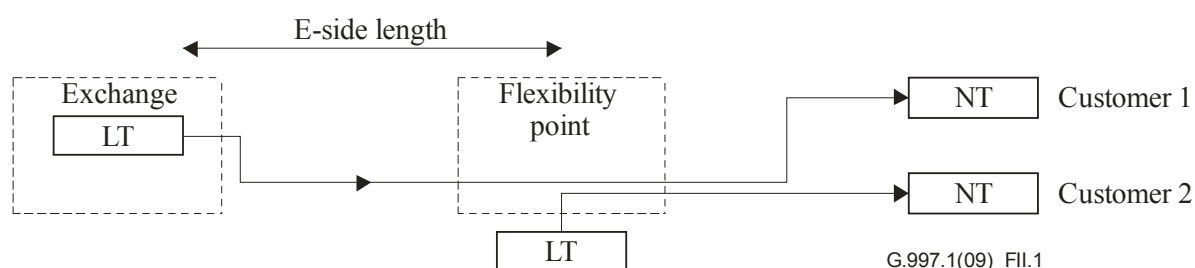

Figure II.1 – Physical layer reference model

This method does not exclude other methods of downstream power back-off, using direct configuration of the parameter PSDMASKds.

A three parameters model of the loop insertion loss has been found to be satisfactory, i.e., $H(f, L) = (a + b \times \sqrt{f} + c \times f) \times L$ dB where L is a metric of electrical length of the E-side cable. Using this model, it has been found possible to track the insertion loss of the predominant gauges of E-side copper pairs with one set of parameters.

The resulting PSD mask for the cabinet based transmitters is a function of a number of parameters that are set by the NMS. The DPBO control information flows for generating the PSD mask are illustrated in Figure II.2. The modification of the downstream PSD mask is done in the ME of the access node. Without DPBO the mask (PSDMASKds) used at the cabinet is the appropriate remote PSD mask defined in the relevant xDSL standard. With DPBO a modified PSDMASKds is generated as a function of the E-side electrical length, maximum useful signal, the cable model parameters and the exchange PSD mask. Additionally, the modified PSD mask is subject to a low frequency override PSD mask that applies independent of DPBOESEL.

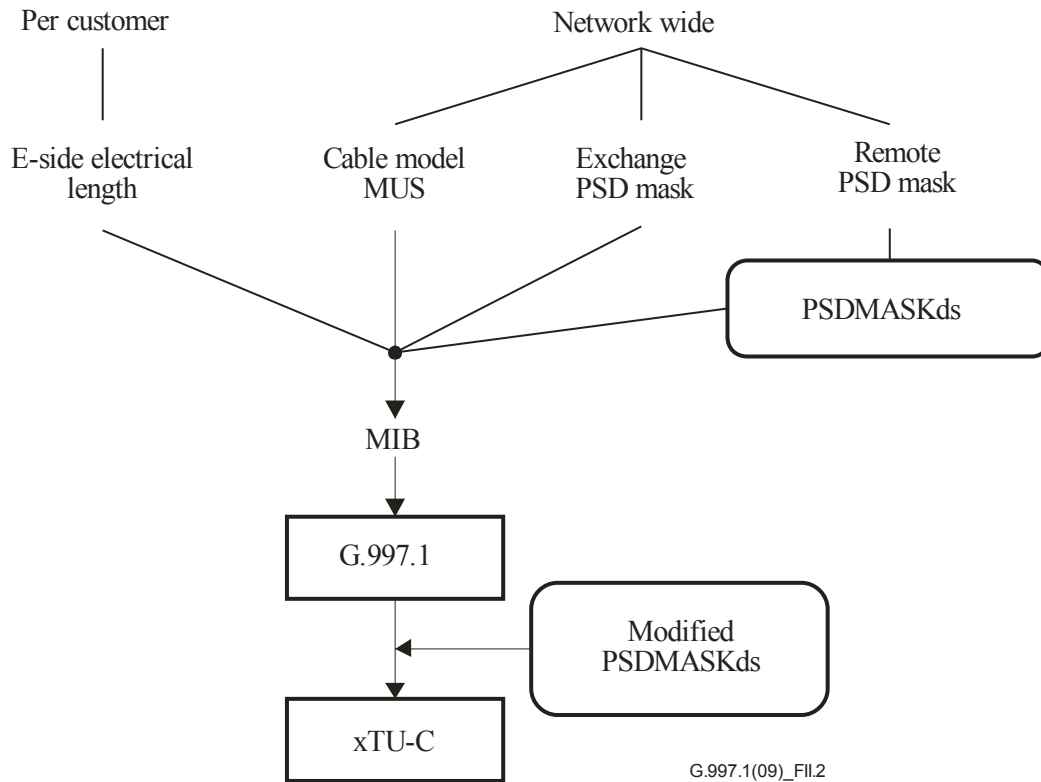

Figure II.2 – DPBO control information flows

II.2 Description of the DPBO method

The configuration parameters of the DPBO defined in this Recommendation are summarized in Table II.1.

Table II.1 – DPBO configuration parameters

Parameter	Description
DPBOEPSD	The exchange site maximum PSD mask.
DPBOPSDMASKds	The overall maximum PSD mask limit when DPBO is applied.
DPBOESEL	The electrical length of exchange to cabinet cable.
DPBOESCMA	E-side cable model parameter A.
DPBOESCMB	E-side cable model parameter B.
DPBOESCMC	E-side cable model parameter C.
DPBOMUS	Assumed minimum usable PSD mask of exchange signals at remote site.
DPBOFMIN	The lower bound on the DPBO frequency span.
DPBOFMAX	The upper bound on the DPBO frequency span.
DPBOLFO	The low frequency PSD mask override.

In the case where there exists a violation of monotonic frequency sequence in the set of breakpoints $PSDMASKds(t_i, PSD_i)$, such that $t_d > t_{d+1}$, then the first step is to derive $DPBOPSDMASKds$ and $DPBOLFO$ from the set of breakpoints $PSDMASKds$ where:

$$DPBOPSDMASKds(t_i, PSD_i) = PSDMASKds(t_i, PSD_i), 0 < i \leq d$$

$$DPBOLFO(t_i, PSD_i) = PSDMASKds(t_i, PSD_i), d < i \leq 32$$

In the case where the frequency sequence in the set of breakpoints $PSDMASK_{ds}(t_i, PSD_i)$ is monotonic, then DPBOLFO is assumed to be everywhere less than or equal to -91.5 dBm/Hz.

The next step in generating the backed-off transmit PSD mask is to generate the predicted downstream exchange signal PSD mask ($PEPSD(f)$) at the remote site:

$$PEPSD(f) = DPBOEPSD(f) - (DPBOESCMA + DPBOESCMB \cdot \sqrt{f} + DPBOESCMC \cdot f) \cdot DPBOESEL$$

The assumed maximum usable frequency (MUF) from the exchange is the highest frequency f such that:

$$PEPSD(f) > DPBOMUS$$

Applying the DPBO mechanism directly will result in a practically difficult "brick wall" transition at the MUF. This is alleviated by introducing a "Minimum PSD Mask" between DPBOFMIN and DPBOFMAX with a smoother transition at MUF and an overall noise floor of -91.5 dBm on the low frequency. The minimum PSD mask also implements the low frequency PSD mask override by taking the maximum of the DPBOLFO and the noise floor. The minimum PSD mask ($DPBOMPSD(f)$) is therefore defined between DPBOFMIN and $F_1 = \min(DPBOFMAX, MUF)$ as:

$$DPBOMPSD(f) = \begin{cases} \max[DPBOLFO(f), -91.5] \text{ dBm/Hz} & \text{for } f \leq F_1 - 175 \text{ kHz} \\ \max[DPBOLFO(f), \frac{11.5}{175}(f - F_1) - 80] \text{ dBm/Hz} & \text{for } F_1 - 175 \text{ kHz} < f < F_1 \end{cases}$$

where f is expressed in kHz.

Downstream power back-off is then applied to $PSDMASK_{ds}(f)$ in this band to create the overall downstream PSD mask for equipment at the remote flexibility point.

$$RESULTMASK_{ds}(f) = \begin{cases} \max[\min(DPBOPSDMASK_{ds}(f), PEPSD(f)), DPBOMPSD(f)] & DPBOFMIN \leq f \leq F_1 \\ DPBOPSDMASK_{ds}(f) & \text{Otherwise} \end{cases}$$

Figure II.3 shows the PSD mask and the resultant mask with DPBO applied.

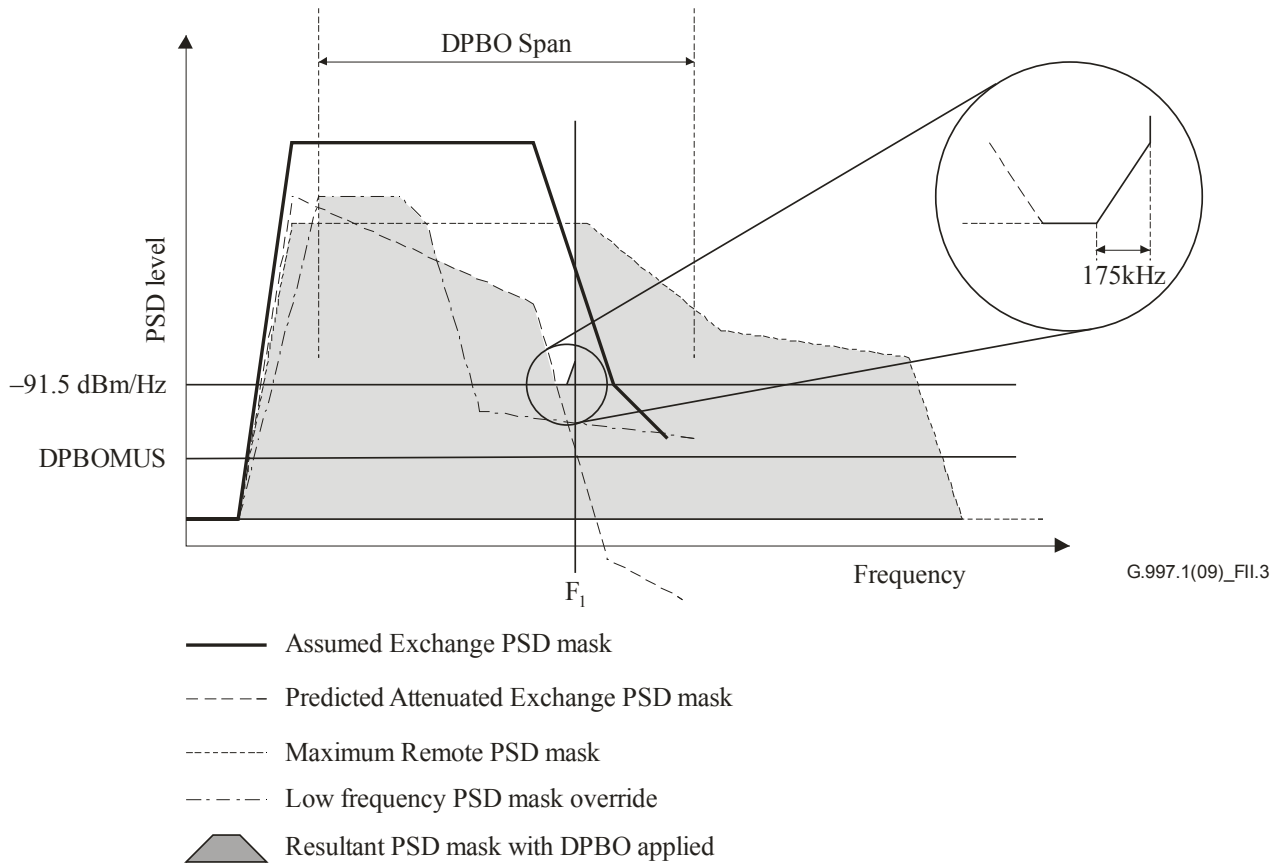

Figure II.3 – Creation of the mask with downstream power back-off

Bibliography

- [b-ITU-T I.361] Recommendation ITU-T I.361 (1999), *B-ISDN ATM layer specification*.
- [b-ITU-T M.20] Recommendation ITU-T M.20 (1992), *Maintenance philosophy for telecommunication networks*.
- [b-ITU-T M.2100] Recommendation ITU-T M.2100 (2003), *Performance limits for bringing-into-service and maintenance of international multi-operator PDH paths and connections*.
- [b-ITU-T M.2101] Recommendation ITU-T M.2101 (2003), *Performance limits for bringing-into-service and maintenance of international multi-operator SDH paths and multiplex sections*.
- [b-ITU-T M.2120] Recommendation ITU-T M.2120 (2002), *International multi-operator paths, sections and transmission systems fault detection and localization procedures*.
- [b-ITU-T X.731] Recommendation ITU-T X.731 (1992) | ISO/IEC 10164-2:1993, *Information technology – Open Systems Interconnection – Systems management: State management function*.
- [b-ATIS 0300231] ATIS 0300231-2003, *Layer 1 In-service Digital Transmission Performance Monitoring*.
- [b-ATIS 0600413] ATIS 0600413-2009, *Network to Customer Installation Interfaces – Asymmetric Digital Subscriber Line (ADSL) Metallic Interface*.
- [b-ETSI TS 101 388] ETSI TS 101 388 V1.4.1 (2007-08), *Access Terminals Transmission and Multiplexing (TM); Access transmission systems on metallic access cables; Asymmetric Digital Subscriber Line (ADSL) – European specific requirements [ITU-T Recommendation G.992.1 modified]*.
- [b-IETF RFC 1700] IETF RFC 1700 (1994), *Assigned Numbers*.
- [b-IETF RFC 2233] IETF RFC 2233 (1997), *The Interfaces Group MIB using SMIv2*.
- [b-IETF RFC 2662] IETF RFC 2662 (1999), *Definitions of Managed Objects for the ADSL Lines*.
- [b-IETF RFC 3440] IETF RFC 3440 (2002), *Definitions of Extension Managed Objects for Asymmetric Digital Subscriber Lines*.
- [b-IEEE 802.3] IEEE Std 802.3-2008, *IEEE Standard for Information technology – Telecommunications and information exchange between systems – Local and metropolitan area networks – Specific requirements – Part 3: Carrier Sense Multiple Access with Collision Detection (CSMA/CD) Access Method and Physical Layer Specifications*.
- [b-ISO/IEC 13239] ISO/IEC 13239:2002, *Information technology – Telecommunications and information exchange between systems – High-level data link control (HDLC) procedures*.

SERIES OF ITU-T RECOMMENDATIONS

Series A	Organization of the work of ITU-T
Series D	General tariff principles
Series E	Overall network operation, telephone service, service operation and human factors
Series F	Non-telephone telecommunication services
Series G	Transmission systems and media, digital systems and networks
Series H	Audiovisual and multimedia systems
Series I	Integrated services digital network
Series J	Cable networks and transmission of television, sound programme and other multimedia signals
Series K	Protection against interference
Series L	Construction, installation and protection of cables and other elements of outside plant
Series M	Telecommunication management, including TMN and network maintenance
Series N	Maintenance: international sound programme and television transmission circuits
Series O	Specifications of measuring equipment
Series P	Terminals and subjective and objective assessment methods
Series Q	Switching and signalling
Series R	Telegraph transmission
Series S	Telegraph services terminal equipment
Series T	Terminals for telematic services
Series U	Telegraph switching
Series V	Data communication over the telephone network
Series X	Data networks, open system communications and security
Series Y	Global information infrastructure, Internet protocol aspects and next-generation networks
Series Z	Languages and general software aspects for telecommunication systems