



INTERNATIONAL TELECOMMUNICATION UNION

ITU-T

TELECOMMUNICATION
STANDARDIZATION SECTOR
OF ITU

H.262

(02/2000)

SERIES H: AUDIOVISUAL AND MULTIMEDIA SYSTEMS
Infrastructure of audiovisual services – Coding of moving
video

**Information technology – Generic coding of
moving pictures and associated audio
information: Video**

ITU-T Recommendation H.262

(Previously CCITT Recommendation)

ITU-T H-SERIES RECOMMENDATIONS
AUDIOVISUAL AND MULTIMEDIA SYSTEMS

Characteristics of transmission channels used for other than telephone purposes	H.10–H.19
Use of telephone-type circuits for voice-frequency telegraphy	H.20–H.29
Telephone circuits or cables used for various types of telegraph transmission or simultaneous transmission	H.30–H.39
Telephone-type circuits used for facsimile telegraphy	H.40–H.49
Characteristics of data signals	H.50–H.99
CHARACTERISTICS OF VISUAL TELEPHONE SYSTEMS	H.100–H.199
INFRASTRUCTURE OF AUDIOVISUAL SERVICES	
General	H.200–H.219
Transmission multiplexing and synchronization	H.220–H.229
Systems aspects	H.230–H.239
Communication procedures	H.240–H.259
Coding of moving video	H.260–H.279
Related systems aspects	H.280–H.299
Systems and terminal equipment for audiovisual services	H.300–H.399
Supplementary services for multimedia	H.450–H.499

For further details, please refer to ITU-T List of Recommendations.

**INFORMATION TECHNOLOGY – GENERIC CODING OF MOVING
PICTURES AND ASSOCIATED AUDIO INFORMATION: VIDEO**

Summary

This Recommendation | International Standard specifies coded representation of video data and the decoding process required to reconstruct pictures. It provides a generic video coding scheme which serves a wide range of applications, bit rates, picture resolutions and qualities. Its basic coding algorithm is a hybrid of motion compensated prediction and DCT. Pictures to be coded can be either interlaced or progressive. Necessary algorithmic elements are integrated into a single syntax, and a limited number of subsets are defined in terms of Profile (functionalities) and Level (parameters) to facilitate practical use of this generic video coding standard.

This second edition of this Recommendation | International Standard consists of ITU-T Rec. H.262 (1995) | ISO/IEC 13818-2:1996, subsequently altered by two corrigenda and six amendments:

1. A first corrigendum adding a slice picture identifier, allowing an application to define default colour description parameters, removing a prohibition of field-structured DCT coding in progressive frames, clarifying ambiguity on restricted range of reconstructed motion vectors, clarifying ambiguity of VBV at boundaries of sequences, and making various minor corrections.
2. A second corrigendum altering the inverse discrete cosine transform requirements, altering temporal_reference for low delay, and making various minor corrections.
3. A first amendment providing a method of obtaining and registering copyright identifiers.
4. A second amendment defining a 4:2:2 profile.
5. A third amendment adding a camera parameters extension and a multi-view profile.
6. A fourth amendment adding an ITU-T extension.
7. A fifth amendment adding a high level to the 4:2:2 profile.
8. A sixth amendment reducing the upper bound for the number of lines per frame in the high level of all profiles from 1152 to 1088.

Source

ITU-T Recommendation H.262 was approved on 17 February 2000. The identical text is also published as ISO/IEC International Standard 13818-2.

This edition of ITU-T H.262 consolidates H.262 (07/1995) and its Amendments 1 and 2 (11/1996), 3 and 4 (02/1998), 5 (05/1999), 6 (02/2000) and Corrigenda 1 and 2 (11/1996).

FOREWORD

ITU (International Telecommunication Union) is the United Nations Specialized Agency in the field of telecommunications. The ITU Telecommunication Standardization Sector (ITU-T) is a permanent organ of the ITU. The ITU-T is responsible for studying technical, operating and tariff questions and issuing Recommendations on them with a view to standardizing telecommunications on a worldwide basis.

The World Telecommunication Standardization Conference (WTSC), which meets every four years, establishes the topics for study by the ITU-T Study Groups which, in their turn, produce Recommendations on these topics.

The approval of Recommendations by the Members of the ITU-T is covered by the procedure laid down in WTSC Resolution No. 1.

In some areas of information technology which fall within ITU-T's purview, the necessary standards are prepared on a collaborative basis with ISO and IEC.

NOTE

In this Recommendation, the expression "Administration" is used for conciseness to indicate both a telecommunication administration and a recognized operating agency.

INTELLECTUAL PROPERTY RIGHTS

The ITU draws attention to the possibility that the practice or implementation of this Recommendation may involve the use of a claimed Intellectual Property Right. The ITU takes no position concerning the evidence, validity or applicability of claimed Intellectual Property Rights, whether asserted by ITU members or others outside of the Recommendation development process.

As of the date of approval of this Recommendation, the ITU had not received notice of intellectual property, protected by patents, which may be required to implement this Recommendation. However, implementors are cautioned that this may not represent the latest information and are therefore strongly urged to consult the TSB patent database.

© ITU 2000

All rights reserved. No part of this publication may be reproduced or utilized in any form or by any means, electronic or mechanical, including photocopying and microfilm, without permission in writing from the ITU.

CONTENTS

	<i>Page</i>
Intro. 1 Purpose.....	v
Intro. 2 Application.....	v
Intro. 3 Profiles and levels.....	v
Intro. 4 The scalable and the non-scalable syntax.....	vi
1 Scope.....	1
2 Normative references.....	1
3 Definitions.....	2
4 Abbreviations and symbols.....	7
4.1 Arithmetic operators.....	7
4.2 Logical operators.....	8
4.3 Relational operators.....	8
4.4 Bitwise operators.....	8
4.5 Assignment.....	8
4.6 Mnemonics.....	8
4.7 Constants.....	9
5 Conventions.....	9
5.1 Method of describing bitstream syntax.....	9
5.2 Definition of functions.....	10
5.3 Reserved, forbidden and marker_bit.....	10
5.4 Arithmetic precision.....	11
6 Video bitstream syntax and semantics.....	11
6.1 Structure of coded video data.....	11
6.2 Video bitstream syntax.....	21
6.3 Video bitstream semantics.....	36
7 The video decoding process.....	61
7.1 Higher syntactic structures.....	61
7.2 Variable length decoding.....	62
7.3 Inverse scan.....	64
7.4 Inverse quantisation.....	66
7.5 Inverse DCT.....	69
7.6 Motion compensation.....	69
7.7 Spatial scalability.....	83
7.8 SNR scalability.....	92
7.9 Temporal scalability.....	99
7.10 Data partitioning.....	102
7.11 Hybrid scalability.....	103
7.12 Output of the decoding process.....	104
8 Profiles and levels.....	106
8.1 ISO/IEC 11172-2 compatibility.....	109
8.2 Relationship between defined profiles.....	109
8.3 Relationship between defined levels.....	111
8.4 Scalable layers.....	111
8.5 Parameter values for defined profiles, levels and layers.....	114
8.6 Compatibility requirements on decoders.....	115
9 Registration of Copyright Identifiers.....	117
9.1 General.....	117
9.2 Implementation of a Registration Authority (RA).....	118

	<i>Page</i>
Annex A – Inverse discrete transform	119
Annex B – Variable length code tables	121
B.1 Macroblock addressing.....	121
B.2 Macroblock type.....	122
B.3 Macroblock pattern.....	127
B.4 Motion vectors.....	128
B.5 DCT coefficients	129
Annex C – Video buffering verifier	138
Annex D – Features supported by the algorithm.....	143
D.1 Overview	143
D.2 Video formats	143
D.3 Picture quality.....	144
D.4 Data rate control	144
D.5 Low delay mode	144
D.6 Random access/channel hopping.....	145
D.7 Scalability.....	145
D.8 Compatibility.....	151
D.9 Differences between this Specification and ISO/IEC 11172-2.....	151
D.10 Complexity	154
D.11 Editing encoded bitstreams.....	154
D.12 Trick modes	154
D.13 Error resilience	155
D.14 Concatenated sequences	162
Annex E – Profile and level restrictions	163
E.1 Syntax element restrictions in profiles	163
E.2 Permissible layer combinations.....	175
Annex F – Bibliography.....	197
Annex G – Registration Procedure	198
G.1 Procedure for the request of a Registered Identifier (RID).....	198
G.2 Responsibilities of the Registration Authority.....	198
G.3 Responsibilities of parties requesting an RID.....	198
G.4 Appeal procedure for denied applications	199
Annex H – Registration Application Form	200
H.1 Contact information of organization requesting a Registered Identifier (RID)	200
H.2 Statement of an intention to apply the assigned RID.....	200
H.3 Date of intended implementation of the RID.....	200
H.4 Authorized representative.....	200
H.5 For official use only of the Registration Authority.....	200
Annex J – 4:2:2 Profile test results	202
J.1 Introduction	202

Introduction

Intro. 1 Purpose

This Part of this Recommendation | International Standard was developed in response to the growing need for a generic coding method of moving pictures and of associated sound for various applications such as digital storage media, television broadcasting and communication. The use of this Specification means that motion video can be manipulated as a form of computer data and can be stored on various storage media, transmitted and received over existing and future networks and distributed on existing and future broadcasting channels.

Intro. 2 Application

The applications of this Specification cover, but are not limited to, such areas as listed below:

BSS	Broadcasting Satellite Service (to the home)
CATV	Cable TV Distribution on optical networks, copper, etc.
CDAD	Cable Digital Audio Distribution
DSB	Digital Sound Broadcasting (terrestrial and satellite broadcasting)
DTTB	Digital Terrestrial Television Broadcasting
EC	Electronic Cinema
ENG	Electronic News Gathering (including SNG, Satellite News Gathering)
FSS	Fixed Satellite Service (e.g. to head ends)
HTT	Home Television Theatre
IPC	Interpersonal Communications (videoconferencing, videophone, etc.)
ISM	Interactive Storage Media (optical disks, etc.)
MMM	Multimedia Mailing
NCA	News and Current Affairs
NDB	Networked Database Services (via ATM, etc.)
RVS	Remote Video Surveillance
SSM	Serial Storage Media (digital VTR, etc.)

Intro. 3 Profiles and levels

This Specification is intended to be generic in the sense that it serves a wide range of applications, bitrates, resolutions, qualities and services. Applications should cover, among other things, digital storage media, television broadcasting and communications. In the course of creating this Specification, various requirements from typical applications have been considered, necessary algorithmic elements have been developed, and they have been integrated into a single syntax. Hence, this Specification will facilitate the bitstream interchange among different applications.

Considering the practicality of implementing the full syntax of this Specification, however, a limited number of subsets of the syntax are also stipulated by means of "profile" and "level". These and other related terms are formally defined in clause 3.

A "profile" is a defined subset of the entire bitstream syntax that is defined by this Specification. Within the bounds imposed by the syntax of a given profile it is still possible to require a very large variation in the performance of encoders and decoders depending upon the values taken by parameters in the bitstream. For instance, it is possible to specify frame sizes as large as (approximately) 2^{14} samples wide by 2^{14} lines high. It is currently neither practical nor economic to implement a decoder capable of dealing with all possible frame sizes.

In order to deal with this problem, "levels" are defined within each profile. A level is a defined set of constraints imposed on parameters in the bitstream. These constraints may be simple limits on numbers. Alternatively they may take the form of constraints on arithmetic combinations of the parameters (e.g. frame width multiplied by frame height multiplied by frame rate).

Bitstreams complying with this Specification use a common syntax. In order to achieve a subset of the complete syntax, flags and parameters are included in the bitstream that signal the presence or otherwise of syntactic elements that occur later in the bitstream. In order to specify constraints on the syntax (and hence define a profile), it is thus only necessary to constrain the values of these flags and parameters that specify the presence of later syntactic elements.

Intro. 4 The scalable and the non-scalable syntax

The full syntax can be divided into two major categories: One is the non-scalable syntax, which is structured as a super set of the syntax defined in ISO/IEC 11172-2. The main feature of the non-scalable syntax is the extra compression tools for interlaced video signals. The second is the scalable syntax, the key property of which is to enable the reconstruction of useful video from pieces of a total bitstream. This is achieved by structuring the total bitstream in two or more layers, starting from a standalone base layer and adding a number of enhancement layers. The base layer can use the non-scalable syntax, or in some situations conform to the ISO/IEC 11172-2 syntax.

Intro. 4.1 Overview of the non-scalable syntax

The coded representation defined in the non-scalable syntax achieves a high compression ratio while preserving good image quality. The algorithm is not lossless as the exact sample values are not preserved during coding. Obtaining good image quality at the bitrates of interest demands very high compression, which is not achievable with intra picture coding alone. The need for random access, however, is best satisfied with pure intra picture coding. The choice of the techniques is based on the need to balance a high image quality and compression ratio with the requirement to make random access to the coded bitstream.

A number of techniques are used to achieve high compression. The algorithm first uses block-based motion compensation to reduce the temporal redundancy. Motion compensation is used both for causal prediction of the current picture from a previous picture, and for non-causal, interpolative prediction from past and future pictures. Motion vectors are defined for each 16-sample by 16-line region of the picture. The prediction error, is further compressed using the Discrete Cosine Transform (DCT) to remove spatial correlation before it is quantised in an irreversible process that discards the less important information. Finally, the motion vectors are combined with the quantised DCT information, and encoded using variable length codes.

Intro. 4.1.1 Temporal processing

Because of the conflicting requirements of random access and highly efficient compression, three main picture types are defined. Intra Coded Pictures (I-Pictures) are coded without reference to other pictures. They provide access points to the coded sequence where decoding can begin, but are coded with only moderate compression. Predictive Coded Pictures (P-Pictures) are coded more efficiently using motion compensated prediction from a past intra or predictive coded picture and are generally used as a reference for further prediction. Bidirectionally-predictive Coded Pictures (B-Pictures) provide the highest degree of compression but require both past and future reference pictures for motion compensation. Bidirectionally-predictive coded pictures are never used as references for prediction (except in the case that the resulting picture is used as a reference in a spatially scalable enhancement layer). The organisation of the three picture types in a sequence is very flexible. The choice is left to the encoder and will depend on the requirements of the application. Figure Intro. 1 illustrates an example of the relationship among the three different picture types.

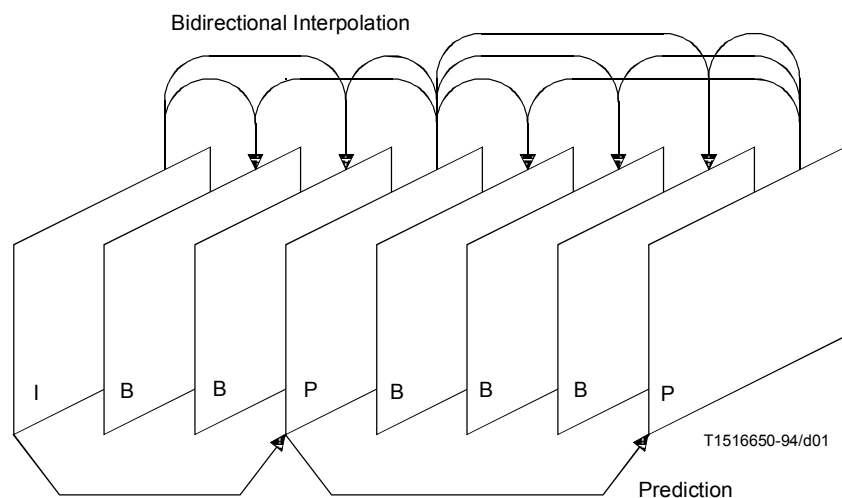

Figure Intro. 1 – Example of temporal picture structure

Intro. 4.1.2 Coding interlaced video

Each frame of interlaced video consists of two fields which are separated by one field-period. The Specification allows either the frame to be encoded as picture or the two fields to be encoded as two pictures. Frame encoding or field encoding can be adaptively selected on a frame-by-frame basis. Frame encoding is typically preferred when the video scene contains significant detail with limited motion. Field encoding, in which the second field can be predicted from the first, works better when there is fast movement.

Intro. 4.1.3 Motion representation – Macroblocks

As in ISO/IEC 11172-2, the choice of 16 by 16 macroblocks for the motion-compensation unit is a result of the trade-off between the coding gain provided by using motion information and the overhead needed to represent it. Each macroblock can be temporally predicted in one of a number of different ways. For example, in frame encoding, the prediction from the previous reference frame can itself be either frame-based or field-based. Depending on the type of the macroblock, motion vector information and other side information is encoded with the compressed prediction error in each macroblock. The motion vectors are encoded differentially with respect to the last encoded motion vectors using variable length codes. The maximum length of the motion vectors that may be represented can be programmed, on a picture-by-picture basis, so that the most demanding applications can be met without compromising the performance of the system in more normal situations.

It is the responsibility of the encoder to calculate appropriate motion vectors. This Specification does not specify how this should be done.

Intro. 4.1.4 Spatial redundancy reduction

Both source pictures and prediction errors have high spatial redundancy. This Specification uses a block-based DCT method with visually weighted quantisation and run-length coding. After motion compensated prediction or interpolation, the resulting prediction error is split into 8 by 8 blocks. These are transformed into the DCT domain where they are weighted before being quantised. After quantisation many of the DCT coefficients are zero in value and so two-dimensional run-length and variable length coding is used to encode the remaining DCT coefficients efficiently.

Intro. 4.1.5 Chrominance formats

In addition to the 4:2:0 format supported in ISO/IEC 11172-2 this Specification supports 4:2:2 and 4:4:4 chrominance formats.

Intro. 4.2 Scalable extensions

The scalability tools in this Specification are designed to support applications beyond that supported by single layer video. Among the noteworthy applications areas addressed are video telecommunications, video on Asynchronous Transfer Mode (ATM) networks, interworking of video standards, video service hierarchies with multiple spatial, temporal and quality resolutions, HDTV with embedded TV, systems allowing migration to higher temporal resolution HDTV, etc. Although a simple solution to scalable video is the simulcast technique which is based on transmission/storage of multiple independently coded reproductions of video, a more efficient alternative is scalable video coding, in which the bandwidth allocated to a given reproduction of video can be partially re-utilised in coding of the next reproduction of video. In scalable video coding, it is assumed that given a coded bitstream, decoders of various complexities can decode and display appropriate reproductions of coded video. A scalable video encoder is likely to have increased complexity when compared to a single layer encoder. However, this Recommendation | International Standard provides several different forms of scalabilities that address non-overlapping applications with corresponding complexities. The basic scalability tools offered are:

- data partitioning;
- SNR scalability;
- spatial scalability; and
- temporal scalability.

Moreover, combinations of these basic scalability tools are also supported and are referred to as *hybrid scalability*. In the case of basic scalability, two layers of video referred to as the *lower layer* and the *enhancement layer* are allowed, whereas in hybrid scalability up to three layers are supported. Tables Intro. 1 to Intro. 3 provide a few example applications of various scalabilities.

Table Intro. 1 – Applications of SNR scalability

Lower layer	Enhancement layer	Application
Recommendation ITU-R BT.601	Same resolution and format as lower layer	Two quality service for Standard TV (SDTV)
High Definition	Same resolution and format as lower layer	Two quality service for HDTV
4:2:0 high definition	4:2:2 chroma simulcast	Video production / distribution

Table Intro. 2 – Applications of spatial scalability

Base	Enhancement	Application
Progressive (30 Hz)	Progressive (30 Hz)	Compatibility or scalability CIF/SCIF
Interlace (30 Hz)	Interlace (30 Hz)	HDTV/SDTV scalability
Progressive (30 Hz)	Interlace (30 Hz)	ISO/IEC 11172-2/compatibility with this Specification
Interlace (30 Hz)	Progressive (60 Hz)	Migration to high resolution progressive HDTV

Table Intro. 3 – Applications of temporal scalability

Base	Enhancement	Higher	Application
Progressive (30 Hz)	Progressive (30 Hz)	Progressive (60 Hz)	Migration to high resolution progressive HDTV
Interlace (30 Hz)	Interlace (30 Hz)	Progressive (60 Hz)	Migration to high resolution progressive HDTV

Intro. 4.2.1 Spatial scalable extension

Spatial scalability is a tool intended for use in video applications involving telecommunications, interworking of video standards, video database browsing, interworking of HDTV and TV, etc., i.e. video systems with the primary common feature that a minimum of two layers of spatial resolution are necessary. Spatial scalability involves generating two spatial resolution video layers from a single video source such that the lower layer is coded by itself to provide the basic spatial resolution and the enhancement layer employs the spatially interpolated lower layer and carries the full spatial resolution of the input video source. The lower and the enhancement layers may either both use the coding tools in this Specification, or the ISO/IEC 11172-2 Standard for the lower layer and this Specification for the enhancement layer. The latter case achieves a further advantage by facilitating interworking between video coding standards. Moreover, spatial scalability offers flexibility in choice of video formats to be employed in each layer. An additional advantage of spatial scalability is its ability to provide resilience to transmission errors as the more important data of the lower layer can be sent over channel with better error performance, while the less critical enhancement layer data can be sent over a channel with poor error performance.

Intro. 4.2.2 SNR scalable extension

SNR scalability is a tool intended for use in video applications involving telecommunications, video services with multiple qualities, standard TV and HDTV, i.e. video systems with the primary common feature that a minimum of two layers of video quality are necessary. SNR scalability involves generating two video layers of same spatial resolution but different video qualities from a single video source such that the lower layer is coded by itself to provide the basic video quality and the enhancement layer is coded to enhance the lower layer. The enhancement layer when added back to the

lower layer regenerates a higher quality reproduction of the input video. The lower and the enhancement layers may either use this Specification or ISO/IEC 11172-2 Standard for the lower layer and this Specification for the enhancement layer. An additional advantage of SNR scalability is its ability to provide high degree of resilience to transmission errors as the more important data of the lower layer can be sent over channel with better error performance, while the less critical enhancement layer data can be sent over a channel with poor error performance.

Intro. 4.2.3 Temporal scalable extension

Temporal scalability is a tool intended for use in a range of diverse video applications from telecommunications to HDTV for which migration to higher temporal resolution systems from that of lower temporal resolution systems may be necessary. In many cases, the lower temporal resolution video systems may be either the existing systems or the less expensive early generation systems, with the motivation of introducing more sophisticated systems gradually. Temporal scalability involves partitioning of video frames into layers, whereas the lower layer is coded by itself to provide the basic temporal rate and the enhancement layer is coded with temporal prediction with respect to the lower layer, these layers when decoded and temporal multiplexed to yield full temporal resolution of the video source. The lower temporal resolution systems may only decode the lower layer to provide basic temporal resolution, whereas more sophisticated systems of the future may decode both layers and provide high temporal resolution video while maintaining interworking with earlier generation systems. An additional advantage of temporal scalability is its ability to provide resilience to transmission errors as the more important data of the lower layer can be sent over channel with better error performance, while the less critical enhancement layer can be sent over a channel with poor error performance.

Intro. 4.2.4 Data partitioning extension

Data partitioning is a tool intended for use when two channels are available for transmission and/or storage of a video bitstream, as may be the case in ATM networks, terrestrial broadcast, magnetic media, etc. The bitstream is partitioned between these channels such that more critical parts of the bitstream (such as headers, motion vectors, low frequency DCT coefficients) are transmitted in the channel with the better error performance, and less critical data (such as higher frequency DCT coefficients) is transmitted in the channel with poor error performance. Thus, degradation to channel errors are minimised since the critical parts of a bitstream are better protected. Data from neither channel may be decoded on a decoder that is not intended for decoding data partitioned bitstreams.

INTERNATIONAL STANDARD

ITU-T RECOMMENDATION

INFORMATION TECHNOLOGY – GENERIC CODING OF MOVING PICTURES AND ASSOCIATED AUDIO INFORMATION: VIDEO

1 Scope

This Recommendation | International Standard specifies the coded representation of picture information for digital storage media and digital video communication and specifies the decoding process. The representation supports constant bitrate transmission, variable bitrate transmission, random access, channel hopping, scalable decoding, bitstream editing, as well as special functions such as fast forward playback, fast reverse playback, slow motion, pause and still pictures. This Recommendation | International Standard is forward compatible with ISO/IEC 11172-2 and upward or downward compatible with EDTV, HDTV, SDTV formats.

This Recommendation | International Standard is primarily applicable to digital storage media, video broadcast and communication. The storage media may be directly connected to the decoder, or via communications means such as busses, LANs, or telecommunications links.

2 Normative references

The following Recommendations and International Standards contain provisions which, through reference in this text, constitute provisions of this Recommendation | International Standard. At the time of publication, the editions indicated were valid. All Recommendations and Standards are subject to revision, and parties to agreements based on this Recommendation | International Standard are encouraged to investigate the possibility of applying the most recent edition of the Recommendations and Standards indicated below. Members of IEC and ISO maintain registers of currently valid International Standards. The Telecommunication Standardization Bureau of ITU maintains a list of currently valid ITU-T Recommendations.

- Recommendation ITU-R BT.601-3 (1992), *Encoding parameters of digital television for studios.*
- Recommendation ITU-R BR.648 (1986), *Digital recording of audio signals.*
- Report ITU-R 955-2 (1990), *Satellite sound broadcasting with portable receivers and receivers in automobiles.*
- ISO/IEC 11172-1:1993, *Information technology – Coding of moving pictures and associated audio for digital storage media at up to about 1,5 Mbit/s – Part 1 : Systems.*
- ISO/IEC 11172-2:1993, *Information technology – Coding of moving pictures and associated audio for digital storage media at up to about 1,5 Mbit/s – Part 2 : Video.*
- ISO/IEC 11172-3:1993, *Information technology – Coding of moving pictures and associated audio for digital storage media at up to about 1,5 Mbit/s – Part 3 : Audio.*
- IEEE 1180:1990, *Standard Specifications for the Implementations of 8 by 8 Inverse Discrete Cosine Transform.*
- IEC 60908 (1999), *Audiorecording – Compact disc digital audio system.*
- IEC 60461 (1986), *Time and control code for video tape recorders.*
- ITU-T Recommendation H.261 (1993), *Video codec for audiovisual services at $p \times 64$ kbit/s.*
- ITU-T Recommendation H.320 (1999), *Narrow-band visual telephone systems and terminal equipment.*
- CCITT Recommendation T.81 (1992) ISO/IEC 10918-1:1994, *Information technology – Digital compression and coding of continuous-tone still images – Requirements and guidelines. (JPEG.)*

3 Definitions

For the purposes of this Recommendation | International Standard, the following definitions apply.

- 3.1 AC coefficient:** Any DCT coefficient for which the frequency in one or both dimensions is non-zero.
- 3.2 big picture:** A coded picture that would cause VBV buffer underflow as defined in C.7. Big pictures can only occur in sequences where `low_delay` is equal to 1. "Skipped picture" is a term that is sometimes used to describe the same concept.
- 3.3 B-field picture:** A field structure B-Picture.
- 3.4 B-frame picture:** A frame structure B-Picture.
- 3.5 B-picture; bidirectionally predictive-coded picture:** A picture that is coded using motion compensated prediction from past and/or future reference fields or frames.
- 3.6 backward compatibility:** A newer coding standard is backward compatible with an older coding standard if decoders designed to operate with the older coding standard are able to continue to operate by decoding all or part of a bitstream produced according to the newer coding standard.
- 3.7 backward motion vector:** A motion vector that is used for motion compensation from a reference frame or reference field at a later time in display order.
- 3.8 backward prediction:** Prediction from the future reference frame (field).
- 3.9 base layer:** First, independently decodable layer of a scalable hierarchy.
- 3.10 bitstream; stream:** An ordered series of bits that forms the coded representation of the data.
- 3.11 bitrate:** The rate at which the coded bitstream is delivered from the storage medium to the input of a decoder.
- 3.12 block:** An 8-row by 8-column matrix of samples, or 64 DCT coefficients (source, quantised or dequantised).
- 3.13 bottom field:** One of two fields that comprise a frame. Each line of a bottom field is spatially located immediately below the corresponding line of the top field.
- 3.14 byte aligned:** A bit in a coded bitstream is byte-aligned if its position is a multiple of 8 bits from the first bit in the stream.
- 3.15 byte:** Sequence of 8 bits.
- 3.16 channel:** A digital medium that stores or transports a bitstream constructed according to ITU-T Rec. H.262 | ISO/IEC 13818-2.
- 3.17 chrominance format:** Defines the number of chrominance blocks in a macroblock.
- 3.18 chroma simulcast:** A type of scalability (which is a subset of SNR scalability) where the enhancement layer(s) contain only coded refinement data for the DC coefficients, and all the data for the AC coefficients, of the chrominance components.
- 3.19 chrominance component:** A matrix, block or single sample representing one of the two colour difference signals related to the primary colours in the manner defined in the bitstream. The symbols used for the chrominance signals are Cr and Cb.
- 3.20 coded B-frame:** A B-frame picture or a pair of B-field pictures.
- 3.21 coded frame:** A coded frame is a coded I-frame, a coded P-frame or a coded B-frame.
- 3.22 coded I-frame:** An I-frame picture or a pair of field pictures, where the first field picture is an I-picture and the second field picture is an I-picture or a P-picture.
- 3.23 coded P-frame:** A P-frame picture or a pair of P-field pictures.
- 3.24 coded picture:** A coded picture is made of a picture header, the optional extensions immediately following it, and the following picture data. A coded picture may be a coded frame or a coded field.
- 3.25 coded video bitstream:** A coded representation of a series of one or more pictures as defined in ITU-T Rec. H.262 | ISO/IEC 13818-2.
- 3.26 coded order:** The order in which the pictures are transmitted and decoded. This order is not necessarily the same as the display order.

- 3.27 coded representation:** A data element as represented in its encoded form.
- 3.28 coding parameters:** The set of user-definable parameters that characterise a coded video bitstream. Bitstreams are characterised by coding parameters. Decoders are characterised by the bitstreams that they are capable of decoding.
- 3.29 component:** A matrix, block or single sample from one of the three matrices (luminance and two chrominance) that make up a picture.
- 3.30 compression:** Reduction in the number of bits used to represent an item of data.
- 3.31 constant bitrate coded video:** A coded video bitstream with a constant bitrate.
- 3.32 constant bitrate:** Operation where the bitrate is constant from start to finish of the coded bitstream.
- 3.33 data element:** An item of data as represented before encoding and after decoding.
- 3.34 data partitioning:** A method for dividing a bitstream into two separate bitstreams for error resilience purposes. The two bitstreams have to be recombined before decoding.
- 3.35 D-Picture:** A type of picture that shall not be used except in ISO/IEC 11172-2.
- 3.36 DC coefficient:** The DCT coefficient for which the frequency is zero in both dimensions.
- 3.37 DCT coefficient:** The amplitude of a specific cosine basis function.
- 3.38 decoder input buffer:** The First-In First-Out (FIFO) buffer specified in the video buffering verifier.
- 3.39 decoder:** An embodiment of a decoding process.
- 3.40 decoding (process):** The process defined in ITU-T Rec. H.262 | ISO/IEC 13818-2 that reads an input coded bitstream and produces decoded pictures.
- 3.41 dequantisation:** The process of rescaling the quantised DCT coefficients after their representation in the bitstream has been decoded and before they are presented to the inverse DCT.
- 3.42 digital storage media (DSM):** A digital storage or transmission device or system.
- 3.43 discrete cosine transform (DCT):** Either the forward discrete cosine transform or the inverse discrete cosine transform. The DCT is an invertible, discrete orthogonal transformation. The inverse DCT is defined in Annex A of ITU-T Rec. H.262 | ISO/IEC 13818-2.
- 3.44 display aspect ratio:** The ratio height/width (in spatial measurement units such as centimeters) of the intended display.
- 3.45 display order:** The order in which the decoded pictures are displayed. Normally this is the same order in which they were presented at the input of the encoder.
- 3.46 display process:** The (non-normative) process by which reconstructed frames are displayed.
- 3.47 dual-prime prediction:** A prediction mode in which two forward field-based predictions are averaged. The predicted block size is 16×16 luminance samples.
- 3.48 editing:** The process by which one or more coded bitstreams are manipulated to produce a new coded bitstream. Conforming edited bitstreams must meet the requirements defined in ITU-T Rec. H.262 | ISO/IEC 13818-2.
- 3.49 encoder:** An embodiment of an encoding process.
- 3.50 encoding (process):** A process, not specified in ITU-T Rec. H.262 | ISO/IEC 13818-2, that reads a stream of input pictures and produces a valid coded bitstream as defined in ITU-T Rec. H.262 | ISO/IEC 13818-2.
- 3.51 enhancement layer:** A relative reference to a layer (above the base layer) in a scalable hierarchy. For all forms of scalability, its decoding process can be described by reference to the lower layer decoding process and the appropriate additional decoding process for the enhancement layer itself.
- 3.52 fast forward playback:** The process of displaying a sequence, or parts of a sequence, of pictures in display-order faster than real-time.
- 3.53 fast reverse playback:** The process of displaying the picture sequence in the reverse of display order faster than real-time.

- 3.54 field:** For an interlaced video signal, a "field" is the assembly of alternate lines of a frame. Therefore an interlaced frame is composed of two fields, a top field and a bottom field.
- 3.55 field-based prediction:** A prediction mode using only one field of the reference frame. The predicted block size is 16×16 luminance samples.
- 3.56 field period:** The reciprocal of twice the frame rate.
- 3.57 field picture; field structure picture:** A field structure picture is a coded picture with picture_structure is equal to "Top field" or "Bottom field".
- 3.58 flag:** A one bit integer variable which may take one of only two values (zero and one).
- 3.59 forbidden:** The term "forbidden" when used in the clauses defining the coded bitstream indicates that the value shall never be used. This is usually to avoid emulation of start codes.
- 3.60 forced updating:** The process by which macroblocks are intra-coded from time-to-time to ensure that mismatch errors between the inverse DCT processes in encoders and decoders cannot build up excessively.
- 3.61 forward compatibility:** A newer coding standard is forward compatible with an older coding standard if decoders designed to operate with the newer coding standard are able to decode bitstreams of the older coding standard.
- 3.62 forward motion vector:** A motion vector that is used for motion compensation from a reference frame or reference field at an earlier time in display order.
- 3.63 forward prediction:** Prediction from the past reference frame (field).
- 3.64 frame:** A frame contains lines of spatial information of a video signal. For progressive video, these lines contain samples starting from one time instant and continuing through successive lines to the bottom of the frame. For interlaced video, a frame consists of two fields, a top field and a bottom field. One of these fields will commence one field period later than the other.
- 3.65 frame-based prediction:** A prediction mode using both fields of the reference frame.
- 3.66 frame period:** The reciprocal of the frame rate.
- 3.67 frame picture; frame structure picture:** A frame structure picture is a coded picture with picture_structure is equal to "Frame".
- 3.68 frame rate:** The rate at which frames are output from the decoding process.
- 3.69 future reference frame (field):** A future reference frame (field) is a reference frame (field) that occurs at a later time than the current picture in display order.
- 3.70 frame re-ordering:** The process of re-ordering the reconstructed frames when the coded order is different from the display order. Frame re-ordering occurs when B-frames are present in a bitstream. There is no frame re-ordering when decoding low delay bitstreams.
- 3.71 group of pictures:** A notion defined only in ISO/IEC 11172-2 (MPEG-1 Video). In ITU-T Rec. H.262 | ISO/IEC 13818-2, a similar functionality can be achieved by the mean of inserting group of pictures headers.
- 3.72 header:** A block of data in the coded bitstream containing the coded representation of a number of data elements pertaining to the coded data that follow the header in the bitstream.
- 3.73 hybrid scalability:** Hybrid scalability is the combination of two (or more) types of scalability.
- 3.74 interlace:** The property of conventional television frames where alternating lines of the frame represent different instances in time. In an interlaced frame, one of the field is meant to be displayed first. This field is called the first field. The first field can be the top field or the bottom field of the frame.
- 3.75 I-field picture:** A field structure I-Picture.
- 3.76 I-frame picture:** A frame structure I-Picture.
- 3.77 I-picture; intra-coded picture:** A picture coded using information only from itself.
- 3.78 intra coding:** Coding of a macroblock or picture that uses information only from that macroblock or picture.
- 3.78.1 Inverse DCT, IDCT:** Inverse discrete cosine transform, as defined in Annex A.
- 3.79 level:** A defined set of constraints on the values which may be taken by the parameters of ITU-T Rec. H.262 | ISO/IEC 13818-2 within a particular profile. A profile may contain one or more levels. In a different context, level is the absolute value of a non-zero coefficient (see "run").

- 3.80 layer:** In a scalable hierarchy denotes one out of the ordered set of bitstreams and (the result of) its associated decoding process (implicitly including decoding of **all** layers below this layer).
- 3.81 layer bitstream:** A single bitstream associated to a specific layer (always used in conjunction with layer qualifiers, e. g. "enhancement layer bitstream").
- 3.82 lower layer:** A relative reference to the layer immediately below a given enhancement layer (implicitly including decoding of **all** layers below this enhancement layer).
- 3.83 luminance component:** A matrix, block or single sample representing a monochrome representation of the signal and related to the primary colours in the manner defined in the bitstream. The symbol used for luminance is Y.
- 3.84 Mbit:** 1 000 000 bits.
- 3.85 macroblock:** The four 8 by 8 blocks of luminance data and the two (for 4:2:0 chrominance format), four (for 4:2:2 chrominance format) or eight (for 4:4:4 chrominance format) corresponding 8 by 8 blocks of chrominance data coming from a 16 by 16 section of the luminance component of the picture. Macroblock is sometimes used to refer to the sample data and sometimes to the coded representation of the sample values and other data elements defined in the macroblock header of the syntax defined in ITU-T Rec. H.262 | ISO/IEC 13818-2. The usage is clear from the context.
- 3.86 motion compensation:** The use of motion vectors to improve the efficiency of the prediction of sample values. The prediction uses motion vectors to provide offsets into the past and/or future reference frames or reference fields containing previously decoded sample values that are used to form the prediction error.
- 3.87 motion estimation:** The process of estimating motion vectors during the encoding process.
- 3.88 motion vector:** A two-dimensional vector used for motion compensation that provides an offset from the coordinate position in the current picture or field to the coordinates in a reference frame or reference field.
- 3.89 non-intra coding:** Coding of a macroblock or picture that uses information both from itself and from macroblocks and pictures occurring at other times.
- 3.90 opposite parity:** The opposite parity of top is bottom, and vice versa.
- 3.91 P-field picture:** A field structure P-Picture.
- 3.92 P-frame picture:** A frame structure P-Picture.
- 3.93 P-picture; predictive-coded picture:** A picture that is coded using motion compensated prediction from past reference fields or frame.
- 3.94 parameter:** A variable within the syntax of ITU-T Rec. H.262 | ISO/IEC 13818-2 which may take one of a range of values. A variable which can take one of only two values is called a flag.
- 3.95 parity (of field):** The parity of a field can be top or bottom.
- 3.96 past reference frame (field):** A past reference frame (field) is a reference frame (field) that occurs at an earlier time than the current picture in display order.
- 3.97 picture:** Source, coded or reconstructed image data. A source or reconstructed picture consists of three rectangular matrices of 8-bit numbers representing the luminance and two chrominance signals. A "coded picture" is defined in 3.21 of ITU-T Rec. H.262 | ISO/IEC 13818-2. For progressive video, a picture is identical to a frame, while for interlaced video, a picture can refer to a frame, or the top field or the bottom field of the frame depending on the context.
- 3.98 picture data:** In the VBV operations, picture data is defined as all the bits of the coded picture, all the header(s) and user data immediately preceding it if any (including any stuffing between them) and all the stuffing following it, up to (but not including) the next start code, except in the case where the next start code is an end of sequence code, in which case it is included in the picture data.
- 3.99 prediction:** The use of a predictor to provide an estimate of the sample value or data element currently being decoded.
- 3.100 prediction error:** The difference between the actual value of a sample or data element and its predictor.
- 3.101 predictor:** A linear combination of previously decoded sample values or data elements.
- 3.102 profile:** A defined subset of the syntax of ITU-T Rec. H.262 | ISO/IEC 13818-2.

NOTE – In ITU-T Rec. H.262 | ISO/IEC 13818-2, the word "profile" is used as defined above. It should not be confused with other definitions of "profile" and in particular it does not have the meaning that is defined by JTC1/SGFS.

- 3.103 progressive:** The property of film frames where all the samples of the frame represent the same instances in time.
- 3.104 quantisation matrix:** A set of sixty-four 8-bit values used by the dequantiser.
- 3.105 quantised DCT coefficients:** DCT coefficients before dequantisation. A variable length coded representation of quantised DCT coefficients is transmitted as part of the coded video bitstream.
- 3.106 quantiser scale:** A scale factor coded in the bitstream and used by the decoding process to scale the dequantisation.
- 3.107 random access:** The process of beginning to read and decode the coded bitstream at an arbitrary point.
- 3.108 reconstructed frame:** A reconstructed frame consists of three rectangular matrices of 8-bit numbers representing the luminance and two chrominance signals. A reconstructed frame is obtained by decoding a coded frame.
- 3.109 reconstructed picture:** A reconstructed picture is obtained by decoding a coded picture. A reconstructed picture is either a reconstructed frame (when decoding a frame picture), or one field of a reconstructed frame (when decoding a field picture). If the coded picture is a field picture, then the reconstructed picture is the top field or the bottom field of the reconstructed frame.
- 3.110 reference field:** A reference field is one field of a reconstructed frame. Reference fields are used for forward and backward prediction when P-pictures and B-pictures are decoded. Note that when field P-pictures are decoded, prediction of the second field P-picture of a coded frame uses the first reconstructed field of the same coded frame as a reference field.
- 3.111 reference frame:** A reference frame is a reconstructed frame that was coded in the form of a coded I-frame or a coded P-frame. Reference frames are used for forward and backward prediction when P-pictures and B-pictures are decoded.
- 3.112 re-ordering delay:** A delay in the decoding process that is caused by frame re-ordering.
- 3.113 reserved:** The term "reserved" when used in the clauses defining the coded bitstream, indicates that the value may be used in the future for ITU-T | ISO/IEC defined extensions.
- 3.114 sample aspect ratio (SAR):** This specifies the relative distance between samples. It is defined (for the purposes of ITU-T Rec. H.262 | ISO/IEC 13818-2), as the vertical displacement of the lines of luminance samples in a frame divided by the horizontal displacement of the luminance samples. Thus, its units are (metres per line) ÷ (metres per sample).
- 3.115 scalable hierarchy:** Coded video data consisting of an ordered set of more than one video bitstream.
- 3.116 scalability:** Scalability is the ability of a decoder to decode an ordered set of bitstreams to produce a reconstructed sequence. Moreover, useful video is output when subsets are decoded. The minimum subset that can thus be decoded is the first bitstream in the set which is called the base layer. Each of the other bitstreams in the set is called an enhancement layer. When addressing a specific enhancement layer, "lower layer" refer to the bitstream which precedes the enhancement layer.
- 3.117 side information:** Information in the bitstream necessary for controlling the decoder.
- 3.118 16 × 8 prediction:** A prediction mode similar to field-based prediction but where the predicted block size is 16 × 8 luminance samples.
- 3.119 run:** The number of zero coefficients preceding a non-zero coefficient, in the scan order. The absolute value of the non-zero coefficient is called "level".
- 3.120 saturation:** Limiting a value that exceeds a defined range by setting its value to the maximum or minimum of the range as appropriate.
- 3.121 skipped macroblock:** A macroblock for which no data is encoded.
- 3.122 slice:** A consecutive series of macroblocks which are all located in the same horizontal row of macroblocks.
- 3.123 SNR scalability:** A type of scalability where the enhancement layer(s) contain only coded refinement data for the DCT coefficients of the lower layer.
- 3.124 source; input:** Term used to describe the video material or some of its attributes before encoding.

- 3.125 spatial prediction:** Prediction derived from a decoded frame of the lower layer decoder used in spatial scalability.
- 3.126 spatial scalability:** A type of scalability where an enhancement layer also uses predictions from sample data derived from a lower layer without using motion vectors. The layers can have different frame sizes, frame rates or chrominance formats.
- 3.127 start codes (system and video):** 32-bit codes embedded in that coded bitstream that are unique. They are used for several purposes including identifying some of the structures in the coding syntax.
- 3.128 stuffing (bits); stuffing (bytes):** Code-words that may be inserted into the coded bitstream that are discarded in the decoding process. Their purpose is to increase the bitrate of the stream which would otherwise be lower than the desired bitrate.
- 3.129 temporal prediction:** Prediction derived from reference frames or fields other than those defined as spatial prediction.
- 3.130 temporal scalability:** A type of scalability where an enhancement layer also uses predictions from sample data derived from a lower layer using motion vectors. The layers have identical frame size, and chrominance formats, but can have different frame rates.
- 3.131 top field:** One of two fields that comprise a frame. Each line of a top field is spatially located immediately above the corresponding line of the bottom field.
- 3.132 top layer:** The topmost layer (with the highest `layer_id`) of a scalable hierarchy.
- 3.133 variable bitrate:** Operation where the bitrate varies with time during the decoding of a coded bitstream.
- 3.134 variable length coding (VLC):** A reversible procedure for coding that assigns shorter code-words to frequent events and longer code-words to less frequent events.
- 3.135 video buffering verifier (VBV):** A hypothetical decoder that is conceptually connected to the output of the encoder. Its purpose is to provide a constraint on the variability of the data rate that an encoder or editing process may produce.
- 3.136 video sequence:** The highest syntactic structure of coded video bitstreams. It contains a series of one or more coded frames.
- 3.137 xxx profile decoder:** Decoder able to decode one or a scalable hierarchy of bitstreams of which the top layer conforms to the specifications of the xxx profile (with xxx being any of the defined Profile names).
- 3.138 xxx profile scalable hierarchy:** Set of bitstreams of which the top layer conforms to the specifications of the xxx profile.
- 3.139 xxx profile bitstream:** A bitstream of a scalable hierarchy with a profile indication corresponding to xxx. Note that this bitstream is only decodable together with all its lower layer bitstreams (unless it is a base layer bitstream).
- 3.140 zigzag scanning order:** A specific sequential ordering of the DCT coefficients from (approximately) the lowest spatial frequency to the highest.

4 Abbreviations and symbols

The mathematical operators used to describe this Specification are similar to those used in the C programming language. However, integer divisions with truncation and rounding are specifically defined. Numbering and counting loops generally begin from zero.

4.1 Arithmetic operators

+	Addition
–	Subtraction (as a binary operator) or negation (as a unary operator)
++	Increment, i.e. $x++$ is equivalent to $x = x + 1$
--	Decrement, i.e. $x--$ is equivalent to $x = x - 1$
\times * }	Multiplication

^	Power
/	Integer division with truncation of the result toward zero. For example, 7/4 and -7/-4 are truncated to 1 and -7/4 and 7/-4 are truncated to -1.
//	Integer division with rounding to the nearest integer. Half-integer values are rounded away from zero unless otherwise specified. For example 3//2 is rounded to 2, and -3//2 is rounded to -2.
DIV	Integer division with truncation of the result toward minus infinity. For example 3 DIV 2 is rounded to 1, and -3 DIV 2 is rounded to -2.
÷	Used to denote division in mathematical equations where no truncation or rounding is intended.
%	Modulus operator. Defined only for positive numbers.
Sign()	$\text{Sign}(x) = \begin{cases} 1 & x > 0 \\ 0 & x == 0 \\ -1 & x < 0 \end{cases}$
Abs()	$\text{Abs}(x) = \begin{cases} x & x \geq 0 \\ -x & x < 0 \end{cases}$
$\sum_{i=a}^{i<b}$	The summation of the $f(i)$ with i taking integral values from a up to, but not including b .

4.2 Logical operators

	Logical OR
&&	Logical AND
!	Logical NOT

4.3 Relational operators

>	Greater than
>=	Greater than or equal to
<	Less than
<=	Less than or equal to
==	Equal to
!=	Not equal to
max [, ... ,]	The maximum value in the argument list
min [, ... ,]	The minimum value in the argument list

4.4 Bitwise operators

&	AND
	OR
>>	Shift right with sign extension
<<	Shift left with zero fill

4.5 Assignment

=	Assignment operator
---	---------------------

4.6 Mnemonics

The following mnemonics are defined to describe the different data types used in the coded bitstream.

bslbf	Bit string, left bit first, where "left" is the order in which bit strings are written in this Specification. Bit strings are generally written as a string of 1s and 0s within single quote marks, e.g. '1000 0001'. Blanks within a bit string are for ease of reading and have no significance. For convenience, large strings are occasionally written in hexadecimal; in this case, conversion to a binary in the conventional manner will yield the value of the bit string. Thus, the left most hexadecimal digit is first and in each hexadecimal digit the most significant of the four bits is first.
--------------	---

- uimsbf** Unsigned integer, most significant bit first.
- simsbf** Signed integer, in twos complement format, most significant (sign) bit first.
- vlcblf** Variable length code, left bit first, where "left" refers to the order in which the VLC codes are written. The byte order of multibyte words is the most significant byte first.

In the clauses describing the syntax, any syntactic element that can only take positive or unsigned values (such as a flag that can be equal to 0 or 1) is described with the mnemonic 'uimsbf'. If the syntactic element can have a negative value, it is described with the mnemonic 'simsbf'. If the syntactic element has a constant value (e.g. marker_bit) then it is described with the mnemonic 'bslbf'. If the syntactic element represents a variable-length code, it is described with the mnemonic 'vlcblf'.

4.7 Constants

- π 3,141 592 653 58...
- e 2,718 281 828 45...

5 Conventions

5.1 Method of describing bitstream syntax

The bitstream retrieved by the decoder is described in 6.2. Each data item in the bitstream is in bold type. It is described by its name, its length in bits, and a mnemonic for its type and order of transmission.

The action caused by a decoded data element in a bitstream depends on the value of that data element and on data elements previously decoded. The decoding of the data elements and definition of the state variables used in their decoding are described in 6.3. The following constructs are used to express the conditions when data elements are present, and are in normal type:

<pre>while (condition) { data_element ... }</pre>	If the condition is true, then the group of data elements occurs next in the data stream. This repeats until the condition is not true.
<pre>do { data_element ... } while (condition)</pre>	The data element always occurs at least once. The data element is repeated until the condition is not true.
<pre>if (condition) { data_element ... } else { data_element ... }</pre>	If the condition is true, then the first group of data elements occurs next in the data stream. If the condition is not true, then the second group of data elements occurs next in the data stream.
<pre>for (i = m; i < n; i++) { data_element ... }</pre>	The group of data elements occurs (m – n) times. Conditional constructs within the group of data elements may depend on the value of the loop control variable i, which is set to zero for the first occurrence, incremented by one for the second occurrence, and so forth.
<pre>/* comment ... */</pre>	Explanatory comment that may be deleted entirely without in any way altering the syntax.

This syntax uses the 'C-code' convention that a variable or expression evaluating to a non-zero value is equivalent to a condition that is true and a variable or expression evaluating to a zero value is equivalent to a condition that is false. In many cases a literal string is used in a condition. For example:

```
if ( scalable_mode == "spatial scalability" ) ...
```

In such cases the literal string is that used to describe the value of the bitstream element in 6.3. In this example, we see that "spatial scalability" is defined in Table 6-10 to be represented by the two bit binary number '01'.

ISO/IEC 13818-2 : 2000 (E)

As noted, the group of data elements may contain nested conditional constructs. For compactness, the {} are omitted when only one data element follows:

data_element [n] data_element [n] is the n + 1th element of an array of data.

data_element [m][n] data_element [m][n] is the m + 1, n + 1th element of a two-dimensional array of data.

data_element [l][m][n] data_element [l][m][n] is the l + 1, m + 1, n + 1th element of a three-dimensional array of data.

While the syntax is expressed in procedural terms, it should not be assumed that 6.2 implements a satisfactory decoding procedure. In particular, it defines a correct and error-free input bitstream. Actual decoders must include means to look for start codes in order to begin decoding correctly, and to identify errors, erasures or insertions while decoding. The methods to identify these situations, and the actions to be taken, are not standardised.

5.2 Definition of functions

Several utility functions for picture coding algorithm are defined as follows.

5.2.1 Definition of bytealigned() function

The function bytealigned () returns 1 if the current position is on a byte boundary, that is the next bit in the bitstream is the first bit in a byte. Otherwise it returns 0.

5.2.2 Definition of nextbits() function

The function nextbits () permits comparison of a bit string with the next bits to be decoded in the bitstream.

5.2.3 Definition of next_start_code() function

The next_start_code() function removes any zero bit and zero byte stuffing and locates the next start code.

next_start_code() {	No. of bits	Mnemonic
while (!bytealigned())		
zero_bit	1	'0'
while (nextbits() != '0000 0000 0000 0000 0000 0001')		
zero_byte	8	'0000 0000'
}		

This function checks whether the current position is byte aligned. If it is not, zero stuffing bits are present. After that any number of zero stuffing bytes may be present before the start code. Therefore, start codes are always byte aligned and may be preceded by any number of zero stuffing bits.

5.3 Reserved, forbidden and marker_bit

The terms "reserved" and "forbidden" are used in the description of some values of several fields in the coded bitstream.

The term "reserved" indicates that the value may be used in the future for ITU-T | ISO/IEC defined extensions.

The term "forbidden" indicates a value that shall never be used (usually in order to avoid emulation of start codes).

The term "marker_bit" indicates a one bit integer in which the value zero is forbidden (and it therefore shall have the value '1'). These marker bits are introduced at several points in the syntax to avoid start code emulation.

5.4 Arithmetic precision

In order to reduce discrepancies between implementations of this Specification, the following rules for arithmetic operations are specified:

- a) Where arithmetic precision is not specified, such as in the calculation of the IDCT, the precision shall be sufficient so that significant errors do not occur in the final integer values.
- b) Where ranges of values are given by a colon, the end points are included if a bracket is present, and excluded if the 'less than' (<) and 'greater than' (>) characters are used. For example, [a : b > means from *a* to *b*, including *a* but excluding *b*.

6 Video bitstream syntax and semantics

6.1 Structure of coded video data

Coded video data consists of an ordered set of video bitstreams, called layers. If there is only one layer, the coded video data is called non-scalable video bitstream. If there are two layers or more, the coded video data is called a scalable hierarchy.

The first layer (of the ordered set) is called base layer, and it can always be decoded independently. See 7.1 to 7.6 and 7.12 for a description of the decoding process for the base layer, except in the case of Data partitioning, described in 7.10.

Other layers are called enhancement layers, and can only be decoded together with all the lower layers (previous layers in the ordered set), starting with the base layer. See 7.7 to 7.11 for a description of the decoding process for scalable hierarchy.

See Rec. ITU-T H.222.0 | ISO/IEC 13818-1 for a description of the way layers may be multiplexed together.

The base layer of a scalable hierarchy may conform to this Specification or to other standards such as ISO/IEC 11172-2. See details in 7.7 to 7.11. Enhancement layers shall conform to this Specification.

In all cases apart from Data partitioning, the base layer does not contain a `sequence_scalable_extension()`. Enhancement layers always contain `sequence_scalable_extension()`.

In general, the video bitstream can be thought of as a syntactic hierarchy in which syntactic structures contain one or more subordinate structures. For instance, the structure "picture_data()" contains one or more of the syntactic structure "slice()" which in turn contains one or more of the structure "macroblock()".

This structure is very similar to that used in ISO/IEC 11172-2.

6.1.1 Video sequence

The highest syntactic structure of the coded video bitstream is the video sequence.

A video sequence commences with a sequence header which may optionally be followed by a group of pictures header and then by one or more coded frames. The order of the coded frames in the coded bitstream is the order in which the decoder processes them, but not necessarily in the correct order for display. The video sequence is terminated by a `sequence_end_code`. At various points in the video sequence, a particular coded frame may be preceded by either a repeat sequence header or a group of pictures header or both. (In the case that both a repeat sequence header and a group of pictures header immediately precede a particular picture, the group of pictures header shall follow the repeat sequence header.)

6.1.1.1 Progressive and interlaced sequences

This Specification deals with coding of both progressive and interlaced sequences.

The output of the decoding process, for interlaced sequences, consists of a series of reconstructed fields that are separated in time by a field period. The two fields of a frame may be coded separately (field-pictures). Alternatively the two fields may be coded together as a frame (frame-pictures). Both frame pictures and field pictures may be used in a single video sequence.

In progressive sequences each picture in the sequence shall be a frame picture. The sequence, at the output of the decoding process, consists of a series of reconstructed frames that are separated in time by a frame period.

6.1.1.2 Frame

A frame consists of three rectangular matrices of integers: a luminance matrix (Y), and two chrominance matrices (Cb and Cr).

The relationship between these Y, Cb and Cr components and the primary (analogue) Red, Green and Blue Signals (E'_R , E'_G and E'_B), the chromaticity of these primaries and the transfer characteristics of the source frame may be specified in the bitstream (or specified by some other means). This information does not affect the decoding process.

6.1.1.3 Field

A field consists of every other line of samples in the three rectangular matrices of integers representing a frame.

A frame is the union of a top field and a bottom field. The top field is the field that contains the top-most line of each of the three matrices. The bottom field is the other one.

6.1.1.4 Picture

A coded picture is made of a picture header, the optional extensions immediately following it and the following picture data. A coded picture may be a coded frame or a coded field.

An I-frame picture or a pair of field pictures, where the first field picture is an I-picture and the second field picture is an I-picture or a P-picture, is called a coded I-frame.

A P-frame picture or a pair of P-field pictures is called a coded P-frame.

A B-frame picture or a pair of B-field pictures is called a coded B-frame.

A coded I-frame, a coded P-frame or a coded B-frame is called a coded frame.

A reconstructed picture is obtained by decoding a coded picture, i.e. a picture header, the optional extensions immediately following it, and the picture data. A coded picture may be a frame picture or a field picture. A reconstructed picture is either a reconstructed frame (when decoding a frame picture), or one field of a reconstructed frame (when decoding a field picture).

6.1.1.4.1 Field pictures

If field pictures are used, then they shall occur in pairs (one top field followed by one bottom field, or one bottom field followed by one top field) and together constitute a coded frame. The two field pictures that comprise a coded frame shall be encoded in the bitstream in the order in which they shall occur at the output of the decoding process.

When the first picture of the coded frame is a P-field picture, then the second picture of the coded frame shall also be a P-field picture. Similarly when the first picture of the coded frame is a B-field picture the second picture of the coded frame shall also be a B-field picture.

When the first picture of the coded frame is a I-field picture, then the second picture of the frame shall be either an I-field picture or a P-field picture. If the second picture is a P-field picture, then certain restrictions apply (see 7.6.3.5).

6.1.1.4.2 Frame pictures

When coding interlaced sequences using frame pictures, the two fields of the frame shall be interleaved with one another and then the entire frame is coded as a single frame-picture.

6.1.1.5 Picture types

There are three types of pictures that use different coding methods:

- an **Intra-coded (I) picture** is coded using information only from itself;
- a **Predictive-coded (P) picture** is a picture which is coded using motion compensated prediction from a past reference frame or past reference field;
- a **Bidirectionally predictive-coded (B) picture** is a picture which is coded using motion compensated prediction from a past and/or future reference frame(s).

6.1.1.6 Sequence header

A video sequence header commences with a `sequence_header_code` and is followed by a series of data elements. In this Specification, `sequence_header()` shall be followed by `sequence_extension()` which includes further parameters beyond those used by ISO/IEC 11172-2. When `sequence_extension()` is present, the syntax and semantics defined in ISO/IEC 11172-2 do not apply, and the present Specification applies.

In repeat sequence headers all of the data elements with the permitted exception of those defining the quantisation matrices (`load_intra_quantiser_matrix`, `load_non_intra_quantiser_matrix` and optionally `intra_quantiser_matrix` and `non_intra_quantiser_matrix`) shall have the same values as in the first sequence header. The quantisation matrices may be redefined each time that a sequence header occurs in the bitstream (note that quantisation matrices may also be updated using `quant_matrix_extension()`).

All of the data elements in the `sequence_extension()` that follows a `repeat_sequence_header()` shall have the same values as in the first `sequence_extension()`.

If a `sequence_scalable_extension()` occurs after the first `sequence_header()` all subsequent sequence headers shall be followed by `sequence_scalable_extension()` in which all data elements are the same as in the first `sequence_scalable_extension()`. Conversely if no `sequence_scalable_extension()` occurs between the first `sequence_header()` and the first `picture_header()`, then `sequence_scalable_extension()` shall not occur in the bitstream.

If a `sequence_display_extension()` occurs after the first `sequence_header()` all subsequent sequence headers shall be followed by `sequence_display_extension()` in which all data elements are the same as in the first `sequence_display_extension()`. Conversely if no `sequence_display_extension()` occurs between the first `sequence_header()` and the first `picture_header()`, then `sequence_display_extension()` shall not occur in the bitstream.

Repeating the sequence header allows the data elements of the initial sequence header to be repeated in order that random access into the video sequence is possible.

In the coded bitstream, the first picture following a sequence header or a repeated sequence header shall be either an I-picture or a P-picture, but not a B-picture. In the case that an interlaced frame is coded as two separate field pictures, a repeat sequence header shall not precede the second of these two field pictures.

If a bitstream is edited so that all of the data preceding any of the repeat sequence headers is removed (or alternatively random access is made to that sequence header), then the resulting bitstream shall be a legal bitstream that complies with this Specification. In the case that the first picture of the resulting bitstream is a P-picture, it is possible that it will contain non-intra macroblocks. Since the reference picture(s) required by the decoding process are not available, the reconstructed picture may not be fully defined. The time taken to fully refresh the entire frame depends on the refresh techniques employed.

6.1.1.7 I-pictures and group of pictures header

I-pictures are intended to assist random access into the sequence. Applications requiring random access, fast-forward playback, or fast reverse playback may use I-pictures relatively frequently.

I-pictures may also be used at scene cuts or other cases where motion compensation is ineffective.

Group of picture header is an optional header that can be used immediately before a coded I-frame to indicate to the decoder if the first consecutive B-pictures immediately following the coded I-frame can be reconstructed properly in the case of a random access. In effect, if the preceding reference frame is not available, those B-pictures, if any, cannot be reconstructed properly unless they only use backward prediction or intra coding. This is more precisely defined in the clause describing `closed_gop` and `broken_link`. A group of picture header also contains a time code information that is not used by the decoding process.

In the coded bitstream, the first coded frame following a group of pictures header shall be a coded I-frame.

6.1.1.8 4:2:0 format

In this format the Cb and Cr matrices shall be one half the size of the Y-matrix in both horizontal and vertical dimensions. The Y-matrix shall have an even number of lines and samples.

NOTE – When interlaced frames are coded as field pictures, the picture reconstructed from each of these field pictures shall have a Y-matrix with half the number of lines as the corresponding frame. Thus, the total number of lines in the Y-matrix of an entire frame shall be divisible by four.

The luminance and chrominance samples are positioned as shown in Figure 6-1.

In order to further specify the organisation, Figures 6-2 and 6-3 show the vertical and temporal positioning of the samples in an interlaced frame. Figure 6-4 shows the vertical and temporal positioning of the samples in a progressive frame.

In each field of an interlaced frame, the chrominance samples do not lie (vertically) midway between the luminance samples of the field, this is so that the spatial location of the chrominance samples in the frame is the same whether the frame is represented as a single frame-picture or two field-pictures.

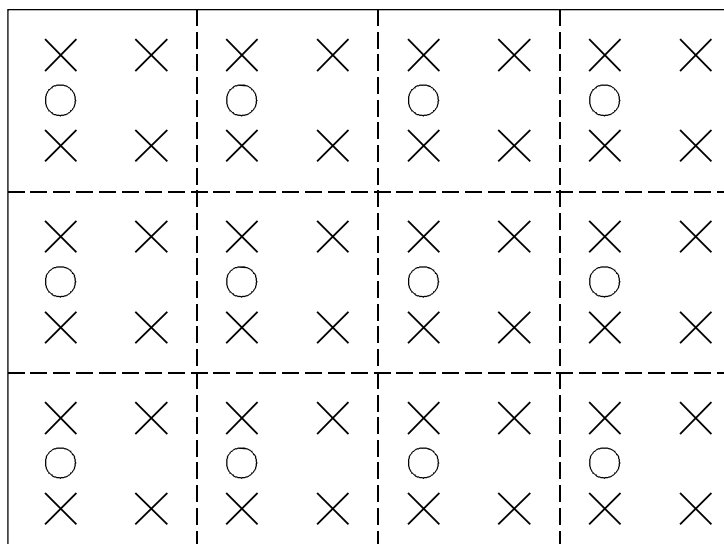

T1515950-94/d02

- X Represents luminance samples
- O Represents chrominance samples

Figure 6-1 – The position of luminance and chrominance samples – 4:2:0 data

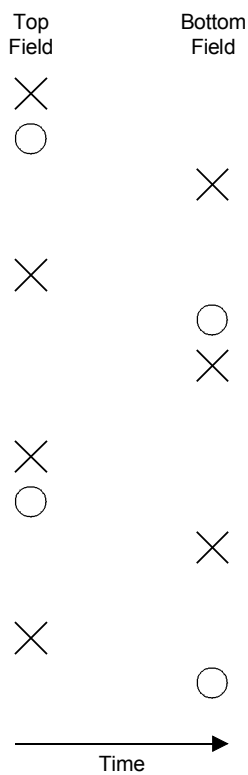

T1515960-94/d03

Figure 6-2 – Vertical and temporal positions of samples in an interlaced frame with top_field_first = 1

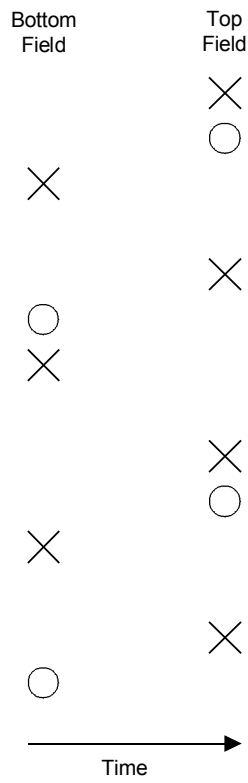

T1515970-94/d04

Figure 6-3 – Vertical and temporal positions of samples in an interlaced frame with top_field_first = 0

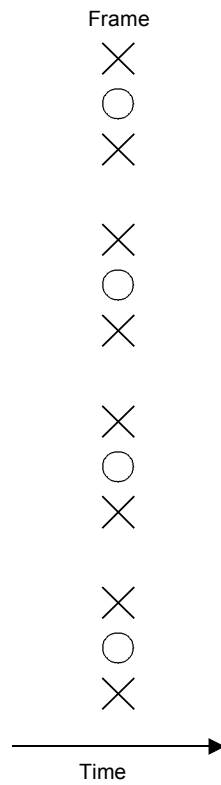

T1515980-94/d05

Figure 6-4 – Vertical and temporal positions of samples in a progressive frame

6.1.1.9 4:2:2 format

In this format the Cb and Cr matrices shall be one half the size of the Y-matrix in the horizontal dimension and the same size as the Y-matrix in the vertical dimension. The Y-matrix shall have an even number of samples.

NOTE – When interlaced frames are coded as field pictures, the picture reconstructed from each of these field pictures shall have a Y-matrix with half the number of lines as the corresponding frame. Thus the total number of lines in the Y-matrix of an entire frame shall be divisible by two.

The luminance and chrominance samples are positioned as shown in Figure 6-5.

In order to clarify the organisation, Figure 6-6 shows the (vertical) positioning of the samples when the frame is separated into two fields.

6.1.1.10 4:4:4 format

In this format the Cb and Cr matrices shall be the same size as the Y-matrix in the horizontal and the vertical dimensions.

NOTE – When interlaced frames are coded as field pictures, the picture reconstructed from each of these field pictures shall have a Y-matrix with half the number of lines as the corresponding frame. Thus the total number of lines in the Y-matrix of an entire frame shall be divisible by two.

The luminance and chrominance samples are positioned as shown in Figures 6-6 and 6-7.

6.1.1.11 Frame re-ordering

When the sequence contains coded B-frames, the number of consecutive coded B-frames is variable and unbounded. The first coded frame after a sequence header shall not be a B-frame.

A sequence may contain no coded P-frames. A sequence may also contain no coded I-frames in which case some care is required at the start of the sequence and within the sequence to effect both random access and error recovery.

The order of the coded frames in the bitstream, also called coded order, is the order in which a decoder reconstructs them. The order of the reconstructed frames at the output of the decoding process, also called the display order, is not always the same as the coded order and this subclause defines the rules of frame re-ordering that shall happen within the decoding process.

When the sequence contains no coded B-frames, the coded order is the same as the display order. This is true in particular always when low_delay is one.

When B-frames are present in the sequence, re-ordering is performed according to the following rules:

- If the current frame in coded order is a B-frame, the output frame is the frame reconstructed from that B-frame.
- If the current frame in coded order is a I-frame or P-frame, the output frame is the frame reconstructed from the previous I-frame or P-frame if one exists. If none exists, at the start of the sequence, no frame is output.

The frame reconstructed from the final I-frame or P-frame is output immediately after the frame reconstructed when the last coded frame in the sequence was removed from the VBV buffer.

The following is an example of frames taken from the beginning of a video sequence. In this example there are two coded B-frames between successive coded P-frames and also two coded B-frames between successive coded I- and P-frames and all pictures are frame-pictures. Frame '1I' is used to form a prediction for frame '4P'. Frames '4P' and '1I' are both used to form predictions for frames '2B' and '3B'. Therefore the order of coded frames in the coded sequence shall be '1I', '4P', '2B', '3B'. However, the decoder shall display them in the order '1I', '2B', '3B', '4P'.

At the encoder input:

1	2	3	4	5	6	7	8	9	10	11	12	13
I	B	B	P	B	B	P	B	B	I	B	B	P

At the encoder output, in the coded bitstream, and at the decoder input:

1	4	2	3	7	5	6	10	8	9	13	11	12
I	P	B	B	P	B	B	I	B	B	P	B	B

At the decoder output:

1	2	3	4	5	6	7	8	9	10	11	12	13
---	---	---	---	---	---	---	---	---	----	----	----	----

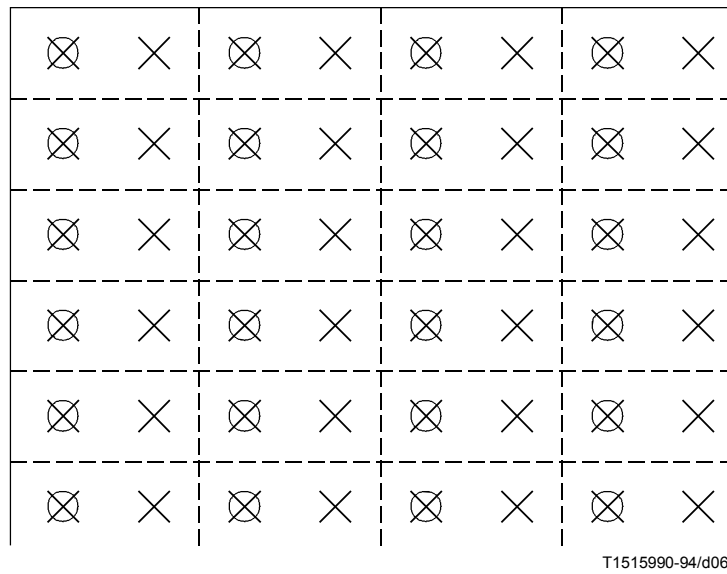

Represents luminance samples
 Represents chrominance samples

Figure 6-5 – The position of luminance and chrominance samples – 4:2:2 data

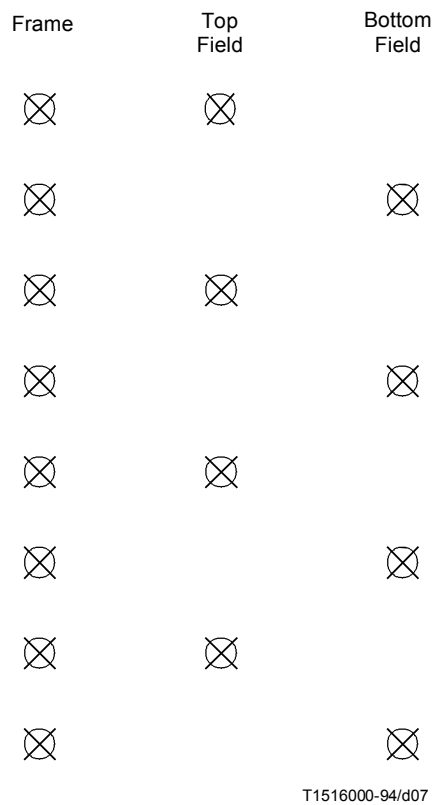
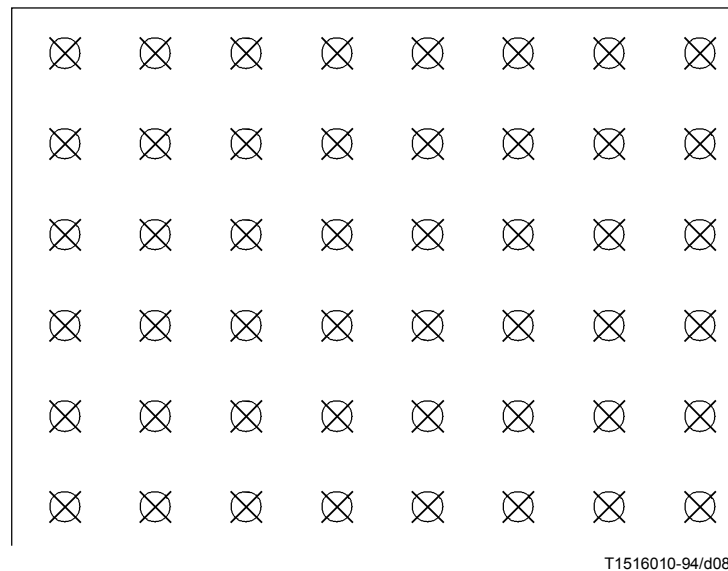

Figure 6-6 – Vertical positions of samples with 4:2:2 and 4:4:4 data



Represents luminance samples
 Represents chrominance samples

Figure 6-7 – The position of luminance and chrominance samples – 4:4:4 data

6.1.2 Slice

A **slice** is a series of an arbitrary number of consecutive macroblocks. The first and last macroblocks of a slice shall not be skipped macroblocks. Every slice shall contain at least one macroblock. Slices shall not overlap. The position of slices may change from picture to picture.

The first and last macroblock of a slice shall be in the same horizontal row of macroblocks.

Slices shall occur in the bitstream in the order in which they are encountered, starting at the upper-left of the picture and proceeding by raster-scan order from left to right and top to bottom (illustrated in Figures 6-8 and 6-9 as alphabetical order).

6.1.2.1 The general slice structure

In the most general case it is not necessary for the slices to cover the entire picture. Figure 6-8 shows this case. Those areas that are not enclosed in a slice are not encoded and no information is encoded for such areas (in the specific picture).

If the slices do not cover the entire picture, then it is a requirement that if the picture is subsequently used to form predictions, then predictions shall only be made from those regions of the picture that were enclosed in slices. It is the responsibility of the encoder to ensure this.

This Specification does not define what action a decoder shall take in the regions between the slices.

6.1.2.2 Restricted slice structure

In certain defined levels of defined profiles a restricted slice structure illustrated in Figure 6-9 shall be used. In this case every macroblock in the picture shall be enclosed in a slice.

Where a defined level of a defined profile requires that the slice structure obeys the restrictions detailed in this subclause, the term "restricted slice structure" may be used.

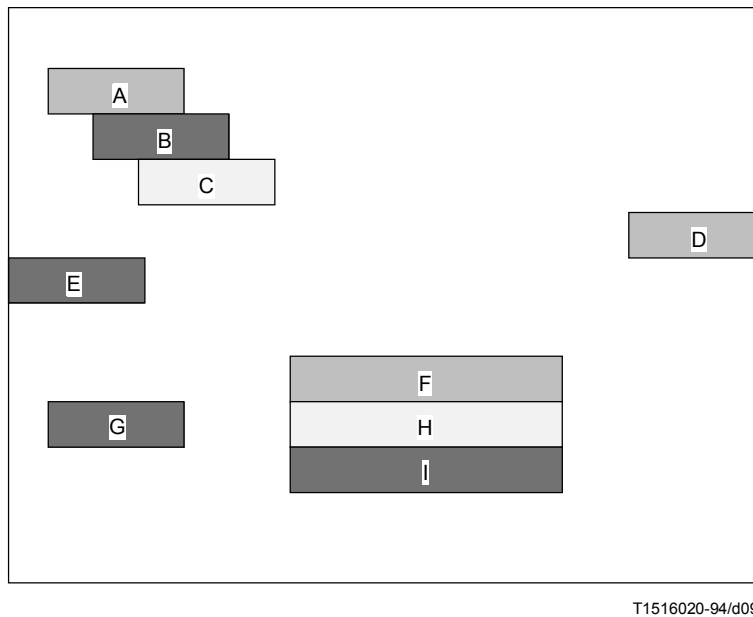

Figure 6-8 – The most general slice structure

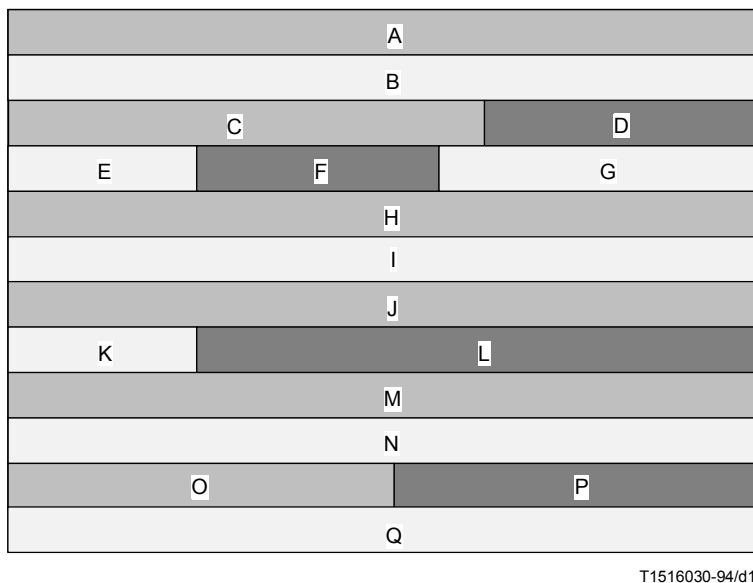

Figure 6-9 – Restricted slice structure

6.1.3 Macroblock

A **macroblock** contains a section of the luminance component and the spatially corresponding chrominance components. The term macroblock can either refer to source and decoded data or to the corresponding coded data elements. A skipped macroblock is one for which no information is transmitted (see 7.6.6). There are three chrominance formats for a macroblock, namely, 4:2:0, 4:2:2 and 4:4:4 formats. The orders of blocks in a macroblock shall be different for each different chrominance format and are illustrated below.

A 4:2:0 Macroblock consists of 6 blocks. This structure holds 4 Y, 1 Cb and 1 Cr Blocks and the block order is depicted in Figure 6-10.

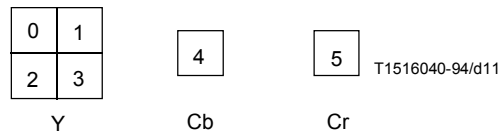

Figure 6-10 – 4:2:0 Macroblock structure

A 4:2:2 Macroblock consists of 8 blocks. This structure holds 4 Y, 2 Cb and 2 Cr Blocks and the block order is depicted in Figure 6-11.

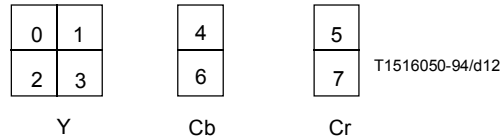

Figure 6-11 – 4:2:2 Macroblock structure

A 4:4:4 Macroblock consists of 12 blocks. This structure holds 4 Y, 4 Cb and 4 Cr Blocks and the block order is depicted in Figure 6-12.

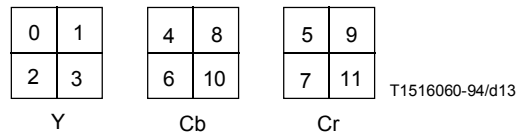

Figure 6-12 – 4:4:4 Macroblock structure

In frame pictures, where both frame and field DCT coding may be used, the internal organisation within the macroblock is different in each case.

- In the case of frame DCT coding, each block shall be composed of lines from the two fields alternately. This is illustrated in Figure 6-13.
- In the case of field DCT coding, each block shall be composed of lines from only one of the two fields. This is illustrated in Figure 6-14.

In the case of chrominance blocks the structure depends upon the chrominance format that is being used. In the case of 4:2:2 and 4:4:4 formats (where there are two blocks in the vertical dimension of the macroblock) the chrominance blocks are treated in exactly the same manner as the luminance blocks. However, in the 4:2:0 format the chrominance blocks shall always be organised in frame structure for the purposes of DCT coding. It should, however, be noted that field based predictions may be made for these blocks which will, in the general case, require that predictions for 8×4 regions (after half-sample filtering) must be made.

In field pictures, each picture only contains lines from one of the fields. In this case each block consists of lines taken from successive lines in the picture as illustrated by Figure 6-13.

6.1.4 Block

The term "block" can refer either to source and reconstructed data or to the DCT coefficients or to the corresponding coded data elements.

When "block" refers to source and reconstructed data it refers to an orthogonal section of a luminance or chrominance component with the same number of lines and samples. There are 8 lines and 8 samples in the block.

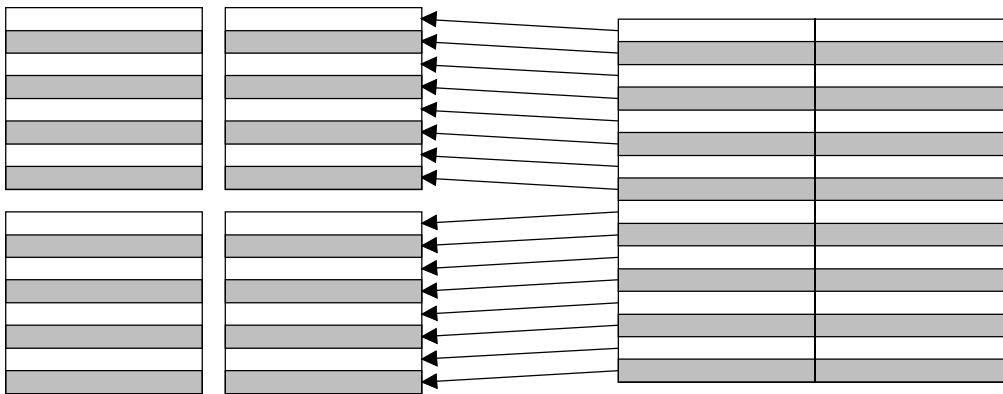

T1520180-95/d14

Figure 6-13 – Luminance macroblock structure in frame DCT coding

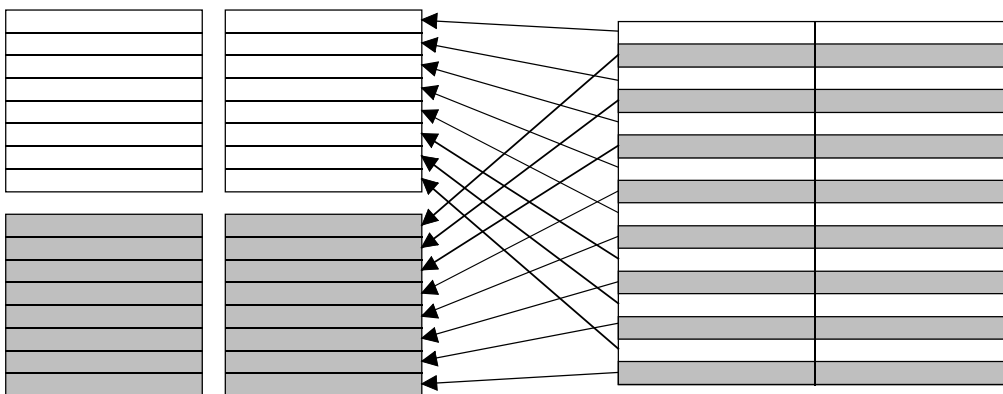

T1520190-95/d15

Figure 6-14 – Luminance macroblock structure in field DCT coding

6.2 Video bitstream syntax

6.2.1 Start codes

Start codes are specific bit patterns that do not otherwise occur in the video stream.

Each start code consists of a start code prefix followed by a start code value. The start code prefix is a string of twenty three bits with the value zero followed by a single bit with the value one. The start code prefix is thus the bit string '0000 0000 0000 0000 0000 0001'.

The start code value is an eight bit integer which identifies the type of start code. Most types of start code have just one start code value. However, `slice_start_code` is represented by many start code values, in this case the start code value is the `slice_vertical_position` for the slice.

All start codes shall be byte aligned. This shall be achieved by inserting bits with the value zero before the start code prefix such that the first bit of the start code prefix is the first (most significant) bit of a byte.

Table 6-1 defines the start code values for the start codes used in the video bitstream.

The use of the start codes is defined in the following syntax description with the exception of the `sequence_error_code`. The `sequence_error_code` has been allocated for use by a media interface to indicate where uncorrectable errors have been detected.

Table 6-1 – Start code values

Name	Start code value (hexadecimal)
picture_start_code	00
slice_start_code	01 through AF
reserved	B0
reserved	B1
user_data_start_code	B2
sequence_header_code	B3
sequence_error_code	B4
extension_start_code	B5
reserved	B6
sequence_end_code	B7
group_start_code	B8
system start codes (Note)	B9 through FF
NOTE – System start codes are defined in Part 1 of this Specification.	

6.2.2 Video Sequence

video_sequence() {	No. of bits	Mnemonic
next_start_code()		
sequence_header()		
if (nextbits() == extension_start_code) {		
sequence_extension()		
do {		
extension_and_user_data(0)		
do {		
if (nextbits() == group_start_code) {		
group_of_pictures_header()		
extension_and_user_data(1)		
}		
picture_header()		
picture_coding_extension()		
extensions_and_user_data(2)		
picture_data()		
} while ((nextbits() == picture_start_code)		
(nextbits() == group_start_code))		
if (nextbits() != sequence_end_code) {		
sequence_header()		
sequence_extension()		
}		
} while (nextbits() != sequence_end_code)		
} else {		
/* ISO/IEC 11172-2 */		
}		
sequence_end_code	32	bslbf
}		

6.2.2.1 Sequence header

sequence_header() {	No. of bits	Mnemonic
sequence_header_code	32	bslbf
horizontal_size_value	12	uimsbf
vertical_size_value	12	uimsbf
aspect_ratio_information	4	uimsbf
frame_rate_code	4	uimsbf
bit_rate_value	18	uimsbf
marker_bit	1	bslbf
vbv_buffer_size_value	10	uimsbf
constrained_parameters_flag	1	bslbf
load_intra_quantiser_matrix	1	uimsbf
if (load_intra_quantiser_matrix)		
intra_quantiser_matrix[64]	8*64	uimsbf
load_non_intra_quantiser_matrix	1	uimsbf
if (load_non_intra_quantiser_matrix)		
non_intra_quantiser_matrix[64]	8*64	uimsbf
next_start_code()		
}		

6.2.2.2 Extension and user data

extension_and_user_data(i) {	No. of bits	Mnemonic
while ((nextbits() == extension_start_code)		
(nextbits() == user_data_start_code)) {		
if ((i != 1) && (nextbits() == extension_start_code))		
extension_data(i)		
if (nextbits() == user_data_start_code)		
user_data()		
}		
}		

6.2.2.2.1 Extension data

extension_data(i) {	No. of bits	Mnemonic
while (nextbits()== extension_start_code) {		
extension_start_code	32	bslbf
if(i == 0) { /* follows sequence_extension() */		
if(nextbits()== "Sequence Display Extension ID")		
sequence_display_extension()		
else if(nextbits()		
== "Sequence Scalable Extension ID")		
sequence_scalable_extension()		
}		
/* NOTE – i never takes the value 1 because extension_data()		
never follows a group_of_pictures_header() */		
if(i == 2) { /* follows picture_coding_extension() */		
if(nextbits() == "Quant Matrix Extension ID")		
quant_matrix_extension()		
else if(nextbits() == "Copyright Extension ID")		
copyright_extension()		
else if(nextbits() == "Picture Display Extension ID")		
picture_display_extension()		
else if(nextbits()		
== "Picture Spatial Scalable Extension ID")		
picture_spatial_scalable_extension()		
else if(nextbits()		
== "Picture Temporal Scalable Extension ID")		
picture_temporal_scalable_extension()		
else if(nextbits()		
== "Camera Parameters Extension ID")		
camera_parameters_extension()		
else if(nextbits()		
== "ITU-T Extension ID")		
ITU-T_extension()		
}		
}		
}		

6.2.2.2 User data

	No. of bits	Mnemonic
user_data() {		
user_data_start_code	32	bslbf
while(nextbits() != '0000 0000 0000 0000 0000 0001') {		
user_data	8	uimsbf
}		
next_start_code()		
}		

6.2.2.3 Sequence extension

	No. of bits	Mnemonic
sequence_extension() {		
extension_start_code	32	bslbf
extension_start_code_identifier	4	uimsbf
profile_and_level_indication	8	uimsbf
progressive_sequence	1	uimsbf
chroma_format	2	uimsbf
horizontal_size_extension	2	uimsbf
vertical_size_extension	2	uimsbf
bit_rate_extension	12	uimsbf
marker_bit	1	bslbf
vbv_buffer_size_extension	8	uimsbf
low_delay	1	uimsbf
frame_rate_extension_n	2	uimsbf
frame_rate_extension_d	5	uimsbf
next_start_code()		
}		

6.2.2.4 Sequence display extension

sequence_display_extension() {	No. of bits	Mnemonic
extension_start_code_identifier	4	uimsbf
video_format	3	uimsbf
colour_description	1	uimsbf
if (colour_description) {		
colour_primaries	8	uimsbf
transfer_characteristics	8	uimsbf
matrix_coefficients	8	uimsbf
}		
display_horizontal_size	14	uimsbf
marker_bit	1	bslbf
display_vertical_size	14	uimsbf
next_start_code()		
}		

6.2.2.5 Sequence scalable extension

sequence_scalable_extension() {	No. of bits	Mnemonic
extension_start_code_identifier	4	uimsbf
scalable_mode	2	uimsbf
layer_id	4	uimsbf
if (scalable_mode == "spatial scalability") {		
lower_layer_prediction_horizontal_size	14	uimsbf
marker_bit	1	bslbf
lower_layer_prediction_vertical_size	14	uimsbf
horizontal_subsampling_factor_m	5	uimsbf
horizontal_subsampling_factor_n	5	uimsbf
vertical_subsampling_factor_m	5	uimsbf
vertical_subsampling_factor_n	5	uimsbf
}		
if (scalable_mode == "temporal scalability") {		
picture_mux_enable	1	uimsbf
if (picture_mux_enable)		
mux_to_progressive_sequence	1	uimsbf
picture_mux_order	3	uimsbf
picture_mux_factor	3	uimsbf
}		
next_start_code()		
}		

6.2.2.6 Group of pictures header

group_of_pictures_header() {	No. of bits	Mnemonic
group_start_code	32	bslbf
time_code	25	uimsbf
closed_gop	1	uimsbf
broken_link	1	uimsbf
next_start_code()		
}		

6.2.3 Picture header

picture_header() {	No. of bits	Mnemonic
picture_start_code	32	bslbf
temporal_reference	10	uimsbf
picture_coding_type	3	uimsbf
vbv_delay	16	uimsbf
if (picture_coding_type == 2 picture_coding_type == 3) {		
full_pel_forward_vector	1	bslbf
forward_f_code	3	bslbf
}		
if (picture_coding_type == 3) {		
full_pel_backward_vector	1	bslbf
backward_f_code	3	bslbf
}		
while (nextbits() == '1') {		
extra_bit_picture /* with the value '1' */	1	uimsbf
extra_information_picture	8	uimsbf
}		
extra_bit_picture /* with the value '0' */	1	uimsbf
next_start_code()		
}		

6.2.3.1 Picture coding extension

picture_coding_extension() {	No . of bits	Mnemonic
extension_start_code	32	bslbf
extension_start_code_identifier	4	uimsbf
f_code[0][0] /* forward horizontal */	4	uimsbf
f_code[0][1] /* forward vertical */	4	uimsbf
f_code[1][0] /* backward horizontal */	4	uimsbf
f_code[1][1] /* backward vertical */	4	uimsbf
intra_dc_precision	2	uimsbf
picture_structure	2	uimsbf
top_field_first	1	uimsbf
frame_pred_frame_dct	1	uimsbf
concealment_motion_vectors	1	uimsbf
q_scale_type	1	uimsbf
intra_vlc_format	1	uimsbf
alternate_scan	1	uimsbf
repeat_first_field	1	uimsbf
chroma_420_type	1	uimsbf
progressive_frame	1	uimsbf
composite_display_flag	1	uimsbf
if (composite_display_flag) {		
v_axis	1	uimsbf
field_sequence	3	uimsbf
sub_carrier	1	uimsbf
burst_amplitude	7	uimsbf
sub_carrier_phase	8	uimsbf
}		
next_start_code()		
}		

6.2.3.2 Quant matrix extension

quant_matrix_extension() {	No. of bits	Mnemonic
extension_start_code_identifier	4	uimsbf
load_intra_quantiser_matrix	1	uimsbf
if (load_intra_quantiser_matrix)		
intra_quantiser_matrix[64]	8 * 64	uimsbf
load_non_intra_quantiser_matrix	1	uimsbf
if (load_non_intra_quantiser_matrix)		
non_intra_quantiser_matrix[64]	8 * 64	uimsbf
load_chroma_intra_quantiser_matrix	1	uimsbf
if (load_chroma_intra_quantiser_matrix)		
chroma_intra_quantiser_matrix[64]	8 * 64	uimsbf
load_chroma_non_intra_quantiser_matrix	1	uimsbf
if (load_chroma_non_intra_quantiser_matrix)		
chroma_non_intra_quantiser_matrix[64]	8 * 64	uimsbf
next_start_code()		
}		

6.2.3.3 Picture display extension

picture_display_extension() {	No. of bits	Mnemonic
extension_start_code_identifier	4	uimsbf
for (i = 0; i < number_of_frame_centre_offsets; i ++) {		
frame_centre_horizontal_offset	16	simsbf
marker_bit	1	bslbf
frame_centre_vertical_offset	16	simsbf
marker_bit	1	bslbf
}		
next_start_code()		
}		

6.2.3.4 Picture temporal scalable extension

picture_temporal_scalable_extension() {	No. of bits	Mnemonic
extension_start_code_identifier	4	uimsbf
reference_select_code	2	uimsbf
forward_temporal_reference	10	uimsbf
marker_bit	1	bslbf
backward_temporal_reference	10	uimsbf
next_start_code()		
}		

6.2.3.5 Picture spatial scalable extension

picture_spatial_scalable_extension() {	No. of bits	Mnemonic
extension_start_code_identifier	4	uimsbf
lower_layer_temporal_reference	10	uimsbf
marker_bit	1	bslbf
lower_layer_horizontal_offset	15	simsbf
marker_bit	1	bslbf
lower_layer_vertical_offset	15	simsbf
spatial_temporal_weight_code_table_index	2	uimsbf
lower_layer_progressive_frame	1	uimsbf
lower_layer_deinterlaced_field_select	1	uimsbf
next_start_code()		
}		

6.2.3.6 Copyright extension

copyright_extension() {	No. of bits	Mnemonic
extension_start_code_identifier	4	uimsbf
copyright_flag	1	uimsbf
copyright_identifier	8	uimsbf
original_or_copy	1	uimsbf
reserved	7	bslbf
marker_bit	1	bslbf
copyright_number_1	20	uimsbf
marker_bit	1	bslbf
copyright_number_2	22	uimsbf
marker_bit	1	bslbf
copyright_number_3	22	uimsbf
next_start_code()		
}		

6.2.3.7 Picture data

picture_data() {	No. of bits	Mnemonic
do {		
slice()		
} while (nextbits() == slice_start_code)		
next_start_code()		
}		

6.2.3.7.1 Camera parameters extension

camera_parameters_extension() {	No. of bits	Mnemonic
extension_start_code_identifier	4	uimsbf
reserved	1	uimsbf
camera_id	7	simsbf
marker_bit	1	bslbf
height_of_image_device	22	uimsbf
marker_bit	1	bslbf
focal_length	22	uimsbf
marker_bit	1	bslbf
f_number	22	uimsbf
marker_bit	1	bslbf
vertical_angle_of_view	22	uimsbf
marker_bit	1	bslbf
camera_position_x_upper	16	simsbf
marker_bit	1	bslbf
camera_position_x_lower	16	
marker_bit	1	bslbf
camera_position_y_upper	16	simsbf
marker_bit	1	bslbf
camera_position_y_lower	16	
marker_bit	1	bslbf
camera_position_z_upper	16	simsbf
marker_bit	1	bslbf
camera_position_z_lower	16	
marker_bit	1	bslbf
camera_direction_x	22	simsbf
marker_bit	1	bslbf
camera_direction_y	22	simsbf
marker_bit	1	bslbf
camera_direction_z	22	simsbf
marker_bit	1	bslbf
image_plane_vertical_x	22	simsbf
marker_bit	1	bslbf
image_plane_vertical_y	22	simsbf
marker_bit	1	bslbf
image_plane_vertical_z	22	simsbf
marker_bit	1	bslbf
reserved	32	bslbf
next_start_code()		
}		
NOTE – The parameters marked 'reserved' in the camera parameters extension shall be equal to zero. Other values are reserved for future use by ITU-T ISO/IEC.		

6.2.3.7.2 ITU-T extension

ITU-T_extension() {	No. of bits	Mnemonic
extension_start_code_identifier	4	uimsbf
while(nextbits() != '0000 0000 0000 0000 0000 0001') {		
ITU-T_data	1	uimsbf
}		
next_start_code()		
}		
NOTE – The construct with the while-statement prevents start code emulation.		

6.2.4 Slice

slice() {	No. of bits	Mnemonic
slice_start_code	32	bslbf
if(vertical_size > 2800)		
slice_vertical_position_extension	3	uimsbf
if (<sequence_scalable_extension() is present in the bitstream>) {		
if(scalable_mode == 'data partitioning')		
priority_breakpoint	7	uimsbf
}		
quantiser_scale_code	5	uimsbf
if(nextbits() == '1') {		
slice_extension_flag	1	bslbf
intra_slice	1	uimsbf
slice_picture_id_enable	1	uimsbf
slice_picture_id	6	uimsbf
while(nextbits() == '1') {		
extra_bit_slice /* with the value '1' */	1	uimsbf
extra_information_slice	8	uimsbf
}		
}		
extra_bit_slice /* with the value '0' */	1	uimsbf
do {		
macroblock()		
} while(nextbits() != '000 0000 0000 0000 0000 0000')		
next_start_code()		
}		

6.2.5 Macroblock

	No. of bits	Mnemonic
macroblock() {		
while (nextbits() == '0000 0001 000')		
macroblock_escape	11	bslbf
macroblock_address_increment	1-11	vlclbf
macroblock_modes()		
if (macroblock_quant)		
quantiser_scale_code	5	uimsbf
if (macroblock_motion_forward		
(macroblock_intra && concealment_motion_vectors)		
motion_vectors(0)		
if (macroblock_motion_backward)		
motion_vectors(1)		
if (macroblock_intra && concealment_motion_vectors)		
marker_bit	1	bslbf
if (macroblock_pattern)		
coded_block_pattern()		
for (i = 0; i < block_count; i ++) {		
block(i)		
}		
}		

6.2.5.1 Macroblock modes

macroblock_modes() {	No. of bits	Mnemonic
macroblock_type	1-9	vlclbf
if ((spatial_temporal_weight_code_flag == 1) && (spatial_temporal_weight_code_table_index != '00')) {		
spatial_temporal_weight_code	2	uimsbf
}		
if (macroblock_motion_forward macroblock_motion_backward) {		
if (picture_structure == 'frame') {		
if (frame_pred_frame_dct == 0)		
frame_motion_type	2	uimsbf
} else {		
field_motion_type	2	uimsbf
}		
}		
if ((picture_structure == "Frame picture") && (frame_pred_frame_dct == 0) && (macroblock_intra macroblock_pattern)) {		
dct_type	1	uimsbf
}		
}		

6.2.5.2 Motion vectors

motion_vectors (s) {	No. of bits	Mnemonic
if (motion_vector_count == 1) {		
if ((mv_format == field) && (dmvc != 1))		
motion_vertical_field_select[0][s]	1	uimsbf
motion_vector(0, s)		
} else {		
motion_vertical_field_select[0][s]	1	uimsbf
motion_vector(0, s)		
motion_vertical_field_select[1][s]	1	uimsbf
motion_vector(1, s)		
}		
}		

6.2.5.2.1 Motion vector

motion_vector (r, s) {	No. of bits	Mnemonic
motion_code[r][s][0]	1-11	vlclbf
if ((f_code[s][0] != 1) && (motion_code[r][s][0] != 0))		
motion_residual[r][s][0]	1-8	uimsbf
if (dmv == 1)		
dmvector[0]	1-2	vlclbf
motion_code[r][s][1]	1-11	vlclbf
if ((f_code[s][1] != 1) && (motion_code[r][s][1] != 0))		
motion_residual[r][s][1]	1-8	uimsbf
if (dmv == 1)		
dmvector[1]	1-2	vlclbf
}		

6.2.5.3 Coded block pattern

coded_block_pattern () {	No. of bits	Mnemonic
coded_block_pattern_420	3-9	vlclbf
if (chroma_format == 4:2:2)		
coded_block_pattern_1	2	uimsbf
if (chroma_format == 4:4:4)		
coded_block_pattern_2	6	uimsbf
}		

6.2.6 Block

The detailed syntax for the terms "First DCT coefficient", "Subsequent DCT coefficient" and "End of Block" is fully described in 7.2.

This subclause does not adequately document the block layer syntax when data partitioning is used. See 7.10.

block(i) {	No. of bits	Mnemonic
if (pattern_code[i]) {		
if (macroblock_intra) {		
if (i < 4) {		
dct_dc_size_luminance	2-9	vlclbf
if(dct_dc_size_luminance != 0)		
dct_dc_differential	1-11	uimsbf
} else {		
dct_dc_size_chrominance	2-10	vlclbf
if(dct_dc_size_chrominance != 0)		
dct_dc_differential	1-11	uimsbf
}		
} else {		
First DCT coefficient	2-24	vlclbf
}		
while (nextbits() != End of block)		
Subsequent DCT coefficients	3-24	vlclbf
End of block	2 or 4	vlclbf
}		
}		

6.3 Video bitstream semantics

6.3.1 Semantic rules for higher syntactic structures

This subclause details the rules that govern the way in which the higher level syntactic elements may be combined together to produce a legal bitstream. Subsequent clauses detail the semantic meaning of all fields in the video bitstream.

Figure 6-15 illustrates the high level structure of the video bitstream.

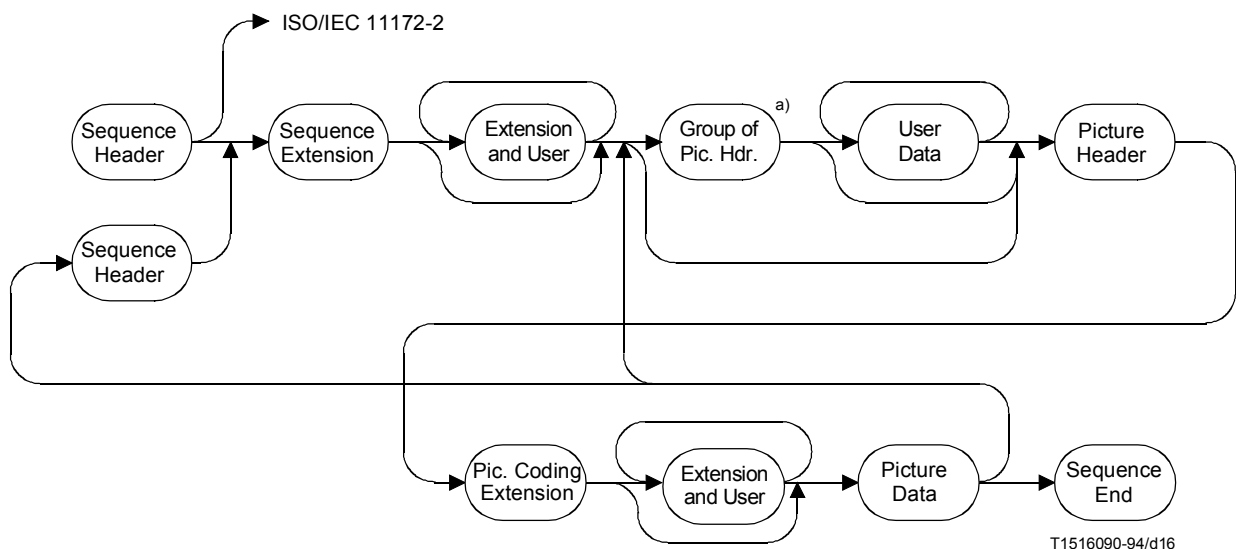

T1516090-94/d16

a) After a GOP, the first picture shall be an I-picture.

Figure 6-15 – High level bitstream organisation

The following semantic rules apply:

- If the first `sequence_header()` of the sequence is not followed by `sequence_extension()`, then the stream shall conform to ISO/IEC 11172-2 and is not documented within this Specification.
- If the first `sequence_header()` of a sequence is followed by a `sequence_extension()`, then all subsequent occurrences of `sequence_header()` shall also be immediately followed by a `sequence_extension()`.
- `sequence_extension()` shall only occur immediately following a `sequence_header()`.
- Following a `sequence_header()` there shall be at least one coded picture before a repeat `sequence_header()` or a `sequence_end_code`. This implies that `sequence_extension()` shall not immediately precede a `sequence_end_code`.
- If `sequence_extension()` occurs in the bitstream, then each `picture_header()` shall be followed immediately by a `picture_coding_extension()`.
- `sequence_end_code` shall be positioned at the end of the bitstream such that, after decoding and frame re-ordering, there shall be no missing frames.
- `picture_coding_extension()` shall only occur immediately following a `picture_header()`.
- The first coded frame following a `group_of_pictures_header()` shall be a coded I-frame.

A number of different extensions are defined in addition to `sequence_extension()` and `picture_coding_extension()`. The set of allowed extensions is different at each different point in the syntax where extensions are allowed. Table 6-2 defines a four bit `extension_start_code_identifier` for each extension.

Table 6-2 – extension_start_code_identifier codes

<code>extension_start_code_identifier</code>	Name
0000	Reserved
0001	Sequence Extension ID
0010	Sequence Display Extension ID
0011	Quant Matrix Extension ID
0100	Copyright Extension ID
0101	Sequence Scalable Extension ID
0110	Reserved
0111	Picture Display Extension ID
1000	Picture Coding Extension ID
1001	Picture Spatial Scalable Extension ID
1010	Picture Temporal Scalable Extension ID
1011	Camera Parameters Extension ID
1100	ITU-T extension ID
1101	Reserved
...	...
1111	Reserved

At each point where extensions are allowed in the bitstream any number of the extensions from the defined allowable set may be included. However, each type of extension shall not occur more than once.

In the case that a decoder encounters an extension with an extension identification that is described as "reserved" in this Specification, the decoder shall discard all subsequent data until the next start code. This requirement allows future definition of compatible extensions to this Specification.

6.3.2 Video sequence

sequence_end_code – The sequence_end_code is the bit string '000001B7' in hexadecimal. It terminates a video sequence.

6.3.3 Sequence header

sequence_header_code – The sequence_header_code is the bit string '000001B3' in hexadecimal. It identifies the beginning of a sequence header.

horizontal_size_value – This word forms the 12 least significant bits of horizontal_size.

vertical_size_value – This word forms the 12 least significant bits of vertical_size.

horizontal_size – The horizontal_size is a 14-bit unsigned integer, the 12 least significant bits are defined in horizontal_size_value, the 2 most significant bits are defined in horizontal_size_extension. The horizontal_size is the width of the displayable part of the luminance component of pictures in samples. The width of the encoded luminance component of pictures in macroblocks, mb_width, is (horizontal_size + 15)/16. The displayable part is left-aligned in the encoded pictures.

In order to avoid start code emulation horizontal_size_value shall not be zero. This precludes values of horizontal_size that are multiples of 4096.

vertical_size – The vertical_size is a 14-bit unsigned integer, the 12 least significant bits are defined in vertical_size_value, the 2 most significant bits are defined in vertical_size_extension. The vertical_size is the height of the displayable part of the luminance component of the frame in lines.

In the case that progressive_sequence is '1' the height of the encoded luminance component of frames in macroblocks, mb_height, is (vertical_size + 15)/16.

In the case that progressive_sequence is '0' the height of the encoded luminance component of frame pictures in macroblocks, mb_height, is $2*((vertical_size + 31)/32)$. The height of the encoded luminance component of field pictures in macroblocks, mb_height, is $((vertical_size + 31)/32)$.

The displayable part is top-aligned in the encoded pictures.

In order to avoid start code emulation vertical_size_value shall not be zero. This precludes values of vertical_size that are multiples of 4096.

aspect_ratio_information – This is a four-bit integer defined in Table 6-3.

Table 6-3 – aspect_ratio_information

aspect_ratio_information	Sample Aspect Ratio	DAR
0000	Forbidden	Forbidden
0001	1.0 (Square Sample)	–
0010	–	3 ÷ 4
0011	–	9 ÷ 16
0100	–	1 ÷ 2.21
0101	–	Reserved
...		...
1111	–	Reserved

aspect_ratio_information either specifies that the "Sample Aspect Ratio" (SAR) of the reconstructed frame is 1,0 (square samples) or alternatively it gives the "Display Aspect Ratio" (DAR).

- If sequence_display_extension() is not present, then it is intended that the entire reconstructed frame is intended to be mapped to the entire active region of the display. The sample aspect ratio may be calculated as follows:

$$SAR = DAR \times \frac{\text{horizontal_size}}{\text{vertical_size}}$$

NOTE 1 – In this case horizontal_size and vertical_size are constrained by the SAR of the source and the DAR selected.

- If sequence_display_extension() is present then the sample aspect ratio may be calculated as follows:

$$SAR = DAR \times \frac{\text{display_horizontal_size}}{\text{display_vertical_size}}$$

frame_rate_code – This is a four-bit integer used to define frame_rate_value as shown in Table 6-4. frame_rate may be derived from frame_rate_value, frame_rate_extension_n and frame_rate_extension_d as follows:

$$\text{frame_rate} = \text{frame_rate_value} * (\text{frame_rate_extension_n} + 1) \div (\text{frame_rate_extension_d} + 1)$$

When an entry for the frame rate exists directly in Table 6-4, frame_rate_extension_n and frame_rate_extension_d shall be zero. (frame_rate_extension_n + 1) and (frame_rate_extension_d + 1) shall not have a common divisor greater than one.

Table 6-4 – frame_rate_value

frame_rate_code	frame_rate_value
0000	Forbidden
0001	24 000 ÷ 1001 (23.976...)
0010	24
0011	25
0100	30 000 ÷ 1001 (29.97...)
0101	30
0110	50
0111	60 000 ÷ 1001 (59.94...)
1000	60
1001	Reserved
...	...
1111	Reserved

If progressive_sequence is '1' the period between two successive frames at the output of the decoding process is the reciprocal of the frame_rate. See Figure 7-18.

If progressive_sequence is '0' the period between two successive fields at the output of the decoding process is half of the reciprocal of the frame_rate. See Figure 7-20.

The frame_rate signalled in the enhancement layer of temporal scalability is the combined frame rate after the temporal re-multiplex operation if picture_mux_enable in the sequence_scalable_extension() is set to '1'.

bit_rate_value – The lower 18 bits of bit_rate.

bit_rate – This is a 30-bit integer. The lower 18 bits of the integer are in bit_rate_value and the upper 12 bits are in bit_rate_extension. bit_rate is measured in units of 400 bits/second, rounded upwards. The value zero is forbidden.

The bitrate specified bounds the maximum rate of operation of the VBV as defined in C.3.

The VBV operates in one of two modes depending on the coded values in `vbv_delay`. In all cases (both constant and variable bitrate operation) the bitrate specified shall be the upper bound of the rate at which the coded data is supplied to the input of the VBV.

NOTE 2 – Since constant bitrate operation is simply a special case of variable bitrate operation there is no requirement that the value of `bit_rate` is the actual bitrate at which the data is supplied. However it is recommended in the case of constant bitrate operation that `bit_rate` should represent the actual bitrate.

marker_bit – This is one bit that shall be set to '1'. This bit prevents emulation of start codes.

vbv_buffer_size_value – the lower 10 bits of `vbv_buffer_size`.

vbv_buffer_size – `vbv_buffer_size` is an 18-bit integer. The lower 10 bits of the integer are in `vbv_buffer_size_value` and the upper 8 bits are in `vbv_buffer_size_extension`. The integer defines the size of the VBV (Video Buffering Verifier, see Annex C) buffer needed to decode the sequence. It is defined as:

$$B = 16 * 1024 * vbv_buffer_size$$

where B is the minimum VBV buffer size in bits required to decode the sequence (see Annex C).

constrained_parameters_flag – This flag (used in ISO/IEC 11172-2) has no meaning in this Specification and shall have the value '0'.

load_intra_quantiser_matrix – See 6.3.11 "Quant matrix extension".

intra_quantiser_matrix – See 6.3.11 "Quant matrix extension".

load_non_intra_quantiser_matrix – See 6.3.11 "Quant matrix extension".

non_intra_quantiser_matrix – See 6.3.11 "Quant matrix extension".

6.3.4 Extension and user data

extension_start_code – The `extension_start_code` is the bit string '000001B5' in hexadecimal. It identifies the beginning of extensions beyond ISO/IEC 11172-2.

6.3.4.1 User data

user_data_start_code – The `user_data_start_code` is the bit string '000001B2' in hexadecimal. It identifies the beginning of user data. The user data continues until receipt of another start code.

user_data – This is an 8 bit integer, an arbitrary number of which may follow one another. User data is defined by users for their specific applications. In the series of consecutive `user_data` bytes there shall not be a string of 23 or more consecutive zero bits.

6.3.5 Sequence extension

extension_start_code_identifier – This is a 4-bit integer which identifies the extension. See Table 6-2.

profile_and_level_indication – This is an 8-bit integer used to signal the profile and level identification. The meaning of the bits is given in clause 8.

NOTE – In a scalable hierarchy the bitstreams of each layer may set `profile_and_level_indication` to a different value as specified in clause 8.

progressive_sequence – When set to '1' the coded video sequence contains only progressive frame-pictures. When `progressive_sequence` is set to '0' the coded video sequence may contain both frame-pictures and field-pictures, and frame-picture may be progressive or interlaced frames.

chroma_format – This is a two-bit integer indicating the chrominance format as defined in Table 6-5.

horizontal_size_extension – This 2-bit integer is the 2 most significant bits from `horizontal_size`.

vertical_size_extension – This 2-bit integer is the 2 most significant bits from `vertical_size`.

bit_rate_extension – This 12-bit integer is the 12 most significant bits from `bit_rate`.

vbv_buffer_size_extension – This 8-bit integer is the 8 most significant bits from `vbv_buffer_size`.

Table 6-5 – Meaning of chroma_format

chroma_format	Meaning
00	Reserved
01	4:2:0
10	4:2:2
11	4:4:4

low_delay – This flag, when set to '1', indicates that the sequence does not contain any B-pictures, that the frame re-ordering delay is not present in the VBV description and that the bitstream may contain "big pictures", i.e. that C.7 of the VBV may apply.

When set to '0', it indicates that the sequence may contain B-pictures, that the frame re-ordering delay is present in the VBV description and that bitstream shall not contain big pictures, i.e. C.7 of the VBV does not apply.

This flag is not used during the decoding process and therefore can be ignored by decoders, but it is necessary to define and verify the compliance of low-delay bitstreams.

frame_rate_extension_n – This is a 2-bit integer used to determine the frame_rate. See frame_rate_code.

frame_rate_extension_d – This is a 5-bit integer used to determine the frame_rate. See frame_rate_code.

6.3.6 Sequence display extension

This Specification does not define the display process. The information in this extension does not affect the decoding process and may be ignored by decoders that conform to this Specification.

video_format – This is a three bit integer indicating the representation of the pictures before being coded in accordance with this Specification. Its meaning is defined in Table 6-6. If the sequence_display_extension() is not present in the bitstream, then the video format may be assumed to be "Unspecified video format".

Table 6-6 – Meaning of video_format

video_format	Meaning
000	Component
001	PAL
010	NTSC
011	SECAM
100	MAC
101	Unspecified video format
110	Reserved
111	Reserved

colour_description – A flag which if set to '1' indicates the presence of colour_primaries, transfer_characteristics and matrix_coefficients in the bitstream.

colour_primaries – This 8-bit integer describes the chromaticity coordinates of the source primaries, and is defined in Table 6-7.

In the case that sequence_display_extension() is not present in the bitstream or colour_description is zero, the chromaticity is assumed to be implicitly defined by the application.

transfer_characteristics – This 8-bit integer describes the opto-electronic transfer characteristic of the source picture, and is defined in Table 6-8.

Table 6-7 – Colour Primaries

Value	Primaries
0	(Forbidden)
1	Recommendation ITU-R BT.709 primary x y green 0.300 0.600 blue 0.150 0.060 red 0.640 0.330 white D65 0.3127 0.3290
2	Unspecified Video Image characteristics are unknown
3	Reserved
4	Recommendation ITU-R BT.470-2 System M primary x y green 0.21 0.71 blue 0.14 0.08 red 0.67 0.33 white C 0.310 0.316
5	Recommendation ITU-R BT.470-2 System B, G primary x y green 0.29 0.60 blue 0.15 0.06 red 0.64 0.33 white D65 0.313 0.329
6	SMPTE 170M primary x y green 0.310 0.595 blue 0.155 0.070 red 0.630 0.340 white D65 0.3127 0.3290
7	SMPTE 240M (1987) primary x y green 0.310 0.595 blue 0.155 0.070 red 0.630 0.340 white D65 0.3127 0.3291
8-255	Reserved

Table 6-8 – Transfer Characteristics

Value	Transfer Characteristic
0	(Forbidden)
1	Recommendation ITU-R BT.709 $V = 1.099 L_c^{0.45} - 0.099$ for $1 \geq L_c \geq 0.018$ $V = 4.500 L_c$ for $0.018 > L_c \geq 0$
2	Unspecified Video Image characteristics are unknown
3	Reserved
4	Recommendation ITU-R BT.470-2 System M Assumed display gamma 2.2
5	Recommendation ITU-R BT.470-2 System B, G Assumed display gamma 2.8
6	SMPTE 170M $V = 1.099 L_c^{0.45} - 0.099$ for $1 \geq L_c \geq 0.018$ $V = 4.500 L_c$ for $0.018 > L_c \geq 0$
7	SMPTE 240M (1987) $V = 1.1115 L_c^{0.45} - 0.1115$ for $L_c \geq 0.0228$ $V = 4.0 L_c$ for $0.0228 > L_c$
8	Linear transfer characteristics i.e. $V = L_c$
9-255	Reserved

In the case that `sequence_display_extension()` is not present in the bitstream or `colour_description` is zero, the transfer characteristics are assumed to be implicitly defined by the application.

matrix_coefficients – This 8-bit integer describes the matrix coefficients used in deriving luminance and chrominance signals from the green, blue, and red primaries, and is defined in Table 6-9.

Table 6-9 – Matrix Coefficients

Value	Matrix
0	(Forbidden)
1	Recommendation ITU-R BT.709 $E'_Y = 0.7154 E'_G + 0.0721 E'_B + 0.2125 E'_R$ $E'_{PB} = -0.386 E'_G + 0.500 E'_B - 0.115 E'_R$ $E'_{PR} = -0.454 E'_G - 0.046 E'_B + 0.500 E'_R$
2	Unspecified Video Image characteristics are unknown
3	Reserved
4	FCC $E'_Y = 0.59 E'_G + 0.11 E'_B + 0.30 E'_R$ $E'_{PB} = -0.331 E'_G + 0.500 E'_B - 0.169 E'_R$ $E'_{PR} = -0.421 E'_G - 0.079 E'_B + 0.500 E'_R$
5	Recommendation ITU-R BT.470-2 System B, G $E'_Y = 0.587 E'_G + 0.114 E'_B + 0.299 E'_R$ $E'_{PB} = -0.331 E'_G + 0.500 E'_B - 0.169 E'_R$ $E'_{PR} = -0.419 E'_G - 0.081 E'_B + 0.500 E'_R$
6	SMPTE 170M $E'_Y = 0.587 E'_G + 0.114 E'_B + 0.299 E'_R$ $E'_{PB} = -0.331 E'_G + 0.500 E'_B - 0.169 E'_R$ $E'_{PR} = -0.419 E'_G - 0.081 E'_B + 0.500 E'_R$
7	SMPTE 240M (1987) $E'_Y = 0.701 E'_G + 0.087 E'_B + 0.212 E'_R$ $E'_{PB} = -0.384 E'_G + 0.500 E'_B - 0.116 E'_R$ $E'_{PR} = -0.445 E'_G - 0.055 E'_B + 0.500 E'_R$
8-255	Reserved

In Table 6-9:

- E'_Y is analogue with values between 0 and 1;
- E'_{PB} and E'_{PR} are analogue between the values -0.5 and 0.5 ;
- E'_R , E'_G and E'_B are analogue with values between 0 and 1;
- Y, Cb and Cr are related to E'_Y , E'_{PB} and E'_{PR} by the following formulae:

$$Y = (219 * E'_Y) + 16$$

$$Cb = (224 * E'_{PB}) + 128$$

$$Cr = (224 * E'_{PR}) + 128$$

NOTE 1 – The decoding process given by this Specification limits output sample values for Y, Cr and Cb to the range [0:255]. Thus, sample values outside the range implied by the above equations may occasionally occur at the output of the decoding process. In particular the sample values 0 and 255 may occur.

In the case that `sequence_display_extension()` is not present in the bitstream or `colour_description` is zero the matrix coefficients are assumed to be implicitly defined by the application.

NOTE 2 – In applications which may have signals with more than one set of colour primaries, transfer characteristics, and/or matrix coefficients, it is recommended to transmit a sequence display extension with `colour_description` set to one, and to specify the appropriate values for the colorimetry parameters.

display_horizontal_size – See display_vertical_size.

display_vertical_size – display_horizontal_size and display_vertical_size together define a rectangle which may be considered as the "intended display's" active region. If this rectangle is smaller than the encoded frame size, then the display process may be expected to display only a portion of the encoded frame. Conversely if the display rectangle is larger than the encoded frame size, then the display process may be expected to display the reconstructed frames on a portion of the display device rather than on the whole display device.

display_horizontal_size shall be in the same units as horizontal_size (samples of the encoded frames).

display_vertical_size shall be in the same units as vertical_size (lines of the encoded frames).

display_horizontal_size and display_vertical_size do not affect the decoding process but may be used by the display process that is not standardised in this Specification.

6.3.7 Sequence scalable extension

It is a syntactic restriction that if a sequence_scalable_extension() is present in the bitstream following a given sequence_extension(), then sequence_scalable_extension() shall follow every other occurrence of sequence_extension(). Thus a bitstream is either scalable or it is not scalable. It is not possible to mix scalable and non-scalable coding within a sequence.

scalable_mode – The scalable_mode indicates the type of scalability used in the video sequence. If no sequence_scalable_extension() is present in the bitstream, then no scalability is used for that sequence. scalable_mode also indicates the macroblock_type tables to be used. However, in the case of spatial scalability if no picture_spatial_scalable_extension() is present for a given picture, then that picture shall be decoded in a non-scalable manner (i.e. as if sequence_scalable_extension() had not been present).

Table 6-10 – Definition of scalable_mode

scalable_mode	Meaning	picture_spatial_scalable_extension()	macroblock_type tables
	sequence_scalable_extension() not present		B-2, B-3 and B-4
00	Data partitioning		B-2, B-3 and B-4
01	Spatial scalability	Present	B-5, B-6 and B-7
		Not present	B-2, B-3 and B-4
10	SNR scalability		B-8
11	Temporal scalability		B-2, B-3 and B-4

layer_id – This is an integer which identifies the layers in a scalable hierarchy. The base layer always has layer_id = 0. However, the base layer of a scalable hierarchy does not carry a sequence_scalable_extension() and hence layer_id, except in the case of data partitioning. Each successive layer has a layer_id which is one greater than the layer for which it is an enhancement.

In the case of data partitioning layer_id shall be zero for partition zero and layer_id shall be one for partition one.

lower_layer_prediction_horizontal_size – This is a 14-bit integer indicating the horizontal size of the lower layer frame which is used for prediction. This shall contain the value contained in horizontal_size (horizontal_size_value and horizontal_size_extension) in the lower layer bitstream.

lower_layer_prediction_vertical_size – This is a 14-bit integer indicating the vertical size of the lower layer frame which is used for prediction. This shall contain the value contained in vertical_size (vertical_size_value and vertical_size_extension) in the lower layer bitstream.

horizontal_subsampling_factor_m – This affects the spatial scalable upsampling process, as defined in 7.7.2. The value zero is forbidden.

horizontal_subsampling_factor_n – This affects the spatial scalable upsampling process, as defined in 7.7.2. The value zero is forbidden.

vertical_subsampling_factor_m – This affects the spatial scalable upsampling process, as defined in 7.7.2. The value zero is forbidden.

vertical_subsampling_factor_n – This affects the spatial scalable upsampling process, as defined in 7.7.2. The value zero is forbidden.

picture_mux_enable – If set to 1, picture_mux_order and picture_mux_factor are used for re-multiplexing prior to display.

mux_to_progressive_sequence – This flag when set to '1' indicates that the decoded pictures corresponding to the two layers shall be temporally multiplexed to generate a progressive sequence for display. When the temporal multiplexing is intended to generate an interlaced sequence this flag shall be '0'.

picture_mux_order – It denotes number of enhancement layer pictures prior to the first base layer picture. It thus assists re-multiplexing of pictures prior to display as it contains information for inverting the demultiplexing performed at the encoder.

picture_mux_factor – It denotes number of enhancement layer pictures between consecutive base layer pictures to allow correct re-multiplexing of base and enhancement layers for display. It also assists in re-multiplexing of pictures prior to display as it contains information for inverting the temporal demultiplexing performed at the encoder. The value '000' is reserved.

6.3.8 Group of pictures header

group_start_code – The group_start_code is the bit string '000001B8' in hexadecimal. It identifies the beginning of a group of pictures header.

time_code – This is a 25-bit integer containing the following: drop_frame_flag, time_code_hours, time_code_minutes, marker_bit, time_code_seconds and time_code_pictures as shown in Table 6-11. The parameters correspond to those defined in the IEC standard publication 60461 for "time and control codes for video tape recorders" (see Bibliography, Annex F). The time code refers to the first picture after the group of pictures header that has a temporal_reference of zero. The drop_frame_flag can be set to either '0' or '1'. It may be set to '1' only if the frame rate is 29.97 Hz. If it is '0' then pictures are counted assuming rounding to the nearest integral number of pictures per second, for example 29.97 Hz would be rounded to and counted as 30 Hz. If it is '1' then picture numbers 0 and 1 at the start of each minute, except minutes 0, 10, 20, 30, 40, 50 are omitted from the count.

NOTE – The information carried by time_code plays no part in the decoding process.

Table 6-11 – time_code

time_code	Range of value	No. of bits	Mnemonic
drop_frame_flag		1	uimsbf
time_code_hours	0 - 23	5	uimsbf
time_code_minutes	0 - 59	6	uimsbf
marker_bit	1	1	bslbf
time_code_seconds	0 - 59	6	uimsbf
time_code_pictures	0 - 59	6	uimsbf

closed_gop – This is a one-bit flag which indicates the nature of the predictions used in the first consecutive B-pictures (if any) immediately following the first coded I-frame following the group of picture header.

closed_gop is set to '1' to indicate that these B-pictures have been encoded using only backward prediction or intra coding.

This bit is provided for use during any editing which occurs after encoding. If the previous pictures have been removed by editing, broken_link may be set to '1' so that a decoder may avoid displaying these B-Pictures following the first I-Picture following the group of picture header. However, if the closed_gop bit is set to '1', then the editor may choose not to set the broken_link bit as these B-Pictures can be correctly decoded.

broken_link – This is a one-bit flag which shall be set to '0' during encoding. It is set to '1' to indicate that the first consecutive B-Pictures (if any) immediately following the first coded I-frame following the group of picture header may not be correctly decoded because the reference frame which is used for prediction is not available (because of the action of editing).

A decoder may use this flag to avoid displaying frames that cannot be correctly decoded.

6.3.9 Picture header

picture_start_code – The picture_start_code is a string of 32 bits having the value 00000100 in hexadecimal.

temporal_reference – The temporal_reference is a 10-bit unsigned integer associated with each coded picture.

The following simple specification applies only when low_delay is equal to zero.

When a coded frame is in the form of two field pictures, the temporal_reference associated with each picture shall be the same (it is called the temporal_reference of the coded frame). The temporal_reference of each coded frame shall increment by one modulo 1024 when examined in display order at the output of the decoding process, except when a group of pictures header occurs. Among the frames coded after a group of pictures header, the temporal_reference of the coded frame that is displayed first, shall be set to zero.

The following more general specification applies when low_delay is equal to zero or one.

If picture A is not a big picture, i.e. the VBV buffer is only examined once before the coded picture A is removed from the VBV buffer and if N is the temporal_reference of picture A, then the temporal_reference of picture B immediately following picture A in display order is equal to:

- 0 if there is a group of pictures header present between picture A and picture B (in coded order).
- $(N + 1) \% 1024$ if picture B is a frame picture or is the first field of a pair of field pictures.
- N if picture B is the second field of a pair of field pictures.

When low_delay is equal to one, there may be situations where the VBV buffer shall be re-examined several times before removing a coded picture (referred to as a big picture) from the VBV buffer.

If picture A is a big picture and if K is the number of times that the VBV buffer is re-examined as defined in C.7 ($K > 0$), if N is the temporal_reference of picture A, then the temporal_reference of picture B immediately following picture A in display order is equal to:

- $K \% 1024$ if there is a group of pictures header present between picture A and picture B (in coded order).
- $(N + K + 1) \% 1024$ if picture B is a frame picture or is the first field of a pair of field pictures.
- $(N + K) \% 1024$ if picture B is the second field of a pair of field pictures.

NOTE 1 – If the big picture is the first field of a frame coded with field pictures, then the temporal_reference of the two field pictures of that coded frame are not identical.

picture_coding_type – The picture_coding_type identifies whether a picture is an intra-coded picture(I), predictive-coded picture(P) or bidirectionally predictive-coded picture(B). The meaning of picture_coding_type is defined in Table 6-12.

NOTE 2 – Intra-coded pictures with only DC coefficients (D-pictures) that may be used in ISO/IEC 11172-2 are not supported by this Specification.

Table 6-12 – picture_coding_type

picture_coding_type	coding method
000	Forbidden
001	intra-coded (I)
010	predictive-coded (P)
011	bidirectionally-predictive-coded (B)
100	Shall not be used (dc intra-coded (D) in ISO/IEC11172-2)
101	Reserved
110	Reserved
111	Reserved

vbv_delay – The `vbv_delay` is a 16-bit unsigned integer. In all cases other than when `vbv_delay` has the value hexadecimal FFFF, the value of `vbv_delay` is the number of periods of a 90 kHz clock derived from the 27 MHz system clock that the VBV shall wait after receiving the final byte of the picture start code before decoding the picture. `vbv_delay` shall be coded to represent the delay as specified above or it shall be coded with the value hexadecimal FFFF. If any `vbv_delay` field in a sequence is coded with hexadecimal FFFF, then all of them shall be coded with this value. If `vbv_delay` takes the value hexadecimal FFFF, input of data to the VBV buffer is defined in C.3.2, otherwise input to the VBV buffer is defined in C.3.1.

If `low_delay` is equal '1' and if the bitstream contains big pictures, the `vbv_delay` values encoded in the `picture_header()` of big pictures may be wrong if not equal to hexadecimal FFFF.

NOTE 3 – There are several ways of calculating `vbv_delay` in an encoder.

In all cases it may be calculated by noting that the end-to-end delay through the encoder and decoder buffer is constant for all pictures. The encoder is capable of knowing the delay experienced by the relevant picture start code in the encoder buffer and the total end-to-end delay. Therefore, the value encoded in `vbv_delay` (the decoder buffer delay of the picture start code) is calculated as the total delay less the delay of the corresponding picture start code in the encoder buffer measured in periods of a 90 kHz clock derived from the 27 MHz system clock.

Alternatively, for constant bitrate operation only, `vbv_delay` may be calculated from the state of the VBV as follows:

$$\text{vbv_delay}_n = 90\,000 * B_n^* / R$$

where:

$n > 0$

B_n^* = VBV occupancy, measured in bits, immediately before removing picture n from the buffer but after removing any header(s), user data and stuffing that immediately precedes the data elements of picture n .

R = the actual bitrate (i.e. to full accuracy rather than the quantised value given by `bit_rate` in the sequence header).

An equivalent method of calculating `vbv_delay` for variable bitrate streams can be derived from the equation in C.3.1. This will be in the form of a recurrence relation for the `vbv_delay` given the previous `vbv_delay`, the decoding times of the current and previous pictures, and the number of bytes in the previous picture. This method can be applied if, at the time `vbv_delay` is encoded, the average bitrate of the transfer of the picture data of the previous picture is known.

full_pel_forward_vector – This flag that is used in ISO/IEC 11172-2 is not used by this Specification. It shall have the value '0'.

forward_f_code – This 3 bit string (which is used in ISO/IEC 11172-2) is not used by this Specification. It shall have the value '111'.

full_pel_backward_vector – This flag that is used in ISO/IEC 11172-2 is not used by this Specification. It shall have the value '0'.

backward_f_code – This 3 bit string (which is used in ISO/IEC 11172-2) is not used by this Specification. It shall have the value '111'.

extra_bit_picture – A bit indicates the presence of the following extra information. If `extra_bit_picture` is set to '1', `extra_information_picture` will follow it. If it is set to '0', there are no data following it. `extra_bit_picture` shall be set to '0', the value '1' is reserved for possible future extensions defined by ITU-T | ISO/IEC.

extra_information_picture – Reserved. A decoder conforming to this Specification that encounters `extra_information_picture` in a bitstream shall ignore it (i.e. remove from the bitstream and discard). A bitstream conforming to this Specification shall not contain this syntax element.

6.3.10 Picture coding extension

f_code[s][t] – A 4 bit unsigned integer taking values 1 through 9, or 15. The value zero is forbidden and the values 10 through 14 are reserved. It is used in the decoding of motion vectors, see 7.6.3.1.

In an I-picture in which `concealment_motion_vectors` is zero `f_code[s][t]` is not used (since motion vectors are not used) and shall take the value 15 (all ones).

Similarly, in an I-picture or a P-picture `f_code[1][t]` is not used in the decoding process (since it refers to backwards motion vectors) and shall take the value 15 (all ones).

See Table 7-7 for the meaning of the indices; s and t.

intra_dc_precision – This is a 2-bit integer defined in the Table 6-13.

Table 6-13 – Intra DC precision

intra_dc_precision	Precision (bits)
00	8
01	9
10	10
11	11

The inverse quantisation process for the Intra DC coefficients is modified by this parameter as explained in 7.4.1.

picture_structure – This is a 2-bit integer defined in the Table 6-14.

Table 6-14 – Meaning of picture_structure

picture_structure	Meaning
00	Reserved
01	Top Field
10	Bottom Field
11	Frame picture

When a frame is encoded in the form of two field pictures both fields must be of the same `picture_coding_type`, except where the first encoded field is an I-picture in which case the second may be either an I-picture or a P-picture.

The first encoded field of a frame may be a top-field or a bottom field, and the next field must be of opposite parity.

When a frame is encoded in the form of two field pictures, the following syntax elements may be set independently in each field picture:

- `f_code[0][0]`, `f_code[0][1]`;
- `f_code[1][0]`, `f_code[1][1]`;
- `intra_dc_precision`, `concealment_motion_vectors`, `q_scale_type`;
- `intra_vlc_format`, `alternate_scan`;
- `vbv_delay`;
- `temporal_reference`.

top_field_first – The meaning of this element depends upon `picture_structure`, `progressive_sequence` and `repeat_first_field`.

If `progressive_sequence` is equal to '0', this flag indicates what field of a reconstructed frame is output first by the decoding process.

In a field picture `top_field_first` shall have the value '0', and the only field output by the decoding process is the decoded field picture.

In a frame picture `top_field_first` being set to '1' indicates that the top field of the reconstructed frame is the first field output by the decoding process. `top_field_first` being set to '0' indicates that the bottom field of the reconstructed frame is the first field output by decoding process.

If `progressive_sequence` is equal to '1', this flag, combined with `repeat_first_field`, indicates how many times (one, two or three) the reconstructed frame is output by the decoding process.

If `repeat_first_field` is set to 0, `top_field_first` shall be set to '0'. In this case the output of the decoding process corresponding to this reconstructed frame consists of one progressive frame.

If `top_field_first` is set to 0 and `repeat_first_field` is set to '1', the output of the decoding process corresponding to this reconstructed frame consists of two identical progressive frames.

If `top_field_first` is set to 1 and `repeat_first_field` is set to '1', the output of the decoding process corresponding to this reconstructed frame consists of three identical progressive frames.

frame_pred_frame_dct – If this flag is set to '1', then only frame-DCT and frame prediction are used. In a field picture it shall be '0'. `frame_pred_frame_dct` shall be '1' if `progressive_sequence` is '1'. This flag affects the syntax of the bitstream.

concealment_motion_vectors – This flag has the value '1' to indicate that motion vectors are coded in intra macroblocks. This flag has the value '0' to indicate that no motion vectors are coded in intra macroblocks.

q_scale_type – This flag affects the inverse quantisation process as described in 7.4.2.2.

intra_vlc_format – This flag affects the decoding of transform coefficient data as described in 7.2.2.1.

alternate_scan – This flag affects the decoding of transform coefficient data as described in 7.3.

repeat_first_field – This flag is applicable only in a frame picture; in a field picture it shall be set to zero and does not affect the decoding process.

If `progressive_sequence` is equal to 0 and `progressive_frame` is equal to 0, `repeat_first_field` shall be zero, and the output of the decoding process corresponding to this reconstructed frame consists of two fields.

If `progressive_sequence` is equal to 0 and `progressive_frame` is equal to 1:

If this flag is set to 0, the output of the decoding process corresponding to this reconstructed frame consists of two fields. The first field (top or bottom field as identified by `top_field_first`) is followed by the other field.

If it is set to 1, the output of the decoding process corresponding to this reconstructed frame consists of three fields. The first field (top or bottom field as identified by `top_field_first`) is followed by the other field, then the first field is repeated.

If `progressive_sequence` is equal to 1:

If this flag is set to 0, the output of the decoding process corresponding to this reconstructed frame consists of one frame.

If it is set to 1, the output of the decoding process corresponding to this reconstructed frame consists of two or three frames, depending on the value of `top_field_first`.

chroma_420_type – If `chroma_format` is "4:2:0", the value of `chroma_420_type` shall be the same as `progressive_frame`; else `chroma_420_type` has no meaning and shall be equal to zero. This flag exists for historical reasons.

progressive_frame – If `progressive_frame` is set to 0 it indicates that the two fields of the frame are interlaced fields in which an interval of time of the field period exists between (corresponding spatial samples) of the two fields. In this case the following restriction applies:

- `repeat_first_field` shall be zero (two field duration).

If `progressive_frame` is set to 1 it indicates that the two fields (of the frame) are actually from the same time instant as one another. In this case a number of restrictions to other parameters and flags in the bitstream apply:

- `picture_structure` shall be "Frame";
- if `progressive_sequence` is equal to one, then `frame_pred_frame_dct` shall be 1.

`progressive_frame` is used when the video sequence is used as the lower layer of a spatial scalable sequence. Here it affects the up-sampling process used in forming a prediction in the enhancement layer from the lower layer.

composite_display_flag – This flag is set to 1 to indicate that the following fields that are of use when the input pictures have been coded as (analogue) composite video prior to encoding into a bitstream that complies with this Specification. If it is set to 0, then these parameters do not occur in the bitstream.

The information relates to the picture that immediately follows the extension. In the case that this picture is a frame picture, the information relates to the first field of that frame. The equivalent information for the second field may be derived (there is no way to represent it in the bitstream).

NOTE 1 – The various syntactic elements that are included in the bitstream if `composite_display_flag` is '1' are not used in the decoding process.

NOTE 2 – `repeat_first_field` will cause a composite video field to be repeated out of the 4-field or 8-field sequence. It is recommended that `repeat_first_field` and `composite_display_flag` are not both set simultaneously.

v_axis – A 1-bit integer used only when the bitstream represents a signal that had previously been encoded according to PAL systems. `v_axis` is set to 1 on a positive sign, `v_axis` is set to 0 otherwise.

field_sequence – A 3-bit integer which defines the number of the field in the eight field sequence used in PAL systems or the four field sequence used in NTSC systems as defined in the Table 6-15.

Table 6-15 – Definition of field_sequence

Field sequence	Frame	Field
000	1	1
001	1	2
010	2	3
011	2	4
100	3	5
101	3	6
110	4	7
111	4	8

sub_carrier – This is a 1-bit integer. Set to 0 means the sub-carrier/line frequency relationship is correct. When set to 1 the relationship is not correct.

burst_amplitude – This is a 7-bit integer defining the burst amplitude (for PAL and NTSC only). The amplitude of the sub-carrier burst is quantised as a Recommendation ITU-R BT.601 luminance signal, with the MSB omitted.

sub_carrier_phase – This is an 8-bit integer defining the phase of the reference sub-carrier at the field-synchronisation datum with respect, to field start as defined in Recommendation ITU-R BT.470 (see Table 6-16).

Table 6-16 – Definition of sub_carrier_phase

sub_carrier_phase	Phase
0	$([360^\circ \div 256] * 0)$
1	$([360^\circ \div 256] * 1)$
...	...
255	$([360^\circ \div 256] * 255)$

6.3.11 Quant matrix extension

Each quantisation matrix has a default set of values. When a sequence_header_code is decoded all matrices shall be reset to their default values. User defined matrices may be downloaded and this can occur in a sequence_header() or in a quant_matrix_extension().

With 4:2:0 data only two matrices are used, one for intra blocks the other for non-intra blocks.

With 4:2:2 or 4:4:4 data four matrices are used. Both an intra and a non-intra matrix are provided for both luminance blocks and for chrominance blocks. Note, however, that it is possible to download the same user defined matrix into both the luminance and chrominance matrix at the same time.

The default matrix for intra blocks (both luminance and chrominance) is:

		<i>u</i>							
		0	1	2	3	4	5	6	7
<i>v</i>	0	8	16	19	22	26	27	29	34
	1	16	16	22	24	27	29	34	37
	2	19	22	26	27	29	34	34	38
	3	22	22	26	27	29	34	37	40
	4	22	26	27	29	32	35	40	48
	5	26	27	29	32	35	40	48	58
	6	26	27	29	34	38	46	56	69
	7	27	29	35	38	46	56	69	83

The default matrix for non-intra blocks (both luminance and chrominance) is:

		<i>u</i>							
		0	1	2	3	4	5	6	7
<i>v</i>	0	16	16	16	16	16	16	16	16
	1	16	16	16	16	16	16	16	16
	2	16	16	16	16	16	16	16	16
	3	16	16	16	16	16	16	16	16
	4	16	16	16	16	16	16	16	16
	5	16	16	16	16	16	16	16	16
	6	16	16	16	16	16	16	16	16
	7	16	16	16	16	16	16	16	16

load_intra_quantiser_matrix – This is a one-bit flag which is set to '1' if `intra_quantiser_matrix` follows. If it is set to '0' then there is no change in the values that shall be used.

intra_quantiser_matrix – This is a list of sixty-four 8-bit unsigned integers. The new values, encoded in the default zigzag scanning order as described in 7.3.1, replace the previous values. The first value shall always be 8 (values 1 to 7 and 9 to 255 are reserved). For all of the 8-bit unsigned integers, the value zero is forbidden. With 4:2:2 and 4:4:4 data the new values shall be used for both the luminance intra matrix and the chrominance intra matrix. However, the chrominance intra matrix may subsequently be loaded with a different matrix.

load_non_intra_quantiser_matrix – This is a one-bit flag which is set to '1' if `non_intra_quantiser_matrix` follows. If it is set to '0' then there is no change in the values that shall be used.

non_intra_quantiser_matrix – This is a list of sixty-four 8-bit unsigned integers. The new values, encoded in the default zigzag scanning order as described in 7.3.1, replace the previous values. For all the 8-bit unsigned integers, the value zero is forbidden. With 4:2:2 and 4:4:4 data, the new values shall be used for both the luminance non-intra matrix and the chrominance non-intra matrix. However, the chrominance non-intra matrix may subsequently be loaded with a different matrix.

load_chroma_intra_quantiser_matrix – This is a one-bit flag which is set to '1' if `chroma_intra_quantiser_matrix` follows. If it is set to '0' then there is no change in the values that shall be used. If `chroma_format` is "4:2:0", this flag shall take the value '0'.

chroma_intra_quantiser_matrix – This is a list of sixty-four 8-bit unsigned integers. The new values, encoded in the default zigzag scanning order as described in 7.3.1, replace the previous values. The first value shall always be 8 (values 1 to 7 and 9 to 255 are reserved). For all of the 8-bit unsigned integers, the value zero is forbidden.

load_chroma_non_intra_quantiser_matrix – This is a one-bit flag which is set to '1' if `chroma_non_intra_quantiser_matrix` follows. If it is set to '0' then there is no change in the values that shall be used. If `chroma_format` is "4:2:0", this flag shall take the value '0'.

chroma_non_intra_quantiser_matrix – This is a list of sixty-four 8-bit unsigned integers. The new values, encoded in the default zigzag scanning order as described in 7.3.1, replace the previous values. For all the 8-bit unsigned integers, the value zero is forbidden.

6.3.12 Picture display extension

This Specification does not define the display process. The information in this extension does not affect the decoding process and may be ignored by decoders that conform to this Specification.

The picture display extension allows the position of the display rectangle whose size is specified in `sequence_display_extension()` to be moved on a picture-by-picture basis. One application for this is the implementation of pan-scan.

frame_centre_horizontal_offset – This is a 16-bit signed integer giving the horizontal offset in units of 1/16th sample. A positive value shall indicate that the centre of the reconstructed frame lies to the right of the centre of the display rectangle.

frame_centre_vertical_offset – This is a 16-bit signed integer giving the vertical offset in units of 1/16th sample. A positive value shall indicate that the centre of the reconstructed frame lies below the centre of the display rectangle.

The dimensions of the display rectangular region are defined in the `sequence_display_extension()`. The coordinates of the region within the coded picture are defined in the `picture_display_extension()`.

The centre of the reconstructed frame is the centre of the rectangle defined by `horizontal_size` and `vertical_size`.

Since (in the case of an interlaced sequence) a coded picture may relate to one, two or three decoded fields, the `picture_display_extension()` may contain up to three offsets.

The number of frame centre offsets in the `picture_display_extension()` shall be defined as follows:

```

if ( progressive_sequence == 1 ) {
    if ( repeat_first_field == '1' ) {
        if ( top_field_first == '1' )
            number_of_frame_centre_offsets = 3
        else
            number_of_frame_centre_offsets = 2
    } else {
        number_of_frame_centre_offsets = 1
    }
} else {
    if (picture_structure == "field") {
        number_of_frame_centre_offsets = 1
    } else {
        if (repeat_first_field == '1')
            number_of_frame_centre_offsets = 3
        else
            number_of_frame_centre_offsets = 2
    }
}

```

A `picture_display_extension()` shall not occur unless a `sequence_display_extension()` followed the previous `sequence_header()`.

In the case that a given picture does not have a `picture_display_extension()`, then the most recently decoded frame centre offset shall be used. Note that each of the missing frame centre offsets have the same value (even if two or three frame centre offsets would have been contained in the `picture_display_extension()` had been present). Following a `sequence_header()` the value zero shall be used for all frame centre offsets until a `picture_display_extension()` defines non-zero values.

Figure 6-16 illustrates the picture display parameters. As shown, the frame centre offsets contained in the `picture_display_extension()` shall specify the position of the centre of the reconstructed frame from the centre of the display rectangle.

NOTE 1 – The display rectangle may also be larger than the reconstructed frame.

NOTE 2 – Even in a field picture the `frame_centre_vertical_offset` still represents the offset of the centre of the frame in 1/16th of a **frame** line (not a line in the field).

NOTE 3 – In the example of Figure 6-16 both `frame_centre_horizontal_offset` and `frame_centre_vertical_offset` have negative values.

6.3.12.1 Pan-scan

The frame centre offsets may be used to implement pan-scan in which a rectangular region is defined which may be panned around the entire reconstructed frame.

By way of example only; this facility may be used to identify a 3/4 aspect ratio window in a 9/16 coded picture format. This would allow a decoder to produce usable pictures for a conventional definition television set from an encoded format intended for enhanced definition. The 3/4 aspect ratio region is intended to contain the "most interesting" region of the picture.

The 3/4 region is defined by `display_horizontal_size` and `display_vertical_size`. The 9/16 frame size is defined by `horizontal_size` and `vertical_size`.

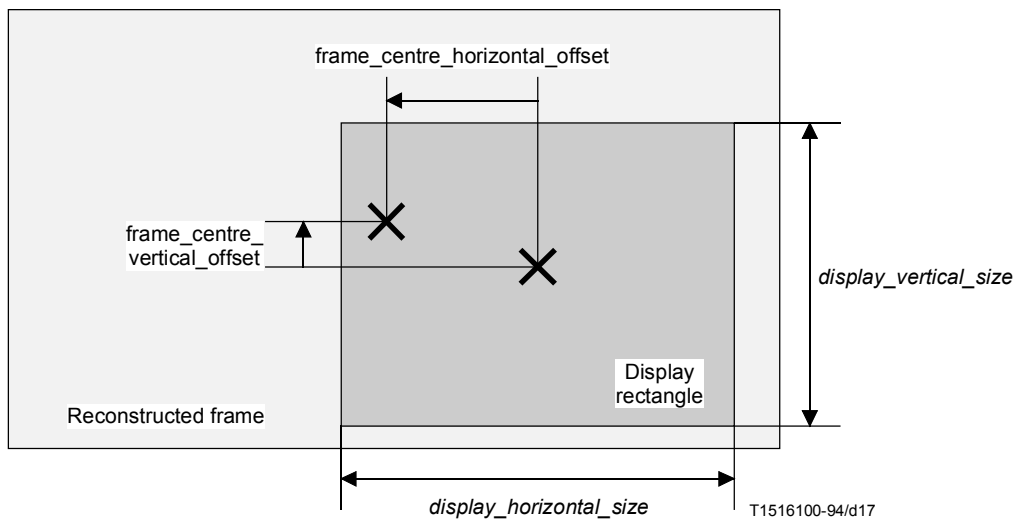

Figure 6-16 – Frame centre offset parameters

6.3.13 Picture temporal scalable extension

NOTE – See also 7.9.

reference_select_code – This is a 2-bit code that identifies reference frames or reference fields for prediction depending on the picture type.

forward_temporal_reference – A 10 bit unsigned integer value which indicates temporal reference of the lower layer frame to be used to provide the forward prediction. If the lower layer indicates temporal reference with more than 10 bits, the least significant bits are encoded here. If the lower layer indicates temporal reference with fewer than 10 bits, all bits are encoded here and the more significant bits shall be set to zero.

backward_temporal_reference – A 10 bit unsigned integer value which indicates temporal reference of the lower layer frame to be used to provide the backward prediction. If the lower layer indicates temporal reference with more than 10 bits, the least significant bits are encoded here. If the lower layer indicates temporal reference with fewer than 10 bits, all bits are encoded here and the more significant bits shall be set to zero.

6.3.14 Picture spatial scalable extension

lower_layer_temporal_reference – A 10 bit unsigned integer value which indicates temporal reference of the lower layer frame to be used to provide the prediction. If the lower layer indicates temporal reference with more than 10 bits, the least significant bits are encoded here. If the lower layer indicates temporal reference with fewer than 10 bits, all bits are encoded here and the more significant bits shall be set to zero.

lower_layer_horizontal_offset – This 15 bit signed (twos complement) integer specifies the horizontal offset (of the top left hand corner) of the upsampled lower layer frame relative to the enhancement layer picture. It is expressed in units of the enhancement layer picture sample width. If the chrominance format is 4:2:0 or 4:2:2, then this parameter shall be an even number.

lower_layer_vertical_offset – This 15 bit signed (twos complement) integer specifies the vertical offset (of the top left hand corner) of the upsampled lower layer picture relative to the enhancement layer picture. It is expressed in units of the enhancement layer picture sample height. If the chrominance format is 4:2:0, then this parameter shall be an even number.

spatial_temporal_weight_code_table_index – This 2-bit integer indicates which table of spatial temporal weight codes is to be used as defined in 7.7. Permissible values of `spatial_temporal_weight_code_table_index` are defined in Table 7-21.

lower_layer_progressive_frame – This flag shall be set to 0 if the lower layer frame is interlaced and shall be set to '1' if the lower layer frame is progressive. The use of this flag in the spatial scalable upsampling process is defined in 7.7.

lower_layer_deinterlaced_field_select – This flag affects the spatial scalable upsampling process, as defined in 7.7.

6.3.15 Copyright extension

extension_start_code_identifier – This is a 4-bit integer which identifies the extension (see Table 6-2).

copyright_flag – This is a one bit flag. When `copyright_flag` is set to '1', it indicates that the source video material encoded in all the coded pictures following the copyright extension, in coding order, up to the next copyright extension or end of sequence code, is copyrighted. The `copyright_identifier` and `copyright_number` identify the copyrighted work. When `copyright_flag` is set to '0', it does not indicate whether the source video material encoded in all the coded pictures following the copyright extension, in coding order, is copyrighted or not.

copyright_identifier – This is an 8-bit integer given by a Registration Authority as designated by ISO/IEC JTC1/SC29. Value zero indicates that this information is not available. The value of `copyright_number` shall be zero when `copyright_identifier` is equal to zero.

When `copyright_flag` is set to '0', `copyright_identifier` has no meaning and shall have the value 0.

original_or_copy – This is a one bit flag. It is set to '1' to indicate that the material is an original, and set to '0' to indicate that it is a copy.

reserved – This is a 7-bit integer, reserved for future extension. It shall have the value zero.

copyright_number_1 – This is a 20-bit integer, representing bits 44 to 63 of `copyright_number`.

copyright_number_2 – This is a 22-bit integer, representing bits 22 to 43 of `copyright_number`.

copyright_number_3 – This is a 22-bit integer, representing bits 0 to 21 of `copyright_number`.

copyright_number – This is a 64-bit integer, derived from `copyright_number_1`, `copyright_number_2`, and `copyright_number_3` as follows:

$$\text{copyright_number} = (\text{copyright_number_1} \ll 44) + (\text{copyright_number_2} \ll 22) + \text{copyright_number_3}.$$

The meaning of `copyright_number` is defined only when `copyright_flag` is set to '1'. In this case, the value of `copyright_number` identifies uniquely the copyrighted work marked by the copyrighted extension. The value 0 for `copyright_number` indicates that the identification number of the copyrighted work is not available.

When `copyright_flag` is set to '0', `copyright_number` has no meaning and shall have the value 0.

6.3.16 Slice

slice_start_code – The `slice_start_code` is a string of 32-bits. The first 24-bits have the value 000001 in hexadecimal and the last 8-bits are the `slice_vertical_position` having a value in the range 01 through AF hexadecimal inclusive.

slice_vertical_position – This is given by the last eight bits of the `slice_start_code`. It is an unsigned integer giving the vertical position in macroblock units of the first macroblock in the slice.

In large pictures (when the vertical size of the frame is greater than 2800 lines) the slice vertical position is extended by the **slice_vertical_position_extension**.

The macroblock row may be calculated as follows:

```

if ( vertical_size > 2800 )
    mb_row = (slice_vertical_position_extension << 7) + slice_vertical_position - 1;
else
    mb_row = slice_vertical_position - 1;

```

The `slice_vertical_position` of the first row of macroblocks is one. Some slices may have the same `slice_vertical_position`, since slices may start and finish anywhere. The maximum value of `slice_vertical_position` is 175 unless `slice_vertical_position_extension` is present in which case `slice_vertical_position` shall be in the range [1:128].

priority_breakpoint – This is a 7-bit integer that indicates the point in the syntax where the bitstream shall be partitioned. The allowed values and their semantic interpretation is given in Table 7-30 `priority_breakpoint` shall take the value zero in partition 1.

quantiser_scale_code – A 5 bit unsigned integer in the range 1 to 31 . The decoder shall use this value until another `quantiser_scale_code` is encountered either in `slice()` or `macroblock()`. The value zero is forbidden.

slice_extension_flag – This flag shall be set to '1' to indicate the presence of `intra_slice`, `slice_picture_id_enable`, `slice_picture_id` in the bitstream.

intra_slice – This flag shall be set to '0' if any of the macroblocks in the slice are non-intra macroblocks. If all of the macroblocks, are intra macroblocks, then `intra_slice` may be set to '1'.

`intra_slice` may be omitted from the bitstream (by setting `intra_slice_flag` to '0') in which case it shall be assumed to have the value zero.

`intra_slice` is not used by the decoding process. `intra_slice` is intended to aid a DSM application in performing FF/FR (see D.12).

slice_picture_id_enable – This flag controls the semantics of `slice_picture_id`. If `slice_picture_id_enable` is set to '0', `slice_picture_id` is not used by this Specification and shall have the value zero. If `slice_picture_id_enable` is set to '1', `slice_picture_id` may have a value different from zero.

`slice_picture_id_enable` must have the same value in all the slices of a picture. `slice_picture_id_enable` may be omitted from the bitstream (by setting `slice_extension_flag` to '0') in which case it shall be assumed to have the value zero.

`slice_picture_id_enable` is not used by the decoding process.

slice_picture_id – This is a 6-bit integer. If `slice_picture_id_enable` is set to '0', `slice_picture_id` is not used by this Specification and shall have the value zero. If `slice_picture_id_enable` is set to '1', `slice_picture_id` is application defined and may have any value, with the constraint that `slice_picture_id` shall have the same value in all the slices of a picture.

`slice_picture_id` is not used by the decoding process. `slice_picture_id` is intended to aid recovery on severe bursts of errors for certain types of applications. For example, the application may increment `slice_picture_id` with each transmitted picture, so that in case of severe burst error, when several slices are lost, the decoder can know if the slice following the burst error belongs to the current picture or to another picture, which may be the case if at least a picture header has been lost.

extra_bit_slice – This flag indicates the presence of the following extra information. If `extra_bit_slice` is set to '1', `extra_information_slice` will follow it. If it is set to '0', there are no data following it. `extra_bit_slice` shall be set to '0', the value '1' is reserved for possible future extensions defined by ITU-T | ISO/IEC.

extra_information_slice – Reserved. A decoder conforming to this Specification that encounters `extra_information_slice` in a bitstream shall ignore it (i.e. remove from the bitstream and discard). A bitstream conforming to this Specification shall not contain this syntax element.

6.3.17 Macroblock

NOTE – "macroblock_stuffing" which is supported in ISO/IEC 11172-2 shall not be used in a bitstream defined by this Specification.

macroblock_escape – The `macroblock_escape` is a fixed bit-string '0000 0001 000' which is used when the difference between `macroblock_address` and `previous_macroblock_address` is greater than 33. It causes the value of `macroblock_address_increment` to be 33 greater than the value that will be decoded by subsequent `macroblock_escape` and the `macroblock_address_increment` codewords.

For example, if there are two `macroblock_escape` codewords preceding the `macroblock_address_increment`, then 66 is added to the value indicated by `macroblock_address_increment`.

macroblock_address_increment – This is a variable length coded integer coded as per Table B.1 which indicates the difference between `macroblock_address` and `previous_macroblock_address`. The maximum value of `macroblock_address_increment` is 33. Values greater than this can be encoded using the `macroblock_escape` codeword.

The `macroblock_address` is a variable defining the absolute position of the current macroblock. The `macroblock_address` of the top-left macroblock is zero.

The `previous_macroblock_address` is a variable defining the absolute position of the last non-skipped macroblock (see 7.6.6 for the definition of skipped macroblocks) except at the start of a slice. At the start of a slice `previous_macroblock_address` is reset as follows:

$$\text{previous_macroblock_address} = (\text{mb_row} * \text{mb_width}) - 1$$

The horizontal spatial position in macroblock units of a macroblock in the picture (`mb_column`) can be computed from the `macroblock_address` as follows:

$$\text{mb_column} = \text{macroblock_address} \% \text{mb_width}$$

where `mb_width` is the number of macroblocks in one row of the picture.

Except at the start of a slice, if the value of `macroblock_address` recovered from `macroblock_address_increment` and the `macroblock_escape` codes (if any) differs from the `previous_macroblock_address` by more than one then some macroblocks have been skipped. It is a requirement that:

- There shall be no skipped macroblocks in I-pictures except when either
 - `picture_spatial_scalable_extension()` follows the `picture_header()` of the current picture; or
 - `sequence_scalable_extension()` is present in the bitstream and `scalable_mode = "SNR scalability"`.
- In a B-picture there shall be no skipped macroblocks immediately following a macroblock in which `macroblock_intra` is one.

It should be noted that the syntax does not allow the first and last macroblock of a slice to be skipped.

6.3.17.1 Macroblock modes

macroblock_type – Variable length coded indicator which indicates the method of coding and content of the macroblock according to the Tables B.2 through B.8, selected by `picture_coding_type` and `scalable_mode`.

macroblock_quant – Derived from `macroblock_type` according to the Tables B.2 through B.8. This is set to 1 to indicate that `quantiser_scale_code` is present in the bitstream.

macroblock_motion_forward – Derived from `macroblock_type` according to the Tables B.2 through B.8. This flag affects the bitstream syntax and is used by the decoding process.

macroblock_motion_backward – Derived from `macroblock_type` according to the Tables B.2 through B.8. This flag affects the bitstream syntax and is used by the decoding process.

macroblock_pattern – Derived from `macroblock_type` according to the Tables B.2 through B.8. This is set to 1 to indicate that `coded_block_pattern()` is present in the bitstream.

macroblock_intra – Derived from `macroblock_type` according to the Tables B.2 through B.8. This flag affects the bitstream syntax and is used by the decoding process.

spatial_temporal_weight_code_flag – Derived from the `macroblock_type`. This indicates whether the `spatial_temporal_weight_code` is present in the bitstream.

When `spatial_temporal_weight_code_flag` is '0' (indicating that `spatial_temporal_weight_code` is not present in the bitstream) the `spatial_temporal_weight_class` is derived from Tables B.5 to B.7. When `spatial_temporal_weight_code_flag` is '1' `spatial_temporal_weight_class` is derived from Table 7-20.

spatial_temporal_weight_code – This is a two bit code which indicates, in the case of spatial scalability, how the spatial and temporal predictions shall be combined to form the prediction for the macroblock. A full description of how to form the spatial scalable prediction is given in 7.7.

frame_motion_type – This is a two bit code indicating the macroblock prediction type, defined in Table 6-17.

Table 6-17 – Meaning of frame_motion_type

Code	spatial_temporal_weight_class	Prediction type	motion_vector_count	mv_format	dmv
00		Reserved			
01	0, 1	Field-based	2	Field	0
01	2, 3	Field-based	1	Field	0
10	0, 1, 2, 3	Frame-based	1	Frame	0
11	0, 2, 3	Dual-Prime	1	Field	1

If `frame_pred_frame_dct` is equal to 1 then `frame_motion_type` is omitted from the bitstream. In this case motion vector decoding and prediction formation shall be performed as if `frame_motion_type` had indicated "Frame-based prediction".

In the case of intra macroblocks (in a frame picture) when `concealment_motion_vectors` is equal to 1 `frame_motion_type` is not present in the bitstream. In this case motion vector decoding and update of the motion vector predictors shall be performed as if `frame_motion_type` had indicated "Frame-based" (see 7.6.3.9).

field_motion_type – This is a two bit code indicating the macroblock prediction type, defined in Table 6-18.

Table 6-18 – Meaning of field_motion_type

Code	spatial_temporal_weight_class	Prediction type	motion_vector_count	mv_format	dmv
00		Reserved			
01	0, 1	Field-based	1	Field	0
10	0, 1	16 × 8 MC	2	Field	0
11	0	Dual-Prime	1	Field	1

In the case of intra macroblocks (in a field picture) when concealment_motion_vectors is equal to 1 field_motion_type is not present in the bitstream. In this case, motion vector decoding and update of the motion vector predictors shall be performed as if field_motion_type had indicated "Field-based" (see 7.6.3.9).

dct_type – This is a flag indicating whether the macroblock is frame DCT coded or field DCT coded. If this is set to '1', the macroblock is field DCT coded.

In the case that **dct_type** is not present in the bitstream, then the value of dct_type (used in the remainder of the decoding process) shall be derived as shown in Table 6-19.

Table 6-19 – Value of dct_type if dct_type is not in the bitstream

Condition	dct_type
picture_structure == "field"	Unused because there is no frame/field distinction in a field picture.
frame_pred_frame_dct == 1	0 ("frame")
!(macroblock_intra macroblock_pattern)	Unused – Macroblock is not coded
macroblock is skipped	Unused – Macroblock is not coded

6.3.17.2 Motion vectors

motion_vector_count is derived from field_motion_type or frame_motion_type as indicated in Tables 6-17 and 6-18.

mv_format is derived from field_motion_type or frame_motion_type as indicated in the Tables 6-17 and 6-18. mv_format indicates if the motion vector is a field-motion vector or a frame-motion vector. mv_format is used in the syntax of the motion vectors and in the process of motion vector prediction.

dmv is derived from field_motion_type or frame_motion_type as indicated in Tables 6-17 and 6-18.

motion_vertical_field_select[r][s] – This flag indicates which reference field shall be used to form the prediction. If motion_vertical_field_select[r][s] is zero, then the top reference field shall be used, if it is one then the bottom reference field shall be used. (See Table 7-7 for the meaning of the indices r and s.)

6.3.17.3 Motion vector

motion_code[r][s][t] – This is a variable length code, as defined in Table B.10, which is used in motion vector decoding as described in 7.6.3.1. (See Table 7-7 for the meaning of the indices r, s and t.)

motion_residual[r][s][t] – This is an integer which is used in motion vector decoding as described in 7.6.3.1. (See Table 7-7 for the meaning of the indices r, s and t.) The number of bits in the bitstream for motion_residual[r][s][t], r_size, is derived from f_code[s][t] as follows:

$$r_size = f_code[s][t] - 1$$

NOTE – The number of bits for both motion_residual[0][s][t] and motion_residual[1][s][t] is denoted by f_code[s][t].

dmvector[t] – This is a variable length code, as defined in Table B.11, which is used in motion vector decoding as described in 7.6.3.6. (See Table 7-7 for the meaning of the index t.)

6.3.17.4 Coded block pattern

coded_block_pattern_420 – A variable length code that is used to derive the variable cbp according to Table B.9.

coded_block_pattern_1

coded_block_pattern_2 – For 4:2:2 and 4:4:4 data the coded block pattern is extended by the addition of either a two bit or six bit fixed length code, coded_block_pattern_1 or coded_block_pattern_2. Then the pattern_code[i] is derived using the following:

```

for (i = 0; i < 12; i++) {
    if (macroblock_intra)
        pattern_code[i] = 1;
    else
        pattern_code[i] = 0;
}
if (macroblock_pattern) {
    for (i = 0; i < 6; i++)
        if ( cbp & (1<<(5 - i)) ) pattern_code[i] = 1;
    if (chroma_format == "4:2:2")
        for (i = 6; i < 8; i++)
            if ( coded_block_pattern_1 & (1<<(7 - i)) ) pattern_code[i] = 1;
    if (chroma_format == "4:4:4")
        for (i = 6; i < 12; i++)
            if ( coded_block_pattern_2 & (1<<(11 - i)) ) pattern_code[i] = 1;
}

```

If pattern_code[i] equals to 1, i = 0 to (block_count-1), then the block number i defined in Figures 6-10, 6-11 and 6-12 is contained in this macroblock.

The number "block_count" which determines the number of blocks in the macroblock is derived from the chrominance format as shown in Table 6-20.

Table 6-20 – block_count as a function of chroma_format

chroma_format	block_count
4:2:0	6
4:2:2	8
4:4:4	12

6.3.18 Block

The semantics of block() are described in clause 7.

6.3.19 Camera parameters extension

camera_id – The number in camera_id identifies a camera.

height_of_image_device – This is a 22-bit unsigned integer which specifies the height of image device. Its value shall be measured to a resolution of 0,001 millimeter and having a range of zero to 4 194,303 mm.

focal_length – This is a 22-bit unsigned integer which specifies the focal length. Its value shall be measured to a resolution of 0,001 millimeter and having a range of zero to 4 194,303 mm.

f_number – This is a 22-bit unsigned integer which specifies the F-number. F-number is defined by (focal_length)/(effective aperture of lens). Its value shall be measured to a resolution of 0,001 and having a range of zero to 4 194,303.

vertical_angle_of_view – This is a 22-bit unsigned integer which specifies the vertical angle of the field of view as determined between the top and bottom edges of the image device. Its value shall be measured to a resolution of 0,0001 degree and having a range of zero to 180 degrees.

camera_position_x_upper, camera_position_y_upper, camera_position_z_upper – These words constitute the 16 most significant bits of camera_position_x, camera_position_y and camera_position_z respectively.

camera_position_x_lower, camera_position_y_lower, camera_position_z_lower – These words constitute the 16 least significant bits of camera_position_x, camera_position_y and camera_position_z respectively.

camera_position_x, camera_position_y, camera_position_z – A set of these values specifies the position of the optical principal point of the camera in a user-specified world coordinate system. Each of these values shall be measured to a resolution of 0,001 millimeter and having a range of +2 147 483,647 mm to –2 147 483,648 mm. The camera_position_x is a 32-bit signed (two's complement) integer, the 16 least significant bits are defined in camera_position_x_lower, the 16 most significant bits are defined in camera_position_x_upper. The camera_position_y is a 32-bit signed (two's complement) integer, the 16 least significant bits are defined in camera_position_y_lower, the 16 most significant bits are defined in camera_position_y_upper. The camera_position_z is a 32-bit signed (two's complement) integer, the 16 least significant bits are defined in camera_position_z_lower, the 16 most significant bits are defined in camera_position_z_upper.

camera_direction_x, camera_direction_y, camera_direction_z – A set of these values specifies the direction of the camera. The direction of the camera is defined by using the vector from optical principal point to a point which is in front of the camera and is on the optical axis of the camera. Each of these values is a 22-bit signed (two's complement) integer and having a range of +2 097 151 to –2 097 152.

image_plane_vertical_x, image_plane_vertical_y, image_plane_vertical_z – A set of these values specifies the upper direction of the camera. The upper direction of the camera is defined by using the vector which is parallel to the side edge of the image device and is from bottom edge to top edge. Each of these values is a 22-bit signed (two's complement) integer and is having a range of +2 097 151 to –2 097 152.

Figure 6-17 explains these terms pictorially.

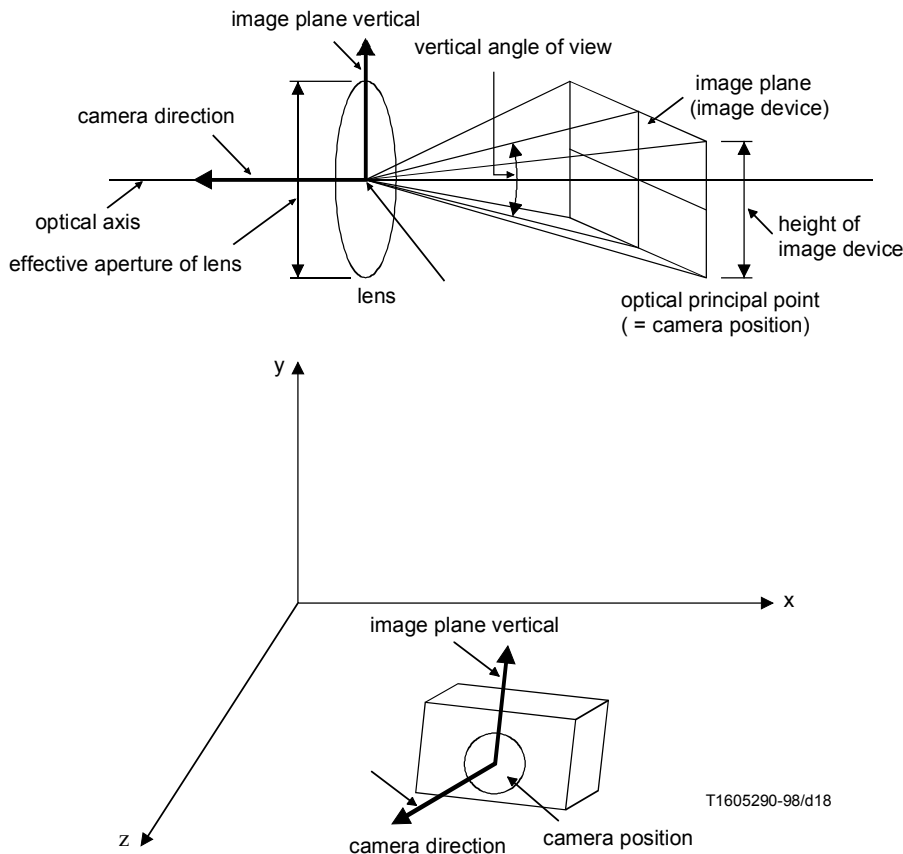

Figure 6-17 -- Camera parameters

6.3.20 ITU-T extension

The use of this extension is defined in Annex A/H.320.

7 The video decoding process

This clause specifies the decoding process that a decoder shall perform to reconstruct frames from the coded bitstream.

The IDCT function $f[y][x]$ used in the decoding process may be any of several approximations of the saturated mathematical integer-number IDCT defined in Annex A. Requirements on the accuracy of the IDCT function used in the decoding process are specified in Annex A.

In 7.1 through 7.6 the simplest decoding process is specified in which no scalability features are used. Subclauses 7.7 to 7.11 specify the decoding process when scalable extensions are used. Subclause 7.12 defines the output of the decoding process.

Figure 7-1 is a diagram of the Video Decoding Process without any scalability. The diagram is simplified for clarity.

NOTE – Throughout this Specification two dimensional arrays are represented as $name[q][p]$ where 'q' is the index in the vertical dimension and 'p' the index in the horizontal dimension.

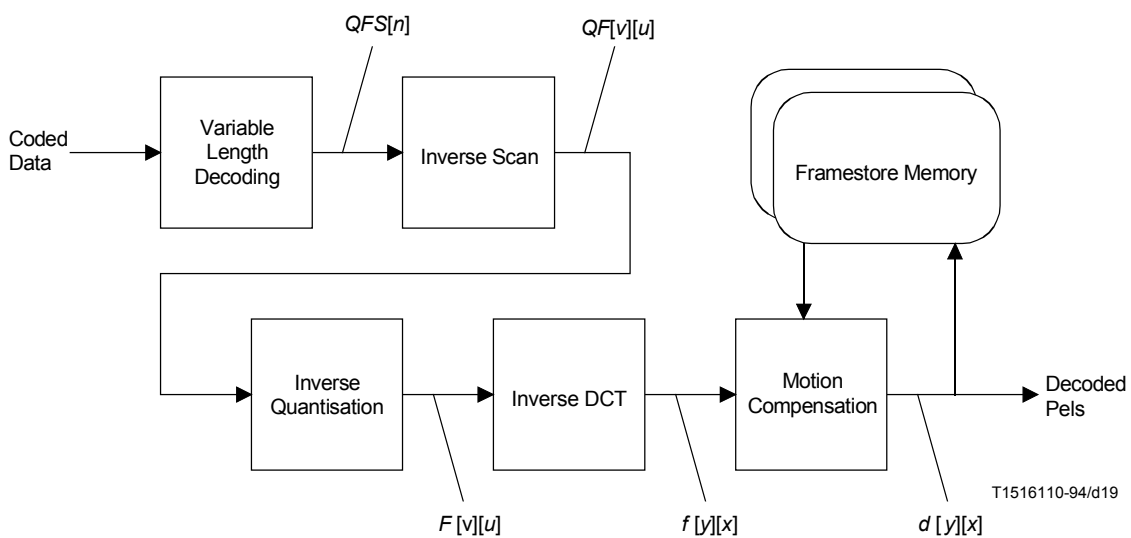

Figure 7-1 – Simplified Video Decoding Process

7.1 Higher syntactic structures

The various parameters and flags in the bitstream for `macroblock()` and all syntactic structures above `macroblock()` shall be interpreted as indicated in clause 6. Many of these parameters and flags affect the decoding process described in the following subclauses. Once all of the macroblocks in a given picture have been processed, the entire picture will have been reconstructed.

Reconstructed fields shall be associated together in pairs to form reconstructed frames. (See "picture_structure" in 6.3.10.)

The sequence of reconstructed frames shall be re-ordered as described in 6.1.1.11.

If `progressive_sequence == 1` the reconstructed frames shall be output from the decoding process at regular intervals of the frame period as shown in Figure 7-19.

If `progressive_sequence == 0` the reconstructed frames shall be broken into a sequence of fields which shall be output from the decoding process at regular intervals of the field period as shown in Figure 7-20. In the case that a frame picture has `repeat_first_field == 1` the first field of the frame shall be repeated after the second field. (See "repeat_first_field" in 6.3.10.)

7.2 Variable length decoding

Subclause 7.2.1 specifies the decoding process used for the DC coefficient ($n = 0$) in an intra coded block. (n is the index of the coefficient in the appropriate zigzag scanning order.) Subclause 7.2.2 specifies the decoding process for all other coefficients, AC coefficients ($n > 0$) and DC coefficients in non-intra coded blocks.

Let cc denote the colour component. It is related to the block number as specified in Table 7-1. Thus, cc is zero for the Y component, one for the Cb component and two for the Cr component.

Table 7-1 – Definition of cc , colour component index

Block Number	cc		
	4:2:0	4:2:2	4:4:4
0	0	0	0
1	0	0	0
2	0	0	0
3	0	0	0
4	1	1	1
5	2	2	2
6		1	1
7		2	2
8			1
9			2
10			1
11			2

7.2.1 DC coefficients in intra blocks

DC coefficients in blocks in intra macroblocks are encoded as a variable length code denoting dct_dc_size as defined in Tables B.12 and B.13. If dct_dc_size is not equal to zero, then this shall be followed by a fixed length code, $dct_dc_differential$, of dct_dc_size bits. A differential value is first recovered from the coded data which is added to a predictor in order to recover the final decoded coefficient.

If cc is zero then Table B.12 shall be used for dct_dc_size . If cc is non-zero, then Table B.13 shall be used for dct_dc_size .

Three predictors are maintained, one for each of the colour components, cc . Each time a DC coefficient in a block in an intra macroblock is decoded the predictor is added to the differential to recover the actual coefficient. Then the predictor shall be set to the value of the coefficient just decoded. At various times, as described below, the predictors shall be reset. The reset value is derived from the parameter $intra_dc_precision$ as specified in Table 7-2.

Table 7-2 – Relation between $intra_dc_precision$ and the predictor reset value

$intra_dc_precision$	Bits of precision	reset value
0	8	128
1	9	256
2	10	512
3	11	1024

The predictors shall be reset to the reset value at the following times:

- At the start of a slice.
- Whenever a non-intra macroblock is decoded.
- Whenever a macroblock is skipped. i.e. when $macroblock_address_increment > 1$.

The predictors are denoted $dct_dc_pred[cc]$.

$QFS[0]$ shall be calculated from dct_dc_size and $dct_dc_differential$ by any process equivalent to:

```

if ( dct_dc_size == 0 ) {
    dct_diff = 0;
} else {
    half_range = 2 ^ ( dct_dc_size - 1 );
    if ( dct_dc_differential >= half_range )
        dct_diff = dct_dc_differential;
    else
        dct_diff = (dct_dc_differential + 1) - (2 * half_range);
}
QFS[0] = dct_dc_pred[cc] + dct_diff;
dct_dc_pred[cc] = QFS[0]

```

NOTE 1 – The symbol ^ denotes power (not XOR).

NOTE 2 – dct_diff and $half_range$ are temporary variables which are not used elsewhere in this Specification.

It is a requirement of the bitstream that $QFS[0]$ shall lie in the range:

$$0 \text{ to } ((2^{(8 + \text{intra_dc_precision}))} - 1)$$

7.2.2 Other coefficients

All coefficients with the exception of the DC intra coefficients shall be encoded using Tables B.14, B.15 and B.16.

In all cases a variable length code shall first be decoded using either Table B.14 or Table B.15. The decoded value of this code denotes one of three courses of action:

- 1) *End of Block* – In this case there are no more coefficients in the block in which case the remainder of the coefficients in the block (those for which no value has yet been decoded) shall be set to zero. This is denoted by "End of block" in the syntax specification of 6.2.6.
- 2) A "normal" coefficient in which a value of *run* and *level* is decoded followed by a single bit, *s*, giving the sign of the coefficient *signed_level* is computed from *level* and *s* as shown below. *run* coefficients shall be set to zero and the subsequent coefficient shall have the value *signed_level*.

```

if (s == 0)
    signed_level = level;
else
    signed_level = (-level);

```

- 3) An "Escape" coded coefficient. In which the values of *run* and *signed_level* are fixed length coded as described in 7.2.2.3.

7.2.2.1 Table selection

Table 7-3 indicates which Table shall be used for decoding the DCT coefficients.

Table 7-3 – Selection of DCT coefficient VLC tables

intra_vlc_format	0	1
intra blocks (macroblock_intra = 1)	B.14	B.15
non-intra blocks (macroblock_intra = 0)	B.14	B.14

7.2.2.2 First coefficient of a non-intra block

In the case of the first coefficient of a non-intra block (a block in a non-intra macroblock) Table B.14 is modified as indicated by Notes 2 and 3 at the foot of that Table.

This modification only affects the entry that represents $run = 0$, $level = \pm 1$. Since it is not possible to encode an End of block as the first coefficient of a block (the block would be "not coded" in this case) no possibility for ambiguity exists.

The positions in the syntax that use this modified Table are denoted by "First DCT coefficient" in the syntax specification of 6.2.6. The remainder of the coefficients are denoted by "Subsequent DCT coefficients".

NOTE – In the case that Table B.14 is used for an intra block, the first coefficient shall be coded as specified in 7.2.1. Table B.14 shall therefore not be modified as the first coefficient that uses Table B.14 is the second coefficient in the block.

7.2.2.3 Escape coding

Many possible combinations of run and level have no variable length code to represent them. In order to encode these statistically rare combinations an Escape coding method is used.

Table B.16 defines the escape coding method. The Escape VLC is followed by a 6-bit fixed length code giving "run". This is followed by a 12-bit fixed length code giving the values of "signed_level".

NOTE – Attention is drawn to the fact that the escape coding method used in this Specification is different to that used in ISO/IEC 11172-2.

7.2.2.4 Summary

To summarise 7.2.2. The variable length decoding process shall be equivalent to the following. At the start of this process n shall take the value zero for non-intra blocks and one for intra blocks.

```

eob_not_read = 1;
while ( eob_not_read )
{
    <decode VLC, decode Escape coded coefficient if required>
    if ( <decoded VLC indicates End of block> ) {
        eob_not_read = 0;
        while ( n < 64 ) {
            QFS[n] = 0;
            n = n + 1;
        }
    } else {
        for ( m = 0; m < run; m++ ) {
            QFS[n] = 0;
            n = n + 1;
        }
        QFS[n] = signed_level
        n = n + 1;
    }
}

```

NOTE – *eob_not_read* and *m* are temporary variables that are not used elsewhere in this Specification.

7.3 Inverse scan

Let the data at the output of the variable length decoder be denoted by $QFS[n]$. n is in the range 0 to 63.

This subclause specifies the way in which the one-dimensional data, $QFS[n]$, is converted into a two-dimensional array of coefficients denoted by $QF[v][u]$. u and v both lie in the range 0 to 7.

Two scan patterns are defined. The scan that shall be used shall be determined by *alternate_scan* which is encoded in the picture coding extension.

Figure 7-2 defines $scan[alternate_scan][v][u]$ for the case that *alternate_scan* is zero. Figure 7-3 defines $scan[alternate_scan][v][u]$ for the case that *alternate_scan* is one.

The inverse scan shall be any process equivalent to the following:

```

for ( v = 0; v < 8; v++ )
    for ( u = 0; u < 8; u++ )
        QF[v][u] = QFS[scan[alternate_scan][v][u]]

```

NOTE – The scan patterns defined here are often referred to as "zigzag scanning order".

		<i>u</i>							
		0	1	2	3	4	5	6	7
<i>v</i>	0	0	1	5	6	14	15	27	28
	1	2	4	7	13	16	26	29	42
	2	3	8	12	17	25	30	41	43
	3	9	11	18	24	31	40	44	53
	4	10	19	23	32	39	45	52	54
	5	20	22	33	38	46	51	55	60
	6	21	34	37	47	50	56	59	61
	7	35	36	48	49	57	58	62	63

Figure 7-2 – Definition of $scan[0][v][u]$

		<i>u</i>							
		0	1	2	3	4	5	6	7
<i>v</i>	0	0	4	6	20	22	36	38	52
	1	1	5	7	21	23	37	39	53
	2	2	8	19	24	34	40	50	54
	3	3	9	18	25	35	41	51	55
	4	10	17	26	30	42	46	56	60
	5	11	16	27	31	43	47	57	61
	6	12	15	28	32	44	48	58	62
	7	13	14	29	33	45	49	59	63

Figure 7-3 – Definition of $scan[1][v][u]$

7.3.1 Inverse scan for matrix download

When the quantisation matrices are downloaded they are encoded in the bitstream in a scan order that is converted into the two-dimensional matrix used in the inverse quantiser in an identical manner to that used for coefficients.

For matrix download the scan defined by Figure 7-2 (i.e. $scan[0][v][u]$) shall always be used.

Let $W[w][v][u]$ denote the weighting matrix in the inverse quantiser (see 7.4.2.1), and $W'[w][n]$ denote the matrix as it is encoded in the bitstream. The matrix download shall then be equivalent to the following:

```

for ( $v = 0; v < 8; v++$ )
  for ( $u = 0; u < 8; u++$ )
     $W[w][v][u] = W'[w][scan[0][v][u]]$ 

```

7.4 Inverse quantisation

The two-dimensional array of coefficients, $QF[v][u]$, is inverse quantised to produce the reconstructed DCT coefficients. This process is essentially a multiplication by the quantiser step size. The quantiser step size is modified by two mechanisms; a weighting matrix is used to modify the step size within a block and a scale factor is used in order that the step size can be modified at the cost of only a few bits (as compared to encoding an entire new weighting matrix).

Figure 7-4 illustrates the overall inverse quantisation process. After the appropriate inverse quantisation arithmetic the resulting coefficients, $F''[v][u]$, are saturated to yield $F'[v][u]$ and then a mismatch control operation is performed to give the final reconstructed DCT coefficients, $F[v][u]$.

NOTE – Attention is drawn to the fact that the method of achieving mismatch control in this Specification is different to that employed by ISO/IEC 11172-2.

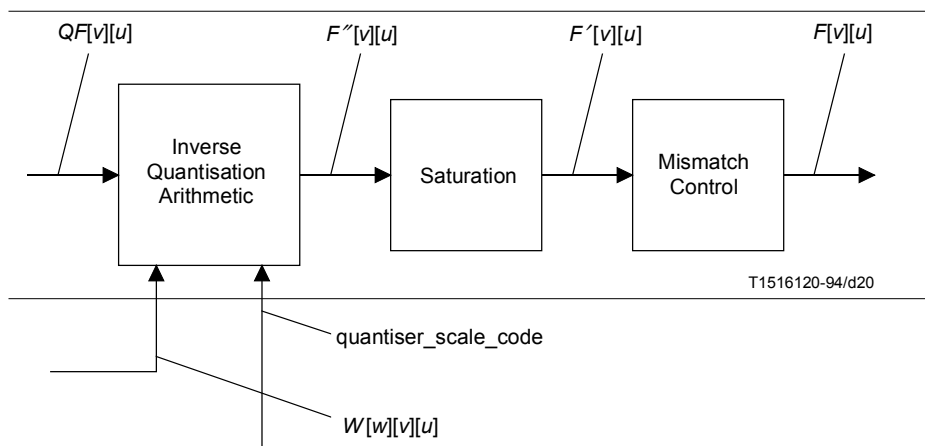

Figure 7-4 – Inverse quantisation process

7.4.1 Intra DC coefficient

The DC coefficients of intra coded blocks shall be inverse quantised in a different manner to all other coefficients.

In intra blocks $F''[0][0]$ shall be obtained by multiplying $QF[0][0]$ by a constant multiplier, *intra_dc_mult*, (constant in the sense that it is not modified by either the weighting matrix or the scale factor). The multiplier is related to the parameter *intra_dc_precision* that is encoded in the picture coding extension. Table 7-4 specifies the relation between *intra_dc_precision* and *intra_dc_mult*.

Thus; $F''[0][0] = \text{intra_dc_mult} \times QF[0][0]$

Table 7-4 – Relation between *intra_dc_precision* and *intra_dc_mult*

<i>intra_dc_precision</i>	Bits of precision	<i>intra_dc_mult</i>
0	8	8
1	9	4
2	10	2
3	11	1

7.4.2 Other coefficients

All coefficients other than the DC coefficient of an intra block shall be inverse quantised as specified in this subclause.

7.4.2.1 Weighting matrices

When 4:2:0 data is used two weighting matrices are used. One shall be used for intra macroblocks and the other for non-intra macroblocks. When 4:2:2 or 4:4:4 data is used, four matrices are used allowing different matrices to be used for luminance and chrominance data. Each matrix has a default set of values which may be overwritten by down-loading a user defined matrix as explained in 6.2.3.2.

Let the weighting matrices be denoted by $W[w][v][u]$ where w takes the values 0 to 3 indicating which of the matrices is being used. Table 7-5 summarises the rules governing the selection of w .

Table 7-5 – Selection of w

	4:2:0		4:2:2 and 4:4:4	
	Luminance (cc = 0)	Chrominance (cc ≠ 0)	Luminance (cc = 0)	Chrominance (cc ≠ 0)
intra blocks (macroblock_intra = 1)	0	0	0	2
non-intra blocks (macroblock_intra = 0)	1	1	1	3

7.4.2.2 Quantiser scale factor

The quantisation scale factor is encoded as a 5-bit fixed length code, `quantiser_scale_code`. This indicates the appropriate *quantiser_scale* to apply in the inverse quantisation arithmetic.

`q_scale_type` (encoded in the picture coding extension) indicates which of two mappings between `quantiser_scale_code` and *quantiser_scale* shall apply. Table 7-6 shows the two mappings between `quantiser_scale_code` and *quantiser_scale*.

7.4.2.3 Reconstruction formulae

The following equation specifies the arithmetic to reconstruct $F''[v][u]$ from $QF[v][u]$ (for all coefficients except intra DC coefficients).

$$F''[v][u] = ((2 \times QF[v][u] + k) \times W[w][v][u] \times \text{quantizer_scale} / 32$$

where:

$$k = \begin{cases} 0 & \text{intra blocks} \\ \text{Sign}(QF[v][u]) & \text{non - intra blocks} \end{cases}$$

NOTE – The above equation uses the "/" operator as defined in 4.1.

7.4.3 Saturation

The coefficients resulting from the Inverse Quantisation Arithmetic are saturated to lie in the range $[-2048:+2047]$. Thus:

$$F'[v][u] = \begin{cases} 2047 & F''[v][u] > 2047 \\ F''[v][u] & -2048 \leq F''[v][u] \leq 2047 \\ -2048 & F''[v][u] < -2048 \end{cases}$$

7.4.4 Mismatch control

Mismatch control shall be performed by any process equivalent to the following. Firstly all of the reconstructed, saturated coefficients, $F'[v][u]$ in the block shall be summed. This value is then tested to determine whether it is odd or even. If the sum is even then a correction shall be made to just one coefficient; $F'[7][7]$. Thus:

$$\text{sum} = \sum_{v=0}^{v < 8} \sum_{u=0}^{u < 8} F'[v][u]$$

$$F[v][u] = F'[v][u] \text{ for all } u, v \text{ except } u = v = 7$$

$$F[7][7] = \begin{cases} F'[7][7] & \text{if sum is odd} \\ \left\{ \begin{array}{l} F'[7][7] - 1 \text{ if } F'[7][7] \text{ is odd} \\ F'[7][7] + 1 \text{ if } F'[7][7] \text{ is even} \end{array} \right\} & \text{if sum is even} \end{cases}$$

NOTE 1 – It may be useful to note that the above correction for $F[7][7]$ may simply be implemented by toggling the least significant bit of the two's complement representation of the coefficient. Also since only the "oddness" or "evenness" of the sum is of interest an exclusive OR (of just the least significant bit) may be used to calculate " sum ".

NOTE 2 – Warning – Small non-zero inputs to the IDCT may result in zero output for compliant IDCTs. If this occurs in an encoder, mismatch may occur in some pictures in a decoder that uses a different compliant IDCT. An encoder should avoid this problem and may do so by checking the output of its own IDCT. It should ensure that it never inserts any non-zero coefficients into the bitstream when the block in question reconstructs to zero through its own IDCT function. If this action is not taken by the encoder, situations can arise where large and very visible mismatches between the state of the encoder and decoder occur.

Table 7-6 – Relation between *quantiser_scale* and *quantiser_scale_code*

quantiser_scale_code	quantiser_scale[q_scale_type]	
	q_scale_type = 0	q_scale_type = 1
0	(Forbidden)	
1	2	1
2	4	2
3	6	3
4	8	4
5	10	5
6	12	6
7	14	7
8	16	8
9	18	10
10	20	12
11	22	14
12	24	16
13	26	18
14	28	20
15	30	22
16	32	24
17	34	28
18	36	32
19	38	36
20	40	40
21	42	44
22	44	48
23	46	52
24	48	56
25	50	64
26	52	72
27	54	80
28	56	88
29	58	96
30	60	104
31	62	112

7.4.5 Summary

In summary the inverse quantisation process is any process numerically equivalent to:

```

for (v = 0; v < 8; v++) {
  for (u = 0; u < 8; u++) {
    if ( (u==0) && (v==0) && (macroblock_intra) ) {
      F''[v][u] = intra_dc_mult * QF[v][u];
    } else {
      if (macroblock_intra) {
        F''[v][u] = ( QF[v][u] * W[w][v][u] * quantiser_scale * 2 ) / 32;
      } else {
        F''[v][u] = ( ( ( QF[v][u] * 2 ) + Sign(QF[v][u]) ) * W[w][v][u]
          * quantiser_scale ) / 32;
      }
    }
  }
}

sum = 0;
for (v = 0; v < 8; v++) {
  for (u = 0; u < 8; u++) {
    if ( F''[v][u] > 2047 ) {
      F'[v][u] = 2047;
    } else {
      if ( F''[v][u] < -2048 ) {
        F'[v][u] = -2048;
      } else {
        F'[v][u] = F''[v][u];
      }
    }
    sum = sum + F'[v][u];
    F[v][u] = F'[v][u];
  }
}

if ((sum & 1) == 0) {
  if ((F[7][7] & 1) != 0) {
    F[7][7] = F'[7][7] - 1;
  } else {
    F[7][7] = F'[7][7] + 1;
  }
}

```

7.5 Inverse DCT

Once the DCT coefficients, $F[v][u]$ are reconstructed, an IDCT transform that conforms to the specifications of Annex A shall be applied to obtain the inverse transformed values $f[y][x]$.

7.5.1 Non-coded blocks and skipped macroblocks

In a macroblock that is not skipped, if $pattern_code[i]$ is one for a given block in the macroblock, then coefficient data is included in the bitstream for that block. This is decoded using as specified in the preceding clauses.

However, if $pattern_code[i]$ is zero, or if the macroblock is skipped, then that block contains no coefficient data. The sample domain coefficients $f[y][x]$ for such a block shall all take the value zero.

7.6 Motion compensation

The motion compensation process forms predictions from previously decoded pictures which are combined with the coefficient data (from the output of the IDCT) in order to recover the final decoded samples. Figure 7-5 shows a simplified diagram of this process.

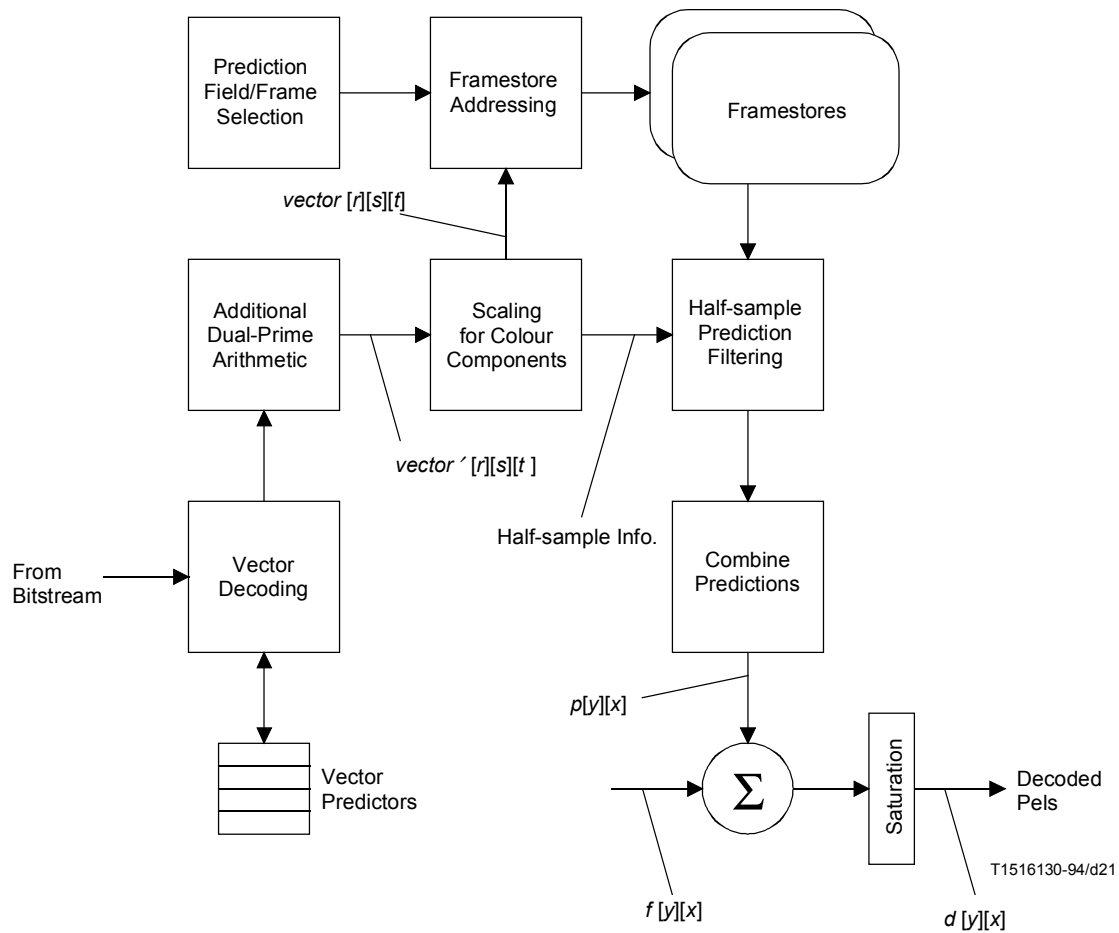

Figure 7-5 – Simplified motion compensation process

In general up to four separate predictions are formed for each block which are combined together to form the final prediction block $p[y][x]$.

In the case of intra coded macroblocks no prediction is formed so that $p[y][x]$ will be zero. The saturation shown in Figure 7-5 is still required in order to remove negative values from $f[y][x]$. Intra coded macroblocks may carry motion vectors known as "concealment motion vectors". Despite this no prediction is formed in the normal course of events. This motion vector information is intended for use in the case that bitstream errors preclude the decoding of coefficient information. The way in which a decoder shall use this information is not specified. The only requirement for these motion vectors is that they shall have the correct syntax for motion vectors. A description of the way in which these motion vectors may be used can be found in 7.6.3.9.

In the case where a block is not coded, either because the entire macroblock is skipped or the specific block is not coded there is no coefficient data. In this case $f[y][x]$ is zero and the decoded samples are simply the prediction, $p[y][x]$.

7.6.1 Prediction modes

There are two major classifications of the prediction mode:

- field prediction; and
- frame prediction.

In field prediction, predictions are made independently for each field by using data from one or more previously decoded fields. Frame prediction forms a prediction for the frame from one or more previously decoded frames. It must be understood that the fields and frames from which predictions are made may themselves have been decoded as either field pictures or frame pictures.

Within a field picture all predictions are field predictions. However, in a frame picture either field predictions or frame predictions may be used (selected on a macroblock-by-macroblock basis).

In addition to the major classification of field or frame prediction two special prediction modes are used:

- *16 × 8 motion compensation* – In which two motion vectors are used for each macroblock. The first motion vector is used for the upper 16 × 8 region, the second for the lower 16 × 8 region. In the case of a bidirectionally predicted macroblock a total of four motion vectors will be used since there will be two for the forward prediction and two for the backward prediction. In this Specification 16 × 8 motion compensation shall only be used with field pictures.
- *Dual-prime* – In which only one motion vector is encoded (in its full format) in the bitstream together with a small differential motion vector. In the case of field pictures two motion vectors are then derived from this information. These are used to form predictions from two reference fields (one top, one bottom) which are averaged to form the final prediction. In the case of frame pictures this process is repeated for the two fields so that a total of four field predictions are made. This mode shall only be used in P-pictures where there are no B-pictures between the predicted and reference fields or frames.

7.6.2 Prediction field and frame selection

The selection of which fields and frames shall be used to form predictions shall be made as detailed in this clause.

7.6.2.1 Field prediction

In P-pictures, the two reference fields from which predictions shall be made are the most recently decoded reference top field and the most recently decoded reference bottom field. The simplest case illustrated in Figure 7-6 shall be used when predicting the first picture of a coded frame or when using field prediction within a frame-picture. In these cases the two reference fields are part of the same reconstructed frame.

NOTE 1 – The reference fields may themselves have been reconstructed from two field-pictures or a single frame-picture.

NOTE 2 – In the case of predicting a field picture, the field being predicted may be either the top field or the bottom field.

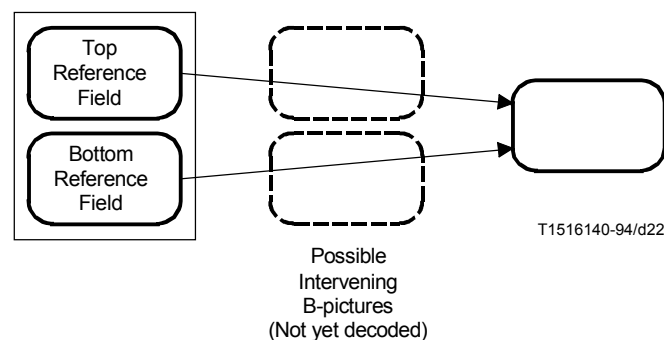

Figure 7-6 – Prediction of the first field or field prediction in a frame-picture

The case when predicting the second field picture of a coded frame is more complicated because the two most recently decoded reference fields shall be used, and in this case, the most recent reference field was obtained from decoding the first field picture of the coded frame. Figure 7-7 illustrates the situation when this second picture is the bottom field. Figure 7-8 illustrates the situation when this second picture is the top field.

NOTE 3 – The earlier reference field may itself have been reconstructed by decoding a field picture or a frame picture.

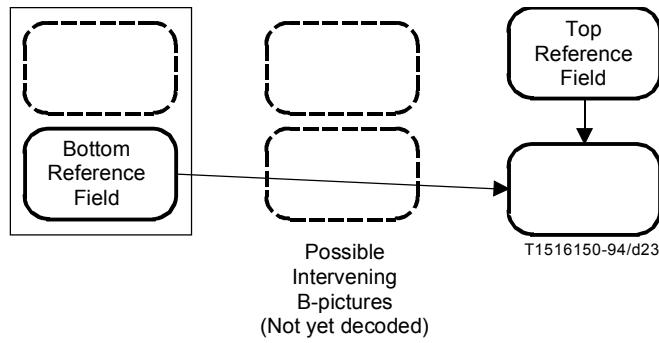

Figure 7-7 – Prediction of the second field-picture when it is the bottom field

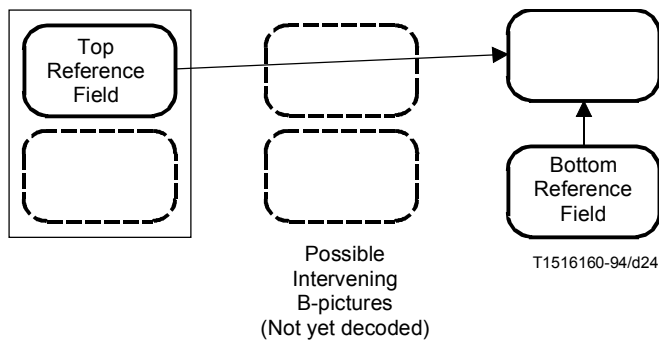

Figure 7-8 – Prediction of the second field-picture when it is the top field

Field prediction in B-pictures shall be made from the two fields of the two most recently reconstructed reference frames. Figure 7-9 illustrates this situation.

NOTE 4 – The reference frames may themselves have been reconstructed from two coded field-pictures or a single coded frame-picture.

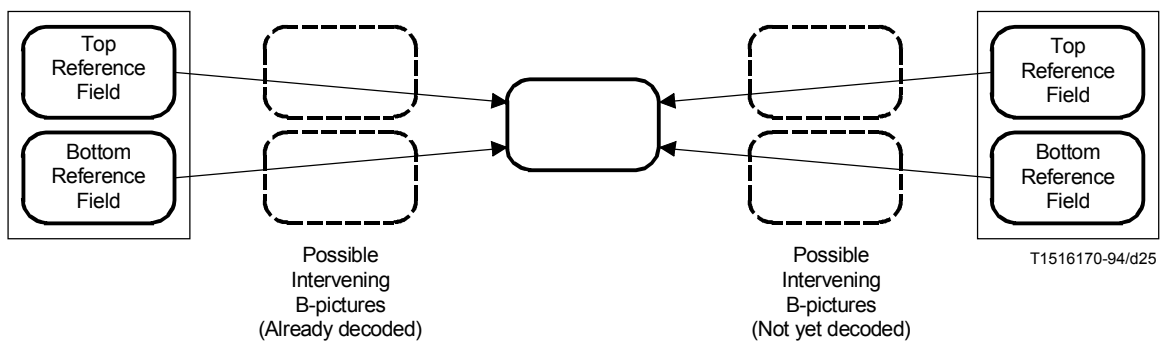

Figure 7-9 – Field-prediction of B-field pictures or B-frame pictures

7.6.2.2 Frame prediction

In P-pictures prediction shall be made from the most recently reconstructed reference frame. This is illustrated in Figure 7-10.

NOTE 1 – The reference frame may itself have been coded as two field pictures or a single frame picture.

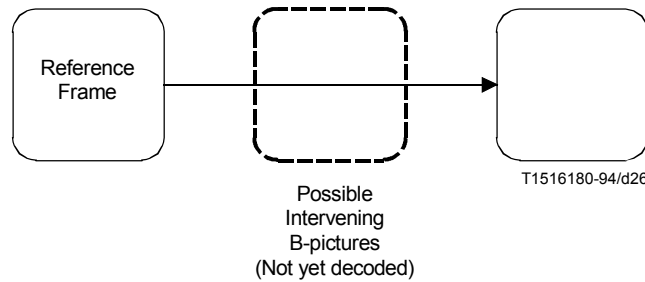

Figure 7-10 – Frame-prediction for I-pictures and P-pictures

Similarly frame prediction in B-pictures shall be made from the two most recently reconstructed reference frames as illustrated in Figure 7-11.

NOTE 2 – The reference frames themselves may each have been coded as either two field pictures or a single frame picture.

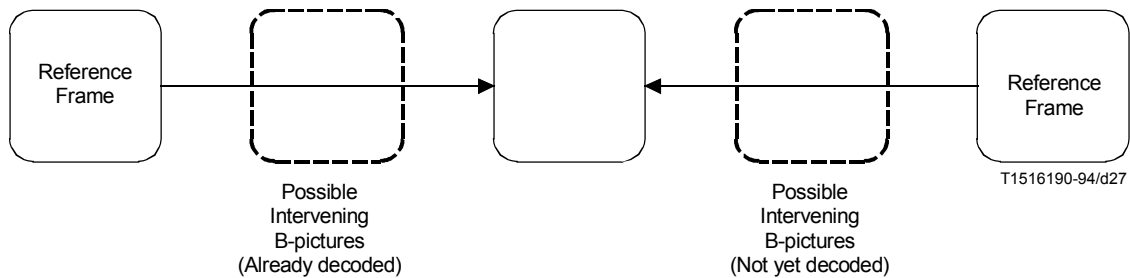

Figure 7-11 – Frame-prediction for B-pictures

7.6.3 Motion vectors

Motion vectors are coded differentially with respect to previously decoded motion vectors in order to reduce the number of bits required to represent them. In order to decode the motion vectors the decoder shall maintain four motion vector predictors (each with a horizontal and vertical component) denoted $PMV[r][s][t]$. For each prediction, a motion vector, $vector'[r][s][t]$ is first derived. This is then scaled depending on the sampling structure (4:2:0, 4:2:2 or 4:4:4) to give a motion vector, $vector[r][s][t]$, for each colour component. The meanings associated with the dimensions in this array are defined in Table 7-7.

Table 7-7 – Meaning of indices in $PMV[r][s][t]$, $vector[r][s][t]$ and $vector'[r][s][t]$

	0	1
r	First motion vector in Macroblock	Second motion vector in Macroblock
s	Forward motion Vector	Backwards motion Vector
t	Horizontal Component	Vertical Component

NOTE – r also takes the values 2 and 3 for derived motion vectors used with dual-prime prediction. Since these motion vectors are derived they do not themselves have motion vector predictors.

7.6.3.1 Decoding the motion vectors

Each motion vector component, $vector[r][s][t]$, shall be calculated by any process that is equivalent to the following one. Note that the motion vector predictors shall also be updated by this process.

```

r_size = f_code[s][t] - 1
f = 1 << r_size
high = ( 16 * f ) - 1;
low = ( (-16) * f );
range = ( 32 * f );

if ( (f == 1) || (motion_code[r][s][t] == 0) )
    delta = motion_code[r][s][t];
else {
    delta = ( ( Abs(motion_code[r][s][t]) - 1 ) * f ) + motion_residual[r][s][t] + 1;
    if (motion_code[r][s][t] < 0)
        delta = - delta;
}

prediction = PMV[r][s][t];
if ( (mv_format == "field") && (t == 1) && (picture_structure == "Frame picture") )
    prediction = PMV[r][s][t] DIV 2;

vector[r][s][t] = prediction + delta;
if (vector[r][s][t] < low )
    vector[r][s][t] = vector[r][s][t] + range;
if (vector[r][s][t] > high)
    vector[r][s][t] = vector[r][s][t] - range;

if ( (mv_format == "field") && (t == 1) && (picture_structure == "Frame picture") )
    PMV[r][s][t] = vector[r][s][t] * 2;
else
    PMV[r][s][t] = vector[r][s][t];

```

The parameters in the bitstream shall be such that the reconstructed differential motion vector, $delta$, shall lie in the range $[low:high]$. In addition the reconstructed motion vector, $vector[r][s][t]$, and the updated value of the motion vector predictor $PMV[r][s][t]$, shall also lie in the range $[low : high]$.

$r_size, f, delta, high, low$ and $range$ are temporary variables that are not used in the remainder of this Specification.

$motion_code[r][s][t]$ and $motion_residual[r][s][t]$ are fields recovered from the bitstream. mv_format is recovered from the bitstream using Tables 6-17 and 6-18.

r, s and t specify the particular motion vector component being processed as identified in Table 7-7.

$vector[r][s][t]$ is the final reconstructed motion vector for the luminance component of the macroblock.

The $vector[r][s][t]$ value considered in this subclause is the one obtained from the pseudo code above. In case of dual-prime, this restriction that $vector[r][s][t]$ shall be in the range $[low:high]$ does not apply to the scaled motion vectors $vector[2:3][0][0:1]$ defined in 7.6.3.6. Other restrictions on motion vectors, including scaled dual-prime motion vectors are specified in 7.6.3.8 and 8.3.

7.6.3.2 Motion vector restrictions

In frame pictures, the vertical component of field motion vectors shall be restricted so that they only cover half the range that is supported by the f_code that relates to those motion vectors. This restriction ensures that the motion vector predictors will always have values that are appropriate for decoding subsequent frame motion vectors. Table 7-8 summarises the size of motion vectors that may be coded as a function of f_code .

7.6.3.3 Updating motion vector predictors

Once all of the motion vectors present in the macroblock have been decoded using the process defined in the previous clause it is sometimes necessary to update other motion vector predictors. This is because in some prediction modes fewer than the maximum possible number of motion vectors are used. The remainder of the predictors that might be used in the picture must retain "sensible" values in case they are subsequently used.

Table 7-8 – Allowable motion vector range as a function of $f_code[s][t]$

$f_code[s][t]$	Vertical components ($t == 1$) of field vectors in frame pictures	All other cases
0	(Forbidden)	
1	[-4: +3.5]	[-8: +7.5]
2	[-8: +7.5]	[-16: +15.5]
3	[-16: +15.5]	[-32: +31.5]
4	[-32: +31.5]	[-64: +63.5]
5	[-64: +63.5]	[-128: +127.5]
6	[-128: +127.5]	[-256: +255.5]
7	[-256: +255.5]	[-512: +511.5]
8	[-512: +511.5]	[-1024: +1023.5]
9	[-1024: +1023.5]	[-2048: +2047.5]
10-14	(Reserved)	
15	(Used when a particular $f_code[s][t]$ will not be used)	

The motion vector predictors shall be updated as specified in Table 7-9 and 7-10. The rules for updating motion vector predictors in the case of skipped macroblocks are specified in 7.6.6.

NOTE – It is possible for an implementation to optimise the updating (and resetting) of motion vector predictors depending on the picture type. For example in a P-picture the predictors for backwards motion vectors are unused and need not be maintained.

Table 7-9 – Updating of motion vector predictors in frame pictures

frame_motion_- type	macroblock_motion_-		macroblock_- intra	Predictors to Update
	forward	backward		
Frame-based ^{a)}	–	–	1	$PMV[1][0][1:0] = PMV[0][0][1:0]$ ^{b)}
Frame-based	1	1	0	$PMV[1][0][1:0] = PMV[0][0][1:0]$ $PMV[1][1][1:0] = PMV[0][1][1:0]$
Frame-based	1	0	0	$PMV[1][0][1:0] = PMV[0][0][1:0]$
Frame-based	0	1	0	$PMV[1][1][1:0] = PMV[0][1][1:0]$
Frame-based ^{a)}	0	0	0	$PMV[r][s][t] = 0$ ^{c)}
Field-based	1	1	0	(None)
Field-based	1	0	0	(None)
Field-based	0	1	0	(None)
Dual prime	1	0	0	$PMV[1][0][1:0] = PMV[0][0][1:0]$

a) **frame_motion_type** is not present in the bitstream but is assumed to be Frame-based.
b) If **concealment_motion_vectors** is zero then $PMV[r][s][t]$ is set to zero (for all r, s and t).
c) (Only occurs in P-picture) $PMV[r][s][t]$ is set to zero (for all r, s and t). See 7.6.3.4.

NOTE – $PMV[r][s][1:0] = PMV[u][v][1:0]$ means that:
 $PMV[r][s][1] = PMV[u][v][1]$ and $PMV[r][s][0] = PMV[u][v][0]$

Table 7-10 – Updating of motion vector predictors in field pictures

frame_motion_ type	macroblock_motion_		macroblock_ intra	Predictors to Update
	forward	backward		
Field-based ^{a)}	–	–	1	$PMV[1][0][1:0] = PMV[0][0][1:0]$ ^{b)}
Field-based	1	1	0	$PMV[1][0][1:0] = PMV[0][0][1:0]$ $PMV[1][1][1:0] = PMV[0][1][1:0]$
Field-based	1	0	0	$PMV[1][0][1:0] = PMV[0][0][1:0]$
Field-based	0	1	0	$PMV[1][1][1:0] = PMV[0][1][1:0]$
Field-based ^{a)}	0	0	0	$PMV[r][s][t] = 0$ ^{c)}
16 × 8 MC	1	1	0	(None)
16 × 8 MC	1	0	0	(None)
16 × 8 MC	0	1	0	(None)
Dual prime	1	0	0	$PMV[1][0][1:0] = PMV[0][0][1:0]$

a) **frame_motion_type** is not present in the bitstream but is assumed to be Field-based.
b) If **concealment_motion_vectors** is zero then $PMV[r][s][t]$ is set to zero (for all r, s and t).
c) (Only occurs in P-picture) $PMV[r][s][t]$ is set to zero (for all r, s and t). See 7.6.3.4.
NOTE – $PMV[r][s][1:0] = PMV[u][v][1:0]$ means that:
 $PMV[r][s][1] = PMV[u][v][1]$ and $PMV[r][s][0] = PMV[u][v][0]$

7.6.3.4 Resetting motion vector predictors

All motion vector predictors shall be reset to zero in the following cases:

- At the start of each slice.
- Whenever an intra macroblock is decoded which has no concealment motion vectors.
- In a P-picture when a non-intra macroblock is decoded in which macroblock_motion_forward is zero.
- In a P-picture when a macroblock is skipped.

7.6.3.5 Prediction in P-pictures

In P-pictures, in the case that macroblock_motion_forward is zero and macroblock_intra is also zero no motion vectors are encoded for the macroblock yet a prediction must be formed. If this occurs in a P-field picture the following apply;

- the prediction type shall be "Field-based";
- the (field) motion vector shall be zero (0;0);
- the motion vector predictors shall be reset to zero;
- predictions shall be made from the field of the same parity as the field being predicted.

If this occurs in a P-frame picture the following apply:

- the prediction type shall be "Frame-based";
- the (frame) motion vector shall be zero (0;0);
- the motion vector predictors shall be reset to zero.

In the case that a P-field picture is used as the second field of a frame in which the first field is an I-field picture a series of semantic restrictions apply. These ensure that prediction is only made from the I field picture. These restrictions are:

- There shall be no macroblocks that are coded with macroblock_motion_forward zero and macroblock_intra zero.
- Dual prime prediction shall not be used.
- Field prediction in which motion_vertical_field_select indicates the same parity as the field being predicted shall not be used.
- There shall be no skipped macroblocks.

7.6.3.6 Dual prime additional arithmetic

In dual prime prediction one field motion vector ($vector^r[0][0][1:0]$) will have been decoded by the process already described. This represents the motion vector used to form predictions from the reference field (or reference fields in a frame picture) of the same parity as the prediction being formed. Here the word "parity" is used to differentiate the two fields. The top field has parity zero, the bottom field has parity one.

In order to form a motion vector for the opposite parity ($vector^r[r][0][1:0]$) the existing motion vector is scaled to reflect the different temporal distance between the fields. A correction is made to the vertical component (to reflect the vertical shift between the lines of top field and bottom field) and then a small differential motion vector is added. This process is illustrated in Figure 7-12 which shows the situation for a frame picture.

$dmvector[0]$ is the horizontal component of the differential motion vector and $dmvector[1]$ the vertical component. The two components of the differential motion vector shall be decoded directly using Table B.11 and shall take only one of the values -1, 0, +1.

$m[parity_ref][parity_pred]$ is the field distance between the predicted field and the reference field as defined in Table 7-11. " $parity_ref$ " is the parity of the reference field for which the new motion vector is being computed. " $parity_pred$ " is the parity of the field that shall be predicted.

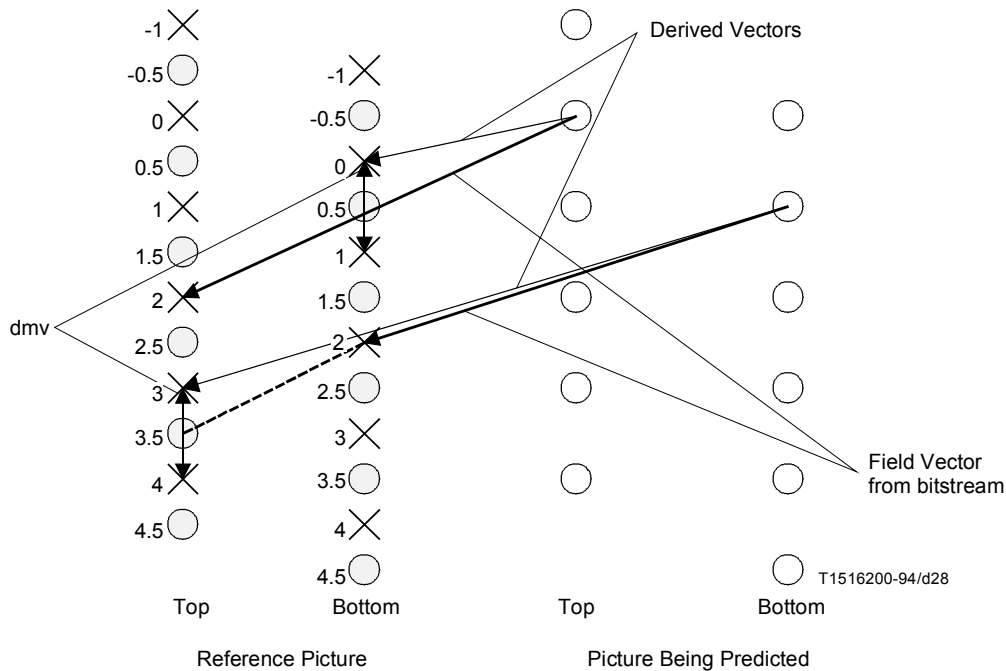

Figure 7-12 – Scaling of motion vectors for dual prime prediction

Table 7-11 – Definition of $m[parity_ref][parity_pred]$

picture_structure	top_field_first	$m[parity_ref][parity_pred]$	
		m[1][0]	m[0][1]
11 (Frame)	1	1	3
11 (Frame)	0	3	1
01 (Top Field)	-	1	-
10 (Bottom Field)	-	-	1

$e[parity_ref][parity_pred]$ is the adjustment necessary to reflect the vertical shift between the lines of top field and bottom field as defined in Table 7-12.

Table 7-12 – Definition of $e[parity_ref][parity_pred]$

$parity_ref$	$parity_pred$	$e[parity_ref][parity_pred]$
0	1	+1
1	0	-1

The motion vector (or motion vectors) used for predictions of opposite parity shall be computed as follows:

$$vector[r][0][0] = ((vector[0][0][0] * m[parity_ref][parity_pred])/2) + dmvector[0];$$

$$vector[r][0][1] = ((vector[0][0][1] * m[parity_ref][parity_pred])/2) + e[parity_ref][parity_pred] + dmvector[1];$$

In the case of field pictures only one such motion vector is required and here $r = 2$. Thus, the (encoded) motion vector used for the same parity prediction is $vector[0][0][1:0]$ and the motion vector used for the opposite parity prediction is $vector[2][0][1:0]$.

In the case of frame pictures two such motion vectors are required. Both fields use the encoded motion vector ($vector[0][0][1:0]$) for predictions of the same parity. The top field shall use $vector[2][0][1:0]$ for opposite parity prediction and the bottom field shall use $vector[3][0][1:0]$ for opposite parity prediction.

7.6.3.7 Motion vectors for chrominance components

The motion vectors calculated in the previous clauses refer to the luminance component where:

$$vector[r][s][t] = vector[r][s][t] \quad (\text{for all } r, s \text{ and } t)$$

For each of the two chrominance components the motion vectors shall be scaled as follows:

4:2:0 Both the horizontal and vertical components of the motion vector are scaled by dividing by two:

$$vector[r][s][0] = vector[r][s][0] / 2;$$

$$vector[r][s][1] = vector[r][s][1] / 2;$$

4:2:2 The horizontal component of the motion vector is scaled by dividing by two, the vertical component is not altered:

$$vector[r][s][0] = vector[r][s][0] / 2;$$

$$vector[r][s][1] = vector[r][s][1];$$

4:4:4 The motion vector is unmodified:

$$vector[r][s][0] = vector[r][s][0];$$

$$vector[r][s][1] = vector[r][s][1];$$

7.6.3.8 Semantic restrictions concerning predictions

It is a requirement on the bitstream that it shall only demand of a decoder that predictions shall be made from slices actually encoded in a reference frame or reference field. This rule applies even for skipped macroblocks and macroblocks in P-pictures in which a zero motion vector is assumed (as explained in 7.6.3.5).

NOTE – As explained in 6.1.2 it is, in general, not necessary for the slices to cover the entire picture. However, in many defined levels of defined profiles the "restricted slice structure" is used in which case the slices do cover the entire picture. In this case the semantic rule may be more simply stated: "it is a restriction on the bitstream that reconstructed motion vectors shall not refer to samples outside the boundary of the coded picture."

7.6.3.9 Concealment motion vectors

Concealment motion vectors are motion vectors that may be carried by intra macroblocks for the purpose of concealing errors if data errors preclude decoding the coefficient data. A concealment motion vector shall be present for all intra macroblocks if (and only if) `concealment_motion_vectors` (in the `picture_coding_extension()`) has the value one.

In the normal course of events no prediction shall be formed for such macroblocks (as would be expected since `macroblock_intra = 1`). This Specification does not specify how error recovery shall be performed. However it is a recommendation that concealment motion vectors are suitable for use by a decoder that performs concealment by forming predictions as if `field_motion_type` and `frame_motion_type` (from which the prediction type is derived) have the following values:

- In a field picture: `field_motion_type = "Field-based"`;
- In a frame picture: `frame_motion_type = "Frame-based"`.

NOTE – If concealment is used in an I-picture then the decoder should perform prediction in a similar way to a P-picture.

Concealment motion vectors are intended for use in the case that a data error results in information being lost. There is therefore little point in encoding the concealment motion vector in the macroblock for which it is intended to be used since if the data error results in the need for error recovery it is very likely that the concealment motion vector itself would be lost or corrupted. As a result the following semantic rules are appropriate:

- For all macroblocks except those in the bottom row of macroblocks concealment motion vectors should be appropriate for use in the macroblock that lies vertically below the macroblock in which the motion vector occurs.
- When the motion vector is used with respect to the macroblock identified in the previous rule a decoder must assume that the motion vector may refer to samples outside of the slices encoded in the reference frame or reference field.
- For all macroblocks in the bottom row of macroblocks the reconstructed concealment motion vectors will not be used. Therefore the motion vector (0;0) may be used to reduce unnecessary overhead.

7.6.4 Forming predictions

Predictions are formed by reading prediction samples from the reference fields or frames. A given sample is predicted by reading the corresponding sample in the reference field or frame offset by the motion vector.

A positive value of the horizontal component of a motion vector indicates that the prediction is made from samples (in the reference field/frame) that lie to the right of the samples being predicted.

A positive value of the vertical component of a motion vector indicates that the prediction is made from samples (in the reference field/frame) that lie below the samples being predicted.

All motion vectors are specified to an accuracy of one half sample. Thus, if a component of the motion vector is odd, the samples will be read from mid-way between the actual samples in the reference field/frame. These half-samples are calculated by simple linear interpolation from the actual samples.

In the case of field-based predictions it is necessary to determine which of the two available fields to use to form the prediction. In the case of dual-prime this is specified in that a motion vector is derived for both of the fields and a prediction is formed from each. In the case of field-based prediction and 16×8 MC an additional bit, `motion_vertical_field_select`, is encoded to indicate which field to use.

If `motion_vertical_field_select` is zero, then the prediction is taken from the top reference field.

If `motion_vertical_field_select` is one, then the prediction is taken from the bottom reference field.

For each prediction block the integer sample motion vectors `int_vec[t]` and the half sample flags `half_flag[t]` shall be formed as follows;

```
for (t = 0; t < 2; t++) {
    int_vec[t] = vector[r][s][t] DIV 2;
    if ((vector[r][s][t] - (2 * int_vec[t]) != 0)
        half_flag[t] = 1;
    else
        half_flag[t] = 0;
}
```

Then for each sample in the prediction block the samples are read and the half sample prediction applied as follows;

```
if ( (! half_flag[0]) && (! half_flag[1]) )
    pel_pred[y][x] = pel_ref[y + int_vec[1]][x + int_vec[0]];

if ( (! half_flag[0]) && half_flag[1] )
    pel_pred[y][x] = ( pel_ref[y + int_vec[1]][x + int_vec[0]] +
        pel_ref[y + int_vec[1]+1][x + int_vec[0]] ) // 2;
```

$$\text{if (half_flag[0]\&\& (! half_flag[1]))}$$

$$\text{pel_pred[y][x] = (pel_ref[y + int_vec[1]][x + int_vec[0]] + }$$

$$\text{pel_ref[y + int_vec[1]][x + int_vec[0]+1]) // 2;}$$

$$\text{if (half_flag[0]\&\& half_flag[1])}$$

$$\text{pel_pred[y][x] = (pel_ref[y + int_vec[1]][x + int_vec[0]] + }$$

$$\text{pel_ref[y + int_vec[1]][x + int_vec[0]+1] + }$$

$$\text{pel_ref[y + int_vec[1]+1][x + int_vec[0]] + }$$

$$\text{pel_ref[y + int_vec[1]+1][x + int_vec[0]+1]) // 4;}$$

where pel_pred[y][x] is the prediction sample being formed and pel_ref[y][x] are samples in the reference field or frame.

7.6.5 Motion vector selection

Table 7-13 shows the prediction modes used in field pictures and Table 7-14 shows the predictions used in frame pictures. In each table the motion vectors that are present in the bitstream are listed in the order in which they appear in the bitstream.

Table 7-13 – Predictions and motion vectors in field pictures

field_ motion_ type	macroblock_motion_ -		macro- block - intra	Motion vector	Prediction formed for
	forward	backward			
Field-based ^{a)}	–	–	1	$\text{vector}[0][0][1:0]$ ^{b)}	None (motion vector is for concealment)
Field-based	1	1	0	$\text{vector}[0][0][1:0]$ $\text{vector}[0][1][1:0]$	Whole field, forward Whole field, backward
Field-based	1	0	0	$\text{vector}[0][0][1:0]$	Whole field, forward
Field-based	0	1	0	$\text{vector}[0][1][1:0]$	Whole field, backward
Field-based ^{a)}	0	0	0	$\text{vector}[0][0][1:0]$ ^{c) d)}	Whole field, forward
16 × 8 MC	1	1	0	$\text{vector}[0][0][1:0]$ $\text{vector}[1][0][1:0]$ $\text{vector}[0][1][1:0]$ $\text{vector}[1][1][1:0]$	Upper 16 × 8 field, forward Lower 16 × 8 field, forward Upper 16 × 8 field, backward Lower 16 × 8 field, backward
16 × 8 MC	1	0	0	$\text{vector}[0][0][1:0]$ $\text{vector}[1][0][1:0]$	Upper 16 × 8 field, forward Lower 16 × 8 field, forward
16 × 8 MC	0	1	0	$\text{vector}[0][1][1:0]$ $\text{vector}[1][1][1:0]$	Upper 16 × 8 field, backward Lower 16 × 8 field, backward
Dual prime	1	0	0	$\text{vector}[0][0][1:0]$ $\text{vector}[2][0][1:0]$ ^{c) e)}	Whole field, from same parity, forward Whole field, from opposite parity, forward

- a) **field_motion_type** is not present in the bitstream but is assumed to be Field-based.
- b) The motion vector is only present if **concealment_motion_vectors** is one.
- c) These motion vectors are not present in the bitstream.
- d) The motion vector is taken to be (0; 0) as explained in 7.6.3.5.
- e) These motion vectors are derived from $\text{vector}[0][0][1:0]$ as described in 7.6.3.6.

NOTE – Motion vectors are listed in the order they appear in the bitstream.

Table 7-14 – Predictions and motion vectors in frame pictures

frame_ motion_ type	macroblock_motion_		macro- block_	Motion vector	Prediction formed for
	forward	backward	intra		
Frame-based ^{a)}	–	–	1	$vector[0][0][1:0]$ ^{b)}	None (motion vector is for concealment)
Frame-based	1	1	0	$vector[0][0][1:0]$ $vector[0][1][1:0]$	Frame, forward Frame, backward
Frame-based	1	0	0	$vector[0][0][1:0]$	Frame, forward
Frame-based	0	1	0	$vector[0][1][1:0]$	Frame, backward
Frame-based ^{a)}	0	0	0	$vector[0][0][1:0]$ ^{c) d)}	Frame, forward
Field-based	1	1	0	$vector[0][0][1:0]$ $vector[1][0][1:0]$ $vector[0][1][1:0]$ $vector[1][1][1:0]$	Top field, forward Bottom field, forward Top field, backward Bottom field, backward
Field-based	1	0	0	$vector[0][0][1:0]$ $vector[1][0][1:0]$	Top field, forward Bottom field, forward
Field-based	0	1	0	$vector[0][1][1:0]$ $vector[1][1][1:0]$	Top field, backward Bottom field, backward
Dual prime	1	0	0	$vector[0][0][1:0]$ $vector[0][0][1:0]$ $vector[2][0][1:0]$ ^{c) e)} $vector[3][0][1:0]$ ^{c) e)}	Top field, from same parity, forward Bottom field, from same parity, forward Top field, from opposite parity, forward Bottom field, from opposite parity, forward

a) **frame_motion_type** is not present in the bitstream but is assumed to be Frame-based.
b) The motion vector is only present if **concealment_motion_vectors** is one.
c) These motion vectors are not present in the bitstream.
d) The motion vector is taken to be (0; 0) as explained in 7.6.3.5.
e) These motion vectors are derived from $vector[0][0][1:0]$ as described in 7.6.3.6.
NOTE – Motion vectors are listed in the order they appear in the bitstream.

7.6.6 Skipped macroblocks

A skipped macroblock is a macroblock for which no data is encoded, that is part of a coded slice. Except at the start of a slice, if the number ($macroblock_address - previous_macroblock_address - 1$) is larger than zero, then this number indicates the number of macroblocks that have been skipped. The decoder shall form a prediction for skipped macroblocks which shall then be used as the final decoded sample values.

The handling of skipped macroblocks is different between P-pictures and B-pictures. In addition, the process differs between field pictures and frame pictures.

There shall be no skipped macroblocks in I-pictures except when either:

- $picture_spatial_scalable_extension()$ follows the $picture_header()$ of the current picture; or
- $sequence_scalable_extension()$ is present in the bitstream and $scalable_mode = "SNR\ scalability"$.

7.6.6.1 P field picture

- the prediction shall be made as if $field_motion_type$ is "Field-based";
- the prediction shall be made from the field of the same parity as the field being predicted;
- motion vector predictors shall be reset to zero;
- the motion vector shall be zero.

7.6.6.2 P frame picture

- the prediction shall be made as if `frame_motion_type` is "Frame-based";
- motion vector predictors shall be reset to zero;
- the motion vector shall be zero.

7.6.6.3 B field picture

- the prediction shall be made as if `field_motion_type` is "Field-based";
- the prediction shall be made from the field of the same parity as the field being predicted;
- the direction of the prediction forward/backward/bi-directional shall be the same as the previous macroblock;
- motion vector predictors are unaffected;
- the motion vectors are taken from the appropriate motion vector predictors. Scaling of the motion vectors for colour components shall be performed as described in 7.6.3.7.

7.6.6.4 B frame picture

- the prediction shall be made as if `frame_motion_type` is "Frame-based";
- the direction of the prediction forward/backward/bi-directional shall be the same as the previous macroblock;
- motion vector predictors are unaffected;
- the motion vectors are taken directly from the appropriate motion vector predictors. Scaling of the motion vectors for colour components shall be performed as described in 7.6.3.7.

7.6.7 Combining predictions

The final stage is to combine the various predictions together in order to form the final prediction blocks.

It is also necessary to organise the data into blocks that are either field organised or frame organised in order to be added directly to the decoded coefficients.

The transform data is either field organised or frame organised as specified by `dct_type`.

7.6.7.1 Simple frame predictions

In the case of simple frame predictions the only further processing that may be required is to average forward and backward predictions in B-pictures. If `pel_pred_forward[y][x]` is the forwards prediction sample and `pel_pred_backward[y][x]` is the corresponding backward prediction, then the final prediction sample shall be formed as:

$$pel_pred[y][x] = (pel_pred_forward[y][x] + pel_pred_backward[y][x]) / 2$$

The predictions for chrominance components of 4:2:0, 4:2:2 and 4:4:4 formats shall be of size 8 samples by 8 lines, 8 samples by 16 lines and 16 samples by 16 lines respectively.

7.6.7.2 Simple field predictions

In the case of simple field predictions (i.e. neither 16×8 or dual prime) the only further processing that may be required is to average forward and backward predictions in B-pictures. This shall be performed as specified for "Frame predictions" in the previous subclause.

In the case of simple field prediction in a frame picture the predictions for chrominance components of 4:2:0, 4:2:2 and 4:4:4 formats for each field shall be of size 8 samples by 4 lines, 8 samples by 8 lines and 16 samples by 8 lines respectively.

In the case of simple field prediction in a field picture the predictions for chrominance components of 4:2:0, 4:2:2 and 4:4:4 formats for each field shall be of size 8 samples by 8 lines, 8 samples by 16 lines and 16 samples by 16 lines respectively.

7.6.7.3 16×8 Motion compensation

In this prediction mode separate predictions are formed for the upper 16×8 region of the macroblock and the lower 16×8 region of the macroblock.

The predictions for chrominance components, for each 16×8 region, of 4:2:0, 4:2:2 and 4:4:4 formats shall be of size 8 samples by 4 lines, 8 samples by 8 lines and 16 samples by 8 lines respectively.

7.6.7.4 Dual prime

In dual prime mode two predictions are formed for each field in an analogous manner to the backward and forward predictions in B-pictures. If $pel_pred_same_parity[y][x]$ is the prediction sample from the same parity field and $pel_pred_opposite_parity[y][x]$ is the corresponding sample from the opposite parity field then the final prediction sample shall be formed as:

$$pel_pred[y][x] = (pel_pred_same_parity[y][x] + pel_pred_opposite_parity[y][x]) // 2;$$

In the case of dual prime prediction in a frame picture, the predictions for chrominance components of each field of 4:2:0, 4:2:2 and 4:4:4 formats shall be of size 8 samples by 4 lines, 8 samples by 8 lines and 16 samples by 8 lines respectively.

In the case of dual prime prediction in a field picture, the predictions for chrominance components of 4:2:0, 4:2:2 and 4:4:4 formats shall be of size 8 samples by 8 lines, 8 samples by 16 lines and 16 samples by 16 lines respectively.

7.6.8 Adding prediction and coefficient data

The prediction blocks have been formed and reorganised into blocks of prediction samples $p[y][x]$ which match the field/frame structure used by the transform data blocks.

The transform data $f[y][x]$ shall be added to the prediction data and saturated to form the final decoded samples $d[y][x]$ as follows:

```

for (y = 0; y < 8; y++) {
    for (x = 0; x < 8; x++) {
        d[y][x] = f[y][x] + p[y][x];
        if (d[y][x] < 0) d[y][x] = 0;
        if (d[y][x] > 255) d[y][x] = 255;
    }
}

```

7.7 Spatial scalability

This subclause specifies the additional decoding process required for the spatial scalable extensions.

Both the lower layer and the enhancement layer shall use the "restricted slice structure" (no gaps between slices).

Figure 7-13 is a diagram of the video decoding process with spatial scalability. The diagram is simplified for clarity.

7.7.1 Higher syntactic structures

In general, the base layer of a spatial scalable hierarchy can conform to any coding standard including Recommendation H.261, ISO/IEC 11172-2 and this Specification. Note however, that within this Specification the decodability of a spatial scalable hierarchy is only considered in the case that the base layer conforms to this Specification or ISO/IEC 11172-2.

Due to the "loose coupling" of layers only one syntactic restriction is needed in the enhancement layer if both lower and enhancement layer are interlaced. In that case `picture_structure` has to take the same value as in the reference frame used for prediction from the lower layer. See 7.7.3.1 for how to identify this reference frame.

7.7.2 Prediction in the enhancement layer

A motion compensated temporal prediction is made from reference frames in the enhancement layer as described in 7.6. In addition, a spatial prediction is formed from the lower layer decoded frame ($d_{lower}[y][x]$), as described in 7.7.3. These predictions are selected individually or combined to form the actual prediction.

In general, up to four separate predictions are formed for each macroblock which are combined together to form the final prediction macroblock $p[y][x]$.

In the case that a macroblock is not coded, either because the entire macroblock is skipped or the specific macroblock is not coded, there is no coefficient data. In this case $f[y][x]$ is zero and the decoded samples are simply the prediction, $p[y][x]$.

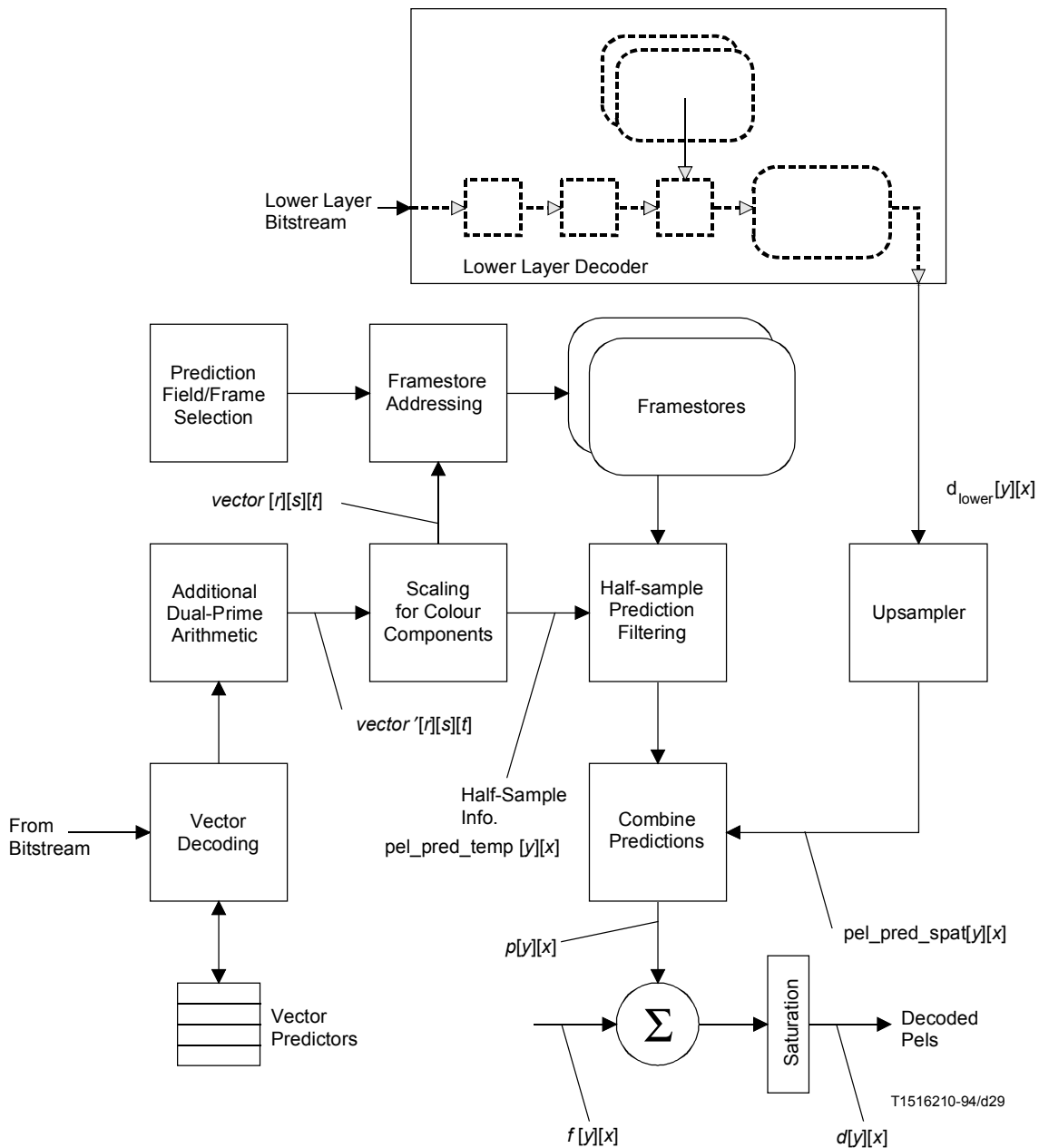

Figure 7-13 – Simplified motion compensation process for spatial scalability

7.7.3 Formation of spatial prediction

Forming the spatial prediction requires identification of the correct reference frame and definition of the spatial resampling process, which is done in the following subclauses.

The resampling process is defined for a whole frame, however, for decoding of a macroblock, only the 16×16 region in the upsampled frame, which corresponds to the position of this macroblock, is needed.

7.7.3.1 Selection of reference frame

The spatial prediction is made from the reconstructed frame of the lower layer referenced by the lower_layer_temporal_reference. However, if lower and enhancement layer bitstreams are embedded in ITU-T Rec. H.220.0 | ISO/IEC 13818-1 (Systems) multiplex, this information is overridden by the timing information given by the decoding time stamps (DTS) in the PES headers.

NOTE – If group_of_pictures_header() occurs often in the lower layer bitstream, then the temporal reference in the lower layer may be ambiguous (because temporal_reference is reset after a group_of_pictures_header()).

The reconstructed picture from which the spatial prediction is made shall be one of the following:

- The coincident or most recently decoded lower layer picture.
- The coincident or most recently decoded lower layer I-picture or P-picture.
- The second most recently decoded lower layer I-picture or P-picture provided that the lower layer does not have `low_delay` set to '1'. Note furthermore that spatial scalability will only work efficiently when predictions are formed from frames in the lower layer which are also coincident (or very close) in display time with the predicted frame in the enhancement layer.

7.7.3.2 Resampling process

The spatial prediction is made by resampling the lower layer reconstructed frame to the same sample grid as the enhancement layer. This grid is defined in terms of frame coordinates, even if a lower-layer interlaced frame was actually coded with a pair of field pictures.

This resampling process is illustrated in Figure 7-14.

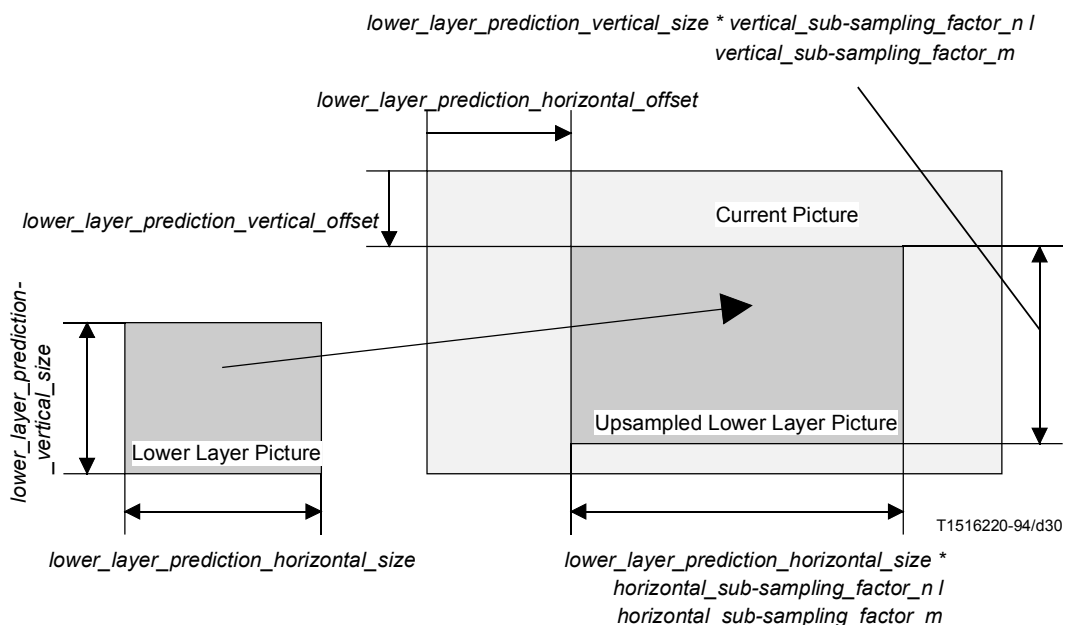

Figure 7-14 – Formation of the "spatial" prediction by interpolation of the lower layer picture

Spatial predictions shall only be made for macroblocks in the enhancement layer that lie wholly within the upsampled lower layer reconstructed frame.

The upsampling process depends on whether the lower layer reconstructed frame is interlaced or progressive, as indicated by `lower_layer_progressive_frame` and whether the enhancement layer frame is interlaced or progressive, as indicated by `progressive_frame`.

When `lower_layer_progressive_frame` is '1', the lower layer reconstructed frame (renamed to `prog_pic`) is resampled vertically as described in 7.7.3.4. The resulting frame is considered to be progressive if `progressive_frame` is '1' and interlaced if `progressive_frame` is '0'. The resulting frame is resampled horizontally as described in 7.7.3.6. `lower_layer_deinterlaced_field_select` shall have the value '1'.

When `lower_layer_progressive_frame` is '0' and `progressive_frame` is '0', each lower layer reconstructed field is deinterlaced as described in 7.7.3.4, to produce a progressive field (`prog_pic`). This field is resampled vertically as described in 7.7.3.5. The resulting field is resampled horizontally as described in 7.7.3.6. Finally the resulting field is subsampled to produce an interlaced field. `lower_layer_deinterlaced_field_select` shall have the value '1'.

When `lower_layer_progressive_frame` is '0' and `progressive_frame` is '1', each lower layer reconstructed field is deinterlaced as described in 7.7.3.4, to produce a progressive field (`prog_pic`). Only one of these fields is required. When `lower_layer_deinterlaced_field_select` is '0' the top field is used, otherwise the bottom field is used. The one that is used is resampled vertically as described in 7.7.3.5. The resulting frame is resampled horizontally as described in 7.7.3.6.

For interlaced frames, if the current (and implicitly the lower-layer) frames are encoded as field pictures, the deinterlacing process described in 7.7.3.5 is done within the field.

lower_layer_vertical_offset and lower_layer_horizontal_offset, defining the position of the lower layer frame within the current frame, shall be taken into account in the resampling definitions in 7.7.3.5 and 7.7.3.6 respectively. The lower layer offsets are limited to even values when the chrominance in the enhancement layer is subsampled in that dimension in order to align the chrominance samples between the two layers.

The upsampling process is summarised Table 7-15.

Table 7-15 – Upsampling process

lower_layer_deinterlaced_field_select	lower_layer_progressive_frame	progressive_frame	Apply deinterlace process	Entity used for prediction
0	0	1	Yes	Top field
1	0	1	Yes	Bottom field
1	1	1	No	Frame
1	1	0	No	Frame
1	0	0	Yes	Both fields

7.7.3.3 Colour component processing

Due to the different sampling grids of luminance and chrominance components, some variables used in 7.7.3.4 to 7.7.3.6 take different values for luminance and chrominance resampling. Furthermore it is permissible for the chrominance formats in the lower layer and the enhancement layer to be different from one another.

Table 7-16 defines the values for the variables used in 7.7.3.4 to 7.7.3.6

Table 7-16 – Local variables used in 7.7.3.3 to 7.7.3.6

Variable	Value for luminance processing	Value for chrominance processing
ll_h_size	lower_layer_prediction_horizontal_size	lower_layer_prediction_horizontal_size / chroma_ratio_horizontal[lower]
ll_v_size	lower_layer_prediction_vertical_size	lower_layer_prediction_vertical_size / chroma_ratio_vertical[lower]
ll_h_offset	lower_layer_horizontal_offset	lower_layer_horizontal_offset / chroma_ratio_horizontal[enhance]
ll_v_offset	lower_layer_vertical_offset	lower_layer_vertical_offset / chroma_ratio_vertical[enhance]
h_subs_m	horizontal_subsampling_factor_m	horizontal_subsampling_factor_m
h_subs_n	horizontal_subsampling_factor_n	horizontal_subsampling_factor_n * format_ratio_horizontal
v_subs_m	vertical_subsampling_factor_m	vertical_subsampling_factor_m
v_subs_n	vertical_subsampling_factor_n	vertical_subsampling_factor_n * format_ratio_vertical

Tables 7-17 and 7-18 give additional definitions.

Table 7-17 – chrominance subsampling ratios for layer = {lower, enhance}

Chrominance format lower layer	chroma_ratio_ horizontal[layer]	chroma_ratio_ vertical[layer]
4:2:0	2	2
4:2:2	2	1
4:4:4	1	1

Table 7-18 – Chrominance format ratios

Chrominance format lower layer	Chrominance format enhancement layer	format_ratio_ horizontal	format_ratio_ vertical
4:2:0	4:2:0	1	1
4:2:0	4:2:2	1	2
4:2:0	4:4:4	2	2
4:2:2	4:2:2	1	1
4:2:2	4:4:4	2	1
4:4:4	4:4:4	1	1

7.7.3.4 Deinterlacing

If deinterlacing needs not to be done (according to Table 7-16), the lower layer reconstructed frame ($d_{\text{lower}}[y][x]$) is renamed to `input_pic`.

First, each lower layer field is padded with zeros to form a progressive grid at a frame rate equal to the field rate of the lower layer, and with the same number of lines and samples per line as the lower layer frame. Table 7-19 specifies the filters to be applied next. The luminance component is filtered using the relevant two field aperture filter if `picture_structure == "Frame-Picture"` or else using the one field aperture filter. The chrominance component is filtered using the one field aperture filter.

Table 7-19 – Deinterlacing Filter

Temporal	Vertical	Two field aperture		One field aperture
		Filter for first field	Filter for second field	Filter (both fields)
-1	-2	0	-1	0
-1	0	0	2	0
-1	2	0	-1	0
0	-1	8	8	8
0	0	16	16	16
0	1	8	8	8
1	-2	-1	0	0
1	0	2	0	0
1	+2	-1	0	0

ISO/IEC 13818-2 : 2000 (E)

The temporal and vertical columns of Table 7-19 indicate the relative spatial and temporal coordinates of the samples to which the filter taps defined in the other two columns apply. An intermediate sum is formed by adding the multiplied coefficients together.

The output of the filter (sum) is then scaled according to the following formula:

$$\text{prog_pic}[y][x] = \text{sum} // 16$$

and saturated to lie in the range [0:255].

The filter aperture can extend outside the coded picture size. In this case the samples of the lines outside the active picture shall take the value of the closest neighbouring existing sample (below or above) of the same field as defined below.

For all samples [y][x]:

```
if (y < 0 && (y&1 == 1))
    y = 1
if (y < 0 && (y&1 == 0))
    y = 0
if (y >= ll_v_size &&
    ((y-ll_v_size)&1 == 1))
    y = ll_v_size - 1
if (y >= ll_v_size &&
    ((y-ll_v_size)&1 == 0))
    y = ll_v_size - 2
```

7.7.3.5 Vertical resampling

The frame subject to vertical resampling, prog_pic, is resampled to the enhancement layer vertical sampling grid using linear interpolation between the sample sites according to the following formula, where vert_pic is the resulting field:

$$\text{vert_pic}[y_h + ll_v_offset][x] = (16 - \text{phase}) * \text{prog_pic}[y_1][x] + \text{phase} * \text{prog_pic}[y_2][x]$$

where

```
y_h + ll_v_offset = output sample co-ordinate in vert_pic
y_1                = (y_h * v_subs_m) / v_subs_n
y_2                = y_1 + 1   if y_1 < ll_v_size - 1
                    y_1       otherwise
phase              = (16 * ((y_h * v_subs_m) % v_subs_n)) // v_subs_n
```

Samples which lie outside the lower layer reconstructed frame which are required for upsampling are obtained by border extension of the lower layer reconstructed frame.

NOTE – The calculation of phase assumes that the sample position in the enhancement layer at $y_h = 0$ is spatially coincident with the first sample position of the lower layer. It is recognised that this is an approximation for the chrominance component if the `chroma_format == 4:2:0`.

7.7.3.6 Horizontal resampling

The frame subject to horizontal resampling, vert_pic, is resampled to the enhancement layer horizontal sampling grid using linear interpolation between the sample sites according to the following formula, where hor_pic is the resulting field:

$$\text{hor_pic}[y][x_h + ll_h_offset] = ((16 - \text{phase}) * \text{vert_pic}[y][x_1] + \text{phase} * \text{vert_pic}[y][x_2]) // 256$$

where

$$\begin{aligned}
 x_h + ll_h_offset &= \text{output sample coordinate in hor_pic} \\
 x1 &= (x_h * h_subs_m) / h_subs_n \\
 x2 &= x1 + 1 \quad \text{if } x1 < ll_h_size - 1 \\
 &\quad x1 \quad \text{otherwise} \\
 \text{phase} &= (16 * ((x_h * h_subs_m) \% h_subs_n)) // h_subs_n
 \end{aligned}$$

Samples which lie outside the lower layer reconstructed frame which are required for upsampling are obtained by border extension of the lower layer reconstructed frame.

7.7.3.7 Reinterlacing

If reinterlacing needs not to be done, the result of the resampling process, hor_pic, is renamed to spat_pred_pic.

If hor_pic was derived from the top field of a lower layer interlaced frame, the even lines of hor_pic are copied to the even lines of spat_pred_pic.

If hor_pic was derived from the bottom field of a lower layer interlaced frame the odd lines of hor_pic are copied to the odd lines of spat_pred_pic.

If hor_pic was derived from a lower layer progressive frame, hor_pic is copied to spat_pred_pic.

7.7.4 Selection and combination of spatial and temporal predictions

The spatial and temporal predictions can be selected or combined to form the actual prediction. The macroblock_type (see Tables B.5, B.6 and B.7) and the additional spatial_temporal_weight_code (see Table 7-21) indicate, by use of the spatial_temporal_weight_class, whether the prediction is temporal-only, spatial-only or a weighted combination of temporal and spatial predictions. Classes are defined in the following way:

- Class 0 indicates temporal-only prediction;
- Class 1 indicates that neither field has spatial-only prediction;
- Class 2 indicates that the top field is spatial-only prediction;
- Class 3 indicates that the bottom field is spatial-only prediction;
- Class 4 indicates spatial-only prediction.

In intra pictures, if spatial_temporal_weight_class is 0, normal intra coding is performed, otherwise the prediction is spatial-only. In predicted and interpolated pictures, if the spatial_temporal_weight_class is 0, prediction is temporal-only, if the spatial_temporal_weight_class is 4, prediction is spatial-only, otherwise one or a pair of prediction weights is used to combine the spatial and temporal predictions.

The possible spatial_temporal_weights are given in a weight table which is selected in the picture spatial scalable extension. Up to four different weight tables are available for use depending on whether the current and lower layers are interlaced or progressive, as indicated in Table 7-20 (allowed, yet not recommended values given in brackets).

Table 7-20 – Intended (allowed) spatial_temporal_weight_code_table_index values

Lower layer format	Enhancement layer format	spatial_temporal_weight_code_table_index
Progressive or interlaced	Progressive	00
Progressive coincident with enhancement layer top fields	Interlaced	10 (00; 01; 11)
Progressive coincident with enhancement layer from bottom fields	Interlaced	01 (00; 10; 11)
Interlaced (picture_structure == Frame-Picture)	Interlaced	00 or 11 (01; 10)
Interlaced (picture_structure != Frame-Picture)	Interlaced	00

In macroblock_modes(), a two bit code, spatial_temporal_weight_code, is used to describe the prediction for each field (or frame), as shown in the Table 7-21. In this table spatial_temporal_integer_weight identifies those spatial_temporal_weight_codes that can also be used with dual prime prediction (see Tables 7-22, 7-23).

Table 7-21 – spatial_temporal_weights and spatial_temporal_weight_classes for the spatial_temporal_weight_code_table_index and spatial_temporal_weight_codes

spatial_temporal_weight_code_table_index	spatial_temporal_weight_code	spatial_temporal_weight (s)	spatial_temporal_weight_class	spatial_temporal_integer_weight
00 ^{a)}	–	(0,5)	1	0
01	00	(0; 1)	3	1
	01	(0; 0,5)	1	0
	10	(0,5; 1)	3	0
	11	(0,5; 0,5)	1	0
10	00	(1; 0)	2	1
	01	(0,5; 0)	1	0
	10	(1; 0,5)	2	0
	11	(0,5; 0,5)	1	0
11	00	(1; 0)	2	1
	01	(1; 0,5)	2	0
	10	(0,5; 1)	3	0
	11	(0,5; 0,5)	1	0
^{a)} For spatial_temporal_weight_code_table_index == 00 no spatial_temporal_weight_code is transmitted.				

NOTE – Spatial-only prediction (weight_class == 4) is signalled by different values of macroblock_type (see Tables B.5 to B.7).

When the spatial_temporal_weight combination is given in the form (a; b), "a" gives the proportion of the prediction for the top field which is derived from the spatial prediction and "b" gives the proportion of the prediction for the bottom field which is derived from the spatial prediction for that field.

When the spatial_temporal_weight is given in the form (a), "a" gives the proportion of the prediction for the picture which is derived from the spatial prediction for that picture.

The precise method for predictor calculation is as follows:

pel_pred_temp[y][x] is used to denote the temporal prediction (formed within the enhancement layer) as defined for pel_pred[y][x] in 7.6. pel_pred_spat[y][x] is used to denote the prediction formed from the lower layer by extracting the appropriate samples, co-located with the current macroblock position, from spat_pred_pic.

If the spatial_temporal_weight is zero, then no prediction is made from the lower layer. Therefore:

$$\text{pel_pred}[y][x] = \text{pel_pred_temp}[y][x];$$

If the spatial_temporal_weight is one, then no prediction is made from the enhancement layer. Therefore:

$$\text{pel_pred}[y][x] = \text{pel_pred_spat}[y][x];$$

If the weight is one half then the prediction is the average of the temporal and spatial predictions. Therefore:

$$\text{pel_pred}[y][x] = (\text{pel_pred_temp}[y][x] + \text{pel_pred_spat}[y][x])//2;$$

When progressive_frame == 0 chrominance is treated as interlaced, that is, the first weight is used for the top field chrominance lines and the second weight is used for the bottom field chrominance lines.

Addition of prediction and coefficient data is then done as in 7.6.8.

7.7.5 Updating motion vector predictors and motion vector selection

In frame pictures where field prediction is used the possibility exists that one of the fields is predicted using spatial-only prediction. In this case no motion vector is present in the bitstream for the field which has spatial-only prediction. For the case where both fields of a frame have spatial-only prediction, the macroblock_type is such that no motion vectors are present in the bitstream for that macroblock.

The spatial_temporal_weight_class also indicates the number of motion vectors which are present in the coded bitstream and how the motion vector predictors are updated as defined in Table 7-22 and Table 7-23.

Table 7-22 – Updating of motion vector predictors in Field Pictures

frame_motion_type	macroblock_motion_forward				Predictors to update
	macroblock_motion_backward				
	macroblock_intra				
	spatial_temporal_weight_class				
Field-based ^{a)}	–	–	1	0	$PMV[1][0][1:0] = PMV[0][0][1:0]$ ^{b)}
Field-based	1	1	0	0	$PMV[1][0][1:0] = PMV[0][0][1:0]$ $PMV[1][1][1:0] = PMV[0][1][1:0]$
Field-based	1	0	0	0,1	$PMV[1][0][1:0] = PMV[0][0][1:0]$
Field-based	0	1	0	0,1	$PMV[1][1][1:0] = PMV[0][1][1:0]$
Field-based ^{a)}	0	0	0	0,1,4	$PMV[r][s][t] = 0$ ^{c)}
16 × 8 MC	1	1	0	0	(None)
16 × 8 MC	1	0	0	0,1	(None)
16 × 8 MC	0	1	0	0,1	(None)
Dual prime	1	0	0	0	$PMV[1][0][1:0] = PMV[0][0][1:0]$

a) **field_motion_type** is not present in the bitstream but is assumed to be Field-based.
b) If **concealment_motion_vectors** is zero then $PMV[r][s][t]$ is set to zero (for all r, s and t).
c) $PMV[r][s][t]$ is set to zero (for all r, s and t). See 7.6.3.4.

NOTE – $PMV[r][s][1:0] = PMV[u][v][1:0]$ means that:
 $PMV[r][s][1] = PMV[u][v][1]$ and $PMV[r][s][0] = PMV[u][v][0]$

7.7.5.1 Resetting motion vector predictors

In addition to the cases identified in 7.6.3.4, the motion vector predictors shall be reset in the following cases:

- In a P-picture when a macroblock is purely spatially predicted (spatial_temporal_weight_class == 4)
- In a B-picture when a macroblock is purely spatially predicted (spatial_temporal_weight_class == 4)

NOTE – In case of spatial_temporal_weight_class == 2 in a frame picture when field-based prediction is used, the transmitted vector is applied for the *bottom* field (see Table 7-25). However this vector[0][s][1:0] is predicted from PMV[0][s][1:0]. PMV[1][s][1:0] is then updated as shown in Table 7-23.

7.7.6 Skipped macroblocks

In all cases, a skipped macroblock is the result of a prediction only, and all the DCT coefficients are considered to be zero.

If sequence_scalable_extension is present and scalable_mode = "spatial scalability", the following rules apply in addition to those given in 7.6.6.

Table 7-23 – Updating of motion vector predictors in Frame Pictures

frame_motion_type	macroblock_motion_forward				Predictors to update
	macroblock_motion_backward				
	macroblock_intra				
	spatial_temporal_weight_class				
Frame-based ^{a)}	–	–	1	0	$PMV[1][0][1:0] = PMV[0][0][1:0]^c)$
Frame-based	1	1	0	0	$PMV[1][0][1:0] = PMV[0][0][1:0]$ $PMV[1][1][1:0] = PMV[0][1][1:0]$
Frame-based	1	0	0	0,1,2,3	$PMV[1][0][1:0] = PMV[0][0][1:0]$
Frame-based	0	1	0	0,1,2,3	$PMV[1][1][1:0] = PMV[0][1][1:0]$
Frame-based ^{a)}	0	0	0	0,1,2,3,4	$PMV[r][s][t] = 0^d)$
Field-based	1	1	0	0	(None)
Field-based	1	0	0	0,1	(None)
Field-based	1	0	0	2	$PMV[1][0][1:0] = PMV[0][0][1:0]$
Field-based	1	0	0	3	$PMV[1][0][1:0] = PMV[0][0][1:0]$
Field-based	0	1	0	0,1	(None)
Field-based	0	1	0	2	$PMV[1][1][1:0] = PMV[0][1][1:0]$
Field-based	0	1	0	3	$PMV[1][1][1:0] = PMV[0][1][1:0]$
Dual prime ^{b)}	1	0	0	0,2,3	$PMV[1][0][1:0] = PMV[0][0][1:0]$

a) **frame_motion_type** is not present in the bitstream but is assumed to be Frame-based.

b) Dual prime can not be used when spatial_temporal_integer_weight = '0'.

c) If **concealment_motion_vectors** is zero then $PMV[r][s][t]$ is set to zero (for all r , s and t).

d) $PMV[r][s][t]$ is set to zero (for all r , s and t). See 7.6.3.4.

NOTE $-PMV[r][s][1:0] = PMV[u][v][1:0]$ means that:
 $PMV[r][s][1] = PMV[u][v][1]$ and $PMV[r][s][0] = PMV[u][v][0]$

In I-pictures, skipped macroblocks are allowed. These are defined as spatial-only predicted.

In P-pictures and B-pictures, the skipped macroblock is temporal-only predicted.

In B-pictures a skipped macroblock shall not follow a spatial-only predicted macroblock.

7.7.7 VBV buffer underflow in the lower layer

In the case of spatial scalability, VBV buffer underflow in the lower layer may cause problems. This is because of possible uncertainty in precisely which frames will be repeated by a particular decoder.

7.8 SNR scalability

See Figure 7-15.

This clause describes the additional decoding process required for the SNR scalable extensions.

SNR scalability defines a mechanism to refine the DCT coefficients encoded in another (lower) layer of a scalable hierarchy. As illustrated in Figure 7-15 data from two bitstreams is combined after the inverse quantisation processes by adding the DCT coefficients. Until the data is combined, the decoding processes of the two layers are independent of one another.

Table 7-24 – Predictions and motion vectors in field pictures

field_motion_type	macroblock_motion_forward				Motion vector	Prediction formed for
	macroblock_motion_backward					
	macroblock_intra					
	spatial_temporal_weight_class					
Field-based ^{a)}	–	–	1	0	$vector^r[0][0][1:0]^b)$	None (motion vector is for concealment)
Field-based	1	1	0	0	$vector^r[0][0][1:0]$	Whole field, forward
					$vector^r[0][1][1:0]$	Whole field, backward
Field-based	1	0	0	0,1	$vector^r[0][0][1:0]$	Whole field, forward
Field-based	0	1	0	0,1	$vector^r[0][1][1:0]$	Whole field, backward
Field-based ^{a)}	0	0	0	0,1,4	$vector^r[0][0][1:0]^c)$ ^{d)}	Whole field, forward
16 × 8 MC	1	1	0	0	$vector^r[0][0][1:0]$	Upper 16 × 8 field, forward
					$vector^r[1][0][1:0]$	Lower 16 × 8 field, forward
					$vector^r[0][1][1:0]$	Upper 16 × 8 field, backward
					$vector^r[1][1][1:0]$	Lower 16 × 8 field, backward
16 × 8 MC	1	0	0	0,1	$vector^r[0][0][1:0]$	Upper 16 × 8 field, forward
					$vector^r[1][0][1:0]$	Lower 16 × 8 field, forward
16 × 8 MC	0	1	0	0,1	$vector^r[0][1][1:0]$	Upper 16 × 8 field, backward
					$vector^r[1][1][1:0]$	Lower 16 × 8 field, backward
Dual prime	1	0	0	0	$vector^r[0][0][1:0]$	Whole field, same parity, forward
					$vector^r[2][0][1:0]^c)$ ^{e)}	Whole field, opposite parity, forward

a) **field_motion_type** is not present in the bitstream but is assumed to be Field-based.
b) The motion vector is only present if **concealment_motion_vectors** is one.
c) These motion vectors are not present in the bitstream.
d) The motion vector is taken to be (0; 0) as explained in 7.6.3.5.
e) These motion vectors are derived from $vector^r[0][0][1:0]$ as described in 7.6.3.6.

NOTE – Motion vectors are listed in the order they appear in the bitstream.

Subclause 7.8.1 defines how to identify these bitstreams in a scalable hierarchy, however they can be classified as follows.

The lower layer, derived from the first bitstream, can itself be either non-scalable, or require the spatial or temporal scalability decoding process (and hence the decoding of additional bitstreams) to be applied.

The enhancement layer, derived from the second bitstream, contains mainly coded DCT coefficients and a small overhead. The decoding process for this layer and the combination of the two layers are described in this subclause.

NOTE – All information regarding prediction is contained in the lower layer bitstream only. Therefore it is not possible to reconstruct an enhancement layer without decoding the lower layer bitstream data in parallel.

Furthermore prediction and reconstruction of the pictures as described in 7.6, 7.7 and 7.9 for the combined lower and enhancement layer is identical to the respective steps for decoding of the lower layer bitstream only.

Semantics and decoding process described in this subclause include a mechanism for "chroma simulcast". This may be used (for instance) to enhance 4:2:0 in the lower layer to 4:2:2 after processing the enhancement layer data. While the luminance data is processed as described before, in this case the chrominance information retrieved from the lower layer bitstream (with exception of intra-DC values, see 7.8.3.4) shall be discarded and replaced by the new information with higher chrominance resolution decoded from the enhancement layer.

Table 7-25 – Predictions and motion vectors in frame pictures

frame_motion_type	macroblock_motion_forward					
	macroblock_motion_backward					
	macroblock_intra					
	spatial_temporal_weight_class				Motion vector	Prediction formed for
Frame-based ^{a)}	–	–	1	0	$vector^r[0][0][1:0]^c)$	None (motion vector is for concealment)
Frame-based	1	1	0	0	$vector^r[0][0][1:0]$	Frame, forward
					$vector^r[0][1][1:0]$	Frame, backward
Frame-based	1	0	0	0,1,2,3	$vector^r[0][0][1:0]$	Frame, forward
Frame-based	0	1	0	0,1,2,3	$vector^r[0][1][1:0]$	Frame, backward
Frame-based ^{a)}	0	0	0	0,1,2,3,4	$vector^r[0][0][1:0]^d) e)$	Frame, forward
Field-based	1	1	0	0	$vector^r[0][0][1:0]$	Top field, forward
					$vector^r[1][0][1:0]$	Bottom field, forward
					$vector^r[0][1][1:0]$	Top field, backward
					$vector^r[1][1][1:0]$	Bottom field, backward
Field-based	1	0	0	0,1	$vector^r[0][0][1:0]$	Top field, forward
					$vector^r[1][0][1:0]$	Bottom field, forward
Field-based	1	0	0	2		Top field, spatial
					$vector^r[0][0][1:0]$	Bottom field, forward
Field-based	1	0	0	3	$vector^r[0][0][1:0]$	Top field, forward
						Bottom field, spatial
Field-based	0	1	0	0,1	$vector^r[0][1][1:0]$	Top field, backward
					$vector^r[1][1][1:0]$	Bottom field, backward
Field-based	0	1	0	2		Top field, spatial
					$vector^r[0][1][1:0]$	Bottom field, backward
Field-based	0	1	0	3	$vector^r[0][1][1:0]$	Top field, backward
						Bottom field, spatial
Dual prime ^{b)}	1	0	0	0,2,3	$vector^r[0][0][1:0]$	Top field, same parity, forward
					$vector^r[0][0][1:0]^d)$	Bottom field, same parity, forward
					$vector^r[2][0][1:0]^d) f)$	Top field, opposite parity, forward
					$vector^r[3][0][1:0]^d) f)$	Bottom field, opposite parity, forward

a) **frame_motion_type** is not present in the bitstream but is assumed to be Frame-based.
 b) Dual prime cannot be used when **spatial_temporal_integer_weight** = '0'.
 c) The motion vector is only present if **concealment_motion_vectors** is one.
 d) These motion vectors are not present in the bitstream.
 e) The motion vector is taken to be (0; 0) as explained in 7.6.3.5.
 f) These motion vectors are derived from $vector^r[0][0][1:0]$ as described in 7.6.3.6.

NOTE – Motion vectors are listed in the order they appear in the bitstream.

It is inherent in SNR scalability that the two layers are very tightly coupled to one another. It is a requirement that corresponding pictures in each layer shall be decoded at the same time as one another.

In the case that the lower layer bitstream conforms to ISO/IEC 11172-2 (and not this Specification), then two different IDCT mismatch control schemes are being used in decoding. Care must be taken in the encoder to take account of this.

7.8.1 Higher syntactic structures

The two bitstream layers in this subclause are identified by their *layer_id*, decoded from the *sequence_scalable_extension*.

The two bitstreams shall have consecutive layer ids, with enhancement layer bitstream having *layer_id* = *id_{enhance}* and the lower layer bitstream having *layer_id* = *id_{enhance}*-1.

The syntax and semantics of the enhancement layer are as defined in 6.2 and 6.3, respectively.

In the case that the lower layer bitstream conforms to ISO/IEC 11172-2 (and not this Specification), then both this lower and the enhancement layer shall use the "restricted slice structure" defined in this Specification.

Semantic restrictions apply to several values in the headers and extensions of the enhancement layer as follows.

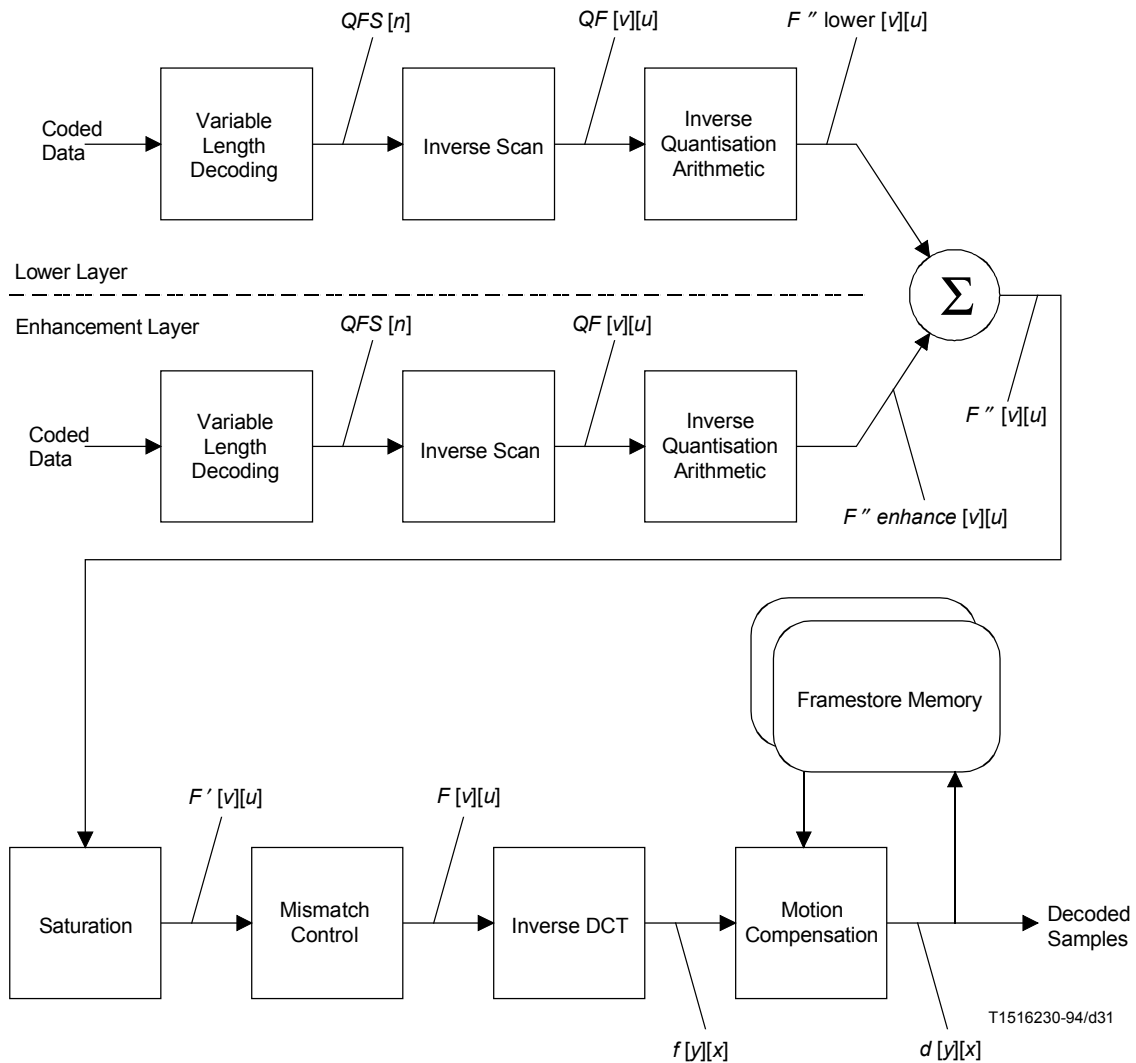

Figure 7-15 – Illustration of decoding process for SNR scalability

Sequence header

This header shall be identical to the one in the lower layer bitstream except for the values of *bit_rate*, *vbv_buffer_size*, *load_intra_quantiser_matrix*, *intra_quantiser_matrix*, *load_non_intra_quantiser_matrix* and *non_intra_quantiser_matrix*. These can be selected independently except for *load_intra_quantiser_matrix* which shall be zero.

Sequence extension

This extension shall be identical to the one in the lower layer bitstream except for the values of `profile_and_level_indication`, `chroma_format`, `bit_rate_extension` and `vbv_buffer_size_extension`. Those can be selected independently.

A different value of `chroma_format` in each layer will cause the `chroma_simulcast` flag to be set as specified by Table 7-26.

Table 7-26 – chroma_simulcast flag

chroma_format (lower layer)	chroma_format (enhancement layer)	chroma_simulcast
4:2:0	4:2:0	0
4:2:0	4:2:2	1
4:2:0	4:4:4	1
4:2:2	4:2:2	0
4:2:2	4:4:4	1
4:4:4	4:4:4	0

The `chroma_format` of the enhancement layer shall be higher or equal to the `chroma_format` of the lower layer bitstream.

In the case that the lower layer bitstream conforms to ISO/IEC 11172-2 (and not This Specification), `sequence_extension()` is not present in the lower layer bitstream, and the following values shall be assumed for the decoding process.

- `progressive_sequence` = 1
- `chroma_format` = "4:2:0"
- `horizontal_size_extension` = 0
- `vertical_size_extension` = 0
- `bit_rate_extension` = 0
- `vbv_buffer_size_extension` = 0
- `low_delay` = 0
- `frame_rate_extension_n` = 0
- `frame_rate_extension_d` = 0

The `sequence_extension()` in the enhancement layer shall have the values shown above.

Sequence display extension

This extension shall not be present as there is no separate display process for the enhancement layer.

Sequence scalable extension

This extension shall be present with `scalable_mode` = "SNR scalability".

GOP header

This header shall be identical to the one in the lower layer bitstream.

NOTE 1 – The GOP header must be present in each layer in order that the `temporal_reference` in each layer are reset on the same frame.

Picture header

This header shall be identical to the one in the lower layer bitstream except for the value of `vbv_delay`. This can be selected independently.

Picture coding extension

This extension shall be identical to the one in the lower layer bitstream except for the value of `q_scale_type` and `alternate_scan`. These can be selected independently.

chroma_420_type shall be set to '0' if chroma_simulcast is set. Else it shall have the same value as in the lower layer bitstream.

In the case that the lower layer bitstream conforms to ISO/IEC 11172-2 (and not this Specification), then picture_coding_extension() is not present in the lower layer bitstream and the following values shall be assumed for the decoding process:

f_code[0][0]	=	forward_f_code in the lower layer bitstream or 15
f_code[0][1]	=	forward_f_code in the lower layer bitstream or 15
f_code[1][0]	=	backward_f_code in the lower layer bitstream or 15
f_code[1][1]	=	backward_f_code in the lower layer bitstream or 15
intra_dc_precision	=	0
picture_structure	=	"Frame Picture"
top_field_first	=	0
frame_pred_frame_dct	=	1
concealment_motion_vectors	=	0
intra_vlc_format	=	0
repeat_first_field	=	0
chroma_420_type	=	1
progressive_frame	=	1
composite_display_flag	=	0

The picture_coding_extension() in the enhancement layer shall have the values shown above.

For the lower layer q_scale_type and alternate_scan shall be assumed to have the value zero.

NOTE 2 – q_scale_type and alternate_scan can be set independently in the enhancement layer.

Quant matrix extension

This extension is optional. Semantics are described in 6.3.11.

load_intra_quantiser_matrix and load_chroma_intra_quantiser_matrix shall both be zero.

NOTE 3 – Only the non-intra matrices will be used in the subsequent decoding process.

Picture display extension

This extension shall not be present.

NOTE 4 – There is no separate display process for the enhancement layer. If pan-scan functionality is desired, it can be accomplished already by using the information conveyed by the pan-scan extension of the lower layer bitstream.

Slice header

Slices shall be coincident with those in the lower layer. The value of quantiser_scale_code can be set independently from the lower layer bitstream.

7.8.2 Macroblock

Subsequently the "current macroblock" denotes the currently processed macroblock. The current macroblock of the lower layer denotes the macroblock identified by having the same macroblock_address as the current macroblock.

The decoding of the macroblock header information is done according to semantics in 6.3.17.

NOTE – Table B.8 which is used if scalable_mode == "SNR scalability" will never set the macroblock_intra, macroblock_motion_forward or macroblock_motion_backward flags, since a macroblock in the enhancement layer contains only refinement data for the current macroblock of the lower layer.

However the corresponding syntax elements and flags of the current macroblock in the lower layer bitstream are relevant for the combined decoding process of lower and enhancement layer following the inverse DCT as described in 7.8.3.5.

7.8.2.1 dct_type

The syntax element dct_type may be present in none, one or both of the lower and enhancement layer macroblock_modes(), as indicated by the semantics in 6.3.17.

If dct_type is present in the macroblock_modes() in both layers it shall have identical values.

7.8.2.2 Skipped Macroblocks

Macroblocks can be skipped in the enhancement layer bitstream, meaning that no coefficient enhancement is done ($F''_{enhance}[v][u] = 0$, for all v, u). Regarding this, the decoding process detailed in 7.8.3 shall be applied.

When macroblocks are skipped in both, the lower and the enhancement layer bitstreams, the decoding process is exactly as specified in 7.6.6.

Macroblocks can also be skipped in the lower layer bitstream, while still being coded in the enhancement layer bitstream. In that case the decoding process detailed in the following has to be applied, but $F''_{lower}[v][u] = 0$, for all v, u .

7.8.3 Block

The first part of the decoding process of the enhancement layer block is independent from the lower layer.

The second part of the decoding process of the enhancement layer block has to be done jointly with the decoding process of the coincident lower layer block.

Two sets of inverse quantised coefficients F''_{lower} and $F''_{enhance}$ are added to form F'' (see Figure 7-15).

F''_{lower} is derived from the lower layer bitstream exactly as defined in 7.1 to 7.4.2.3.

$F''_{enhance}$ is derived as is defined in the clauses below.

The resulting F'' is further processed, starting with saturation, as defined in 7.4.3 to 7.6 (7.7, 7.9).

7.8.3.1 Variable length decoding

In an enhancement layer block the VLC decoding shall be performed according to 7.2, as for a non-intra block (as indicated by $macroblock_intra = 0$).

7.8.3.2 Inverse scan

Inverse scan shall be done exactly as defined in 7.3.

7.8.3.3 Inverse quantisation

In an enhancement layer block the inverse quantisation shall be performed according to 7.4.2 as for a non-intra block.

In the case that the lower layer bitstream conforms to ISO/IEC 11172-2 (and not this Specification), then the "inverse quantisation arithmetic" used to derive $F''_{lower}[v][u]$ (see Figure 7-14) shall include the IDCT mismatch control (oddification) and saturation specified in ISO/IEC 11172-2.

7.8.3.4 Addition of coefficients from the two layers

Corresponding coefficients from the blocks of each layer shall be added together to form F'' (see Figure 7-15).

$$F''[v][u] = F''_{lower}[v][u] + F''_{enhance}[v][u], \text{ for all } u, v$$

If $chroma_simulcast = 1$ is set only the luminance blocks are treated as described above.

For chrominance blocks the DC coefficient of the base layer is used as a prediction of the DC coefficient in the coincident block in the enhancement layer, whereas the AC coefficients of the base layer are discarded and AC coefficients of the enhancement layer form F'' in Figure 7-14 according to the following formulae:

$$F''[0][0] = F''_{lower}[0][0] + F''_{enhance}[0][0]$$

$$F''[v][u] = F''_{enhance}[v][u], \text{ for all } u, v \text{ except } u = v = 0$$

NOTE – Chroma simulcast blocks are inverse quantised like non-intra blocks and use the chrominance non-intra matrix.

Table 7-27 gives the index of the chrominance block whose DC coefficient ($F''_{lower}[0][0]$) is to be used to predict the DC coefficient in the coincident chrominance block of the enhancement layer ($F''_{enhance}[0][0]$).

Table 7-27 – Block index used to predict DC coefficient

chroma_format	Block index							
	4	5	6	7	8	9	10	11
base: 4:2:0 upper: 4:2:2	4	5	4	5				
base: 4:2:0 upper: 4:4:4	4	5	4	5	4	5	4	5
base: 4:2:2 upper: 4:4:4	4	5	6	7	4	5	6	7

7.8.3.5 Remaining macroblock decoding steps

After addition of coefficients from the two layers, the remainder of the macroblock decoding steps is exactly as described in 7.4.3 to 7.6 (7.7, 7.9, if applicable), since there is now only one data stream $F''[v][u]$ to be processed.

In this process, the spatio/temporal prediction $p[y][x]$ is derived according to the macroblock type syntax elements and flags for the current macroblock known from the lower layer bitstream.

7.9 Temporal scalability

Temporal scalability involves two layers, a lower layer and an enhancement layer. Both the lower and the enhancement layers process the same spatial resolution. The enhancement layer enhances the temporal resolution of the lower layer and if temporally re-multiplexed with the lower layer provides full temporal rate. This is the frame rate indicated in the enhancement layer. The decoding process for enhancement layer pictures is similar to the normal decoding process described in 7.1 to 7.6. The only difference is in the "Prediction field and frame selection" described in 7.6.2.

The reference frames for prediction are selected by `reference_select_code` as described in Tables 7-28 and 7-29. In P-pictures, the forward reference picture can be one of the following three: most recent enhancement picture, most recent lower layer frame, or next lower layer frame in display order. Note that in the latter case, the reference frame in lower layer used for prediction is backward in time.

Table 7-28 – Prediction references selection in P-pictures

reference_select_code	Forward prediction reference
00	Most recent decoded enhancement picture(s)
01	Most recent lower layer frame in display order
10	Next lower layer frame in display order
11	Forbidden

Table 7-29 – Prediction references selection in B-pictures

reference_select_code	Forward prediction reference	Backward prediction reference
00	Forbidden	Forbidden
01	Most recent decoded enhancement picture(s)	Most recent lower layer picture in display order
10	Most recent decoded enhancement picture(s)	Next lower layer picture in display order
11	Most recent lower layer picture in display order	Next lower layer picture in display order

In B-pictures, the forward reference can be one of the following two: most recent the enhancement pictures or most recent (or temporally coincident) lower layer frame whereas the backward reference can be one of the following two: most recent lower layer picture including temporally coincident picture in display order or next lower layer frame in display order. Note that in this case, the backward reference frame in lower layer used for prediction is forward in time.

Backward prediction cannot be made from a picture in the enhancement layer. This avoids the need for frame reordering in the enhancement layer. Motion compensation process forms predictions using lower layer decoded pictures and/or previous temporal prediction from the enhancement layer.

The enhancement layer can contain I-pictures, P-pictures or B-pictures, but B-pictures in enhancement layer behave more like P-pictures in the sense that a decoded B-picture can be used to predict the following P-pictures or B-pictures in the enhancement layer.

When the most recent frame in the lower layer is used as the reference, this includes the frame that is temporally coincident with the frame or the first field (in case of field pictures) in the enhancement layer. The prediction references used for P-picture and B-pictures are shown in Table 7-28 and Table 7-29 respectively.

The lower and enhancement layers shall use the restricted slice structure.

Figure 7-16 shows a simplified diagram of the motion compensation process for the enhancement layer using temporal scalability.

I-pictures do not use prediction references; to indicate this, the `reference_select_code` for I-pictures shall be '11'.

Depending on `picture_coding_type`, when `forward_temporal_reference` or `backward_temporal_reference` do not imply references to be used for prediction, they shall take the value 0.

7.9.1 Higher syntactic structures

The two bitstream layers in this subclause are identified by their `layer_id`, decoded from the `sequence_scalable_extension`.

The two bitstreams shall have consecutive layer ids, with enhancement layer having `layer_id = idenhance` and the lower layer having `layer_id = idenhance - 1`.

The syntax and semantics of enhancement layers are as defined in 6.2 and 6.3 respectively.

Semantic restrictions apply to several values in the headers and extensions of the enhancement layer as follows.

The lower layer shall conform to this Specification (and not to ISO/IEC 11172-2).

Sequence header

The values in this header can be different from the lower layer except for `horizontal_size_value`, `vertical_size_value` and `aspect_ratio_information`.

Sequence extension

This extension shall be identical to the one in the lower layer except for values of `profile_and_level_indication`, `bit_rate_extension`, `vbv_buffer_size_extension`, `low_delay`, `frame_rate_extension_n` and `frame_rate_extension_d`. These can be selected independently. Note that `progressive_sequence` indicates the scanning format of the enhancement layer frames only rather than of the output frames after multiplexing. The latter is indicated by `mux_to_progressive_sequence` (see sequence scalable extension).

Sequence display extension

This extension shall not be present as there is no separate display process for the enhancement layer.

Sequence scalable extension

This extension shall be present with `scalable_mode = "Temporal scalability"`.

When `progressive_sequence = 0` and `mux_to_progressive_sequence = 0`, `top_field_first` and `picture_mux_factor` can be selected.

When `progressive_sequence = 0` and `mux_to_progressive_sequence = 1`, `top_field_first` shall contain a complement of the value of `top_field_first` of the lower layer but `picture_mux_factor` shall be 1.

When `progressive_sequence = 1` and `mux_to_progressive_sequence = 1`, `top_field_first` shall be zero but `picture_mux_factor` can be selected.

The combination of `progressive_sequence = 1` and `mux_to_progressive_sequence = 0` shall not occur.

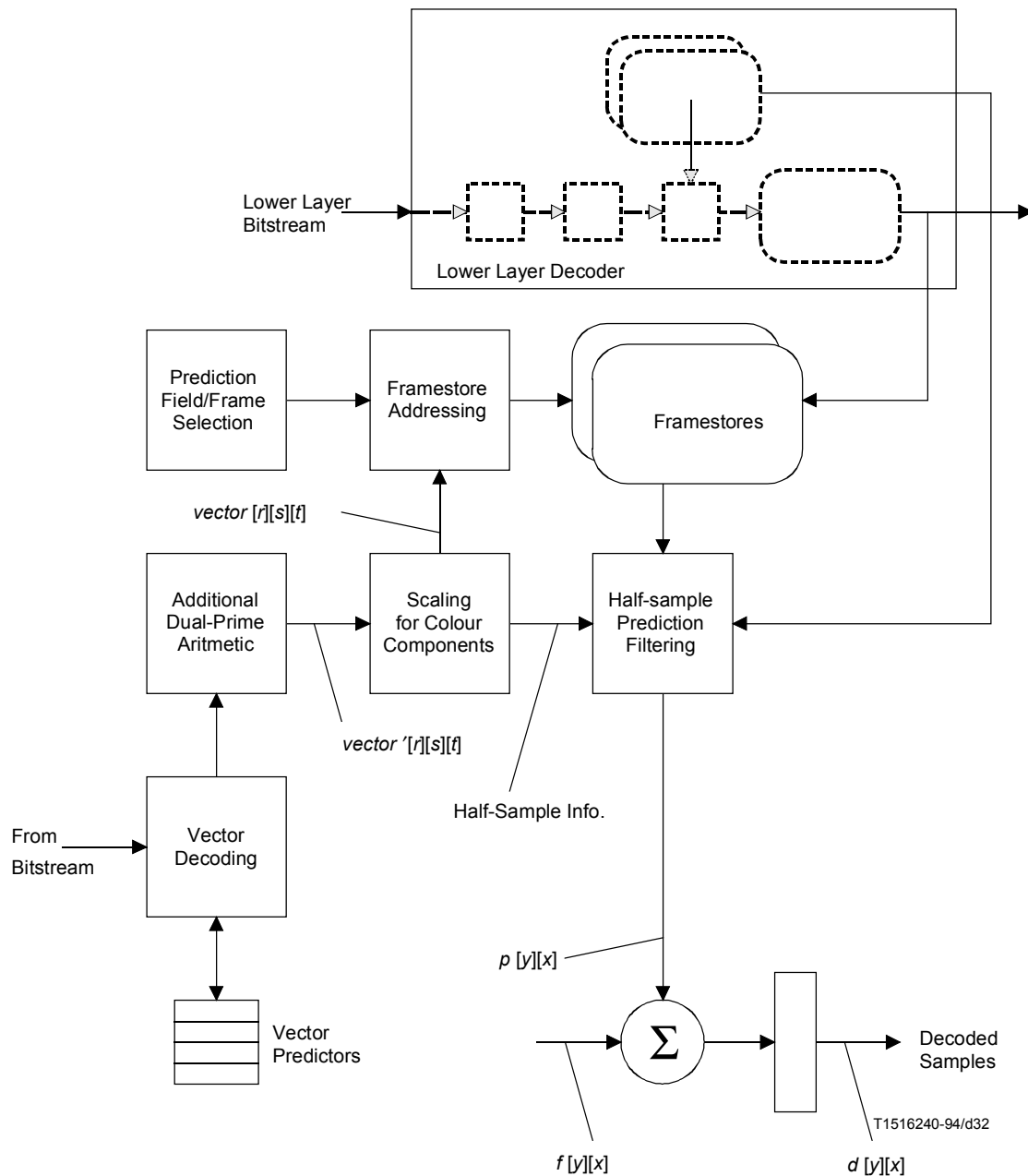

Figure 7-16 – Simplified motion compensation process for the enhancement layer using temporal scalability

GOP header

There is no restriction on GOP header (if present) to be the same as that for lower layer.

Picture header

There is no restriction on picture headers to be the same as in the lower layer.

Picture coding extension

The values in this extension can be different from the lower layer except for *top_field_first*, *concealment_motion_vectors*, and *chroma_420_type* and *progressive_frame*. The *top_field_first* shall be based on *progressive_sequence* and *mux_to_progressive_sequence* (see *sequence_scalable_extension* above) and *concealment_motion_vectors* shall be 0. *Chroma_420_type* shall be identical to the lower layer. *Progressive_frame* shall always have the same value as *progressive_sequence*.

Picture temporal scalable extension

This extension shall be present for each picture.

Quant matrix extension

This extension may be present in the enhancement layer.

7.9.2 Restrictions on temporal prediction

Although temporal predictions can be made from decoded pictures referenced by `forward_temporal_reference` or both `forward_temporal_reference` and `backward_temporal_references`, temporal scalability is efficient if predictions are formed using decoded picture/pictures from lower layer and enhancement layer that are very close in time to the enhancement picture being predicted. It is a requirement on the bitstreams that P-pictures and B-pictures shall form predictions from most recent or next pictures as illustrated by Tables 7-28 and 7-29.

In case `group_of_pictures_header` occurs very often in `lower_layer`, ambiguity can occur due to possibility of non-uniqueness of temporal references (which are reset at each `group_of_pictures_header`). This ambiguity shall be resolved with help of systems layer timing information.

7.10 Data partitioning

Data partitioning is a technique that splits a video bitstream into two layers, called partitions. A priority breakpoint indicates which syntax elements are placed in partition 0, which is the base partition (also called high priority partition). The remainder of the bitstream is placed in partition 1 (which is also called low priority partition). Sequence, GOP, and picture headers are redundantly copied in partition 1 to facilitate error recovery. The `sequence_end_code` is also redundantly copied into partition 1. All fields in the redundant headers must be identical to the original ones. The only extensions allowed (and required) in partition 1 are `sequence_extension()`, `picture_coding_extension()` and `sequence_scalable_extension()`.

NOTE – The `slice()` syntax given in 6.2.4 is followed in both partitions up to (and including) the syntax element `extra_bit_slice`.

The interpretation of `priority_breakpoint` is given in Table 7-30.

Table 7-30 – Priority breakpoint values and associated semantics

priority_breakpoint	Syntax elements included in partition zero
0	This value is reserved for partition 1. All slices in partition 1 shall have a <code>priority_breakpoint</code> equal to 0.
1	All data at the sequence, GOP, picture and <code>slice()</code> down to <code>extra_bit_slice</code> in <code>slice()</code> .
2	All data included above, plus macroblock syntax elements up to and including <code>macroblock_address_increment</code> .
3	All data included above, plus macroblock syntax elements up to but not including <code>coded_block_pattern()</code> .
4 ... 63	Reserved.
64	All syntax elements up to and including <code>coded_block_pattern()</code> or DC coefficient (<code>dct_dc_differential</code>), and the first (run, level) DCT coefficient pair (or EOB). (Note)
65	All syntax elements above, plus up to 2 (run, level) DCT coefficient pairs.
...	
63 + j	All syntax elements above, plus up to j (run, level) DCT coefficient pairs.
...	
127	All syntax elements above, plus up to 64 (run, level) DCT coefficient pairs.
NOTE – A <code>priority_breakpoint</code> immediately following the DC coefficient is disallowed since it might cause start code emulation.	

Semantics of VBV remains unchanged, i.e. the VBV refers to the sum of two partitions, not any single one.

The bitstream parameters *bit_rate* (*bit_rate_value* and *bit_rate_extension*), *vbv_buffer_size* (*vbv_buffer_size_value* and *vbv_buffer_size_extension*) and *vbv_delay* shall take the same value in the two partitions. These parameters refer to the characteristics of the entire bitstream formed from the two partitions.

The decoding process is modified in the following manner:

- Set *current_partition* to 0, and start decoding from bitstream that contains the *sequence_scalable_extension* (partition 0).
- If *current_partition* = 0, check to see if the current point in the bitstream is a priority breakpoint. If yes, set *current_partition* to 1. Next item will be decoded from partition 1. Otherwise, continue decoding from partition 0. Remove sequence, GOP, and picture headers from both partitions.
- If *current_partition* = 1, check the priority breakpoint to see if the next item to be decoded is expected in partition 0. If yes, set *current_partition* to 0. Next item will be decoded from partition 0. Otherwise, continue decoding from partition 1.

An example is shown in Figure 7-17 where the priority breakpoint is set at 64 [one (run, level) pair].

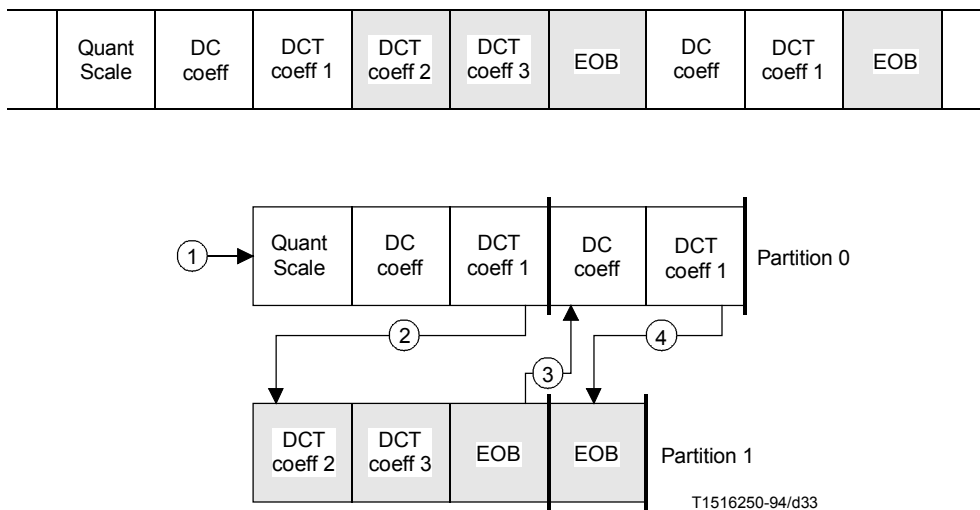

Figure 7-17 – A segment from a bitstream with two partitions, with *priority_breakpoint* set to 64 (one (run, level) pair). The two partitions are shown, with arrows indicating how the decoder needs to switch between partitions

7.11 Hybrid scalability

Hybrid scalability is the combination of two different types of scalability. The types of scalability that can be combined are SNR scalability, spatial scalability and temporal scalability. When two types of scalability are combined, there are three bitstreams that have to be decoded. The layers to which these bitstreams belong are named in Table 7-31.

Table 7-31 – Names of layers

layer_id	Name
0	Base layer
1	Enhancement layer 1
2	Enhancement layer 2
...	...

ISO/IEC 13818-2 : 2000 (E)

For the scalability between the enhancement layers 1 and 2, the enhancement layer 1 is its lower layer, and the enhancement layer 2 is its enhancement layer. No layer can be omitted from the hierarchical ladder. E.g. if there is SNR scalability between enhancement layer 1 and enhancement layer 2, the prediction types in enhancement layer 1 are also valid for the combined decoding process for enhancement layers 1 and 2.

The coupling of layers is more loose with spatial and temporal scalability than with SNR scalability. Therefore, in these kinds of scalability, first the base layer has to be decoded and upconverted before it can be used in the enhancement layer. In SNR scalability, both layers are decoded simultaneously. The decoding order can be summarised as follows:

Case 1

base layer
 <spatial or temporal scalability>
enhancement layer 1
 <SNR scalability>
enhancement layer 2

First decode the base layer, and then decode both enhancement layers simultaneously.

Case 2

base layer
 <SNR scalability>
enhancement layer 1
 <spatial or temporal scalability>
enhancement layer 2

First decode the base layer and the enhancement layer 1 simultaneously, and then decode the enhancement layer 2.

Case 3

base layer
 <spatial or temporal scalability>
enhancement layer 1
 <spatial or temporal scalability>
enhancement layer 2

First decode the base layer, then decode the enhancement layer 1, and finally decode enhancement layer 2.

7.12 Output of the decoding process

This subclause describes the output of the theoretical model of the decoding process that decodes bitstreams conforming to this Specification.

The decoding process input is one or more coded video bitstreams (one for each of the layers). The video layers are generally multiplexed by the means of a system stream that also contains timing information.

The output of the decoding process is a series of fields or frames that are normally the input of a display process. The order in which fields or frames are output by the decoding process is called the display order, and may be different from the coded order (when B-pictures are used). The display process is responsible for the action of displaying the decoded fields or frames on a display device. If the display device cannot display at the frame rate indicated in the bitstream, the display process may perform frame rate conversion. This Specification does not describe a theoretical model of display process nor the operation of the display process.

Since some of the syntax elements, such as `progressive_frame`, may be needed by the display process, in this theoretical model of the decoding process, all the syntactic elements that are decoded by the decoding process are output by the decoding process and may be accessed by the display process.

When the progressive sequence is decoded (`progressive_sequence` is equal to 1), the luminance and chrominance samples of the reconstructed frames are output by decoding process in the form of progressive frames and the output rate is the frame rate. Figure 7-18 illustrates this in the case of `chroma_format` equals to 4:2:0.

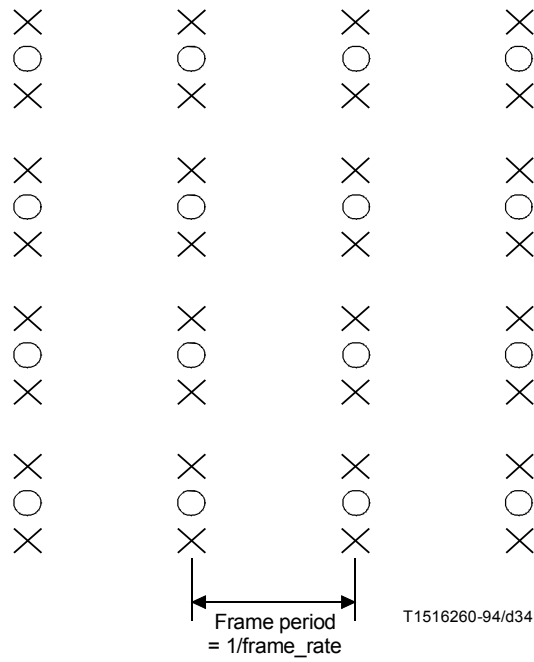

Figure 7-18 – progressive_sequence == 1

The same reconstructed frame is output one time if repeat_first_field is equal to 0, and two or three consecutive times if repeat_first_field is equal to 1, depending on the value of top_field_first. Figure 7-19 illustrates this in the case of chroma_format equals to 4:2:0 and repeat_first_field equals 1.

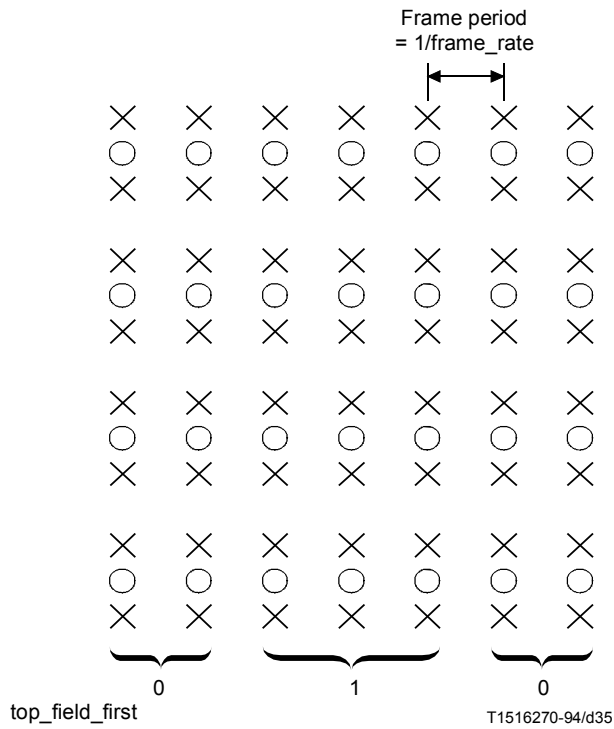

Figure 7-19 – progressive_sequence == '1'; repeat_first_field == '1'

When decoding an interlaced sequence (`progressive_sequence` is equal to 0), the luminance samples of the reconstructed frames are output by the decoding process in the form of interlaced fields at a rate that is twice the frame rate. Figure 7-20 illustrates this.

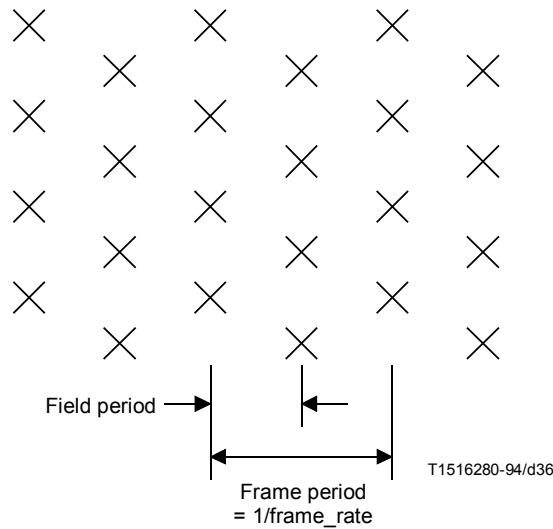

Figure 7-20 – `progressive_sequence == 0`

It is a requirement on the bitstream that the fields at the output of the decoding process shall always be alternately top and bottom (note that the very first field of a sequence may be either top or bottom).

If the reconstructed frame is interlaced (`progressive_frame` is equal to 0), the luminance samples and chrominance samples are output by the decoding process in the form of two consecutive fields. The first field output by the decoding process is the top field or the bottom field of the reconstructed frame, depending on the value of `top_field_first`.

Although all the samples of progressive frames represent the same instant in time, all the samples are not output at the same time by the decoding process when the sequence is interlaced.

If the reconstructed frame is progressive (`progressive_frame` is equal to 1), the luminance samples are output by the decoding process in the form of two or three consecutive fields, depending on the value of `repeat_first_field`.

NOTE – The information that these fields originate from the same progressive frame in the bitstream is conveyed to the display process.

All of the chrominance samples of the reconstructed progressive frame are output by the decoding process at the same time as the first field of luminance samples. This is illustrated in Figures 7-21 and 7-22.

8 Profiles and levels

NOTE – In this Specification the word "profile" is used as defined below. It should not be confused with other definitions of "profile" and in particular it does not have the meaning that is defined by JTC1/SGFS.

Profiles and levels provide a means of defining subsets of the syntax and semantics of this Specification and thereby the decoder capabilities required to decode a particular bitstream. A profile is a defined subset of the entire bitstream syntax that is defined by this Specification. A level is a defined set of constraints imposed on parameters in the bitstream. Conformance tests will be carried out against defined profiles at defined levels.

The purpose of defining conformance points in the form of profiles and levels is to facilitate bitstream interchange among different applications. Implementers of this Specification are encouraged to produce decoders and bitstreams which correspond to those defined conformance regions. The discretely defined profiles and levels are the means of bitstream interchange between applications of this Specification.

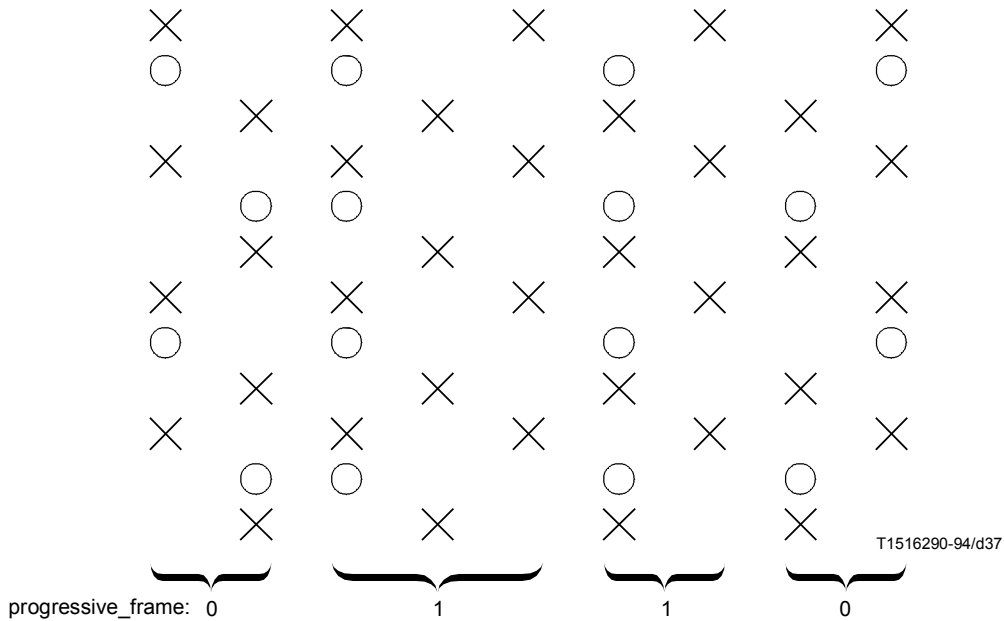

Figure 7-21 – progressive_sequence == 0 with 4:2:0 chrominance

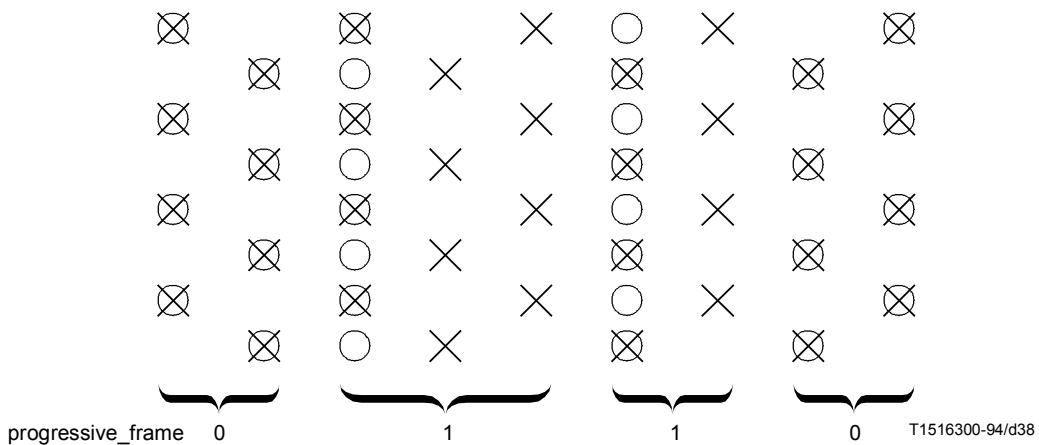

Figure 7-22 – progressive_sequence == 0 with 4:2:2 or 4:4:4 chrominance

In this clause the constrained parts of the defined profiles and levels are described. All syntactic elements and parameter values which are not explicitly constrained may take any of the possible values that are allowed by this Specification. In general, a decoder shall be deemed to be conformant to a given profile at a given level if it is able to properly decode all allowed values of all syntactic elements as specified by that profile at that level. One exception to this rule exists in the case of a Simple profile Main level decoder, which must also be able to decode Main profile, Low level bitstreams. A bitstream shall be deemed to be conformant if it does not exceed the allowed range of allowed values and does not include disallowed syntactic elements.

Attention is drawn to 5.4 which defines the convention for specifying a range of numbers. This is used throughout to specify the range of values and parameters.

The profile_and_level_indication in the sequence_extension indicates the profile and level to which the bitstream complies. The most significant bit of profile_and_level_indication is called 'escape bit'. When the escape bit is set to zero, the profile and level are derived from profile_and_level_indication according to Tables 8-1, 8-2 and 8-3.

Table 8-1 – Meaning of bits in profile_and_level_indication

Bits	Field Size (bits)	Meaning
[7:7]	1	Escape bit
[6:4]	3	Profile identification
[3:0]	4	Level identification

Table 8-2 specifies the profile identification codes and Table 8-3 the level identification codes. When the escape bit equals zero a profile with a numerically larger identification value will be a subset of a profile with a numerically smaller identification value. Similarly, whenever the escape bit equals zero, a level with a numerically larger identification value will be a subset of a level with a numerically smaller identification value.

Table 8-2 – Profile identification

Profile identification	Profile
110 to 111	(Reserved)
101	Simple
100	Main
011	SNR Scalable
010	Spatially Scalable
001	High
000	(Reserved)

Table 8-3 – Level identification

Level identification	Level
1011 to 1111	(Reserved)
1010	Low
1001	(Reserved)
1000	Main
0111	(Reserved)
0110	High 1440
0101	(Reserved)
0100	High
0000 to 0011	(Reserved)

Table 8-4 describes profiles and levels when the escape bit equals 1. For these profiles and levels there is no implied hierarchy from the assignment of profile_and_level_indication and profiles and levels are not necessarily subsets of others.

Attention is drawn to Annex E, which describes in detail those parts of ISO/IEC 13818-2 that are used for a given profile and level.

NOTE 1 – On 4:2:2 Profile: The ITU-T Rec. H.262 | ISO/IEC 13818-2 compression algorithm exploits temporal redundancy, spatial redundancy, and human psycho-visual properties and is not a lossless algorithm. For sequences with substantial spatial and temporal redundancies, or without many sharp lines/edges, the quality of the sequences obtained after decompression will be higher than that obtained for sequences with lower redundancy, or with a large number of sharp lines/edges.

The 4:2:2 profile can provide higher video quality, better chroma resolution and allows a higher bit rate (at Main level, up to 50 Mbit/s) than MP@ML. It also provides the capability to encode all active lines of video.

Although it is not part of the hierarchy of profiles and levels, the 4:2:2 profile @ Main level decoder is required to decode all the bit streams decodable by MP@ML decoders.

The 4:2:2 profile does not support scalability. This allows implementation architectures to be similar to those of MP@ML.

This profile can be used for applications requiring multiple generations of encoding and decoding. In the case of multiple generations without picture manipulation or change in picture coding type between generations, the quality remains nearly constant after the first generation. Use of picture manipulation or change in picture coding type between generations causes some degradation in quality. Nevertheless, the resulting quality is acceptable for a broad range of applications.

The 4:2:2 profile permits all I-picture encoding. This enables fast recovery from transmission errors and can simplify editing applications. This profile allows the high bit rates required to maintain high quality while using only I-picture coding. The 4:2:2 profile also allows the use of P- and B-picture coding types which can further improve quality or reduce bit rate for the same quality.

See Annex J for more information on the picture quality of the 4:2:2 profile.

NOTE 2 – On Multi-view Profile: The Multi-view Profile (MVP) is envisioned to be a profile appropriate for applications that require multiple viewpoints within the context of ITU-T Rec. H.262 | ISO/IEC 13818-2. MVP supports stereoscopic pictures as its source images for a wide range of picture resolution and quality as requested by the applications to be used. A base layer of MVP is assigned to a left view and an enhancement layer is assigned to a right view.

Table 8-4 – Escape profile_and_level_indication identification

profile_and_level_indication	Name
10001111 to 11111111	(Reserved)
10001110	Multi-view profile @ Low level
10001101	Multi-view profile @ Main level
10001100	(Reserved)
10001011	Multi-view profile @ High1440 level
10001010	Multi-view profile @ High level
10000110 to 10001001	(Reserved)
10000101	4:2:2 profile @ Main level
10000011 to 10000100	(Reserved)
10000010	4:2:2 profile @ High level
10000000 to 10000001	(Reserved)

A monoscopic coding with the same tools as Main Profile (MP), including ISO/IEC 11172-2, is applied to the base layer. An enhancement layer is coded using Temporal Scalability tools and a hybrid prediction of motions and disparity can be utilized in the enhanced layer.

MVP, viewed as one of the scalable profiles in terms of multiple viewpoint layers, is expected to have the same type of compatibility features other scalable profiles have, such as compatibility with MP. For example:

- 1) decoders compliant to MVP at a certain Level are capable of decoding the bitstreams compliant to MP at the corresponding Level (i.e. forward compatibility);
- 2) decoders compliant to MP at a certain Level are capable of decoding the bitstream in the base layer of MVP (i.e. backward compatibility).

8.1 ISO/IEC 11172-2 compatibility

ISO/IEC 11172-2 "constrained parameter" bitstreams shall be decodable by Simple, Main, SNR Scalable, Spatially Scalable and High profile decoders at all levels. Additionally Simple, Main, SNR Scalable, Spatially Scalable and High profile decoders shall be able to decode D-pictures-only bitstreams of ISO/IEC 11172-2 which are within the level constraints of the decoder.

8.2 Relationship between defined profiles

The Simple, Main, SNR Scalable, Spatially Scalable and High profiles have a hierarchical relationship. Therefore the syntax supported by a 'higher' profile includes all the syntactic elements of 'lower' profiles (e.g. for a given level, a Main profile decoder shall be able to decode a bitstream conforming to Simple profile restrictions). For a given profile, the same syntax set is supported regardless of level. The order of hierarchy is given in Table 8-2.

The syntactic differences between constraints of profiles are given in Table 8-5. This table describes the limits which apply to a bitstream. Note that a Simple Profile conformant decoder must be able to fully decode both Simple profile, Main level and Main profile, Low level bitstreams.

Table 8-5 – Syntactic constraints of profiles

Syntactic Element	Profile						
	Simple	Main	SNR	Spatial	High	4:2:2	Multi-view
chroma_format	4:2:0	4:2:0	4:2:0	4:2:0	4:2:2 or 4:2:0	4:2:2 or 4:2:0	4:2:0
frame_rate_extension_n	0	0	0	0	0	0	0
frame_rate_extension_d	0	0	0	0	0	0	0
aspect_ratio_information	0001, 0010, 0011	0001, 0010, 0011	0001, 0010, 0011	0001, 0010, 0011	0001, 0010, 0011	0001, 0010, 0011	0001, 0010, 0011
picture_coding_type	I, P	I, P, B	I, P, B	I, P, B	I, P, B	I, P, B	I, P, B
repeat_first_field	Constrained		Unconstrained			Constrained	Unconstrained
sequence_scalable_extension()	No	No	Yes	Yes	Yes	No	Yes
scalable_mode	–	–	SNR	SNR or Spatial	SNR or Spatial	–	Temporal
picture_spatial_scalable_extension()	No	No	No	Yes	Yes	No	No
picture_temporal_scalable_extension()	No	No	No	No	No	No	Yes
intra_dc_precision	8, 9, 10	8, 9, 10	8, 9, 10	8, 9, 10	8, 9, 10, 11	8, 9, 10, 11	8, 9, 10
Slice structure	Restricted 6.1.2.2						

For all defined profiles, there is a semantic restriction on the bitstream that all of the data for a macroblock shall be represented with not more than the number of bits indicated by Table 8-6. However, a maximum of two macroblocks in each horizontal row of macroblocks may exceed this limitation.

Table 8-6 – Maximum number of bits in a macroblock

chroma_format	Maximum number of bits
4:2:0	4608
4:2:2	6144
4:2:2 (in 4:2:2 Profile)	Unconstrained
4:4:4	9216

In this context, a macroblock is deemed to start with the first bit of the macroblock_address_increment (or macroblock_escape, if any) and continues until the last bit of the macroblock() syntactic structure. The bits required to represent any slice() that precedes (or follows) the macroblock are not counted as part of the macroblock.

The High profile is also distinguished by having different constraints on luminance sample rate, maximum bit rate, and VBV buffer size. Refer to Tables 8-12, 8-13 and 8-14.

Decoders that are Simple profile @ Main level compliant shall be capable of decoding Main profile @ Low level bitstreams.

8.2.1 Use of repeat_first_field

The use of repeat_first_field in Simple and Main profile bitstreams is constrained as specified in Table 8-7.

Table 8-7 – Constraints on use of repeat_first_field for Simple and Main Profiles

frame_rate_code	frame_rate_value	Repeat_first_field	
		progressive_sequence==0	progressive_sequence==1
0000	Forbidden		
0001	24 000 ÷ 1001 (23,976...)	0	0
0010	24	0	0
0011	25	0 or 1	0
0100	30 000 ÷ 1001 (29,97...)	0 or 1	0
0101	30	0 or 1	0
0110	50	0 or 1	0
0111	60 000 ÷ 1001 (59,94...)	0 or 1	0 or 1
1000	60	0 or 1	0 or 1
...	Reserved		
1111	Reserved		

Additional constraints exist for Main profile @ Main level and Simple profile @ Main level only:

- if (vertical_size > 480 lines) or (frame_rate is "25Hz") then if picture_coding_type == 011 (i.e. B-picture), repeat_first_field shall be 0.
- if vertical_size > 480 lines frame_rate shall be "25Hz"

Additionally, the following constraints exist for 4:2:2 profile @ Main level only:

- if vertical_size > 512 lines,
then if picture_coding_type=011 (i.e. B-picture), repeat_first_field shall be 0;
- if vertical_size > 512 lines frame_rate shall be "25Hz".

8.3 Relationship between defined levels

The Low, Main, High-1440 and High levels have a hierarchical relationship. Therefore the parameter constraints of a 'higher' level equal or exceed the constraints of 'lower' levels (e.g. for a given profile, a Main level decoder shall be able to decode a bitstream conforming to Low level restrictions). The order of hierarchy is given in Table 8-3.

The different parameter constraints for levels are given in Table 8-8.

8.4 Scalable layers

The SNR Scalable, Spatial Scalable, High and Multi-view profiles may use more than one bitstream to code the image. These different bitstreams represent layers of coding, which when combined create a higher quality image than that obtainable from one layer alone (see Annex D). The maximum number of layers for a given profile is specified in Table 8-9. The scalable layers are named according to Table 7-31. The syntactic and parameter constraints for these profile/level combinations when coded using the maximum permitted number of layers are given in Tables 8-11, 8-12, 8-13 and 8-14. When the number of layers is less than the maximum permitted, reference should also be made to Tables E-21 to E-46 as appropriate.

It should be noted that a bitstream of the base layer of SNR Scalable and Multi-view profiles can always be decoded by a Main profile decoder of equivalent level. Conversely, a Main profile bitstream shall be decodable by either SNR Scalable or Multi-view profile decoder of equivalent level.

Table 8-8 – Parameter constraints for levels

Syntactic Element	Level			
	Low	Main	High-1440	High
f_code[0][0] (forward horizontal)	[1:7]	[1:8]	[1:9]	[1:9]
f_code[1][0] ^{a)} (backward horizontal)	[1:7]	[1:8]	[1:9]	[1:9]
Frame picture				
f_code[0][1] (forward vertical)	[1:4]	[1:5]	[1:5]	[1:5]
f_code[1][1] ^{a)} (backward vertical)	[1:4]	[1:5]	[1:5]	[1:5]
Vertical vector range ^{b)}	[-64:63,5]	[-128:127,5]	[-128:127,5]	[-128:127,5]
Field picture				
f_code[0][1] (forward vertical)	[1:3]	[1:4]	[1:4]	[1:4]
f_code[1][1] ^{a)} (backward vertical)	[1:3]	[1:4]	[1:4]	[1:4]
Vertical vector range ^{b)}	[-32:31,5]	[-64:63,5]	[-64:63,5]	[-64:63,5]
frame_rate_code	[1:5]	[1:5]	[1:8]	[1:8]
Sample Density	Table 8-11			
Luminance Sample Rate	Table 8-12			
Maximum Bit Rate	Table 8-13			
Buffer Size	Table 8-14			
<p>a) For Simple profile bitstreams which do not include B-pictures, f_code[1][0] and f_code[1][1] shall be set to 15 (not used).</p> <p>b) This restriction applies to the final reconstructed motion vector. In the case of dual prime motion vectors, this restriction applies to all the following values:</p> $\text{vector}'[0][0][1]$ $((\text{vector}'[0][0][1] * m[\text{parity_ref}][\text{parity_pred}])//2)$ $((\text{vector}'[0][0][1] * m[\text{parity_ref}][\text{parity_pred}])//2)" + e[\text{parity_ref}][\text{parity_pred}]$ $((\text{vector}'[0][0][1] * m[\text{parity_ref}][\text{parity_pred}])//2)" + dmvector[1]$ $((\text{vector}'[0][0][1] * m[\text{parity_ref}][\text{parity_pred}])//2)" + e[\text{parity_ref}][\text{parity_pred}] + dmvector[1]$				

Table 8-9 – Upper bounds for scalable layers in SNR Scalable, Spatial Scalable, High and Multi-view profiles

Level	Maximum Number of	Profile			
		SNR	Spatial	High	Multi-view
High	All layers (base + enhancement)			3	2
	Spatial enhancement layers			1	0
	SNR enhancement layers			1	0
	Temporal auxiliary layers			0	1
High-1440	All layers (base + enhancement)		3	3	2
	Spatial enhancement layers		1	1	0
	SNR enhancement layers		1	1	0
	Temporal auxiliary layers		0	0	1
Main	All layers (base + enhancement)	2		3	2
	Spatial enhancement layers	0		1	0
	SNR enhancement layers	1		1	0
	Temporal auxiliary layers	0		0	1
Low	All layers (base + enhancement)	2			2
	Spatial enhancement layers	0			0
	SNR enhancement layers	1			0
	Temporal auxiliary layers	0			1

8.4.1 Permissible layer combinations

Table 8-10 is a summary of the permitted combinations, and is subject to the following rules:

- SNR Scalable and Multi-view profile: maximum of 2 layers; Spatial Scalable and High profile: maximum of 3 layers. (See Table 8-9.)
- Only one SNR and one Spatial scale allowed in 3-layer combinations, either SNR/Spatial or Spatial/SNR order is permitted. (See Table 8-9.)
- Chroma simulcast, which allows to add 4:2:2 chroma information to a 4:2:0 base layer and defined in 7.8 is implemented with SNR scalability.
- A 4:2:0 layer is not permitted if the lower layer is 4:2:2. (See 7.7.3.3.)
- (level – 1) is defined as follows:
 - if level is Main, (level – 1) is Low;
 - if level is High – 1440, (level – 1) is Main;
 - if level is High, (level – 1) is High – 1440.

Table 8-10 – Permissible layer combinations

Profile	Scalable mode			Profile/level of simplest base layer decoder (level reference top layer) ^{a)}
	Base layer	Enhancement layer 1	Enhancement layer 2	
SNR	4:2:0	SNR, 4:2:0	–	MP@same level
Spatial	4:2:0	SNR, 4:2:0	–	MP@same level
Spatial	4:2:0	Spatial, 4:2:0	–	MP@(level – 1)
Spatial	4:2:0	SNR, 4:2:0	Spatial, 4:2:0	MP@(level – 1)
Spatial	4:2:0	Spatial, 4:2:0	SNR, 4:2:0	MP@(level – 1)
High	4:2:0	–	–	HP@same level
High	4:2:2	–	–	HP@same level
High	4:2:0	SNR, 4:2:0	–	HP@same level
High	4:2:0	SNR, 4:2:2	–	HP@same level
High	4:2:2	SNR, 4:2:2	–	HP@same level
High	4:2:0	Spatial, 4:2:0	–	HP@(level – 1)
High	4:2:0	Spatial, 4:2:2	–	HP@(level – 1)
High	4:2:2	Spatial, 4:2:2	–	HP@(level – 1) ^{b)}
High	4:2:0	SNR, 4:2:0	Spatial, 4:2:0	HP@(level – 1)
High	4:2:0	SNR, 4:2:0	Spatial, 4:2:2	HP@(level – 1)
High	4:2:0	SNR, 4:2:2	Spatial, 4:2:2	HP@(level – 1) ^{b)}
High	4:2:2	SNR, 4:2:2	Spatial, 4:2:2	HP@(level – 1) ^{b)}
High	4:2:0	Spatial, 4:2:0	SNR, 4:2:0	HP@(level – 1)
High	4:2:0	Spatial, 4:2:0	SNR, 4:2:2	HP@(level – 1)
High	4:2:0	Spatial, 4:2:2	SNR, 4:2:2	HP@(level – 1)
High	4:2:2	Spatial, 4:2:2	SNR, 4:2:2	HP@(level – 1) ^{b)}
Multi-view	4:2:0	Temporal, 4:2:0	–	MP@same level

^{a)} The simplest compliant decoder to decode the base layer is specified, assuming that bitstream may contain any syntax and parameter value permitted for the stated profile @ level, except scalability. Note that for High profile @ Main level spatially scaled bitstreams, 'HP @ (level – 1)' becomes 'MP @ (level – 1)'. In the event that a base layer bitstream uses fewer syntactic elements or a reduced parameter range than permitted, profile_and_level_indication may indicate a 'simpler' profile @ level.

^{b)} Note that 4:2:2 chroma format is not supported as a lower spatial layer of High profile @ Main level (see Table 8-12).

Details of the different parameter limits that may be applied in each layer of a bitstream and the corresponding appropriate profile_and_level_indication that should be used are given in Tables E.20 to E.45.

8.4.2 Multi-view Profile specific constraints

Both the enhancement and base layers have the same frame rate.

The picture_mux_enable, picture_mux_order and picture_mux_factor are not used in this profile and shall be ignored.

ISO/IEC 13818-2 : 2000 (E)

The reference_select_code should be "00" or "01" for the P-frames in the enhancement layer. The reference_select_code should be "01" for B-frames in the enhancement layer.

If the base layer coded frame is the first frame of the Group Of Pictures then the corresponding frame in the enhancement layer should be either I-frame or P-frame with the reference_select_code value of "01".

In a P-field picture with reference_select_code = "01" and which is the first field of a frame, the following restriction applies:

- Dual prime prediction shall not be used.
- Field prediction in which motion_vertical_field_select indicates the second field of the base layer frame shall not be used.
- If base and enhancement layers do not have the same value for top_field_first, there shall be no macroblocks that are coded with macroblock_motion_forward zero and macroblock_intra zero.
- If base and enhancement layer do not have the same value for top_field_first, there shall be no skipped macroblocks.

In a B-field picture which is the first field of a frame, the prediction shall not make reference to the second field of the corresponding base layer frame.

It is inherent in the Multi-view Profile that the two layers are tightly coupled to one another. It is a requirement that the pictures in enhancement layer shall be decoded immediately after their corresponding required reference pictures are decoded unless this requirement makes one to decode the enhancement layer pictures out of display order. In that case, the pictures in the enhancement layer should be decoded in the display order.

8.5 Parameter values for defined profiles, levels and layers

See Table 8-11.

Table 8-11 - Upper bounds for sampling density

Level	Spatial resolution layer		Profile							
			Simple	Main	SNR	Spatial	High	4:2:2	Multi	
High	Enhancement	Samples/line Lines/frame Frames/sec		1920 1088 60				1920 1088 60	1920 1088 60	1920 1088 60
	Lower	Samples/line Lines/frame Frames/sec		–				960 576 30	–	1920 1088 60
High-1440	Enhancement	Samples/line Lines/frame Frames/sec		1440 1088 60			1440 1088 60	1440 1088 60	–	1440 1088 60
	Lower	Samples/line Lines/frame Frames/sec		–			720 576 30	720 576 30	–	1440 1088 60
Main	Enhancement	Samples/line Lines/frame Frames/sec	720 576 30	720 576 30	720 576 30			720 576 30	720 608 ^{a)} 30	720 576 30
	Lower	Samples/line Lines/frame Frames/sec	–	–	–			352 288 30	–	720 576 30
Low	Enhancement	Samples/line Lines/frame Frames/sec		352 288 30	352 288 30				–	352 288 30
	Lower	Samples/line Lines/frame Frames/sec		–	–				–	352 288 30

In the case of single layer or SNR scaled coding, the limits specified by 'Enhancement layer' apply.

^{a)} 512 lines/frame for 525/60, 608 lines/frame for 625/50

The syntactic elements referenced by this table are as follows:

- samples/line: horizontal_size;
- lines/frame: vertical_size;
- frames/sec: frame_rate.

The upper bound for frame_rate is the same for both progressive_sequence == 0 and progressive_sequence == 1.

Table 8-12 – Upper bounds for luminance sample rate (samples/s)

Level	Spatial resolution layer	Profile						
		Simple	Main	SNR	Spatial	High	4:2:2	Multi-view
High	Enhancement		62 668 800			62 668 800 (4:2:2) 83 558 400 (4:2:0)	62 668 800	62 668 800
	Lower		–			14 745 600 (4:2:2) 19 660 800 (4:2:0)	–	62 668 800
High-1440	Enhancement		47 001 600		47 001 600	47 001 600 (4:2:2) 62 668 800 (4:2:0)	–	47 001 600
	Lower		–		10 368 000	11 059 200 (4:2:2) 14 745 600 (4:2:0)	–	47 001 600
Main	Enhancement	10 368 000	10 368 000	10 368 000		11 059 200 (4:2:2) 14 745 600 (4:2:0)	11 059 200	10 368 000
	Lower	–	–	–		– 3 041 280 (4:2:0)	–	10 368 000
Low	Enhancement		3 041 280	3 041 280			–	3 041 280
	Lower		–	–			–	3 041 280

NOTE – In the case of single layer or SNR scaled coding, the limits specified by "Enhancement layer" apply.

The luminance sample rate P is defined as follows:

- For progressive_sequence == 1:

$$P = (16 * ((horizontal_size + 15) / 16)) \times (16 * ((vertical_size + 15) / 16)) \times frame_rate$$

- For progressive_sequence == 0:

$$P = (16 * ((horizontal_size + 15) / 16)) \times (32 * ((vertical_size + 31) / 32)) \times frame_rate$$

8.6 Compatibility requirements on decoders

Table 8-15 defines the requirements on compatibility for decoders. There is a requirement that a decoder of a profile and level represented by a column in Table 8-15 be capable of decoding correctly all bitstreams with profile and level indication marked by an X in the column. In case of scalable hierarchy of bitstreams, the profile and level indication are that of the upper layer.

NOTE – For Profiles and Levels which obey a hierarchical structure, it is recommended that each layer of the bitstream contain the profile_and_level_indication of the "simplest" decoder which is capable of successfully decoding that layer of the bitstream. In the case where the profile_and_level_indication Escape bit == 0, this will be the numerically largest of the possible valid values of profile_and_level_indication.

Table 8-13 – Upper bounds for bit rates (Mbit/s)

Level	Profile						
	Simple	Main	SNR	Spatial	High	4:2:2	Multi-view
High		80			100 all layers 80 middle + base layer 25 base layer	300	– 130 both layers 80 base layer
High-1440		60		60 all layers 40 middle + base layers 15 base layer	80 all layers 60 middle + base layers 20 base layer	–	– 100 both layers 60 base layer
Main	15	15	– 15 both layers 10 base layer		20 all layers 15 middle + base layer 4 base layer	50	– 25 both layers 15 base layer
Low		4	– 4 both layers 3 base layer			–	– 8 both layers 4 base layer

NOTE 1 – This table defines the maximum rate of operation of the VBV for a coded bitstream of the given profile and level. This rate is indicated by bit_rate (see 6.3.3).

NOTE 2 – This table defines the maximum permissible data rate for all layers up to and including the stated layer. For multi-layer coding applications, the data rate apportioned between layers is constrained only by the maximum rate permitted for a given layer as stated in this table.

NOTE 3 – 1 Mbit = 1 000 000 bits

Table 8-14 – VBV buffer size requirements (bits)

Level	Layer	Profile						
		Simple	Main	SNR	Spatial	High	4:2:2	Multi-view
High	Enhancement 2 Enhancement 1 Base		9 781 248			12 222 464 9 781 248 3 047 424	47 185 920	– 15 898 480 9 787 248
High-1440	Enhancement 2 Enhancement 1 Base		7 340 032		7 340 032 4 882 432 1 835 008	9 781 248 7 340 032 2 441 216	–	– 12 222 464 7 340 032
Main	Enhancement 2 Enhancement 1 Base	1 835 008	1 835 008	– 1 835 008 1 212 416		2 441 216 1 835 008 475 136	9 437 184	– 3 047 424 1 835 008
Low	Enhancement 2 Enhancement 1 Base		475 136	– 475 136 360 448			–	– 950 272 475 136

NOTE 1 – The buffer size is calculated to be proportional to the maximum allowable bit rate, rounded down to the nearest multiple of 16 × 1024 bits. The reference value for scaling is the Main profile, Main level buffer size.

NOTE 2 – This table defines the total decoder buffer size required to decode all layers up to and including the stated layer. For multi-layer coding applications, the allocation of buffer memory between layers is constrained only by the maximum size permitted for a given layer as stated in this table.

NOTE 3 – The syntactic element corresponding to this table is vbv_buffer_size (see 6.3.3).

Table 8-15 – Forward compatibility between different profiles and levels

Profile and Level indication in bitstream	Decoder																
	HP @ HL	HP @ H-14	HP @ ML	Spatial @ H-14	SNR @ ML	SNR @ LL	MP @ HL	MP @ H-14	MP @ ML	MP @ LL	SP @ ML	4:2:2P @ ML	4:2:2P @ HL	MVP @ HL	MVP @ H-14	MVP @ ML	MVP @ LL
HP@HL	X																
HP@H-14	X	X															
HP@ML	X	X	X														
Spatial@H-14	X	X		X													
SNR@ML	X	X	X	X	X												
SNR@LL	X	X	X	X	X	X											
MP@HL	X						X						X ^{c)}	X			
MP@H-14	X	X		X			X	X					X ^{c)}	X	X		
MP@ML	X	X	X	X	X		X	X	X			X ^{b)}	X ^{c)}	X	X	X	
MP@LL	X	X	X	X	X	X	X	X	X	X	X ^{a)}	X ^{b)}	X ^{c)}	X	X	X	X
SP@ML	X	X	X	X	X		X	X	X		X	X ^{b)}	X ^{c)}	X	X	X	
ISO/IEC 11172-2	X	X	X	X	X	X	X	X	X	X	X	X ^{b)}	X ^{c)}	X	X	X	X
4:2:2@ML												X	X ^{c)}				
4:2:2@HL													X				
MVP@HL														X			
MVP@H-14														X	X		
MVP@ML														X	X	X	
MVP@LL														X	X	X	X

X indicates that the decoder shall be able to decode the bit stream including all relevant lower layers.

a) SP@ML decoders are required to decode MP@LL bitstreams.

b) A 4:2:2 profile@Main level decoder shall be able to decode Main profile@Main level, Main profile@Low level and Simple profile@Main level bitstreams, as well as ISO/IEC 11172-2 constrained system parameter bitstreams.

c) A 4:2:2 profile@High level decoder shall be able to decode 4:2:2P@ML, MP@HL, MP@HL-1440, MP@ML, MP@LL and SP@ML, as well as ISO/IEC 11172-2 constrained system parameter bitstreams.

9 Registration of Copyright Identifiers

9.1 General

Parts 1, 2, and 3 of ISO/IEC 13818 provide support for the management of audiovisual works copyrighting. In ITU-T Rec. H.222.0 | ISO/IEC 13818-1 this is by means of a copyright descriptor, while ITU-T Rec. H.262 | ISO/IEC 13818-2 and ISO/IEC 13818-3 contain fields for identifying copyright holders through syntax fields in the elementary stream syntax. This Recommendation | International Standard presents the method of obtaining and registering copyright identifiers in ITU-T Rec. H.262 | ISO/IEC 13818-2.

ITU-T Rec. H.262 | ISO/IEC 13818-2 specifies a unique 32-bit copyright_identifier which is a work type code identifier (such as ISBN, ISSN, ISRC, etc.) carried in the copyright descriptor. The copyright_identifier enables identification of a wide number of Copyright Registration Authorities. Each Copyright Registration Authority may specify a syntax and semantic for identifying the audiovisual works or other copyrighted works within that particular copyright organization through appropriate use of the variable length additional_copyright_info field which contains the copyright number.

ISO/IEC 13818-2 : 2000 (E)

In the following subclause and Annexes G, H and I, the benefits and responsibilities of all parties to the registration of `copyright_identifier` are outlined.

9.2 Implementation of a Registration Authority (RA)

ISO/IEC JTC 1 shall call for nominations for an international organization which will serve as the Registration Authority for the **copyright_identifier** as defined in ITU-T Rec. H.262 | ISO/IEC 13818-2. The selected organization shall serve as the Registration Authority. The so-named Registration Authority shall execute its duties in compliance with Annex H of the JTC 1 Directives. The registered `copyright_identifier` is hereafter referred to as the Registered Identifier (RID).

Upon selection of the Registration Authority, JTC 1 shall require the creation of a Registration Management Group (RMG) which will review appeals filed by organizations whose request for an RID to be used in conjunction with ITU-T Rec. H.262 | ISO/IEC 13818-2 has been denied by the Registration Authority.

Annexes G, H and I to this Specification provide information on the procedures for registering a unique `copyright_identifier`.

Annex A

Inverse discrete transform

(This annex forms an integral part of this Recommendation | International Standard)

The $N \times N$ two dimensional DCT is defined as:

$$F(u, v) = \frac{2}{N} C(u)C(v) \sum_{x=0}^{N-1} \sum_{y=0}^{N-1} f(x, y) \cos \frac{(2x+1)u\pi}{2N} \cos \frac{(2y+1)v\pi}{2N}$$

with $u, v, x, y = 0, 1, 2, \dots, N-1$

where x, y are spatial coordinates in the sample domain

u, v are coordinates in the transform domain

$$C(u), C(v) = \begin{cases} \frac{1}{\sqrt{2}} & \text{for } u, v = 0 \\ 1 & \text{otherwise} \end{cases}$$

The definition of the DCT (also called forward DCT) is purely informative. Forward DCT is not used by the decoding process described by this Specification.

The mathematical real-number IDCT is defined as:

$$f(x, y) = \frac{2}{N} \sum_{u=0}^{N-1} \sum_{v=0}^{N-1} C(u)C(v)F(u, v) \cos \frac{(2x+1)u\pi}{2N} \cos \frac{(2y+1)v\pi}{2N}$$

$f(x, y)$ is a real number.

The mathematical integer-number IDCT is defined as:

$$f'(x, y) = \text{round}(f(x, y))$$

where $\text{round}()$ is the rounding to the nearest integer, with half-integer values rounded away from zero. No clamping or saturation is performed.

The saturated mathematical integer-number IDCT is defined as:

$$f''(x, y) = \text{saturate}(f'(x, y))$$

where $\text{saturate}()$ is the saturation in the range $[-256, 255]$, defined as:

$$\text{saturate}(x) = \begin{cases} -256 & x < -256 \\ 255 & x > 255 \\ x & -256 \leq x \leq 255 \end{cases}$$

The IDCT function $f[y][x]$ used in the decoding process may be any of several approximations of the saturated mathematical integer-number IDCT $f''(x, y)$, provided that it meets all of the following requirements:

- 1) The IDCT function $f[y][x]$ used in the decoding process shall have values always in the range $[-256, 255]$.
- 2) The IDCT function $f[y][x]$ used in the decoding process shall conform to the IEEE Standard Specification for the implementation of 8 by 8 Inverse Discrete Cosine Transform, IEEE Std. 1180-1990, 6 December 1990.
- 3) This item applies only when input blocks of DCT coefficients cause all the 64 values output of the mathematical integer-number IDCT $f'(x, y)$ to be in the range $[-384, 383]$. When $f'(x, y) > 256$, $f[y][x]$ shall be equal to 255 and when $f'(x, y) < -257$, $f[y][x]$ shall be equal to -256 . For all values of $f'(x, y)$ in the range $[-257, 256]$ the absolute difference between $f[y][x]$ and $f''(x, y)$ shall not be larger than 2.

4) Let F be the set of 4096 blocks $Bi[y][x]$ ($i = 0 \dots 4095$) defined as follows:

- a) $Bi[0][0] = i - 2048$.
- b) $Bi[7][7] = 1$ if $Bi[0][0]$ is even, $Bi[7][7] = 0$ if $Bi[0][0]$ is odd.
- c) All other coefficients $Bi[y][x]$ other than $Bi[0][0]$ and $Bi[7][7]$ are equal to 0.

For each block $Bi[y][x]$ that belongs to set F defined above, an IDCT that conforms to this specification (see Annex A) shall output a block $f[y][x]$ that has a peak error of 1 or less compared to the reference saturated mathematical integer-number IDCT $f''(x, y)$. In other words, $|f[y][x] - f''(x, y)|$ shall be ≤ 1 for all x and y.

In addition to these requirements, the following is a recommendation on the accuracy of the IDCT function $f[y][x]$.

- 5) When item 3) does not apply, i.e. for input blocks of DCT coefficients causing the output of the mathematical integer-number IDCT $f'(x, y)$ to contain one or more values out of the range $[-384, 383]$, it is desirable that $f[y][x]$ be as close as possible to $f''(x, y)$ for all bitstreams produced by reasonably well-designed encoders.

NOTE – Clause 2.3 IEEE Standard 1180-1990 "Considerations of Specifying IDCT Mismatch Errors" requires the specification of periodic intra-picture coding in order to control the accumulation of mismatch errors. Every macroblock is required to be refreshed before it is coded 132 times as predictive macroblocks. Macroblocks in B-pictures (and skipped macroblocks in P-pictures) are excluded from the counting because they do not lead to the accumulation of mismatch errors. This requirement is the same as indicated in 1180-1990 for visual telephony according to Recommendation H.261.

Annex B

Variable length code tables

(This annex forms an integral part of this Recommendation | International Standard)

B.1 Macroblock addressing

See Table B.1.

Table B.1 – Variable length codes for macroblock_address_increment

macroblock_address_increment VLC code	Increment value	macroblock_address_increment VLC code	Increment value
1	1	0000 0101 01	18
011	2	0000 0101 00	19
010	3	0000 0100 11	20
0011	4	0000 0100 10	21
0010	5	0000 0100 011	22
0001 1	6	0000 0100 010	23
0001 0	7	0000 0100 001	24
0000 111	8	0000 0100 000	25
0000 110	9	0000 0011 111	26
0000 1011	10	0000 0011 110	27
0000 1010	11	0000 0011 101	28
0000 1001	12	0000 0011 100	29
0000 1000	13	0000 0011 011	30
0000 0111	14	0000 0011 010	31
0000 0110	15	0000 0011 001	32
0000 0101 11	16	0000 0011 000	33
0000 0101 10	17	0000 0001 000	macroblock_escape

NOTE – The "macroblock stuffing" entry that is available in ISO/IEC 11172-2 is not available in this Specification.

B.2 Macroblock type

The properties of the macroblock are determined by the macroblock type VLC according to Tables B.2 to B.8.

Table B.2 – Variable length codes for macroblock_type in I-pictures

macroblock_type VLC code								
	macroblock_quant							
		macroblock_motion_forward						
			macroblock_motion_backward					
				macroblock_pattern				
					macroblock_intra			
						spatial_temporal_weight_code_flag		
						permitted spatial_temporal_weight_classes		
						Description		
1	0	0	0	0	1	0	Intra	0
01	1	0	0	0	1	0	Intra, Quant	0

Table B.3 – Variable length codes for macroblock_type in P-pictures

macroblock_type VLC code								
	macroblock_quant							
		macroblock_motion_forward						
			macroblock_motion_backward					
				macroblock_pattern				
					macroblock_intra			
						spatial_temporal_weight_code_flag		
						permitted spatial_temporal_weight_classes		
						Description		
1	0	1	0	1	0	0	MC, Coded	0
01	0	0	0	1	0	0	No MC, Coded	0
001	0	1	0	0	0	0	MC, Not Coded	0
0001 1	0	0	0	0	1	0	Intra	0
0001 0	1	1	0	1	0	0	MC, Coded, Quant	0
0000 1	1	0	0	1	0	0	No MC, Coded, Quant	0
0000 01	1	0	0	0	1	0	Intra, Quant	0

Table B.4 – Variable length codes for macroblock_type in B-pictures

macroblock_type VLC code								
macroblock_quant								
macroblock_motion_forward								
macroblock_motion_backward								
macroblock_pattern								
macroblock_intra								
spatial_temporal_weight_code_flag								
permitted spatial_temporal_weight_classes								
Description								
10	0	1	1	0	0	0	Interp, Not Coded	0
11	0	1	1	1	0	0	Interp, Coded	0
010	0	0	1	0	0	0	Bwd, Not Coded	0
011	0	0	1	1	0	0	Bwd, Coded	0
0010	0	1	0	0	0	0	Fwd, Not Coded	0
0011	0	1	0	1	0	0	Fwd, Coded	0
0001 1	0	0	0	0	1	0	Intra	0
0001 0	1	1	1	1	0	0	Interp, Coded, Quant	0
0000 11	1	1	0	1	0	0	Fwd, Coded, Quant	0
0000 10	1	0	1	1	0	0	Bwd, Coded, Quant	0
0000 01	1	0	0	0	1	0	Intra, Quant	0

Table B.5 – Variable length codes for macroblock_type in I-pictures with spatial scalability

macroblock_type VLC code								
macroblock_quant								
macroblock_motion_forward								
macroblock_motion_backward								
macroblock_pattern								
macroblock_intra								
spatial_temporal_weight_code_flag								
permitted spatial_temporal_weight_classes								
Description								
1	0	0	0	1	0	0	Coded, Compatible	4
01	1	0	0	1	0	0	Coded, Compatible, Quant	4
0011	0	0	0	0	1	0	Intra	0
0010	1	0	0	0	1	0	Intra, Quant	0
0001	0	0	0	0	0	0	Not Coded, Compatible	4

Table B.6 – Variable length codes for macroblock_type in P-pictures with spatial scalability

macroblock_type VLC code								
macroblock_quant								
macroblock_motion_forward								
macroblock_motion_backward								
macroblock_pattern								
macroblock_intra								
spatial_temporal_weight_code_flag								
permitted spatial_temporal_weight_classes								
Description								
10	0	1	0	1	0	0	MC, Coded	0
011	0	1	0	1	0	1	MC, Coded, Compatible	1,2,3
0000 100	0	0	0	1	0	0	No MC, Coded	0
0001 11	0	0	0	1	0	1	No MC, Coded, Compatible	1,2,3
0010	0	1	0	0	0	0	MC, Not Coded	0
0000 111	0	0	0	0	1	0	Intra	0
0011	0	1	0	0	0	1	MC, Not coded, Compatible	1,2,3
010	1	1	0	1	0	0	MC, Coded, Quant	0
0001 00	1	0	0	1	0	0	No MC, Coded, Quant	0
0000 110	1	0	0	0	1	0	Intra, Quant	0
11	1	1	0	1	0	1	MC, Coded, Compatible, Quant	1,2,3
0001 01	1	0	0	1	0	1	No MC, Coded, Compatible, Quant	1,2,3
0001 10	0	0	0	0	0	1	No MC, Not Coded, Compatible	1,2,3
0000 101	0	0	0	1	0	0	Coded, Compatible	4
0000 010	1	0	0	1	0	0	Coded, Compatible, Quant	4
0000 011	0	0	0	0	0	0	Not Coded, Compatible	4

Table B.7 – Variable length codes for macroblock_type in B-pictures with spatial scalability

macroblock_type VLC code								
macroblock_quant								
macroblock_motion_forward								
macroblock_motion_backward								
macroblock_pattern								
macroblock_intra								
spatial_temporal_weight_code_flag								
permitted spatial_temporal_weight_classes								
Description								
10	0	1	1	0	0	0	Interp, Not coded	0
11	0	1	1	1	0	0	Interp, Coded	0
010	0	0	1	0	0	0	Back, Not coded	0
011	0	0	1	1	0	0	Back, Coded	0
0010	0	1	0	0	0	0	For, Not coded	0
0011	0	1	0	1	0	0	For, Coded	0
0001 10	0	0	1	0	0	1	Back, Not Coded, Compatible	1,2,3
0001 11	0	0	1	1	0	1	Back, Coded, Compatible	1,2,3
0001 00	0	1	0	0	0	1	For, Not Coded, Compatible	1,2,3
0001 01	0	1	0	1	0	1	For, Coded, Compatible	1,2,3
0000 110	0	0	0	0	1	0	Intra	0
0000 111	1	1	1	1	0	0	Interp, Coded, Quant	0
0000 100	1	1	0	1	0	0	For, Coded, Quant	0
0000 101	1	0	1	1	0	0	Back, Coded, Quant	0
0000 0100	1	0	0	0	1	0	Intra, Quant	0
0000 0101	1	1	0	1	0	1	For, Coded, Compatible, Quant	1,2,3
0000 0110 0	1	0	1	1	0	1	Back, Coded, Compatible, Quant	1,2,3
0000 0111 0	0	0	0	0	0	0	Not Coded, Compatible	4
0000 0110 1	1	0	0	1	0	0	Coded, Compatible, Quant	4
0000 0111 1	0	0	0	1	0	0	Coded, Compatible	4

Table B.8 – Variable length codes for macroblock_type in I-pictures, P-pictures and B-pictures with SNR scalability

macroblock_type VLC code								
macroblock_quant								
macroblock_motion_forward								
macroblock_motion_backward								
macroblock_pattern								
macroblock_intra								
spatial_temporal_weight_code_flag								
permitted spatial_temporal_weight_classes								
Description								
1	0	0	0	1	0	0	Coded	0
01	1	0	0	1	0	0	Coded, Quant	0
001	0	0	0	0	0	0	Not Coded	0

NOTE – There is no differentiation between picture types, since macroblocks are processed identically in I-, P- and B-pictures. The "Not coded" type is needed, since skipped macroblocks are not allowed at beginning and end of a slice.

B.3 Macroblock pattern

See Table B.9.

Table B.9 – Variable length codes for coded_block_pattern

coded_block_pattern VLC code	cbp	coded_block_pattern VLC code	cbp
111	60	0001 1100	35
1101	4	0001 1011	13
1100	8	0001 1010	49
1011	16	0001 1001	21
1010	32	0001 1000	41
1001 1	12	0001 0111	14
1001 0	48	0001 0110	50
1000 1	20	0001 0101	22
1000 0	40	0001 0100	42
0111 1	28	0001 0011	15
0111 0	44	0001 0010	51
0110 1	52	0001 0001	23
0110 0	56	0001 0000	43
0101 1	1	0000 1111	25
0101 0	61	0000 1110	37
0100 1	2	0000 1101	26
0100 0	62	0000 1100	38
0011 11	24	0000 1011	29
0011 10	36	0000 1010	45
0011 01	3	0000 1001	53
0011 00	63	0000 1000	57
0010 111	5	0000 0111	30
0010 110	9	0000 0110	46
0010 101	17	0000 0101	54
0010 100	33	0000 0100	58
0010 011	6	0000 0011 1	31
0010 010	10	0000 0011 0	47
0010 001	18	0000 0010 1	55
0010 000	34	0000 0010 0	59
0001 1111	7	0000 0001 1	27
0001 1110	11	0000 0001 0	39
0001 1101	19	0000 0000 1	0 (Note)
NOTE – This entry shall not be used with 4:2:0 chrominance structure.			

B.4 Motion vectors

See Tables B.10 and B.11.

Table B.10 – Variable length codes for motion_code

Variable length code	motion_code[r][s][t]
0000 0011 001	-16
0000 0011 011	-15
0000 0011 101	-14
0000 0011 111	-13
0000 0100 001	-12
0000 0100 011	-11
0000 0100 11	-10
0000 0101 01	-9
0000 0101 11	-8
0000 0111	-7
0000 1001	-6
0000 1011	-5
0000 111	-4
0001 1	-3
0011	-2
011	-1
1	0
010	1
0010	2
0001 0	3
0000 110	4
0000 1010	5
0000 1000	6
0000 0110	7
0000 0101 10	8
0000 0101 00	9
0000 0100 10	10
0000 0100 010	11
0000 0100 000	12
0000 0011 110	13
0000 0011 100	14
0000 0011 010	15
0000 0011 000	16

Table B.11 – Variable length codes for dmvector[t]

Code	Value
11	-1
0	0
10	1

B.5 DCT coefficients

See Tables B.12 to B.16.

Table B.12 – Variable length codes for dct_dc_size_luminance

Variable length code	dct_dc_size_luminance
100	0
00	1
01	2
101	3
110	4
1110	5
1111 0	6
1111 10	7
1111 110	8
1111 1110	9
1111 1111 0	10
1111 1111 1	11

Table B.13 – Variable length codes for dct_dc_size_chrominance

Variable length code	dct_dc_size_chrominance
00	0
01	1
10	2
110	3
1110	4
1111 0	5
1111 10	6
1111 110	7
1111 1110	8
1111 1111 0	9
1111 1111 10	10
1111 1111 11	11

Table B.14 – DCT coefficients Table zero

Variable length code (Note 1)	Run	Level
10 (Note 2)	End of Block	
1 s (Note 3)	0	1
11 s (Note 4)	0	1
011 s	1	1
0100 s	0	2
0101 s	2	1
0010 1 s	0	3
0011 1 s	3	1
0011 0 s	4	1
0001 10 s	1	2
0001 11 s	5	1
0001 01 s	6	1
0001 00 s	7	1
0000 110 s	0	4
0000 100 s	2	2
0000 111 s	8	1
0000 101 s	9	1
0000 01	Escape	
0010 0110 s	0	5
0010 0001 s	0	6
0010 0101 s	1	3
0010 0100 s	3	2
0010 0111 s	10	1
0010 0011 s	11	1
0010 0010 s	12	1
0010 0000 s	13	1
0000 0010 10 s	0	7
0000 0011 00 s	1	4
0000 0010 11 s	2	3
0000 0011 11 s	4	2
0000 0010 01 s	5	2
0000 0011 10 s	14	1
0000 0011 01 s	15	1
0000 0010 00 s	16	1

Table B.14 – DCT coefficients Table zero (continued)

Variable length code (Note 1)	Run	Level
0000 0001 1101 s	0	8
0000 0001 1000 s	0	9
0000 0001 0011 s	0	10
0000 0001 0000 s	0	11
0000 0001 1011 s	1	5
0000 0001 0100 s	2	4
0000 0001 1100 s	3	3
0000 0001 0010 s	4	3
0000 0001 1110 s	6	2
0000 0001 0101 s	7	2
0000 0001 0001 s	8	2
0000 0001 1111 s	17	1
0000 0001 1010 s	18	1
0000 0001 1001 s	19	1
0000 0001 0111 s	20	1
0000 0001 0110 s	21	1
0000 0000 1101 0 s	0	12
0000 0000 1100 1 s	0	13
0000 0000 1100 0 s	0	14
0000 0000 1011 1 s	0	15
0000 0000 1011 0 s	1	6
0000 0000 1010 1 s	1	7
0000 0000 1010 0 s	2	5
0000 0000 1001 1 s	3	4
0000 0000 1001 0 s	5	3
0000 0000 1000 1 s	9	2
0000 0000 1000 0 s	10	2
0000 0000 1111 1 s	22	1
0000 0000 1111 0 s	23	1
0000 0000 1110 1 s	24	1
0000 0000 1110 0 s	25	1
0000 0000 1101 1 s	26	1

Table B.14 – DCT coefficients Table zero (continued)

Variable length code (Note 1)	Run	Level
0000 0000 0111 11 s	0	16
0000 0000 0111 10 s	0	17
0000 0000 0111 01 s	0	18
0000 0000 0111 00 s	0	19
0000 0000 0110 11 s	0	20
0000 0000 0110 10 s	0	21
0000 0000 0110 01 s	0	22
0000 0000 0110 00 s	0	23
0000 0000 0101 11 s	0	24
0000 0000 0101 10 s	0	25
0000 0000 0101 01 s	0	26
0000 0000 0101 00 s	0	27
0000 0000 0100 11 s	0	28
0000 0000 0100 10 s	0	29
0000 0000 0100 01 s	0	30
0000 0000 0100 00 s	0	31
0000 0000 0011 000 s	0	32
0000 0000 0010 111 s	0	33
0000 0000 0010 110 s	0	34
0000 0000 0010 101 s	0	35
0000 0000 0010 100 s	0	36
0000 0000 0010 011 s	0	37
0000 0000 0010 010 s	0	38
0000 0000 0010 001 s	0	39
0000 0000 0010 000 s	0	40
0000 0000 0011 111 s	1	8
0000 0000 0011 110 s	1	9
0000 0000 0011 101 s	1	10
0000 0000 0011 100 s	1	11
0000 0000 0011 011 s	1	12
0000 0000 0011 010 s	1	13
0000 0000 0011 001 s	1	14

Table B.14 – DCT coefficients Table zero (concluded)

Variable length code (Note 1)	Run	Level
0000 0000 0001 0011 s	1	15
0000 0000 0001 0010 s	1	16
0000 0000 0001 0001 s	1	17
0000 0000 0001 0000 s	1	18
0000 0000 0001 0100 s	6	3
0000 0000 0001 1010 s	11	2
0000 0000 0001 1001 s	12	2
0000 0000 0001 1000 s	13	2
0000 0000 0001 0111 s	14	2
0000 0000 0001 0110 s	15	2
0000 0000 0001 0101 s	16	2
0000 0000 0001 1111 s	27	1
0000 0000 0001 1110 s	28	1
0000 0000 0001 1101 s	29	1
0000 0000 0001 1100 s	30	1
0000 0000 0001 1011 s	31	1
<p>NOTE 1 – The last bit 's' denotes the sign of the level: '0' for positive, '1' for negative.</p> <p>NOTE 2 – "End of Block" shall not be the only code of the block.</p> <p>NOTE 3 – This code shall be used for the first (DC) coefficient in the block.</p> <p>NOTE 4 – This code shall be used for all other coefficients.</p>		

Table B.15 – DCT coefficients Table one

Variable length code (Note 1)	Run	Level
0110 (Note 2)	End of Block	
10s	0	1
010 s	1	1
110 s	0	2
0010 1 s	2	1
0111 s	0	3
0011 1 s	3	1
0001 10 s	4	1
0011 0 s	1	2
0001 11 s	5	1
0000 110 s	6	1
0000 100 s	7	1
1110 0 s	0	4
0000 111 s	2	2
0000 101 s	8	1
1111 000 s	9	1
0000 01	Escape	
1110 1 s	0	5
0001 01 s	0	6
1111 001 s	1	3
0010 0110 s	3	2
1111 010 s	10	1
0010 0001 s	11	1
0010 0101 s	12	1
0010 0100 s	13	1
0001 00 s	0	7
0010 0111 s	1	4
1111 1100 s	2	3
1111 1101 s	4	2
0000 0010 0 s	5	2
0000 0010 1 s	14	1
0000 0011 1 s	15	1
0000 0011 01 s	16	1

Table B.15 – DCT coefficients Table one (continued)

Variable length code (Note 1)	Run	Level
1111 011 s	0	8
1111 100 s	0	9
0010 0011 s	0	10
0010 0010 s	0	11
0010 0000 s	1	5
0000 0011 00 s	2	4
0000 0001 1100 s	3	3
0000 0001 0010 s	4	3
0000 0001 1110 s	6	2
0000 0001 0101 s	7	2
0000 0001 0001 s	8	2
0000 0001 1111 s	17	1
0000 0001 1010 s	18	1
0000 0001 1001 s	19	1
0000 0001 0111 s	20	1
0000 0001 0110 s	21	1
1111 1010 s	0	12
1111 1011 s	0	13
1111 1110 s	0	14
1111 1111 s	0	15
0000 0000 1011 0 s	1	6
0000 0000 1010 1 s	1	7
0000 0000 1010 0 s	2	5
0000 0000 1001 1 s	3	4
0000 0000 1001 0 s	5	3
0000 0000 1000 1 s	9	2
0000 0000 1000 0 s	10	2
0000 0000 1111 1 s	22	1
0000 0000 1111 0 s	23	1
0000 0000 1110 1 s	24	1
0000 0000 1110 0 s	25	1
0000 0000 1101 1 s	26	1

Table B.15 – DCT coefficients Table one (continued)

Variable length code (Note 1)	Run	Level
0000 0000 0111 11 s	0	16
0000 0000 0111 10 s	0	17
0000 0000 0111 01 s	0	18
0000 0000 0111 00 s	0	19
0000 0000 0110 11 s	0	20
0000 0000 0110 10 s	0	21
0000 0000 0110 01 s	0	22
0000 0000 0110 00 s	0	23
0000 0000 0101 11 s	0	24
0000 0000 0101 10 s	0	25
0000 0000 0101 01 s	0	26
0000 0000 0101 00 s	0	27
0000 0000 0100 11 s	0	28
0000 0000 0100 10 s	0	29
0000 0000 0100 01 s	0	30
0000 0000 0100 00 s	0	31
0000 0000 0011 000 s	0	32
0000 0000 0010 111 s	0	33
0000 0000 0010 110 s	0	34
0000 0000 0010 101 s	0	35
0000 0000 0010 100 s	0	36
0000 0000 0010 011 s	0	37
0000 0000 0010 010 s	0	38
0000 0000 0010 001 s	0	39
0000 0000 0010 000 s	0	40
0000 0000 0011 111 s	1	8
0000 0000 0011 110 s	1	9
0000 0000 0011 101 s	1	10
0000 0000 0011 100 s	1	11
0000 0000 0011 011 s	1	12
0000 0000 0011 010 s	1	13
0000 0000 0011 001 s	1	14

Table B.15 – DCT coefficients Table one (concluded)

Variable length code (Note 1)	Run	Level
0000 0000 0001 0011 s	1	15
0000 0000 0001 0010 s	1	16
0000 0000 0001 0001 s	1	17
0000 0000 0001 0000 s	1	18
0000 0000 0001 0100 s	6	3
0000 0000 0001 1010 s	11	2
0000 0000 0001 1001 s	12	2
0000 0000 0001 1000 s	13	2
0000 0000 0001 0111 s	14	2
0000 0000 0001 0110 s	15	2
0000 0000 0001 0101 s	16	2
0000 0000 0001 1111 s	27	1
0000 0000 0001 1110 s	28	1
0000 0000 0001 1101 s	29	1
0000 0000 0001 1100 s	30	1
0000 0000 0001 1011 s	31	1
NOTE 1 –The last bit 's' denotes the sign of the level: '0' for positive, '1' for negative.		
NOTE 2 – "End of Block" shall not be the only code of the block.		

Table B.16 – Encoding of run and level following an ESCAPE code

Fixed length code	Run
0000 00	0
0000 01	1
0000 10	2
...	...
...	...
...	...
...	...
1111 11	63

Fixed length code	signed_level
1000 0000 0000	reserved
1000 0000 0001	-2047
1000 0000 0010	-2046
...	...
1111 1111 1111	-1
0000 0000 0000	Forbidden
0000 0000 0001	+1
...	...
0111 1111 1111	+2047

Annex C

Video buffering verifier

(This annex forms an integral part of this Recommendation | International Standard)

Coded video bitstreams shall meet constraints imposed through a Video Buffering Verifier (VBV) defined in this annex. Each bitstream in a scalable hierarchy shall not violate the VBV constraints defined in this annex.

The VBV is a hypothetical decoder, which is conceptually connected to the output of an encoder. It has an input buffer known as the VBV buffer. Coded data is placed in the buffer as defined below in C.3 and is removed from the buffer as defined in C.5, C.6, and C.7. It is required that a bitstream that conforms to this Specification shall not cause the VBV buffer to overflow. When `low_delay` equals zero, the bitstream shall not cause the VBV buffer to underflow. When `low_delay` equals one, decoding a picture at the normally expected time might cause the VBV buffer to underflow. If this is the case, the picture is not decoded and the VBV buffer is re-examined at a sequence of later times specified in C.7 and C.8 until it is all present in the VBV buffer.

All the arithmetic in this annex is done with real-values, so that no rounding errors can propagate. For example, the number of bits in the VBV buffer is not necessarily an integer.

C.1 The VBV and the video encoder have the same clock frequency as well as the same frame rate, and are operated synchronously.

C.2 The VBV buffer is of size B , where B is the `vbv_buffer_size` coded in the sequence header and sequence extension if present.

C.3 This subclause defines the input of data to the VBV buffer. Two mutually exclusive cases are defined in C.3.1 and C.3.2. In both cases the VBV buffer is initially empty. Let R_{\max} be the bitrate specified in the `bit_rate` field.

C.3.1 In the case where `vbv_delay` is coded with a value not equal to hexadecimal FFFF, the picture data of the n -th coded picture enters the buffer at a rate $R(n)$ where:

$$R(n) = d_n^* / (\tau(n) - \tau(n+1) + t(n+1) - t(n))$$

Where

$R(n)$ is the rate, in bits/s, that the picture data for the n -th coded picture enters the VBV.

d_n^* is the number of bits after the final bit of the n -th picture start code and before and including the final bit of the $(n+1)$ -th picture start code.

$\tau(n)$ is the decoding delay coded in `vbv_delay` for the n -th coded picture, measured in seconds.

$t(n)$ is the time, measured in seconds, when the n -th coded picture is removed from VBV buffer. $t(n)$ is defined in C.9, C.10, C.11, and C.12.

Ambiguity at the beginning of a sequence:

The interval of time $t_{n+1} - t_n$ between removal of two consecutive pictures can normally be derived from the bitstream as described in C.9, C.10, C.11 and C.12.

When random access is made in a sequence, $t_{n+1} - t_n$ cannot be determined from the video bitstream alone for the first picture(s) after the sequence header since the previous coded P- or I-frame does not exist in the decoded sequence. If the bitstream is multiplexed as part of a systems bitstream according to ITU-T Rec. H.222.0 | ISO/IEC 13818-1, then it is possible (but not certain) that information in the systems bitstream may be used to determine unambiguously this interval of time. This information is available if Decoding Time Stamps (DTS) are transmitted for pictures n and $n+1$.

If the rate $R(n)$ cannot be determined unambiguously, it is not possible for the VBV to precisely determine the fullness in trajectories in the VBV buffer during a limited period (always less than the maximum value for `vbv_delay`, which is approximately 0.73 seconds), therefore strict VBV verification of the entire bitstream is not always possible. Note that an encoder always knows the values of $t_{n+1} - t_n$ after each repeated sequence headers and therefore knows how to generate a bitstream that does not violate the VBV constraints at those points.

The ambiguity may become a problem when the video bitstream is remultiplexed and delivered at a rate different from the intended piecewise constant rate $R(n)$.

It should also be noted that the input rate for the bits preceding the first picture header cannot be determined from the bitstream.

Ambiguity at the end of a sequence:

The input of all the bits following the picture start code of the picture preceding an end of sequence code cannot be determined from the bitstream. There shall exist an input rate for these bits that does not lead to an overflow or, if low_delay is equal to 1, an underflow of the VBV buffer. This rate shall be less than the maximum rate specified in the sequence header.

After filling the VBV buffer with all the data that precedes the first picture start code of the sequence and the picture start code itself, the VBV buffer is filled from the bitstream for the time specified by the vbv_delay field in the picture header. At this time decoding begins. The data input continues at the rates specified in this subclause.

For all bitstreams $R(n) \leq R_{max}$ for all picture data.

NOTE – For constant rate video the sequence of values $R(n)$ are constant throughout the sequence to within the accuracy permitted by the quantisation of vbv_delay .

C.3.2 In the case where vbv_delay is coded with the value hexadecimal FFFF, data enters the VBV buffer as specified in this subclause.

If the VBV buffer is not full, data enters the buffer at R_{max} .

If the VBV buffer becomes full after filling at R_{max} for some time, no more data enters the buffer until some data is removed from the buffer.

After filling the VBV buffer with all the data that precedes the first picture start code of the sequence and the picture start code itself, the VBV buffer is filled from the bitstream until it is full. At this time decoding begins. The data input continues at the rate specified in this subclause.

C.4 Starting at the time defined in C.3, the VBV buffer is examined at successive times defined in C.9 to C.12. C.5 to C.8 defines the actions to be taken at each time the VBV buffer is examined.

C.5 This subclause defines a requirement on all video bitstreams.

At the time the VBV buffer is examined *before* removing any picture data, the number of bits in the buffer shall lie between zero bits and B bits where B is the size of the VBV buffer indicated by vbv_buffer_size .

For the purpose of this annex, picture data is defined as all the bits of the coded picture, all the header(s) and user data immediately preceding it if any (including any stuffing between them) and all the stuffing following it, up to (but not including) the next start code, except in the case where the next start code is an end of sequence code, in which case it is included in the picture data.

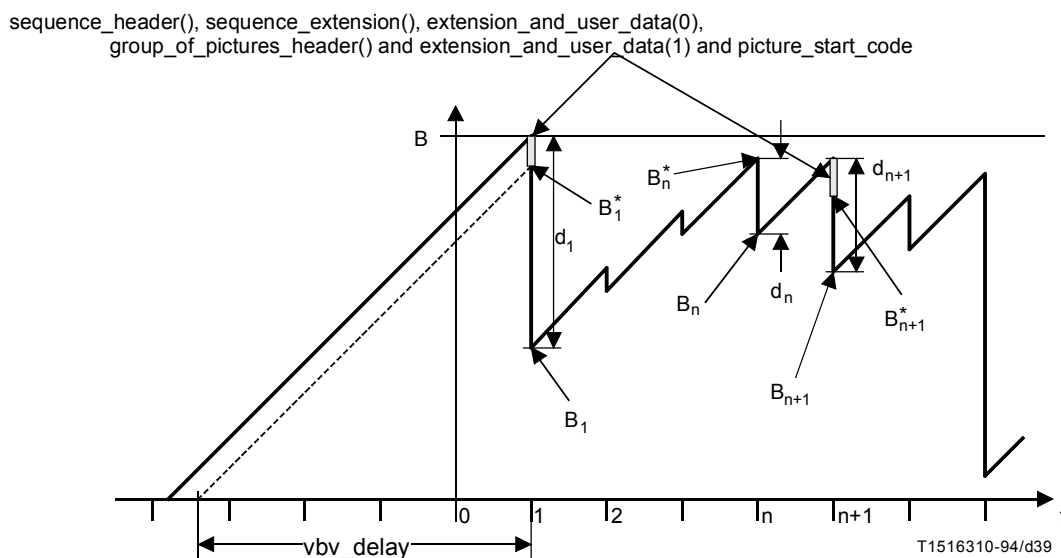

Figure C.1 – VBV Buffer Occupancy – Constant bit-rate operation

C.6 This subclause defines a requirement on the video bitstreams when the `low_delay` flag is equal to zero.

At each time the VBV buffer is examined and before any bits are removed, all of the data for the picture which (at that time) has been in the buffer longest shall be present in the VBV buffer. This picture data shall be removed instantaneously at this time.

VBV buffer underflow shall not occur when the `low_delay` flag is equal to 0. This requires that all picture data for the n -th picture shall be present in the VBV buffer at the decoding time, t_n .

C.7 This subclause only applies when the `low_delay` flag is equal to one.

When `low_delay` is equal to one, there may be situations where the VBV buffer shall be re-examined several times before removing a coded picture from the VBV buffer. It is possible to know if the VBV buffer has to be re-examined and how many times by looking at the `temporal_reference` of the next picture (the one that follows the picture currently to be decoded), see 6.3.10. If the VBV buffer has to be re-examined, the picture currently to be decoded is referred to as a big picture.

If picture currently to be decoded is a big picture, the VBV buffer is re-examined at intervals of 2 field-periods before removing the big picture, and no picture data is removed until the final re-examination.

At this time, the number of bits the VBV buffer immediately before removing the big picture shall be less than B , all the picture data for the picture that has been in the buffer longest (the big picture) shall be present in the buffer and shall be removed instantaneously. Then, normal operation of the VBV resumes, and C.5 applies.

The last coded picture of a sequence shall not be a big picture.

C.8 This subclause is informative only.

The situation where the VBV buffer would underflow (see C.7) can happen when low-delay applications transmit occasionally large pictures, for example in case of scene-cuts.

Decoding such bitstreams will cause the display process associated with a decoder to repeat a previously decoded field or frame until normal operation of the VBV can resume. This process is sometimes referred to as the occurrence of "skipped pictures". Note that this situation should normally not occur except occasionally. It shall not occur when `low_delay` is equal to 0.

C.9 This subclause defines the time intervals between successive examination of the VBV buffer in the case where `progressive_sequence` equals to 1 and `low_delay` equals to 0. In this case, the frame re-ordering delay always exists and B-pictures can occur.

The time interval $t_{n+1} - t_n$ between two successive examinations of the VBV buffer is a multiple of T , where T is the inverse of the frame rate.

If the n -th picture is a B-picture with `repeat_first_field` equals to 0, then $t_{n+1} - t_n$ is equal to T .

If the n -th picture is a B-Picture with `repeat_first_field` equal to 1 and `top_field_first` equals 0, then $t_{n+1} - t_n$ is equal to $2 * T$.

If the n -th picture is a B-Picture with `repeat_first_field` equal to 1 and `top_field_first` equals 1, then $t_{n+1} - t_n$ is equal to $3 * T$.

If the n -th picture is a P-Picture or I-Picture and if the previous P-Picture or I-Picture has `repeat_first_field` equal to 0, then $t_{n+1} - t_n$ is equal to T .

If the n -th picture is a P-Picture or I-Picture and if the previous P-Picture or I-Picture has `repeat_first_field` equal to 1 and `top_field_first` equal to 0, then $t_{n+1} - t_n$ is equal to $2 * T$.

If the n -th picture is a P-Picture or I-Picture and if the previous P-Picture or I-Picture has `repeat_first_field` equal to 1 and `top_field_first` equal to 1, then $t_{n+1} - t_n$ is equal to $3 * T$.

C.10 This subclause defines the time intervals between successive examination of the VBV buffer in the case where `progressive_sequence` equals to 1 and `low_delay` equals to 1. In this case the sequence contains no B-Pictures and there is no frame re-ordering delay.

The time interval $t_{n+1} - t_n$ between two successive examinations of the VBV buffer is a multiple of T , where T is the inverse of the frame rate.

If the n -th picture is a P-Picture or I-Picture with `repeat_first_field` equal to 0, then $t_{n+1} - t_n$ is equal to T .

If the n -th picture is a P-Picture or I-Picture with `repeat_first_field` equal to 1 and `top_field_first` equal to 0, then $t_{n+1} - t_n$ is equal to $2 * T$.

If the n -th picture is a P-Picture or I-Picture with `repeat_first_field` equal to 1 and `top_field_first` equal to 1, then $t_{n+1} - t_n$ is equal to $3 * T$.

C.11 This subclause defines the time intervals between successive examination of the VBV buffer in the case where `progressive_sequence` equals to 0 and `low_delay` equals to 0. In this case, the frame re-ordering delay always exists and B-pictures can occur.

The time interval $t_{n+1} - t_n$ between two successive examinations of the VBV input buffer is a multiple of T , where T is the inverse of two times the frame rate.

If the n -th picture is a *frame-structure* coded B-frame with `repeat_first_field` equal to 0, then $t_{n+1} - t_n$ is equal to $2 * T$.

If the n -th picture is a *frame-structure* coded B-frame with `repeat_first_field` equal to 1, then $t_{n+1} - t_n$ is equal to $3 * T$.

If the n -th picture is a *field-structure* B-picture (B-field picture), then $t_{n+1} - t_n$ is equal to T .

If the n -th picture is a *frame-structure* coded P-frame or coded I-Frame and if the previous coded P-Frame or coded I-Frame has `repeat_first_field` equal to 0, then $t_{n+1} - t_n$ is equal to $2 * T$.

If the n -th picture is a *frame-structure* coded P-Frame or coded I-Frame and if the previous coded P-Frame or coded I-Frame has `repeat_first_field` equal to 1, then $t_{n+1} - t_n$ is equal to $3 * T$.

If the n -th picture is the *first* field of a *field-structure* coded P-frame or coded I-Frame, then $t_{n+1} - t_n$ is equal to T .

If the n -th picture is the *second* field of a *field-structure* coded P-Frame or coded I-Frame and if the previous coded P-Frame or coded I-Frame is using *field-structure* or has `repeat_first_field` equal to 0, then $t_{n+1} - t_n$ is equal to $(2 * T - T)$.

If the n -th picture is the *second* field of a *field-structure* coded P-Frame or coded I-Frame and if the previous coded P-Frame or coded I-Frame is using *frame-structure* and has `repeat_first_field` equal to 1, then $t_{n+1} - t_n$ is equal to $(3 * T - T)$.

Figure C.2 shows the VBV in a simple case with only frame-pictures. Frames P_0 , B_2 and B_4 have a display duration of 3 fields.

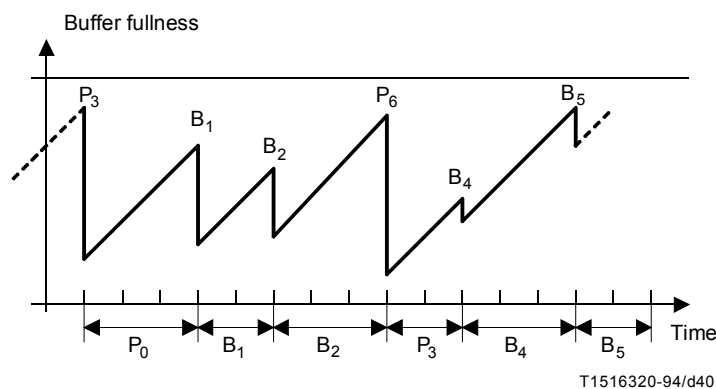

Figure C.2

C.12 This clause defines the time intervals between successive examination of the VBV buffer in the case where `progressive_sequence` equals to 0 and `low_delay` equals to 1. In this case the sequence contains no B-Pictures and there is no frame re-ordering delay.

The time interval $t_{n+1} - t_n$ between two successive examinations of the VBV input buffer is a multiple of T , where T is the inverse of two times the frame rate.

If the n-th picture is a *frame-structure* coded P-Frame or coded I-Frame with `repeat_first_field` equal to 0, then $t_{n+1} - t_n$ is equal to $2 * T$.

If the n-th picture is a *frame-structure* coded P-Frame or coded I-Frame with `repeat_first_field` equal to 1, then $t_{n+1} - t_n$ is equal to $3 * T$.

If the n-th picture is a *field-structure* coded P-Frame or coded I-Frame, then $t_{n+1} - t_n$ is equal to T .

Figure C.3 shows the VBV in a simple case with only frame-pictures. Frames I_0 , P_2 and P_4 have `repeat_first_field` equal to 1.

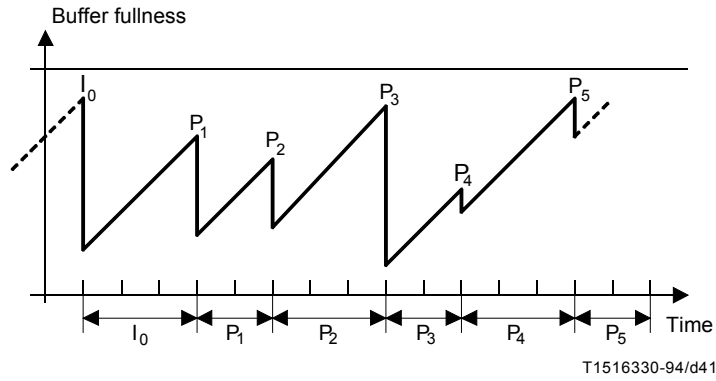

Figure C.3

Annex D

Features supported by the algorithm

(This annex does not form an integral part of this Recommendation | International Standard)

D.1 Overview

The following non-exhaustive list of features is included in this Specification:

- 1) Different chrominance sampling formats (i.e. 4:2:0, 4:2:2 and 4:4:4) can be represented.
- 2) Video in both the progressive and interlaced scan formats can be encoded.
- 3) The decoder can use 3:2 pull down to represent a ~24 fps film as ~30 fps video.
- 4) The displayed video can be selected by a movable pan-scan window within a larger raster.
- 5) A wide range of picture qualities can be used.
- 6) Both constant and variable bitrate channels are supported.
- 7) A low delay mode for face-to-face applications is available.
- 8) Random access (for DSM, channel acquisition, and channel hopping) is available.
- 9) ISO/IEC 11172-2 constrained parameter bitstreams are decodable.
- 10) Bitstreams for high and low (hardware) complexity decoders can be generated.
- 11) Editing of encoded video is supported.
- 12) Fast-forward and fast-reverse playback recorded bitstreams can be implemented.
- 13) The encoded bitstream is resilient to errors.

D.2 Video formats

D.2.1 Sampling formats and colour

This Specification video coding supports both interlaced and progressive video. The respective indication is provided with a `progressive_sequence` flag transmitted in the Sequence Extension code.

Allowed raster sizes are between 1 and $(2^{14} - 1)$ luminance samples each of the horizontal and vertical directions. The video is represented in a luminance/chrominance colour space with selectable colour primaries. The chrominance can be sampled in either the 4:2:0 (half as many samples in the horizontal and vertical directions), 4:2:2 (half as many samples in the horizontal direction only). Furthermore, application specific sample aspect ratios and image aspect ratios are flexibly supported. A `chroma_format` parameter is contained in the Sequence Extension code.

Sample aspect ratio information is provided by means of `aspect_ratio_information` and (optional) `display_horizontal_size` and `display_vertical_size` in the `sequence_display_extension()`. Examples of appropriate values for signals sampled in accordance with Recommendation ITU-R BT. 601 are given in Table D.1.

This Specification implements tools to support 4:4:4 chrominance, for possible future use. However, this is currently not supported in any profile.

Table D.1 – Example display size values

Signal Format	<code>display_horizontal_size</code>	<code>display_vertical_size</code>
525-line	711	483
625-line	702	575

D.2.2 Movie timing

A decoder can implement 3:2 pull down when a sequence of progressive pictures is encoded. Each encoded movie picture can independently specify whether it is displayed for two or three video field periods, so "irregular" 3:2 pull down source material can be transmitted as progressive video. Two flags, `top_field_first` and `repeat_first_field`, are transmitted with the Picture Coding Extensions and adequately describe the necessary display timing.

D.2.3 Display format control

The display process converts a sequence of digital frames (in the case of progressive video) or fields (in the case of interlaced video) to output video. It is not a normative part of this Recommendation | International Standard. The video syntax of this Specification does communicate certain display parameters for use in reconstructing the video. Optional information (in the sequence display extension) specifies the chromaticities, the display primaries, the opto-electronic transfer characteristics (e.g. the value of gamma) and the RGB-to-luminance/chrominance conversion matrix.

Moreover, a display window within the encoded raster may be defined as, e.g. in the case of pan and scan. Alternatively the encoded raster may be defined as a window on a large area display device. In the case of pan-scan the position of the window representing the displayed region of a larger picture can be specified on a field-by-field basis. It is specified in the Picture display extension described in 6.3.12. A typical use for the pan-scan window is to describe the "important" 4:3 aspect ratio rectangle within a 16:9 video sequence. Similarly, in the case of small encoded pictures on a large display, the size of the display and the position of the window within that display may be specified.

D.2.4 Transparent coding of composite video

Decoding from PAL/NTSC before transmission and re-coding to PAL/NTSC after transmission of composite source signals in non-low quality applications, such as contribution and distribution, requires a precise reconstruction of the carrier amplitude and phase reference signal (and v-axis switch for PAL).

The input format can be indicated in the sequence header using the video_format bits. Possible source formats are: PAL, NTSC, SECAM and MAC. Reconstruction of the carrier signal is possible by using the carrier parameters: v_axis, field_sequence, sub_carrier, burst_amplitude and sub_carrier_phase that are enabled by setting the composite_display_flag in the picture_coding_extension().

D.3 Picture quality

High picture quality is provided according to the bitrate used. Provision for very high picture quality is made by sufficiently high bitrate limits relating to a certain level in a particular profile. High chrominance band quality can be achieved by using 4:2:2 chrominance

Quantiser matrices can be downloaded and used with a small a quantiser_scale_code to achieve near lossless coding.

Moreover, scalable coding with flexible bitrate allows for service or quality hierarchy and graceful degradation. E.g. decoding a subset of the bitstream carrying a lower resolution picture allows for decoding this signal in a low-cost receiver with related quality; decoding the complete bitstream allows to obtain the high overall quality.

Furthermore, operation at low bitrates can be accommodated by using low frame rates (by either pre-processing before coding or frame skipping indicated by the temporal_reference in the picture header) and low spatial resolution.

D.4 Data rate control

The number of transmitted bits per unit time, which is selectable in a wide range, may be controlled in two ways, which are both supported by this Specification. A bit_rate description is transmitted with the Sequence Header Code.

For Constant Bitrate (CBR) coding, the number of transmitted bits per unit time is constant on the channel. Since the encoder output rate generally varies depending on the picture content, it shall regulate the rate constant by buffering, etc. In CBR, picture quality may vary depending on its content.

The other mode is the Variable Bitrate (VBR) coding, in which case the number of transmitted bits per unit time may vary on the channel under some constriction. VBR is meant to provide constant quality coding. A model for VBR application is near-constant-quality coding over B-ISDN channels subject to Usage Parameter Control (UPC).

D.5 Low delay mode

A low encoding and decoding delay mode is accommodated for real-time video communications such as visual telephony, video-conferencing, monitoring. Total encoding and decoding delay of less than 150 milliseconds can be achieved for low delay mode operation of this Specification. Setting the low_delay flag in the Sequence Header code defines a low delay bitstream.

The total encoding and decoding delay can be kept low by generating a bitstream which does not contain B-pictures. This prevents frame re-ordering delay. By using dual-prime prediction for coded P-frames, the picture quality can still be high.

A low buffer occupancy for both encoder and decoder is needed for low delay. Large coded pictures should be avoided by the encoder. By using intra update on the basis of one or more slices per frame (intra slices) instead of intra frames this can be accommodated.

In case of exceeding, for low delay operation, the desired number of bits per frame the encoder can skip one or more frames. This action is indicated by a discontinuity in the value of temporal_reference for the next picture (see the semantic definition in 6.3.9) and may cause C.7 of the VBV to apply, i.e. the decoder buffer would underflow if some frames are not repeated by the decoder.

D.6 Random access/channel hopping

The syntax of this Specification supports random access and channel hopping. Sufficient random access/channel hopping functionality is possible by encoding suitable random access points into the bitstream without significant loss of image quality.

Random access is an essential feature for video on a storage medium. It requires that any picture can be accessed and decoded in a limited amount of time. It implies the existence of access points in the bitstream – that is segments of information that are identifiable and can be decoded without reference to other segments of data. In this Specification access points are provided by sequence_header() and this is then followed by intra information (picture data that can be decoded without access to previously decoded pictures). A spacing of two random access points per second can be achieved without significant loss of picture quality.

Channel hopping is the similar situation in transmission applications such as broadcasting. As soon as a new channel has been selected and the bitstream of the selected channel is available to the decoder, the next data entry, i.e. random access point has to be found to start decoding the new program in the manner outlined in the previous paragraph.

D.7 Scalability

The syntax of this Specification supports bitstream scalability. To accommodate the diverse functionality requirements of the applications envisaged by this Specification, a number of bitstream scalability tools have been developed:

- **SNR scalability** mainly targets for applications which require graceful degradation.
- **Chroma simulcast** targets at applications with high chrominance quality requirements.
- **Data partitioning** is primarily targeted for cell loss resilience in ATM networks.
- **Temporal scalability** is a method suitable for interworking of services using high temporal resolution progressive video formats. Also suitable for high quality graceful degradation in the presence of channel errors.
- **Spatial scalability** allows multiresolution coding technique suitable for video service interworking applications. This tool can also provide coding modes to achieve compatibility with existing coding standards, i.e. ISO/IEC 11172-2, at the lower layer.

D.7.1 Use of SNR scalability at a single spatial resolution

The aim of SNR scalability is primarily to provide a mechanism for transmission of a two layer service, these two layers providing the same picture resolution but different quality level. For example, the transmission of service with two different quality levels is expected to become useful in the future for some TV broadcast applications, especially when very good picture quality is needed for large size display receivers. The sequence is encoded into two bitstreams called lower and enhancement layer bitstreams. The lower layer bitstream can be decoded independently from the enhancement layer bitstream. The lower layer, at 3 to 4 Mbit/s, would provide a picture quality equivalent to the current NTSC/PAL/SECAM quality. Then, by using both the lower and the enhancement layer bitstreams, an enhanced decoder can deliver a picture quality subjectively close to the studio quality, with a total bitrate of 7 to 12 Mbit/s.

D.7.1.1 Additional features

D.7.1.1.1 Error resilience

As described in D.13, the SNR scalable scheme can be used as a mechanism for error resilience. If the two layer bitstreams are received with different error rate, the lower layer, better protected, stands as a good substitute to fall back on, if the enhancement layer is damaged.

D.7.1.1.2 Chroma simulcast

The SNR scalable syntax can be used in a chroma simulcast system. The goal of such a scheme would be to provide a mechanism for simultaneous distribution of services with the same luminance resolution but different chrominance sampling format (e.g. 4:2:0 in the lower layer and 4:2:2, when adding the enhancement layer and the simulcast chrominance components) for applications which would require such a feature. The SNR scalable enhancement layer contains some luminance refinement. The 4:2:2 chrominance is sent in simulcast. Only chrominance DC is predicted from the lower layer. The combination of both layer luminance and of the 4:2:2 chrominance constitutes the high quality level.

D.7.1.2 SNR scalable encoding process

D.7.1.2.1 Description

In the lower layer, the encoding is similar to the non scalable situation in terms of decisions, adaptive quantisation, buffer regulation. The intra or error prediction macroblocks are DCT transformed. The coefficients are then quantised using a first rather coarse quantiser. The quantised coefficients are then VLC coded and sent together with the required side information (macroblock_type, motion vectors, coded_block_pattern()).

In parallel, the quantised DCT coefficients coming from the lower layer, are dequantised. The residual error between the coefficients and the dequantised coefficients is then re-quantised, using a second finer quantiser. The resulting refinement coefficients are VLC coded and form the additional enhancement layer, together with a marginal amount of side information (quantiser_scale_code, coded_block_pattern() ...). The non-intra VLC table is used for all the coefficients in the enhancement layer, since it is of differential nature.

D.7.1.2.2 A few important remarks

Since the prediction is the same for both layers, it is recommended to use the refined images in the motion estimation loop (e.g. the images obtained by the conjunction of the lower and the enhancement layer). Thus, there is a drift between the prediction used at the encoder side and what the low level decoder can get as a prediction. This drift does accumulate from P-picture to P-picture and is reset to zero at each I-Picture. However, the drift has been found to have little visual effect when there is an I-picture every 15 pictures or so.

Since the enhancement layer only contains refinement coefficients, the needed overhead is quite reduced: most of the information about the macroblocks (macroblock types, motion vectors ...) are included in the lower layer. Therefore the syntax of this stream is very much simplified:

- the macroblock type table only indicates if the quantiser_scale_code in the enhancement layer has changed and if the macroblock is NOT-CODED (for first and last macroblock of the slices), which amounts to three VLC words.
- quantiser_scale_code in the enhancement layer is sent if the value has changed.
- coded_block_pattern() is transmitted for all coded macroblocks.

All NON-CODED macroblocks that are not at the beginning or end of a slice are skipped, since the overhead information can be deduced from the lower layer.

It is recommended to use different weighting matrices for the lower and the enhancement layer. Some better results are obtained when the first quantisation is steeper than the second one. However, it is recommended not to quantise too coarsely the DCT coefficient that corresponds to the interlace motion, to avoid juddering effects.

D.7.2 Multiple resolution scalability bitstreams using SNR scalability

The aim of resolution scalability is to decode the base layer video suitable for display at reduced spatial resolution. In addition, it is desirable to implement a decoder with reduced complexity for this purpose. This functionality is useful for applications where the receiver display is either not capable or willing to display the full spatial resolution supported by both layers and for applications where software decoding is targeted. The method described in this subclause uses the SNR Scalability syntax outlined in clause 7 to transmit the video in two layers. Note that none of the options suggested in this subclause changes the structure of the highest resolution decoder, which remains identical to the one outlined in Figure 7-14. The bitstream generated on both layers is compatible with the HIGH profile. However, the base layer decoder could be implemented differently with reduced implementation complexity suitable to software decoding.

D.7.2.1 Decoder implementation

In decoding to a smaller spatial resolution, an inverse DCT of reduced size could be used when decoding the base layer. The frame memory requirement in the decoder MC loop would also be reduced accordingly.

If the bitstream of the two SNR Scalability layers was generated with only one MC loop at the encoder the base video will be subject to drift. This drift may or may not be acceptable depending on the application. Image quality will, to a large extent, depend on the sub-sample accuracy used for motion compensation in the decoder. It is possible to use the full precision motion vector as transmitted in the base layer for motion compensation with a sub-sample accuracy comparable to that of the higher layer. Drift can be minimised by using advanced sub-sample interpolation filters (see [12], [13] and [16] in the Bibliography of Annex F).

D.7.2.2 Encoder implementation

It is possible to tailor the base layer SNR Scalability bitstream to the particular requirements of the resolution scaled decoder. A smaller DCT size can be more easily supported by only transmitting the appropriate DCT-coefficients belonging to the appropriate subset in the base layer bitstream.

Finally it is possible to support a drift-free decoding at lower resolution scale by incorporating more than one MC loop in the encoder scheme. An identical reconstruction process is used in the encoder and decoder.

D.7.3 Bitrate allocation in data partitioning

Data partitioning allows splitting a bitstream for increased error resilience when two channels with different error performance are available. It is often required to constrain the bitrate of each partition. This can be achieved at the encoder by adaptively changing priority breakpoint at each slice.

The encoder can use two virtual buffers for the two bitstreams, and implement feedback rate control by picking a priority breakpoint that approximately meets the target rate for each channel. Difference between target and actual rates is used to revise the target for the next frame in a feedback loop.

It is desirable to vary the bitrate split from frame to frame for higher error resilience. Typically, I-pictures benefit from having more of the data in partition 0 than the P-pictures while B-pictures could be placed entirely in partition 1.

D.7.4 Temporal scalability

A two layer temporally scalable coding structure consisting of a base and an enhancement layer is shown in Figure D.1. Consider video input at full temporal rate to temporal demultiplexer; in our example it is temporally demultiplexed to form two video sequences, one input to the base layer encoder and the other input to the enhancement layer encoder. The base layer encoder is a non-hierarchical encoder operating at half temporal rate, the enhancement layer encoder is like a MAIN profile encoder and also operates at half temporal rate except that it uses base layer decoded pictures for motion compensated prediction. The encoded bitstreams of base and enhancement layers are multiplexed as a single stream in the systems multiplexer. The systems demultiplexer extracts two bitstreams and inputs corresponding bitstreams to base and enhancement layer decoders. The output of the base layer decoder can be shown standalone at half temporal rate or after multiplexing with enhancement layer decoded frames and shown at full temporal rate.

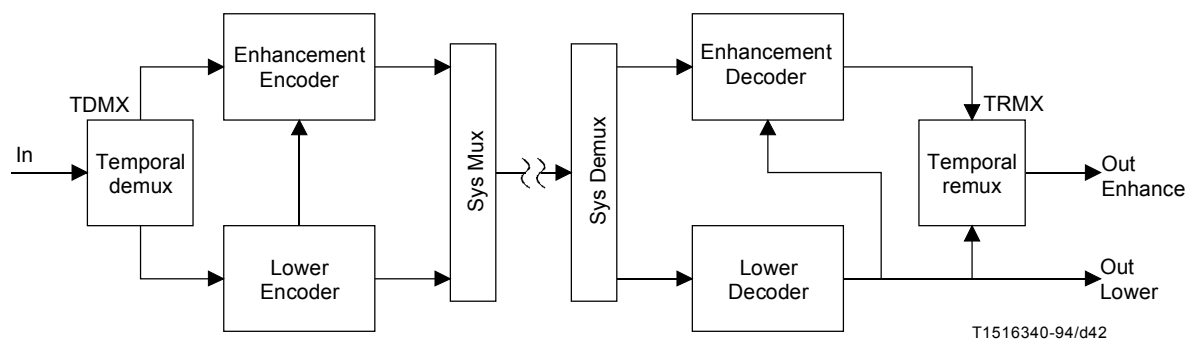

Figure D.1 – A two-layer codec structure for temporal scalability

The following forms of temporal scalability are supported and are expressed as higher layer: base layer-to-enhancement layer picture formats.

- 1) Progressive: progressive-to-progressive Temporal Scalability.
- 2) Progressive: interlace-to-interlace Temporal Scalability.
- 3) Interlace: interlace-to-interlace Temporal Scalability.

D.7.4.1 Progressive – Progressive-to-progressive temporal scalability

Assuming progressive video input, if it is necessary to code progressive-format video in base and enhancement layers, the operation of *temporal demux* may be relatively simple and involve temporal demultiplexing of input frames into two progressive sequences. The operation of *temporal remux* is inverse, i.e. it performs re-multiplexing of two progressive sequences to generate full temporal rate progressive output (see Figure D.2).

D.7.4.2 Progressive – Interlace-to-interlace temporal scalability

Again, assuming full temporal rate progressive video input, if it is necessary to code interlaced format video in base layer, the operation of *temporal demux* may involve progressive to two interlace conversion; this process involves extraction of a normal interlaced- and a complementary interlaced sequence from progressive input video. The operation of *temporal remux* is inverse, i.e. it performs two interlace to progressive conversion to generate full temporal rate progressive output. Figures D.3 and D.4 show operations required in progressive to two interlace and two interlace to progressive conversion.

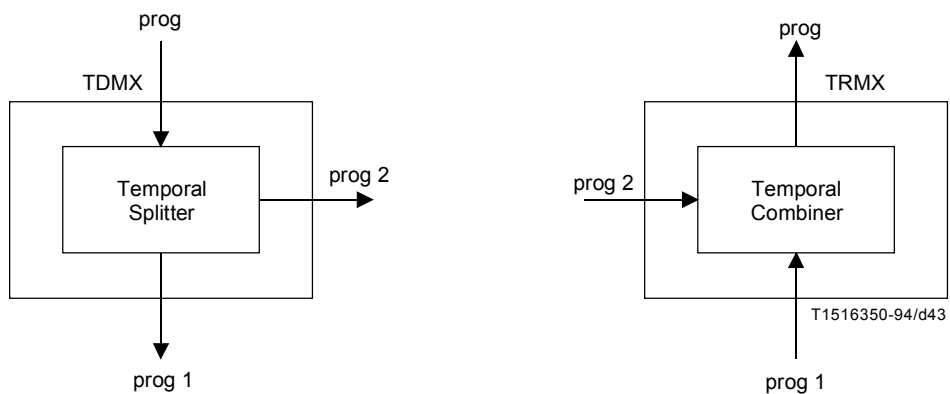

Figure D.2 – Temporal demultiplexer and remultiplexer for progressive – Progressive-to-progressive temporal scalability

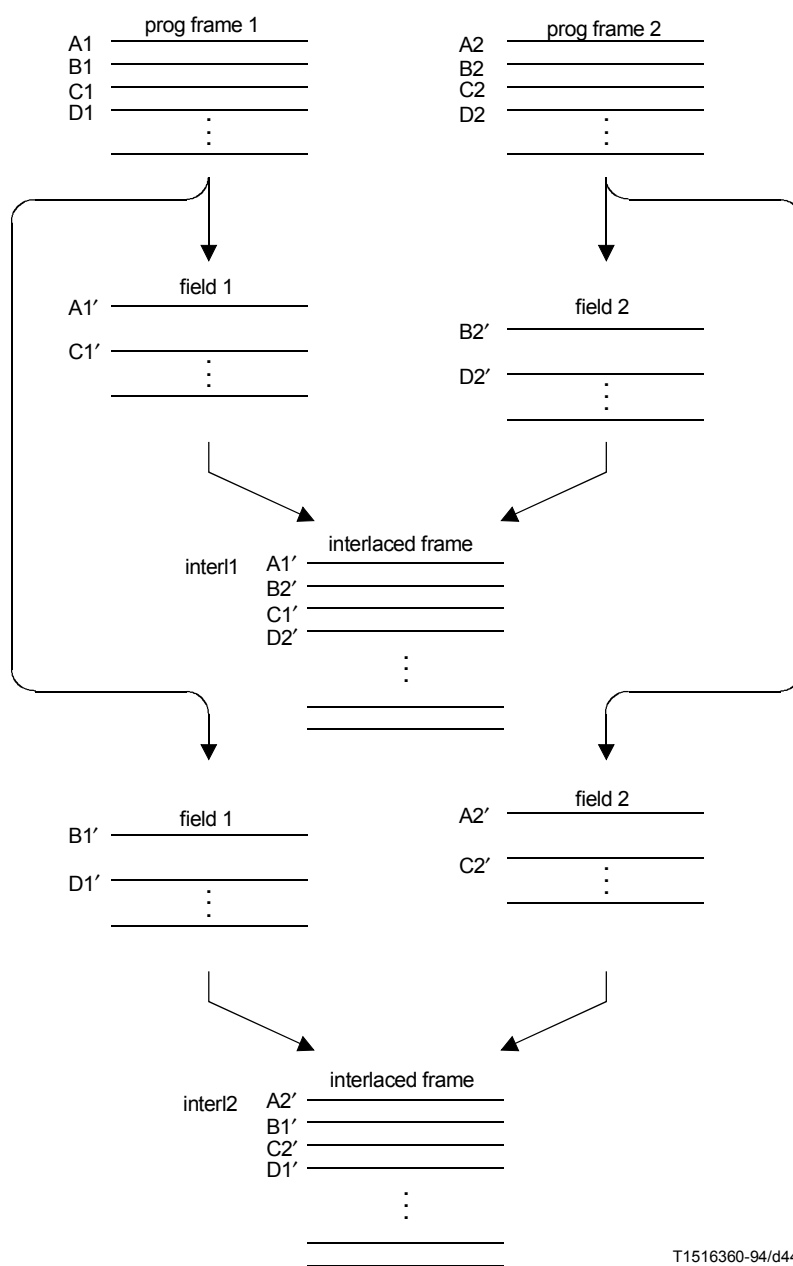

Figure D.3 – Progressive to two-interlace conversion

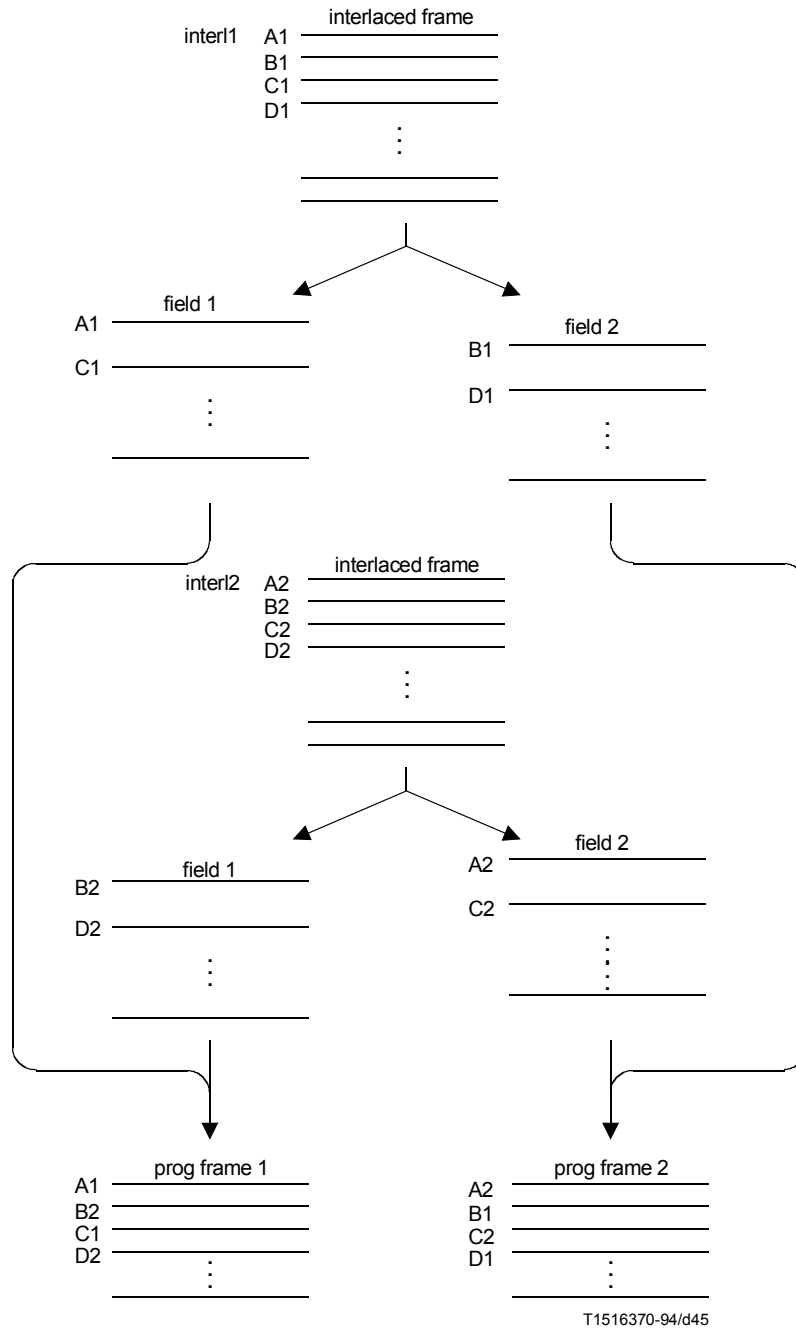

Figure D.4 – Two-interlace to progressive conversion

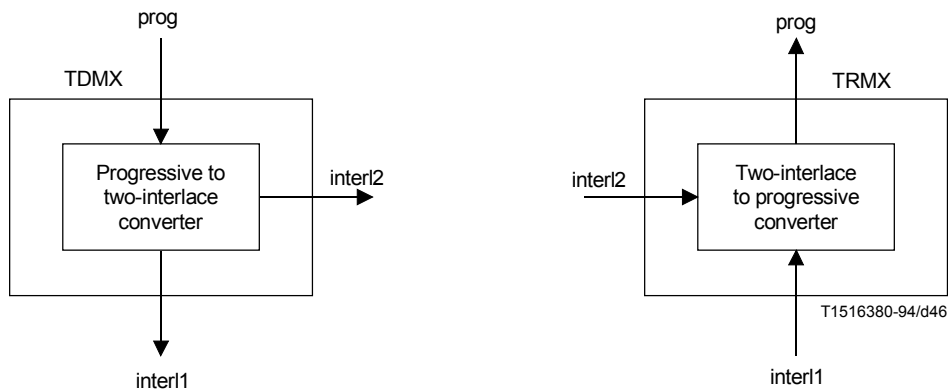

Figure D.5 – Temporal demultiplexer and remultiplexer for progressive – Interface-to-interface temporal scalability

D.7.4.3 Interlace – Interlace-to-interlace temporal scalability

Assuming interlaced video input, if it is necessary to code interlaced- format video in base and enhancement layers, the operation of *temporal demux* may be relatively simple and involve temporal demultiplexing of input frames into two interlaced sequences. The operation of *temporal remux* is inverse, i.e. it performs re-multiplexing of two interlaced sequences to generate full temporal rate interlaced output. The demultiplexing and re-multiplexing is similar to that in Figure D.2.

D.7.5 Hybrids of the spatial, the SNR and the temporal scalable extensions

This Recommendation | International Standard also allows combinations of scalability tools to produce more than 2 video layers as may be useful and practical to support more demanding applications. Taken two at a time, 3 explicit combinations result. Moreover, within each combination, the order in which each scalability is applied, when interchanged, results in distinct applications. In the hybrid scalabilities involving three layers, the layers are referred to as base layer, enhancement layer 1 and enhancement layer 2.

D.7.5.1 Spatial and SNR hybrid scalability applications

a) *HDTV with standard TV at two qualities:*

Base layer provides standard TV resolution at basic quality, enhancement layer 1 helps generate standard TV resolution but at higher quality by SNR scalability and the enhancement layer 2 employs HDTV resolution and format which is coded with spatial scalability with respect to high quality standard TV resolution generated by using enhancement layer 1.

b) *Standard TV at two qualities and low definition TV/videophone:*

Base layer provides videophone/low definition quality, using spatial scalability enhancement layer 1 provides standard TV resolution at a basic quality and enhancement layer 2 uses SNR scalability to help generate high quality standard TV.

c) *HDTV at two qualities and standard TV:*

Base layer provides standard TV resolution, using spatial scalability enhancement layer 1 provides basic quality HDTV and enhancement layer 2 uses SNR scalability to help generate high quality HDTV.

D.7.5.2 Spatial and temporal hybrid scalability applications

a) *High temporal resolution progressive HDTV with basic interlaced HDTV and standard TV:*

Base layer provides standard TV resolution, using spatial scalability enhancement layer 1 provides basic HDTV of interlaced format and enhancement layer 2 uses temporal scalability to help generate full temporal resolution progressive HDTV.

b) *High resolution progressive HDTV with enhanced progressive HDTV and basic progressive HDTV:*

Base layer provides basic progressive HDTV format at temporal resolution, using temporal scalability enhancement layer 1 helps generate progressive HDTV at full temporal resolution and enhancement layer 2 uses spatial scalability to provide high spatial resolution progressive HDTV (at full temporal resolution).

- c) *High resolution progressive HDTV with enhanced progressive HDTV and basic interlaced HDTV:*

Base layer provides basic interlaced HDTV format, using temporal scalability enhancement layer 1 helps generate progressive HDTV at full temporal resolution and enhancement layer 2 uses spatial scalability to provide high spatial resolution progressive HDTV (at full temporal resolution).

D.7.5.3 Temporal and SNR hybrid scalability applications

- a) *Enhanced progressive HDTV with basic progressive HDTV at two qualities:*

Base layer provides basic progressive HDTV at lower temporal rate, using temporal scalability enhancement layer 1 helps generate progressive HDTV at full temporal rate but with basic quality and enhancement layer 2 uses SNR scalability to help generate progressive HDTV with high quality (at full temporal resolution).

- b) *Enhanced progressive HDTV with basic interlaced HDTV at two qualities:*

Base layer provides interlaced HDTV of basic quality, using SNR scalability enhancement layer 1 helps generate interlaced HDTV at high quality and enhancement layer 2 uses temporal scalability to help generate progressive HDTV at full temporal resolution (at high quality).

D.8 Compatibility

This Recommendation | International Standard supports compatibility between different resolution formats as well as compatibility with ISO/IEC 11172-2 (and Recommendation H.261).

D.8.1 Compatibility with higher and lower resolution formats

This Specification supports compatibility between different resolution video formats. Compatibility is provided for spatial and temporal resolutions with the Spatial Scalability and Temporal Scalability tools. The video is encoded into two resolution layers. A decoder only capable or willing to display a lower resolution video accepts and decodes the lower layer bitstream. The full resolution video can be reconstructed by accepting and decoding both resolution layers provided.

D.8.2 Compatibility with ISO/IEC 11172-2 (and Recommendation H.261)

The syntax of this Specification supports both backward and forward compatibility with ISO/IEC 11172-2. Forward compatibility with ISO/IEC 11172-2 is provided since the syntax of this Specification is a superset of the ISO/IEC 11172-2 syntax. The Spatial Scalability tool provided by this Specification allows using ISO/IEC 11172-2 coding in the lower resolution, i.e. base layer, thus achieving backward compatibility.

The video syntax contains tools that are needed to implement H.261 compatibility that may be needed for possible future use, however, this is currently not supported by any profile.

Simulcast serves as a simple alternative method to provide backward compatibility with both Recommendation H.261 and ISO/IEC 11172-2.

D.9 Differences between this Specification and ISO/IEC 11172-2

This subclause lists the differences between MPEG-1 Video and MPEG-2 Video.

All MPEG-2 Video decoders that comply with currently defined profiles and levels are required to decode MPEG-1 constrained bitstreams.

In most instances, MPEG-2 represents a super-set of MPEG-1. For example, the MPEG-1 coefficient zigzag scanning order is one of the two coefficient scanning modes of MPEG-2. However, in some cases, there are syntax elements (or semantics) of MPEG-1 that does not have a direct equivalent in MPEG-2. This Specification lists all those elements.

This Specification may help implementers identify those elements of the MPEG-1 video syntax (or semantics) that do not have their direct equivalent in MPEG-2, and therefore require a special care in order to have guarantee MPEG-1 compatibility.

In this subclause, MPEG-1 refers to ISO/IEC 11172-2 whilst MPEG-2 refers to this Specification.

D.9.1 IDCT mismatch

MPEG-1 – The IDCT mismatch control consists in adding (or removing) one to each non-zero coefficient that would have been even after inverse quantisation. This is described as part of the inverse quantisation process, in 2.4.4.1, 2.4.4.2 and 2.4.4.3 of ISO/IEC 11172-2 (MPEG-1).

ISO/IEC 13818-2 : 2000 (E)

MPEG-2 – The IDCT mismatch control consists in adding (or removing) one to coefficient [7] [7] if the sum of all coefficients is even after inverse quantisation. This is described in 7.4.4 of MPEG-2.

D.9.2 Macroblock stuffing

MPEG-1 – The VLC code '0000 0001 111' (`macroblock_stuffing`) can be inserted any number of times before each `macroblock_address_increment`. This code must be discarded by the decoder. This is described in 2.4.2.7 of MPEG-1.

MPEG-2 – This VLC code is reserved and not used in MPEG-2. In MPEG-2, stuffing can be generated only by inserting zero bytes before a start-code. This is described in 5.2.3 of MPEG-2.

D.9.3 Run-level escape syntax

MPEG-1 – Run-level values that cannot be coded with a VLC are coded by the escape code '0000 01' followed by either a 14-bit FLC ($-127 \leq \text{level} \leq 127$), or a 22-bit FLC ($-255 \leq \text{level} \leq 255$). This is described in Annex B, 2-B5 of MPEG-1.

MPEG-2 – Run-level values that cannot be coded with a VLC are coded by the escape code '0000 01' followed by a 18-bit FLC ($-2047 \leq \text{level} \leq 2047$). This is described in 7.2.2.3 of MPEG-2.

D.9.4 Chrominance samples horizontal position

MPEG-1 – The horizontal position of chrominance samples is half the way between luminance samples. This is described in 2.4.1 of MPEG-1.

MPEG-2 – The horizontal position of chrominance samples is co-located with luminance samples. This is described in 6.1.1.8 of MPEG-2.

D.9.5 Slices

MPEG-1 – Slices do not have to start and end on the same horizontal row of macroblocks. Consequently it is possible to have all the macroblocks of a picture in a single slice. This is described in 2.4.1 of MPEG-1.

MPEG-2 – Slices always start and end on the same horizontal row of macroblocks. This is described in 6.1.2 of MPEG-2.

D.9.6 D-Pictures

MPEG-1 – A special syntax is defined for D-pictures (`picture_coding_type = 4`). D-pictures are like I-pictures with only Intra-DC coefficients, no End of Block, and a special `end_of_macroblock` code '1'.

MPEG-2 – D-pictures (`picture_coding_type = 4`) are not permitted. This is described in 6.3.9 of MPEG-2.

D.9.7 Full-pel motion vectors

MPEG-1 – The syntax elements `full_pel_forward_vector` and `full_pel_backward_vector` can be set to '1'. When this is the case, the motion vectors that are coded are in integer-sample units instead of half-sample units. Motion vector coordinates must be multiplied by two before being used for the prediction. This is described in 2.4.4.2 and 2.4.4.3 of MPEG-1.

MPEG-2 – The syntax elements `full_pel_forward_vector` and `full_pel_backward_vector` must be equal to '0'. Motion vectors are always coded in half-sample units.

D.9.8 Aspect ratio information

MPEG-1 – The 4-bit `pel_aspect_ratio` value coded in the sequence header specifies the sample aspect ratio. This is described in 2.4.3.2 of MPEG-1.

MPEG-2 – The 4-bit `aspect_ratio_information` value coded in the sequence header specifies the display aspect ratio. The sample aspect ratio is derived from this and from the frame size and display size. This is described in 6.3.3 of MPEG-2.

D.9.9 forward_f_code and backward_f_code

MPEG-1 – The `f_code` values used for decoding the motion vectors are `forward_f_code` and `backward_f_code`, located in the `picture_header()`.

MPEG-2 – The `f_code` values used for decoding the motion vectors are `f_code[s][t]`, located in the `picture_coding_extension()`. The values of `forward_f_code` and `backward_f_code` must be '111' and are ignored. This is described in 6.3.9 of MPEG-2.

D.9.10 constrained_parameter_flag and maximum_horizontal_size

MPEG-1 – When the `constrained_parameter_flag` is set to '1', this indicates that a certain number of constraints are verified. One of those constraints is that `horizontal_size` \leq 768. It should be noted that a constrained MPEG-1 video bitstream can have pictures with an horizontal size of up to 768 luminance samples. This is described in 2.4.3.2 of MPEG-1.

MPEG-2 – The `constrained_parameter_flag` mechanism has been replaced by the profile and level mechanism. However, it should be noted that MP @ ML bitstreams cannot have horizontal size larger than 720 luminance samples. This is described in 8.2.3.1 of MPEG-2.

D.9.11 Bit_rate and vbv_delay

MPEG-1 – `Bit_rate` and `vbv_delay` are set to 3FFFF and FFFF (hex) respectively to indicate variable bitrate. Other values are for constant bitrate.

MPEG-2 – The semantics for `bit_rate` are changed. In variable bitrate operation, `vbv_delay` may be set to FFFF (hex), but a different value does not necessarily mean that the bitrate is constant. Constant bitrate operation is simply a special case of variable bitrate operation. There is no way to tell that a bitstream is constant bitrate without examining all of the `vbv_delay` values and making complicated computations.

Even if the bitrate is constant the value of `bit_rate` may not be the actual bitrate since `bit_rate` need only be an upper bound to the actual bitrate.

D.9.12 VBV

MPEG-1 – VBV is only defined for constant bitrate operation. The STD supersedes the VBV model for variable bitrate operation.

MPEG-2 – VBV is only defined for variable bitrate operation. Constant bitrate operation is viewed as a special case of variable bitrate operation.

D.9.13 temporal_reference

MPEG-1 – `Temporal_reference` is incremented by one modulo 1024 for each coded picture, and reset to zero at each group of pictures header.

MPEG-2 – If there are no big pictures, `temporal_reference` is incremented by one modulo 1024 for each coded picture, and reset to zero at each group of pictures header (as in MPEG-1). If there are big pictures (in low delay bitstreams), then `temporal_reference` follows different rules.

D.9.14 MPEG-2 syntax versus MPEG-1 syntax

It is possible to make MPEG-2 bitstreams that have a syntax very close to MPEG-1, by using particular values for the various MPEG-2 syntax elements that do not exist in the MPEG-1 syntax.

In other words, the MPEG-1 decoding process is the same (except for the particular points mentioned earlier) as the MPEG-2 decoding process when :

```

progressive_sequence = '1' (progressive sequence)
chroma_format = '01' (4:2:0)
frame_rate_extension_n = 0 and frame_rate_extension_d = 0 (MPEG-1 frame-rate)
intra_dc_precision = '00' (8-bit Intra-DC precision)
picture_structure = '11' (frame-picture, because progressive_sequence = '1')
frame_pred_frame_dct = 1 (only frame-based prediction and frame DCT)
concealment_motion_vectors = '0' (no concealment motion vectors)
q_scale_type = '0' (linear quantiser_scale)
intra_vlc_format = '0' (MPEG-1 VLC table for Intra MBs)
alternate_scan = '0' (MPEG-1 zigzag scanning order)
repeat_first_field = '0' (because progressive_sequence = '1')
chroma_420_type = '1' (chrominance is "frame-based", because
progressive_sequence = '1')
progressive_frame = '1' (because progressive_sequence = '1')

```

D.10 Complexity

The MPEG-2 Standard supports combinations of high performance/high complexity and low performance/low complexity decoders. This is accommodated by MPEG-2 with the Profiles and Levels definitions which introduce new sets of tool and functionality with every new profile. It is thus possible to trade-off performance of the MPEG-2 coding schemes by decreasing implementation complexity.

Moreover, certain restrictions could allow reducing decoder implementation cost.

D.11 Editing encoded bitstreams

Many operations on the encoded bitstream are supported to avoid the expense and quality costs of re-coding. Editing, and concatenation of encoded bitstreams with no re-coding and no disruption of the decoded image sequence is possible.

There is a conflict between the requirement for high compression and easy editing. The coding structure and syntax have not been designed with the primary aim of simplifying editing at any picture. Nevertheless, a number of features have been included that enable editing of coded data.

Editing of encoded MPEG-2 bitstreams is supported due to the syntactic hierarchy of the encoded video bitstream. Unique start codes are encoded with different level in the hierarchy (i.e. video sequence, group of pictures, etc.). Video can be encoded with Intra-picture/intra-slices access points in the bitstream. This enables the identification, access and editing of parts of the bitstream without the necessity to decode the entire video.

D.12 Trick modes

Certain Digital Storage Media (DSM) provide the capability of trick modes, such as Fast Forward/Fast Reverse (FF/FR). The MPEG-2 syntax supports all special access, search and scan modes of ISO/IEC 11172-2. This functionality is supported with the syntactic hierarchy of the video bitstream which enables the identification of relevant parts within a video sequence. It can be assisted by MPEG-2 tools which provide bitstream scalability to limit the access bitrate (i.e. Data Partitioning and the general slice structure). This subclause provides some guideline for decoding a bitstream provided by a DSM.

The decoder is informed by means of a 1-bit flag (`DSM_trick_mode_flag`) in the PES packet header. This flag indicates that the bitstream is reconstructed by DSM in trick mode, and the bitstream is valid from syntax point of view, but invalid from semantics point of view. When this bit is set, an 8-bit field (`DSM_trick_modes`) follows. The semantics of `DSM_trick_modes` are in the ITU-T Rec. H.220.0 | ISO/IEC 13818-1.

D.12.1 Decoder

While the decoder is decoding PES Packet whose `DSM_trick_mode_flag` is set to 1, the decoder is recommended to:

- Decode bitstream and display according to `DSM_trick_modes`.

Pre-processing

When the decoder encounters PES Packet whose `DSM_trick_mode_flag` is set to 1, the decoder is recommended to:

- Clear non trick mode bitstream from buffer.

Post-processing

When the decoder encounters PES Packet whose `DSM_trick_mode_flag` is set to 0, the decoder is recommended to:

- Clear trick mode bitstream from buffer.

Video Part

While the decoder is decoding PES Packet whose `DSM_trick_mode_flag` is set to 1, the decoder is recommended to:

- Neglect `vbv_delay` and `temporal_reference` value.
- Decode one picture and display it until next picture is decoded.

The bitstream in trick mode may have a gap between slices. When the decoder encounters a gap between slices, the decoder is recommended to:

- Decode the slice and display it according to the slice vertical position in slice header.
- Fill up the gap with co-sited part of the last displayed picture.

D.12.2 Encoder

The encoder is recommended to:

- Encode with short size of slice with intra macroblocks.
- Encode with short periodic refreshment by intra picture or intra slice.

DSM

DSM is recommended to provide the bitstream in trick mode with perfect syntax.

Pre-processing

DSM is recommended to:

- Complete "normal" bitstream at picture_header() and higher syntactic structures.

System Part

DSM is recommended to:

- Set DSM_trick_mode_flag to 1 in a PES Packet header.
- Set DSM_trick_modes(8-bit) according to the trick mode.

Video Part

DSM is recommended to:

- Insert a sequence_header() with the same parameters as a normal bitstream.
- Insert a sequence_extension() with the same parameters as a normal bitstream.
- Insert a picture_header() with the same parameters as a normal bitstream except that it may be preferable to indicate variable bit rate operation. One way to achieve this is to set vbv_delay to FFFF (hex).
 - NOTE – In most cases temporal_reference and vbv_delay are ignored in a decoder, therefore the DSM may not need to set temporal_reference and vbv_delay to correct values.
- Concatenate slices which consists of intra coded macroblocks. The concatenated slices should have slice vertical positions in increasing order.

D.13 Error resilience

Most digital storage media and communication channels are not error-free. Appropriate channel coding schemes should be used and are beyond the scope of this Specification. Nevertheless the MPEG-2 syntax supports error resilient modes relevant to cell loss in ATM networks and bit errors (isolated and in bursts) in transmissions. The slice structure of the compression scheme defined in this Specification allows a decoder to recover after a residual data error and to re-synchronise its decoding. Therefore, bit errors in the coded data will cause errors in the decoded pictures to be limited in area. Decoders may be able to use concealment strategies to disguise these errors. Error resilience includes graceful degradation in proportion to bit error rate (BER) and graceful recovery in the face of missing video bits or data packets. It has to be noted that all items may require additional support at the system level.

Being an example of a packet-based system, B-ISDN with its Asynchronous Transfer Mode (ATM) is addressed in some detail in the following. Similar statements can be made for other systems where certain packets of data are protected individually by means of forward error-correcting coding.

ATM uses short, fixed length packets, called cells, consisting of a 5 byte header containing routing information, and a user payload of 48 bytes. The nature of errors on ATM is such that some cells may be lost, and the user payload of some cells may contain bit errors. Depending on AAL (ATM Adaptation layer) functionality, indications of lost cells and cells containing bit errors may be available.

As an indication of the impact of cell loss in an ATM environment Table D.2 summarises the average interval between cell losses for a range of CLR and service bitrates based on simple statistical modelling. (A cell payload must be assumed for this. Allowing 1 byte/cell for AAL functions leaves 376 bits = 47 bytes). Note, however, that this summary ignores cell loss bursts and other shorter term temporal statistics.

Bit Error Ratios (BER) corresponding to the above mean times between errors can be calculated easily for the case of isolated bit errors. The BER that would cause the same incidence rate of errors is found by dividing by the cell payload size, i.e. $BER = CLR/376$.

Table D.2 – Average interval between cell losses for a range of CLR and service bitrates

	Average interval time of error			
	5 Mbit/s	10 Mbit/s	50 Mbit/s	100 Mbit/s
10^{-2}	7,52 ms	3,76 ms	0,752 ms	0,376 ms
10^{-3}	75,2 ms	37,6 ms	7,52 ms	3,76 ms
10^{-4}	752 ms	376 ms	75,2 ms	37,6 ms
10^{-5}	7,52 s	3,76 s	752 ms	376 ms
10^{-6}	1,25 m	37,6 s	7,52 s	3,76 s
10^{-7}	12,5 m	6,27 m	1,25 m	37,6 s
10^{-8}	2,09 h	1,04 h	12,5 m	6,27 m

The following techniques of minimising the impact of lost cells and other error/loss effects are provided for reference, and indicate example methods of using the various tools available in this Specification to provide good performance in the presence of those errors. Note that the techniques described may be applicable in the cases of packets of other sizes (e.g. LANs or certain storage media) or video data with uncorrected errors of different characteristics, in addition to cell loss. It may be appropriate to treat a known erasure [uncorrected bit error(s) known to exist somewhere in a data block] as a lost data block, since the impact of bit errors cannot be predicted. However, this should be a decoder option. The discussion that follows refers generally to "transport packets" where appropriate, to emphasise the applicability to a variety of transport and storage systems. However, specific examples will refer to Cell Loss Ratios (CLR) because cell transport is the most completely defined at the time of preparing this Specification.

The error resilience techniques are summarised in three categories, covering methods of concealing the error once it has occurred, and the restriction of the influence of a loss or error in both space (within a picture) and time (from picture to picture).

D.13.1 Concealment possibilities

Concealment techniques hide the effect of losses/errors once they have occurred. Some concealment methods can be implemented using any encoded bitstream, while others are reliant on the encoder to structure the data or provide additional information to enable enhanced performance.

D.13.1.1 Temporal predictive concealment

A decoder can provide concealment of the errors by estimating the lost data from spatio-temporally adjacent data. The decoder uses information which has been successfully received to make an informed estimate of what should be displayed in place of the lost/errored data, under the assumption that the picture characteristics are fairly similar across adjacent blocks (in both the spatial and temporal dimensions). In the temporal case, this means estimation of errored or lost data from nearby fields or frames.

D.13.1.1.1 Substitution from previous frame

The simplest possible approach is to replace a lost macroblock with the macroblock in the same location in the previous picture. This approach is suitable for relatively static picture areas but block displacement is noticeable for moving areas.

The "previous picture" must be interpreted with care due to the use of bi-directional prediction and a difference between picture coded order and picture display order. When a macroblock is lost in a P- or I-picture, it can be concealed by copying the data corresponding to the same macroblock in the previous P-picture or I-picture. This ensures that the picture is complete before it is used for further prediction. Lost macroblocks in B-pictures can be substituted from the last displayed picture, of any type, or from a future I- or P-picture held in memory but not yet displayed.

D.13.1.1.2 Motion compensated concealment

The concealment from neighbouring pictures can be improved by estimating the motion vectors for the lost macroblock, based on the motion vectors of neighbouring macroblocks in the affected picture (provided these are not also lost). This improves the concealment in moving picture areas, but there is an obvious problem with errors in macroblocks whose neighbouring macroblocks are coded intra, because there are ordinarily no motion vectors. Encoder assistance to get around this problem is discussed in D.13.1.1.3.

Sophisticated motion vector estimation might involve storage of adjacent macroblock motion vectors from above and below the lost macroblock, for predictions both forward and backward (for B-pictures) in time. The motion vectors from above and below (if available) could then be averaged.

Less complex decoders could use, for example, only forward prediction and/or only the motion vector from the macroblock above the lost macroblock. This would save on storage and interpolation.

D.13.1.1.3 Use of Intra MVs

The motion compensated concealment technique outlined in D.13.1.1.2 could not ordinarily be applied when the macroblocks above and below the lost/errored macroblock are Intra-coded, since there is no motion vector associated with Intra-coded macroblocks. In particular, in I-pictures, this type of concealment would not be possible with the normal calculation and use of motion vectors.

The encoding process can be extended to include motion vectors for intra macroblocks. Of course, the motion vector and coded information for a particular macroblock must be transmitted separately (e.g. in different packets) so that the motion vector is still available in the event that the image data is lost.

When "concealment_motion_vectors" = 1, motion vectors are transmitted with Intra macroblocks, allowing improved concealment performance of the decoders. The concealment motion vector associated with an Intra-coded macroblock is intended to be used only for concealment (if necessary) of the macroblock located immediately below the Intra-coded macroblock.

For simplicity, concealment motion vectors associated with Intra-coded macroblocks are always forward, and are considered as frame motion-vectors in Frame pictures and field motion-vectors in field pictures.

Therefore, encoders that choose to generate concealment motion vectors should transmit, for a given Intra-coded macroblock, the frame- or field-motion vector that should be used to conceal (i.e. to predict, with forward frame- or field-based prediction respectively) the macroblock located immediately below the Intra-coded macroblock.

Concealment motion vectors are intended primarily for I- and P-pictures, but the syntax allows their use in B-pictures. Concealment in B-pictures is not critical, since B-pictures are not used as predictors and so errors do not propagate to other pictures. Therefore, it may be wasteful to transmit concealment motion vectors in B-pictures.

Concealment motion vectors transmitted with Intra macroblocks located in the bottom row of a picture cannot be used for concealment. However, if "concealment_motion_vectors" = 1, those concealment motion vectors must be transmitted. Encoders can use the (0, 0) motion vector to minimise the coding overhead.

When concealment motion vectors are used, it is a good idea to have one slice contain one row of macroblocks (or smaller), so that concealment can be limited to less than one row of macroblocks when a slice, or part of a slice, is lost. This means that the loss of macroblocks in two successive rows is much less likely, and therefore the chances of achieving effective concealment using concealment motion vectors is improved.

NOTE – When "concealment_motion_vectors" = 1, Predictors for Motion Vectors (PMV) are NOT reset when an Intra macroblock is transmitted. Ordinarily, an Intra macroblock would reset the PMVs.

D.13.1.2 Spatial predictive concealment

The generation of predicted, concealment macroblocks is also possible by interpolation from neighbouring macroblocks within the one picture (see Annex F, Bibliography, reference [17]). This is best suited to areas of high motion, where temporal prediction is not successful, or as an alternative means of concealment for Intra macroblocks when concealment motion vectors (see D.13.1.1.3) are not available. It also could be particularly useful for cell loss after scene changes.

There are several possible approaches to spatial interpolation, and it could be carried out in the spatial or DCT domain, but normally it is only feasible and useful to predict the broad features of a lost macroblock, such as the DC coefficient and perhaps the lowest AC coefficients. Spatial prediction of fine detail (high frequencies) is likely to be unsuccessful and is of little value in fast-moving pictures anyway.

Spatial predictive macroblock concealment may also be useful in combination with layered coding methods (i.e. Data Partitioning or SNR scalability, see D.13.1.3). If in the event of cell loss some DCT coefficients in a macroblock are recovered from the lower layer, it is possible to use all information available (DCT coefficients recovered in the same macroblock from the lower layer and all DCT coefficients received in the adjacent macroblocks) for error concealment. This is especially useful if the lower layer only contains DC coefficients due to bandwidth constraints.

D.13.1.3 Layered coding to facilitate concealment

It is possible to assist the concealment process further by arranging the coded video information such that the most important information is most likely to be received. The loss of the less important information can then be more effectively concealed. This approach can gain from use of a transmission medium or storage device with different priority levels (such as priority-controlled cell-based transmission in the B-ISDN, or where different error protection or correction is provided on different channels). The components produced by the coding process can be placed in a hierarchy of importance according to the effect of loss on the reconstructed image. By indicating the priority of bitstream components and treating the individual components with due importance, superior error concealment performance may be possible.

Strategies available for producing hierarchically ordered bitstreams, or layers, include:

- **Data partitioning** – The coded macroblock data is partitioned into multiple layers such that partition zero contains address and control information and lower order DCT coefficients, while partition one contains high frequency DCT coefficients.
- **SNR scalability** – Two sets of coefficients are dequantised and then added together at the receiver before decoding. One set of coefficients could be a refinement of the quantisation error of the other, but other combinations (including an emulation of data partitioning) are possible.
- **Spatial scalability** – The lower layer may be coded without regard for the enhancement layer, and could use other standard coding methods (ISO/IEC 11172-2, etc.). The enhancement layer contains the coded prediction error from a prediction based on the lower layer.
- **Temporal scalability** – The enhancement layer defines additional pictures which, when re-multiplexed with the base layer, provides a combined picture sequence of greater picture rate.

These strategies produce layers which, when added progressively, produce increasing quality of the reconstructed sequence. While some of these source coding techniques may result in a bitrate increase compared to the system without layering, the performance of the layered systems, when subjected to channel errors, may be greater.

Considering error resilience alone, the hierarchically ordered layers should be handled with due quality, such that some function (such as picture quality for a given total bitrate) is optimised. The bitstream components may be treated differently at one or more of the following locations:

- *Encoder* – Different channel coding might be used.
- *Channel* – The channel may be able to provide different cell/packet loss probabilities or error characteristics to the different bitstream components.
- *Decoder* – Error concealment could be performed differently within each bitstream.

D.13.1.3.1 Use of data partitioning

Data partitioning allows a straightforward division of macroblock data into two layers. The Priority Break Point (PBP) pointer determines the contents of each layer. Ordinarily, data partition 0 contains the address and control information and the low frequency DCT coefficients, while data partition 1 contains the high frequency DCT coefficients.

At the encoder the value of the PBP pointer may be different for each slice such that the distribution of bits between the two layers may be controlled (e.g. maintained constant). The distribution may be different for I-, P-, and B-frames. The management of rate between the layers could mean that, for some macroblocks, data partition 0 contains no DCT coefficients or motion vectors.

Good tolerance to errors can be achieved if channel errors are distributed so that data partition 1 receives most errors.

It is assumed that errors can be detected at the decoder, so that actions can be taken to prevent errored data from being displayed. For data partition 1, errored data is simply not displayed (i.e. only data partition 0 is used). Losses or errors in data partition 0 should be minimised through use of high reliability transport. Decoder concealment actions may also be necessary.

D.13.1.3.2 Use of SNR scalable coding

SNR scalable coding provides two layers with the same spatial resolution but different image quality, depending on whether one or both layers are decoded. This technique is mainly intended to provide a lower-quality layer that is usable even when the enhancement layer is absent. However, it also provides good error resilience if the errors can be mainly confined to the enhancement layer.

In case of errors in the enhancement layer, the lower layer can be used alone for the affected image area. Especially in the case of frequent errors, temporary loss or permanent unavailability of the enhancement layer this concealment is very effective, since the displayed signal can be made relatively free of non-linear distortions like blocking or motion jerkiness.

If the enhancement layer is permanently unavailable and so only the lower layer is decoded, a small drift may occur in the case where only one MC prediction loop is implemented in the encoder. However, this drift is likely to be invisible in most configurations (e.g. $M = 3$, $N = 12$ would normally provide correction often enough).

The lower-layer of an SNR Scalable system is well suited to concealment in the case of a very high error rate, temporary or permanent loss of the enhancement-layer signal. However, the enhancement-layer quality in the error-free case does not achieve that of a sub-band like layered scheme (e.g. data partitioning).

D.13.1.3.3 Use of spatial scalable coding

Spatial scalable coding allows the lower layer to be coded without regard for the enhancement layer, and other standard coding methods (ISO/IEC 11172-2, etc.) could be used. The enhancement layer contains the coded prediction error from a prediction based on the lower layer. In case of errors in the enhancement layer, the upconverted lower layer can be used directly as concealment information for the affected image area. Especially in case of frequent errors or temporary loss of the enhancement layer, this concealment data is relatively free of non-linear distortions like blocking (which could arise if high frequency DCT coefficients are completely absent from the lower layer) or motion jerkiness (if the motion information is omitted from the high priority layer).

In the error-free case the upconverted lower layer is used as an additional source of predictions in a macroblock-adaptive way to improve the enhancement-layer coding performance. The enhancement layer bitstream therefore consists of the quantised temporal or lower layer prediction errors.

Spatial scalable coding provides a lower layer that is very suitable for concealment in case of a high error rate or temporary loss of the enhancement layer. However, the quality of the enhanced picture when both layers are available will not, in general, be as good as other layered coding approaches.

D.13.1.3.4 Use of temporal scalable coding

Temporal scalability is a coding technique that allows layering of video frames. The spatial resolution of frames in each layer is the same but the temporal rates of each layer are lower than that of the source; however the combined temporal rate of the two layers results in full temporal rate of the source. In case of errors in the enhancement layer, the base layer of full spatial resolution can be easily used for concealment. Especially in case of frequent errors or temporary loss of the enhancement layer, the base layer offers good concealment properties.

In some telecommunications applications a high degree of error resilience might be achieved with temporal scalability by encoding the base layer using the same spatial resolution but only half the temporal resolution of the source; the remaining frames corresponding to the other half of the temporal resolution are coded in the enhancement layer. Typically, the enhancement layer data may be assigned lower priority and when lost, the base layer decoded frames can be used for concealment by frame repetition. This type of concealment leads to only a temporary loss of full temporal resolution while maintaining full spatial quality and full spatial resolution.

In HDTV applications such as those using high temporal resolution progressive video format as source, high degree of error resilience can be achieved with temporal scalability. Such an application is envisaged to require 2 layers, a base layer and an enhancement layer, each of which process same picture formats (either both progressive or both interlaced) but at half the temporal rates. Temporal re-multiplexing of the base and enhancement layers irrespective of their chosen formats always results in full progressive temporal resolution of the source. In HDTV transmission, if the lower priority enhancement layer is corrupted, the base layer can be used for concealment, either directly, as in case of progressive format base layer or after reversal of parity of fields for interlaced format base layer.

Typically, the enhancement layer data may be assigned lower priority and when lost, the base layer decoded frames can be used for concealment by either frame repetition or frame averaging. This type of concealment leads to only a temporary indistinguishable loss in temporal resolution while maintaining full spatial quality and full spatial resolution.

D.13.2 Spatial localisation

Spatial localisation encompasses those methods aimed at minimising the extent to which errors propagate within a picture, by providing early resynchronisation of the elements in the bitstream that are coded differentially between macroblocks.

Isolated bit errors may be detected through invalid codewords and so a decoder designer may choose to allow an errored sequence to be decoded. However, the effect on the picture is difficult to predict (legal, but incorrect, codewords could be generated) and it may be preferable to control the error through concealment of the entire affected slice(s) even when only one bit is known to be in error somewhere in a block of data.

When long consecutive errors occur (e.g. packet or cell loss), virtually the only option is to discard data until the next resynchronisation point is located (a start code at the next slice or picture header). By providing more resynchronisation points, the area of the screen affected by a loss or error can be reduced, in turn reducing the demands on the concealment techniques and making the errors less visible at the expense of coding efficiency. Spatial localisation of errors is therefore dependent on controlling the slice size since this is the smallest coded unit with resynchronisation points (start codes).

D.13.2.1 Small slices

The most basic method for achieving spatial localisation of errors is to reduce the (fixed) number of macroblocks in a slice. The increased frequency of resynchronisation points will reduce the affected picture area in the event of a loss. It is effective in any transport or storage media, and in any profile since the slice structure is always present in MPEG coded video.

The method results in a small loss of coding efficiency due to the increase of overhead information. The loss is about 3% for 11 Macroblocks per slice and 12% for 4 Macroblocks per slice based on Recommendation ITU-R BT.601 picture format at 4 Mbit/s, (percentages calculated relative to a system using 44 Macroblocks, or one picture width, per slice). The efficiency loss results in degradation of picture quality up to about 1 dB with 4 Macroblocks per slice and 0,2 dB with 11 Macroblocks per slice without errors at 4 Mbit/s. However, the method performs approximately 1 to 5 dB better at $CLR = 10^{-2}$, depending on the concealment method used (simple macroblock replacement or motion compensated concealment).

From the view point of perceived picture quality, the performance of this method is generally dependent on the relative size of slice size and picture. Therefore, the slice size should be decided by considering the picture size (in macroblocks) and the trade-off between coding efficiency and visual degradation due to errors.

D.13.2.2 Adaptive slice size

There is a significant variation in the number of bits required to code a picture slice, depending on the coding mode, picture activity, etc. If slices contain only a few macroblocks, it will be possible that one transport packet, even a short packet or cell, could contain several slices. Offering multiple resynchronisation points in the same transport packet serves no purpose. Another problem with the simplistic short slice approach is that, because no account is taken of the transport packet structure, the first valid transport packet after a loss could contain most of the information for a slice, but it is unusable because the start code was lost.

An improvement over the small slice method may be to use adaptive slice sizes. As the encoder is producing the bitstream, it keeps track of the data contents within transport packets. The start of a slice is placed at the first opportunity in every transport packet (or in every second, third, ...). This approach can achieve about the same spatial localisation of errors as small, fixed size slices, but with a greater efficiency.

However, this method ONLY gives an advantage for cell or packet based transmission, or where error detection occurs over a large block of data. The frequent resynchronisation points of small slice localisation are only wasteful if more than one is lost in the event of an error. If isolated bit errors affect just one slice anyway, then there is no advantage in adapting the slice size.

Furthermore, the adaptive slice size technique requires an intimate connection between encoder and packetiser, to allow a new slice for a new packet or cell. As such, it may not be appropriate for some applications (e.g. stored video intended to be distributed by multiple means) because only one transport packet structure would be assumed during encoding.

D.13.3 Temporal localisation

Temporal localisation encompasses those methods aimed at minimising the extent to which errors propagate from picture to picture in the temporal sequence, by providing early resynchronisation of pictures that are coded differentially. An obvious way to do this is to make use of intra mode coding.

D.13.3.1 Intra pictures

By use of intra pictures a single error will not stay in the decoded picture longer than $(N + M - 1)$ pictures if every Nth picture is coded intra and $(M-1)$ B-pictures are displayed before each I-picture.

While the intra pictures, normally used as "anchors" for synchronising the video decoding part way through a sequence, are useful for temporal localisation, care should be taken in adding extra intra pictures (i.e. reducing N) for error resilience. Intra pictures require a large number of bits to code, take up a relatively large proportion of the encoded bitstream and, as a result, are more likely to be affected by losses or errors themselves.

D.13.3.2 Intra slices

To avoid the additional delay caused by intra pictures, some applications requiring low delay may want to update the picture by coding only parts of the picture intra. This may provide the same kind of error resilience as intra pictures. As an example assume that a constant number of slices per picture from top to bottom are intra coded so that the whole picture is updated every P-pictures. Three aspects of this kind of updating should be kept in mind:

- While an errored portion of the scene will ordinarily be erased within P-pictures (with an average duration of about $P/2$), it is possible that motion compensation will allow the disturbance to bypass the intra refresh and it may persist as long as $2P$ -pictures.

- To ensure that errors are not propagating into the updated region of the picture, restrictions could be put on motion vectors, limiting the vertical vector components to ensure that predictions are not made from the "oldest" parts of the picture.
- The visual effect of clearing errors can be similar to a windscreen wiper clearing water. This *windscreen wiper* effect can become noticeable in some cases in the error free sequence, unless the rate control mechanism ensures that the quality of the intra slice is close to that of the surrounding non-intra macroblocks.

D.13.4 Summary

Table D.3 summarises the above error resilience techniques, with a guide to their applicability.

Table D.3 – Summary of error concealment techniques

Category	Technique	Profile/Applicability
Concealment	Temporal predictive– Substitution from previous picture	Any profile. Most suited to static pictures.
	Temporal predictive – Motion compensated	Any profile. Choice of sophistication in motion vector estimation.
	Temporal predictive – Using concealment MVs	Any profile, but calculation of Intra MVs is an encoder option.
	Spatial predictive	Any profile. Not suitable for static, complex pictures.
	Data Partitioning	Not currently used in a profile, but may be added as post/pre-processing. Minimal overhead and complexity. Depending on bitrate allocation, lower layer may not provide usable pictures by itself.
	SNR Scalability	SNR SCALABLE, SPATIALLY SCALABLE, HIGH profiles. Suitable for very high error rates or temporary unavailability of the enhancement layer. Relatively simple to implement.
	Spatial Scalability	SPATIALLY SCALABLE and HIGH profiles. Suitable for very high error rates or temporary unavailability of the enhancement layer.
	Temporal Scalability	Not currently used in a profile. Suitable for very high error rates or temporary unavailability of the enhancement layer.
	Spatial Localisation	Small Slices
Adaptive slice sizes		Any profile, but requires knowledge of transmission characteristics when packet size is decided.
Temporal Localisation	Intra pictures	Any profile, but has delay implications.
	Intra slices	Any profile, but errors may persist longer than for Intra picture method.

It is not possible to provide a concise indication of error resilience performance, because assessments must necessarily be subjective and application dependent, and so should be taken as nothing more than a guide. It is also true that several different approaches to error resilience are likely to be used in combination. However, the following descriptions are provided as some guidance to performance. They are the results of cell loss experiments, looking only at cell-based transmission of video information.

A simple macroblock substitution from a previous frame combined with the small-slice method (4 macroblocks per slice) will provide adequate picture quality for most sequences in the presence of rather low error rates of around $CLR = 10^{-5}$ (in a reference 4 Mbit/s, Main Profile, Main Level system).

Including sophisticated motion compensated concealment (with full spatial and temporal interpolation of motion vectors for lost macroblocks, and concealing losses in P-pictures that use intra slice updating, i.e. $N = \text{infinity}$, $M = 1$) provides adequate picture quality at $CLR = 10^{-3}$ (again, in a reference 4 Mbit/s, Main Profile, Main Level system).

Operation in environments with greater loss may require use of one of the layered coding methods. With adequate protection of the high priority information, these schemes can provide adequate performance in the face of CLRs as high as 10^{-2} or even 10^{-1} . Data partitioning, implemented as a post-processing function to a 4 Mbit/s Main Profile, Main Level system, with 50% of the rate allocated to each partition and no loss in the base layer, has been shown in one example to give approximately 0,5 dB loss in SNR at a CLR of 10^{-3} , about 1,5 dB loss at 10^{-2} , and with almost no visible degradation in either case.

Given the range of different layered coding approaches that are possible, some general comments may be useful. In general, it is not expected that inclusion of the most complex layered coding methods could be justified purely on the basis of error resilience. Instead, they could be utilised for error resilience if they were required to satisfy other system requirements. Data partitioning is very simple to implement and is likely to provide error resilience very nearly the same as any of the other methods except in the case of extremely high error rates ($> 10\%$ loss) or where the enhancement layer could be lost completely. SNR scalability is slightly more complex, and has slightly lower efficiency than data partitioning, but it is easier to produce lower layers of a usable quality when the enhancement layer is absent. Spatial scalability is more complex again, but provides a good lower layer picture quality at the expense of overall (two layer) efficiency.

D.14 Concatenated sequences

Sequence concatenation occurs when an elementary stream contains a sequence ending with a `sequence_end_code` that is followed by another sequence starting with a `sequence_start_code`. Any parameter including but not limited to profile, level, VBV buffer size, frame rate, horizontal size, vertical size, or bitrate, which is not allowed to change within a single sequence may change from sequence to sequence.

The behaviour of the decoding process and display process for concatenated sequences is not within the scope of this Recommendation | International Standard. An application that needs to use concatenated sequences must ensure by private arrangement that the decoder will be able to decode and play concatenated sequences.

Applications should ensure that decoders will have an acceptable behaviour when parameters change. For example changes to the

- frame size;
- frame rate;
- field parity of the first displayed field of the new sequence versus the field parity of the final displayed field of the previous sequence;
- buffer status,

amongst others may cause problems.

Annex E

Profile and level restrictions

(This annex does not form an integral part of this Recommendation | International Standard)

E.1 Syntax element restrictions in profiles

This annex tabulates all of the syntactic elements defined in this Specification. Each is classified to indicate whether it is required to be supported by a decoder compliant to a particular profile and level. Note that normative specifications for compliance are given in ISO/IEC 13818-4.

NOTE – This annex is informative and is simply intended as a summary of the normative restrictions set out in clause 8. If, because of an error in the preparation of this text, a discrepancy exists between clause 8 and Annex E, the normative text in clause 8 shall always take precedence.

In the Tables E.2 to E.19 a number of abbreviations are used as shown in Table E.1.

Table E.1 – Abbreviations used in the Tables of Annex E

Abbreviation	Used in	Meaning
x	Status	Must be supported by the decoder.
o	Status	Need not be supported by the decoder.
D	Type	Item with Level-dependent parameters.
I	Type	Item independent of the Level in the Profile.
P	Type	Item for post-processing after decoding; the decoder must be capable of decoding bitstreams which contain these items, but their use is beyond the scope of this Recommendation International Standard.
NOTE – "Status" is kept blank if an entry is not a syntactic element.		

Table E.2 – Sequence header

#	Status								Type	Comments
	Multi-view									
	4:2:2									
	HIGH									
	SPATIAL									
	SNR									
	MAIN									
	SIMPLE									
	Syntactic elements									
01	horizontal_size_value	x	x	x	x	x	x	x	D	Table 8-11
02	vertical_size_value	x	x	x	x	x	x	x	D	Table 8-11
03	aspect_ratio_information	x	x	x	x	x	x	x	P	
04	frame_rate_code	x	x	x	x	x	x	x	D	Table 8-11
05	(sample rate) NOTE – This is not a syntactic element								D	Table 8-12. Sample rate is a product of samples/line, lines/frame and frames/sec.
06	bit_rate_value	x	x	x	x	x	x	x	D	Table 8-13
07	vbv_buffer_size_value	x	x	x	x	x	x	x	D	Table 8-14
08	constrained_parameters_flag	x	x	x	x	x	x	x	I	Set to "1" if ISO/IEC 11172-2 constrained, Set to "0" if ITU-T Rec. H.262 ISO/IEC 13818-2
09	load_intra_quantiser_matrix	x	x	x	x	x	x	x	I	
10	intra_quantiser_matrix[64]	x	x	x	x	x	x	x	I	
11	load_non_intra_quantiser_matrix	x	x	x	x	x	x	x	I	
12	non_intra_quantiser_matrix[64]	x	x	x	x	x	x	x	I	
13	sequence_extension()	x	x	x	x	x	x	x	I	Always present if ITU-T Rec. H.262 ISO/IEC 13818-2
14	sequence_display_extension()	x	x	x	x	x	x	x	P	
15	sequence_scalable_extension()	o	o	x	x	x	o	x	I	Table 8-9 for maximum number of scalable layers
16	user_data()	x	x	x	x	x	x	x	I	Decoder may skip this data

Table E.3 – Sequence extension

#	Status								Type	
	Multi-view								Comments	
	4:2:2									
	HIGH									
	SPATIAL									
	SNR									
	MAIN									
	SIMPLE									
	Syntactic elements									
01	profile_and_level_indication	x	x	x	x	x	x	x	D	Profile: one of 8 values Level: one of 16 values Escape bit: one of 2 values
02	progressive_sequence	x	x	x	x	x	x	x	I	
03	chroma_format	x	x	x	x	x	x	x	I	Table 8-5
04	horizontal_size_extension	x	x	x	x	x	x	x	D	Input picture size related
05	vertical_size_extension	x	x	x	x	x	x	x	D	Input picture size related
06	bit_rate_extension	x	x	x	x	x	x	x	D	Input picture size related
07	vbv_buffer_size_extension	x	x	x	x	x	x	x	D	Input picture size related
08	low_delay	x	x	x	x	x	x	x	I	
09	frame_rate_extension_n	x	x	x	x	x	x	x	I	Set to "0" for all defined profiles
10	frame_rate_extension_d	x	x	x	x	x	x	x	I	Set to "0" for all defined profiles

Table E.4 – Sequence display extension elements

#	Status								Type	
	Multi-view								Comments	
	4:2:2									
	HIGH									
	SPATIAL									
	SNR									
	MAIN									
	SIMPLE									
	Syntactic elements									
01	video_format	x	x	x	x	x	x	x	P	
02	colour_description	x	x	x	x	x	x	x	P	Input format related
03	colour primaries	x	x	x	x	x	x	x	P	
04	transfer_characteristics	x	x	x	x	x	x	x	P	
05	matrix_coefficients	x	x	x	x	x	x	x	P	
06	display_horizontal_size	x	x	x	x	x	x	x	P	Input format related
07	display_vertical_size	x	x	x	x	x	x	x	P	Input format related

Table E.5 – Sequence scalable extension

#	Status								Type	
	Multi-view								Comments	
	4:2:2									
	HIGH									
	SPATIAL									
	SNR									
	MAIN									
	SIMPLE									
	Syntactic elements									
01	scalable_mode	o	o	x	x	x	o	x	I	SNR Profile: SNR Scalability Spatial and High Profile: SNR and/or Spatial Scalability Multi-view Profile: Temporal Scalability
02	layer_id	o	o	x	x	x	o	x	I	
	if (spatial scalable)									
03	lower_layer_prediction_horizontal_size	o	o	o	x	x	o	o	D	Table 8-12 for luminance sampling density
04	lower_layer_prediction_vertical_size	o	o	o	x	x	o	o	D	Table 8-12 for luminance sampling density
05	horizontal_subsampling_factor_m	o	o	o	x	x	o	o	I	
06	horizontal_subsampling_factor_n	o	o	o	x	x	o	o	I	
07	vertical_subsampling_factor_m	o	o	o	x	x	o	o	I	
08	vertical_subsampling_factor_n	o	o	o	x	x	o	o	I	
	if (temporal scalable)									
09	picture_mux_enable	o	o	o	o	o	o	x	I	
10	mux_to_progressive_sequence	o	o	o	o	o	o	x	I	
11	picture_mux_order	o	o	o	o	o	o	x	I	
12	picture_mux_factor	o	o	o	o	o	o	x	I	

Table E.6 – Group of pictures header

#	Status								Type	Comments	
	Syntactic elements	SIMPLE	MAIN	SNR	SPATIAL	HIGH	4:2:2	Multi-view			
01	time_code	x	x	x	x	x	x	x	x	I	Decoder may skip this data
02	closed_gop	x	x	x	x	x	x	x	x	I	
03	broken_link	x	x	x	x	x	x	x	x	I	

Table E.7 – Picture header

#	Status								Type	Comments	
	Syntactic elements	SIMPLE	MAIN	SNR	SPATIAL	HIGH	4:2:2	Multi-view			
01	temporal_reference	x	x	x	x	x	x	x	x	I	
02	picture_coding_type	x	x	x	x	x	x	x	x	I	Simple Profile: I, P at Main level, I, P, B at Low level Main, SNR, Spatial, High and Multi-view Profile: I, P, B
03	vbv_delay	x	x	x	x	x	x	x	x	I	
04	full_pel_forward_vector	x	x	x	x	x	x	x	x	I	Set to "0" for ITU-T Rec. H.262 ISO/IEC 13818-2
05	forward_f_code	x	x	x	x	x	x	x	x	I	Set to "111" for ITU-T Rec. H.262 ISO/IEC 13818-2
06	full_pel_backward_vector	x	x	x	x	x	x	x	x	I	Set to "0" for ITU-T Rec. H.262 ISO/IEC 13818-2
07	backward_f_code	x	x	x	x	x	x	x	x	I	Set to "111" for ITU-T Rec. H.262 ISO/IEC 13818-2
08	extra_information_picture	x	x	x	x	x	x	x	x	I	
09	picture_coding_extension()	x	x	x	x	x	x	x	x	I	
10	quant_matrix_extension()	x	x	x	x	x	x	x	x	I	
11	picture_display_extension()	x	x	x	x	x	x	x	x	P	
12	picture_spatial_scalable_extension()	o	o	o	x	x	o	o	o	I	
13	picture_temporal_scalable_extension()	o	o	o	o	o	o	o	x	I	
14	camera_parameters_extension()	o	o	o	o	o	o	o	x	P	

Table E.8 – Picture coding extension

#	Status								Type	Comments
	Multi-view									
	4:2:2									
	HIGH									
	SPATIAL									
	SNR									
	MAIN									
	SIMPLE									
	Syntactic elements									
01	f_code[0][0] (forward horizontal)	x	x	x	x	x	x	x	D	Low Level [1:7] Main Level [1:8] High-1440 and High Level [1:9]
02	f_code[0][1] (forward vertical)	x	x	x	x	x	x	x	D	Low Level [1:4] Main, High-1440 and High Level [1:5]
03	f_code[1][0](backward horizontal)	x	x	x	x	x	x	x	D	Low Level [1:7] Main Level [1:8] High-1440 and High Level [1:9]
04	f_code[1][1] (backward vertical)	x	x	x	x	x	x	x	D	Low level [1:4] Main, H-14 and High Level [1:5]
05	intra_dc_precision	x	x	x	x	x	x	x	I	Simple, Main, SNR, Spatial and Multi-view Profile: [8:10] High Profile: [8:11] 4:2:2 Profile: [8:11]
06	picture_structure	x	x	x	x	x	x	x	I	
07	top_field_first	x	x	x	x	x	x	x	I	
08	frame_pred_frame_dct	x	x	x	x	x	x	x	I	
09	concealment_motion_vectors	x	x	x	x	x	x	x	I	
10	q_scale_type	x	x	x	x	x	x	x	I	
11	intra_vlc_format	x	x	x	x	x	x	x	I	
12	alternate_scan	x	x	x	x	x	x	x	I	
13	repeat_first_field	x	x	x	x	x	x	x	I	
14	chroma_420_type	x	x	x	x	x	x	x	P	
15	progressive_frame	x	x	x	x	x	x	x	P	
16	composite_display_flag	x	x	x	x	x	x	x	P	
17	v_axis	x	x	x	x	x	x	x	P	
18	field_sequence	x	x	x	x	x	x	x	P	
19	sub_carrier	x	x	x	x	x	x	x	P	
20	burst_amplitude	x	x	x	x	x	x	x	P	
21	sub_carrier_phase	x	x	x	x	x	x	x	P	

Table E.9 – Quant matrix extension

#	Status								Type	Comments
	Syntactic elements	SIMPLE	MAIN	SNR	SPATIAL	HIGH	4:2:2	Multi-view		
01	load_intra_quantiser_matrix	x	x	x	x	x	x	x	I	
02	intra_quantiser_matrix[64]	x	x	x	x	x	x	x	I	
03	load_non_intra_quantiser_matrix	x	x	x	x	x	x	x	I	
04	non_intra_quantiser_matrix[64]	x	x	x	x	x	x	x	I	
05	load_chroma_intra_quantiser_matrix	o	o	o	o	x	x	o	I	
06	chroma_intra_quantiser_matrix[64]	o	o	o	o	x	x	o	I	
07	load_chroma_non_intra_quantiser_matrix	o	o	o	o	x	x	o	I	
08	chroma_non_intra_quantiser_matrix[64]	o	o	o	o	x	x	o	I	

Table E.10 – Picture display extension

#	Status								Type	Comments
	Syntactic elements	SIMPLE	MAIN	SNR	SPATIAL	HIGH	4:2:2	Multi-view		
01	frame_centre_horizontal_offset	x	x	x	x	x	x	x	P	Input format related
02	frame_centre_vertical_offset	x	x	x	x	x	x	x	P	Input format related

Table E.11 – Picture temporal scalable extension

#	Status								Type			
	Syntactic elements	Multi-view							Comments			
4:2:2												
HIGH												
SPATIAL												
SNR												
MAIN												
SIMPLE												
01	reference_select_code	o	o	o	o	o	o	x			I	
02	forward_temporal_reference	o	o	o	o	o	o	x			I	
03	backward_temporal_reference	o	o	o	o	o	o	x			I	

Table E.12 – Picture spatial scalable extension

#	Status								Type			
	Syntactic elements	Multi-view							Comments			
4:2:2												
HIGH												
SPATIAL												
SNR												
MAIN												
SIMPLE												
01	lower_layer_temporal_reference	o	o	o	x	x	o	o			I	
02	lower_layer_horizontal_offset	o	o	o	x	x	o	o			D	Input format related
03	lower_layer_vertical_offset	o	o	o	x	x	o	o			D	Input format related
04	spatial_temporal_weight_code_table_index	o	o	o	x	x	o	o	I			
05	lower_layer_progressive_frame	o	o	o	x	x	o	o	I			
06	lower_layer_deinterlaced_field_select	o	o	o	x	x	o	o	I			

Table E.12-1 – Camera parameters extension

#	Status								Type		Comments
	Multi-view										
	4:2:2										
	HIGH										
	SPATIAL										
	SNR										
	MAIN										
	SIMPLE										
	Syntactic elements										
01	reserved	o	o	o	o	o	o	x	P		
02	camera_id	o	o	o	o	o	o	x	P		
03	marker_bit	o	o	o	o	o	o	x	P		
04	height_of_image_device	o	o	o	o	o	o	x	P		
05	marker_bit	o	o	o	o	o	o	x	P		
06	focal_length	o	o	o	o	o	o	x	P		
07	marker_bit	o	o	o	o	o	o	x	P		
08	f_number	o	o	o	o	o	o	x	P		
09	marker_bit	o	o	o	o	o	o	x	P		
10	vertical_angle_of_view	o	o	o	o	o	o	x	P		
11	marker_bit	o	o	o	o	o	o	x	P		
12	camera_position_x_upper	o	o	o	o	o	o	x	P		
13	marker_bit	o	o	o	o	o	o	x	P		
14	camera_position_x_lower	o	o	o	o	o	o	x	P		
15	marker_bit	o	o	o	o	o	o	x	P		
16	camera_position_y_upper	o	o	o	o	o	o	x	P		
17	marker_bit	o	o	o	o	o	o	x	P		
18	camera_position_y_lower	o	o	o	o	o	o	x	P		
19	marker_bit	o	o	o	o	o	o	x	P		
20	camera_position_z_upper	o	o	o	o	o	o	x	P		
21	marker_bit	o	o	o	o	o	o	x	P		
22	camera_position_z_lower	o	o	o	o	o	o	x	P		
23	marker_bit	o	o	o	o	o	o	x	P		
24	camera_direction_x	o	o	o	o	o	o	x	P		
25	marker_bit	o	o	o	o	o	o	x	P		
26	camera_direction_y	o	o	o	o	o	o	x	P		
27	marker_bit	o	o	o	o	o	o	x	P		
28	camera_direction_z	o	o	o	o	o	o	x	P		
29	marker_bit	o	o	o	o	o	o	x	P		
30	image_plane_vertical_x	o	o	o	o	o	o	x	P		
31	marker_bit	o	o	o	o	o	o	x	P		
32	image_plane_vertical_y	o	o	o	o	o	o	x	P		
33	marker_bit	o	o	o	o	o	o	x	P		
34	image_plane_vertical_z	o	o	o	o	o	o	x	P		
35	reserved	o	o	o	o	o	o	x	P		

Table E.13 – Slice layer

#	Syntactic elements	Status								Type	Comments
		Multi-view									
		4:2:2									
		HIGH									
		SPATIAL									
		SNR									
		MAIN									
		SIMPLE									
01	slice_vertical_position_extension	x	x	x	x	x	x	x	x	D	Input format related
02	priority_breakpoint	o	o	o	o	o	o	o	o	I	Only required for data partitioning
03	quantiser_scale_code	x	x	x	x	x	x	x	x	I	
04	slice_extension_flag	x	x	x	x	x	x	x	x	I	
05	intra_slice	x	x	x	x	x	x	x	x	I	Decoder may skip this data
06	slice_picture_id_enable	x	x	x	x	x	x	x	x	I	Decoder may skip this data
07	slice_picture_id	x	x	x	x	x	x	x	x	I	Decoder may skip this data
08	extra_bit_slice	x	x	x	x	x	x	x	x	I	Decoder may skip this data
09	macroblock()	x	x	x	x	x	x	x	x	I	

Table E.14 – Macroblock layer

#	Syntactic elements	Status								Type	Comments
		Multi-view									
		4:2:2									
		HIGH									
		SPATIAL									
		SNR									
		MAIN									
		SIMPLE									
01	macroblock_escape	x	x	x	x	x	x	x	x	I	
02	macroblock_address_increment	x	x	x	x	x	x	x	x	I	
03	macroblock_modes()	x	x	x	x	x	x	x	x	I	
04	quantiser_scale_code	x	x	x	x	x	x	x	x	I	
05	motion_vectors(0)	x	x	x	x	x	x	x	x	I	Forward motion vector
06	motion_vectors(1)	o	x	x	x	x	x	x	x	I	Backward motion vector
07	coded_block_pattern()	x	x	x	x	x	x	x	x	I	
08	block(i)	x	x	x	x	x	x	x	x	I	

Table E.15 – Macroblock modes

#	Status									Type	
	Multi-view									Comments	
4:2:2									Comments		
HIGH										Comments	
SPATIAL									Comments		
SNR										Comments	
MAIN									Comments		
SIMPLE										Comments	
Syntactic elements									Comments		
01	macroblock_type	x	x	x	x	x	x	x		x	I
02	spatial_temporal_weight_code	o	o	o	x	x	o	o		I	
03	frame_motion_type	x	x	x	x	x	x	x		I	01: Field-based prediction 10: Frame-based prediction 11: Dual-prime
04	field_motion_type	x	x	x	x	x	x	x		I	01: Field-based prediction 10: 16 × 8 MC 11: Dual-prime
05	dct_type	x	x	x	x	x	x	x		I	

Table E.16 – Motion vectors

#	Status									Type	
	Multi-view									Comments	
4:2:2									Comments		
HIGH										Comments	
SPATIAL									Comments		
SNR										Comments	
MAIN									Comments		
SIMPLE										Comments	
Syntactic elements									Comments		
01	motion_vertical_field_select	x	x	x	x	x	x	x		x	I
02	motion_vector()	x	x	x	x	x	x	x	x	I	

Table E.17 – Motion vector

#	Status								Type	
	Syntactic elements	Multi-view							I	Comments
4:2:2							I	Comments		
HIGH						I			Comments	
SPATIAL					I		Comments			
SNR				I		Comments				
MAIN			I		Comments					
SIMPLE		I		Comments						
01	motion_horizontal_code		x		x	x	x	x	x	x
02	motion_horizontal_r	x	x	x	x	x	x	x	I	
03	dmv_horizontal	x	x	x	x	x	x	x	I	
04	motion_vertical_code	x	x	x	x	x	x	x	I	
05	motion_vertical_r	x	x	x	x	x	x	x	I	
06	dmv_vertical	x	x	x	x	x	x	x	I	

Table E.18 – Coded block pattern

#	Status								Type	
	Syntactic elements	Multi-view							I	Comments
4:2:2							I	Comments		
HIGH						I			Comments	
SPATIAL					I		Comments			
SNR				I		Comments				
MAIN			I		Comments					
SIMPLE		I		Comments						
01	coded_block_pattern_420		x		x	x	x	x	x	x
02	coded_block_pattern_1	o	o	o	o	x	x	o	I	4:2:2
03	coded_block_pattern_2	o	o	o	o	o	o	o	I	4:4:4

Table E.19 – Block layer

#	Status									Type	
	Multi-view									Comments	
4:2:2									Comments		
HIGH										Comments	
SPATIAL									Comments		
SNR										Comments	
MAIN									Comments		
SIMPLE										Comments	
Syntactic elements									Comments		
01	DCT coefficients	x	x	x	x	x	x	x		x	I
02	End of block	x	x	x	x	x	x	x	x	I	

E.2 Permissible layer combinations

Tables E.20 to E.46 illustrate the parameter limits that may be applied in each layer of a bitstream, and the corresponding appropriate profile_and_level_indication that should be used. Each table describes the limits of a single compliance point in the profile / level matrix.

The following notation has been adopted:

<profile abbreviation>@<level abbreviation>

The abbreviations are defined in Table E.20.

Table E.20 – Abbreviations for profile and level names

Profile	<profile abbreviation>	Level	<level abbreviation>
Simple	SP	Low	LL
Main	MP	Main	ML
SNR Scalable	SNR	High-1440	H-14
Spatially Scalable	Spt	High	HL
High	HP		
Multi-view	MVP		
ISO/IEC 11172-2 constrained parameters			ISO/IEC 11172-2

Table E.21 – Simple profile @ Main level

No. of layers	layer id	Scalable mode	Maximum sample density (H/V/F)	Maximum sample rate	Maximum total bit rate /1000000	Maximum total VBV buffer	Profile and level indication
1	0	Base	720/576/30	10 368 000	15	1 835 008	SP@ML

Table E.22 – Main profile @ Low level

No. of layers	layer id	Scalable mode	Maximum sample density (H/V/F)	Maximum sample rate	Maximum total bit rate /1000000	Maximum total VBV buffer	Profile and level indication
1	0	Base	352/288/30	3 041 280	4	475 136	MP@LL

Table E.23 – Main profile @ Main level

No. of layers	layer id	Scalable mode	Maximum sample density (H/V/F)	Maximum sample rate	Maximum total bit rate /1000000	Maximum total VBV buffer	Profile and level indication
1	0	Base	720/576/30	10 368 000	15	1 835 008	MP@ML

Table E.24 – Main profile @ High-1440 level

No. of layers	layer id	Scalable mode	Maximum sample density (H/V/F)	Maximum sample rate	Maximum total bit rate /1000000	Maximum total VBV buffer	Profile and level indication
1	0	Base	1440/1088/60	47 001 600	60	7 340 032	MP@H-14

Table E.25 – Main profile @ High level

No. of layers	layer id	Scalable mode	Maximum sample density (H/V/F)	Maximum sample rate	Maximum total bit rate /1000000	Maximum total VBV buffer	Profile and level indication
1	0	Base	1920/1088/60	62 668 800	80	9 781 248	MP@HL

Table E.26 – SNR profile @ Low level

No. of layers	layer id	Scalable mode	Maximum sample density (H/V/F)	Maximum sample rate	Maximum total bit rate /1000000	Maximum total VBV buffer	Profile and level indication
2	0	Base	352/288/30	2 534 400	1.856	327 680	ISO 11172
	1	SNR	352/288/30	2 534 400	4	475 136	SNR@LL
2	0	Base	352/288/30	3 041 280	3	360 448	SP@ML
	1	SNR	352/288/30	3 041 280	4	475 136	SNR@LL
2	0	Base	352/288/30	3 041 280	3	360 448	MP@LL
	1	SNR	352/288/30	3 041 280	4	475 136	SNR@LL

Table E.27 – SNR profile @ Main level

No. of layers	layer id	Scalable mode	Maximum sample density (H/V/F)	Maximum sample rate	Maximum total bit rate /1000000	Maximum total VBV buffer	Profile and level indication
2	0	Base	720/576/30	2 534 400	1.856	327 680	ISO 11172
	1	SNR	720/576/30	2 534 400	15	1 835 008	SNR@ML
2	0	Base	720/576/30	10 368 000	10	1 212 416	SP@ML
	1	SNR	720/576/30	10 368 000	15	1 835 008	SNR@ML
2	0	Base	352/288/30	3 041 280	4	475 136	MP@LL
	1	SNR	352/288/30	3 041 280	15	1 835 008	SNR@ML
2	0	Base	720/576/30	10 368 000	10	1 212 416	MP@ML
	1	SNR	720/576/30	10 368 000	15	1 835 008	SNR@ML

Table E.28 – Spatial profile @ High-1440 level (Base Layer + SNR)

No. of layers	layer id	Scalable mode	Maximum sample density (H/V/F)	Maximum sample rate	Maximum total bit rate /1000000	Maximum total VBV buffer	Profile and level indication
2	0	Base	352/288/30	2 534 400	1.856	327 680	ISO 11172
	1	SNR	352/288/30	2 534 400	60	7 340 032	Spt@H-14
2	0	Base	720/576/30	10 368 000	15	1 835 008	SP@ML
	1	SNR	720/576/30	10 368 000	60	7 340 032	Spt@H-14
2	0	Base	352/288/30	3 041 280	4	475 136	MP@LL
	1	SNR	352/288/30	3 041 280	60	7 340 032	Spt@H-14
2	0	Base	720/576/30	10 368 000	15	1 835 008	MP@ML
	1	SNR	720/576/30	10 368 000	60	7 340 032	Spt@H-14
2	0	Base	1440/1088/60	47 001 600	40	4 882 432	MP@H-14
	1	SNR	1440/1088/60	47 001 600	60	7 340 032	Spt@H-14

Table E.29 – Spatial profile @ High-1440 level (Base Layer + Spatial)

No. of layers	layer id	Scalable mode	Maximum sample density (H/V/F)	Maximum sample rate	Maximum total bit rate /1000000	Maximum total VBV buffer	Profile and level indication
2	0	Base	768/576/30	2 534 400	1.856	327 680	ISO 11172
	1	Spatial	1440/1088/30	47 001 600	60	7 340 032	Spt@H-14
2	0	Base	720/576/30	10 368 000	15	1 835 008	SP@ML
	1	Spatial	1440/1088/30	47 001 600	60	7 340 032	Spt@H-14
2	0	Base	352/288/30	3 041 280	4	475 136	MP@LL
	1	Spatial	1440/1088/30	47 001 600	60	7 340 032	Spt@H-14
2	0	Base	720/576/30	10 368 000	15	1 835 008	MP@ML
	1	Spatial	1440/1088/30	47 001 600	60	7 340 032	Spt@H-14
2	0	Base	1440/1088/60	47 001 600	40	4 882 432	MP@H-14
	1	Spatial	1440/1088/60	47 001 600	60	7 340 032	Spt@H-14

Table E.30 – Spatial profile @ High-1440 level (Base Layer + SNR + Spatial)

No. of layers	layer id	Scalable mode	Maximum sample density (H/V/F)	Maximum sample rate	Maximum total bit rate /1000000	Maximum total VBV buffer	Profile and level indication
3	0	Base	352/288/30	2 534 400	1.856	327 680	ISO 11172
	1	SNR	352/288/30	2 534 400	4	475 136	SNR@LL
	2	Spatial	1440/1088/30	47 001 600	60	7 340 032	Spt@H-14
3	0	Base	352/288/30	3 041 280	3	360 448	SP@ML
	1	SNR	352/288/30	3 041 280	4	475 136	SNR@LL
	2	Spatial	1440/1088/30	47 001 600	60	7 340 032	Spt@H-14
3	0	Base	352/288/30	3 041 280	3	360 448	MP@LL
	1	SNR	352/288/30	3 041 280	4	475 136	SNR@LL
	2	Spatial	1440/1088/30	47 001 600	60	7 340 032	Spt@H-14
3	0	Base	720/576/30	2 534 400	1.856	327 680	ISO 11172
	1	SNR	720/576/30	2 534 400	15	1 835 008	SNR@ML
	2	Spatial	1440/1088/30	47 001 600	60	7 340 032	Spt@H-14
3	0	Base	720/576/30	10 368 000	10	1 212 416	SP@ML
	1	SNR	720/576/30	10 368 000	15	1 835 008	SNR@ML
	2	Spatial	1440/1088/30	47 001 600	60	7 340 032	Spt@H-14
3	0	Base	352/288/30	3 041 280	4	475 136	MP@LL
	1	SNR	352/288/30	3 041 280	15	1 835 008	SNR@ML
	2	Spatial	1440/1088/30	47 001 600	60	7 340 032	Spt@H-14
3	0	Base	720/576/30	10 368 000	10	1 212 416	MP@ML
	1	SNR	720/576/30	10 368 000	15	1 835 008	SNR@ML
	2	Spatial	1440/1088/30	47 001 600	60	7 340 032	Spt@H-14
3	0	Base	1440/1088/60	10 368 000	15	1 835 008	MP@H-14
	1	SNR	1440/1088/60	10 368 000	40	4 882 432	Spt@H-14
	2	Spatial	1440/1088/60	47 001 600	60	7 340 032	Spt@H-14

Table E.31 – Spatial profile @ High-1440 level (Base Layer + Spatial + SNR)

No. of layers	layer id	Scalable mode	Maximum sample density (H/V/F)	Maximum sample rate	Maximum total bit rate /1000000	Maximum total VBV buffer	Profile and level indication
3	0	Base	768/576/30	2 534 400	1.856	327 680	ISO 11172
	1	Spatial	1440/1088/30	47 001 600	40	4 882 432	Spt@H-14
	2	SNR	1440/1088/30	47 001 600	60	7 340 032	Spt@H-14
3	0	Base	720/576/30	10 368 000	15	1 835 008	SP@ML
	1	Spatial	1440/1088/30	47 001 600	40	4 882 432	Spt@H-14
	2	SNR	1440/1088/30	47 001 600	60	7 340 032	Spt@H-14
3	0	Base	352/288/30	3 041 280	4	475 136	MP@LL
	1	Spatial	1440/1088/30	47 001 600	40	4 882 432	Spt@H-14
	2	SNR	1440/1088/30	47 001 600	60	7 340 032	Spt@H-14
3	0	Base	720/576/30	10 368 000	15	1 835 008	MP@ML
	1	Spatial	1440/1088/30	47 001 600	40	4 882 432	Spt@H-14
	2	SNR	1440/1088/30	47 001 600	60	7 340 032	Spt@H-14
3	0	Base	720/576/30	10 368 000	15	1 835 008	MP@H-14
	1	Spatial	1440/1088/60	47 001 600	40	4 882 432	Spt@H-14
	2	SNR	1440/1088/30	47 001 600	60	7 340 032	Spt@H-14

Table E.32 – High profile @ Main level (Base Layer)

No. of layers	layer id	Scalable mode	Chroma Format	Maximum sample density (H/V/F)	Maximum sample rate	Maximum total bit rate /1000000	Maximum total VBV buffer	Profile and level indication
1	0	Base	4:2:0	720/576/30	14 745 600	20	2 441 216	HP@ML
1	0	Base	4:2:2	720/576/30	11 059 200	20	2 441 216	HP@ML

Table E.33 – High profile @ Main level (Base Layer + SNR)

No. of layers	layer id	Scalable mode	Chroma Format	Maximum sample density (H/V/F)	Maximum sample rate	Maximum total bit rate /1000000	Maximum total VBV buffer	Profile and level indication
2	0	Base	4:2:0	720/576/30	10 368 000	15	1 835 008	SP@ML
	1	SNR	4:2:0	720/576/30	10 368 000	20	2 441 216	HP@ML
2	0	Base	4:2:0	720/576/30	10 368 000	15	1 835 008	SP@ML
	1	SNR	4:2:2	720/576/30	10 368 000	20	2 441 216	HP@ML
2	0	Base	4:2:0	352/288/30	3 041 280	4	475 136	MP@LL
	1	SNR	4:2:0	352/288/30	3 041 280	20	2 441 216	HP@ML
2	0	Base	4:2:0	352/288/30	3 041 280	4	475 136	MP@LL
	1	SNR	4:2:2	352/288/30	3 041 280	20	2 441 216	HP@ML
2	0	Base	4:2:0	720/576/30	10 368 000	15	1 835 008	MP@ML
	1	SNR	4:2:0	720/576/30	10 368 000	20	2 441 216	HP@ML
2	0	Base	4:2:0	720/576/30	10 368 000	15	1 835 008	MP@ML
	1	SNR	4:2:2	720/576/30	10 368 000	20	2 441 216	HP@ML
2	0	Base	4:2:0	720/576/30	14 745 600	15	1 835 008	HP@ML
	1	SNR	4:2:0	720/576/30	14 745 600	20	2 441 216	HP@ML
2	0	Base	4:2:2	720/576/30	11 059 200	15	1 835 008	HP@ML
	1	SNR	4:2:2	720/576/30	11 059 200	20	2 441 216	HP@ML

Table E.34 – High profile @ Main level (Base Layer + Spatial)

No. of layers	layer id	Scalable mode	Chroma Format	Maximum sample density (H/V/F)	Maximum sample rate	Maximum total bit rate /1000000	Maximum total VBV buffer	Profile and level indication
2	0	Base	4:2:0	352/288/30	2 534 400	1.856	327 680	ISO 11172
	1	Spatial	4:2:0	720/576/30	14 745 600	20	2 441 216	HP@ML
2	0	Base	4:2:0	352/288/30	2 534 400	1.856	327 680	ISO 11172
	1	Spatial	4:2:2	720/576/30	11 059 200	20	2 441 216	HP@ML
2	0	Base	4:2:0	352/288/30	3 041 280	4	475 136	SP@ML
	1	Spatial	4:2:0	720/576/30	14 745 600	20	2 441 216	HP@ML
2	0	Base	4:2:0	352/288/30	3 041 280	4	475 136	SP@ML
	1	Spatial	4:2:2	720/576/30	11 059 200	20	2 441 216	HP@ML
2	0	Base	4:2:0	352/288/30	3 041 280	4	475 136	MP@LL
	1	Spatial	4:2:0	720/576/30	14 745 600	20	2 441 216	HP@ML
2	0	Base	4:2:0	352/288/30	3 041 280	4	475 136	MP@LL
	1	Spatial	4:2:2	720/576/30	11 059 200	20	2 441 216	HP@ML

Table E.35 – High profile @ Main level (Base Layer + SNR + Spatial)

No. of layers	layer id	Scalable mode	Chroma Format	Maximum sample density (H/V/F)	Maximum sample rate	Maximum total bit rate /1000000	Maximum total VBV buffer	Profile and level indication
3	0	Base	4:2:0	352/288/30	3 041 280	3	360 448	SP@ML
	1	SNR	4:2:0	352/288/30	3 041 280	4	475 136	SNR@LL
	2	Spatial	4:2:0	720/576/30	14 745 600	20	2 441 216	HP@ML
3	0	Base	4:2:0	352/288/30	3 041 280	3	360 448	SP@ML
	1	SNR	4:2:0	352/288/30	3 041 280	4	475 136	SNR@LL
	2	Spatial	4:2:2	720/576/30	11 059 200	20	2 441 216	HP@ML
3	0	Base	4:2:0	352/288/30	3 041 280	3	360 448	MP@LL
	1	SNR	4:2:0	352/288/30	3 041 280	4	475 136	SNR@LL
	2	Spatial	4:2:0	720/576/30	14 745 600	20	2 441 216	HP@ML
3	0	Base	4:2:0	352/288/30	3 041 280	3	360 448	MP@LL
	1	SNR	4:2:0	352/288/30	3 041 280	4	475 136	SNR@LL
	2	Spatial	4:2:2	720/576/30	11 059 200	20	2 441 216	HP@ML

Table E.36 – High profile @ Main level (Base Layer + Spatial + SNR)

No. of layers	layer id	Scalable mode	Chroma Format	Maximum sample density (H/V/F)	Maximum sample rate	Maximum total bit rate /1000000	Maximum total VBV buffer	Profile and level indication
3	0	Base	4:2:0	352/288/30	2 534 400	1.856	327 680	ISO 11172
	1	Spatial	4:2:0	720/576/30	14 745 600	15	1 835 008	HP@ML
	2	SNR	4:2:0	720/576/30	14 745 600	20	2 441 216	HP@ML
3	0	Base	4:2:0	352/288/30	2 534 400	1.856	327 680	ISO 11172
	1	Spatial	4:2:0	720/576/30	11 059 200	15	1 835 008	HP@ML
	2	SNR	4:2:2	720/576/30	11 059 200	20	2 441 216	HP@ML
3	0	Base	4:2:0	352/288/30	2 534 400	1.856	327 680	ISO 11172
	1	Spatial	4:2:2	720/576/30	11 059 200	15	1 835 008	HP@ML
	2	SNR	4:2:2	720/576/30	11 059 200	20	2 441 216	HP@ML
3	0	Base	4:2:0	352/288/30	3 041 280	4	475 136	SP@ML
	1	Spatial	4:2:0	720/576/30	14 745 600	15	1 835 008	HP@ML
	2	SNR	4:2:0	720/576/30	14 745 600	20	2 441 216	HP@ML
3	0	Base	4:2:0	352/288/30	3 041 280	4	475 136	SP@ML
	1	Spatial	4:2:0	720/576/30	11 059 200	15	1 835 008	HP@ML
	2	SNR	4:2:2	720/576/30	11 059 200	20	2 441 216	HP@ML
3	0	Base	4:2:0	352/288/30	3 041 280	4	475 136	SP@ML
	1	Spatial	4:2:2	720/576/30	11 059 200	15	1 835 008	HP@ML
	2	SNR	4:2:2	720/576/30	11 059 200	20	2 441 216	HP@ML
3	0	Base	4:2:0	352/288/30	3 041 280	4	475 136	MP@LL
	1	Spatial	4:2:0	720/576/30	14 745 600	15	1 835 008	HP@ML
	2	SNR	4:2:0	720/576/30	14 745 600	20	2 441 216	HP@ML
3	0	Base	4:2:0	352/288/30	3 041 280	4	475 136	MP@LL
	1	Spatial	4:2:0	720/576/30	11 059 200	15	1 835 008	HP@ML
	2	SNR	4:2:2	720/576/30	11 059 200	20	2 441 216	HP@ML
3	0	Base	4:2:0	352/288/30	3 041 280	4	475 136	MP@LL
	1	Spatial	4:2:2	720/576/30	11 059 200	15	1 835 008	HP@ML
	2	SNR	4:2:2	720/576/30	11 059 200	20	2 441 216	HP@ML

Table E.37 – High profile @ High-1440 level (Base Layer)

No. of layers	layer id	Scalable mode	Chroma Format	Maximum sample density (H/V/F)	Maximum sample rate	Maximum total bit rate /1000000	Maximum total VBV buffer	Profile and level indication
1	0	Base	4:2:0	1440/1088/60	62 668 800	80	9 781 248	HP@H-14
1	0	Base	4:2:2	1440/1088/60	47 001 600	80	9 781 248	HP@H-14

Table E.38 – High profile @ High-1440 level (Base Layer + SNR)

No. of layers	layer id	Scalable mode	Chroma Format	Maximum sample density (H/V/F)	Maximum sample rate	Maximum total bit rate /1000000	Maximum total VBV buffer	Profile and level indication
2	0	Base	4:2:0	720/576/30	10 368 000	15	1 835 008	SP@ML
	1	SNR	4:2:0	720/576/30	10 368 000	80	9 781 248	HP@H-14
2	0	Base	4:2:0	720/576/30	10 368 000	15	1 835 008	SP@ML
	1	SNR	4:2:2	720/576/30	10 368 000	80	9 781 248	HP@H-14
2	0	Base	4:2:0	352/288/30	3 041 280	4	475 136	MP@LL
	1	SNR	4:2:0	352/288/30	3 041 280	80	9 781 248	HP@H-14
2	0	Base	4:2:0	352/288/30	3 041 280	4	475 136	MP@LL
	1	SNR	4:2:2	352/288/30	3 041 280	80	9 781 248	HP@H-14
2	0	Base	4:2:0	720/576/30	10 368 000	15	1 835 008	MP@ML
	1	SNR	4:2:0	720/576/30	10 368 000	80	9 781 248	HP@H-14
2	0	Base	4:2:0	720/576/30	10 368 000	15	1 835 008	MP@ML
	1	SNR	4:2:2	720/576/30	10 368 000	80	9 781 248	HP@H-14
2	0	Base	4:2:0	1440/1088/60	47 001 600	60	7 340 032	MP@H-14
	1	SNR	4:2:0	1440/1088/60	47 001 600	80	9 781 248	HP@H-14
2	0	Base	4:2:0	1440/1088/60	47 001 600	60	7 340 032	MP@H-14
	1	SNR	4:2:2	1440/1088/60	47 001 600	80	9 781 248	HP@H-14
2	0	Base	4:2:0	720/576/30	14 745 600	20	1 835 008	HP@ML
	1	SNR	4:2:0	720/576/30	14 745 600	80	9 781 248	HP@H-14
2	0	Base	4:2:0	720/576/30	14 745 600	20	1 835 008	HP@ML
	1	SNR	4:2:2	720/576/30	14 745 600	80	9 781 248	HP@H-14
2	0	Base	4:2:2	720/576/30	11 059 200	20	1 835 008	HP@ML
	1	SNR	4:2:2	720/576/30	11 059 200	80	9 781 248	HP@H-14
2	0	Base	4:2:0	1440/1088/60	62 668 800	60	7 340 032	HP@H-14
	1	SNR	4:2:0	1440/1088/60	62 668 800	80	9 781 248	HP@H-14
2	0	Base	4:2:0	1440/1088/60	47 001 600	60	7 340 032	HP@H-14
	1	SNR	4:2:2	1440/1088/60	47 001 600	80	9 781 248	HP@H-14
2	0	Base	4:2:2	1440/1088/60	47 001 600	60	7 340 032	HP@H-14
	1	SNR	4:2:2	1440/1088/60	47 001 600	80	9 781 248	HP@H-14

Table E.39 – High profile @ High-1440 level (Base Layer + Spatial)

No. of layers	layer id	Scalable mode	Chroma Format	Maximum sample density (H/V/F)	Maximum sample rate	Maximum total bit rate /1000000	Maximum total VBV buffer	Profile and level indication
2	0	Base	4:2:0	352/288/30	2 534 400	1.856	327 680	ISO 11172
	1	Spatial	4:2:0	1440/1088/60	62 668 800	80	9 781 248	HP@H-14
2	0	Base	4:2:0	352/288/30	2 534 400	1.856	327 680	ISO 11172
	1	Spatial	4:2:2	1440/1088/60	47 001 600	80	9 781 248	HP@H-14
2	0	Base	4:2:0	720/576/30	10 368 000	15	1 835 008	SP@ML
	1	Spatial	4:2:0	1440/1088/60	62 668 800	80	9 781 248	HP@H-14
2	0	Base	4:2:0	720/576/30	10 368 000	15	1 835 008	SP@ML
	1	Spatial	4:2:2	1440/1088/60	47 001 600	80	9 781 248	HP@H-14
2	0	Base	4:2:0	352/288/30	3 041 280	4	475 136	MP@LL
	1	Spatial	4:2:0	1440/1088/60	62 668 800	80	9 781 248	HP@H-14
2	0	Base	4:2:0	352/288/30	3 041 280	4	475 136	MP@LL
	1	Spatial	4:2:2	1440/1088/60	47 001 600	80	9 781 248	HP@H-14
2	0	Base	4:2:0	720/576/30	10 368 000	15	1 835 008	MP@ML
	1	Spatial	4:2:0	1440/1088/60	62 668 800	80	9 781 248	HP@H-14
2	0	Base	4:2:0	720/576/30	10 368 000	15	1 835 008	MP@ML
	1	Spatial	4:2:2	1440/1088/60	47 001 600	80	9 781 248	HP@H-14
2	0	Base	4:2:0	720/576/30	14 745 600	20	2 441 216	MP@H-14
	1	Spatial	4:2:0	1440/1088/60	62 668 800	80	9 781 248	HP@H-14
2	0	Base	4:2:0	720/576/30	14 745 600	20	2 441 216	MP@H-14
	1	Spatial	4:2:2	1440/1088/60	47 001 600	80	9 781 248	HP@H-14
2	0	Base	4:2:0	720/576/30	14 745 600	20	2 441 216	HP@ML
	1	Spatial	4:2:0	1440/1088/60	62 668 800	80	9 781 248	HP@H-14
2	0	Base	4:2:0	720/576/30	14 745 600	20	2 441 216	HP@ML
	1	Spatial	4:2:2	1440/1088/60	47 001 600	80	9 781 248	HP@H-14
2	0	Base	4:2:2	720/576/30	11 059 200	20	2 441 216	HP@ML
	1	Spatial	4:2:2	1440/1088/60	47 001 600	80	9 781 248	HP@H-14

Table E.40 – High profile @ High-1440 level (Base Layer + SNR + Spatial)

No. of layers	layer id	Scalable mode	Chroma Format	Maximum sample density (H/V/F)	Maximum sample rate	Maximum total bit rate /1000000	Maximum total VBV buffer	Profile and level indication
3	0	Base	4:2:0	352/288/30	3 041 280	3	360 448	SP@ML
	1	SNR	4:2:0	352/288/30	3 041 280	4	475 136	SNR@LL
	2	Spatial	4:2:0	1440/1088/60	62 668 800	80	9 781 248	HP@H-14
3	0	Base	4:2:0	352/288/30	3 041 280	3	360 448	SP@ML
	1	SNR	4:2:0	352/288/30	3 041 280	4	475 136	SNR@LL
	2	Spatial	4:2:2	1440/1088/60	47 001 600	80	9 781 248	HP@H-14
3	0	Base	4:2:0	720/576/30	10 368 000	10	1 212 416	SP@ML
	1	SNR	4:2:0	720/576/30	10 368 000	15	1 835 008	SNR@ML
	2	Spatial	4:2:0	1440/1088/60	62 668 800	80	9 781 248	HP@H-14
3	0	Base	4:2:0	720/576/30	10 368 000	10	1 212 416	SP@ML
	1	SNR	4:2:0	720/576/30	10 368 000	15	1 835 008	SNR@ML
	2	Spatial	4:2:2	1440/1088/60	47 001 600	80	9 781 248	HP@H-14
3	0	Base	4:2:0	352/288/30	3 041 280	3	360 448	MP@LL
	1	SNR	4:2:0	352/288/30	3 041 280	4	475 136	SNR@LL
	2	Spatial	4:2:0	1440/1088/60	62 668 800	80	9 781 248	HP@H-14
3	0	Base	4:2:0	352/288/30	3 041 280	3	360 448	MP@LL
	1	SNR	4:2:0	352/288/30	3 041 280	4	475 136	SNR@LL
	2	Spatial	4:2:2	1440/1088/60	47 001 600	80	9 781 248	HP@H-14
3	0	Base	4:2:0	720/576/30	10 368 000	10	1 212 416	MP@ML
	1	SNR	4:2:0	720/576/30	10 368 000	15	1 835 008	SNR@ML
	2	Spatial	4:2:0	1440/1088/60	62 668 800	80	9 781 248	HP@H-14
3	0	Base	4:2:0	720/576/30	10 368 000	10	1 212 416	MP@ML
	1	SNR	4:2:0	720/576/30	10 368 000	15	1 835 008	SNR@ML
	2	Spatial	4:2:2	1440/1088/60	47 001 600	80	9 781 248	HP@H-14
3	0	Base	4:2:0	720/576/30	10 368 000	15	1 835 008	MP@ML
	1	SNR	4:2:2	720/576/30	10 368 000	20	2 441 216	HP@ML
	2	Spatial	4:2:2	1440/1088/60	47 001 600	80	9 781 248	HP@H-14
3	0	Base	4:2:0	720/576/30	14 745 600	15	1 835 008	HP@ML
	1	SNR	4:2:0	720/576/30	14 745 600	20	2 441 216	HP@ML
	2	Spatial	4:2:2	1440/1088/60	47 001 600	80	9 781 248	HP@H-14
3	0	Base	4:2:0	720/576/30	11 059 200	15	1 835 008	HP@ML
	1	SNR	4:2:2	720/576/30	11 059 200	20	2 441 216	HP@ML
	2	Spatial	4:2:2	1440/1088/60	47 001 600	80	9 781 248	HP@H-14
3	0	Base	4:2:2	720/576/30	11 059 200	15	1 835 008	HP@ML
	1	SNR	4:2:2	720/576/30	11 059 200	20	2 441 216	HP@ML
	2	Spatial	4:2:2	1440/1088/60	47 001 600	80	9 781 248	HP@H-14

Table E.41 – High profile @ High-1440 level (Base Layer + Spatial + SNR)

No. of layers	layer id	Scalable mode	Chroma Format	Maximum sample density (H/V/F)	Maximum sample rate	Maximum total bit rate /1000000	Maximum total VBV buffer	Profile and level indication
3	0	Base	4:2:0	352/288/30	2 534 400	1.856	327 680	ISO 11172
	1	Spatial	4:2:0	1440/1088/60	47 001 600	60	7 340 032	Spt@H-14
	2	SNR	4:2:0	1440/1088/60	47 001 600	80	9 781 248	HP@H-14
3	0	Base	4:2:0	352/288/30	2 534 400	1.856	327 680	ISO 11172
	1	Spatial	4:2:0	1440/1088/60	47 001 600	60	7 340 032	Spt@H-14
	2	SNR	4:2:2	1440/1088/60	47 001 600	80	9 781 248	HP@H-14
3	0	Base	4:2:0	352/288/30	2 534 400	1.856	327 680	ISO 11172
	1	Spatial	4:2:0	1440/1088/60	62 668 800	60	7 340 032	HP@H-14
	2	SNR	4:2:0	1440/1088/60	62 668 800	80	9 781 248	HP@H-14
3	0	Base	4:2:0	352/288/30	2 534 400	1.856	327 680	ISO 11172
	1	Spatial	4:2:2	1440/1088/60	47 001 600	60	7 340 032	HP@H-14
	2	SNR	4:2:2	1440/1088/60	47 001 600	80	9 781 248	HP@H-14
3	0	Base	4:2:0	720/576/30	10 368 000	15	1 835 008	SP@ML
	1	Spatial	4:2:0	1440/1088/60	47 001 600	60	7 340 032	Spt@H-14
	2	SNR	4:2:0	1440/1088/60	47 001 600	80	9 781 248	HP@H-14
3	0	Base	4:2:0	720/576/30	10 368 000	15	1 835 008	SP@ML
	1	Spatial	4:2:0	1440/1088/60	47 001 600	60	7 340 032	Spt@H-14
	2	SNR	4:2:2	1440/1088/60	47 001 600	80	9 781 248	HP@H-14
3	0	Base	4:2:0	720/576/30	10 368 000	15	1 835 008	SP@ML
	1	Spatial	4:2:0	1440/1088/60	62 668 800	60	7 340 032	HP@H-14
	2	SNR	4:2:0	1440/1088/60	62 668 800	80	9 781 248	HP@H-14
3	0	Base	4:2:0	720/576/30	10 368 000	15	1 835 008	SP@ML
	1	Spatial	4:2:2	1440/1088/60	47 001 600	60	7 340 032	HP@H-14
	2	SNR	4:2:2	1440/1088/60	47 001 600	80	9 781 248	HP@H-14
3	0	Base	4:2:0	352/288/30	3 041 280	4	475 136	MP@LL
	1	Spatial	4:2:0	1440/1088/60	47 001 600	60	7 340 032	Spt@H-14
	2	SNR	4:2:0	1440/1088/60	47 001 600	80	9 781 248	HP@H-14
3	0	Base	4:2:0	352/288/30	3 041 280	4	475 136	MP@LL
	1	Spatial	4:2:0	1440/1088/60	47 001 600	60	7 340 032	Spt@H-14
	2	SNR	4:2:2	1440/1088/60	47 001 600	80	9 781 248	HP@H-14
3	0	Base	4:2:0	352/288/30	3 041 280	4	475 136	MP@LL
	1	Spatial	4:2:0	1440/1088/60	62 668 800	60	7 340 032	HP@H-14
	2	SNR	4:2:0	1440/1088/60	62 668 800	80	9 781 248	HP@H-14
3	0	Base	4:2:0	352/288/30	3 041 280	4	475 136	MP@LL
	1	Spatial	4:2:2	1440/1088/60	47 001 600	60	7 340 032	HP@H-14
	2	SNR	4:2:2	1440/1088/60	47 001 600	80	9 781 248	HP@H-14
3	0	Base	4:2:0	720/576/30	10 368 000	15	1 835 008	MP@ML
	1	Spatial	4:2:0	1440/1088/60	47 001 600	60	7 340 032	Spt@H-14
	2	SNR	4:2:0	1440/1088/60	47 001 600	80	9 781 248	HP@H-14

Table E.41 – High profile @ High-1440 level (Base Layer + Spatial + SNR) (concluded)

No. of layers	layer id	Scalable mode	Chroma Format	Maximum sample density (H/V/F)	Maximum sample rate	Maximum total bit rate /1000000	Maximum total VBV buffer	Profile and level indication
3	0	Base	4:2:0	720/576/30	10 368 000	15	1 835 008	MP@ML
	1	Spatial	4:2:0	1440/1088/60	47 001 600	60	7 340 032	Spt@H-14
	2	SNR	4:2:2	1440/1088/60	47 001 600	80	9 781 248	HP@H-14
3	0	Base	4:2:0	720/576/30	10 368 000	15	1 835 008	MP@ML
	1	Spatial	4:2:0	1440/1088/60	62 668 800	60	7 340 032	HP@H-14
	2	SNR	4:2:0	1440/1088/60	62 668 800	80	9 781 248	HP@H-14
3	0	Base	4:2:0	720/576/30	10 368 000	15	1 835 008	MP@ML
	1	Spatial	4:2:2	1440/1088/60	47 001 600	60	7 340 032	HP@H-14
	2	SNR	4:2:2	1440/1088/60	47 001 600	80	9 781 248	HP@H-14
3	0	Base	4:2:0	720/576/30	14 745 600	20	2 441 216	HP@ML
	1	Spatial	4:2:0	1440/1088/60	62 668 800	60	7 340 032	HP@H-14
	2	SNR	4:2:0	1440/1088/60	62 668 800	80	9 781 248	HP@H-14
3	0	Base	4:2:0	720/576/30	14 745 600	20	2 441 216	HP@ML
	1	Spatial	4:2:0	1440/1088/60	47 001 600	60	7 340 032	HP@H-14
	2	SNR	4:2:2	1440/1088/60	47 001 600	80	9 781 248	HP@H-14
3	0	Base	4:2:0	720/576/30	14 745 600	20	2 441 216	HP@ML
	1	Spatial	4:2:2	1440/1088/60	47 001 600	60	7 340 032	HP@H-14
	2	SNR	4:2:2	1440/1088/60	47 001 600	80	9 781 248	HP@H-14
3	0	Base	4:2:2	720/576/30	11 059 200	20	2 441 216	HP@ML
	1	Spatial	4:2:2	1440/1088/60	47 001 600	60	7 340 032	HP@H-14
	2	SNR	4:2:2	1440/1088/60	47 001 600	80	9 781 248	HP@H-14

Table E.42 – High profile @ High level (Base Layer)

No. of layers	layer id	Scalable mode	Chroma Format	Maximum sample density (H/V/F)	Maximum sample rate	Maximum total bit rate /1000000	Maximum total VBV buffer	Profile and level indication
1	0	Base	4:2:0	1920/1088/60	83 558 400	100	12 222 464	HP@HL
1	0	Base	4:2:2	1920/1088/60	62 668 800	100	12 222 464	HP@HL

Table E.43 – High profile @ High level (Base Layer + SNR)

No. of layers	layer id	Scalable mode	Chroma Format	Maximum sample density (H/V/F)	Maximum sample rate	Maximum total bit rate /1000000	Maximum total VBV buffer	Profile and level indication
2	0	Base	4:2:0	720/576/30	10 368 000	15	1 835 008	SP@ML
	1	SNR	4:2:0	720/576/30	10 368 000	100	12 222 464	HP@HL
2	0	Base	4:2:0	720/576/30	10 368 000	15	1 835 008	SP@ML
	1	SNR	4:2:2	720/576/30	10 368 000	100	12 222 464	HP@HL
2	0	Base	4:2:0	352/288/30	3 041 280	4	475 136	MP@LL
	1	SNR	4:2:0	352/288/30	3 041 280	100	12 222 464	HP@HL
2	0	Base	4:2:0	352/288/30	3 041 280	4	475 136	MP@LL
	1	SNR	4:2:2	352/288/30	3 041 280	100	12 222 464	HP@HL
2	0	Base	4:2:0	720/576/30	10 368 000	15	1 835 008	MP@ML
	1	SNR	4:2:0	720/576/30	10 368 000	100	12 222 464	HP@HL
2	0	Base	4:2:0	720/576/30	10 368 000	15	1 835 008	MP@ML
	1	SNR	4:2:2	720/576/30	10 368 000	100	12 222 464	HP@HL
2	0	Base	4:2:0	1440/1088/60	47 001 600	60	7 340 032	MP@H-14
	1	SNR	4:2:0	1440/1088/60	47 001 600	100	12 222 464	HP@HL
2	0	Base	4:2:0	1440/1088/60	47 001 600	60	7 340 032	MP@H-14
	1	SNR	4:2:2	1440/1088/60	47 001 600	100	12 222 464	HP@HL
2	0	Base	4:2:0	1920/1088/60	62 668 800	80	9 781 248	MP@HL
	1	SNR	4:2:0	1920/1088/60	62 668 800	100	12 222 464	HP@HL
2	0	Base	4:2:0	1920/1088/60	62 668 800	80	9 781 248	MP@HL
	1	SNR	4:2:2	1920/1088/60	62 668 800	100	12 222 464	HP@HL
2	0	Base	4:2:0	720/576/30	14 745 600	20	1 835 008	HP@ML
	1	SNR	4:2:0	720/576/30	14 745 600	100	12 222 464	HP@HL
2	0	Base	4:2:0	720/576/30	14 745 600	20	1 835 008	HP@ML
	1	SNR	4:2:2	720/576/30	14 745 600	100	12 222 464	HP@HL
2	0	Base	4:2:2	720/576/30	11 059 200	20	1 835 008	HP@ML
	1	SNR	4:2:2	720/576/30	11 059 200	100	12 222 464	HP@HL
2	0	Base	4:2:0	1440/1088/60	62 668 800	80	9 781 248	HP@H-14
	1	SNR	4:2:0	1440/1088/60	62 668 800	100	12 222 464	HP@HL
2	0	Base	4:2:0	1440/1088/60	62 668 800	80	9 781 248	HP@H-14
	1	SNR	4:2:2	1440/1088/60	62 668 800	100	12 222 464	HP@HL
2	0	Base	4:2:2	1440/1088/60	47 001 600	80	9 781 248	HP@H-14
	1	SNR	4:2:2	1440/1088/60	47 001 600	100	12 222 464	HP@HL
2	0	Base	4:2:0	1920/1088/60	83 558 400	80	9 781 248	HP@HL
	1	SNR	4:2:0	1920/1088/60	83 558 400	100	12 222 464	HP@HL
2	0	Base	4:2:0	1920/1088/60	62 668 800	80	9 781 248	HP@HL
	1	SNR	4:2:2	1920/1088/60	62 668 800	100	12 222 464	HP@HL
2	0	Base	4:2:2	1920/1088/60	62 668 800	80	9 781 248	HP@HL
	1	SNR	4:2:2	1920/1088/60	62 668 800	100	12 222 464	HP@HL

Table E.44 – High profile @ High level (Base Layer + Spatial)

No. of layers	layer id	Scalable mode	Chroma Format	Maximum sample density (H/V/F)	Maximum sample rate	Maximum total bit rate /1000000	Maximum total VBV buffer	Profile and level indication
2	0	Base	4:2:0	352/288/30	2 534 400	1.856	327 680	ISO 11172
	1	Spatial	4:2:0	1920/1088/60	83 558 400	100	12 222 464	HP@HL
2	0	Base	4:2:0	352/288/30	2 534 400	1.856	327 680	ISO 11172
	1	Spatial	4:2:2	1920/1088/60	62 668 800	100	12 222 464	HP@HL
2	0	Base	4:2:0	720/576/30	10 368 000	15	1 835 008	SP@ML
	1	Spatial	4:2:0	1920/1088/60	83 558 400	100	12 222 464	HP@HL
2	0	Base	4:2:0	720/576/30	10 368 000	15	1 835 008	SP@ML
	1	Spatial	4:2:2	1920/1088/60	62 668 800	100	12 222 464	HP@HL
2	0	Base	4:2:0	352/288/30	3 041 280	4	475 136	MP@LL
	1	Spatial	4:2:0	1920/1088/60	83 558 400	100	12 222 464	HP@HL
2	0	Base	4:2:0	352/288/30	3 041 280	4	475 136	MP@LL
	1	Spatial	4:2:2	1920/1088/60	62 668 800	100	12 222 464	HP@HL
2	0	Base	4:2:0	720/576/30	10 368 000	15	1 835 008	MP@ML
	1	Spatial	4:2:0	1920/1088/60	83 558 400	100	12 222 464	HP@HL
2	0	Base	4:2:0	720/576/30	10 368 000	15	1 835 008	MP@ML
	1	Spatial	4:2:2	1920/1088/60	62 668 800	100	12 222 464	HP@HL
2	0	Base	4:2:0	960/576/30	19 660 800	25	3 047 424	MP@H-14
	1	Spatial	4:2:0	1920/1088/60	83 558 400	100	12 222 464	HP@HL
2	0	Base	4:2:0	960/576/30	19 660 800	25	3 047 424	MP@H-14
	1	Spatial	4:2:2	1920/1088/60	62 668 800	100	12 222 464	HP@HL
2	0	Base	4:2:0	720/576/30	14 745 600	20	2 441 216	HP@ML
	1	Spatial	4:2:0	1920/1088/60	83 558 400	100	12 222 464	HP@HL
2	0	Base	4:2:0	720/576/30	14 745 600	20	2 441 216	HP@ML
	1	Spatial	4:2:2	1920/1088/60	62 668 800	100	12 222 464	HP@HL
2	0	Base	4:2:2	720/576/30	11 059 200	20	2 441 216	HP@ML
	1	Spatial	4:2:2	1920/1088/60	62 668 800	100	12 222 464	HP@HL
2	0	Base	4:2:0	960/576/30	19 660 800	25	3 047 424	HP@H-14
	1	Spatial	4:2:0	1920/1088/60	83 558 400	100	12 222 464	HP@HL
2	0	Base	4:2:0	960/576/30	19 660 800	25	3 047 424	HP@H-14
	1	Spatial	4:2:2	1920/1088/60	62 668 800	100	12 222 464	HP@HL
2	0	Base	4:2:2	960/576/30	14 745 600	25	3 047 424	HP@H-14
	1	Spatial	4:2:2	1920/1088/60	62 668 800	100	12 222 464	HP@HL

Table E.45 – High profile @ High level (Base Layer + SNR + Spatial)

No. of layers	layer id	Scalable mode	Chroma Format	Maximum sample density (H/V/F)	Maximum sample rate	Maximum total bit rate /1000000	Maximum total VBV buffer	Profile and level indication
3	0	Base	4:2:0	352/288/30	3 041 280	3	360 448	SP@ML
	1	SNR	4:2:0	352/288/30	3 041 280	4	475 136	SNR@LL
	2	Spatial	4:2:0	1920/1088/60	83 558 400	100	12 222 464	HP@HL
3	0	Base	4:2:0	352/288/30	3 041 280	3	360 448	SP@ML
	1	SNR	4:2:0	352/288/30	3 041 280	4	475 136	SNR@LL
	2	Spatial	4:2:2	1920/1088/60	83 558 400	100	12 222 464	HP@HL
3	0	Base	4:2:0	720/576/30	10 368 000	10	1 212 416	SP@ML
	1	SNR	4:2:0	720/576/30	10 368 000	15	1 835 008	SNR@ML
	2	Spatial	4:2:0	1920/1088/60	83 558 400	100	12 222 464	HP@HL
3	0	Base	4:2:0	720/576/30	10 368 000	10	1 212 416	SP@ML
	1	SNR	4:2:0	720/576/30	10 368 000	15	1 835 008	SNR@ML
	2	Spatial	4:2:2	1920/1088/60	62 668 800	100	12 222 464	HP@HL
3	0	Base	4:2:0	720/576/30	10 368 000	15	1 835 008	SP@ML
	1	SNR	4:2:2	720/576/30	10 368 000	20	2 441 216	HP@ML
	2	Spatial	4:2:2	1920/1088/60	62 668 800	100	12 222 464	HP@HL
3	0	Base	4:2:0	352/288/30	3 041 280	3	360 448	MP@LL
	1	SNR	4:2:0	352/288/30	3 041 280	4	475 136	SNR@LL
	2	Spatial	4:2:0	1920/1088/60	83 558 400	100	12 222 464	HP@HL
3	0	Base	4:2:0	352/288/30	3 041 280	3	360 448	MP@LL
	1	SNR	4:2:0	352/288/30	3 041 280	4	475 136	SNR@LL
	2	Spatial	4:2:2	1920/1088/60	62 668 800	100	12 222 464	HP@HL
3	0	Base	4:2:0	720/576/30	10 368 000	10	1 212 416	MP@ML
	1	SNR	4:2:0	720/576/30	10 368 000	15	1 835 008	SNR@ML
	2	Spatial	4:2:0	1920/1088/60	83 558 400	100	12 222 464	HP@HL
3	0	Base	4:2:0	720/576/30	10 368 000	10	1 212 416	MP@ML
	1	SNR	4:2:0	720/576/30	10 368 000	15	1 835 008	SNR@ML
	2	Spatial	4:2:2	1920/1088/60	62 668 800	100	12 222 464	HP@HL
3	0	Base	4:2:0	720/576/30	10 368 000	15	1 835 008	MP@ML
	1	SNR	4:2:2	720/576/30	10 368 000	20	2 441 216	HP@ML
	2	Spatial	4:2:2	1920/1088/60	62 668 800	100	12 222 464	HP@HL
3	0	Base	4:2:0	960/576/30	19 660 800	20	2 441 216	MP@H-14
	1	SNR	4:2:0	960/576/30	19 660 800	25	3 047 424	Spt@H-14
	2	Spatial	4:2:0	1920/1088/60	83 558 400	100	12 222 464	HP@HL
3	0	Base	4:2:0	960/576/30	19 660 800	20	2 441 216	MP@H-14
	1	SNR	4:2:0	960/576/30	19 660 800	25	3 047 424	Spt@H-14
	2	Spatial	4:2:2	1920/1088/60	62 668 800	100	12 222 464	HP@HL
3	0	Base	4:2:0	960/576/30	14 745 600	20	2 441 216	MP@H-14
	1	SNR	4:2:2	960/576/30	14 745 600	25	3 047 424	HP@H-14
	2	Spatial	4:2:2	1920/1088/60	62 668 800	100	12 222 464	HP@HL

Table E.45 – High profile @ High level (Base Layer + SNR + Spatial) (concluded)

No. of layers	layer id	Scalable mode	Chroma Format	Maximum sample density (H/V/F)	Maximum sample rate	Maximum total bit rate /1000000	Maximum total VBV buffer	Profile and level indication
3	0	Base	4:2:0	720/576/30	14 745 600	15	1 835 008	HP@ML
	1	SNR	4:2:0	720/576/30	14 745 600	20	2 441 216	HP@ML
	2	Spatial	4:2:0	1920/1088/60	83 558 400	100	12 222 464	HP@HL
3	0	Base	4:2:0	720/576/30	14 745 600	15	1 835 008	HP@ML
	1	SNR	4:2:0	720/576/30	14 745 600	20	2 441 216	HP@ML
	2	Spatial	4:2:2	1920/1088/60	62 668 800	100	12 222 464	HP@HL
3	0	Base	4:2:0	720/576/30	11 059 200	15	1 835 008	HP@ML
	1	SNR	4:2:2	720/576/30	11 059 200	20	2 441 216	HP@ML
	2	Spatial	4:2:2	1920/1088/60	62 668 800	100	12 222 464	HP@HL
3	0	Base	4:2:2	720/576/30	11 059 200	15	1 835 008	HP@ML
	1	SNR	4:2:2	720/576/30	11 059 200	20	2 441 216	HP@ML
	2	Spatial	4:2:2	1920/1088/60	62 668 800	100	12 222 464	HP@HL
3	0	Base	4:2:0	960/576/30	19 660 800	20	2 441 216	HP@H-14
	1	SNR	4:2:0	960/576/30	19 660 800	25	3 047 424	HP@H-14
	2	Spatial	4:2:0	1920/1088/60	83 558 400	100	12 222 464	HP@HL
3	0	Base	4:2:0	960/576/30	19 660 800	20	2 441 216	HP@H-14
	1	SNR	4:2:0	960/576/30	19 660 800	25	3 047 424	HP@H-14
	2	Spatial	4:2:2	1920/1088/60	62 668 800	100	12 222 464	HP@HL
3	0	Base	4:2:0	960/576/30	14 745 600	20	2 441 216	HP@H-14
	1	SNR	4:2:2	960/576/30	14 745 600	25	3 047 424	HP@H-14
	2	Spatial	4:2:2	1920/1088/60	62 668 800	100	12 222 464	HP@HL
3	0	Base	4:2:2	960/576/30	14 745 600	20	2 441 216	HP@H-14
	1	SNR	4:2:2	960/576/30	14 745 600	25	3 047 424	HP@H-14
	2	Spatial	4:2:2	1920/1088/60	62 668 800	100	12 222 464	HP@HL

Table E.46 – High profile @ High level (Base Layer + Spatial + SNR)

No. of layers	layer id	Scalable mode	Chroma Format	Maximum sample density (H/V/F)	Maximum sample rate	Maximum total bit rate /1000000	Maximum total VBV buffer	Profile and level indication
3	0	Base	4:2:0	352/288/30	2 534 400	1.856	327 680	ISO 11172
	1	Spatial	4:2:0	1440/1088/60	47 001 600	60	7 340 032	Spt@H-14
	2	SNR	4:2:0	1440/1088/60	47 001 600	100	12 222 464	HP@HL
3	0	Base	4:2:0	352/288/30	2 534 400	1.856	327 680	ISO 11172
	1	Spatial	4:2:0	1440/1088/60	47 001 600	60	7 340 032	Spt@H-14
	2	SNR	4:2:2	1440/1088/60	47 001 600	100	12 222 464	HP@HL
3	0	Base	4:2:0	352/288/30	2 534 400	1.856	327 680	ISO 11172
	1	Spatial	4:2:0	720/576/30	14 745 600	20	2 441 216	HP@ML
	2	SNR	4:2:0	720/576/30	14 745 600	100	12 222 464	HP@HL
3	0	Base	4:2:0	352/288/30	2 534 400	1.856	327 680	ISO 11172
	1	Spatial	4:2:0	720/576/30	14 745 600	20	2 441 216	HP@ML
	2	SNR	4:2:2	720/576/30	14 745 600	100	12 222 464	HP@HL
3	0	Base	4:2:0	352/288/30	2 534 400	1.856	327 680	ISO 11172
	1	Spatial	4:2:2	720/576/30	11 059 200	20	2 441 216	HP@ML
	2	SNR	4:2:2	720/576/30	11 059 200	100	12 222 464	HP@HL
3	0	Base	4:2:0	352/288/30	2 534 400	1.856	327 680	ISO 11172
	1	Spatial	4:2:0	1440/1088/60	62 668 800	80	9 781 248	HP@H-14
	2	SNR	4:2:0	1440/1088/60	62 668 800	100	12 222 464	HP@HL
3	0	Base	4:2:0	352/288/30	2 534 400	1.856	327 680	ISO 11172
	1	Spatial	4:2:0	1440/1088/60	62 668 800	80	9 781 248	HP@H-14
	2	SNR	4:2:2	1440/1088/60	62 668 800	100	12 222 464	HP@HL
3	0	Base	4:2:0	352/288/30	2 534 400	1.856	327 680	ISO 11172
	1	Spatial	4:2:2	1440/1088/60	47 001 600	80	9 781 248	HP@H-14
	2	SNR	4:2:2	1440/1088/60	47 001 600	100	12 222 464	HP@HL
3	0	Base	4:2:0	352/288/30	2 534 400	1.856	327 680	ISO 11172
	1	Spatial	4:2:0	1920/1088/60	83 558 400	80	9 781 248	HP@HL
	2	SNR	4:2:0	1920/1088/60	83 558 400	100	12 222 464	HP@HL
3	0	Base	4:2:0	352/288/30	2 534 400	1.856	327 680	ISO 11172
	1	Spatial	4:2:0	1920/1088/60	62 668 800	80	9 781 248	HP@HL
	2	SNR	4:2:2	1920/1088/60	62 668 800	100	12 222 464	HP@HL
3	0	Base	4:2:0	352/288/30	2 534 400	1.856	327 680	ISO 11172
	1	Spatial	4:2:2	1920/1088/60	62 668 800	80	9 781 248	HP@HL
	2	SNR	4:2:2	1920/1088/60	62 668 800	100	12 222 464	HP@HL
3	0	Base	4:2:0	720/576/30	10 368 000	15	1 835 008	SP@ML
	1	Spatial	4:2:0	1440/1088/60	47 001 600	60	7 340 032	Spt@H-14
	2	SNR	4:2:0	1440/1088/60	47 001 600	100	12 222 464	HP@HL
3	0	Base	4:2:0	720/576/30	10 368 000	15	1 835 008	SP@ML
	1	Spatial	4:2:0	1440/1088/60	47 001 600	60	7 340 032	Spt@H-14
	2	SNR	4:2:2	1440/1088/60	47 001 600	100	12 222 464	HP@HL

Table E.46 – High profile @ High level (Base Layer + Spatial + SNR) (continued)

No. of layers	layer id	Scalable mode	Chroma Format	Maximum sample density (H/V/F)	Maximum sample rate	Maximum total bit rate /1000000	Maximum total VBV buffer	Profile and level indication
3	0	Base	4:2:0	720/576/30	10 368 000	15	1 835 008	SP@ML
	1	Spatial	4:2:0	1440/1088/60	62 668 800	80	9 781 248	HP@H-14
	2	SNR	4:2:0	1440/1088/60	62 668 800	100	12 222 464	HP@HL
3	0	Base	4:2:0	720/576/30	10 368 000	15	1 835 008	SP@ML
	1	Spatial	4:2:0	1440/1088/60	62 668 800	80	9 781 248	HP@H-14
	2	SNR	4:2:2	1440/1088/60	62 668 800	100	12 222 464	HP@HL
3	0	Base	4:2:0	720/576/30	10 368 000	15	1 835 008	SP@ML
	1	Spatial	4:2:2	1440/1088/60	47 001 600	80	9 781 248	HP@H-14
	2	SNR	4:2:2	1440/1088/60	47 001 600	100	12 222 464	HP@HL
3	0	Base	4:2:0	720/576/30	10 368 000	15	1 835 008	SP@ML
	1	Spatial	4:2:0	1920/1088/60	83 558 400	80	9 781 248	HP@HL
	2	SNR	4:2:0	1920/1088/60	83 558 400	100	12 222 464	HP@HL
3	0	Base	4:2:0	720/576/30	10 368 000	15	1 835 008	SP@ML
	1	Spatial	4:2:0	1920/1088/60	62 668 800	80	9 781 248	HP@HL
	2	SNR	4:2:2	1920/1088/60	62 668 800	100	12 222 464	HP@HL
3	0	Base	4:2:0	720/576/30	10 368 000	15	1 835 008	SP@ML
	1	Spatial	4:2:2	1920/1088/60	62 668 800	80	9 781 248	HP@HL
	2	SNR	4:2:2	1920/1088/60	62 668 800	100	12 222 464	HP@HL
3	0	Base	4:2:0	352/288/30	3 041 280	4	475 136	MP@LL
	1	Spatial	4:2:0	1440/1088/60	47 001 600	60	7 340 032	Spt@H-14
	2	SNR	4:2:0	1440/1088/60	47 001 600	100	12 222 464	HP@HL
3	0	Base	4:2:0	352/288/30	3 041 280	4	475 136	MP@LL
	1	Spatial	4:2:0	1440/1088/60	47 001 600	60	7 340 032	Spt@H-14
	2	SNR	4:2:2	1440/1088/60	47 001 600	100	12 222 464	HP@HL
3	0	Base	4:2:0	352/288/30	3 041 280	4	475 136	MP@LL
	1	Spatial	4:2:0	720/576/30	14 745 600	20	2 441 216	HP@ML
	2	SNR	4:2:0	720/576/30	14 745 600	100	12 222 464	HP@HL
3	0	Base	4:2:0	352/288/30	3 041 280	4	475 136	MP@LL
	1	Spatial	4:2:0	720/576/30	14 745 600	20	2 441 216	HP@ML
	2	SNR	4:2:2	720/576/30	14 745 600	100	12 222 464	HP@HL
3	0	Base	4:2:0	352/288/30	3 041 280	4	475 136	MP@LL
	1	Spatial	4:2:2	720/576/30	11 059 200	20	2 441 216	HP@ML
	2	SNR	4:2:2	720/576/30	11 059 200	100	12 222 464	HP@HL
3	0	Base	4:2:0	352/288/30	3 041 280	4	475 136	MP@LL
	1	Spatial	4:2:0	1440/1088/60	62 668 800	80	9 781 248	HP@H-14
	2	SNR	4:2:0	1440/1088/60	62 668 800	100	12 222 464	HP@HL
3	0	Base	4:2:0	352/288/30	3 041 280	4	475 136	MP@LL
	1	Spatial	4:2:0	1440/1088/60	62 668 800	80	9 781 248	HP@H-14
	2	SNR	4:2:2	1440/1088/60	62 668 800	100	12 222 464	HP@HL

Table E.46 – High profile @ High level (Base Layer + Spatial + SNR) (continued)

No. of layers	layer id	Scalable mode	Chroma Format	Maximum sample density (H/V/F)	Maximum sample rate	Maximum total bit rate /1000000	Maximum total VBV buffer	Profile and level indication
3	0	Base	4:2:0	352/288/30	3 041 280	4	475 136	MP@LL
	1	Spatial	4:2:2	1440/1088/60	47 001 600	80	9 781 248	HP@H-14
	2	SNR	4:2:2	1440/1088/60	62 668 800	100	12 222 464	HP@HL
3	0	Base	4:2:0	352/288/30	3 041 280	4	475 136	MP@LL
	1	Spatial	4:2:0	1920/1088/60	83 558 400	80	9 781 248	HP@HL
	2	SNR	4:2:0	1920/1088/60	83 558 400	100	12 222 464	HP@HL
3	0	Base	4:2:0	352/288/30	3 041 280	4	475 136	MP@LL
	1	Spatial	4:2:0	1920/1088/60	62 668 800	80	9 781 248	HP@HL
	2	SNR	4:2:2	1920/1088/60	62 668 800	100	12 222 464	HP@HL
3	0	Base	4:2:0	352/288/30	3 041 280	4	475 136	MP@LL
	1	Spatial	4:2:2	1920/1088/60	62 668 800	80	9 781 248	HP@HL
	2	SNR	4:2:2	1920/1088/60	62 668 800	100	12 222 464	HP@HL
3	0	Base	4:2:0	720/576/30	10 368 000	15	1 835 008	MP@ML
	1	Spatial	4:2:0	1440/1088/60	47 001 600	60	7 340 032	Spt@H-14
	2	SNR	4:2:0	1440/1088/60	47 001 600	100	12 222 464	HP@HL
3	0	Base	4:2:0	720/576/30	10 368 000	15	1 835 008	MP@ML
	1	Spatial	4:2:0	1440/1088/60	47 001 600	60	7 340 032	Spt@H-14
	2	SNR	4:2:2	1440/1088/60	47 001 600	100	12 222 464	HP@HL
3	0	Base	4:2:0	720/576/30	10 368 000	15	1 835 008	MP@ML
	1	Spatial	4:2:0	1440/1088/60	62 668 800	80	9 781 248	HP@H-14
	2	SNR	4:2:0	1440/1088/60	62 668 800	100	12 222 464	HP@HL
3	0	Base	4:2:0	720/576/30	10 368 000	15	1 835 008	MP@ML
	1	Spatial	4:2:0	1440/1088/60	62 668 800	80	9 781 248	HP@H-14
	2	SNR	4:2:2	1440/1088/60	62 668 800	100	12 222 464	HP@HL
3	0	Base	4:2:0	720/576/30	10 368 000	15	1 835 008	MP@ML
	1	Spatial	4:2:2	1440/1088/60	47 001 600	80	9 781 248	HP@H-14
	2	SNR	4:2:2	1440/1088/60	47 001 600	100	12 222 464	HP@HL
3	0	Base	4:2:0	720/576/30	10 368 000	15	1 835 008	MP@ML
	1	Spatial	4:2:0	1920/1088/60	83 558 400	80	9 781 248	HP@HL
	2	SNR	4:2:0	1920/1088/60	83 558 400	100	12 222 464	HP@HL
3	0	Base	4:2:0	720/576/30	10 368 000	15	1 835 008	MP@ML
	1	Spatial	4:2:0	1920/1088/60	62 668 800	80	9 781 248	HP@HL
	2	SNR	4:2:2	1920/1088/60	62 668 800	100	12 222 464	HP@HL
3	0	Base	4:2:0	720/576/30	10 368 000	15	1 835 008	MP@ML
	1	Spatial	4:2:2	1920/1088/60	62 668 800	80	9 781 248	HP@HL
	2	SNR	4:2:2	1920/1088/60	62 668 800	100	12 222 464	HP@HL
3	0	Base	4:2:0	960/576/30	19 660 800	25	3 047 424	HP@H-14
	1	Spatial	4:2:0	1920/1088/60	83 558 400	80	9 781 248	HP@HL
	2	SNR	4:2:0	1920/1088/60	83 558 400	100	12 222 464	HP@HL

Table E.46 – High profile @ High level (Base Layer + Spatial + SNR) (concluded)

No. of layers	layer id	Scalable mode	Chroma Format	Maximum sample density (H/V/F)	Maximum sample rate	Maximum total bit rate /1000000	Maximum total VBV buffer	Profile and level indication
3	0	Base	4:2:0	960/576/30	19 660 800	25	3 047 424	HP@H-14
	1	Spatial	4:2:0	1920/1088/60	62 668 800	80	9 781 248	HP@HL
	2	SNR	4:2:2	1920/1088/60	62 668 800	100	12 222 464	HP@HL
3	0	Base	4:2:0	960/576/30	19 660 800	25	3 047 424	HP@H-14
	1	Spatial	4:2:2	1920/1088/60	62 668 800	80	9 781 248	HP@HL
	2	SNR	4:2:2	1920/1088/60	62 668 800	100	12 222 464	HP@HL
3	0	Base	4:2:2	960/576/30	14 745 600	25	3 047 424	HP@H-14
	1	Spatial	4:2:2	1920/1088/60	62 668 800	80	9 781 248	HP@HL
	2	SNR	4:2:2	1920/1088/60	62 668 800	100	12 222 464	HP@HL

Table E.47 – Multi-view profile @ Low level

No. of layers	layer id	Scalable mode	Maximum sample density (H/V/F)	Maximum sample rate	Maximum total bit rate /1000000	Maximum total VBV buffer	Profile and level indication
2	0	Base	352/288/30	3 041 280	4	475 136	MP@LL
	1	Temporal	352/288/30	3 041 280	8	950 272	MVP@LL

Table E.48 – Multi-view profile @ Main level

No. of layers	layer id	Scalable mode	Maximum sample density (H/V/F)	Maximum sample rate	Maximum total bit rate /1000000	Maximum total VBV buffer	Profile and level indication
2	0	Base	720/576/30	10 368 000	15	1 835 008	SP@ML
	1	Temporal	720/576/30	10 368 000	25	3 047 424	MVP@ML
2	0	Base	720/576/30	10 368 000	15	1 835 008	MP@ML
	1	Temporal	720/576/30	10 368 000	25	3 047 424	MVP@ML

Table E.49 – Multi-view profile @ High-1440 level

No. of layers	layer id	Scalable mode	Maximum sample density (H/V/F)	Maximum sample rate	Maximum total bit rate /1000000	Maximum total VBV buffer	Profile and level indication
2	0	Base	1440/1088/60	47 001 600	60	7 340 032	MP@H-14
	1	Temporal	1440/1088/60	47 001 600	100	12 222 464	MVP@H-14

Table E.50 – Multi-view profile @ High level

No. of layers	layer id	Scalable mode	Maximum sample density (H/V/F)	Maximum sample rate	Maximum total bit rate /1000000	Maximum total VBV buffer	Profile and level indication
2	0	Base	1920/1088/60	62 668 800	80	9 781 248	MP@HL
	1	Temporal	1920/1088/60	62 668 800	130	15 898 480	MVP@HL

Annex F

Bibliography

(This annex does not form an integral part of this Recommendation | International Standard)

- [1] NETRAVALI (A.N.) and HASKELL (B.G.): Digital Pictures, representation and compression, *Plenum Press*, 1988.
- [2] LEGALL (D.): MPEG: A Video Compression Standard for Multimedia Applications, *Trans. ACM*, April 1991.
- [3] LOEFFLER (C.), LIGTENBERG (A.), MOSCHYTZ (G.S.): Practical fast 1-D DCT algorithms with 11 multiplications, *Proceedings IEEE ICASSP-89*, Vol. 2, pp. 988-991, February 1989.
- [4] See the Normative Reference for ITU-R Recommendation BT.601.
- [5] See the Normative Reference for IEC Publication 60461.
- [6] See the Normative Reference for Recommendation H.261.
- [7] See the Normative reference for IEEE Standard Specification P1180-1990.
- [8] CCITT Recommendation T.81 (1992) | ISO/IEC 10918-1:1994 (Previously JPEG).
- [9] VISCITO (E.) and GONZALES (C.): A Video Compression Algorithm with Adaptive Bit Allocation and Quantization, *Proc. SPIE Visual Communications and Image Proc 91*, Vol. 1605 205, Boston, MA, 10-15 November 1991.
- [10] PURI (A.) and ARAVIND (R.): Motion Compensated Video Coding with Adaptive Perceptual Quantization, *IEEE Trans. on Circuits and Systems for Video Technology*, Vol. 1, pp. 351, December 1991.
- [11] GONZALES (C.) and VISCITO (E.): Flexibly scalable digital video coding, *Image Communications*, Vol. 5, Nos. 1-2, February 1993.
- [12] JOHNSON (A.W.), SIKORA (T.) and TAN (T.K.): Filters for Drift Reduction in Frequency Scalable Video Coding Schemes, *Transmitted for publication to Electronic Letters*.
- [13] MOKRY (R.) and ANASTASSIOU (D.): Minimal Error Drift in Frequency Scalability for Motion-Compensated DCT Coding, *IEEE Transactions on Circuits and Systems for Video Technology*, Vol. 4, No. 4, pp. 392-407, August 1994.
- [14] NGAN (K.N.), ARNOLD (J.), SIKORA (T.), TAN (T.K.) and JOHNSON (A.W.): Frequency Scalability Experiments for MPEG-2 Standard, *Asia-Pacific Conference on Communications*, Korea, August 1993.
- [15] SIKORA (T.), TAN (T.K.) and NGAN (K.N.): A Performance Comparison of Frequency Domain Pyramid Scalable Coding Schemes Within the MPEG Framework, *Proc. PCS, Picture Coding Symposium*, pp. 16.1-16.2, March 1993, Lausanne, Switzerland.
- [16] IWAHASHI (M.): Motion Compensation Technique for 2:1 Scaled-down Moving Pictures. 8-14, *Picture Coding Symposium 93*.
- [17] SIKORA, (T.) and PANG, (K.): Experiments with Optimal Block-Overlapping Filters for Cell Loss Concealment in Packet Video, *Proc. IEEE Visual Signal Processing and Communications Workshop*, pp. 247-250, 21-22 September 1993, Melbourne.
- [18] PURI (A.): Video Coding Using the MPEG-2 Compression Standard, *Proc. SPIE Visual Communications and Image Proc. 93*, Boston, MA, November 1993.
- [19] PURI (A.) and WONG (A.): Spatial Domain Resolution Scalable Video Coding, *Proc. SPIE Visual Communications and Image Proc. 93*, Boston, MA, November 1993.

Annex G

Registration Procedure

(This annex does not form an integral part of this Recommendation | International Standard)

G.1 Procedure for the request of a Registered Identifier (RID)

Requesters of an RID shall apply to the Registration Authority. Registration forms shall be available from the Registration Authority. Information which the requester shall provide is given in G.3. Companies and organizations are eligible to apply.

G.2 Responsibilities of the Registration Authority

The primary responsibilities of the Registration Authority administrating the registration of copyright_identifiers is outlined in this subclause; certain other responsibilities may be found in the JTC 1 Directives. The Registration Authority shall:

- a) implement a registration procedure for application for a unique RID in accordance with Annex H of the JTC 1 Directives;
- b) receive and process the applications for allocation of the work type code identifier from Copyright Registration Authority;
- c) ascertain which applications received are in accordance with this registration procedure, and to inform the requester within 30 days of receipt of the application of their assigned RID;
- d) inform application providers whose request is denied in writing within 30 days of receipt of the application, and also inform the requesting party of the appeals process;
- e) maintain an accurate register of the allocated RID. Revisions to the contact information and technical specifications shall be accepted and maintained by the Registration Authority;
- f) make the contents of this register available upon request to any interested party;
- g) maintain a database of RID request forms, granted and denied. Parties seeking technical information on the format of private data which has a copyright_identifier shall have access to such information which is part of the database maintained by the Registration Authority;
- h) report its activities to JTC 1, the ITTF, and the JTC 1/SC 29 Secretariat, or their respective assignees, annually on a schedule mutually agreed upon.

G.2.1 Contact information of the Registration Authority

Organization Name:

Address:

Telephone:

Fax:

G.3 Responsibilities of parties requesting an RID

The party requesting an RID for the purpose of copyright identification shall:

- a) apply using the form and procedures supplied by the Registration Authority;
- b) provide contact information describing how a complete description of the copyright organization can be obtained on a non-discriminatory basis;
- c) include technical details of the syntax and semantics of the data format used to describe the audiovisual works or other copyrighted works within the additional_copyright_info field. Once registered, the syntax used for the additional copyright information shall not change;
- d) agree to institute the intended use of the granted copyright_identifier within a reasonable time-frame;
- e) maintain a permanent record of the application form and the notification received from the Registration Authority of each granted copyright_identifier.

G.4 Appeal procedure for denied applications

The Registration Management Group is formed to have jurisdiction over appeals relating to a denied request for an RID. The RMG shall have a membership who are nominated by P and L members of the ISO technical body responsible for this Recommendation | International Standard. It shall have a convenor and secretariat nominated from its members. The Registration Authority is entitled to nominate one non-voting observing member.

The responsibilities of the RMG shall be:

- a) to review and act on all appeals within a reasonable time-frame;
- b) to inform, in writing, organizations which make an appeal for reconsideration of its petition of the RMG's disposition of the matter;
- c) to review the annual report of the Registration Authority summary of activities;
- d) to supply ISO member bodies with information concerning the scope of operation of the Registration Authority.

Annex H

Registration Application Form

(This annex does not form an integral part of this Recommendation | International Standard)

H.1 Contact information of organization requesting a Registered Identifier (RID)

Organization Name:

Address:

Telephone:

Fax:

E-mail:

H.2 Statement of an intention to apply the assigned RID

RID application domain: using guidelines to be provided by the Registration Authority.

H.3 Date of intended implementation of the RID

H.4 Authorized representative

Name:

Title:

Address:

Signature _____

H.5 For official use only of the Registration Authority

Registration Rejected _____

Reason for rejection of the application:

Registration Granted _____ Registration Value _____

Attachment 1 – Attachment of technical details of the registered data format.

Attachment 2 – Attachment of notification of appeal procedure for rejected applications.

Annex I

(This annex does not form an integral part of this Recommendation | International Standard)

**Registration Authority
Diagram of administration structure**

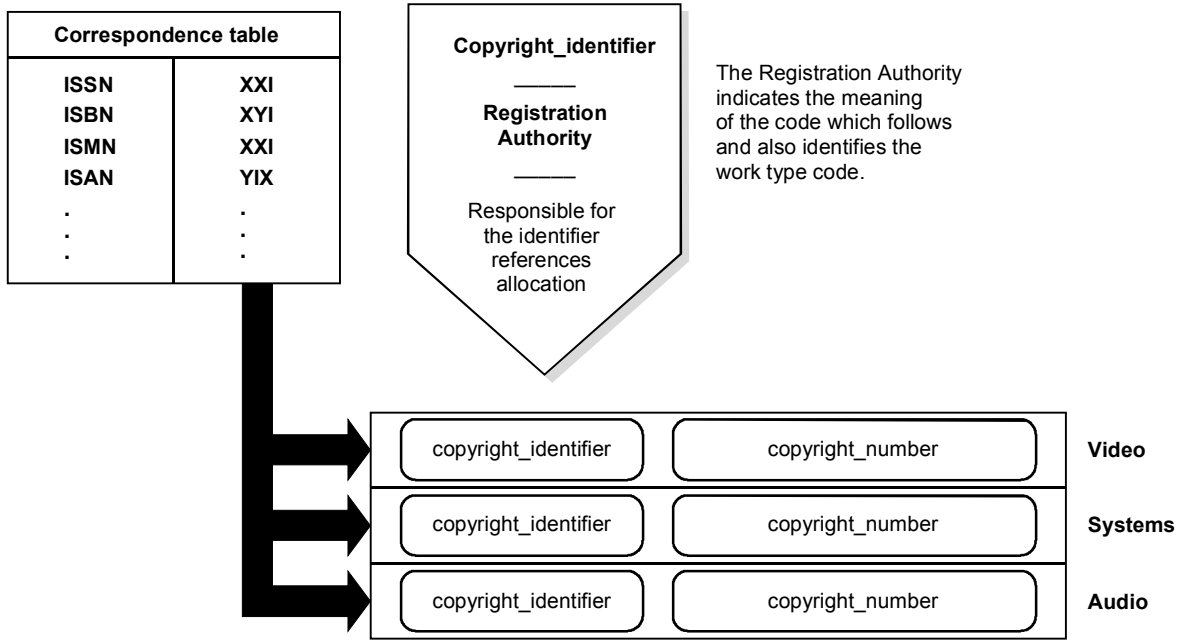

T1521020-96/d47

Examples



T1521030-96/d48

All the copyright_identifiers are registered by the Registration Authority, uniquely for copyright_numbers standardized by ISO. Each organization which allocates copyright_numbers, requests a specific copyright_identifier from the Registration Authority, e.g. Staatsbibliothek Preussischer Kulturbesitz, designated by ISO to manage I.S.B.N., asks for a specific copyright_identifier from the R.A. for book numbering.

Annex J

4:2:2 Profile test results

(This annex does not form an integral part of this Recommendation | International Standard)

J.1 Introduction

This annex provides guidance to users regarding the applicability of the 4:2:2 Profile at Main Level to applications which may require:

- higher quality than Main Profile at Main Level;
- better chroma resolution than Main Profile at Main Level;
- post processing after compression and decompression;
- multiple generations of compression and decompression;
- short Group of Pictures (GOP) for editability;
- capability to pass all active video;
- capability to pass vertical blanking interval information.

It should be noted that application of this Profile is an area of ongoing progress. Results presented here reflect varying degrees of algorithm refinement, so further improvement can be expected.

J.1.1 Test sequences

The test sequences were generated using computer simulation of the ITU-T Rec. H.262 | ISO/IEC 13818-2 compression and decompression. For 525/60, the test material included:

- Gwen;
- Trailblazers;
- Mobile and Calendar;
- Dissolve.

For 625/50, the test material included:

- Balls of Wool;
- Cactus and Comb;
- Basketball;
- Wall;
- Renata and Butterfly;
- Mobile and Calendar.

"Gwen" is a chroma key test sequence with a woman in the foreground keyed over a forest scene in the background. "Gwen" is a difficult sequence to chroma key but an easy sequence to compress. Both "Cactus and Comb" and "Balls of Wool" are chroma key sequences which were used with a coloured background. "Trailblazers" is a rapid motion basketball sequence shot with an unshuttered CCD camera. "Basketball" is also a rapid motion sports sequence. Both are typical program material and moderately difficult to compress. "Wall" consists of a woman standing in front of a wall made of many small stones. "Renata" consists of a woman in front of a complex background with a dissolve to a complex image of butterflies. "Mobile and Calendar" is a particularly difficult compression test sequence with saturated colours and complex motion. "Dissolve" consists of two segments of "Mobile and Calendar" with a one second fade between the two segments and is also difficult to compress.

Test sequences were supplied by:

- ITU-R;
- Portland Trailblazers;
- SMPTE;
- Tektronix.

J.1.2 Test procedures

MPEG has conducted experiments to verify the performance of the 4:2:2 Profile. The results of those experiments are presented here. There are separate tests for 525/60 and 625/50. The 525/60 tests explore a broad range of data rates and GOP structures, while the 625/50 tests include more variety of test material but less combinations of data rate, GOP structure, and number of generations. The parameters chosen for the experiments are for example only, and do not cover the entire range of allowed parameter values. The examples are not intended as specific recommendations. Each application should use the combination of parameters that is most appropriate, depending on its requirements for quality, editability, and cost.

The tests include both a single generation and eight generations of cascaded compression and decompression. For the eight generation tests, separate tests were done with no shifts, with two spatial shifts, and with two temporal shifts. Spatial shifting means that the picture was shifted horizontally and vertically by two pixels and two spatial lines between the first and second generations and then back between the fifth and sixth generations. Spatial shifting represents the effects of picture repositioning which might occur in a DVE. Temporal shifting means that the GOP structure was shifted one frame between the first and second generations and again between the fifth and sixth generations. Temporal shifting represents the effect of multiple generations which have different GOP alignment.

Chroma key experiments were done by processing the foreground with blue screen through compression and decompression. After decompression the component digital signal was chroma keyed to add the background. The background image was not compressed.

Mixed environment tests for 525/60 used ITU-T Rec. H.262 | ISO/IEC 13818-2 4:2:2 compression and decompression cascaded with a compressed digital VTR using 2:1 intra-field compression. The tests used a total of eight generations of compression. The four odd number generations were MPEG and the four even number generations were compressed digital VTR. There were no shifts between generations.

Mixed environment tests for 625/50 used only MPEG compression. The tests used a total of three generations of compression. The first and third generations were ITU-T Rec. H.262 | ISO/IEC 13818-2 4:2:2 compression with IBBP-GOP structure at 20 Mb/s, while the second generation was ITU-T Rec. H.262 | ISO/IEC 13818-2 4:2:2 compression with I-only GOP structure at 50 Mb/s. A temporal shift of one frame was included between the second and third generations.

Compression and decompression processing were contributed by:

- CCETT;
- FTZ;
- IRT;
- JVC;
- Sony;
- Technical University of Braunschweig/BTS;
- Tektronix.

Editing and duplication of test tapes were contributed by:

- RAI;
- Tektronix.

J.1.3 Subjective assessment

The subjective assessment used the DSCQS method described in ITU-R Rec. BT.500-6. Both expert and non-expert viewing sessions were conducted at a number of sites around the world. All of the expert viewing results were combined, and all of the non-expert viewing results were combined. Both expert and non-expert results are presented here. Only subjective test results are presented, as signal to noise ratio is not regarded as a reliable measure of picture quality in these cases.

Expert subjective assessment viewing sessions were conducted by:

- NHK;
- SMPTE.

Non-expert subjective assessment viewing sessions were conducted by:

- CCETT;
- JVC/MPT/NHK/NTV;
- RAI;
- Technical University of Braunschweig/BTS.

J.1.4 Test results

Test results are presented in the following order (see Tables J.1 and J.2):

- 525/60 Homogeneous Environment;
- 525/60 Non-Homogeneous Environment;
- 625/50 Homogeneous Environment;
- 625/50 Non-Homogeneous Environment.

The tables of test results are organized with higher data rates presented first and lower data rates presented last. Within a given bit rate, results are organized by GOP structure, number of generations, and type of shifting. The mean and confidence interval are given for each test sequence.

These tests used the continuous quality scale specified in ITU-R Rec. BT.500-6. The subjective assessments were done on a continuous 0 to 100 scale. The mean differences between original and compressed sequence ratings were calculated, on a 0 to 100 scale, with differences inferior or equal to 0 representing no degradation through compression and 100 being the worst possible rating.

Hereinafter the average of the differences between original and compressed sequence ratings, calculated over the subjects, will be referred to as diff-grade.

The results presented here are based on the following quality definitions:

- **transparency:** diff-grade for all test sequences does not exceed 12% of the scale;
- **near transparency:** the diff-grade of the 25% of the test sequences is between 12% and 18%, while all the other diff-grades do not exceed 12% of the scale;
- **good quality in most of the material:** the mean diff-grades calculated over the test sequences do not exceed 18%, while the diff-grades of 25% of the test sequences exceed 18% of the scale;
- **difficulties in some materials:** all other cases.

Table J.1 – Subjective test results for the 525/60 system

Compression parameters		Viewer ratings	
525/60 50 Mbits/s		Expert viewers	Non-expert viewers
GOP = I	1 generation	Transparency	Transparency
	8 generations, No shifts	Good quality in most test materials	Transparency
	8 generations, 2 spatial shifts	Good quality in most test materials	Near-transparency
GOP = IB	1 generation	Transparency	Transparency
	8 generations, No shifts	Transparency	Transparency
	8 generations, 2 spatial shifts	Good quality in most test materials	Transparency
	8 generations, 2 temporal shifts	Transparency	Transparency
525/60 30 Mbits/s		Expert viewers	Non-expert viewers
GOP = I	1 generation	Difficulties in some materials	Good quality in most test materials
	8 generations, No shifts	Difficulties in some materials	Transparency
	8 generations, 2 spatial shifts	Difficulties in some materials	Difficulties in some materials
GOP = IB	1 generation	Good quality in most test materials	Transparency
	8 generations, No shifts	Good quality in most test materials	Transparency
	8 generations, 2 spatial shifts	Difficulties in some materials	Near-transparency
	8 generations, 2 temporal shifts	Difficulties in some materials	Good quality in most test materials
525/60 20 Mbits/s		Expert viewers	Non-expert viewers
GOP = IB	1 generation	Difficulties in some materials	Difficulties in some materials
	8 generations, No shifts	Difficulties in some materials	Transparency
	8 generations, 2 spatial shifts	Difficulties in some materials	Difficulties in some materials
	8 generations, 2 temporal shifts	Difficulties in some materials	Difficulties in some materials
GOP = IBBP	1 generation	Transparency	Transparency
	8 generations, No shifts	Difficulties in some materials	Good quality in most test materials
	8 generations, 2 spatial shifts	Difficulties in some materials	Difficulties in some materials
	8 generations, 2 temporal shifts	Difficulties in some materials	Difficulties in some materials
525/60 mixed environment		Expert viewers	Non-expert viewers
30 Mbits/s GOP = I	8 generations, No shifts	Difficulties in some materials	Good quality in most test materials
20 Mbits/s GOP = IB	8 generations, No shifts	Difficulties in some materials	Good quality in most test materials

Table J.2 – Subjective test results for the 625/50 system

Compression parameters		Viewers	
625/50 50 Mbits/s		Expert viewers	Non-expert viewers
GOP = I	1 generation	Transparency	Transparency
	8 generations, 2 spatial shifts	Transparency	Transparency
625/50 30 Mbits/s		Expert viewers	Non-expert viewers
GOP = I	1 generation	Transparency	Transparency
	8 generations, 2 spatial shifts	Good quality in most test materials	Difficulties in some materials
GOP = IB	8 generations, 2 spatial shifts	Good quality in most test materials	Near-transparency
	8 generations, 2 temporal shifts	Good quality in most test materials	Near-transparency
625/50 20 Mbits/s		Expert viewers	Non-expert viewers
GOP = IB	1 generation	Transparency	Transparency
	8 generations, 2 spatial shifts	Difficulties in some materials	Difficulties in some materials
	8 generations, 2 temporal shifts	Difficulties in some materials	Difficulties in some materials
GOP = IBBP	8 generations, 2 spatial shifts	Difficulties in some materials	Difficulties in some materials
	8 generations, 2 temporal shifts	Good quality in most test materials	Good quality in most test materials
625/50 mixed environment Cascaded 20 Mbits/s + 50 Mbits/s + 20 Mbits/s		Expert viewers	Non-expert viewers
GOP = IBBP + I + IBBP	3 generations, 1 temporal shift	Good quality in most test materials	Good quality in most test materials

ITU-T RECOMMENDATIONS SERIES

Series A	Organization of the work of the ITU-T
Series B	Means of expression: definitions, symbols, classification
Series C	General telecommunication statistics
Series D	General tariff principles
Series E	Overall network operation, telephone service, service operation and human factors
Series F	Non-telephone telecommunication services
Series G	Transmission systems and media, digital systems and networks
Series H	Audiovisual and multimedia systems
Series I	Integrated services digital network
Series J	Transmission of television, sound programme and other multimedia signals
Series K	Protection against interference
Series L	Construction, installation and protection of cables and other elements of outside plant
Series M	TMN and network maintenance: international transmission systems, telephone circuits, telegraphy, facsimile and leased circuits
Series N	Maintenance: international sound programme and television transmission circuits
Series O	Specifications of measuring equipment
Series P	Telephone transmission quality, telephone installations, local line networks
Series Q	Switching and signalling
Series R	Telegraph transmission
Series S	Telegraph services terminal equipment
Series T	Terminals for telematic services
Series U	Telegraph switching
Series V	Data communication over the telephone network
Series X	Data networks and open system communications
Series Y	Global information infrastructure
Series Z	Languages and general software aspects for telecommunication systems