

I n t e r n a t i o n a l T e l e c o m m u n i c a t i o n U n i o n

ITU-T

TELECOMMUNICATION
STANDARDIZATION SECTOR
OF ITU

J.128

(10/2008)

SERIES J: CABLE NETWORKS AND TRANSMISSION
OF TELEVISION, SOUND PROGRAMME AND OTHER
MULTIMEDIA SIGNALS

Interactive systems for digital television distribution

**Set-top gateway specification for transmission
systems for interactive cable television services**

Recommendation ITU-T J.128



Recommendation ITU-T J.128

Set-top gateway specification for transmission systems for interactive cable television services

Summary

Recommendation ITU-T J.128 introduces additional requirements on a DOCSIS cable modem termination system and DOCSIS cable modem (Annex B of Recommendation ITU-T J.112 and Recommendation ITU-T J.122) to support the configuration and transport of a class of service known as "Out-Of-Band (OOB) messaging" between a set-top controller (or application server) and the customer premises equipment (CPE). In general, the CPE is intended to be a digital set-top device, but may include other CPE devices, such as residential gateways or other electronic equipment.

Source

Recommendation ITU-T J.128 was approved on 29 October 2008 by ITU-T Study Group 9 (2005-2008) under Recommendation ITU-T A.8 procedures.

FOREWORD

The International Telecommunication Union (ITU) is the United Nations specialized agency in the field of telecommunications, information and communication technologies (ICTs). The ITU Telecommunication Standardization Sector (ITU-T) is a permanent organ of ITU. ITU-T is responsible for studying technical, operating and tariff questions and issuing Recommendations on them with a view to standardizing telecommunications on a worldwide basis.

The World Telecommunication Standardization Assembly (WTSA), which meets every four years, establishes the topics for study by the ITU-T study groups which, in turn, produce Recommendations on these topics.

The approval of ITU-T Recommendations is covered by the procedure laid down in WTSA Resolution 1.

In some areas of information technology which fall within ITU-T's purview, the necessary standards are prepared on a collaborative basis with ISO and IEC.

NOTE

In this Recommendation, the expression "Administration" is used for conciseness to indicate both a telecommunication administration and a recognized operating agency.

Compliance with this Recommendation is voluntary. However, the Recommendation may contain certain mandatory provisions (to ensure e.g. interoperability or applicability) and compliance with the Recommendation is achieved when all of these mandatory provisions are met. The words "shall" or some other obligatory language such as "must" and the negative equivalents are used to express requirements. The use of such words does not suggest that compliance with the Recommendation is required of any party.

INTELLECTUAL PROPERTY RIGHTS

ITU draws attention to the possibility that the practice or implementation of this Recommendation may involve the use of a claimed Intellectual Property Right. ITU takes no position concerning the evidence, validity or applicability of claimed Intellectual Property Rights, whether asserted by ITU members or others outside of the Recommendation development process.

As of the date of approval of this Recommendation, ITU had not received notice of intellectual property, protected by patents, which may be required to implement this Recommendation. However, implementers are cautioned that this may not represent the latest information and are therefore strongly urged to consult the TSB patent database at <http://www.itu.int/ITU-T/ipr/>.

© ITU 2010

All rights reserved. No part of this publication may be reproduced, by any means whatsoever, without the prior written permission of ITU.

CONTENTS

	Page
1	Scope 1
1.1	Introduction and overview 1
1.2	Purpose of the Recommendation 1
2	References 2
2.1	Normative references 2
2.2	Informative references 3
3	Definitions, Abbreviations, and Conventions 4
3.1	Definitions 4
3.2	Abbreviations 6
3.3	Conventions 7
4	Reference Architecture 8
4.1	DSG basic mode 10
4.2	DSG advanced mode 10
4.3	DSG and IP multicast 10
5	DOCSIS set-top gateway 10
5.1	Assumptions and Constraints 10
5.2	Requirements – General 11
5.3	Requirements – DSG tunnel definition 17
5.4	DSG eCM operation 27
5.5	Security considerations 69
5.6	Interoperability 70
5.7	DSG operation 71
	Annex A – DOCSIS set-top gateway agent MIB definition 78
	Annex B – DOCSIS set-top gateway set-top device MIB definition 95
	Annex C – Format and content for DSG eCM event, SYSLOG, and SNMP trap extensions 105
	C.1 DSG eCM event extensions description 105
	C.2 DSG DOCSIS events extensions 107
	Annex D – Delivery of MPEG-2 sections in the broadcast tunnel 109
	D.1 MPEG-2 section encapsulation 109
	D.2 Layer 4 multiplexing 110
	Annex E – Delivery of MPEG-2 Sections in Application Tunnels 111
	Appendix I – Parsing the MIB in the DSG agent 112
	I.1 DSG Configuration TLVs (51) 114
	I.2 DSG Rule (50) 114
	I.3 DownStream Packet Classification Encoding (23) 116
	I.4 Iteration 116
	I.5 Order of data entry into the MIB 116

	Page
I.6 Building the MIB from a model of communication paths – (example)	117
I.7 DCD rules from this example.....	118
Bibliography.....	125

Recommendation ITU-T J.128

Set-top gateway specification for transmission systems for interactive cable television services

1 Scope

1.1 Introduction and overview

This Recommendation defines an interface and associated protocol that introduces additional requirements on a DOCSIS CMTS and DOCSIS CM to support the configuration and transport of a class of service known as "Out-Of-Band (OOB) messaging" between a Set-top Controller (or application servers) and the customer premises equipment (CPE). In general, the CPE is intended to be a digital Set-top Device, but may include other CPE devices, such as Residential Gateways or other electronic equipment. Figure 1-1 provides the context for this Recommendation in relation to the data-over-cable reference architecture and the other interface specifications in the DOCSIS Cable Modem series.

Traditionally, the physical transport of this Out-Of-Band messaging has been carried over a variety of mechanisms, including [ITU-T J.184]. This Recommendation defines the applicable communications standards and protocols needed to implement an Out-Of-Band messaging interface to the Set-top Device using DOCSIS as a transport. It applies to cable systems employing HFC and coaxial architectures. Specifically, the scope of this Recommendation is to:

- Describe the communications protocols and standards to be employed.
- Specify the data communication requirements and parameters that will be common to all units.

The intent of this Recommendation is to specify open protocols, with a preference for existing, well-known and well-accepted standards. This interface Recommendation is written to provide the minimal set of requirements for satisfactory communication between the Set-top Controller and the Set-top Device over the DOCSIS transport. "DOCSIS Set-top Gateway" (DSG) shall be the general term used to describe this interface.

1.2 Purpose of the Recommendation

Cable operators have deployed millions of digital set-top boxes enabling broadcast and interactive services. They have also deployed millions of DOCSIS cable modems with the associated infrastructure, CMTS, routers, and network connectivity. There is significant interest in enabling digital set-top boxes to leverage the existing infrastructure of digital video and DOCSIS networks. This Recommendation is one of a series of interface specifications that will permit the early definition, design, development and deployment of digital cable systems on a uniform, consistent, open, non-proprietary, multi-vendor interoperable basis.

The intended service will allow transparent unidirectional and bidirectional transport of Out-Of-Band messaging over Internet Protocol (IP), between the cable system headend and customer locations, over an all-coaxial or hybrid-fibre/coax (HFC) cable network. This is shown in simplified form in Figure 1-1.

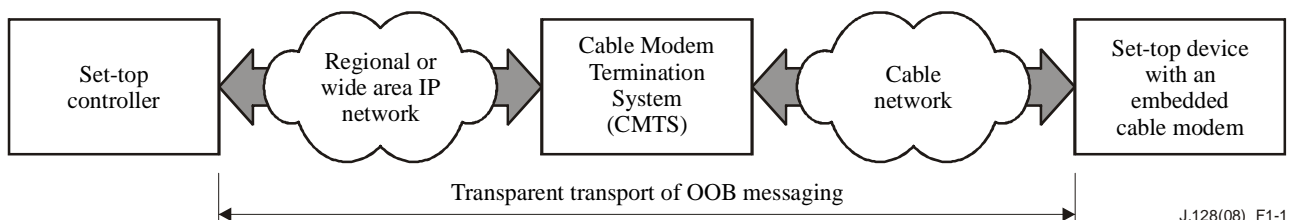

Figure 1-1 – Transparent out-of-band messaging via DOCSIS

The transmission path over the cable system is realized at the headend by a Set-top Controller that is responsible for managing the Set-top Devices, a regional or wide area IP network connecting the Set-top Controller to the Cable Modem Termination System (CMTS), and, at each customer location, a Set-top Device with an embedded Cable Modem. At the headend (or hub), the interface to the data-over-cable system is called the Cable Modem Termination System – Network-Side Interface.

The intent is for the cable operators to transparently transport OOB messaging traffic between these interfaces, including but not limited to UDP over IP datagrams in either unicast, broadcast, or multicast forms. DSG addresses several issues.

- DSG allows the DOCSIS downstream transport to be used for Out-of-Band signalling.
- DSG allows delivery of Out-of-Band messages through the DOCSIS downstream without requiring return path functionality between the Set-top Devices and the CMTS.
- DSG allows legacy non-IP addressing of Set-top Devices by a Set-top Controller to be transported over a tunnel on an IP network.

NOTE – The structure and content of this Recommendation have been organized for ease of use by those familiar with the original source material; as such, the usual style of ITU-T Recommendations has not been applied.

2 References

2.1 Normative references

The following ITU-T Recommendations and other references contain provisions which, through reference in this text, constitute provisions of this Recommendation. At the time of publication, the editions indicated were valid. All Recommendations and other references are subject to revision; users of this Recommendation are therefore encouraged to investigate the possibility of applying the most recent edition of the Recommendations and other references listed below. A list of the currently valid ITU-T Recommendations is regularly published. The reference to a document within this Recommendation does not give it, as a stand-alone document, the status of a Recommendation.

- | | |
|--------------|--|
| [J.112-B] | Recommendation ITU-T J.112 Annex B (2004), <i>Data-over-cable service interface specifications: Radio-frequency interface specification</i> . |
| [J.122] | Recommendation ITU-T J.122 (2002), <i>Second-generation transmission systems for interactive cable television services – IP cable modems</i> . |
| [DOCSIS-RFI] | Refers to both [J.112-B] and [J.122]. |
| [J.222.2] | Recommendation J.222.2 (2007), <i>Third-generation transmission systems for interactive cable television services – IP cable modems: MAC and Upper Layer protocols</i> . |
| [MULPI] | Refers to [DOCSIS-RFI] and [J.222.2]. |

2.2 Informative references

- [CAS ID] *Conditional Access System Identifier*, CA_system_ID, administered by DVB, www.dvb.org. Table at <http://www.dvb.org/index.php?id=174>
- [ANSI/SCTE 23-3] ANSI/SCTE 23-3 (2003), *DOCSIS 1.1 Part 3: Operations Support System Interface*.
- [ANSI/SCTE 79-2] ANSI/SCTE 79-2 (2002), *DOCSIS 2.0 Operations Support System Interface*.
- [eDOCSIS] Recommendation ITU-T J.126 (2004), *Embedded Cable Modem device specification*.
- [IANA] IANA (2006), *Internet Multicast Addresses*.
<http://www.iana.org/assignments/multicast-addresses>
- [IEEE 802.3] IEEE 802.3 (2005), *Local and metropolitan area networks – Specific requirements Part 3: Carrier Sense Multiple Access with Collision Detection (CSMA/CD) Access Method and Physical Layer Specifications*.
- [ITU-T J.94] Recommendation ITU-T J.94 (1998), *Service information for digital broadcasting in cable television systems*.
- [ITU-T J.184] Recommendation ITU-T J.184 (2001), *Digital broadband delivery system: Out-of-band transport*.
- [GRE 1] IETF RFC 1701 (1994), *Generic Routing Encapsulation (GRE)*.
<http://www.ietf.org/rfc/rfc1701.txt>
- [GRE 2] IETF RFC 2784 (2000), *Generic Routing Encapsulation (GRE)*.
<http://www.ietf.org/rfc/rfc2784.txt>
- [MPEG-SI] Recommendation ITU-T H.222.0 (2000) | ISO/IEC 13818-1:2000, *Information technology – Generic coding of moving pictures and associated audio information: Systems*.
- [OUI] Organizationally Unique Identifier, <http://standards.ieee.org/regauth/oui>
- [RFC 768] IETF RFC 768 (1980), *User datagram Protocol*.
<<http://www.ietf.org/rfc/rfc0768.txt?number=768>>
- [RFC 791] IETF RFC 791 (1981), *Internet Protocol. Darpa Internet Program Protocol Specification*.
<<http://www.ietf.org/rfc/rfc0791.txt?number=791>>
- [RFC 1112] IETF RFC 1112 (1989), *Host Extensions for IP Multicasting*,
<http://www.ietf.org/rfc/rfc1112.txt>
- [RFC 3171] IETF RFC 3171 (2001), *IANA Guidelines for IPv4 Multicast Address Assignments*. <http://www.ietf.org/rfc/rfc3171.txt>
- [RFC 3569] IETF RFC 3569 (2003), *An Overview of Source-Specific Multicast (SSM)*.
<http://www.ietf.org/rfc/rfc3569.txt>
- [RFC 4639] IETF RFC 4639 (2006), *Cable Device Management Information Base for Data-Over-Cable Service Interface Specification (DOCSIS) Compliant Cable Modems and Cable Modem Termination Systems*.
<<http://www.ietf.org/rfc/rfc4639.txt?number=4639>>
- [OC-SP-CD-IF] OpenCable TM Common Download Specification – I08-040831,
<http://www.opencable.com>

[OC-SP-OCAP1.0] OpenCable™ OC-SP-OCAP1.0-I16-050803 for OCAP, <http://www.opencable.com>

[SCTE-18] SCTE 18 (2002), *Emergency Alert Message for Cable*, <http://www.scte.org>

3 Definitions, Abbreviations, and Conventions

3.1 Definitions

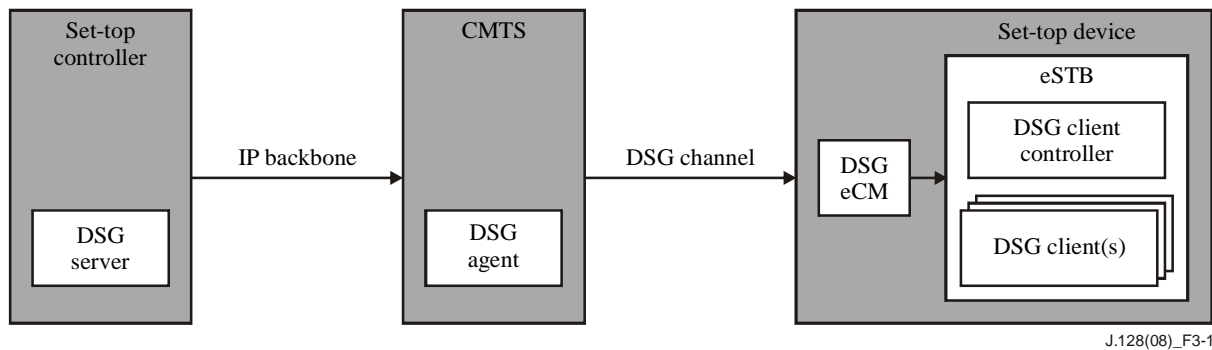

Figure 3-1 – DSG terminology

This Recommendation defines the following terms:

3.1.1 application ID: This is a 16-bit field indicating a numeric ID for an application running on the Set-top Device. The Application ID is typically assigned through a Source Name Sub-table (SNS) from [ITU-T J.94] carried in the Broadcast DSG Tunnel.

3.1.2 CA_system ID: This is a 16-bit field indicating the type of CA system applicable for either the associated ECM and/or EMM streams. The CA_system_ID may be used as a DSG Client ID in DSG Advanced Mode.

3.1.3 DOCSIS Set-Top Gateway (DSG): The DOCSIS Set-top Gateway (DSG) defines functionality on a DOCSIS CMTS and DOCSIS CM to support the configuration and transport of a class of service known as "Out-Of-Band (OOB) messaging" between a Set-top Controller (or application servers) and the customer premises equipment (CPE). The DSG is not intended for the delivery of programming content.

3.1.4 DSG address table: The collection of DSG Rules and DSG Classifiers contained within the DCD message. The DSG Client uses its DSG Client ID as an index into the DSG Address Table to determine what DSG Tunnel Address to receive.

3.1.5 DSG advanced mode: Operation with the DCD message. Address assignment is dynamic. The DSG Tunnel Address is determined by the DSG Agent and learned by the DSG Client through the DSG Address Table in the DCD message.

3.1.6 DSG agent: The DSG Agent is the implementation of the DSG protocol within the CMTS. The DSG Agent creates the DSG Tunnel, places content from the DSG Server into the DSG Tunnel, and sends the DSG Tunnel to the DSG Client.

3.1.7 DSG basic mode: Operation without the DCD message. Address assignment is static. The DSG Tunnel Address is determined by the DSG Client and learned by the DSG Agent through configuration. This mode provides backwards compatibility with earlier versions of the DSG specification.

3.1.8 DSG channel: Any DOCSIS downstream channel that contains one or more DSG Tunnels.

3.1.9 DSG classifier: A description of layer 3 and layer 4 filtering applied to DSG Tunnel traffic. DSG Classifiers may be specified in the DSG Agent and sent as a component of the DSG Address Table in the DCD Message.

3.1.10 DSG client: The DSG Client terminates the DSG Tunnel and receives content from the DSG Server. There may be more than one DSG Client within a Set-top Device.

3.1.11 DSG client controller: The portion of the Set-top Device that handles the processing of DCD messages and makes decisions regarding the forwarding of DSG Tunnels within the Set-top Device.

3.1.12 DSG client ID: This is an identifier that uniquely identifies a DSG Client. The DSG Client ID is unique per DSG Client, but is not unique per Set-top Device as the same DSG Client which provides the same function may exist in multiple Set-top Devices. In DSG Basic Mode, the DSG Client ID is a 6-byte MAC address. In DSG Advanced Mode, the DSG Client ID may additionally be a 2-byte Application ID, a 2-byte CA_system_ID, or a broadcast ID.

3.1.13 DSG eCM: A DOCSIS Cable Modem that has been embedded into a Set-top Device and includes DSG functionality.

3.1.14 DSG rule: A row entry within the DSG Address Table that assigns a DSG Client ID to a DSG Tunnel Address.

3.1.15 DSG server: The DSG Server refers to any server such as an Application Server or other network attached device that provides content that is transported through the DSG Tunnel to the DSG Client.

3.1.16 DSG tunnel: A stream of packets sent from the CMTS to the Set-top Terminal. In DSG Basic Mode, a DSG Tunnel is identified solely by its DSG Tunnel Address; all of the DSG Tunnel's packets use the same DSG Tunnel Address and different DSG Tunnels use different DSG Tunnel Addresses. In DSG Advanced Mode, a DSG Tunnel might be identified solely by its DSG Tunnel Address, or it might be identified by a combination of the DSG Tunnel Address along with other DSG Rule parameters: UCID List, Classifier IP addresses, and UDP port numbers.

3.1.17 DSG tunnel address: This specifically refers to the destination MAC address of the DSG Tunnel. If the source MAC address, the destination IP address, or the source IP address is to be referenced, then that reference must be explicitly stated.

3.1.18 Embedded set-top box: An embedded Set-top Box is an embedded Service Application Functional Entity (eSAFE) defined in [eDOCSIS]. It includes the DSG Client(s), a DSG Client Controller, an embedded processor for an application environment, and either an embedded or removable module for Conditional Access.

3.1.19 one-way: This expression infers that the downstream path (from the network to the subscriber) is operational, and that the upstream path (from the subscriber to the network) is not operational. This may occur because the upstream path is not available, the Set-top Device is not registered, or the Set-top Device does not support a two-way mode of operation.

3.1.20 out-of-band messaging: The control and information messages sent from the Set-top Controller (or Application Server or similar device for legacy Out-Of-Band (OOB) messaging) to one or more Set-top Devices. Specifically, OOB infers the use of a dedicated channel for signalling which is separate from the video channels. This includes the following types of messages:

- Conditional Access (CA) messages including entitlements;
- Service Information (SI) messages;
- Electronic Program Guide (EPG) messages;
- Emergency Alert System (EAS) messages;
- Other control or information messages.

3.1.21 POD: A detachable device distributed by cable providers that connects to the cable receiver and manages Conditional Access.

3.1.22 QoS parameter set: The set of Service Flow Encodings that describe the Quality of Service attributes of a Service Flow or a Service Class.

3.1.23 service class: A set of queuing and scheduling attributes that is named and that is configured at the CMTS. A Service Class is identified by a Service Class Name. A Service Class has an associated QoS Parameter Set.

3.1.24 set-top controller: This is the computer system responsible for managing the Set-top Devices within a cable system. It manages Set-top Devices through control and information messages sent via the Out-Of-Band channel.

3.1.25 set-top device: A cable receiver that contains an embedded Cable Modem for DOCSIS connectivity and an embedded Set-top Box.

3.1.26 two-way: This expression infers that the downstream path and the upstream path are operational.

3.1.27 well-known MAC address: This refers to the MAC address of the DSG Client within the Set-top Device. This MAC address has been assigned by the manufacturer of the POD and/or Conditional Access system within the Set-top Device, and has been made known to the operator for use in configuring the DSG Agent.

3.2 Abbreviations

This Recommendation uses the following abbreviations:

CA	Conditional Access
CM	Cable Modem
CMTS	Cable Modem Termination System
CPE	Customer Premises Equipment
CVT	Code Version Table
DCC	Dynamic Channel Change
DCD	Downstream Channel Descriptor
DOCSIS	Data Over Cable Service Interface Specifications
DS	Downstream
DSG	DOCSIS Set-top Gateway
DVS	Digital Video Subcommittee
EAS	Emergency Alert System
eCM	Embedded Cable Modem
EPG	Electronic Program Guide
eSTB	Embedded Set-top Box
HFC	Hybrid Fibre Coax
IP	Internet Protocol
MAC	Media Access Control
MTA	Multimedia Terminal Adapter
MTC	Multiple Transmit Channel

MTU	Maximum Transmission Units
OCAP	OpenCable Application Platform
OOB	Out-Of-Band
SCTE	Society of Cable Telecommunications Engineers
SI	Service Information
SNS	Source Name Sub-Table
SSD	Secure Software Download
STD	Set Top Device
TCP	Transmission Control Protocol
TCS	Transmit Channel Set
TLV	Type Length Value
UCID	Upstream Channel ID
uinshf	unsigned integer, most significant first
UDP	User Datagram Protocol
US	Upstream
VSP	Vendor Specific Parameter
XAIT	Extended Application Information Table (OCAP)

3.3 Conventions

Throughout this Recommendation, the words that are used to define the significance of particular requirements are capitalized. These words are:

"MUST"	This word or the adjective "REQUIRED" means that the item is an absolute requirement of this Recommendation.
"MUST NOT"	This phrase means that the item is an absolute prohibition of this Recommendation.
"SHOULD"	This word or the adjective "RECOMMENDED" means that there may exist valid reasons in particular circumstances to ignore this item, but the full implications should be understood and the case carefully weighed before choosing a different course.
"SHOULD NOT"	This phrase means that there may exist valid reasons in particular circumstances when the listed behaviour is acceptable or even useful, but the full implications should be understood and the case carefully weighed before implementing any behaviour described with this label.
"MAY"	This word or the adjective "OPTIONAL" means that this item is truly optional. One vendor may choose to include the item because a particular marketplace requires it or because it enhances the product, for example; another vendor may omit the same item.

4 Reference Architecture

The reference architecture for the data-over-cable services and interfaces is shown in Figure 4-1.

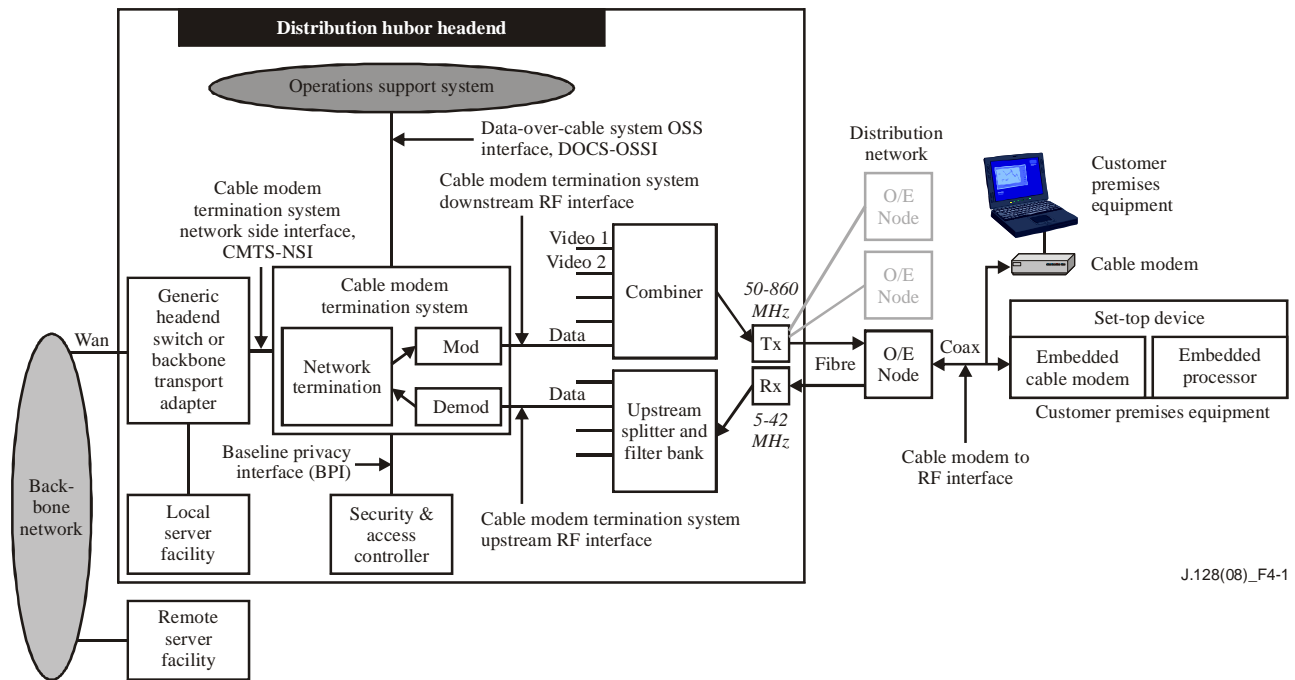

Figure 4-1 – Data-over-cable reference architecture

The DOCSIS Set-top Gateway architecture is an adaptation of the DOCSIS reference architecture shown in Figure 4-1. Figure 4-2 shows how the DOCSIS Set-top Gateway layers on the DOCSIS reference architecture. As shown in this figure, there are potentially multiple servers (1 to K) that function as the Set-top Controller, a regional IP network or IP backbone that connects these servers to potentially multiple CMTSs (1 to M) located in distribution hubs or headends, and an HFC/Cable Network that connects the CMTS to the Set-top Devices located in the subscriber's home. The DOCSIS Set-top Gateway as shown in this diagram is implemented in the CMTS.

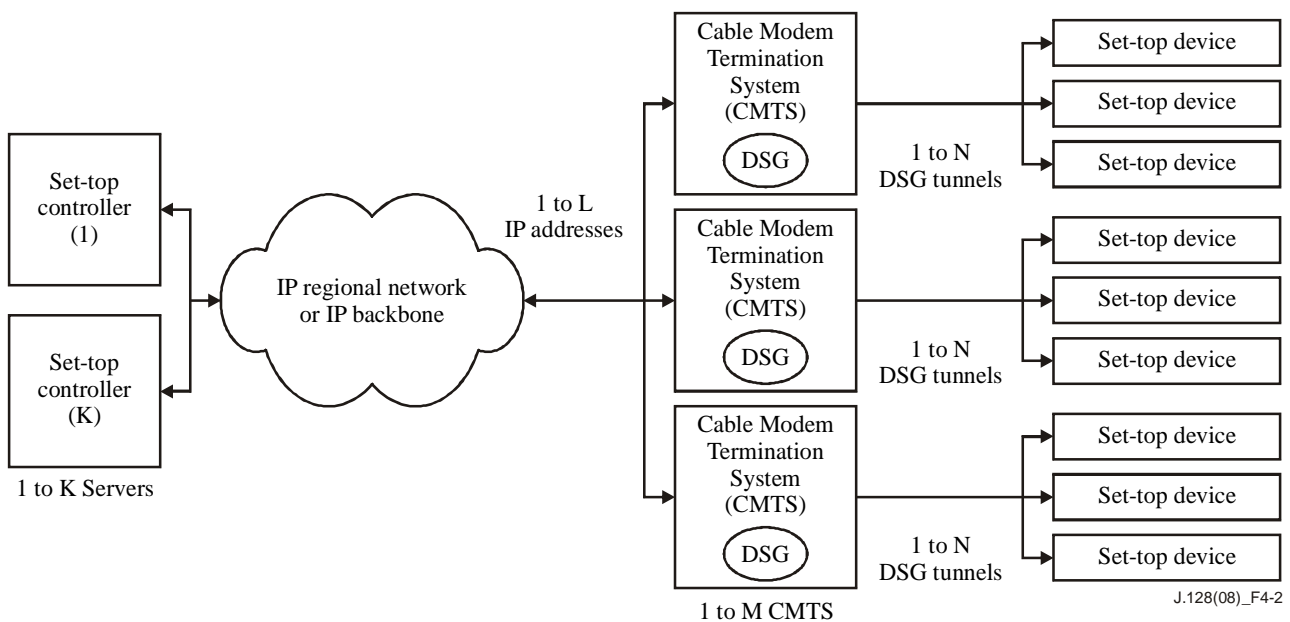

Figure 4-2 – DOCSIS set-top gateway system physical diagram

The DSG Agent maps IP datagrams received on its IP Network Interface to N DSG Tunnels on the DOCSIS transport. In particular, the DSG Agent:

- Receives IP Multicast datagrams on potentially multiple IP addresses (1 to L);
- Maps these datagrams to one of potentially multiple DSG Tunnels on the DOCSIS transport and forwards them on to the DSG Clients.

Networking solutions are available for either legacy DSG Servers or legacy IP networks that do not support IP Multicast. Refer to clause 5.7.8.

The instantiation of the DSG Protocol within the Set-top Device is referred to as the DSG Client. The instantiation of the DSG Protocol within the CMTS is referred to as the DSG Agent. The Set-top Controller or application server which sources content is referred to as the DSG Server. Thus the OOB messages originate at the DSG Server, pass through the DSG Agent, onto the DSG Tunnel, and terminate at the DSG Client. The expression DSG Tunnel Address implicitly refers to the destination MAC address of the DSG Tunnel.

The logical view of the DOCSIS Set-top Gateway is shown in Figure 4-3.

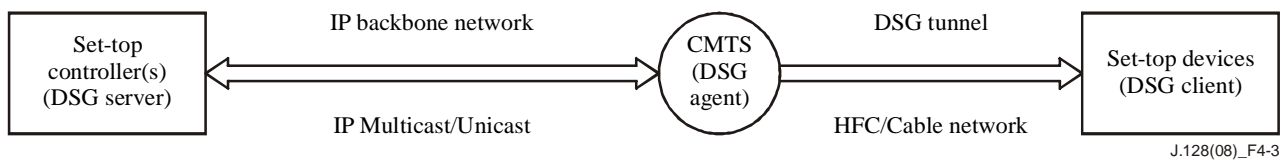

Figure 4-3 – DOCSIS set-top gateway logical diagram

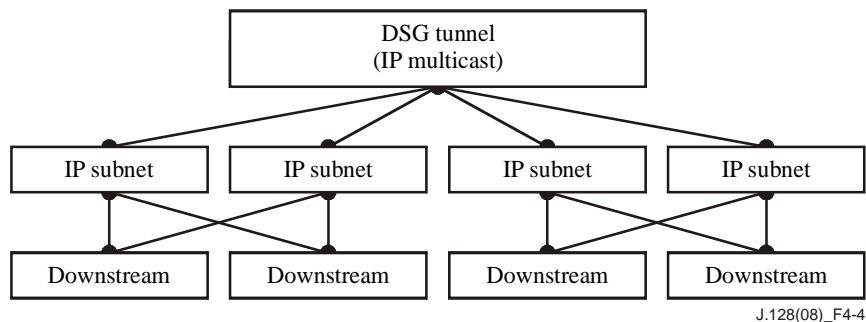

Figure 4-4 – DSG tunnel within the DSG agent

The DSG Agent has to define the uniqueness of a DSG Tunnel in relation to an IP Multicast destination address, IP subnets, and DOCSIS downstreams. This relationship is shown in Figure 4-4 above and is described below.

The following conditions exist at the DSG Agent:

- A DSG Agent may have one or more DOCSIS downstream channels and one or more IP subnets.
- An IP subnet may span one or more DOCSIS downstream channels.
- A DOCSIS Downstream Channel may be a member of one or more IP Subnets.
- There is one instantiation of the DSG Tunnel per DSG Agent and each IP subnet requiring the DSG Tunnel joins the IP Multicast session. The IP address associated with the DSG Tunnel is the IP address of the IP Multicast connection from the DSG Server to the DSG Agent.

4.1 DSG basic mode

The term DSG Basic Mode was previously used in this Recommendation to refer to a method of delivering DSG Tunnels without using a DCD message. This mode of operation is now deprecated. There may still be legacy units operating in DSG Basic mode deployed in some systems.

4.2 DSG advanced mode

In DSG Advanced Mode, the DSG Tunnel Address is determined dynamically by an entry in the DSG Address Table. The DSG Address Table is located in the DOCSIS MAC Management Message called Downstream Channel Descriptor (DCD). The DSG Address Table is indexed by the DSG Client with its DSG Client ID. The following features may be achieved by performing an appropriate DSG Client ID to DSG Tunnel Address association and the concept of regionalization:

- Multiple DSG Clients can be assigned to a single DSG Tunnel. This would be a one-to-many scenario.
- A DSG Client can be given different DSG Tunnels based upon downstream or upstream associations.
- The uniqueness of a DSG Tunnel for a particular DSG Client is per downstream on a one-way HFC plant, and per upstream on a two-way HFC plant.

DSG Advanced Mode uses a multicast (group) MAC address for the DSG Tunnel Address. Since more than one IP multicast address may map to the same multicast MAC address when using IP Multicast [RFC 1112], the DSG Client should use both the destination MAC address and the destination IP address to receive the DSG Tunnel.

A multicast (group) MAC address is used for DSG Advanced Mode since DSG Tunnels are multicast in nature. Use of DSG Advanced Mode presumes that the DOCSIS 1.0 CMs have been configured to disable the IP Multicast forwarding of DSG traffic.

4.3 DSG and IP multicast

DSG is intended as an extension to IP Multicast. In the general case, the addressing of the IP Multicast packet and the DSG Tunnel are the same. The DSG Tunnel encapsulates the IP Multicast datagram in a DOCSIS frame. The one exception to the addressing is that under certain circumstances, DSG allows the MAC address to be re-written to another multicast MAC address.

The signalling protocols for the two are different. The fundamental reason for this is the need for DSG to work on a one-way plant. IP Multicast has several different protocols which allow end points to join an IP Multicast session. In DSG, the CMTS assigns end points to DSG Tunnels using a DOCSIS MAC management message.

5 DOCSIS set-top gateway

The DSG Agent is intended to provide transparent transport of Out-Of-Band messaging over a DOCSIS channel that is traditionally carried on dedicated channels, specifically those defined in [ITU-T J.184]. The following clauses detail the requirements and normative behaviour of the DSG Server, DSG Agent, and DSG Client for this service.

5.1 Assumptions and Constraints

The DSG Agent will exist within a constrained environment. This clause details the assumptions regarding the environment that is required in order to enable this service.

- Any implementation of the DOCSIS Set-top Gateway will work with DOCSIS 1.0, DOCSIS 1.1, DOCSIS 2.0 and DOCSIS 3.0 networks.

- Any implementation of the DOCSIS Set-top Gateway will work for both embedded and removable security implementations within a Set-top Device.
- Any implementation of the DOCSIS Set-top Gateway will not impact the security of the CA systems negatively.
- The DSG Agent will support the transport of multiple simultaneous Conditional Access systems.
- The DSG Agent will provide one-way downstream transport for Out-Of-Band messaging.
- Since the DSG Agent provides a one-way stream of Out-Of-Band messages, DOCSIS Baseline Privacy Interface (BPI) and Baseline Privacy Plus Interface (BPI+) do not apply to the DSG transport.
- The Set-top Device will use an IP session over DOCSIS for all return traffic. For example, if an Out-Of-Band polling message is sent from the DSG Server to the Set-top Device via the DSG Agent within the CMTS, the Set-top Device response to the message is returned to the headend via IP over DOCSIS.
- The Set-Top Device will operate in a one-way environment. Examples of the limited functionality available to a Set-top Device in a one-way environment might be:
 - Analog NTSC audiovisual programming (clear, non-scrambled).
 - Digital audiovisual programming using MPEG-2 transport including, but not limited to, standard and high definition MPEG-2 Main Profile @ Main Level video and Dolby AC-3 audio.
 - Broadcast (in-the-clear), subscription-based (scrambled or encrypted), and call-ahead Pay-Per-View (PPV) (scrambled or encrypted) services. (Call-ahead Pay-Per-View is a paid service in which the viewer pre-subscribes selected programming via telephone.)
 - Processing and enforcement of Copy Protection.
 - Pass through of digital high definition audiovisual programming.
- Considerations for DOCSIS 3.0
 - DSG Tunnels will not contain IPv6 data unless it is encapsulated.
 - DSG Agents, DSG Client Controllers and DSG eCMs will not support IPv6 DSG classifiers.
 - A DSG Client Controller will not be affected by DOCSIS 3.0 operation; no new messages will be used between the DSG Client Controller and the eCM.

5.2 Requirements – General

5.2.1 DSG server

- For DSG Basic Mode only, the DSG Server MUST maintain a minimum data rate of one packet per second on at least one DSG Tunnel within each unique group of DSG Tunnels which serve a CPE device. This requirement is to keep the acquisition time of the appropriate DOCSIS channel to less than one second. The intent is that the data be present at a sufficiently high rate such that in the process of searching for and trying to acquire a DOCSIS channel, no exorbitant amount of time needs to be spent on any DOCSIS channel that does not carry OOB data.
- The DSG Server MUST support either IP Multicast or IP Unicast.
- The DSG Server MUST NOT send packets of a size that would cause IP fragmentation to occur.

NOTE 1 – The calculation of payload size should allow for the 20-byte IP protocol overhead, the 8-byte UDP overhead, and any VPN/IPSec or other IP protocol overhead that may be in use. Fragmented IP/UDP packets would not contain the port number in every fragment. For the eCM classifiers to successfully filter fragments by port, the filters would have to be stateful filters; a complication to be avoided. Annex D was added to provide for the orderly segmentation of MPEG tables by the DSG Server.

- A DSG Server that produces an industry-standard data stream among those listed in Table 5-2 MUST NOT include in this stream any data other than that allowed by the indicated standard. The DSG Server MUST emit the data stream such that a DSG Rule and its optional Classifiers can distinctly describe a tunnel containing only this stream. For instance, distinct UDP port numbers or distinct destination IP addresses, sometimes in combination with source IP addresses, are adequate to distinguish streams.

NOTE 2 – A DSG Rule with a Broadcast Client ID among those listed in Table 5-2 must have one and only one Broadcast client ID and must have a single DSG classifier with a single UDP destination port number designated. The combination of DSG MAC Address, Source IP address/mask, IP destination address, and UDP destination port number must be unique across all rules in a DCD containing Broadcast Client IDs. A given DCD may contain multiple rules for a given Broadcast Client ID. The DSG Client Controller is expected to select at most one rule to use for a given Broadcast Client ID.

- A DSG Server that produces an Object or Data Carousel data stream associated with an Application Client ID MUST NOT include in this stream any other data including non-carousel related MPEG sections or unspecified data formats. Annex E was added to provide for the encapsulation of such data.

5.2.2 DSG agent

The following are the normative requirements for the DSG Agent within a CMTS.

5.2.2.1 General operation

- The DSG Agent MUST be implemented on a CMTS.
- The DSG Agent MUST implement the MIB defined in Annex A and be configurable through this MIB.
- The DSG Agent SHOULD allow SNMP access to the DSG MIBs on the same IP address it allows access to the DOCSIS MIBs.

5.2.2.2 Network side operation

- The DSG Agent MUST NOT forward frames with Ethertypes other than 0x0800, corresponding to IP, onto the DSG Tunnel.
- The DSG Agent MUST be able to filter packets based on the UDP port number and the IP protocol type, after de-encapsulation of any IP tunnelling protocols that may have been used between the DSG Server and the DSG Agent. This requirement should be interpreted as an input access list on a CMTS. This requirement should not be interpreted as the CMTS using the UDP ports to route packets to different DSG Tunnels.
- The DSG Agent MAY use source IP address verification to prevent forwarding of packets originating from other than a trusted DSG Server.
- The DSG Agent MAY use dedicated links, Secure Sockets Layer (SSL/TLS), virtual private networks (VPN), IPSec, or other means to provide secure connections between it and the DSG Server. The specifics of how this may be implemented are beyond the scope of this Recommendation.

5.2.2.3 RF side operation

- The DSG Agent MUST support a one-way (downstream) transport without requiring return path functionality from the DSG Client.
- The DSG Agent MUST be able to support forwarding on one or more DOCSIS downstream channels.
- The DSG Agent MUST simultaneously support STDs operating in DSG Basic Mode and STDs operating in DSG Advanced mode.
- The downstream DOCSIS PDUs encapsulating the DSG OOB messages MUST have Frame Control bits set to the Packet PDU code point by the CMTS.
- The CMTS MUST NOT send standard DOCSIS MAC Management messages to the DSG Tunnel Address.
- The DSG Agent MUST be able to support at least 32 DSG Rules per DCD Message.

NOTE 1 – Since a single DSG Rule represents a single DSG Tunnel on a particular downstream channel, in effect this requires the DSG Agent to support at least 32 DSG Tunnels per downstream channel.

- The DSG Agent MUST be capable of rate limiting or rate shaping each DSG Tunnel, as described in [DOCSIS-RFI]. The rate limiting parameters MUST be configurable per DSG Tunnel and are determined by the QoS Parameter Set associated with the Service Class assigned to the DSG Tunnel. The DCD MAC Management Message is not included in this calculation.

NOTE 2 – One application in which rate limiting functionality may be used is an OpenCable Host. The buffer capacity contained in the OpenCable Host is limited and data rates in excess of 2.048 Mbit/s can potentially overflow this buffer. Thus, the maximum sustained traffic rates for all DSG Tunnels that cross the Card interface for a particular OpenCable host device should be chosen such that the total traffic crossing the Card interface for that host, including DCD message fragments, DSG Tunnels, and any other data, does not exceed 2.048 Mbit/s. Note that encapsulation overhead and the size of the packets traversing this interface could reduce the available bandwidth. Refer to [b-OC-CC-IF] for additional information.

- The DSG Agent MUST forward the IP packets received at its configured IP address(es) by performing a MAC level rewrite by replacing the destination MAC address with the DSG Tunnel Address and the source MAC address with the DSG HFC side MAC address. The DSG Agent MUST NOT modify the IP Source Address, IP Destination Address, or IP Protocol Type of the IP header. The CMTS containing the DSG Agent MUST NOT modify the IP Source Address or IP Protocol Type of the IP header. The CMTS containing the DSG Agent MUST NOT modify the IP Destination Address of the IP header except in the context of supporting IP Unicast message streams as defined in clause 5.2.2.4. The DSG Agent or containing CMTS MAY modify other fields of the IP header. The payload of the IP packet, including the UDP port numbers, MUST remain unchanged.

5.2.2.4 IP addressing for DSG tunnels

- The DSG Agent MUST allow the mapping of an IP Multicast address to a DSG Tunnel Address. The DSG Agent MUST NOT allow one IP Multicast address to be mapped to more than one DSG Tunnel Address.

NOTE – Many DSG Servers may send content to the same IP Multicast stream which would be associated to one DSG Tunnel. This scenario is referred to as "many-to-one" in this Recommendation.

- The DSG Agent MUST be configured so that each interface requiring the DSG Tunnel is a member of the appropriate multicast group. An IP Multicast address to DSG Tunnel Address association MAY span one or more IP subnets. An IP Subnet MAY span one or more downstreams.

- The use of an IP Unicast address to transport DSG Tunnel information is intended only to support legacy DSG servers and networks that do not support multicast IP routing. Otherwise, the binding of an IP Unicast address to a DSG Tunnel is explicitly deprecated. If the message stream from the DSG Server to the DSG Agent is IP Unicast, then the CMTS that hosts the DSG Agent MUST support that IP Unicast message stream by at least one of the following three methods:
 - The CMTS supports IP Multicast tunnelled over IP Unicast. The DSG Server or a router external to the DSG Server would encapsulate the IP Multicast packet within an IP Unicast packet. The CMTS would de-encapsulate the IP Unicast tunnel and forward the IP Multicast packet to the DSG Agent. [GRE 1] [GRE 2]. In this case, the DSG Agent receives an IP Multicast packet, and so the DSG Classifier is configured with the appropriate IP Multicast destination address.
 - The CMTS translates the IP Unicast address to an IP Multicast address. The new multicast packet would be forwarded to the DSG Agent. In this case, the DSG Agent receives an IP Multicast packet, and so the DSG Classifier is configured with the appropriate IP Multicast destination address.
 - The CMTS forwards the IP Unicast packet directly onto the DOCSIS downstream. This option may cause an IP Unicast packet with the provisioned DSG Tunnel MAC address to be forwarded in a multicast fashion on multiple DOCSIS downstream channels. In this case, the DSG Agent receives an IP Unicast packet, and so the DSG Classifier is configured with the appropriate IP Unicast destination address.

5.2.2.5 MAC addressing for DSG tunnels

- The destination MAC address of the DSG Tunnel is known as the DSG Tunnel Address. The DSG Agent MUST be configurable to use a multicast (group) MAC address as the DSG Tunnel Address. The use of a unicast MAC address is explicitly deprecated.
- A multicast (group) MAC address may be derived by taking a unicast (individual) MAC address, and setting the I/G bit to a one. The I/G bit is the Individual/Group bit, and it is the LSB of the first byte of the MAC address [IEEE 802.3].
- A DSG Client Controller would use a DSG Client ID as an index into the DSG Address Table in the DCD MAC management message to discover the DSG Tunnel Address. The DSG Client ID could be a DSG Broadcast ID, a Well-Known MAC Address, an Application ID, or a CA_system_ID.
- In certain cases, an operator may want DSG Clients that support DSG Advanced Mode to receive DSG Basic Mode Tunnels. To support such a configuration, and to provide consistency of provisioning, a DSG Basic Mode Tunnel is defined as a DSG Tunnel in which both the DSG Tunnel Address and the DSG Client ID match the Well-Known MAC Address provided by the Set-top Device manufacturer.

5.2.2.6 DOCSIS 3.0 DSG Agent Considerations

DOCSIS 3.0 introduces new concepts which are relevant to DSG Agent operation including downstream channel bonding and enhanced multicast.

5.2.2.6.1 Downstream Bonding Considerations

The DSG Agent is to be configured such that all DSG tunnels are sent on primary-capable downstream channels. A DSG eCM discards DCD messages or DSG tunnel traffic received on non-Primary Downstream channels.

The DSG Agent MUST transmit each instance of a DSG Tunnel on a single downstream channel, as non-bonded traffic.

In DOCSIS 3.0, a downstream channel may be shared by multiple CMTS MAC domains. A downstream channel shared by multiple MAC domains contains multiple MDD messages with different source MAC addresses. A DOCSIS 3.0 eCM parses the source MAC address of the MDD and DCD messages to ensure that the CMTS MAC domain of the MDD message is the same as that of the DCD message. However, a Pre-3.0 DOCSIS DSG eCM does not parse the source MAC address of the DCD message and would be confused if it received multiple DCDs from different MAC Domains on a downstream channel. The DSG Agent **MUST NOT** insert DCD messages from more than one MAC Domain on any downstream channel.

5.2.2.6.2 Multicast Considerations

In DOCSIS 3.0, the DSG Agent labels all multicast traffic with a DSID to be used by the eCM for filtering and forwarding purposes. The DSG Agent broadcasts the DSID(s) to be used for DSG tunnel traffic in the DSG DA-to-DSID Association Entry TLV in the MDD message. The DSG Agent is not permitted to modify the DSID that is associated with a Destination Address once it has been added to the MDD message; as such, entries in the DSG DA-to-DSID Association Entry TLV can only be added or deleted, but never modified. The DSG Agent can only modify the DSG DA-to-DSID Association Entry TLV in the MDD message when it modifies the DCD message due to the addition or deletion of DSG rules.

The DSG Agent is responsible for ensuring that the DSG eCM continues to receive DSG tunnel traffic labeled with DSIDs known to the DSG eCM. The DSG Agent is also responsible for ensuring that DSG tunnel traffic is not sent to any eCM interface other than the DSG tunnel interface.

The DSG Agent is not permitted to add or delete any multicast DSIDs associated with the DSG tunnel interface in the Registration Response message. This includes any static multicast sessions erroneously created via the CMTS Static Multicast Session Encodings in which the Static Multicast CMIM indicates the DSG tunnel interface. The DSG Agent **MUST NOT** signal any multicast DSIDs used to label DSG tunnel traffic in the Registration Response message.

The DSG Agent is not permitted to initiate a DBC transaction to add or delete a multicast DSID associated with the DSG tunnel interface. The DSG Agent **MUST NOT** initiate a DBC transaction to signal any multicast DSIDs used to label DSG tunnel traffic.

The Downstream Multicast QoS mechanisms described in [J.222.2] do not apply to DSG tunnels.

5.2.3 DSG eCM

- The DSG eCM **MUST** coexist with other DOCSIS devices on the same DOCSIS channel (Standalone Cable Modem, Embedded MTA, Embedded PS, etc.).
- The DSG eCM component **MUST** implement the MIB module DSG-IF-STD-MIB defined in Annex B to indicate the eCM and DSG client controller interactions for DSG operations in a Set-top Device.
- The DSG eCM **MUST** support the DOCSIS Event extensions defined in Annex C.
- The DSG eCM **MUST** be able to function in either a one-way or two-way environment.
- The DSG eCM **MUST** support the bridging of 8 simultaneous DSG Tunnel MAC addresses.

NOTE – A DOCSIS 3.0 DSG eCM in MDF enabled mode [J.222.2] will use a DSID in place of the DSG Tunnel MAC address for purposes of forwarding DSG tunnel traffic.

- The DSG eCM **MUST** support at least twelve simultaneous DSG Classifiers per DSG Tunnel MAC Address, and **MUST** support at least thirty-two simultaneous DSG Classifiers in total.

- The DSG eCM MUST NOT perform any DSG operations if a DSG Client Controller is not present in the Set-top Device. DSG operations include but are not limited to: the hunt for a DOCSIS downstream channel with a valid DSG tunnel identifier (DCD and/or well-known CA MAC addresses); acquisition of the DCD; acquisition and forwarding of any DSG tunnels; etc. As a result, the provisions of this Recommendation only apply to a DSG eCM when DSG is active.
- The DSG eCM MUST follow the standard DOCSIS initialization and registration process, with the following specific exceptions:
 - In acquiring the appropriate DOCSIS downstream channel in DSG Advanced Mode, the DSG eCM MUST search for the first DOCSIS channel that contains a DCD message, and pass the contents of the DCD message (including fragment information) to the DSG Client Controller. The DSG Client Controller will make a determination on the suitability of the DCD.
 - The DSG eCM MUST only attempt to register on the network after acquiring the appropriate DOCSIS downstream channel.
 - The DSG eCM MUST NOT reboot under circumstances in which the upstream channel is impaired. Instead of rebooting, the DSG eCM MUST continue to receive and process the DOCSIS downstream channel.
 - The DSG eCM MUST periodically attempt to re-register after loss of the upstream channel (except when the upstream transmitter has been disabled).
 - The state transition between the one-way and two-way modes of operation MUST be as shown in Figure 5-1.

The specifics of how these requirements are implemented are detailed in clause 5.4.

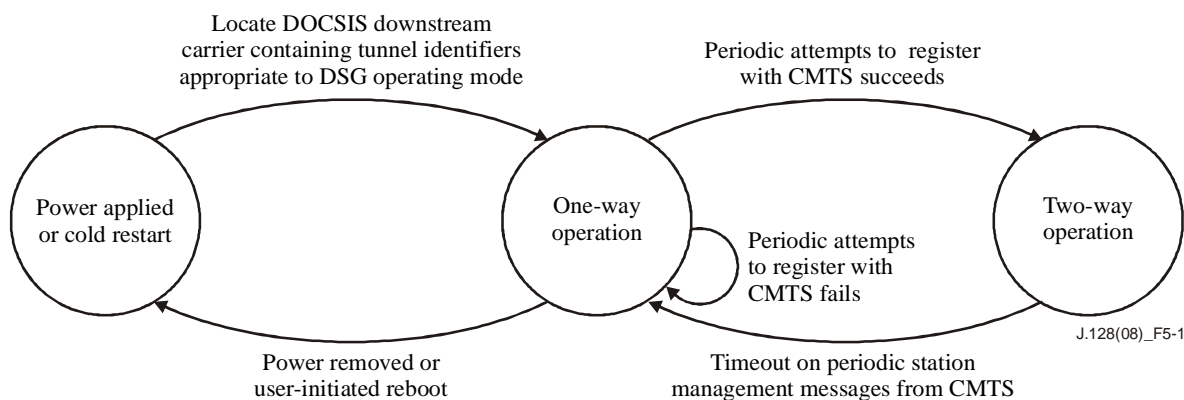

Figure 5-1 – DSG eCM state transition diagram

5.2.3.1 DOCSIS 3.0 DSG eCM Considerations

DOCSIS 3.0 introduces several new concepts which are relevant to DSG operation: downstream service group resolution, upstream channel bonding, and enhanced multicast.

Upon initialization, the DOCSIS 3.0 DSG eCM searches for a DSG downstream channel which carries both DOCSIS SYNC messages and a DCD message. The DOCSIS downstream channel on which the DSG eCM finds a DCD message may be considered a DOCSIS 3.0 primary-capable downstream channel if it additionally contains an MDD message containing ambiguity resolution TLVs. If no MDD messages are detected, the DSG eCM reverts to DOCSIS 2.0 operation, continues to gather upstream parameters, then ranges before continuing on to establish IP connectivity and then registers with the CMTS.

If the DSG eCM finds a DCD message on a primary-capable downstream channel which also contains an MDD message, the eCM ensures that the MDD message has a source MAC address matching the source MAC address of the DCD message. This ensures that the MAC domain of the DCD message is the same as the MAC domain of the MDD message. If the source MAC address of the MDD message differs from the source MAC address of the DCD message, the DSG eCM discards the MDD message and reverts to DOCSIS 2.0 operation.

If the DOCSIS downstream channel on which the eCM finds a DCD message contains an MDD message with a source MAC address matching that of the DCD message, the eCM determines the MD-DS-SG (MAC domain downstream service group) prior to forwarding the DCD message to the DSG Client Controller. This is to maintain consistency in tuner usage in downstream ambiguity resolution for both CMs and DOCSIS 3.0 DSG eCMs. If the DSG client controller considers the DCD message to be invalid, the DOCSIS 3.0 DSG eCM searches all primary-capable downstream channels within the MAC domain for a valid DSG downstream before scanning other downstream channels. This increases the chance that the DSG eCM will register as a DOCSIS 3.0 DSG eCM. The DSG eCM uses the 'Downstream Active Channel List TLV' in the MDD message to get the list of primary-capable downstream channels in the MAC domain.

Neither DCD messages nor DSG tunnel traffic are sent bonded across multiple downstreams. The DOCSIS 3.0 DSG eCM forwards DCD messages and DSG tunnels received on the Primary Downstream Channel to the DSG Client Controller. The DOCSIS 3.0 DSG eCM discards DCD messages and DSG tunnels not received on the Primary Downstream Channel.

In the case of a failure in the upstream path, the DOCSIS 3.0 DSG CM operating in Multiple Transmit Channel (MTC) Mode enters one-way mode when the CM loses all of the upstream channels on which the primary upstream service flow is assigned. (This includes the case in which the DOCSIS 3.0 DSG eCM maintains upstream connectivity with one or more upstream channels not associated with the primary upstream service flow.) If a failure occurs in the upstream path that causes it to switch from an operational state to one-way mode, the DOCSIS 3.0 DSG eCM in MTC Mode periodically attempts to restart the upstream ambiguity resolution process after the expiration of the Tdsg3 timer.

In DOCSIS 3.0, all downstream multicast traffic is labeled with a DSID, which is communicated to the eCM to be used for filtering and forwarding purposes. DSG tunnel traffic is to be labeled with a DSID that the CMTS advertises in the DSG DA-to-DSID Association Entry in the MDD message. If the DSG DA-to-DSID Association Entry is present in the MDD message, the DOCSIS 3.0 DSG eCM filters and forwards DSG tunnel traffic based on the DSID communicated in the DSG DA-to-DSID Association Entry in the MDD message. When filtering and forwarding DSG tunnel traffic based on a DSID, it may be necessary for the DOCSIS 3.0 DSG eCM to update its DSIDs in response to an indication of a change to its DSG tunnels such as a DCD message with an updated change count or message from the DSG Client Controller altering a DSG tunnel.

5.3 Requirements – DSG tunnel definition

DSG Advanced Mode Tunnels use a DOCSIS MAC management message called the Downstream Channel Descriptor (DCD) which provides dynamic provisioning of DSG Tunnels and allows the implementation of several additional features:

Consolidated Keep-Alive: The one DCD message provides a consolidated keep-alive function for all the DSG Tunnels on a downstream. This keep-alive is provided by the DSG Agent rather than the DSG Server.

Enhanced Security: This is achieved through a combination of techniques. First, the destination MAC address of the DSG Tunnel may be replaced dynamically. If the DSG Client ID were to ever become widely known, it may provide the opportunity for a PC to assume that MAC address and snoop the DSG Tunnel. This problem is reduced by substituting the known DSG Tunnel Address

with a MAC address assigned by the DSG Agent. DSG Advanced Mode also allows the DSG Tunnel to be further qualified by the destination IP address, source IP address, and destination UDP port.

One-to-Many: With the ability to re-assign the DSG Tunnel Address, it is possible to have one DSG Tunnel service more than one distinct DSG Client.

Regionalization: DSG Advanced Mode allows the DSG Tunnels to be unique per downstream on a one-way plant, and unique per upstream on a two-way plant.

Layer 4 Multiplexing: In DSG Advanced Mode, a DSG Server may use destination UDP ports to distinguish content, and then combine all the content onto one IP session. This reduces the number of IP Unicast or IP Multicast addresses required for the configuration of DSG Tunnels. Specifically, the DSG Server would do the multiplexing of UDP ports into an IP stream, the DSG Agent would forward that IP stream to a DSG Tunnel, and the DSG Client would demultiplex the stream based upon UDP port number.

5.3.1 Downstream Channel Descriptor (DCD)

DSG Advanced Mode uses a DSG Address Table within a DOCSIS MAC Management Message called the Downstream Channel Descriptor (DCD) to manage the DSG Tunnel. The DCD message provides several functions.

- It provides a consolidated keep-alive mechanism for all DSG Tunnels on a particular downstream, even if the IP network has been interrupted. The keep-alive for a particular DSG Tunnel is based upon the existence of a series of DCD messages and upon the inclusion of that DSG Tunnel within those DCD messages.
- It provides an address substitution and classification mechanism to increase the flexibility and security of the DSG Tunnel.
- It allows the use of multicast addresses. Specifically, multicast sessions from the IP backbone based upon [RFC 1112] addressing may be passed through the DSG Agent as a DSG Tunnel without address translation.
- It allows the operator to assign any Set-top Device to any DSG Tunnel.
- It allows global changes to the DSG Client timers to allow operator driven changes in DSG eCM performance.
- It provides a list of downstream frequencies which contain DSG Tunnels.

The DCD Message contains a group of DSG Rules and DSG Classifiers. This collection of DSG Rules and DSG Classifiers in the DCD message is known as the DSG Address Table. The DSG Address Table contains information relevant to the tunnels on the current downstream that allows a DSG Client Controller to discover the presence of applicable tunnels, their DSG Tunnel Addresses and associated DSG Classifiers. The DSG Agent MUST include all DSG Tunnels on the current downstream in the DSG Address Table in the DCD message. The DCD message is unique per downstream. When necessary, the DCD message is broken into a number of DCD message fragments.

The DSG Agent MUST insert at least one DCD message fragment per second. The DSG Agent SHOULD send a complete DCD message at least once per second on each DOCSIS downstream that contains a DSG Tunnel. Since a DCD message containing a single TLV cannot be fragmented, the DSG Agent MUST be capable of inserting a DCD message containing only a DSG Configuration TLV at least once per second on each DOCSIS downstream that does not contain a DSG Tunnel. It is expected that the DSG Client Controller will accept the inclusion of a DSG Client ID in the DSG Address Table as an indication that a DSG Tunnel exists on this downstream for a DSG Client corresponding to that DSG Client ID.

The DCD message fragments MUST be LLC unnumbered information frames and be compatible with the format of a DOCSIS MAC Management Message. The DCD message fragments MUST NOT exceed 1522 bytes in length, as measured from the beginning of the Ethernet destination MAC address to the end of the CRC. The MAC Management Message Header and the values of the Version field and the Type field for DCD in the MAC Management Message Header are defined in [J.122].

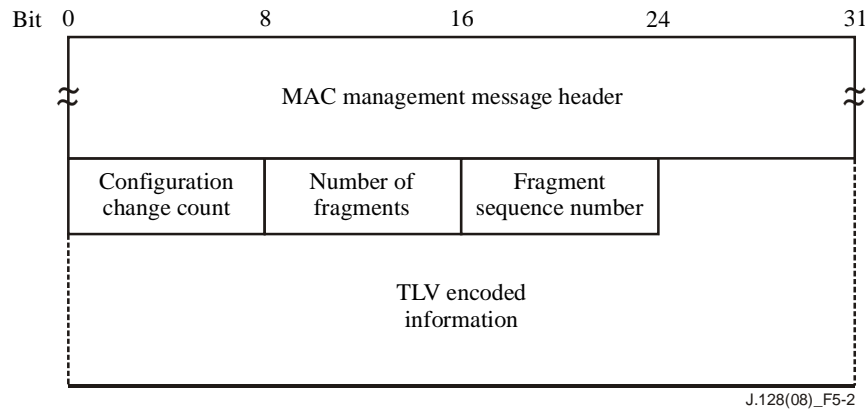

Figure 5-2 – DCD message fragment structure

A DSG Agent MUST generate Downstream Channel Descriptors in the form shown in Figure 5-2, including the following parameters:

Configuration Change Count: Incremented by one (modulo the field size) by the DSG Agent whenever any of the values of the Downstream Channel Descriptor change. The configuration change count MUST be the same value across DCD message fragments.

Number of Fragments: Fragmentation allows the DCD TLV parameters to be spread across more than one DOCSIS MAC Frame, thus allowing the total number of DCD TLV parameters to exceed the maximum payload of a single DCD MAC management frame. The value of this field represents the number of DCD MAC management frames that a unique and complete set of DCD TLV parameters are spread across to constitute the DCD message. This field is an 8-bit unsigned integer. The default value for this field is 1.

Fragment Sequence Number: This field indicates the position of this fragment in the sequence that constitutes the complete DCD message. Fragment Sequence Numbers MUST start with the value of 1 and increase by 1 for each fragment in the sequence. Thus, the first DCD message fragment would have a Fragment Sequence Number of 1 and the last DCD message fragment would have a Fragment Sequence Number equal to the Number of Fragments. The DSG Agent MUST NOT fragment within any top level or lower level TLVs. Each DCD message fragment is a complete DOCSIS frame with its own CRC. Other than the Fragment Sequence Number, the framing of one DCD message fragment is independent of the framing of another DCD message fragment. This allows the potential for the Set-top Device to process fragments as they are received rather than reassembling the entire payload. This field is an 8-bit unsigned integer. The default value for this field is 1.

NOTE 1 – A change in the structure of any of the fields that are not TLVs could cause backward compatibility issues for deployed devices, and therefore should be avoided.

All other parameters are coded as TLV tuples. The DSG Agent MUST be capable of changing these parameters dynamically during normal operation in response to configuration changes. If these parameters are changed, the DSG Agent MUST increment the configuration change count (modulo the field size). In some events (for example, failover, hot swap, etc.) discontinuities in the value of configuration change count may occur. After any event that can cause a discontinuity in the

configuration change count, the DSG Agent MUST ensure that the configuration change count is incremented (modulo the field size) between two subsequent DCD messages (even if the DCD message does not change). This is done to ensure that, after a failover or hot swap, the new configuration change count does not match the configuration change count used before the failover event. When the configuration change count is changed, all DSG Rules and DSG Classifiers from the previous DCD message are considered invalid and are replaced by the DSG Rules and DSG Classifiers from the current DCD message. The DSG eCM MUST not re-initialize if any of these operational parameters are changed.

NOTE 2 – DSG Tunnels are not guaranteed to provide reliable transport to DSG clients. In particular, there could be some packet loss when DSG Tunnel parameters are changed, while the DSG clients adapt to the new parameters.

DSG Vendor-Specific Parameters: Vendor-specific information for DSG Clients, if present, MUST be encoded in the vendor-specific information field (VSIF) (code 43) using the Vendor ID field (code 8) to specify which TLV tuples apply to which vendor's products. Vendor-Specific Parameters may be located inside or outside of a DSG Rule. Vendor-Specific Parameters are coded as TLV tuples and are defined in Annex C of [DOCSIS-RFI].

DSG Classification Parameters: The DSG Classifier is used to provide additional layer 3 and layer 4 filtering for the DSG Tunnel.

DSG Rules: These parameters are used by the DSG Client Controller to determine which DSG Tunnel to receive and if there are any DSG Classifiers to apply.

DSG Configuration: These include various operating parameters for the DSG eCM, including timer values for the DSG eCM state machines and a list of the downstream frequencies containing DSG Tunnels.

The DSG Agent MUST support the above TLVs through the MIB defined in Annex A. DOCSIS 1.0 CMTSs that implement DSG Advanced Mode MUST support these parameters on the DOCSIS signalling interface, but are not obligated to use the same data structures in their internal implementation. The DSG eCM MUST pass all TLVs in a DCD message to the DSG Client Controller without processing. It is expected that the DSG Client Controller will reject without failure any TLV that it does not recognize while accepting the remaining TLVs that it does recognize.

These TLVs used by the DSG Agent and the DSG Client Controller are summarized in Table 5-1 and then described in the subsequent clauses. A check mark beneath the DSG Agent column indicates that the corresponding TLV is intended for use when processing packets received by the DSG Agent. A check mark beneath the DSG Client Controller column indicates that the corresponding TLV may be included in the DCD message and is intended for use when processing packets received by the DSG eCM. The Mandatory/Optional in DCD column indicates whether or not the TLV MUST be included by the DSG Agent in order for the DCD message to be considered valid. Note that a sub-TLV that is labelled "Mandatory" does not override the fact that its parent TLV is optional, i.e., the sub-TLV is only required if the optional parent TLV is present. The Repeatable in DCD column indicates whether or not a TLV may be included multiple times in the DCD message. Note that the Repeatability of a sub-TLV is specified only in the context of its parent TLV, i.e., a non-repeatable sub-TLV may be included at most once within each instance of its parent TLV. Note that, as per [DOCSIS-RFI], the maximum value for the length octet in any TLV is 254. This places limitations on the number of repeated sub-TLVs that can be included within any TLV.

Table 5-1 – Summary of DCD TLV parameters

Type	Length	Name	DSG agent	DSG client controller	Mandatory /Optional in DCD	Repeatable in DCD
23	–	Downstream Packet Classification Encoding	√	√	O	√
23.2	2	Classifier Identifier	√	√	M	
23.5	1	Classifier Priority	√	√	M	
23.9	-	IP Packet Classification Encodings	√	√	M	
23.9.3	4	Source IP Address	√	√	O	
23.9.4	4	Source IP Mask	√	√	O	
23.9.5	4	Destination IP Address	√	√	M	
23.9.9	2	Destination TCP/UDP Port Start		√	O	
23.9.10	2	Destination TCP/UDP Port End		√	O	
50	–	DSG Rule		√	O	√
50.1	1	DSG Rule Identifier		√	M	
50.2	1	DSG Rule Priority		√	M	
50.3	n	DSG UCID List		√	O	
50.4	–	DSG Client ID		√	M	
50.4.1	0	DSG Broadcast		√	O	√
50.4.2	6	DSG well-known MAC Address		√	O	√
50.4.3	2	CA System ID		√	O	√
50.4.4	2	Application ID		√	O	√
50.5	6	DSG Tunnel Address	√	√	M	
50.6	2	DSG Classifier Identifier	√	√	O	√
50.43	–	DSG Rule Vendor-Specific Parameters		√	O	√
51	–	DSG Configuration		√	O	
51.1	4	DSG Channel List Entry		√	O	√
51.2	2	DSG Initialization Timeout (Tdsg1)		√	O	
51.3	2	DSG Operational Timeout (Tdsg2)		√	O	
51.4	2	DSG Two-Way Retry Timer (Tdsg3)		√	O	
51.5	2	DSG One-Way Retry Timer (Tdsg4)		√	O	
51.43	–	DSG Config Vendor-Specific Parameters		√	O	√

5.3.1.1 DSG classifier

DSG Classifiers are for classifying packets and are coded as TLV tuples. The definitions of the TLV values are defined in the clause "Packet Classification Encodings" in Annex C of [DOCSIS-RFI]. The DSG Classifier parameters are set through the DSG MIB. They are not intended to be configured via a CM Configuration File. When a DSG Classifier is configured to be included in the DCD, the DSG Agent MUST include the DSG Classifier in the DCD message on the downstream channel to which the Classifier applies. The DSG Classifier ID is unique per DSG Agent.

The DSG Agent applies the DSG Classifier parameters to incoming packets from the DSG Server in order to assign the packet to the appropriate DSG Tunnel. The DSG Agent MUST classify incoming packets based upon the Classification Parameters listed in Table 5-1 with the exception of the UDP Port.

The DSG Client Controller will use the DSG Classifier parameters to establish a packet filter on the DSG eCM for the downstream DSG Tunnel packet flow. DSG Tunnel packets which match filters established by the DSG Client Controller MUST be forwarded by the DSG eCM.

The DCD message, which is intended for use by the DSG Client Controller, may include any of the Classification Parameters in Table 5-1. The DCD message MUST NOT include any classification parameters not listed in Table 5-1. The DSG Agent MUST NOT include any Ethernet LLC Packet Classification Encodings as these might interfere with the DSG Rule parameters.

Type	Length	Value
23	n	

5.3.1.2 DSG rule

The DSG Agent MUST support all DSG Rule TLVs.

The DSG Rule is only intended to be included in the DCD message and is not intended to be included in the CM Configuration File.

Type	Length	Value
50	n	

5.3.1.2.1 DSG rule identifier

The value of the field specifies an identifier for the DSG Rule. This value is unique per DCD Message. The DSG Agent assigns the DSG Rule Identifier.

Type	Length	Value
50.1	1	1-255

5.3.1.2.2 DSG rule priority

The value of the field specifies the priority for the DSG Rule, which is used for determining the order of application of the DSG Rule. A higher value indicates higher priority. The default value is 0 which is the lowest priority.

Type	Length	Value
50.2	1	0-255

5.3.1.2.3 DSG UCID list

The values of the field specify the matching parameters for the Upstream Channel ID (UCID) for which the DSG Rule applies. If this TLV is omitted, then the DSG Rule applies to all values of UCID, regardless if the UCID is known or unknown by the DSG Client Controller.

NOTE – If this TLV is included, then an additional DSG Rule would have to be written for a DSG Client Controller residing on a Set-top Device that does not have a UCID available to it because the DSG eCM is operating in one-way mode. This additional DSG Rule would be given a lower DSG Rule Priority, while the DSG Rule with the UCID TLV would be assigned a higher DSG Rule Priority.

UCIDs are 8-bit unsigned integers.

Type	Length	Value
50.3	n	<UCID-1>, <UCID-2>, ... , <UCID-n>

5.3.1.2.4 DSG client ID

The value of the field specifies the matching parameters for the DSG Client ID for which the DSG Rule applies. A DSG Rule will apply to a DSG Client if there is a match on one of the DSG Client ID fields AND a match on the UCID List (if present).

The DSG Client ID recognizes that IDs may originate from different address spaces. Each of those address spaces are coded as sub-TLVs within the DSG Client ID TLV. These sub-TLVs MAY be repeated within the DSG Client ID TLV to include additional DSG Client IDs. The same DSG Client ID MAY be listed in more than one DSG Rule. If the same DSG Client ID is listed in more than one DSG Rule, the expected behaviour of the DSG Client Controller is to take the DSG Rule Priority field into account when applying DSG Rules.

The DSG Agent MUST support all ID types.

Type	Length	Value
50.4	n	

5.3.1.2.4.1 DSG broadcast ID

Traffic for a DSG Client ID of this type conforms to specific industry standards. This traffic is received by a DSG Client that operates with standard data. A DSG Client ID of this type should not have a Length of zero (0). If the Length is 0 then the DSG Client Controller should disregard the rule if a Length of zero is not supported by the DSG Client Controller (the use of this subtype with Length 0 is deprecated). If the Length is 2 and the Value is non-zero, a specific type of industry-standard data is denoted per Table 5-2. The DCD MUST NOT contain a DSG Broadcast ID TLV of Length 2 and Value 0.

NOTE 1 – Client behaviour is not defined if data streams for multiple standards are mixed into a single tunnel, and provisioning by the operator is expected to prevent such mixing.

NOTE 2 – The DCD can contain multiple rules with a DSG Broadcast ID, each to indicate the presence of a specific industry-standard data stream.

Subtype	Length	Value
50.4.1	0	Unspecified broadcast; the use of this subtype with Length 0 is deprecated
50.4.1	2	As defined in Table 5-2

Table 5-2 – DSG broadcast ID value definitions

Value	Definition
0	Prohibited
1	Contains J.94 [J.94] – Delivery as defined in Annex D
2	Contains EAS [SCTE-18] – Delivery as defined in Annex D
3	Contains OCAP Object Carousel [OC-SP-OCAP1.0]: The use of this value is deprecated*.
4	Contains OpenCable Common Download Carousel [OC-SP-CD-IF]. The use of this value is deprecated.
5	Contains XAIT and/or CVT data as specified in [OC-SP-CD-IF] – Delivery as defined in Annex D.
6-55534	Reserved for future use
55535-65535	Reserved for operator specific use
* Carousel data will be carried in tunnels labeled with Application Client IDs.	

5.3.1.2.4.2 DSG well-known MAC address

A DSG Client ID of this type is received by a DSG Client that has been assigned a MAC Address. The first three bytes of the MAC address are known as the Organizationally Unique Identifier (OUI) as defined in [OUI]. The MAC address is assigned by the DSG Client Controller.

Subtype	Length	Value
50.4.2	6	dst1, dst2, dst3, dst4, dst5, dst6

NOTE – The Well-Known MAC address can be used as a transition from the DSG Basic mode deployment to DSG advanced mode deployment.

5.3.1.2.4.3 CA system ID

A DSG Client ID of this type is received by a DSG Client that has been assigned a CA_system_ID as defined by [MPEG-SI] and assigned by [CAS ID]. The CA_system_ID is sent "uimsbf" (unsigned integer most significant bit first).

Subtype	Length	Value
50.4.3	2	CA_system_ID

5.3.1.2.4.4 Application ID

A DSG Client ID of this type is received by a DSG Client that has been assigned an Application ID. The Application ID is sent "uimsbf" (unsigned integer most significant bit first). The Application ID would be taken from a private address space managed by the operator. The Application ID can be assigned to the DSG Client from a table contained within the DSG Broadcast Tunnel such as the Source Name Subtable (SNS) as defined in [ITU-T J.94]. (Refer to Annex D for information on the delivery of ITU-T J.94 tables.)

There may be one or more applications per DSG Tunnel. There may be one or more DSG Tunnels that are used for carrying application traffic.

Subtype	Length	Value
50.4.4	2	Application_ID

5.3.1.2.5 DSG tunnel address

This is the destination MAC address that will be used for the DSG Tunnel. This TLV allows the DSG Tunnel Address to be dynamically remapped to another MAC address. A 3.0 DSG eCM with Multicast DSID forwarding enabled only uses the DSG Tunnel address to identify the DSID for the DSG tunnel Data from the DA-to-DSID Association Entry TLV.

Type	Length	Value
50.5	6	Destination MAC Address of the DSG Tunnel

5.3.1.2.6 DSG classifier identifier

The value of the field specifies a Classifier Identifier that identifies the corresponding DSG Classifier to be used with this DSG Rule. The Classifier Identifier MUST correspond to a DSG Classifier included in the same DCD message.

This TLV may be repeated within a DSG Rule to include additional DSG Classifiers.

Type	Length	Value
50.6	2	1-65535

5.3.1.2.7 DSG rule vendor-specific parameters

This allows vendors to encode vendor-specific DSG parameters within a DSG Rule. The Vendor ID MUST be the first TLV embedded inside Vendor-Specific Parameters. If the first TLV inside Vendor-Specific Parameters is not a Vendor ID, then the TLV will be discarded. Refer to [DOCSIS-RFI] for the definition of Vendor ID.

This TLV may be repeated within a DSG Rule to include additional DSG Rule Vendor-Specific Parameters. The length (n) of this TLV can be between 5 and 55 bytes (5 bytes for the Vendor ID, and up to 50 bytes for the subsequent values).

Type	Length	Value
50.43	n	

5.3.1.3 DSG configuration

This group of TLVs contains parameters for configuration and operation of the DSG eCM. The DSG Channel List allows a DSG Agent to advertise which downstreams contain DSG Tunnels. This is intended to reduce the Set-top Device initial scan time.

The state machines of the DSG eCM in the Set-top Device have several timer values which define the operation of DSG. The set of DSG Timer TLVs allows those timer values to be dynamically provisioned from the DSG Agent.

Type	Length	Value
51	n	

5.3.1.3.1 DSG channel list entry

The value of this field is a receive frequency that is available to be used by the Set-top Device for receiving DSG Tunnels. This TLV MAY be repeated to create a DSG Channel List which would be a list of downstreams containing DSG Tunnels. This DSG Channel List may be transmitted on any DOCSIS downstream channel, regardless of the presence or absence of DSG Tunnels on that channel. This TLV may be the only TLV present in the DCD message, or it may co-exist with other TLVs within the DCD Message.

This is the centre frequency of the downstream channel in Hz stored as a 32-bit binary number. The receive frequency assigned by the CMTS MUST be a multiple of 62 500 Hz.

NOTE – The intent of the DSG Channel List is to contain a list of all the downstream frequencies that contain DSG Tunnels.

Type	Length	Value
51.1	4	Rx Frequency

5.3.1.3.2 DSG initialization timeout (Tdsg1)

This is the timeout period for the DSG packets during initialization of the DSG eCM defined in seconds. The default value is 2 seconds. If this sub-TLV is present, it is intended to overwrite the default value of Tdsg1 in the DSG eCM initialization state machine. If the DSG Initialization Timeout sub-TLV is not present, then the DSG eCM MUST utilize the default value. The valid range of values is 1 to 65535.

Type	Length	Value
51.2	2	Tdsg1 (in seconds)

5.3.1.3.3 DSG operational timeout (Tdsg2)

This is the timeout period for the DSG packets during normal operation of the DSG eCM defined in seconds. The default value is 600 seconds. If this sub-TLV is present, it is intended to overwrite the default value of Tdsg2 in the DSG eCM operational state machine. If the DSG Operational Timeout sub-TLV is not present, then the DSG eCM MUST utilize the default value. The valid range of values is 1 to 65535.

Type	Length	Value
51.3	2	Tdsg2 (in seconds)

5.3.1.3.4 DSG two-way retry timer (Tdsg3)

This is the retry timer that determines when the DSG eCM attempts to reconnect with the CMTS and establish two-way connectivity defined in seconds. The default value is 300 seconds. If this sub-TLV is present, it is intended to overwrite the default value of Tdsg3 in the DSG eCM operational state machine. If the DSG Two-Way Retry Timer sub-TLV is not present, then the DSG eCM MUST utilize the default value. The valid range of values is 0 to 65535. A value of zero (0) indicates that the DSG client must continuously retry two-way operation.

Type	Length	Value
51.4	2	Tdsg3 (in seconds)

5.3.1.3.5 DSG one-way retry timer (Tdsg4)

This is the retry timer that determines when the DSG eCM attempts to rescan for a downstream DOCSIS channel that contains DSG packets after a Tdsg2 timeout defined in seconds. The default value is 1800 seconds. If this sub-TLV is present, it is intended to overwrite the default value of Tdsg4 in the DSG eCM operational state machine. If the DSG One-Way Retry Timer sub-TLV is not present, then the DSG eCM MUST utilize the default value. Valid range of values is 0 to 65535. A value of zero (0) indicates the DSG client must immediately begin scanning upon Tdsg1 or Tdsg2 timeout.

Type	Length	Value
51.5	2	Tdsg4 (in seconds)

5.3.1.3.6 DSG configuration vendor-specific parameters

This allows vendors to encode vendor-specific parameters outside the DSG Rule but within the DCD message. The Vendor ID MUST be the first TLV embedded inside Vendor-Specific Parameters. If the first TLV inside Vendor-Specific Parameters is not a Vendor ID, then the TLV will be discarded. Refer to [DOCSIS-RFI] for the definition of Vendor ID.

This TLV may be repeated within a DSG Rule to include additional DSG Configuration Vendor-Specific Parameters. The length (n) of this TLV can be between 5 and 55 bytes (5 bytes for the Vendor ID, and up to 50 bytes for the subsequent values).

Type	Length	Value
51.43	n	

5.3.2 DSG service class

The DSG Service Class is used to manage the Quality of Service of the DSG Tunnels within the DSG Agent. The DSG Service Class is identified with a Service Class Name and has an associated QoS Parameter Set. The DSG Service Class parameters are set through the DSG MIB. Multiple DSG Tunnels may reference the same DSG Service Class. Each DSG Tunnel MUST only have one Service Class reference. The DSG Service Class parameters are not intended to be included in the DCD message or the CM Configuration File.

The DSG Agent MUST recognize the following DSG Service Class Parameters. These parameters are defined in the clause "Service Flow Encodings" in Annex C of [DOCSIS-RFI].

- Service Class Name;
- Traffic Priority;
- Downstream Maximum Sustained Traffic Rate (R);
- Maximum Traffic Burst (B);
- Minimum Reserved Traffic Rate;
- Assumed Minimum Reserved Rate Packet Size.

5.4 DSG eCM operation

This clause describes the behaviour of DSG eCMs for two different versions of DOCSIS.

- Clause 5.4.3 describes the behaviour of Pre-3.0 DOCSIS DSG eCMs
- Clause 5.4.4 describes the behaviour of DOCSIS 3.0 DSG eCMs. A DOCSIS 3.0 DSG eCM follows the initialization sequence outlined in these clauses even if it is registering on a Pre-3.0 DOCSIS DSG CMTS.

5.4.1 DSG modes

The DSG Client Controller, acting on behalf of a Client (or Clients) instructs the eCM to begin DSG operation. In DSG Advanced Mode the DSG Client Controller becomes aware of operator defined tunnel MAC addresses by indexing into the DSG Address Table in the DCD message.

The following requirements apply to the DSG eCM:

- The DSG eCM MUST NOT begin DSG operation unless explicitly instructed to do so by the DSG Client Controller. (Figures 5-11 and 5-29)
- The DSG eCM MUST forward the unaltered contents of each DCD fragment that comprises the first DCD message received to the DSG Client Controller.
- After any change in the DCD message (as indicated by the change count) the DSG eCM MUST forward the unaltered contents of each DCD fragment that comprises the new DCD message to the DSG Client Controller.
- The DSG eCM MUST scan additional downstream channels for a DCD message if the DSG Client Controller indicates that the DCD message was in error or invalid.
- If the DSG eCM has been unable to identify a downstream channel with an appropriate DCD message after a complete downstream scan, it MUST inform the DSG Client Controller that it could not locate a DCD message and continue scanning.

5.4.2 DSG eCM initialization and operation

The DSG eCM will have an initialization sequence that differs from the standard DOCSIS cable modem, primarily related to how the DSG eCM responds to the various timeouts and error conditions. The DSG eCM will remain tuned to a DOCSIS downstream containing DSG packets and continue to process the IP packets carried in the DSG tunnel even when the return channel is impaired or two-way connectivity is lost. This is necessary to enable the delivery of downstream OOB messages regardless of two-way capabilities.

The Pre-3.0 DOCSIS DSG eCM initialization sequence is based on the CM initialization sequence defined in the "Cable Modem Initialization" clause of [DOCSIS-RFI]. The DOCSIS 3.0 DSG eCM initialization sequence is based on the CM initialization sequence defined in clause 10.2 of [J.222.2]. The differences from the DOCSIS standard are detailed in the following clauses as well as highlighted in gray in the accompanying figures. The DSG eCM initialization sequence introduces two new timers and two new retry timers. These are:

- Tdsg1 – The timeout period for the DSG channel during initialization of the DSG eCM.
- Tdsg2 – The timeout period for the DSG channel during normal operation of the DSG eCM.
- Tdsg3 – Two-way retry timer – The retry timer that determines when the DSG eCM attempts to reconnect with the CMTS and establish two-way connectivity.
- Tdsg4 – One-way retry timer – The retry timer that determines when the DSG eCM attempts to rescan for a downstream DOCSIS channel that contains DSG packets after a Tdsg2 timeout.

When operating in DSG Advanced mode, the DSG eCM MUST use the default timer values as specified in clauses 5.3.1.3.2 through 5.3.1.3.5 unless they are overridden by the DSG Client Controller in response to an override from a DCD message. If the default timer values are overridden by the DSG Client Controller, the DSG eCM MUST use those updated values until it is rebooted or another override is received.

In general, the intent of this initialization sequence is to avoid rebooting the DSG eCM if at all possible and to continue to receive downstream OOB messages via DSG in all cases. To achieve this, the DSG Specification introduces a one-way mode of operation that is distinguished from normal two-way DOCSIS operation by remaining tuned to and processing the DOCSIS downstream during periods when the upstream channel is impaired or other timeout conditions occur. As shown in the following clauses, this is achieved by modifying all instances that would result in re-initializing the MAC layer in DOCSIS to go to the one-way mode of operation. The DSG eCM recovers from these error conditions by periodically attempting to reacquire the upstream channel and establish two-way connectivity.

When a DSG eCM loses its upstream channel capability, either through upstream channel impairment or other reasons, it will no longer respond to periodic ranging requests from the CMTS. The CMTS will eventually de-register the DSG eCM. Consequently, when the DSG eCM attempts to reacquire two-way connectivity it will begin the Upstream Acquisition process by collecting UCD messages or by resolving MD-US-SG (3.0 DSG eCM only).

Further, since the DSG tunnel is not guaranteed to be present on all downstream DOCSIS channels, the initialization sequence is also modified to make certain that a valid DOCSIS downstream is acquired that is deemed by the DSG Client Controller as a Valid DSG channel.

The DSG Client Controller needs to be made aware of any eCM limitations that may impact 2-Way data forwarding, so it can provide the proper reactions on such limitations. If data forwarding to any or all of the eSTB MAC addresses cannot be supported, the eCM MUST report these limitations to the DSG Client Controller.

5.4.2.1 DCC considerations for DSG eCMs

The DSG Client Controller needs to be made aware of DCC operations so it can track DCC progress; provide the proper reactions to upstream and downstream channel changes; and maintain a valid DSG channel. Such DCC operations are bracketed in time between two CM-generated messages: DCC-RSP (Depart) and DCC-RSP (Arrive) [DOCSIS-RFI].

- When the CM sends a "DCC-RSP (Depart)" message, the eCM MUST also send a "DCC Depart, Initialization Type <IT>" (where IT = "DCC initialization type") message to the DSG Client Controller.
- When the CM sends a "DCC-RSP (Arrive)" message, the eCM MUST also send a "2-Way OK, UCID <P1>" (where P1 = Upstream Channel ID) message to the DSG Client Controller.

5.4.2.2 DBC considerations for DOCSIS 3.0 DSG eCMs

In a set-top box containing a DOCSIS 3.0 DSG eCM, the DSG Client Controller needs to be made aware of DBC operations so it can track DBC progress, provide the proper reactions to upstream and downstream channel changes, and maintain a valid DSG channel. On a DOCSIS 3.0 DSG eCM, if the DBC changes the primary downstream channel or changes the upstream with the lowest numbered UCID, the eCM sends the "DCC depart message" to the DSG Client Controller. The intent here is to reuse the DCC Depart message from the Pre-3.0 DOCSIS eCMs for the DBC case as well, so that the DSG Client Controller does not see any differences with respect to DOCSIS 3.0 or pre-3.0 DOCSIS DSG eCMs. The eCM MUST send the "DCC Depart Message" before it sends the DBC-RSP. The eCM SHOULD send the "DCC Depart Message" prior to implementing the changes indicated in the DBC-REQ.

After a successful DBC operation affecting the primary downstream or the upstream with the lowest numbered UCID, when the eCM sends a "DBC-RSP" message, the eCM MUST also send a "2-Way OK, UCID <P1>" (where P1 = Upstream Channel ID) message to the DSG Client Controller.

The DSG eCM MUST initialize and operate as described in the following subclauses and their state transition diagrams. Note that the eCM MUST be prepared to receive instruction from the DSG Client Controller at any time, and act upon that instruction.

5.4.3 Pre-3.0 DOCSIS DSG eCM Operation

This clause only applies to Pre-3.0 DOCSIS DSG eCMs.

5.4.3.1 DSG eCM State Transition Diagrams

The operation of a DSG eCM is described here by two separate state machines. The first, "DSG eCM Initialization and Operation", is covered by the state transition diagrams in Figures 5-3 through 5-10 (and described in clauses 5.4.3.2 to 5.4.3.7), and the second, "DSG Operation," is covered by the state transition diagram in Figure 5-11 (and described in clause 5.4.3.8). These two different state machines operate in parallel, and the "DSG Operation" state machine provides inputs into the "DSG eCM Initialization and Operation" state machine.

These state transaction diagrams apply only to the eCM. The messages sent between the two state machines, and to and from the DSG Client Controller, are provided in the following clauses.

5.4.3.1.1 Messages sent/received by "DSG eCM Initialization and Operation"

Inputs from the DSG Operation state machine:

- Valid DSG Channel
- Invalid DSG Channel
- DCD Present (DSG Advanced Mode only)

Inputs from the DSG Client Controller:

- Disable upstream transmitter
- Enable upstream transmitter

Outputs to DSG Client Controller:

- Downstream Scan Completed
- 2-Way OK, UCID
- Entering One-way Mode
- Cannot forward 2-Way traffic, NACO <val>, Max CPE <val>
- DCC Depart, Initialization Type <IT> (where IT = "DCC initialization type")

5.4.3.1.2 Messages sent/received by "DSG Operation"

Inputs from the DSG Client Controller:

- Start DSG Advanced Mode
- Filter these MAC Addresses and Classifiers
- Not Valid. Hunt for new DSG Channel

Outputs to DSG Client Controller:

- DCD Message information

5.4.3.2 DSG eCM initialization overview

Figure 5-3 corresponds to the "CM Initialization Overview" figure in [DOCSIS-RFI]. The difference in the initialization of the DSG eCM is scanning for the downstream DSG channel and going to Two-way Operation as opposed to just becoming Operational. This process is described in detail in the following clauses.

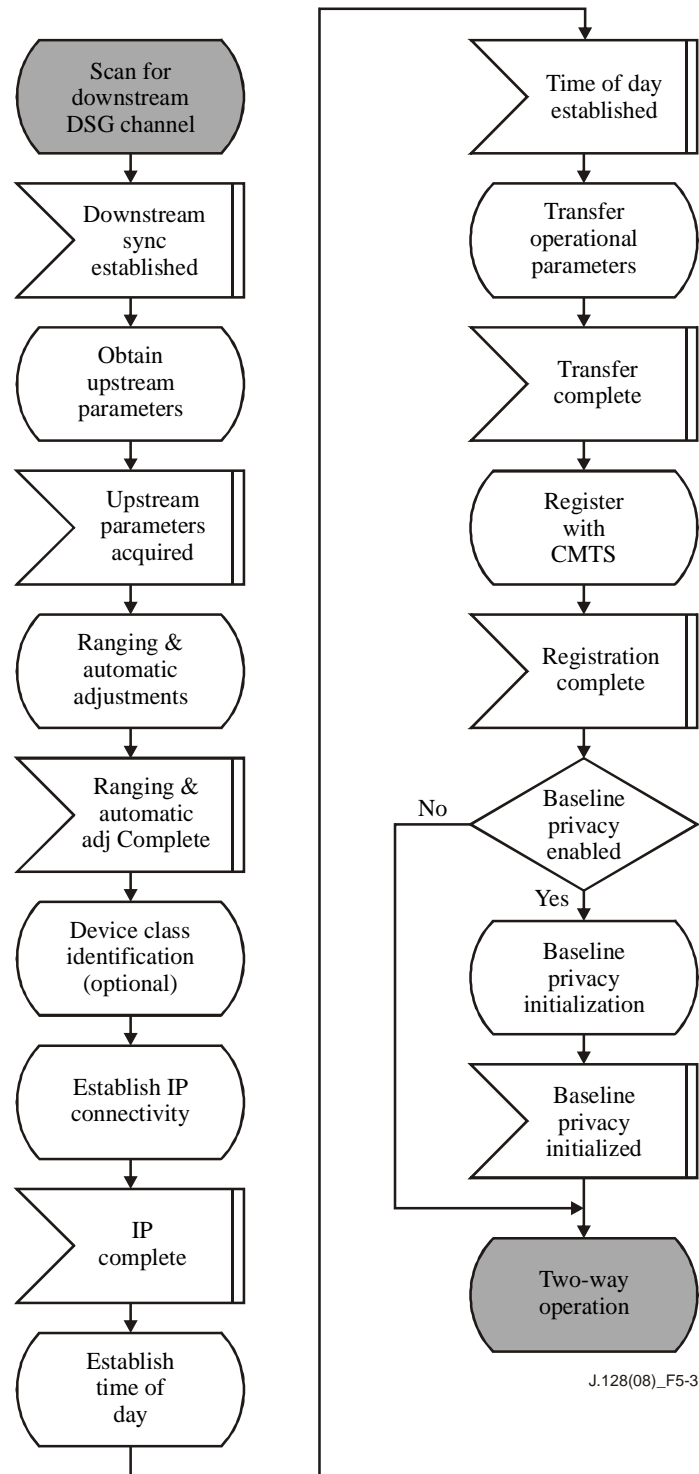

Figure 5-3 – DSG eCM initialization overview

5.4.3.3 DSG eCM scan for downstream channel

This clause corresponds to the "Scanning and Synchronization to Downstream" clause in [DOCSIS-RFI], although Figure 5-4 does not have a corresponding figure in either Recommendation. In addition to the steps required to acquire a valid downstream channel, it is necessary that the downstream channel contain appropriate DSG tunnels. If a DOCSIS downstream channel containing the appropriate DSG tunnels cannot be found, then the DSG eCM **MUST** continue scanning.

The DSG eCM **MUST** have its DSG Mode set to Advanced at startup before scanning for a downstream channel.

When operating in DSG Advanced mode, the DSG Client Controller may provide the DSG eCM with a list of downstream frequencies which have been derived from the DSG Channel List portion of the DCD message. This list is meant to aid the DSG eCM in acquiring an appropriate downstream rapidly. Note that once the DSG eCM receives a configuration file via the registration process, the requirements relating to the Downstream Frequency Configuration Setting (TLV1) and the Downstream Channel List (TLV41) as described in [DOCSIS-RFI] still apply.

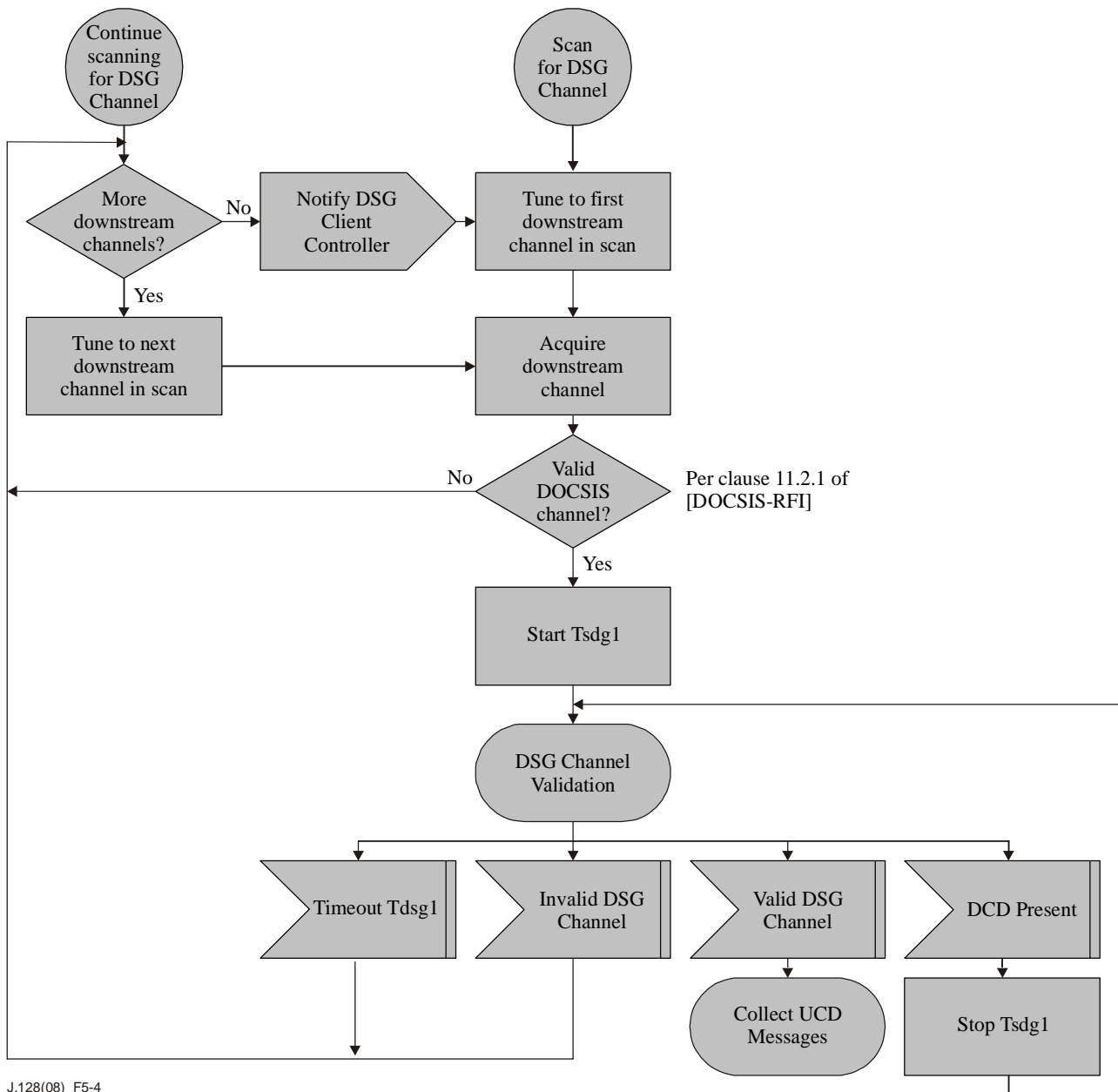

Figure 5-4 – DSG eCM scan for downstream DSG channel

5.4.3.4 DSG eCM obtain upstream parameters

This clause corresponds to the "Obtain Upstream Parameters" clause in [DOCSIS-RFI]. The difference in this case is that in the case of a T1 timeout the DSG eCM will Start One-way mode of operation.

If the T1 timer expires, the eCM MUST enter One-way mode. This requirement also covers T1 timer activity as mentioned in [J.122] related to unusable UCDs.

It should be noted that a DSG modem that does not comply with TLV19 [DOCSIS-RFI], will move to One-way mode of operation if the CMTS issues an intentional Range Abort to kick the DSG modem off an upstream that is 'reserved' via TLV19. In this case, the DSG modem will take Tdsg3 seconds (default 300 seconds) to begin another search for another upstream. The expectation is that most DSG modems will comply with TLV19.

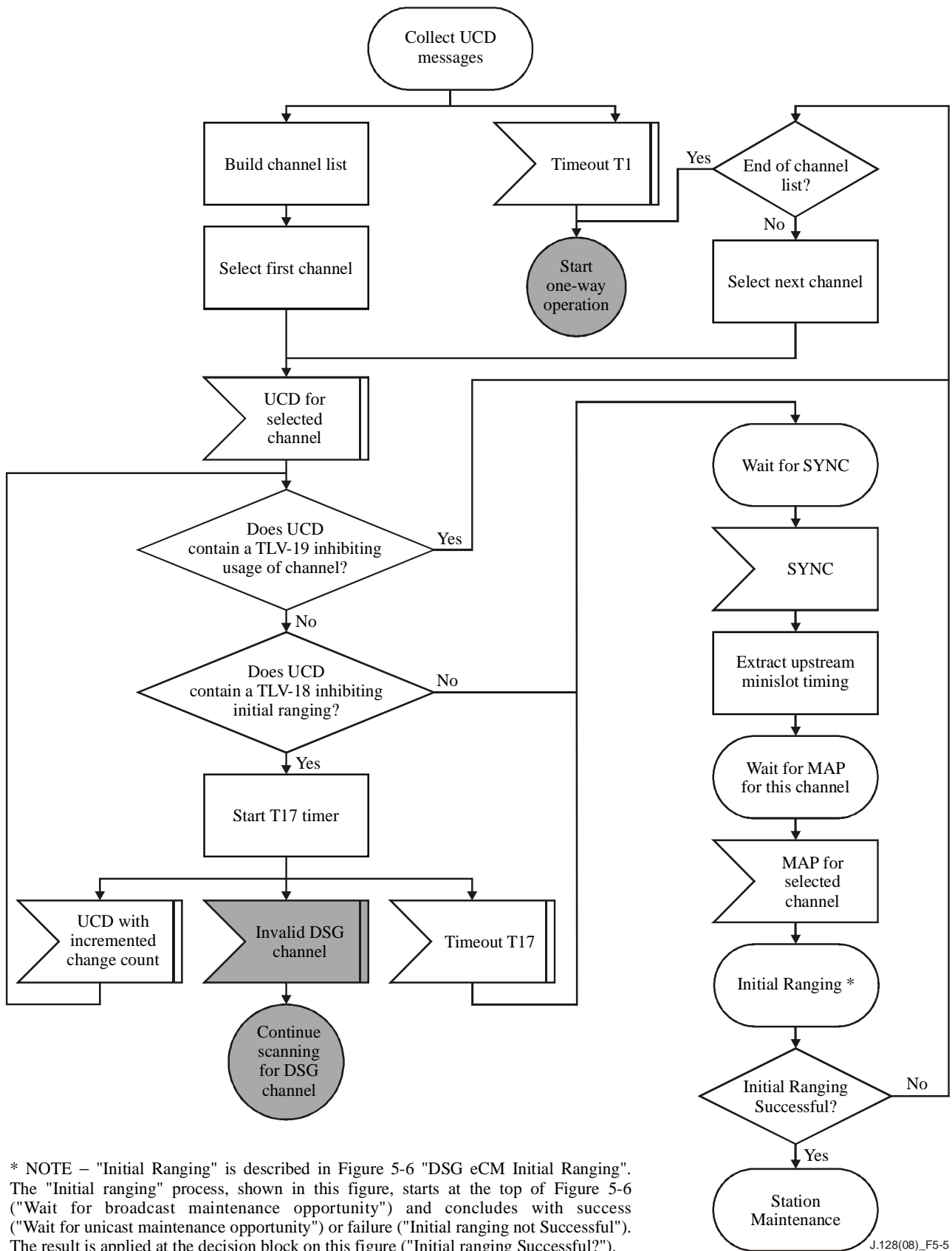
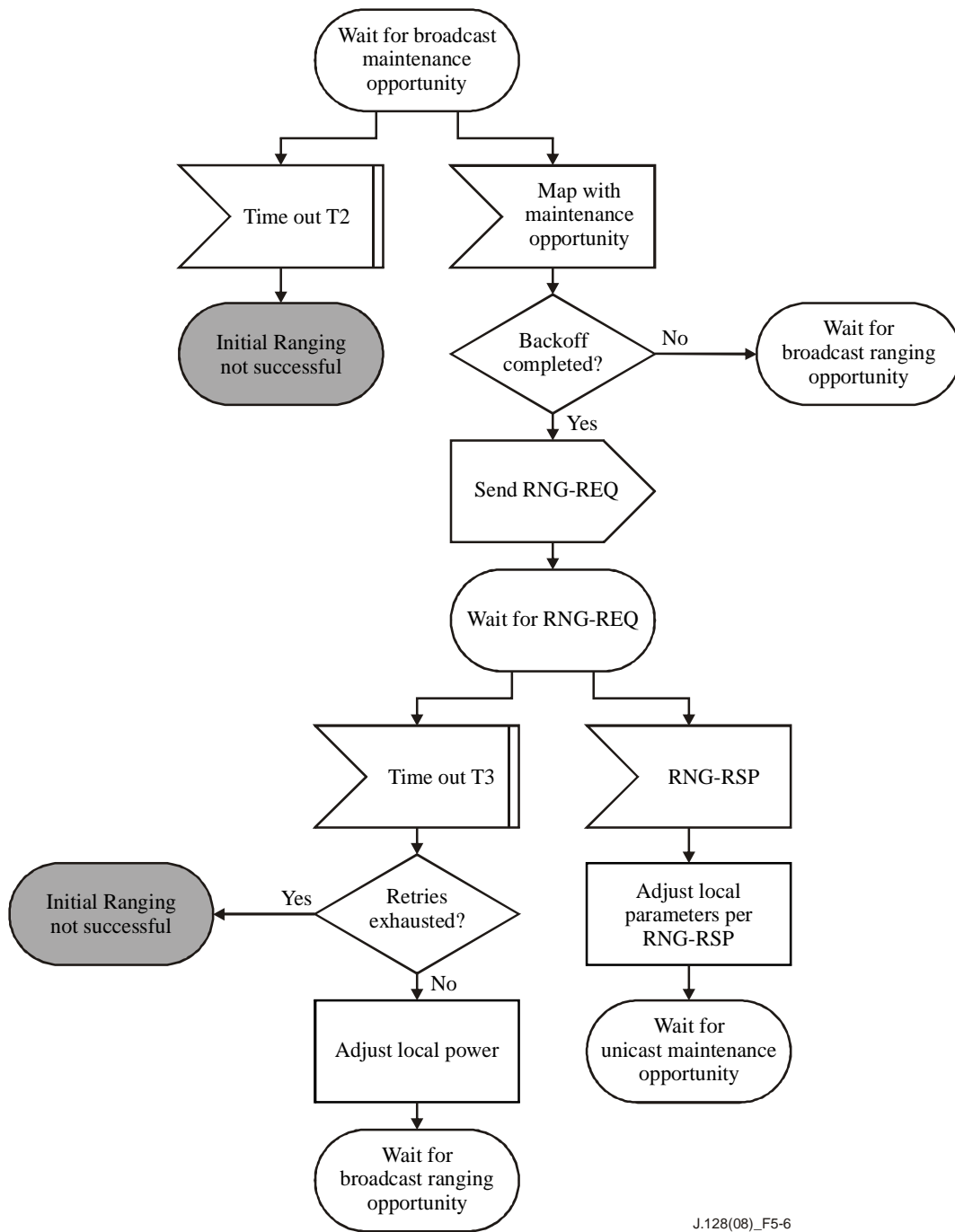

Figure 5-5 – DSG eCM obtaining upstream parameters

5.4.3.5 DSG eCM ranging and automatic adjustments

This clause corresponds to the "Ranging and Automatic Adjustments" clause in [DOCSIS-RFI]. The differences in this case are that conditions which would have caused the CM to reinitialize the MAC layer, such as a T2 or T4 timeout, or other error conditions, will instead cause either the initial ranging to fail or the eCM to start One-way mode of operation. In addition, successful ranging enables bidirectional data transfer, as opposed to just enabling data transfer, since downstream tunnel forwarding will already have been enabled.



J.128(08)_F5-6

NOTE – Timeout T3 may occur because the RNG-REQs from multiple modems collided. To avoid these modems repeating the loop in lockstep, a random backoff is required. This is a backoff over the ranging window specified in the MAP. T3 timeouts can also occur during multi-channel operation. On a system with multiple upstream channels, the CM attempts initial ranging on every suitable upstream channel before moving to One-way Operation.

Figure 5-6 – DSG eCM initial ranging

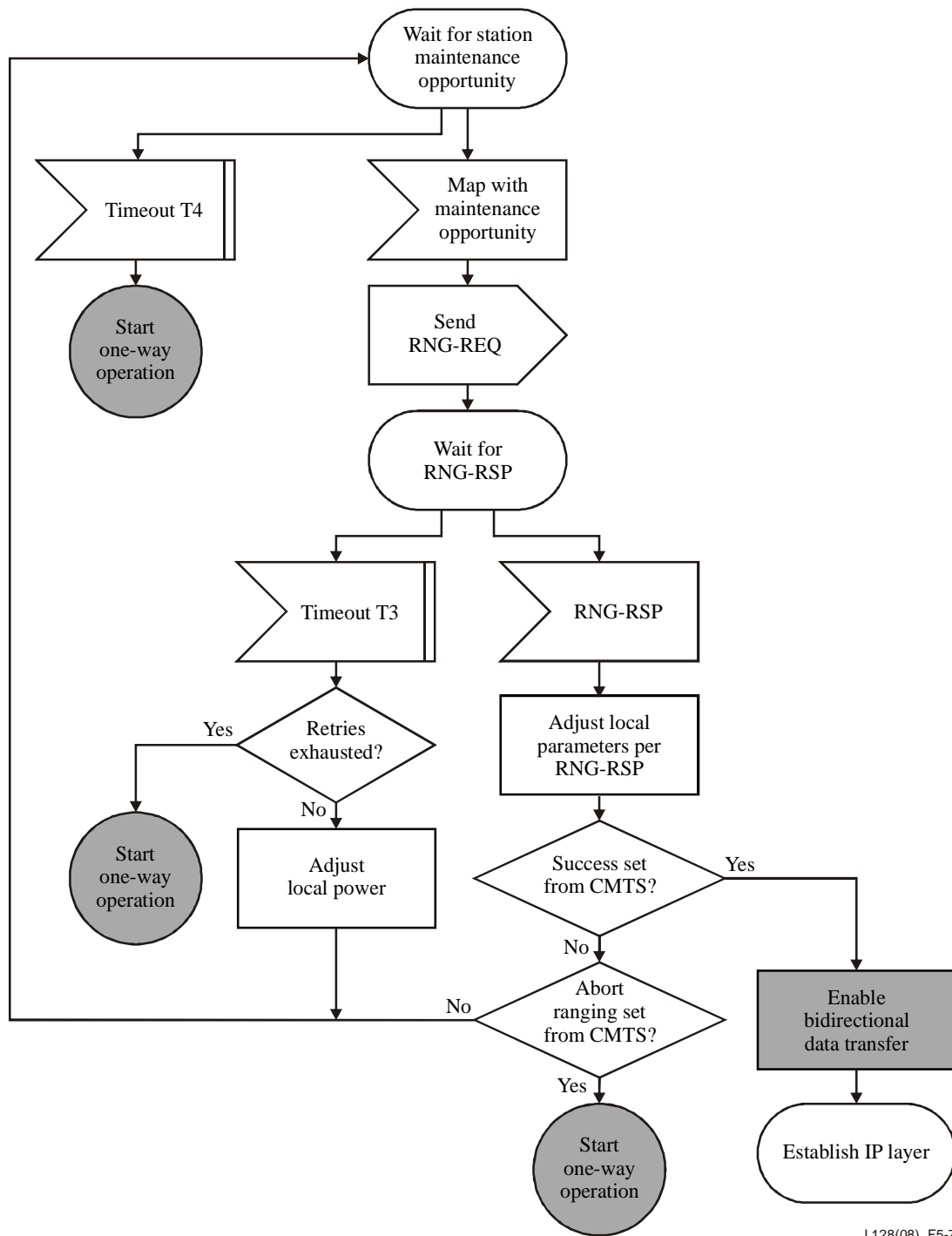

J.128(08)_F5-7

NOTE – The path between this point and Figure 5-8 is shown in Figure 5-3, namely from 'Establish IP Connectivity' through 'Establish Time of Day'.

Figure 5-7 – DSG eCM unicast station maintenance ranging

5.4.3.6 DSG eCM registration

This clause corresponds to the "Registration" clause in [DOCSIS-RFI]. The difference in this case is that when retries for the Config File are exhausted, T6 timeout retries are exhausted, there are TLV type 11 errors, or the registration response is not OK, the DSG eCM will Start One-way mode of operation. There is also a notification to the DSG Client Controller when Two-way Operation has been established.

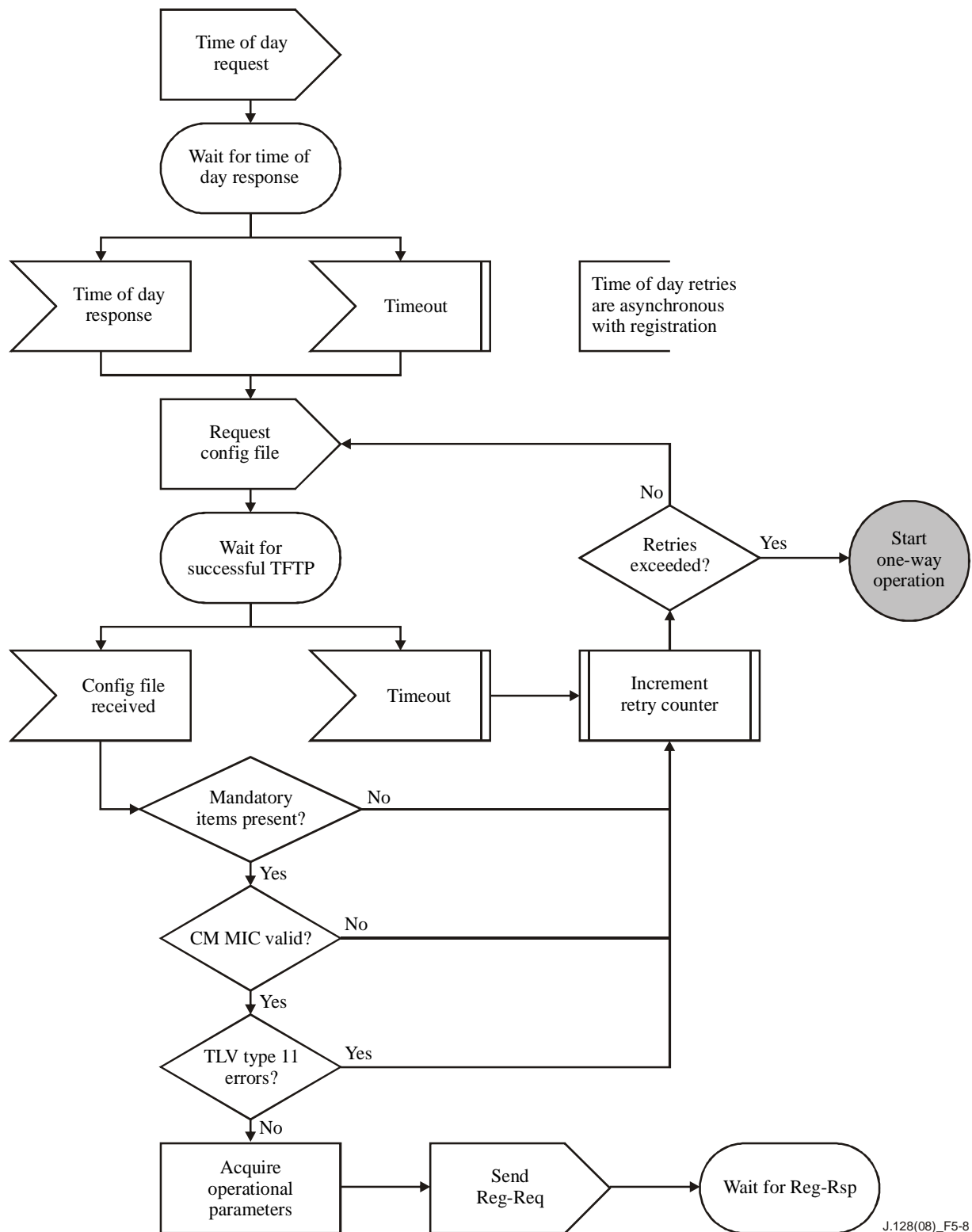
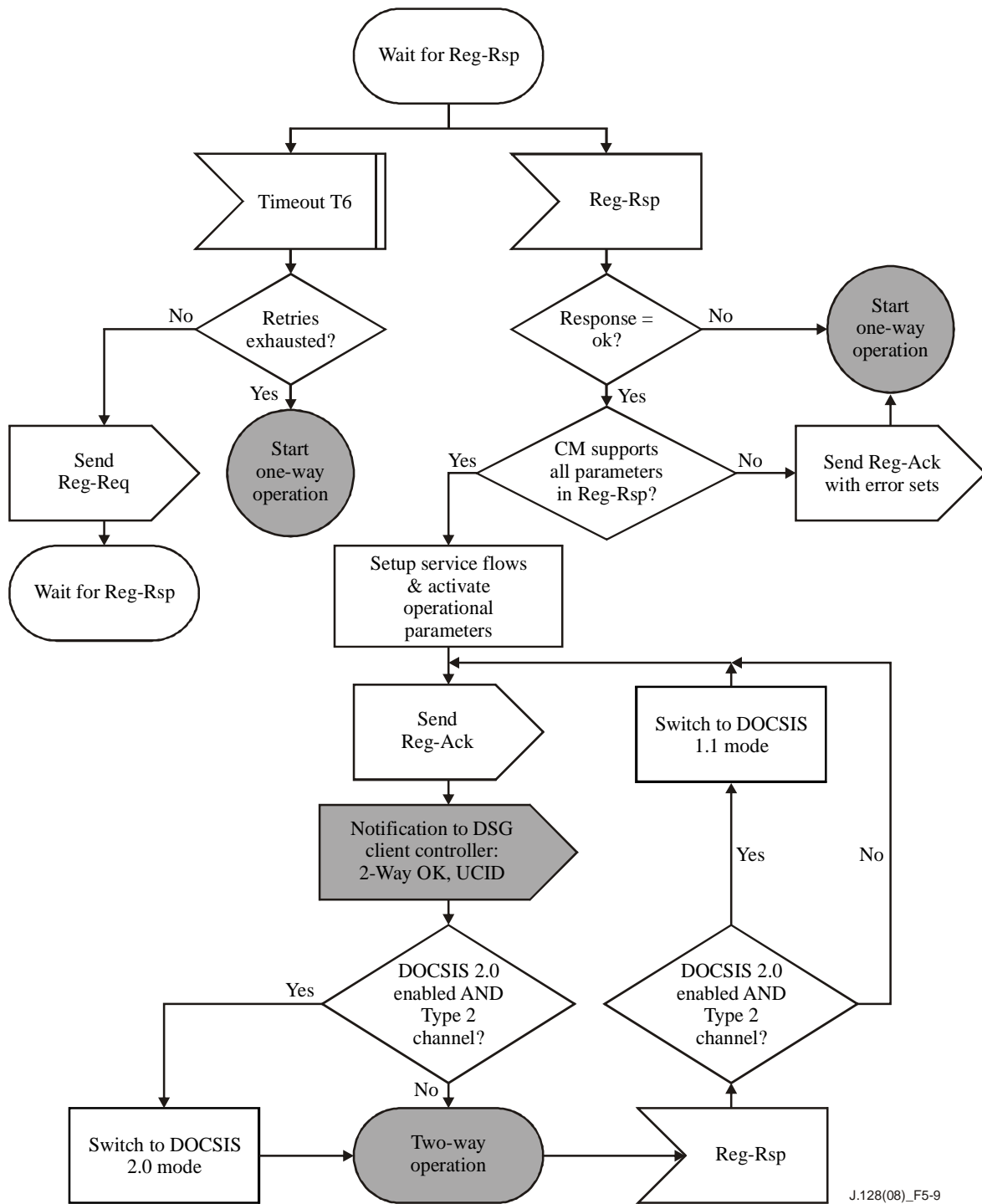

Figure 5-8 – DSG eCM registration



J.128(08)_F5-9

Figure 5-9 – DSG eCM wait for registration response

5.4.3.7 DSG eCM operation

This clause corresponds in part to the "Periodic Signal Level Adjustment" clause in [DOCSIS-RFI], although it also introduces several completely new concepts. The differences include One-way mode of operation, Two-way Operation Disabled, and the reception of a Invalid DSG Channel notification. The messages sent between the DSG Client Controller and the DSG eCM are detailed in clause 5.4.3.1.1.

When the DSG eCM enters One-way mode of operation as a consequence of any of the timeouts or error conditions indicated in the preceding clauses, it **MUST** remain tuned to and process DSG traffic on the DOCSIS downstream channel. If the eCM enters One-way mode of operation as a result of loss of downstream sync, the eCM **MAY** disable the Tdsg3 timer and refrain from attempting two-way operation until downstream sync is re-established. If the CM loses downstream sync temporarily, the eCM can still receive DSG tunnel data, but will be unable to transmit on the upstream. As long as the CM receives the DCD messages and DSG tunnel data, eCM stays on the downstream, unless there is loss of DCD messages or DSG tunnel data on that downstream channel.

When the DSG eCM enters two-way disabled operation as a consequence of being told by the DSG Client Controller to disable its upstream transmitter, it **MUST** remain tuned to and process DSG traffic on the DOCSIS downstream channel. At any point in its initialization or operational sequences, when the DSG eCM receives notification from the DSG Client Controller to disable its upstream transmitter, the DSG eCM **MUST** immediately cease using its upstream transmitter. The DSG eCM **MUST** then enter DSG Two-way Disabled operation as described in Figure 5-10.

If the eCM is unable to renew its IP address [DOCSIS-RFI], then the eCM **MUST** move to One-way mode of operation.

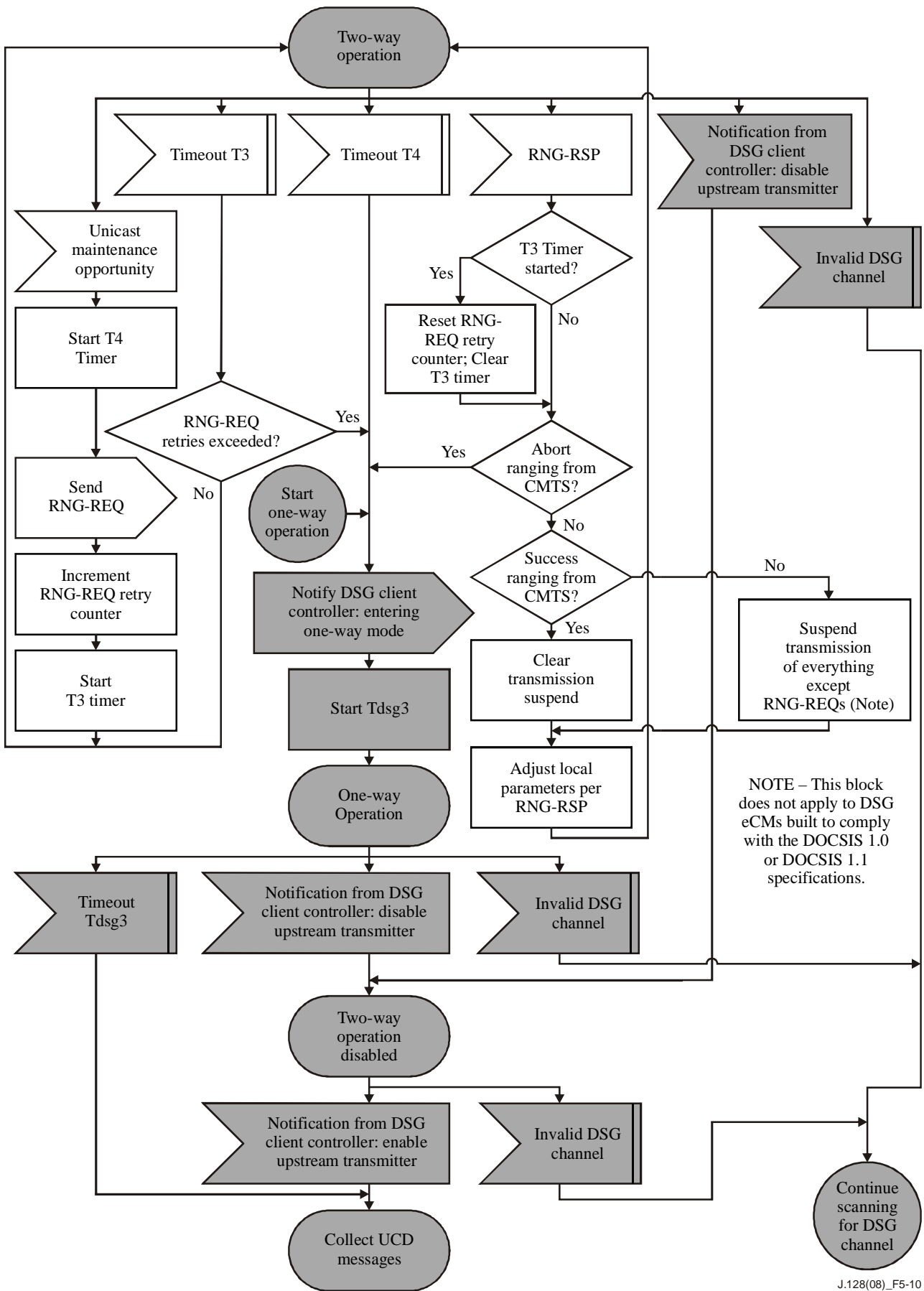

J.128(08)_F5-10

Figure 5-10 – DSG eCM operation

5.4.3.8 DSG operation

The DSG tunnel provides OOB information to the DSG Client(s) within the Set-top Device. Multiple DSG tunnels are permitted, each identified by a MAC address. To acquire data from one or more tunnels, the DSG Client Controller must be able to understand the addresses in use to define the tunnels, and must be able to request the appropriate filtering for the DSG Client.

When DSG is operational, the DSG eCM MUST operate as described in Figure 5-11.

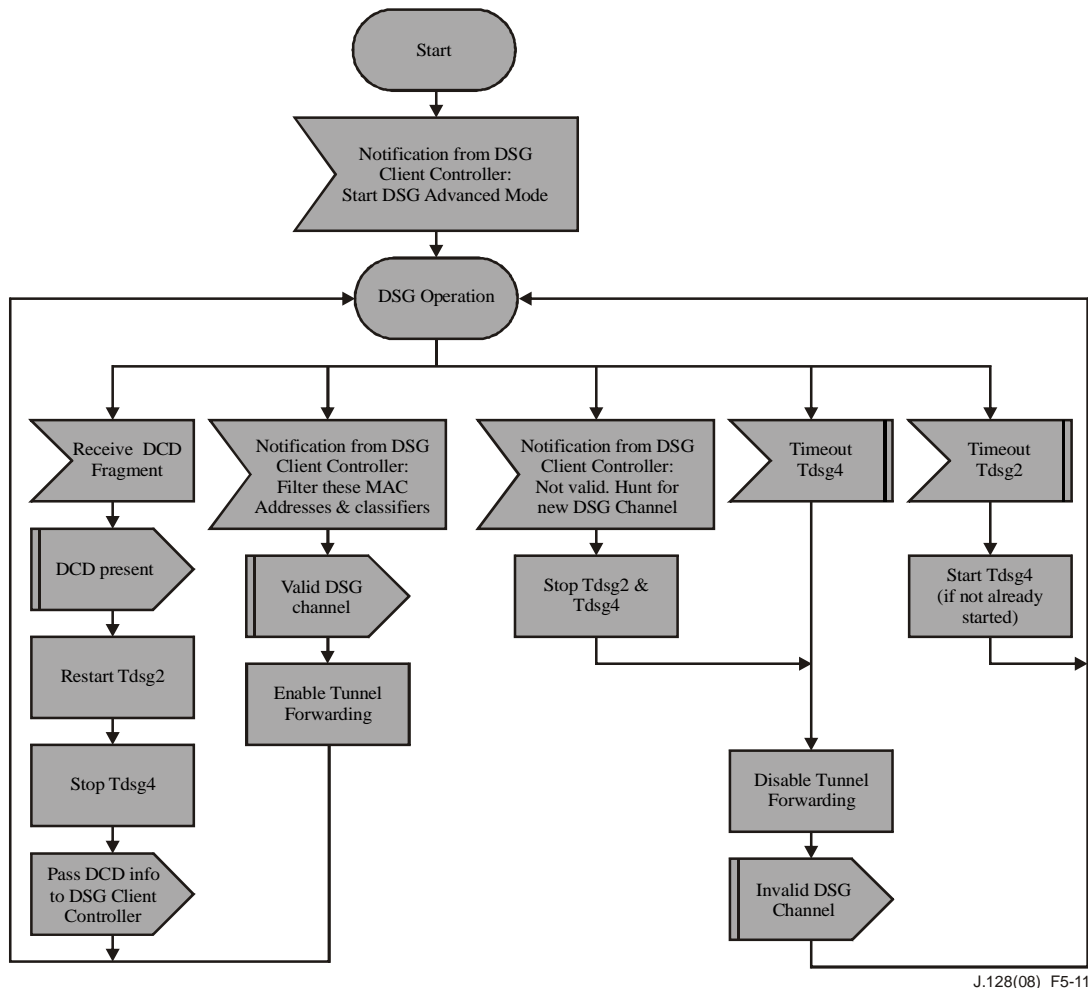

Figure 5-11 – DSG operation

5.4.4 DOCSIS 3.0 DSG eCM Operation

This clause only applies to DOCSIS-3.0 DSG eCMs.

5.4.4.1 DOCSIS 3.0 DSG eCM State Transition Diagrams

The operation of a DOCSIS 3.0 DSG eCM is described here by two separate state machines that operate in parallel. These state transaction diagrams apply only to the eCM.

The first state machine, "DSG 3.0 eCM Initialization and Operation", is covered by the state transition diagrams in Figures 5-12 through 5-28 (and described in clauses 5.4.4.2 to 5.4.4.7).

The second state machine "DSG Operation" is covered by the state transition diagram in Figure 5-29 (and described in clause 5.4.4.8). This state machine provides inputs into the "DSG eCM Initialization and Operation" state machine.

The messages sent between the two state machines, and to and from the DSG Client Controller, are provided in the following clauses. There are no messages defined to and from the DSG Client Controller other than the ones already defined in the Pre-3.0 DOCSIS DSG eCM Case.

5.4.4.1.1 Messages sent/received by "DSG eCM Initialization and Operation"

Inputs from the DSG Operation state machine & the Channel Presence validation diagram are:

- Valid DSG Channel
- Invalid DSG Channel
- DSG-Channel Found
- Continue DS Scan.

The Continue DS Scan and the DSG-Channel Found messages are only for DOCSIS 3.0 DSG eCMs but are internal to eCM state machines and do not reach the DSG Client Controller.

Inputs from the DSG Client Controller:

- Disable upstream transmitter
When the eCM is operating with Multiple Transmit Channel Mode, this message requires the CM to disable all its upstream transmissions.
- Enable upstream transmitter

Outputs to DSG Client Controller:

- Downstream Scan Completed
- 2-Way OK, UCID
When the eCM is operating with Multiple Transmit Channel Mode, the eCM sends up the lowest numbered UCID from its Transmit Channel Set (TCS).
- Entering One-way Mode
- Cannot forward 2-Way traffic, NACO <val>, Max CPE <val>
- DCC Depart, Initialization Type <IT> (where IT = "DCC initialization type")

5.4.4.1.2 Messages sent/received by "DSG Operation"

Inputs from the DSG Client Controller:

- Start DSG Advanced Mode
- Filter these MAC Addresses and Classifiers
- Not Valid. Hunt for new DSG Channel

Outputs to DSG Client Controller:

- DCD Message information

5.4.4.2 DOCSIS 3.0 DSG eCM Initialization Overview

The following figure corresponds to the "Cable Modem Initialization Overview" figure in [J.222.2]. The difference in the initialization of the DOCSIS 3.0 DSG eCM is scanning for the downstream DSG channel and going to Two-way Operation as opposed to just becoming Operational. This process is described in detail in the following clauses.

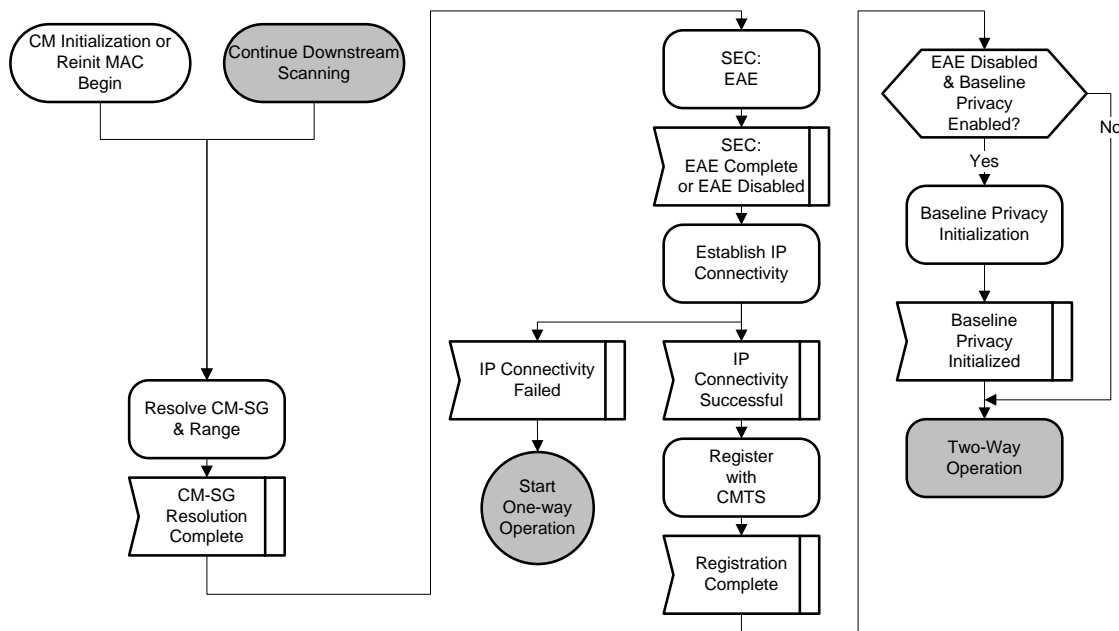

Figure 5-12 – DOCSIS 3.0 DSG eCM Initialization Overview

The DOCSIS 3.0 DSG eCM follows the initialization sequence described below.

The eCM powers up and starts scanning for a primary-capable DOCSIS Downstream channel after its DSG Mode is set to "DSG Advanced Mode" at startup by the DSG Client Controller. The eCM tries to find a DCD message on the downstream channel on which it locks. If it does not find any DCD messages, it tunes to the next primary-capable downstream channel. If the eCM finds DCD messages on the downstream channel, it looks for an MDD message with a source MAC address matching that of the DCD message.

If the eCM does not find an MDD message with the source address matching that of the DCD message, it starts the initialization process as a DSG eCM would on a DOCSIS 2.0 CMTS.

If the eCM finds MDD messages on the downstream channel, then it starts the process of Downstream Ambiguity resolution to determine which MD-DS-SG it belongs to. The MDD provides the different active downstream channels which exist in that MAC Domain.

After DS Ambiguity resolution, the eCM sends the DCD message to the DSG Client Controller. If the DSG Client Controller accepts the DCD and signals that the downstream channel is a valid DSG channel, the eCM continues with the rest of the Initialization and registration process. If the DSG Client Controller signals that the downstream channel is an invalid DSG channel, the eCM scans the other downstream channels in the MD-DS-SG for DCD messages within the MAC domain. The eCM discards any DCD messages that do not have a source MAC address matching that of the MAC domain. The eCM sends any DCD messages it finds within the MAC domain to the DSG Client Controller. If none of the DCDs on the downstream channels within the MAC domain are acceptable to the DSG Client Controller, then the eCM continues with the downstream channel scan to find the next channel with a DCD.

During the Upstream parameter acquisition and ranging process, if the eCM is unable to communicate with the CMTS, then the eCM goes into One-way mode of operation. The same happens for failure to establish IP connectivity or registration failure.

Details of each of the steps above are described in the clauses below.

5.4.4.3 DSG eCM Scan For Downstream Channel

The DOCSIS 3.0 DSG eCM will follow the initialization sequence as described in the "Scan for Downstream Channel" and "Continue Downstream channels" clauses in [J.222.2].

In addition to acquiring a valid downstream channel, it is necessary that the downstream channel contain appropriate DSG tunnels. If a DOCSIS downstream channel containing the appropriate DSG tunnels cannot be found, then the DSG eCM MUST continue scanning.

The DOCSIS 3.0 DSG eCM MUST NOT start scanning for Downstream Channels before the DSG Client Controller sets the DSG Mode to Advanced.

When operating in DSG Advanced mode, the DSG Client Controller may provide the DSG eCM with a list of downstream frequencies which have been derived from the DSG Channel List portion of the DCD message. This list is meant to aid the DSG eCM in acquiring an appropriate downstream rapidly. Note that once the DSG eCM receives a configuration file via the registration process, the requirements relating to the Downstream Frequency Configuration Setting (TLV-1) and the Downstream Channel List (TLV-41) as described in [J.222.2] still apply.

5.4.4.4 DSG eCM Service Group Discovery and Initial Ranging

This clause corresponds to the "Service Group Discovery and Initial Ranging" clause in [J.222.2]. The details of the SDL is described in the below subclauses.

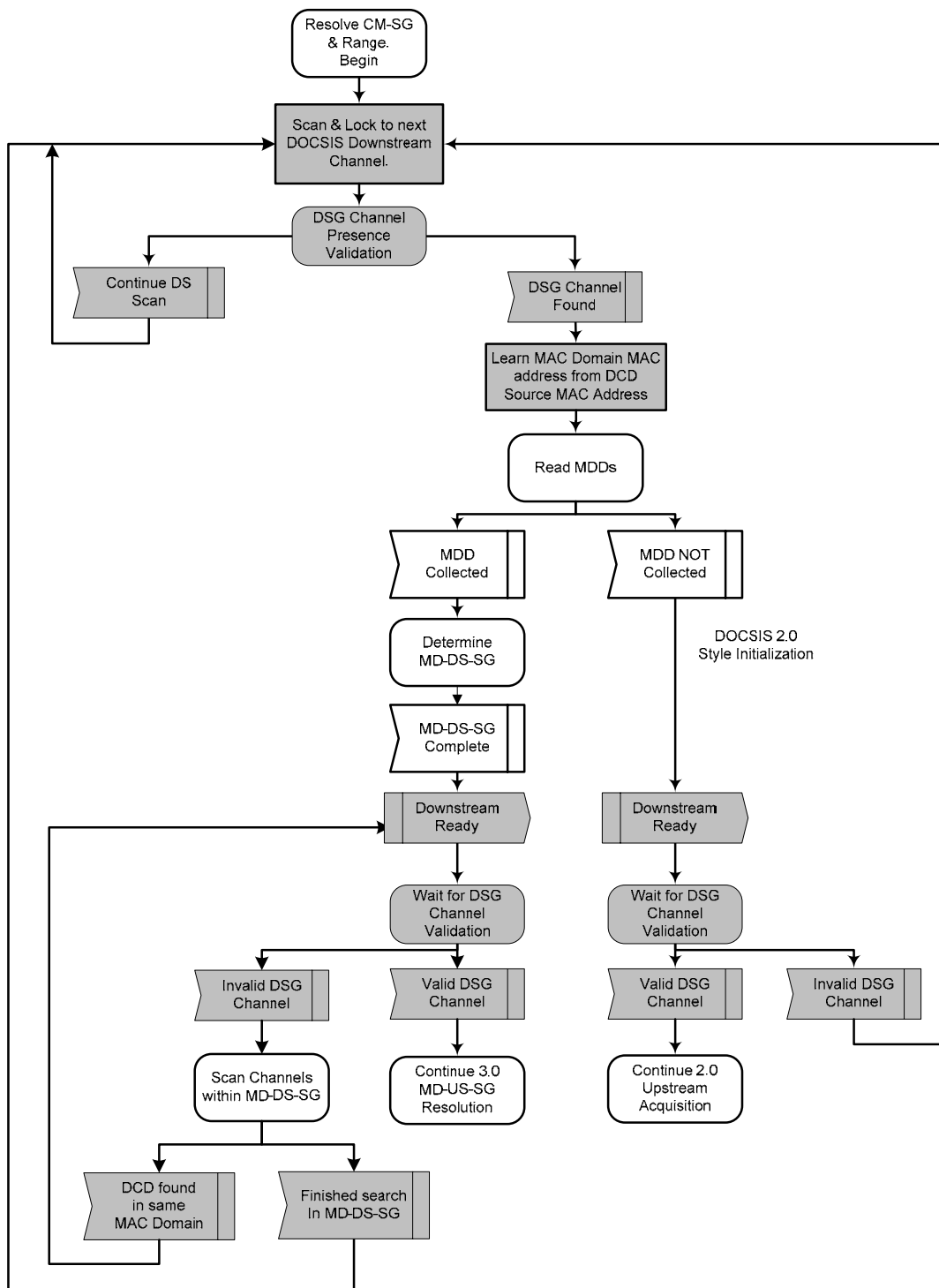

Figure 5-13 – DOCSIS 3.0 DSG eCM Scan and MD-DS-SG Resolution

The following diagram describes the steps the eCM performs to complete upstream acquisition and ranging when connected to a DOCSIS 3.0 downstream channel or to acquire an upstream when connected to a DOCSIS 2.0 downstream.

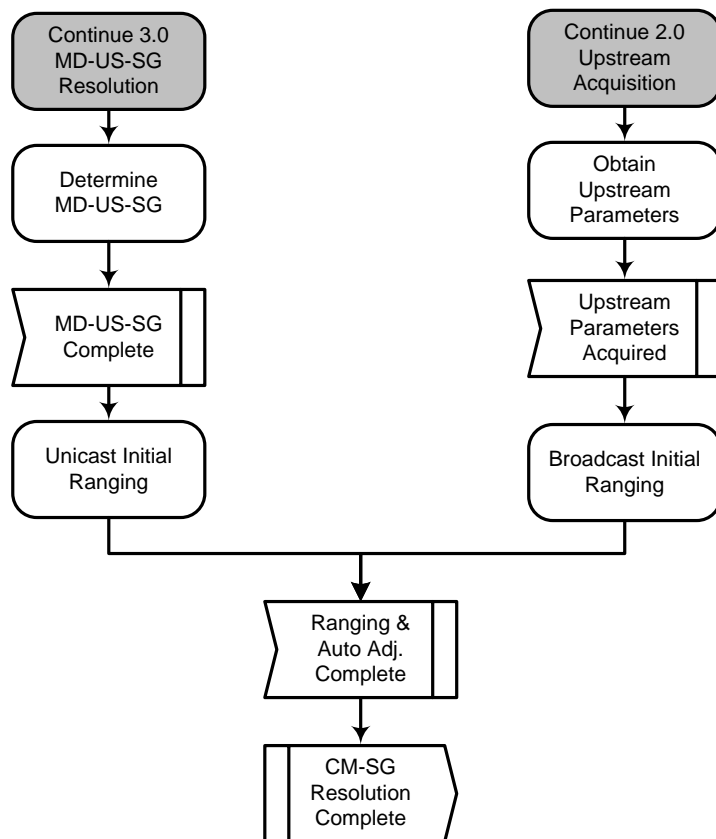

Figure 5-14 – Continue Upstream Acquisition

5.4.4.4.1 DOCSIS 3.0 DSG Channel Presence Validation

This clause describes the process by which a DOCSIS 3.0 DSG eCM determines the presence of a valid DSG channel. This was part of the DSG operation State machine for the Pre-3.0 DOCSIS DSG eCMs, but was separated out for DOCSIS 3.0 as there was a need to complete the DSG channel validation prior to completing the Downstream Ambiguity Resolution. The DOCSIS 3.0 DSG eCM starts the Tdsg1 timer and waits to find a DCD message fragment. If the Tdsg1 timer times out, the eCM continues downstream scanning. If the eCM finds a DCD message, it stops the Tdsg1 timer and sends a "DSG channel found" message to the downstream scan state machine.

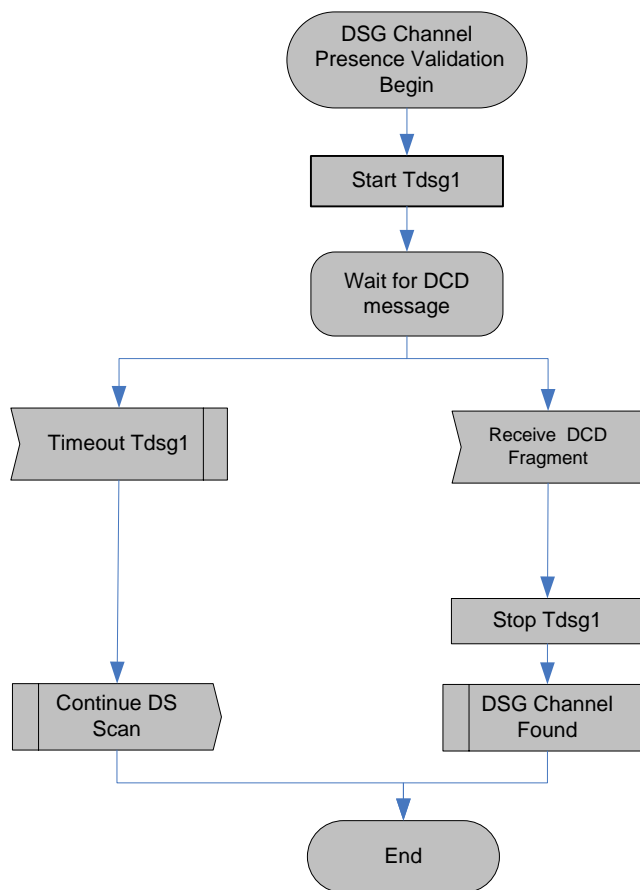

Figure 5-15 – DSG Channel Presence Validation

5.4.4.4.2 Read MAC Domain Descriptor (MDD)

This clause corresponds to the "Read MAC Domain Descriptor (MDD)" clause in [J.222.2]. It describes how the eCM looks for MDD messages on a downstream channel. The process is a little different from what is in [J.222.2]. As the eCM sees MDD message fragments on the downstream, it compares the Source MAC Address of the newly collected fragment to the MAC domain Address of the DCD message. Only if the address matches does the eCM collect the MDD fragment. A DOCSIS 3.0 DSG eCM MUST NOT use an MDD message whose source MAC address does not match that of the DCD message.

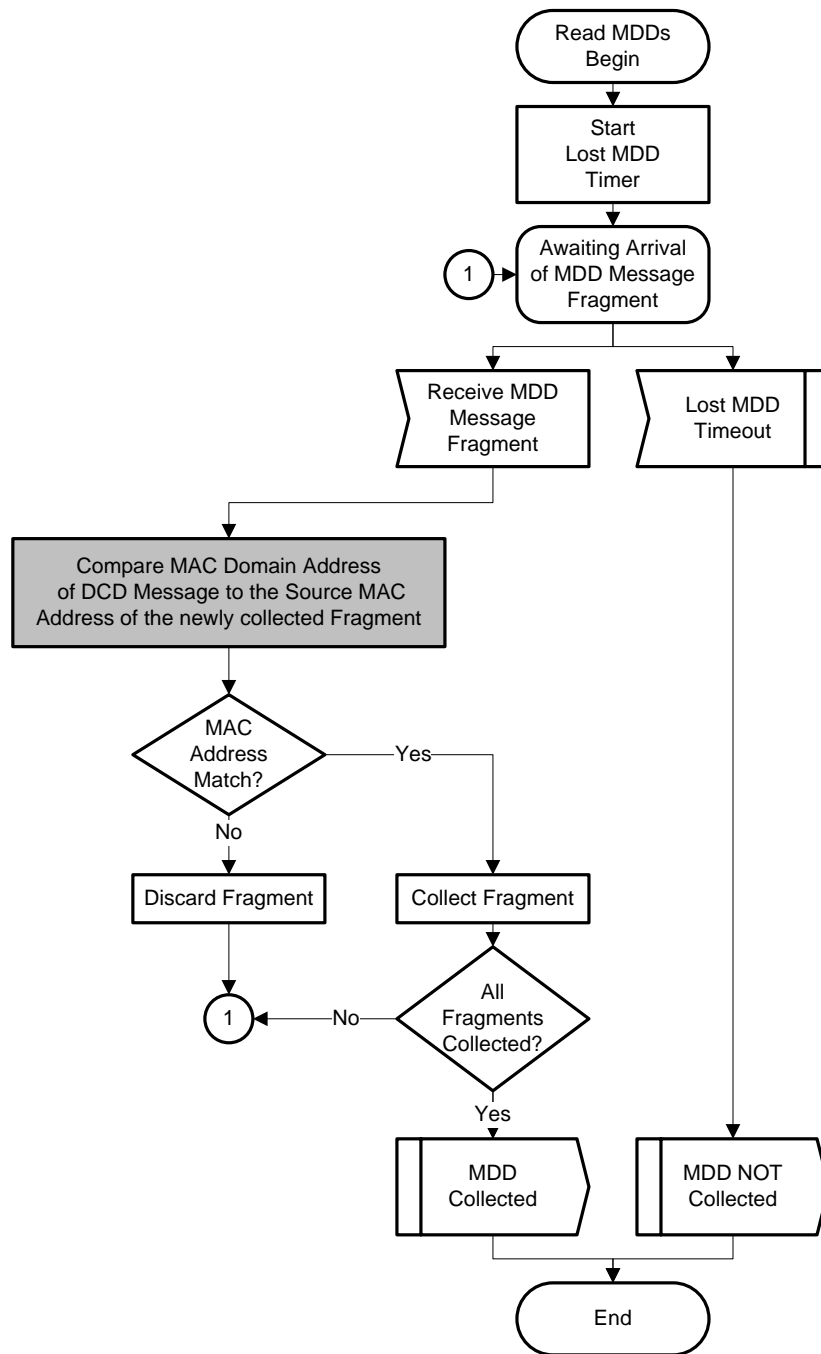

Figure 5-16 – Read MDD

5.4.4.4.3 Determination of MD-DS-SG

This clause corresponds to the "Determination of MD-DS-SG (MDD)" clause in [J.222.2]. It describes how the eCM determines its downstream Service group and this process is unchanged from the one defined in [MULPI]. This Downstream Ambiguity resolution needs to be completed prior to sending the stream of DCD messages to the DSG Client Controller.

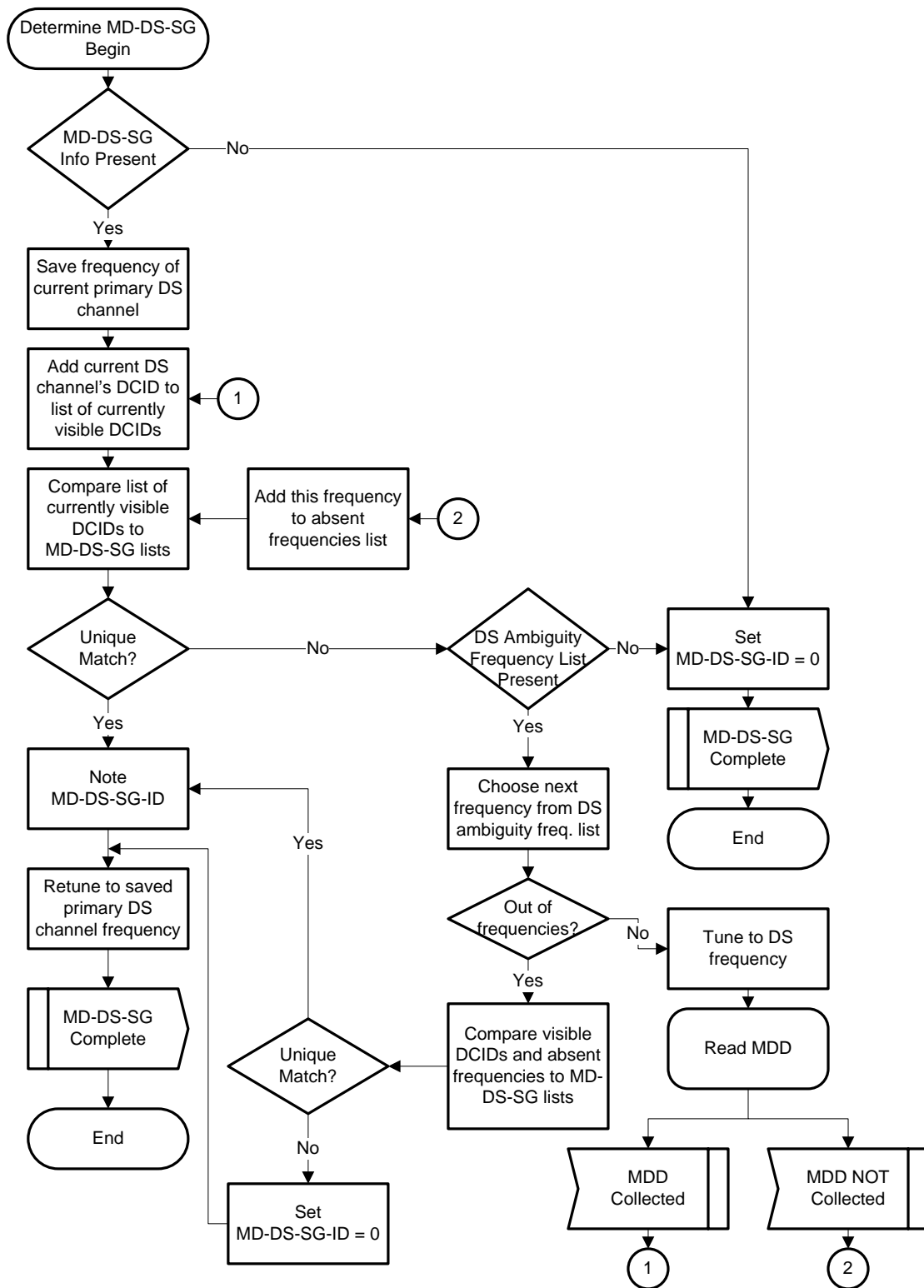

Figure 5-17 – Determine MD-DS-SG

5.4.4.4.4 Wait for DSG channel Validation

The "Wait for DSG channel Validation" is a DSG eCM wait state where the DSG eCM waits till it gets a message from the DSG Client Controller specifying if the DSG channel was a valid one or not.

5.4.4.4.5 Scan DS channels within MD-DS-SG

If the DSG Client Controller signals that the downstream channel is an invalid DSG channel then the eCM first scans to find other downstream channels in the MD-DS-SG. When scanning for channels within the MAC Domain the eCM first chooses channels in common with the channels present in the DSG Channel List (from the DCD). If there is a DSG Channel List present and it does not include any channels in the MAC Domain, the eCM is not required to try every single channel within MD-DS-SG.

For each of the downstream channels, if the eCM finds DCDs (within the same MAC Domain), it forwards the DCD on to the DSG Client Controller. The eCM discards DCDs received from different MAC domains and continues scanning for other downstream channels.

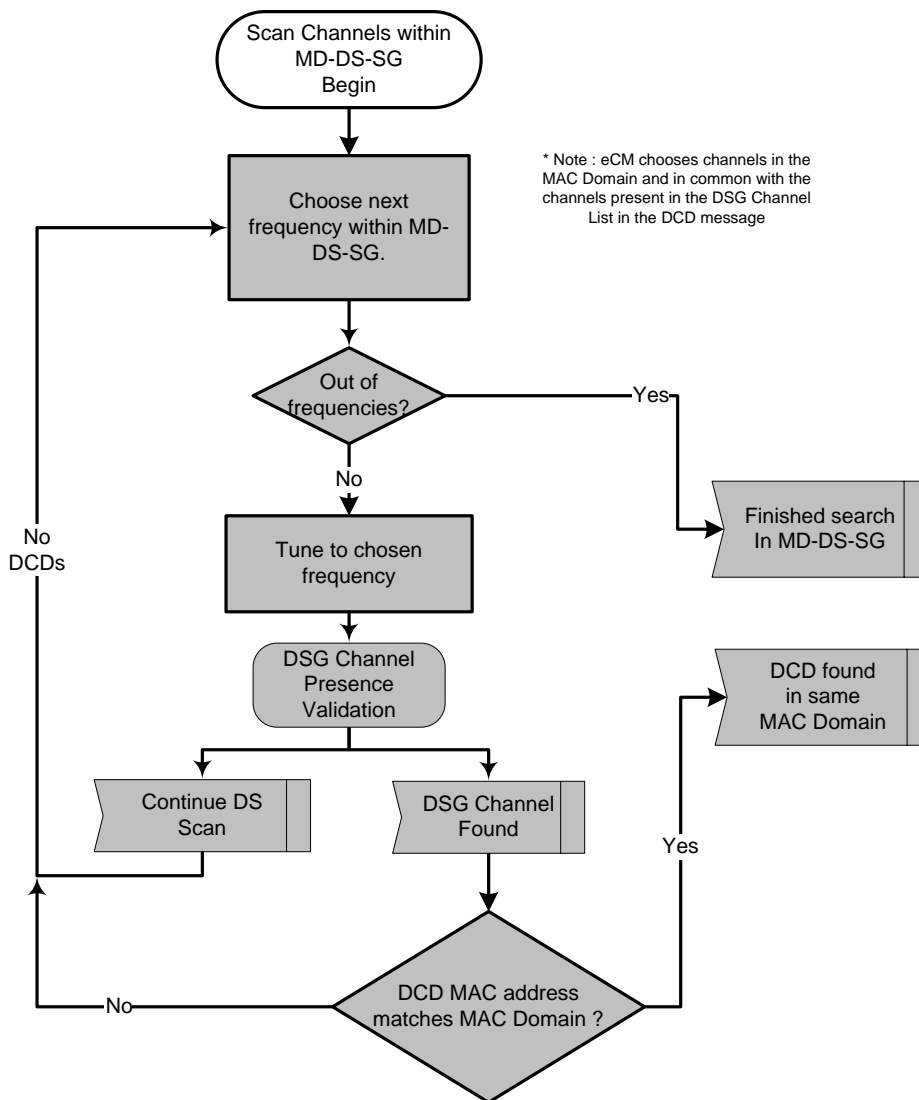

Figure 5-18 – Scan Channels within MD-DS-SG

5.4.4.4.6 Determine MD-US-SG

This clause corresponds to the "Determination of MD-US-SG" clause in [J.222.2]. It describes the steps the eCM needs to perform to complete MD-US-SG resolution. The behaviour here is the same as in [MULPI] except when the eCM is out of candidate UCIDs, the DSG eCM starts One-way mode of operation. The eCM also checks for ranging Hold-off direction per [J.222.2].

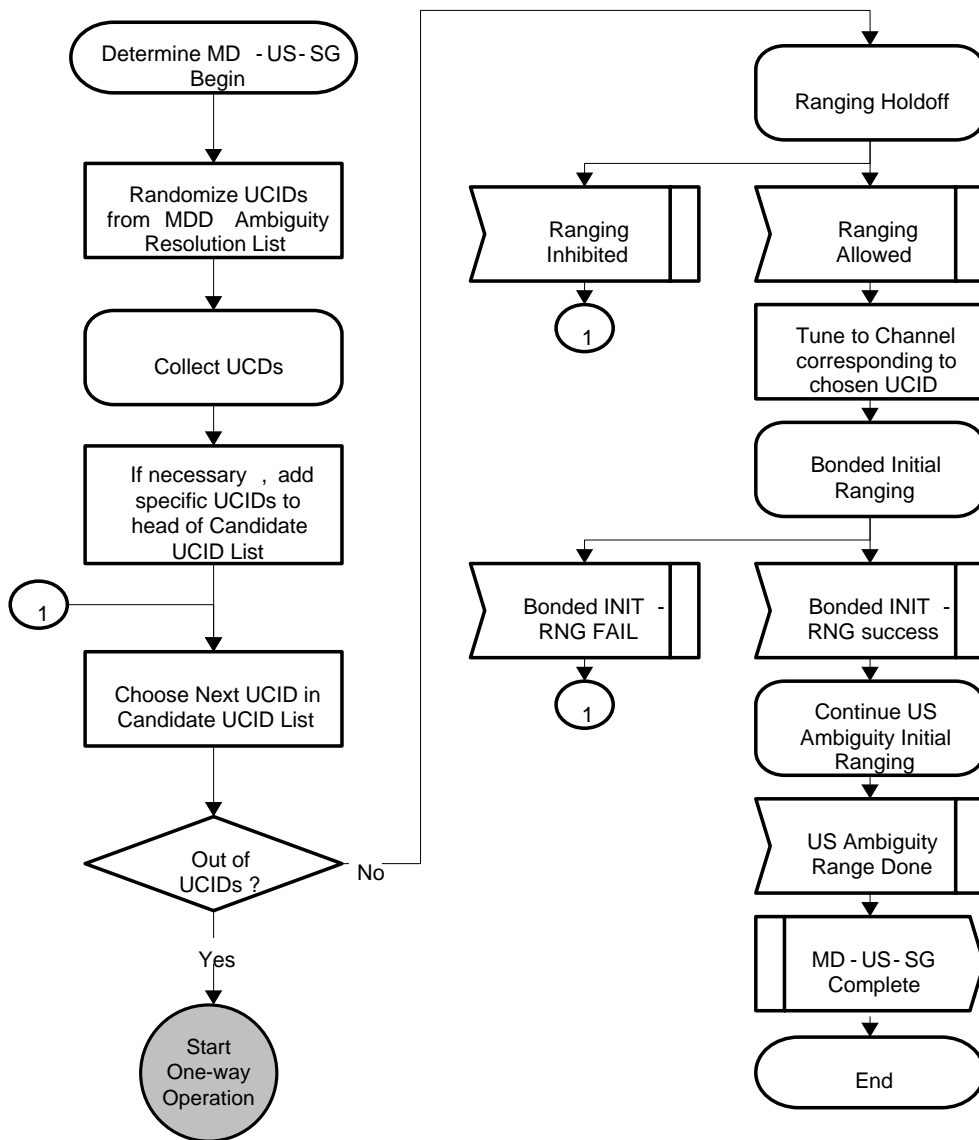

Figure 5-19 – Determine MD-US-SG

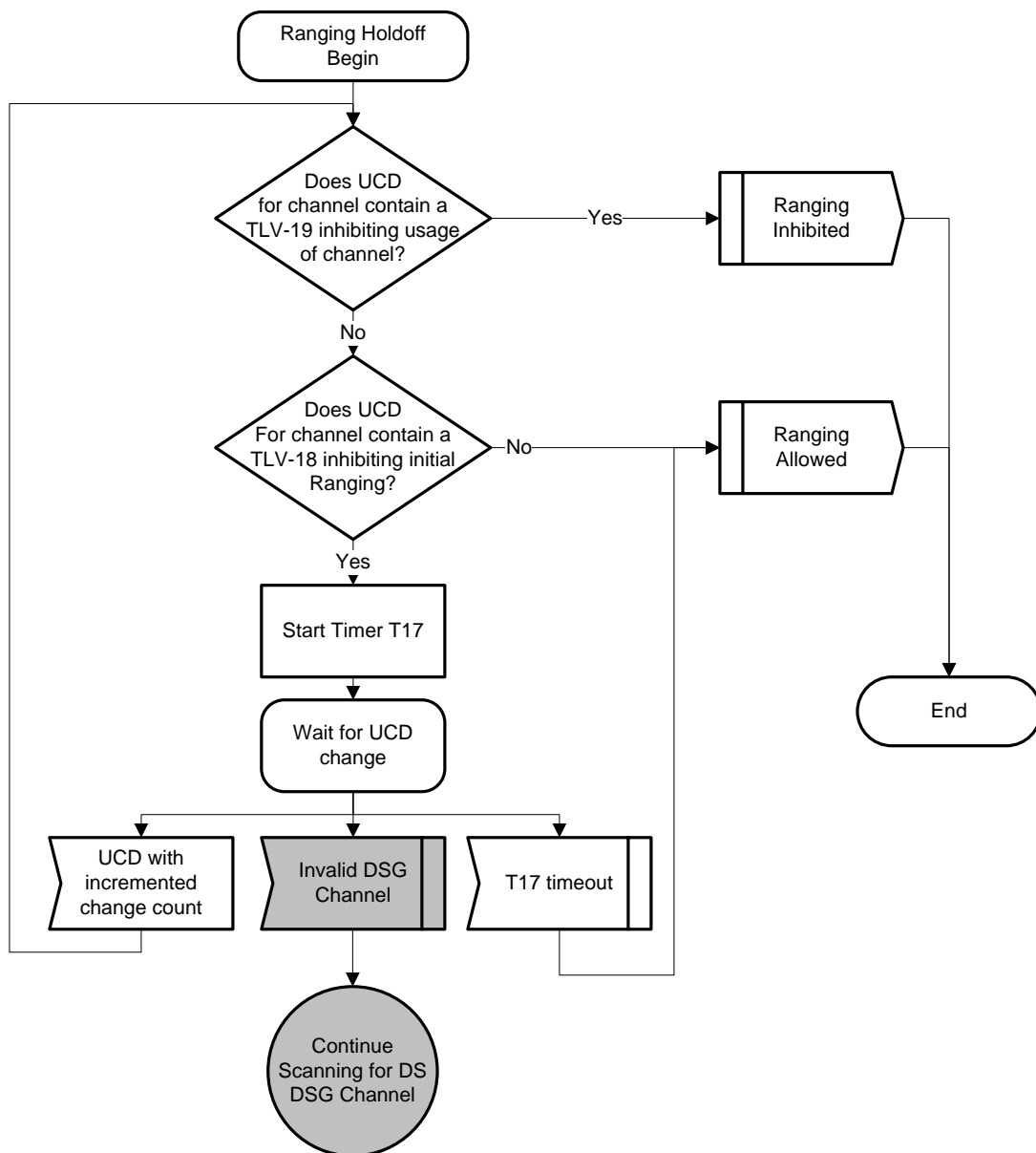

Figure 5-20 – Determine Ranging Hold-Off

5.4.4.4.6.1 Bonded Initial Ranging

This clause corresponds to the "Bonded Initial Ranging" clause in [J.222.2]. It describes how the eCM performs Bonded Initial Ranging. The behaviour here is the same as in [MULPI] except when the eCM receives a Ranging Abort, the DSG eCM starts One-way mode of operation.

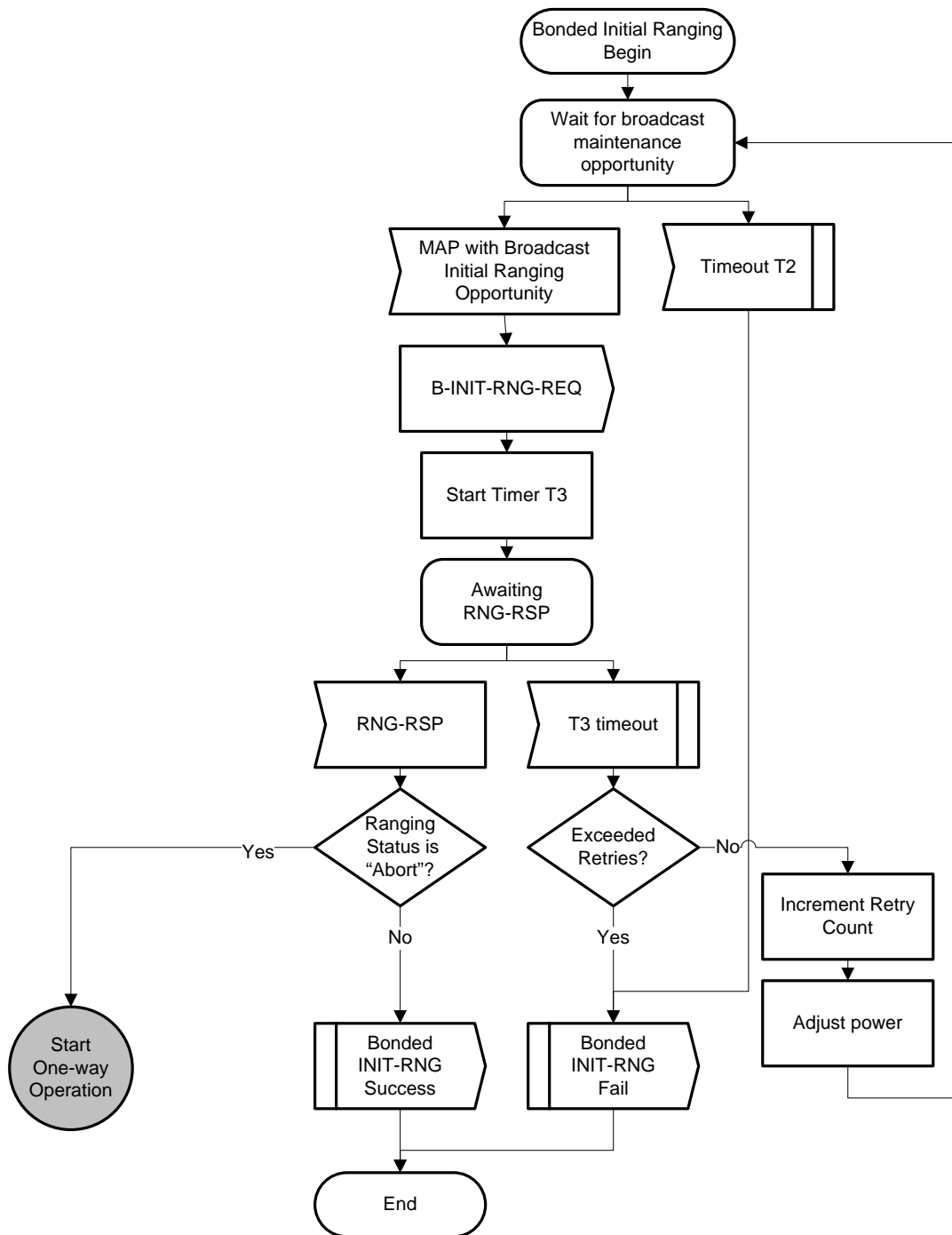
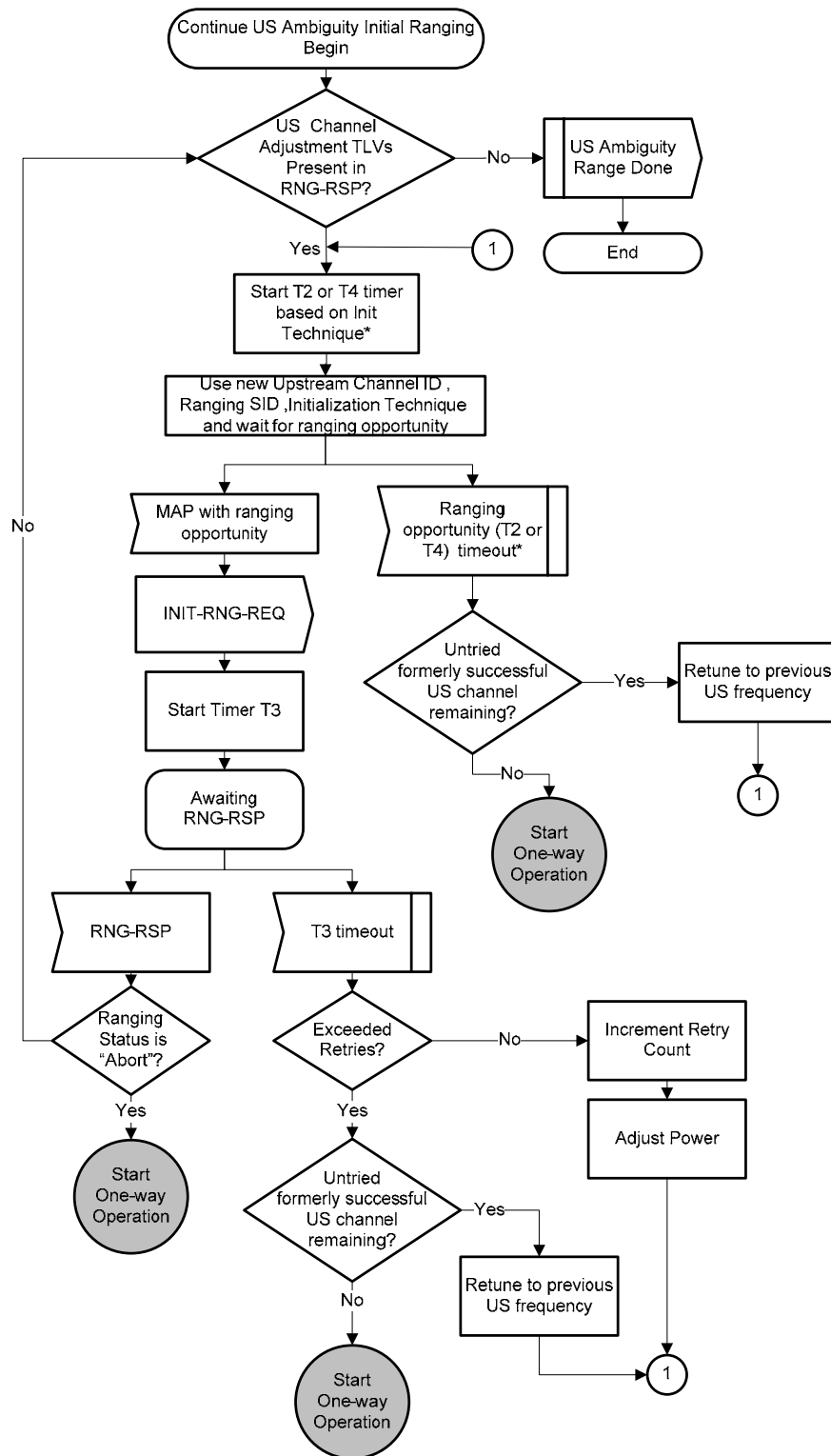

Figure 5-21 – Bonded Initial Ranging

5.4.4.4.6.2 Continue US Ambiguity Initial Ranging

This clause corresponds to the "Continue US Ambiguity Initial Ranging" clause in [J.222.2]. It describes how the eCM performs upstream Ambiguity Initial Ranging. The behaviour here is the same as in [MULPI] except when the eCM is unable to range and no more untried US channels remain and on a Ranging Abort, the DSG eCM starts One-way mode of operation.



***Note:** The ranging opportunity timeout is dependent on the Initialization Technique attribute in the current adjustment request. If Technique 1 is used then the timeout value is T2. If Initialization Techniques 2 or 3 are used the timeout value is T4.

Figure 5-22 – Continue US Ambiguity Initial Ranging

5.4.4.4.7 Obtain Upstream Parameters

This clause corresponds to the "Obtain Upstream Parameters/Try Next Upstream (DOCSIS 2.0 Initialization)" clause in [J.222.2]. It describes the steps the eCM needs to perform to complete upstream acquisition when connected to a 2.0 downstream channel. The behaviour here is the same as in [MULPI] except on a T1 timeout, the DSG eCM starts One-way mode of operation.

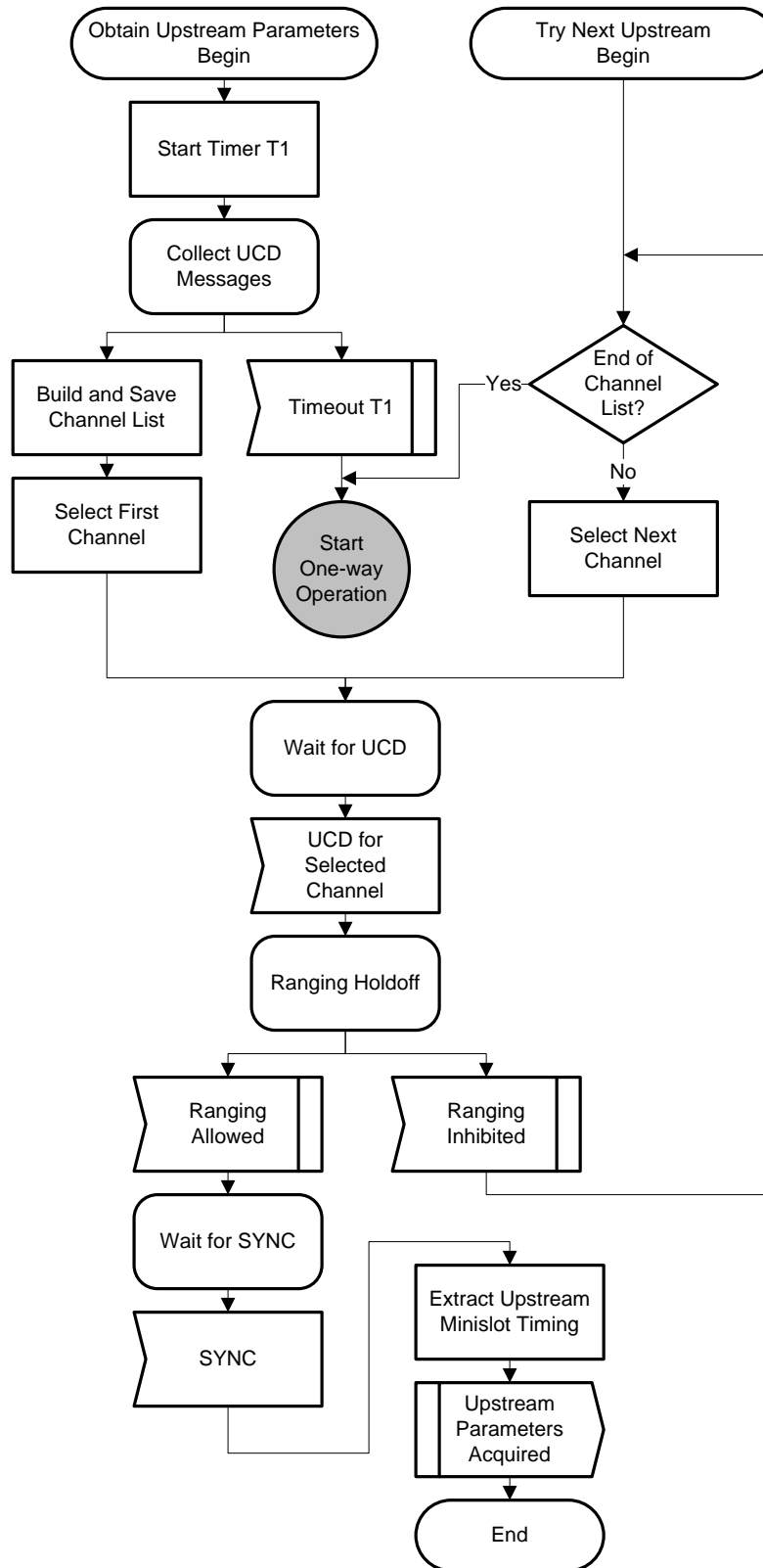

Figure 5-23 – Obtain Upstream Parameters

5.4.4.4.8 Broadcast Initial Ranging

This clause corresponds to the "Ranging and Automatic Adjustments" clause in [J.222.2]. It describes the steps the eCM needs to perform to complete ranging and adjustment of transmitting parameters. The behaviour here is the same as in [MULPI] except on a Range Abort from the CMTS, the DSG eCM starts One-way mode of operation.

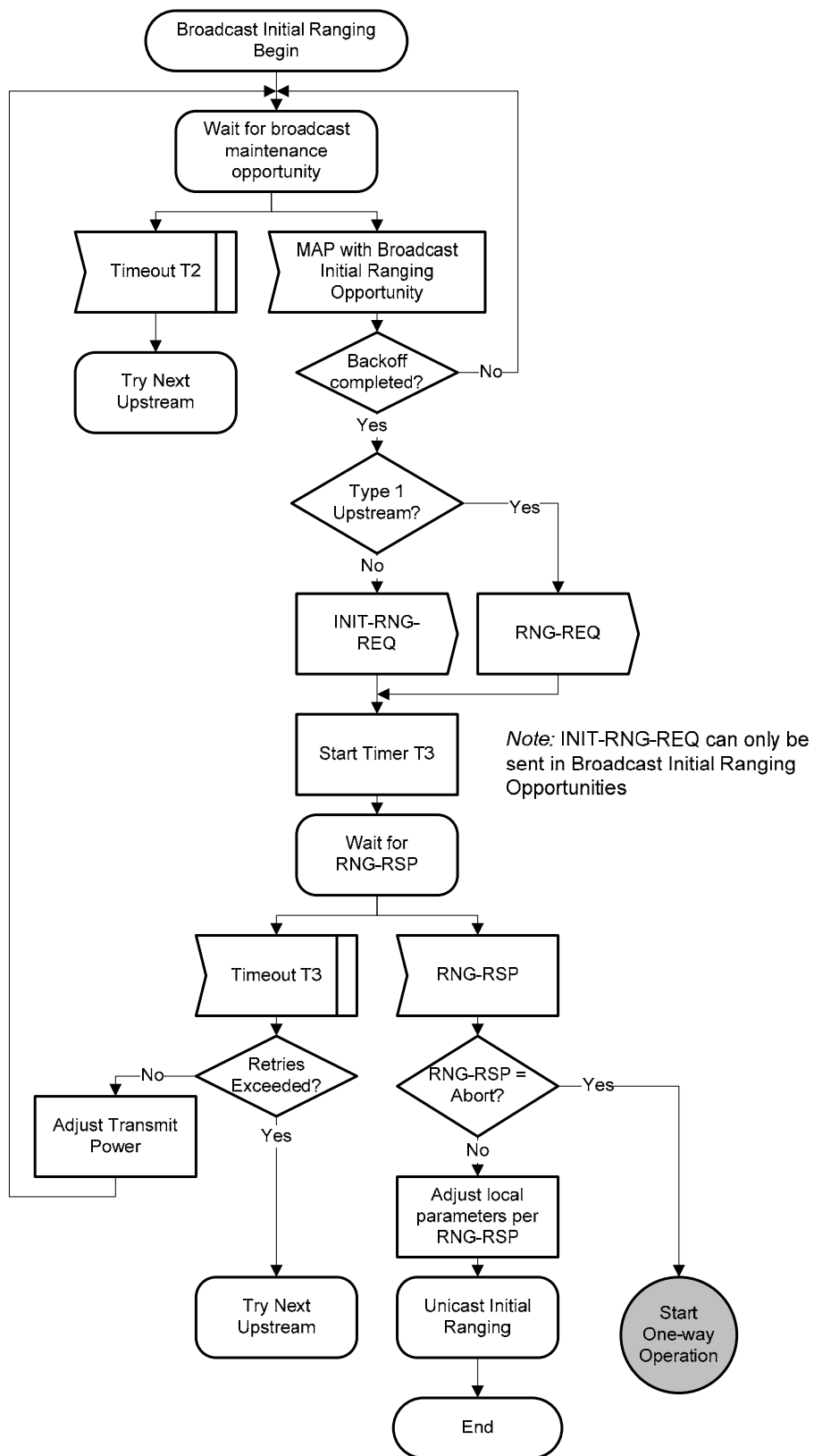

Figure 5-24 – Broadcast Initial Ranging

5.4.4.4.9 Unicast Initial Ranging

This clause corresponds to the "Ranging and Automatic Adjustments" clause in [J.222.2]. It describes the steps the eCM needs to perform during Unicast Initial Ranging. The behaviour here is the same as in [MULPI] except on T4 timeouts, Retries exceeded after T3 timeouts and a Range Abort from the CMTS, the DSG eCM starts One-way mode of operation.

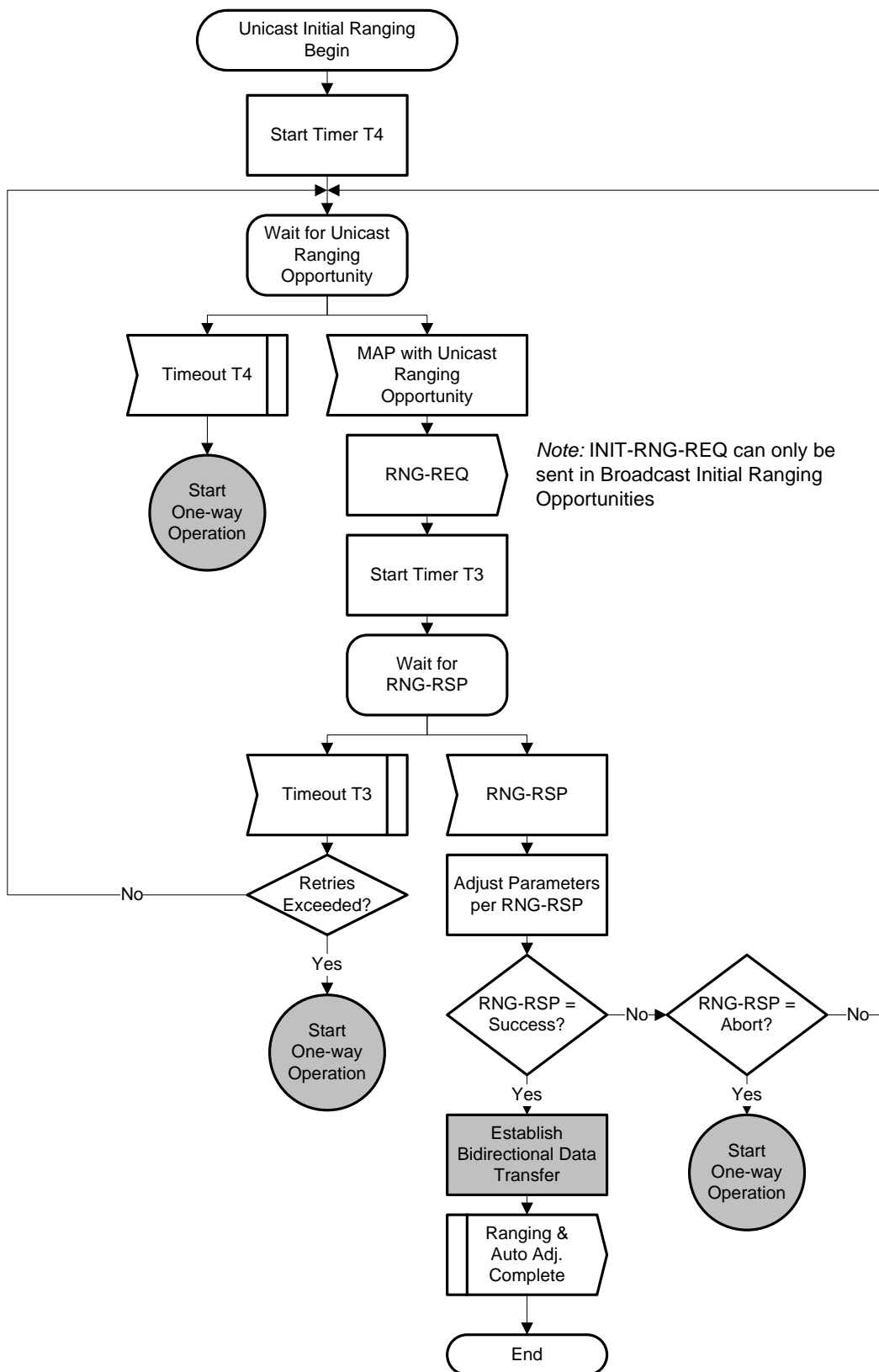

Figure 5-25 – Unicast Initial Ranging

5.4.4.5 Establishing IP Connectivity

This clause corresponds to the "Establishing IP connectivity" clause in [J.222.2]. It describes the steps the eCM performs to acquire a management IP address for itself. The eCM can obtain an IPv4 or IPv6 management address. The behaviour here is the same as in [MULPI].

If the IP connectivity step fails, the eCM goes into One-way mode of operation (Figure 5-12).

5.4.4.6 Registration with the CMTS

This clause corresponds to the "Registration with the CMTS" clause in [J.222.2]. It describes the steps the eCM needs to perform during registration with a CMTS. The behaviour here is the same as in [MULPI] except where noted below and in the diagrams in this clause. When acquiring CM transmit channels, if a failure occurs on all the upstreams or the number of retries is exhausted after a T6 timeout, then the eCM begins One-way mode of operation.

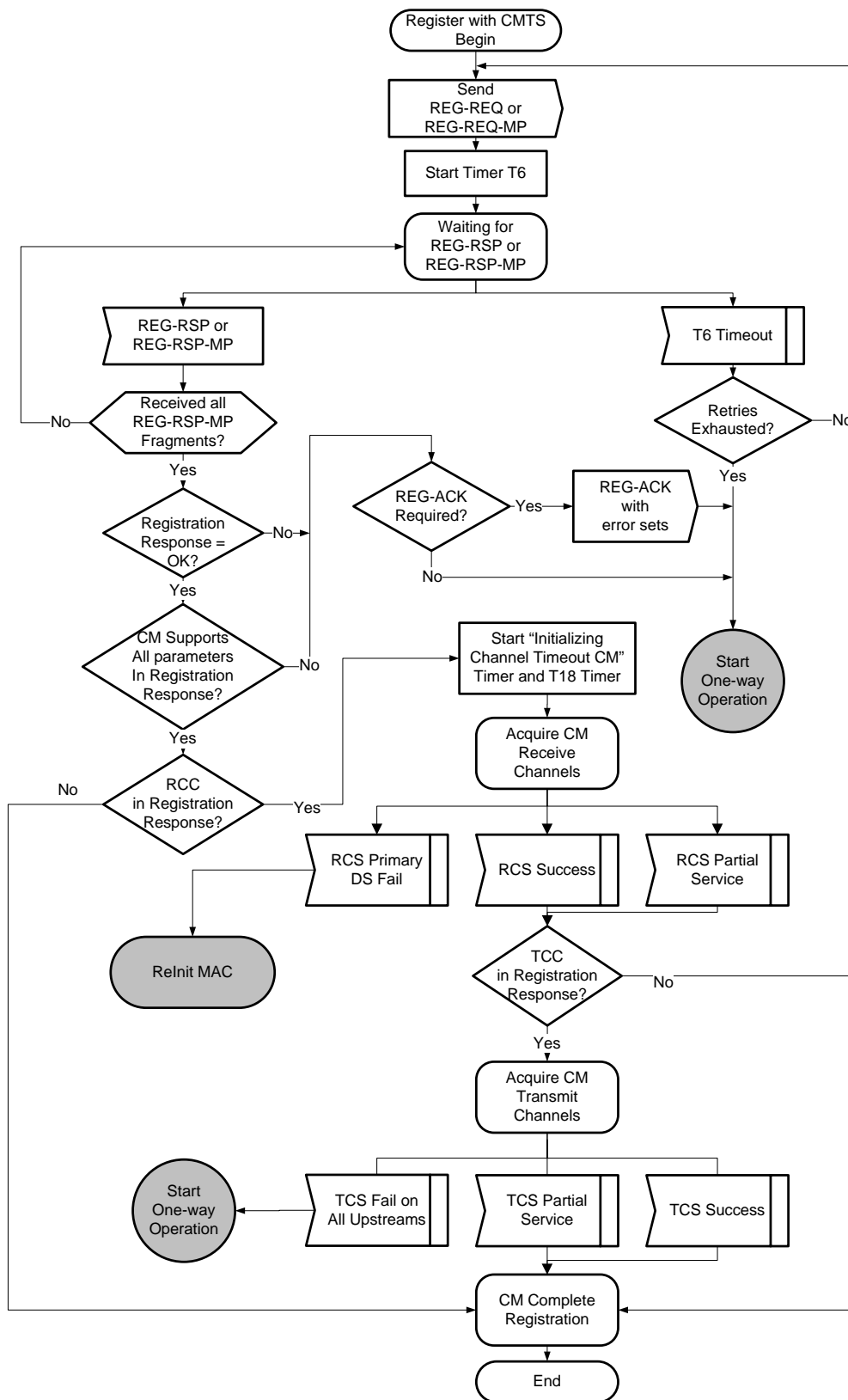

Figure 5-26 – CM Registration with CMTS

5.4.4.6.1 CM Acquire Receive and Transmit Channels

This clause corresponds to the "Registration with the CMTS" clause in [J.222.2]. It describes the steps the eCM performs during registration when the CM starts to acquire all the Receive and Transmit Channels as directed by the CMTS. The behaviour here is the same as defined in [MULPI].

5.4.4.6.2 CM Completes Registration

This clause corresponds to the "Registration with the CMTS" clause in [J.222.2]. It describes the steps the eCM performs during registration after the CM completes Receive and Transmit Channel acquisition. The behaviour here is the same as in [J.222.2] except if the REG-ACK retries are exceeded or if the primary upstream service flow cannot be established, the eCM Starts One-way mode of operation. Also, after registration is complete, the eCM sends a Notification message to the DSG Client Controlled that "Two-way operation" is OK and also informs the DSG Client Controller of the upstream channel ID. If the CM has registered in Multiple Transmit Mode, it MUST choose the lowest numbered UCID from its Transmit Channel Set (TCS) to signal to the DSG Client Controller. Operators may allocate low UCID values to the relevant upstreams to maintain the same technique for DSG regionalization for 3.0 DSG eCMs.

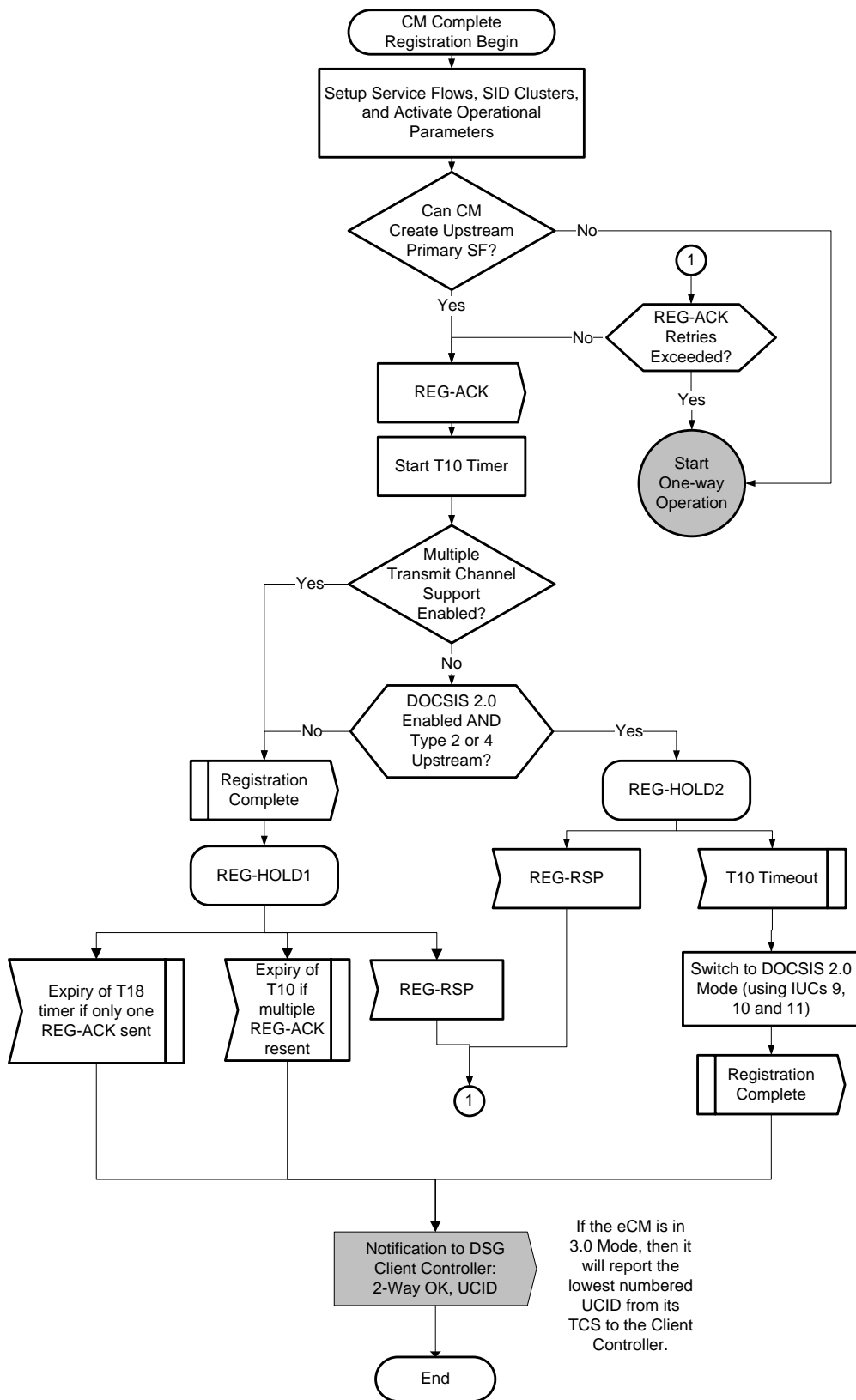

Figure 5-27 – CM Completes Registration

5.4.4.7 DOCSIS 3.0 DSG eCM Operation

This clause corresponds to the "Periodic Maintenance" clause in [J.222.2]. Like the DOCSIS Pre-3.0 DSG eCM, the 3.0 DSG eCM uses the same concepts of One-way Operation, Two-way Operation Disabled, and the reception of an Invalid DSG Channel notification. The messages sent between the DSG Client Controller and the DSG eCM are detailed in clause 5.4.4.1.1.

When the DSG eCM enters One-way mode of operation as a consequence of any of the timeouts or error conditions indicated in the preceding clauses, it **MUST** remain tuned to and process DSG traffic on the primary downstream channel. If the eCM enters One-way mode of operation as a result of loss of downstream sync, the eCM **MAY** disable the Tdsg3 timer and refrain from attempting two-way operation until downstream sync is re-established. If the CM loses downstream sync temporarily, the eCM can still receive DSG tunnel data, but will be unable to transmit on the upstream. As long as the CM receives the DCD messages and DSG tunnel data, eCM stays on the downstream, unless there is loss of DCD messages or DSG tunnel data on that downstream channel.

When the DSG eCM enters two-way disabled operation as a consequence of being told by the DSG Client Controller to disable its upstream transmitter, it **MUST** remain tuned to and process DSG traffic on the DOCSIS downstream channel. At any point in its initialization or operational sequences, when the DSG eCM receives notification from the DSG Client Controller to disable its upstream transmitter, the DOCSIS 3.0 DSG eCM **MUST** immediately cease using all of its upstream transmitters. The DSG eCM **MUST** then enter DSG Two-way Disabled operation as described in Figure 5-28.

When the eCM is in One-way mode of operation, and the Tdsg3 timer times out, the eCM will "Continue Upstream Acquisition" (Figure 5-14) and try to range and reacquire the upstream channels. The DSG eCM keeps context, if it is in 3.0 mode or 2.0 mode, and appropriately chooses the mode of upstream acquisition.

When the eCM is in One-way mode of operation, or in Two-way operation disabled and the eCM receives an "Invalid DSG channel message" from the DSG Client Controller, then the eCM resumes the scan for new Downstream channels.

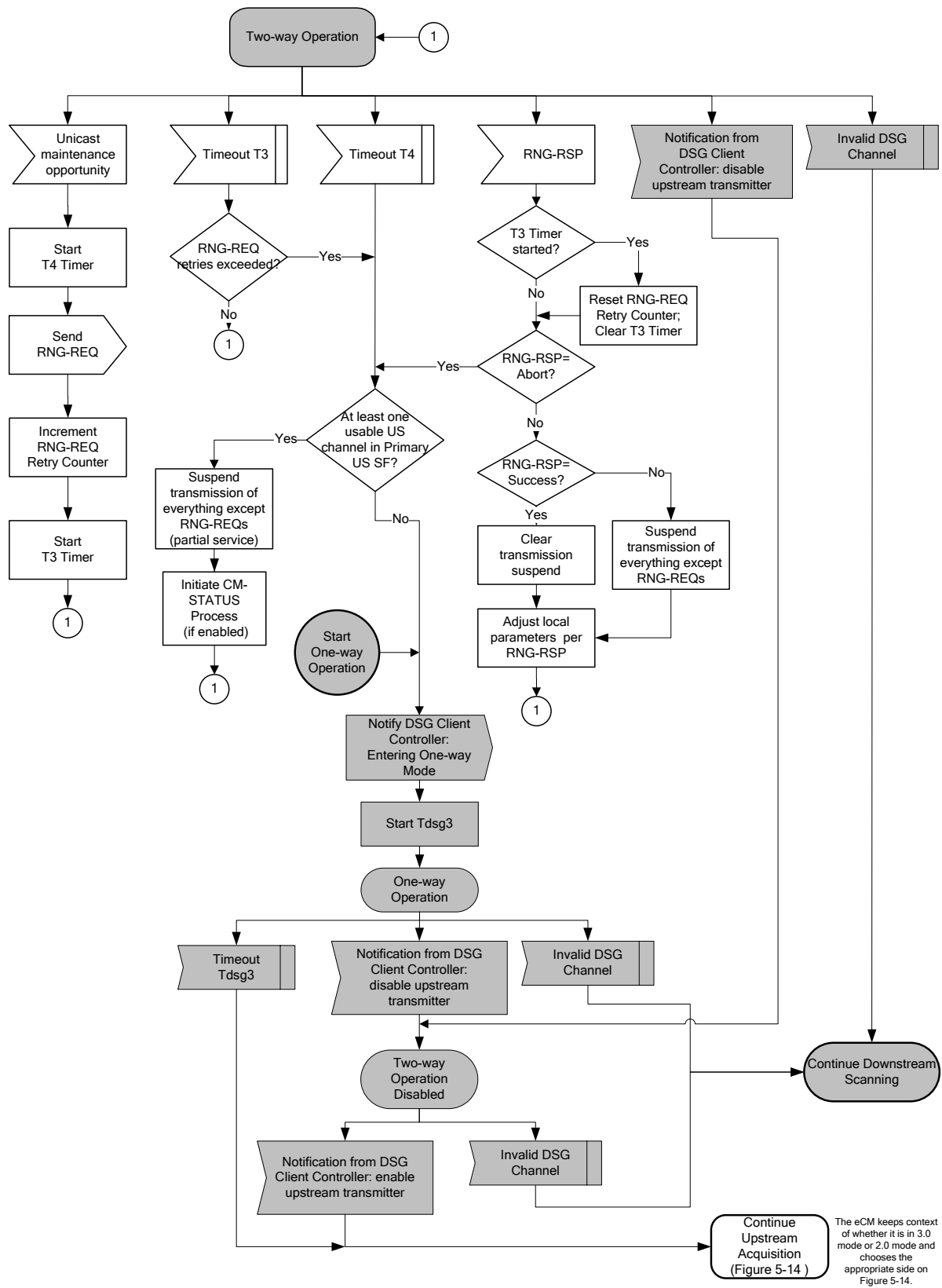

The eCM keeps context of whether it is in 3.0 mode or 2.0 mode and chooses the appropriate side on Figure 5-14.

Figure 5-28 – eCM Operation

If the eCM is unable to renew its IP address, then the eCM MUST move to One-way mode of operation.

NOTE – When the eCM is configured to provision in APM or DPM, it should not enter One-way mode of operation unless it obtains either an IPv4 or an IPv6 address ([J.222.2]).

5.4.4.7.1 Multiple Transmit Channel (MTC) mode and Partial Service considerations

In DOCSIS 3.0, Multiple Transmit Channel Mode (MTC Mode) provides mechanisms and capabilities that enable Upstream Channel Bonding. If a CM is operating in MTC Mode, all of its service flows, whether assigned to a single channel or to an upstream bonding group, operate with the mechanisms that are supported in MTC Mode.

Whenever one or more channels in the Transmit Channel Set (TCS) and/or the Receive Channel Set (RCS) are unusable, that CM is said to be operating in a "partial service" mode of operation in the upstream and/or downstream respectively. A channel is deemed to be unusable when the CM is unable to acquire one or more channels during registration and/or DBC, or if a CM has lost an upstream and/or downstream channel during normal operation.

If the eCM loses the upstream channel previously signalled to the DSG Client Controller, the eCM MUST communicate the next lowest numbered UCID of the upstream channels on which the CM is currently ranged to the DSG Client Controller. This is done via a "2-Way OK, UCID <P1>" (where P1 = Upstream Channel ID) notification message to the DSG Client Controller. It notifies the DSG Client Controller that "Two-way operation" is OK and also informs the DSG Client Controller of the upstream channel ID.

If the eCM loses all of the upstream channels on which the primary upstream service flow is assigned, the eCM enters One-way mode of operation.

5.4.4.8 DOCSIS 3.0 DSG Operation

The DSG tunnel provides OOB information to the DSG Client(s) within the Set-top Device. Multiple DSG tunnels are permitted, each identified by a MAC address. To acquire data from one or more tunnels, the DSG Client Controller must be able to understand the addresses in use to define the tunnels, and must be able to request the appropriate filtering for the DSG Client.

The DOCSIS 3.0 DSG eCM MUST discard DCD messages and DSG tunnel packets not received on its Primary Downstream channel. The DOCSIS 3.0 DSG eCM MUST discard DCD messages and message fragments whose source MAC address does not match that of the MDD that the eCM is using on its Primary Downstream.

When DSG is operational, the DOCSIS DSG eCM MUST operate as described in Figure 5-29.

This DSG operational diagram is similar to the one defined for Pre-3.0 DOCSIS DSG eCMs, but with differences as defined below.

The diagram introduces a "DSG HOLD" state because the eCM completes Downstream Ambiguity resolution prior to sending a DCD message to the DSG Client Controller. When the eCM receives a notification from the DSG Client Controller to start Advanced mode, it moves into this DSG Hold state. It waits there until it receives the "Downstream Ready" message from the "DSG 3.0 eCM DS scan & MD-DS-SG Resolution" portion of the eCM Initialization sequence. The "Downstream Ready" message communicates that the eCM has successfully acquired a DOCSIS 2.0 downstream channel or acquired a DOCSIS 3.0 downstream channel and completed the downstream ambiguity resolution process for that downstream. Once it receives the "Downstream Ready" message, the eCM moves to the DSG Operation state.

When in the DSG Operation state, either on notification from the DSG Client Controller that the DSG channel is invalid or if the Tdsg4 timer times out, then the eCM sends out the Invalid DSG Channel message to the "DSG eCM operation" state machine and goes to the DSG HOLD state. It waits there until the eCM finds another valid Downstream Channel. This way the eCM will not forward the new DCD messages from a particular downstream unless the DS ambiguity resolution process has been completed from that new downstream channel since the DS ambiguity resolution process could potentially break the flow of DCD messages to the DSG Client Controller.

Another change from the Pre-3.0 DOCSIS DSG Operation diagram is that the eCM does not signal the "DCD present" message to the DSG 3.0 eCM DS scan and MD-DS-SG Resolution part of the Initialization sequence. This has been replaced by the DOCSIS 3.0 DSG Channel Presence Validation (clause 5.4.4.1).

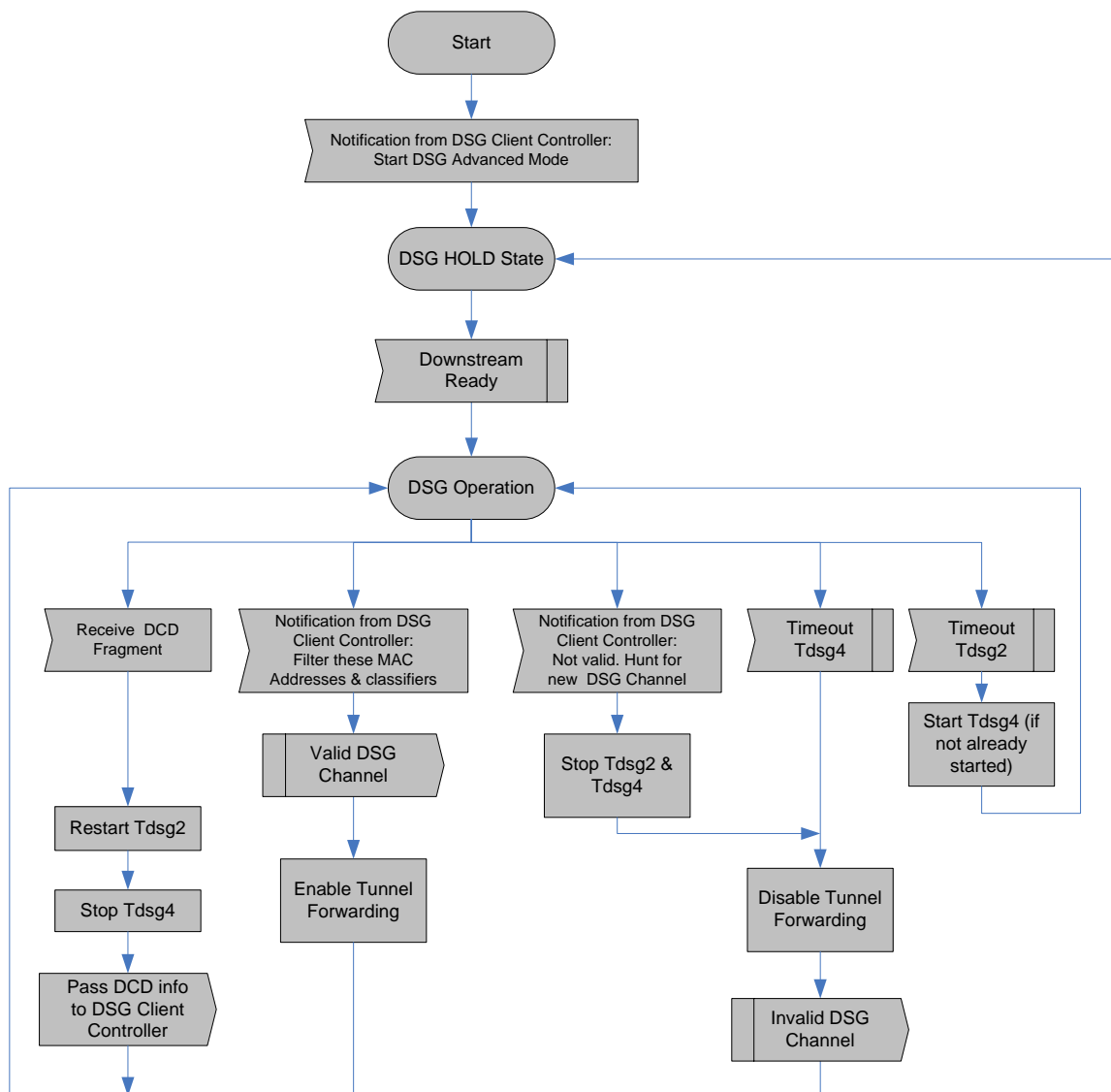

Figure 5-29 – DOCSIS 3.0 DSG Operation

5.4.5 Tunnel Acquisition and Handling

5.4.5.1 DSG advanced mode tunnel acquisition and handling

When operating in DSG Advanced Mode, the DSG eCM MUST comply with the following DSG tunnel acquisition requirements:

- The DSG eCM MUST pass the contents of the DCD to the DSG Client Controller and allow the DSG Client Controller to determine the appropriateness of the current downstream channel.
- The DSG eCM MUST NOT forward DSG Tunnel data to the DSG Client(s) until the appropriate filters have been set, based upon information received from the DSG Client Controller. When in MDF enabled Mode, the DOCSIS 3.0 DSG eCM uses the DSID from

the DA-to-DSID TLV in the MDD message to forward the appropriate DSG tunnels and the DSG Tunnel Address is not enforced as a filtering criteria.

- Once these filters have been set, the DSG eCM MUST begin forwarding DSG Tunnel data to the DSG Client(s) whether it is operating in One-Way mode or Two-Way mode.
- The DSG eCM MUST only forward DSG Tunnel data to the DSG Client that matches these filters.
- The DSG eCM MUST dynamically replace these filters if instructed to do so by the DSG Client Controller.
- After becoming operational in Two-Way mode, the DSG eCM MUST notify the DSG Client Controller of the UCID the DSG eCM is using.
- If the DSG eCM transitions from a Two-Way to a One-Way mode of operation, it MUST continue to forward the same DSG Tunnels to the DSG Client(s) unless instructed to do otherwise by the DSG Client Controller. For example, UCID-based filters are not removed by the transition from Two-Way to One-Way operation.

5.4.5.2 DA-to-DSID Association of DSG Tunnels in DOCSIS 3.0

DOCSIS 3.0 defines the DSG DA-to-DSID Association Entry TLV in the MDD message to convey the association between a DSID and a Group MAC Address used for DSG tunnel traffic [MULPI].

The DSG Agent MUST include one instance of the DSG DA-to-DSID Association Entry TLV for each DSG Tunnel address in the MDD message unless it has been configured to disable Multicast DSID Forwarding on a Global or MAC Domain basis. The DSG Agent MUST NOT use a given DSID value in more than one instance of the DSG DA-to-DSID Association Entry TLV. The DSG Agent MUST NOT modify DSID values in the DSG DA-to-DSID Association Entry TLV in the MDD message. The only time that the DSG Agent modifies the DSG DA-to-DSID Association Entry TLV in the MDD message is when it modifies the DCD message due to the addition or deletion of DSG rules. The DSG Agent MUST add new DA-to-DSID mappings to the DSG DA-to-DSID Association Entry TLV in the MDD message when it adds new DSG tunnels to the DCD message. The DSG Agent MUST delete existing DA-to-DSID mappings from the DSG DA-to-DSID Association Entry TLV in the MDD message when it deletes DSG tunnels from the DCD message. When it includes the DSG DA-to-DSID Association Entry TLV in the MDD message, the DSG Agent MUST label DSG tunnel traffic with the associated DSID which is communicated in the DSG DA-to-DSID Association Entry.

If it has been configured to disable Multicast DSID Forwarding on a Global or MAC Domain basis, the DSG Agent MUST NOT include the DSG DA-to-DSID Association Entry TLV in the MDD message. The DSG Agent MUST NOT disable Multicast DSID forwarding on individual DSG eCMs when it includes the DSG DA-to-DSID Association Entry TLV in the MDD message.

The presence of the DSG DA-to-DSID Association Entry TLV in the MDD message indicates that Multicast DSID Forwarding is to be enabled on the DSG eCM. If the MDD message contains the DSG DA-to-DSID Association Entry TLV, the DSG eCM MUST perform DSID based filtering and forwarding of DSG tunnel traffic. A DOCSIS 3.0 DSG eCM uses the information in the DSG DA-to-DSID Association Entry TLV to ascertain the DSIDs to use for each multicast group MAC address for which it needs to forward DSG Tunnel data.

The absence of either the MDD message or the DSG DA-to-DSID Association Entry TLV in the MDD message indicates that Multicast DSID Forwarding is to be disabled on the DSG eCM. If no MDD is present on the downstream channel or the MDD message does not contain the DSG DA-to-DSID Association Entry TLV, the DOCSIS 3.0 DSG eCM MUST filter and forward DSG tunnel traffic based on the DSG Tunnel address.

When filtering and forwarding DSG tunnel traffic based on a DSID, it may be necessary for the DOCSIS 3.0 DSG eCM to update its DSIDs. When it receives an indication of a change to its DSG tunnels, the DOCSIS 3.0 eCM MUST update its application of the DSG DA-to-DSID Association Entry TLV in the MDD message to DSG tunnel filters.

5.5 Security considerations

Since DSG must be capable of working on a one-way plant, the BPI or BPI+ protocols, as currently defined, are not available for use.

Security considerations for a DSG system that include DSG Servers, DSG Agents, and DSG Clients can be grouped into two categories: receiver-based and sender-based.

5.5.1 Receiver-based

Receiver-based broadly refers to ensuring the content is received by the desired end points and no others.

The MAC address for the DSG Tunnel provides a basic but unsecured way of choosing which end points will receive the content from the DSG Tunnel. Should the DSG Client IDs be placed in the public domain, then it may be possible for a subscriber to adopt that MAC address and begin receiving DSG Tunnel content.

In DSG Advanced Mode, this mode of operation is enhanced by allowing the DSG Agent to substitute new values for the DSG Tunnel Address.

Since none of these techniques are fully secure, the Set-top Device Manufacturer is expected to provide application layer encryption which would run between the DSG Server and the DSG Client, and would protect any sensitive DSG Tunnel content.

5.5.2 Sender-based

Sender-based broadly refers to ensuring the content that is received by the Set-top Device originated from the correct sender. This can be accomplished by specifying operating procedures at the Set-top Device and the CMTS.

In DSG Advanced Mode, a packet filter may be installed in the DSG Client which further qualifies the packets in the DSG Tunnel by adding access control based upon the source IP address, destination IP address, and destination UDP port. If the CMTS and the IP network can prevent packets from illegally entering the Head End IP Network with these fields set to the values of the DSG Tunnel, then an enhanced layer of security can be achieved.

Since none of these techniques are fully secure, the Set-top Device Manufacturer is expected to provide an application layer protocol that will allow the Set-Top Device to authenticate the sender of the content of the DSG Tunnel.

The CMTS which hosts the DSG Agent MUST ensure that other network protocols (such as ARP, DHCP, DOCSIS Registration, BPKM signalling, etc.) do not associate the destination MAC address of the DSG Tunnel with a non-DSG IP Address, or do not disassociate the destination MAC address of the DSG Tunnel from its designated DSG IP Address.

NOTE 1 – This provision is to prevent a security threat in which an external entity sends in a packet or signalling message on any inbound CMTS interface which infers ownership by that external entity of a MAC address in use by a DSG Tunnel. In such a scenario, unless specifically prevented, other protocols in the CMTS could create false associations of DSG Tunnel MAC Addresses to other IP addresses. It is worth noting that most of these security concerns can be negated by using a multicast (group) MAC address for the DSG Tunnel (see DSG Advanced Mode), since the above protocols generally operate in conjunction with IP flows with unicast (individual) MAC addresses.

The CMTS which hosts the DSG Agent MUST NOT allow any packets sourced from the DOCSIS upstream to be retransmitted to a DSG Tunnel or to prevent the operation of the DSG Tunnel.

NOTE 2 – This provision is to prevent a security threat in which an external entity connected to a DOCSIS CM sends a packet which imitates a packet from the DSG Server with the intent of having that packet retransmitted to the DSG Tunnel. This provision also identifies and disallows a Denial of Service scenario where packets sent from a single entity on a DOCSIS Upstream are not allowed to shut down the operation of a DSG Tunnel.

5.6 Interoperability

5.6.1 DSG and IP multicast

On the DSG Agent Network Side Interface (NSI) the DSG Agent **MUST** advertise, via a multicast routing protocol, the multicast routes/groups that are configured in the DSG Agent.

On the DSG Agent RF Side Interface (RFI), IP Multicast Addresses that are associated with DSG Tunnels via the DCD message **MUST NOT** be managed by IGMP. As such, the downstream channel carrying the DCD message **MUST** be considered to be "statically joined" to each multicast group included in the DCD message. For these associated multicast groups, the DSG Agent **MUST** ignore any IGMP messages (membership queries, membership reports, leave messages) on the RF interface. Also, the DSG Agent **MUST** not generate IGMP messages (group-specific queries, membership reports, leave messages) on the RF interface.

In accordance with [RFC 3171] and [IANA] the DSG Agent is not required to support IP Multicast Addresses in the ranges indicated as RESERVED in [RFC 3171]. These addresses should not be used for DSG Tunnels.

In the case of IP Multicast, where the destination IP address is multicast and the DSG Tunnel Address has been derived from [RFC 1112], then the DSG Rule **MUST** include a DSG Classifier with an entry for the destination IP address. This is required because the addressing algorithm in [RFC 1112] allows up to 32 IP addresses to map to the same MAC address.

By including a source IP address and source IP mask in the DSG Classifier, Source-Filtered Multicast and Source-Specific Multicast [RFC 3569] like operations can be used. The DSG Agent is not required to support source IP mask values other than 255.255.255.255 in DSG Classifiers that include a destination IP address in the range indicated for source-specific multicast [RFC 3171].

NOTE 1 – When using a [RFC 1112]-derived MAC address, the format of a DSG Tunnel will be identical to that of a standard IP Multicast packet over DOCSIS. The difference between a DSG Tunnel and an IP Multicast over DOCSIS session is the signalling protocol for setting up the session. The DSG Tunnel uses the DCD Message, while the standard multicast session over DOCSIS would be using IGMP.

NOTE 2 – By default, DOCSIS 1.0 cable modems forward multicast traffic onto the home network. This can be avoided by using a unicast (individual) DSG Tunnel Address or by programming the downstream address filters in the CM (through SNMP) to reject the DSG Multicast traffic. Refer to [RFC 4639] for details on the CM filters. Refer to clause 5.2.2.5, MAC Addressing for DSG Tunnels, for further considerations about the use of unicast DSG tunnel addresses.

5.6.2 DSG basic mode and DSG advanced mode

This clause discusses issues with interoperability between DSG Basic Mode and DSG Advanced Mode, and the expected behaviour of the DSG Agent and DSG Client.

In the deprecated DSG Basic Mode, the DSG Tunnel Address (the destination MAC address of the DSG Tunnel) is set equal to the DSG Client ID (which is a MAC address for DSG Basic Mode), while in DSG Advanced Mode, the DSG Agent assigns the DSG Tunnel Address with the DSG Address Table which is located in the DCD message.

The DSG Agent will always generate DCD messages for its DSG Tunnels, but would be able to support DSG Clients that are operating either in DSG Basic Mode or DSG Advanced Mode by proper choice of the DSG Tunnel Addresses.

In general, the operator might configure the DSG Agent to use different DSG Tunnels for STDs operating in DSG Basic Mode and STDs operating in DSG Advanced mode since the DSG Tunnels may carry slightly different content. If the same content can be sent to both, then a single DSG Tunnel can be configured with the DSG Client ID appropriate for the STDs operating in DSG Advanced Mode, and the DSG Tunnel Address set to the Well-Known MAC Address that the STDs operating in DSG Basic Mode are expecting. In this case, the operator should not arbitrarily change the DSG Tunnel Address as this would disconnect the STDs operating in DSG Basic Mode.

A Set-top Device which supports both Modes can use the presence of the DCD message to determine which mode the DSG Agent supports. If the DCD message is present, the Set-top Device would assume DSG Advanced Mode of operation. If the DCD message is absent, the Set-top would assume DSG Basic Mode of operation. For an example of an algorithm for switching between the two modes at the Set-top Device, refer to [b-OC-HOST-CFR].

5.7 DSG operation

This clause discusses a variety of ways that DSG may be used in deployment. This clause is not inclusive of all scenarios.

5.7.1 DSG advanced mode tunnels

The DCD message is supported by DSG Client Controllers that support DSG Advanced Mode. The DSG Client Controller will forward the DSG Tunnel to the DSG Client, based upon the criteria in the DSG Address Table. The DSG Address Table consists of series of DSG Rules and DSG Classifiers.

The DSG Client Controller searches the DSG Address Table for DSG Rules that match. When a match is found, the DSG Client Controller uses the DSG Rule to obtain the destination MAC address of the DSG Tunnel to receive (known as the DSG Tunnel Address), and it uses the DSG Classifiers to determine what Layer 3 and/or Layer 4 parameters to filter on. This information is then passed to the DSG eCM.

This is demonstrated in Figure 5-30, Example #1.

5.7.2 DSG tunnel address substitution

The destination IP address of the DSG Tunnel is always a multicast address. The DSG Tunnel Address (destination MAC Address) is always a multicast (group) MAC address. As a result, the destination MAC address of the DSG Tunnel may be unrelated to the destination IP address of the DSG Tunnel.

This ability to substitute destination MAC addresses may be useful for increasing the security of the DSG Tunnel should the DSG Client ID or the DSG Tunnel Address become publicly known.

This is demonstrated in Figure 5-30, Example #1.

5.7.3 Many-to-one

In this scenario, one DSG Server may be supplying content to multiple DSG Clients over a larger area, while another DSG Server may be supplying directed content to a smaller serving area. Within a downstream, however, the content from both the DSG Servers are going to the same DSG Client.

DSG Advanced Mode allows multiple IP flows from the Backbone to merge into one DSG Tunnel. This is indicated to the DSG Client Controller by including multiple DSG Classifiers within one DSG Rule. Note that the multiple IP flows could be IP Unicast, IP Multicast, or both.

This is demonstrated in Figure 5-31, Example #5.

5.7.4 One-to-many

The ability to have multiple entries within the DSG Client ID TLV within a DSG Rule would allow one DSG Server to send common content with a single IP stream to the DSG Agent, and use a shared DSG Tunnel to DSG Clients from different manufacturers, each of which have their own DSG Client ID. This allows a one-to-many connectivity of DSG Server to DSG Clients, while maintaining the requirement that one IP address must be resolvable to only one MAC address.

This is demonstrated in Figure 5-31, Example #5.

5.7.5 Regionalization

An operator may want to send different content to different Set-top Devices from the same manufacturer on different HFC network segments. This can be accomplished in a variety of ways.

In DSG Advanced Mode, a DSG Tunnel Address substitution may be made on a per downstream basis. For example, there could be multiple IP flows from the DSG Server to the DSG Agent. These flows may be intended for the same function, such as EAS information, but the content differs across downstreams within the same subnet. Each of these flows would get mapped to a different DSG Tunnel Address on each downstream (or group of downstreams, depending upon geographical requirements). Each downstream would have a unique DCD message which would contain the same DSG Client ID, but would contain the unique DSG Tunnel Address. This is demonstrated in Figure 5-30, Example #2.

On a two-way HFC plant, the DSG Client Controller can use the Upstream Channel ID (UCID) for further granularity. One approach is to write a separate DSG Rule for each set of UCIDs that are within a region. Each DSG Rule would be for a separate DSG Tunnel. In this scenario, multiple DSG Rules would have the same DSG Client ID, but a different DSG Tunnel Address and a different UCID List. This is demonstrated in Figure 5-30, Example #3.

A second approach which would use fewer DSG Tunnels is for the DSG Server to place the regionalized content onto different destination UDP ports. Each destination UDP port would then be associated with a different set of UCIDs. In this scenario, multiple DSG Rules would have the same DSG Client ID and the same DSG Tunnel Address, but a different UCID List.

In both approaches, at least one DSG Rule would include the default DSG Tunnel for DSG eCMs which could not register and obtain UCIDs. This rule would have a lower Rule Priority than the other DSG Rules.

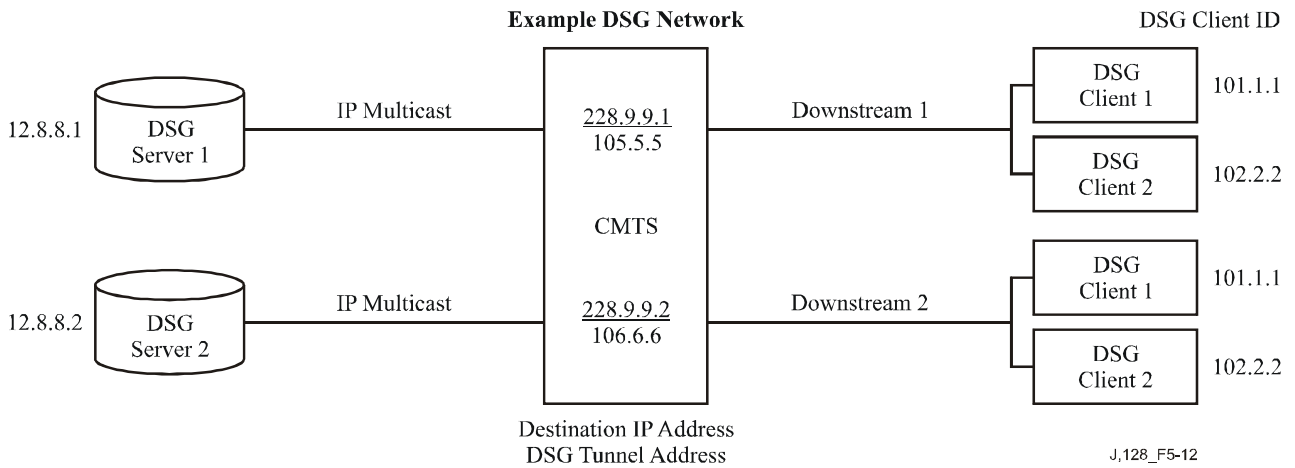

NOTE – 105.5.5 is short for 0105.0005.0005.

Example # 1: Two DSG Tunnels with MAC DA substitution. (DS = Downstream)

DSG Rule (DS1 & DS2)	
DSG Rule ID	1
DSG Client ID	101.1.1
DSG Tunnel Address	105.5.5

DSG Rule (DS1 & DS2)	
DSG Rule ID	2
DSG Client ID	102.2.2
DSG Tunnel Address	106.6.6

Example # 2: Regionalization per Downstream

DSG Rule (DS1)	
DSG Rule ID	1
DSG Client ID	101.1.1
DSG Tunnel Address	105.5.5

DSG Rule (DS2)	
DSG Rule ID	2
DSG Client ID	101.2.2
DSG Tunnel Address	106.6.6

Example # 3: Regionalization per Upstream (US)

DSG Rule (DS1)	
DSG Rule ID	1
DSG Client ID	101.1.1
DSG UCID List	1, 2, 3
DSG Tunnel Address	105.5.5

DSG Rule (DS1)	
DSG Rule ID	2
DSG Client ID	101.1.1
DSG UCID List	4, 5, 6
DSG Tunnel Address	106.6.6

Figure 5-30 – Example DSG configurations

Example #4: Two DSG Tunnels with Full Classifiers with MAC DA substitution.

DSG Rule (DS1 & DS2)	
DSG Rule ID	1
DSG Client ID	101.1.1
DSG Tunnel Address	105.5.5
DSG Classifier ID	10

DSG Rule (DS1 & DS2)	
DSG Rule ID	2
DSG Client ID	102.2.2
DSG Tunnel Address	106.6.6
DSG Classifier ID	20

DSG Classifier	
DSG Classifier ID	10
IP SA	12.8.8.1
IP DA	228.9.9.1
UDP DP	8000

DSG Classifier	
DSG Classifier ID	20
IP SA	12.8.8.2
IP DA	228.9.9.2
UDP DP	8000

Example #5: One DSG Tunnel, supporting both IP Multicast flows from multiple DSG Servers (many-to-one) to multiple DSG Clients (one-to-many) with full classification and MAC substitution.

DSG Rule (DS1 & DS2)	
DSG Rule ID	1
DSG Client ID	101.1.1 102.2.2
DSG Tunnel Address	105.5.5
DSG Classifier ID	10 20

DSG Classifier	
DSG Classifier ID	10
IP SA	12.8.8.1
IP DA	228.9.9.1
UDP DP	8000

DSG Classifier	
DSG Classifier ID	20
IP SA	12.8.8.2
IP DA	228.9.9.2
UDP DP	8000

Figure 5-31 – Example DSG configurations

5.7.6 Layer 4 multiplexing

One of the fields of the DSG Classifier is the destination UDP port. This provides more flexibility for how the DSG Server creates content and how the network delivers that content.

With DSG Advanced Mode, the DSG Server could assign different content to different destination UDP ports. There would then be one IP session from the DSG Server to the DSG Agent which would continue onto the DOCSIS downstream as a single DSG Tunnel. This DSG Tunnel would then feed multiple DSG Clients, based upon the destination UDP ports.

The DSG Address Table would contain a series of DSG Rules which pointed all participating DSG Clients to the same DSG Tunnel, but each of which contained a different pairing of destination UDP port and a DSG Client ID. A variant of this feature would be to include the UCID List in the DSG Rule to steer content from different UDP ports to different regions.

This is useful as there are fewer IP addresses on the DSG Agent to be reserved, and it permits DSG configurations to scale without impacting any IP address space limitations. This would also simplify the networking configuration of multicast by reducing the number of multicast sessions required and by pushing the management of different DSG Tunnel content to layer 4.

Care must be taken to not place too much content into one DSG Tunnel such that the combined content would exceed the rate limits chosen for the DSG Tunnel, or that the content would overwhelm the DSG eCM since the packet filter specified by the DSG Classifier is typically executed in software.

This mode of operation requires that the DSG Client Controller not only use the DSG Classifier as part of an accept/discard filter, but also to forward the correct content, based upon UDP Port, to the correct destination within the Set-top Device.

5.7.7 DSG channel list

A DSG Channel is a downstream channel that contains one or more DSG Tunnels. A DSG Channel List is therefore a list of downstreams that contain DSG Tunnels. Set-top Devices are responsible for picking a DSG Channel from the DSG Channel List, based upon some criteria that they own. The DSG Channel List is not intended to indicate which Set-top Device should go on which downstream.

Typically, the DSG Channel List will contain a list of all the DSG Channels, and the DSG Channel List will be advertised on all DOCSIS downstream channels, if the DOCSIS downstream channel is a DSG Channel. This typical scenario has exceptions. Each DOCSIS downstream serves different physical areas of the plant. A single CMTS may actually span two regions of the plant which have different frequencies for their DOCSIS downstreams. Thus, the DSG Channel List would be different for each of those regions.

As an example of operation, if the DSG Tunnels for Vendor A were on downstream A, the DSG Tunnels for Vendor B were on downstream B, and downstreams C and D had no DSG Tunnels, then the DSG Channel List would exist on downstreams A through D, but only list downstreams A and B. The Set-top Device would decide whether to transition between downstream A and B, based upon whether all its DSG Clients were able to find their appropriate DSG Tunnels.

5.7.8 Support for legacy DSG servers and legacy IP networks

Legacy DSG Servers may not support IP Multicast. Likewise, legacy IP networks may not support IP Multicast. These two facts create four operational scenarios, each of which have different solutions. These solutions are described in Table 5-3. Note that tunnelling of IP Multicast over IP Unicast is a preferred solution over Address Translation as it is a more common and efficient practice when dealing with IP Multicast.

Table 5-3 – Support strategies for legacy network equipment

DSG server capability	Network capability	Strategy
Multicast	Multicast	<p>The DSG Server generates an IP Multicast packet. The IP network delivers an IP Multicast packet to the CMTS. The CMTS passes the packet to the DSG Agent.</p> <p>This solution is the preferred solution.</p>
Multicast	Unicast	<p>The DSG Server tunnels an IP Multicast packet in an IP Unicast tunnel through the IP Network to each CMTS. The CMTS terminates the IP tunnel and delivers the IP Multicast packet to the DSG Agent.</p> <p>This solution compensates for a legacy IP network that does not support IP Multicast.</p>
Unicast	Multicast	<p>The DSG Server generates an IP Unicast packet. An external router to the DSG Server provides a Network Address Translation (NAT) function which translates the IP Unicast packet to IP Multicast. This router supports IP Multicast routing protocols and sends the IP Multicast packets to one or more CMTSs through the IP network. The CMTS passes the packet to its DSG Agent.</p> <p>This solution compensates for a legacy DSG Server which does not support IP Multicast. This solution allows the DSG Server to support multiple CMTSs.</p>
Unicast	Unicast	<p>The DSG Server generates an IP Unicast packet for each CMTS. The IP network delivers the IP Unicast packet to the CMTS. Either address translation is done to convert the IP Unicast packet to an IP Multicast packet or the IP Unicast packet is forwarded in a multicast fashion on multiple DOCSIS downstream channels.</p> <p>This solution results from both a legacy DSG Server and a legacy IP network.</p>

5.7.9 DCC considerations (Informative)

Dynamic Channel Change (DCC) operations [DOCSIS-RFI] allow the opportunity to move CMs, including DSG eCMs, to new US and/or DS channels. DCC operations can be triggered manually or autonomously for load-balancing purposes. If DCC is implemented and used to change downstream channels, then an operator needs to ensure that the content of the DSG Tunnels are forwarded onto the old and new DOCSIS downstream channels that are impacted by the DCC message. If not, the Set-top Device will not be able to receive DSG tunnel information on the downstream, and will eventually begin to hunt for a new downstream, a process that could take a significant period of time. Similarly, if DCC is implemented and used to change upstream channels and the DSG UCID List is being used, then the operator needs to ensure that the US channel the CM is being moved to is a part of that UCID List. If not, then the Set-top Device may begin receiving a different DSG Tunnel or have to search for a new DSG channel altogether. In all cases, if a DSG eCM is subject to DCC operations, then care must be taken to provide the proper provisioning and configuration of the DSG Agent and the DSG eCM.

5.7.10 DBC Considerations for DOCSIS 3.0 DSG eCMs

Dynamic Bonding Change (DBC) operations [J.222.2] allow the CMTS to change upstream and/or downstream bonding parameters or channels within a MAC domain on CMs including DSG eCMs operating in Multiple Receive Channel mode. At any time after registration, the CMTS uses the DBC command to change any combination of the following parameters in a CM: the receive channel set, the transmit channel set, DSID(s) or DSID associated attributes (including Multicast Rules), Security association(s) for encrypting downstream traffic and Service Flow SID Cluster Assignments.

DBC operations can be triggered manually or autonomously for load-balancing purposes. If DBC is implemented and used to change the Primary Downstream Channel, then an operator needs to ensure that the content of the DSG Tunnels are forwarded onto the old and new DOCSIS downstream channels that are impacted by the DBC message. If not, the Set-top Device will not be able to receive DSG tunnel information on the downstream, and will eventually begin to hunt for a new downstream, a process that could take a significant period of time. Similarly, if DBC is implemented and used to change the transmit channel set of the DSG eCM and the DSG UCID List is being used, then the operator needs to ensure that the lowest numbered UCID that the CM is being moved to is a part of that UCID List. If not, then the Set-top Device may begin receiving a different DSG Tunnel or have to search for a new DSG channel altogether.

DBC messaging is not intended to change the Multicast DSIDs of the DSG tunnels in any fashion. The DSIDs for the DSG tunnels are signalled via the MDD and the DBC messaging is not used to change those DSIDs. The use of DBC messaging to signal or change Multicast DSIDs for non-DSG tunnel traffic is permitted in DOCSIS 3.0 devices.

In all cases, if a DSG eCM is subject to DBC operations, then care must be taken to provide the proper provisioning and configuration of the DSG Agent and the DSG eCM.

5.7.11 Load Balancing Considerations

DOCSIS 2.0 & 3.0 CMTSs support autonomous load balancing of CMs using DCC and/or DBC. Also when a DOCSIS 3.0 CM registers with a DOCSIS 3.0 CMTS, the CMTS performs a channel assignment (RCC & TCC) [J.222.2] based on the load balancing configuration for the CM. Since the DSG Agent is unaware of the DSG tunnels being received by a particular DSG eCM, autonomous load balancing and DSG operation could conflict unless specifically configured otherwise.

One option to avoid this conflict is to disable load balancing on DSG eCMs. Alternatively, the operator could configure a restricted load balancing group that only contains downstream channels that are carrying identical DSG tunnels. Finally, the CMTS vendor could implement a load balancing policy which allows load balancing of upstream channels and/or non-primary downstream channels, but does not allow a change to the DSG eCMs Primary Downstream Channel.

Annex A

DOCSIS set-top gateway agent MIB definition

(This annex forms an integral part of this Recommendation)

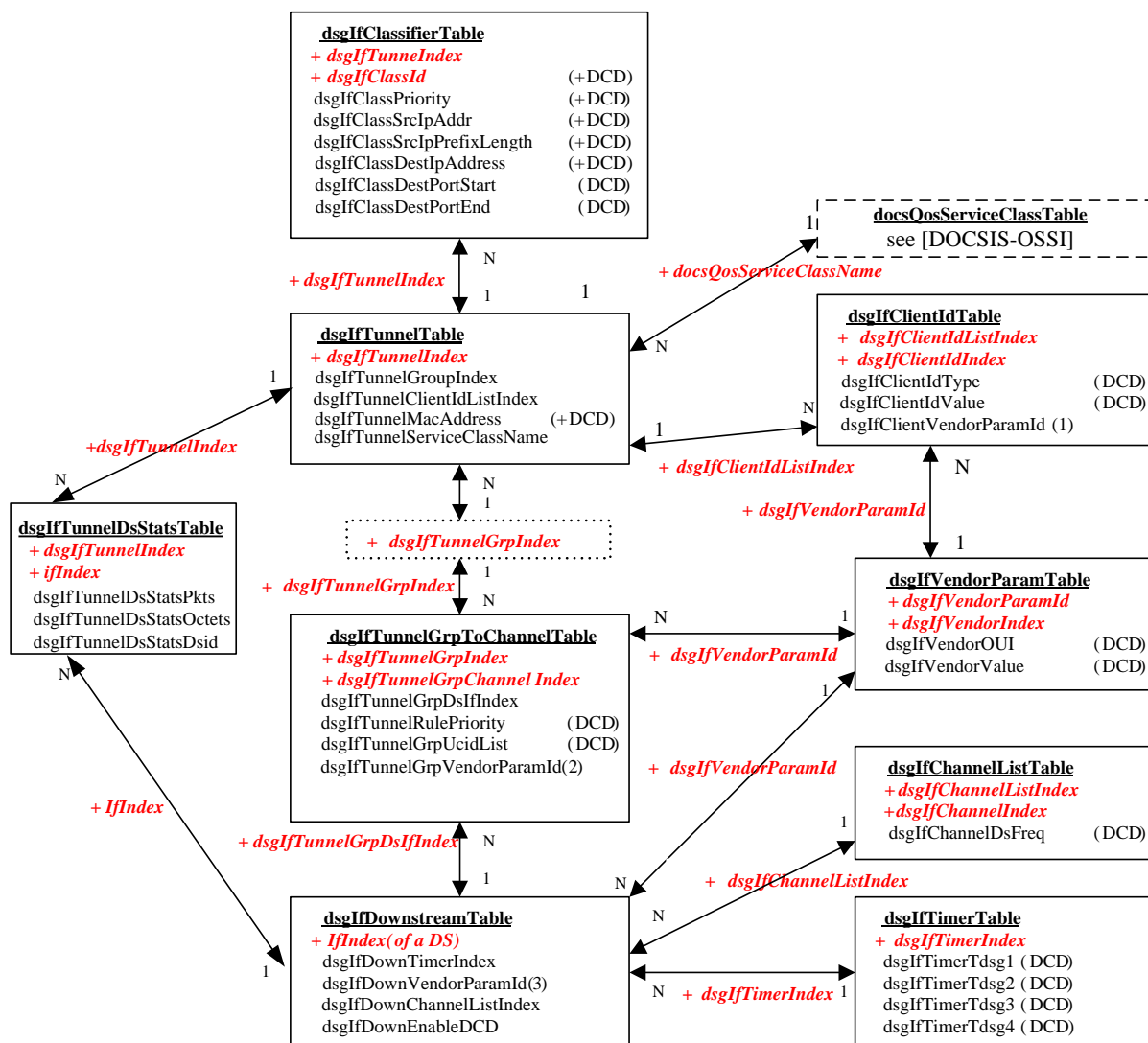

Note: DCD = Sent to DSG Client via DCD

+ DCD = Applies to DSG Agent & sent to DSG Client via DCD

DSG Rule = { Rule ID, Client IDs, VendorParams(1), Destination MAC Address, Rule Priority, UCID List, VendorParams(2), Classifier IDs }

DCD = { Classifier(s), DSG Rule(s), Timers, DSG Channel List, VendorParams(3) }

⋮ No actual table, just shown for clarity

⋮ Existing table from another MIB

Figure A.1 – DSG MIB module objects relationships

```

DSG-IF-MIB DEFINITIONS ::= BEGIN
IMPORTS
    MODULE-IDENTITY,
    OBJECT-TYPE,
    Unsigned32,
    Integer32
        FROM SNMPv2-SMI
    TruthValue,
    MacAddress,
    RowStatus
        FROM SNMPv2-TC
    OBJECT-GROUP,
    MODULE-COMPLIANCE
        FROM SNMPv2-CONF
    InetAddressType,
    InetAddress,
    InetAddressPrefixLength,
    InetPortNumber
        FROM INET-ADDRESS-MIB
    SnmpAdminString
        FROM SNMP-FRAMEWORK-MIB
    InterfaceIndex,
    ifIndex
        FROM IF-MIB
    Counter64
        FROM SNMPv2-SMI -- RFC 2578
    clabProjDocsis
        FROM CLAB-DEF-MIB;

dsgIfMIB MODULE-IDENTITY
    LAST-UPDATED "200806260000Z" -- June 26, 2008
    ORGANIZATION "Cable Television Laboratories, Inc"
    CONTACT-INFO
        "Postal: Cable Television Laboratories, Inc.
         858 Coal Creek Circle
         Louisville, Colorado 80027
         U.S.A.
        Phone : +1 303-661-9100
        Fax   : +1 303-661-9199
        E-mail: mibs@cablelabs.com"
    DESCRIPTION
        "This is the MIB Module for the DOCSIS Set-top Gateway
        (DSG). The DSG provides a one-way IP datagram transport
        for Out-Of-Band (OOB) messaging to cable set-top clients.
        The one-way IP datagram transport is called a DSG Tunnel.

        A DSG Tunnel carrying either a broadcast, unicast or
        multicast IP datagram stream originating at the DOCSIS
        Set-top Gateway and carrying Out-Of-Band messages intended
        for set-top clients. It is carried over one or more
        downstream DOCSIS channels.

        Multiple DSG tunnels may exist on a single downstream
        DOCSIS channel."
    REVISION "200806260000Z" -- June 26, 2008"
    DESCRIPTION
        "This revision, published as part of DOCSIS Set-top
        Gateway Specification."
    ::= { clabProjDocsis 3 }

Dsid ::= TEXTUAL-CONVENTION
    DISPLAY-HINT "d"
    STATUS current
    DESCRIPTION
        "This data type defines the 20-bit Downstream Service Identifier
        (DSID) used by the CM for downstream resequencing, filtering,
        and forwarding. The value zero is reserved for use when the
        DSID is unknown or does not apply."
    REFERENCE
        "DOCSIS 3.0 MAC and Upper Layer Protocols Interface

```

Specification CM-SP-MULPIv3.0-I08-080522, DSID Definition section."

SYNTAX Unsigned32 (0..1048575)

```
dsgIfMIBNotifications    OBJECT IDENTIFIER ::= { dsgIfMIB 0 }
dsgIfMIBObjects          OBJECT IDENTIFIER ::= { dsgIfMIB 1 }
dsgIfMIBConformance      OBJECT IDENTIFIER ::= { dsgIfMIB 2 }

dsgIfClassifier          OBJECT IDENTIFIER ::= { dsgIfMIBObjects 1 }
dsgIfTunnel              OBJECT IDENTIFIER ::= { dsgIfMIBObjects 2 }
dsgIfTunnelGrpToChannel  OBJECT IDENTIFIER ::= { dsgIfMIBObjects 3 }
dsgIfDownstreamChannel   OBJECT IDENTIFIER ::= { dsgIfMIBObjects 4 }

dsgIfDCD                 OBJECT IDENTIFIER ::= { dsgIfMIBObjects 5 }
dsgIfTunnelDsStats       OBJECT IDENTIFIER ::= { dsgIfMIBObjects 6 }
```

```
-----
--The Classifier Table contains objects for classifying packets.
--The DSG Agent applies the DSG classifier parameters to the inbound
--packets from the DSG server in order to assign the packet to the
--appropriate DSG tunnel. The DSG Agent must classify incoming
--packets based upon the objects in this table with the exception of
--the dsgIfClassDestPortStart and dsgIfClassDestPortEnd objects.
--
--The DSG Agent must also include these encoding in the DCD messages on
--the downstream channels to which the classifiers apply.
--
--The DSG classifier is unique per DSG Agent.
-----
```

```
dsgIfClassifierTable OBJECT-TYPE
    SYNTAX      SEQUENCE OF DsgIfClassifierEntry
    MAX-ACCESS  not-accessible
    STATUS      current
    DESCRIPTION
        "The Classifier Table contains attributes used to classify
        inbound packets into the tunnel and classifiers for the DSG
        clients, encoding in the DCD messages on the downstream
        channels to which the classifiers apply."
    ::= { dsgIfClassifier 1 }
```

```
dsgIfClassifierEntry OBJECT-TYPE
    SYNTAX      DsgIfClassifierEntry
    MAX-ACCESS  not-accessible
    STATUS      current
    DESCRIPTION
        "An entry in the Classifier Table. Rows are created
        by an SNMP SET request setting the value of
        dsgIfClassRowStatus to 'createAndGo'. Each entry is created
        for a tunnel, index by dsgTunnelIndex.

        Rows are deleted by an SNMP SET request setting the value
        of dsgIfClassRowStatus to 'destroy'."
    INDEX { dsgIfTunnelIndex, dsgIfClassId }
    ::= { dsgIfClassifierTable 1 }
```

```
DsgIfClassifierEntry ::= SEQUENCE {
    dsgIfClassId          Unsigned32,
    dsgIfClassPriority    Unsigned32,
    dsgIfClassSrcIpAddrType  InetAddressType,
    dsgIfClassSrcIpAddr    InetAddress,
    dsgIfClassSrcIpPrefixLength  InetAddressPrefixLength,
    dsgIfClassDestIpAddressType  InetAddressType,
    dsgIfClassDestIpAddress  InetAddress,
    dsgIfClassDestPortStart  InetPortNumber,
    dsgIfClassDestPortEnd    InetPortNumber,
    dsgIfClassRowStatus      RowStatus,
    dsgIfClassIncludeInDCD   TruthValue
}
```

```
dsgIfClassId OBJECT-TYPE
```

```

SYNTAX      Unsigned32 (1..65535)
MAX-ACCESS  not-accessible
STATUS      current
DESCRIPTION
    "The index that provides a unique classifier (in a DSG
    Agent). This value corresponds to the Classifier ID TLV
    in the DCD message."
 ::= { dsgIfClassifierEntry 1 }

dsgIfClassPriority OBJECT-TYPE
SYNTAX      Unsigned32 (0..255)
MAX-ACCESS  read-create
STATUS      current
DESCRIPTION
    "The priority of this classifier.
    Default value 0 indicates lowest priority."
DEFVAL { 0 }
 ::= { dsgIfClassifierEntry 2 }

dsgIfClassSrcIpAddrType OBJECT-TYPE
SYNTAX      InetAddressType
MAX-ACCESS  read-create
STATUS      current
DESCRIPTION
    "The type of internet address of dsgIfClassSrcIpAddress."
DEFVAL { ipv4 }
 ::= { dsgIfClassifierEntry 3 }

dsgIfClassSrcIpAddr OBJECT-TYPE
SYNTAX      InetAddress
MAX-ACCESS  read-create
STATUS      current
DESCRIPTION
    "The source IP address to be matched for this classifier.
    A value 0 for this object indicates a match of any IP
    address. A value that contains non-zero bits
    outside the range indicated by dsgIfClassSrcIpPrefixLength
    is invalid and should be rejected."
DEFVAL { '00000000'h }
 ::= { dsgIfClassifierEntry 4 }

dsgIfClassSrcIpPrefixLength OBJECT-TYPE
SYNTAX      InetAddressPrefixLength
MAX-ACCESS  read-create
STATUS      current
DESCRIPTION
    "The length of the CIDR Prefix carried in
    dsgIfClassSrcIpAddr. In IPv4 addresses, a length of 32 indicates
    a match of a single host address, and a length between
    0 and 32 indicates the use of a CIDR Prefix. A length of
    0 is not allowed. This object is irrelevant and not used
    when dsgIfClassSrcIpAddr value is 0."
DEFVAL { 32 }
 ::= { dsgIfClassifierEntry 5 }

dsgIfClassDestIpAddressType OBJECT-TYPE
SYNTAX      InetAddressType
MAX-ACCESS  read-create
STATUS      current
DESCRIPTION
    "The type of internet address of dsgIfClassDestIpAddress."
DEFVAL { ipv4 }
 ::= { dsgIfClassifierEntry 6 }

dsgIfClassDestIpAddress OBJECT-TYPE
SYNTAX      InetAddress
MAX-ACCESS  read-create
STATUS      current
DESCRIPTION
    "The destination IP address to be matched for this
    classifier."

```

```

DEFVAL { '00000000'h }
::= { dsgIfClassifierEntry 7 }

dsgIfClassDestPortStart OBJECT-TYPE
SYNTAX      InetPortNumber
MAX-ACCESS  read-create
STATUS      current
DESCRIPTION
    "This is the inclusive lower bound of the transport-layer
    source port range that is to be matched."
DEFVAL { 0 }
::= { dsgIfClassifierEntry 8 }

dsgIfClassDestPortEnd OBJECT-TYPE
SYNTAX      InetPortNumber
MAX-ACCESS  read-create
STATUS      current
DESCRIPTION
    "This is the inclusive higher bound of the transport-layer
    source port range that is to be matched."
DEFVAL { 65535 }
::= { dsgIfClassifierEntry 9 }

dsgIfClassRowStatus OBJECT-TYPE
SYNTAX      RowStatus
MAX-ACCESS  read-create
STATUS      current
DESCRIPTION
    "The status of the row. A value of active(1) indicates
    that this classifier is applied to this tunnel.
    A value of notInService(2) indicates that matching of
    the packets are ignored and this classifier parameters
    will not be included in the DCD message."
::= { dsgIfClassifierEntry 10 }

dsgIfClassIncludeInDCD OBJECT-TYPE
SYNTAX      TruthValue
MAX-ACCESS  read-create
STATUS      current
DESCRIPTION
    "Indicates whether or not this DSG Classifier will
    be sent in DCD messages for use as a Layer-3 and
    Layer-4 packet filter by the DSG eCM."
DEFVAL { false }
::= { dsgIfClassifierEntry 11 }

-----
-- The DSG Tunnel Table contains group(s) of DSG Tunnel Indexes.
-- Tunnel Entry is mapped to the destination MAC address and each
-- tunnel is associated to the Qos Service Class Name.
-----

dsgIfTunnelTable OBJECT-TYPE
SYNTAX      SEQUENCE OF DsgIfTunnelEntry
MAX-ACCESS  not-accessible
STATUS      current
DESCRIPTION
    "The DSG Tunnel Table contains group(s) of tunnel(s).
    Each tunnel is associated to the destination MAC address."
::= { dsgIfTunnel 1 }

dsgIfTunnelEntry OBJECT-TYPE
SYNTAX      DsgIfTunnelEntry
MAX-ACCESS  not-accessible
STATUS      current
DESCRIPTION
    "An entry in the DSG Tunnel Table. Rows are created by
    an SNMP SET request setting the value of
    dsgIfTunnelRowStatus to 'createAndGo'.

    Each entry associated to a tunnel. A dsgIfTunnelGroupIndex

```

represents a group of tunnels that could be associated to one or more downstreams. Each `dsgIfTunnelIndex` represents a tunnel.

Rows are deleted by an SNMP SET request setting the value of `dsgIfTunnelRowStatus` to 'destroy'."

```
INDEX { dsgIfTunnelIndex }  
::= { dsgIfTunnelTable 1 }
```

```
DsgIfTunnelEntry ::= SEQUENCE {  
    dsgIfTunnelIndex           Unsigned32,  
    dsgIfTunnelGroupIndex     Unsigned32,  
    dsgIfTunnelClientIdListIndex Unsigned32,  
    dsgIfTunnelMacAddress      MacAddress,  
    dsgIfTunnelServiceClassName SnmpAdminString,  
    dsgIfTunnelRowStatus      RowStatus  
}
```

```
dsgIfTunnelIndex OBJECT-TYPE  
SYNTAX      Unsigned32  
MAX-ACCESS  not-accessible  
STATUS      current  
DESCRIPTION  
    "The index into the DSG Tunnel table that represents  
    a tunnel."  
::= { dsgIfTunnelEntry 1 }
```

```
dsgIfTunnelGroupIndex OBJECT-TYPE  
SYNTAX      Unsigned32  
MAX-ACCESS  read-create  
STATUS      current  
DESCRIPTION  
    "This index represents a group of tunnels that could be  
    associated to one or more downstreams which mapped  
    to dsgIfTunnelGrpIndex."  
::= { dsgIfTunnelEntry 2 }
```

```
dsgIfTunnelClientIdListIndex OBJECT-TYPE  
SYNTAX      Unsigned32  
MAX-ACCESS  read-create  
STATUS      current  
DESCRIPTION  
    "This index represents a group of client id(s)  
    which mapped to dsgIfClientIdListIndex."  
::= { dsgIfTunnelEntry 3 }
```

```
dsgIfTunnelMacAddress OBJECT-TYPE  
SYNTAX      MacAddress  
MAX-ACCESS  read-create  
STATUS      current  
DESCRIPTION  
    "The DSG tunnel destination MAC address."  
DEFVAL { '000000000000'h }  
::= { dsgIfTunnelEntry 4 }
```

```
dsgIfTunnelServiceClassName OBJECT-TYPE  
SYNTAX      SnmpAdminString  
MAX-ACCESS  read-create  
STATUS      current  
DESCRIPTION  
    "For DOCSIS 2.0 the Service Class Name is associated  
    to the docsQosServiceClassName in the DOCS-QOS-MIB.  
    For DOCSIS 3.0 the Service Class Name is associated  
    to the docsQosServiceClassName in the DOCS-QOS3-MIB.  
    Creation of a Service Class MUST be configured through  
    the docsQosServiceClassTable. Only partial of the  
    docsQosServiceClassTable objects are applicable to the  
    DSG service class thus some are ignored.
```

If the referenced parameter is not present in the corresponding DOCSIS QOS Parameter Set, the default

```

        value of this object is a zero length string."
REFERENCE "SP-RFiv1.1-I10-030730, Appendix C.2.2.3.4
          CM-SP-MULPIv3.0-I07-080215 Annex C.2.2.3.4;
          CM-SP-OSSIV2.0-I10-070803 Annex J;
          CM-SP-OSSIV3.0-I06-080215 Annex Q.7"
 ::= { dsGIfTunnelEntry 5 }

```

```

dsGIfTunnelRowStatus OBJECT-TYPE
SYNTAX      RowStatus
MAX-ACCESS  read-create
STATUS      current
DESCRIPTION
    "The status of the row. A value of notInService(2)
    indicates that this tunnel is disabled and no OOB traffic
    will be forwarded to DSG clients and these tunnel parameters
    will not be included in the DCD message."
 ::= { dsGIfTunnelEntry 6}

```

```

-----
--The DSG Tunnel Group to Channel Table contains the association of
--groups of tunnels to one or more downstream channels. This table
--contains the downstream ifIndex, rule priority, UCID Range and vendor
--parameter identification(2).
-----

```

```

dsGIfTunnelGrpToChannelTable OBJECT-TYPE
SYNTAX      SEQUENCE OF DsgIfTunnelGrpToChannelEntry
MAX-ACCESS  not-accessible
STATUS      current
DESCRIPTION
    "The DSG Tunnel Group to Channel Table associates a group
    of tunnels to one or more downstream channels."
 ::= { dsGIfTunnelGrpToChannel 1 }

```

```

dsGIfTunnelGrpToChannelEntry OBJECT-TYPE
SYNTAX      DsgIfTunnelGrpToChannelEntry
MAX-ACCESS  not-accessible
STATUS      current
DESCRIPTION
    "An entry in the DSG Tunnel Table. Rows are created by
    an SNMP SET request setting the value of
    dsGIfTunnelGrpRowStatus to 'createAndGo'.

    Rows are deleted by an SNMP SET request setting the
    value of dsGIfTunnelRowStatus to 'destroy'."
INDEX { dsGIfTunnelGrpIndex, dsGIfTunnelGrpChannelIndex }
 ::= { dsGIfTunnelGrpToChannelTable 1 }

```

```

DsgIfTunnelGrpToChannelEntry ::= SEQUENCE {
    dsGIfTunnelGrpIndex      Unsigned32,
    dsGIfTunnelGrpChannelIndex Unsigned32,
    dsGIfTunnelGrpDsIfIndex  InterfaceIndex,
    dsGIfTunnelGrpRulePriority Unsigned32,
    dsGIfTunnelGrpUcidList   OCTET STRING,
    dsGIfTunnelGrpVendorParamId Unsigned32,
    dsGIfTunnelGrpRowStatus   RowStatus
}

```

```

dsGIfTunnelGrpIndex OBJECT-TYPE
SYNTAX      Unsigned32
MAX-ACCESS  not-accessible
STATUS      current
DESCRIPTION
    "The index into this table."
 ::= { dsGIfTunnelGrpToChannelEntry 1 }

```

```

dsGIfTunnelGrpChannelIndex OBJECT-TYPE
SYNTAX      Unsigned32
MAX-ACCESS  not-accessible
STATUS      current
DESCRIPTION

```

```

        "The index into this table."
 ::= { dsGIfTunnelGrpToChannelEntry 2 }

dsGIfTunnelGrpDsIfIndex OBJECT-TYPE
SYNTAX      InterfaceIndex
MAX-ACCESS  read-create
STATUS      current
DESCRIPTION
    "The downstream ifIndex that will be associated to
     this group of tunnel(s)."
```

```

 ::= { dsGIfTunnelGrpToChannelEntry 3 }

dsGIfTunnelGrpRulePriority OBJECT-TYPE
SYNTAX      Unsigned32 (0..255)
MAX-ACCESS  read-create
STATUS      current
DESCRIPTION
    "The DSG rule priority determines the order of which
     channel and its associated UCIDs should be applied by
     the DSG client. The default value is 0, which is the lowest
     priority."
DEFVAL { 0 }
 ::= { dsGIfTunnelGrpToChannelEntry 4 }

dsGIfTunnelGrpUcidList OBJECT-TYPE
SYNTAX      OCTET STRING (SIZE(0..255))
MAX-ACCESS  read-create
STATUS      current
DESCRIPTION
    "The list of Upstream Channel ID (UCID) values (octets)
     for which the DSG rule applies. One octet represents one UCID value (0-255) A
     DSG client matches this parameter if its UCID value is included in the list.
     The default value of zero length string indicates that this
     DSG Rule applies to all DSG clients."
DEFVAL { "" }
 ::= { dsGIfTunnelGrpToChannelEntry 5 }

dsGIfTunnelGrpVendorParamId OBJECT-TYPE
SYNTAX      Unsigned32
MAX-ACCESS  read-create
STATUS      current
DESCRIPTION
    "The index of vendor parameter, dsGIfVendorParamId in the
     dsGIfVendorParamTable describing the vendor specific DSG
     parameters. If no associated entry in dsGIfVendorParamTable
     exists, this value is 0."
DEFVAL { 0 }
 ::= { dsGIfTunnelGrpToChannelEntry 6 }

dsGIfTunnelGrpRowStatus OBJECT-TYPE
SYNTAX      RowStatus
MAX-ACCESS  read-create
STATUS      current
DESCRIPTION
    "The status of this row. The value of notInService(2)
     indicates that this tunnel group is disabled and no OOB
     traffic on all the associated tunnel(s) will be forwarded
     to DSG clients and all parameters will not be included in
     the DCD message."
 ::= { dsGIfTunnelGrpToChannelEntry 7 }

-----
--The Downstream Table contains the DSG Tunnel Index, the timer
--index, specific vendor parameter identification(3) and the
--index to the downstream channel list.
-----

dsGIfDownstreamTable OBJECT-TYPE
SYNTAX      SEQUENCE OF DsgIfDownstreamEntry
MAX-ACCESS  not-accessible
STATUS      current
```

DESCRIPTION

"The DSG Downstream Table contains the associated timers, vendor specific parameters index and the channel list index to a specific downstream."

::= { dsgIfDownstreamChannel 1 }

dsgIfDownstreamEntry OBJECT-TYPE

SYNTAX DsgIfDownstreamEntry

MAX-ACCESS not-accessible

STATUS current

DESCRIPTION

"An entry in the DSG Downstream Table.

An entry in this table exists for each ifEntry with an ifType of docsCableDownstream(128)."

INDEX { ifIndex }

::= { dsgIfDownstreamTable 1 }

DsgIfDownstreamEntry ::= SEQUENCE {

dsgIfDownTimerIndex Unsigned32,

dsgIfDownVendorParamId Unsigned32,

dsgIfDownChannelListIndex Unsigned32,

dsgIfDownEnableDCD TruthValue

}

dsgIfDownTimerIndex OBJECT-TYPE

SYNTAX Unsigned32

MAX-ACCESS read-write

STATUS current

DESCRIPTION

"The index into the timer table, dsgIfTimerTable providing the timers used by the DSG client(s).

The default value 0 indicates there is no associated timers that need to be sent in the DCD message."

DEFVAL { 0 }

::= { dsgIfDownstreamEntry 1 }

dsgIfDownVendorParamId OBJECT-TYPE

SYNTAX Unsigned32

MAX-ACCESS read-write

STATUS current

DESCRIPTION

"The index of vendor parameter, dsgIfVendorParamId in the dsgIfVendorParamTable describing the vendor specific DSG parameters. If no associated entry in dsgIfVendorParamTable exists, this value is 0."

DEFVAL { 0 }

::= { dsgIfDownstreamEntry 2 }

dsgIfDownChannelListIndex OBJECT-TYPE

SYNTAX Unsigned32

MAX-ACCESS read-write

STATUS current

DESCRIPTION

"The index of the downstream frequency channel lists, dsgIfChannelListIndex in the dsgIfChannelListTable providing the list of downstream frequencies that contain DSG tunnels."

DEFVAL { 0 }

::= { dsgIfDownstreamEntry 3 }

dsgIfDownEnableDCD OBJECT-TYPE

SYNTAX TruthValue

MAX-ACCESS read-write

STATUS current

DESCRIPTION

"Used to enable or disable DCD messages to be sent on this downstream channel. The value is always true(1) for those downstreams that contain one or many DSG Tunnels."

::= { dsgIfDownstreamEntry 4 }

--The Client Table contains the objects that specify the matching
 --parameters for the DSG clients for which the DSG rules applies.
 --The DSG clients recognized that ids may be originated from different
 --address space. The same DSG client id may be used by multiple rules.

```

-----

dsgIfClientIdTable OBJECT-TYPE
  SYNTAX      SEQUENCE OF DsgIfClientIdEntry
  MAX-ACCESS  not-accessible
  STATUS      current
  DESCRIPTION
    "The Client Identification Table contains the client
    identification type and value. It also contains the
    vendor specific parameter identification. There could
    be multiple client ids associated to a tunnel, grouped
    by the dsgIfClientIdListIndex."
  ::= { dsgIfDCD 1 }

dsgIfClientIdEntry OBJECT-TYPE
  SYNTAX      DsgIfClientIdEntry
  MAX-ACCESS  not-accessible
  STATUS      current
  DESCRIPTION
    "An entry in the Client Id Table. Rows are created
    by an SNMP SET request setting the value of
    dsgIfClientRowStatus to 'createAndGo'.

    Rows are deleted by an SNMP SET request setting the
    value of dsgIfClientIdRowStatus to 'destroy'."
  INDEX { dsgIfClientIdListIndex, dsgIfClientIdIndex }
  ::= { dsgIfClientIdTable 1 }

DsgIfClientIdEntry ::= SEQUENCE {
  dsgIfClientIdListIndex  Unsigned32,
  dsgIfClientIdIndex      Unsigned32,
  dsgIfClientIdType       INTEGER,
  dsgIfClientIdValue      OCTET STRING,
  dsgIfClientVendorParamId Unsigned32,
  dsgIfClientRowStatus    RowStatus
}

dsgIfClientIdListIndex OBJECT-TYPE
  SYNTAX      Unsigned32
  MAX-ACCESS  not-accessible
  STATUS      current
  DESCRIPTION
    "The index to this table."
  ::= { dsgIfClientIdEntry 1 }

dsgIfClientIdIndex OBJECT-TYPE
  SYNTAX      Unsigned32
  MAX-ACCESS  not-accessible
  STATUS      current
  DESCRIPTION
    "The index to each entry of the Client Id."
  ::= { dsgIfClientIdEntry 2 }

dsgIfClientIdType OBJECT-TYPE
  SYNTAX      INTEGER {
    broadcast(1),
    macAddress(2),
    caSystemId(3),
    applicationId(4)
  }
  MAX-ACCESS  read-create
  STATUS      current
  DESCRIPTION
    "The Client Identification type. A DSG client id of type
    broadcast(1) received by all DSG client(s). A DSG client
    id of type macAddress(2) is received by the DSG client that
  
```

has been assigned with this MAC address where the first 3 bytes are the Organization Unique Identifier (OUI). A DSG client id of type caSystemId(3) is received by the DSG client that has been assigned a CA_system_ID. A DSG client id of type applicationId(4) is received by the DSG client that has been assigned an application ID."

```
DEFVAL { broadcast }  
 ::= { dsgIfClientIdEntry 3 }
```

dsgIfClientIdValue OBJECT-TYPE

SYNTAX OCTET STRING (SIZE(6))

MAX-ACCESS read-create

STATUS current

DESCRIPTION

"The Client Identification Value. The content depends on the value of the dsgIfClientIdType.

For dsgIfClientIdType of a type broadcast(1), this object will have a 16-bit value whether or not it is a length 0 or length 2 broadcast ID. If the value is 0, then the encoded TLV in the DCD would be the original, zero length, broadcast ID. If the value is specified in Table 5-2, then the TLV in the DCD would be a length 2 broadcast ID followed by the value.

For dsgIfClientIdType of a type macAddress(2), this object is a well-known MAC address.

For dsgIfClientIdType of a type caSystemId(3), this object is a CA System ID.

For dsgIfClientIdType of a type applicationId(4), this object is an application ID.

Client IDs representing types broadcast(1), caSystemId(3) or applicationId(4) are encoded in DCD messages as Unsigned integers and configured in this object as 6 octet string with the 2 LSB for the client ID value, e.g., an applicationId 2048 (0x0800) is encoded as '000000000800'h."

REFERENCE

"DOCSIS Set-top Gateway (DSG) Interface"

```
DEFVAL { '000000000000'h }  
 ::= { dsgIfClientIdEntry 4 }
```

dsgIfClientVendorParamId OBJECT-TYPE

SYNTAX Unsigned32

MAX-ACCESS read-create

STATUS current

DESCRIPTION

"The index of the vendor parameter id, dsgIfVendorParamId in the dsgIfVendorParamTable describing the vendor specific DSG parameters. If no associated entry in dsgIfVendorParamTable exists, this value is 0."

```
DEFVAL { 0 }  
 ::= { dsgIfClientIdEntry 5 }
```

dsgIfClientRowStatus OBJECT-TYPE

SYNTAX RowStatus

MAX-ACCESS read-create

STATUS current

DESCRIPTION

"The status of the row."

```
 ::= { dsgIfClientIdEntry 6 }
```

--The Vendor Parameter Table contains vendor-specific parameters
--which allow vendors to send the specific parameters within a
--DSG rule or within the DSG Configuration block in a DCD message.

dsgIfVendorParamTable OBJECT-TYPE

SYNTAX SEQUENCE OF DsgIfVendorParamEntry

MAX-ACCESS not-accessible

STATUS current

DESCRIPTION

"The DSG Vendor Parameter Table allows vendors to send

```

        specific parameters to the DSG clients within a DSG
        rule or within the DSG Configuration block in a
        DCD message."
 ::= { dsgIfDCD 2 }

dsgIfVendorParamEntry OBJECT-TYPE
SYNTAX      DsgIfVendorParamEntry
MAX-ACCESS  not-accessible
STATUS      current
DESCRIPTION
    "An entry in the DSG Vendor Parameter Table. Rows are
    created by an SNMP SET request setting the value of
    dsgIfVendorRowStatus to 'createAndGo'. Each entry
    represents one or more vendor's specific parameters.
    Rows are deleted by an SNMP SET request setting the
    value of dsgIfVendorRowStatus to 'destroy'."

    There are limits to the amount of vendor specific
    information that can be carried in a DSG Rule or
    DSG Configuration block. An SNMP SET request which
    would result in these limits being exceeded should be
    rejected."
INDEX { dsgIfVendorParamId, dsgIfVendorIndex }
 ::= { dsgIfVendorParamTable 1 }

DsgIfVendorParamEntry ::= SEQUENCE {
    dsgIfVendorParamId      Unsigned32,
    dsgIfVendorIndex        Unsigned32,
    dsgIfVendorOUI          OCTET STRING,
    dsgIfVendorValue        OCTET STRING,
    dsgIfVendorRowStatus    RowStatus
}

dsgIfVendorParamId OBJECT-TYPE
SYNTAX      Unsigned32
MAX-ACCESS  not-accessible
STATUS      current
DESCRIPTION
    "The index of the table."
 ::= { dsgIfVendorParamEntry 1 }

dsgIfVendorIndex OBJECT-TYPE
SYNTAX      Unsigned32
MAX-ACCESS  not-accessible
STATUS      current
DESCRIPTION
    "The Vendor Specific Index."
 ::= { dsgIfVendorParamEntry 2 }

dsgIfVendorOUI OBJECT-TYPE
SYNTAX      OCTET STRING (SIZE(3))
MAX-ACCESS  read-create
STATUS      current
DESCRIPTION
    "The Vendor assigned Organization Unique Id (OUI).".
DEFVAL { '000000'h }
 ::= { dsgIfVendorParamEntry 3 }

dsgIfVendorValue OBJECT-TYPE
SYNTAX      OCTET STRING (SIZE(0..50))
MAX-ACCESS  read-create
STATUS      current
DESCRIPTION
    "The Vendor Specific Parameter Value."
DEFVAL { "" }
 ::= { dsgIfVendorParamEntry 4 }

dsgIfVendorRowStatus OBJECT-TYPE
SYNTAX      RowStatus
MAX-ACCESS  read-create
STATUS      current

```

```
DESCRIPTION
    "The status of the row."
 ::= { dsGIfVendorParamEntry 5 }
```

```
-----
--The Channel List Table contains lists of one or multiple
--downstream frequencies that are carrying DSG tunnels. The
--appropriate DSG Channel List will be included in the DCD
--message on the associated downstream channel from the
--dsGIfDownstreamTable.
--The DSG Client uses this list to determine which downstream
--frequencies have DSG Tunnels present.
-----
```

```
dsGIfChannelListTable OBJECT-TYPE
    SYNTAX          SEQUENCE OF DsgIfChannelListEntry
    MAX-ACCESS      not-accessible
    STATUS          current
    DESCRIPTION
        "The DSG Channel List Table contains a list of one or
        multiple downstream frequencies that are carrying DSG
        tunnel(s)."
```

```
 ::= { dsGIfDCD 3 }
```

```
dsGIfChannelListEntry OBJECT-TYPE
    SYNTAX          DsgIfChannelListEntry
    MAX-ACCESS      not-accessible
    STATUS          current
    DESCRIPTION
        "An entry in the DSG Channel List Table. Rows are
        created by an SNMP SET request setting the value of
        dsGIfChannelRowStatus to 'createAndGo'."

        Rows are deleted by an SNMP SET request setting the value
        of dsGIfChannelRowStatus to 'destroy'."
    INDEX { dsGIfChannelListIndex, dsGIfChannelIndex }
 ::= { dsGIfChannelListTable 1 }
```

```
DsgIfChannelListEntry ::= SEQUENCE {
    dsGIfChannelListIndex Unsigned32,
    dsGIfChannelIndex     Unsigned32,
    dsGIfChannelDsFreq    Integer32,
    dsGIfChannelRowStatus RowStatus
}
```

```
dsGIfChannelListIndex OBJECT-TYPE
    SYNTAX          Unsigned32
    MAX-ACCESS      not-accessible
    STATUS          current
    DESCRIPTION
        "The index to this table."
 ::= { dsGIfChannelListEntry 1 }
```

```
dsGIfChannelIndex OBJECT-TYPE
    SYNTAX          Unsigned32
    MAX-ACCESS      not-accessible
    STATUS          current
    DESCRIPTION
        "The index for each downstream frequency that
        contains the DSG tunnel(s)."
```

```
 ::= { dsGIfChannelListEntry 2 }
```

```
dsGIfChannelDsFreq OBJECT-TYPE
    SYNTAX          Integer32 (0..1000000000)
    UNITS           "hertz"
    MAX-ACCESS      read-create
    STATUS          current
    DESCRIPTION
        "The DOCSIS downstream centre frequency. The receive
        frequency MUST be a multiple of 62500 Hz."
```

```
 DEFVAL { 0 }
```



```

 ::= { dsgIfChannelListEntry 3 }

dsgIfChannelRowStatus OBJECT-TYPE
SYNTAX      RowStatus
MAX-ACCESS  read-create
STATUS      current
DESCRIPTION
    "The status of the row."
 ::= { dsgIfChannelListEntry 4 }

-----
--The Timer Table contains 4 timeout timers that are sent to the DSG
--clients via the DCD message. These timers are sent to the DSG clients
--via the DCD message.
--Each downstream mapped to only one set of timers.
-----

dsgIfTimerTable OBJECT-TYPE
SYNTAX      SEQUENCE OF DsgIfTimerEntry
MAX-ACCESS  not-accessible
STATUS      current
DESCRIPTION
    "The DSG Timer Table contains timers that are sent to
    the DSG client(s) via the DCD message."
 ::= { dsgIfDCD 4 }

dsgIfTimerEntry OBJECT-TYPE
SYNTAX      DsgIfTimerEntry
MAX-ACCESS  not-accessible
STATUS      current
DESCRIPTION
    "An entry in the DSG Timer Table. Rows are created
    by an SNMP SET request setting the value of
    dsgIfTimerRowStatus to 'createAndGo'.

    Rows are deleted by an SNMP SET request setting the value
    of dsgIfTimerRowStatus to 'destroy'."
INDEX { dsgIfTimerIndex }
 ::= { dsgIfTimerTable 1 }

DsgIfTimerEntry ::= SEQUENCE {
    dsgIfTimerIndex      Unsigned32,
    dsgIfTimerTdsg1     Unsigned32,
    dsgIfTimerTdsg2     Unsigned32,
    dsgIfTimerTdsg3     Unsigned32,
    dsgIfTimerTdsg4     Unsigned32,
    dsgIfTimerRowStatus RowStatus
}

dsgIfTimerIndex OBJECT-TYPE
SYNTAX      Unsigned32
MAX-ACCESS  not-accessible
STATUS      current
DESCRIPTION
    "The index to this table."
 ::= { dsgIfTimerEntry 1 }

dsgIfTimerTdsg1 OBJECT-TYPE
SYNTAX      Unsigned32 (1..65535)
UNITS      "second"
MAX-ACCESS  read-create
STATUS      current
DESCRIPTION
    "Initialization Timeout. This is the timeout period
    for the DSG packets during initialization of the DSG
    client. The default value is 2 seconds."
DEFVAL { 2 }
 ::= { dsgIfTimerEntry 2 }

dsgIfTimerTdsg2 OBJECT-TYPE
SYNTAX      Unsigned32 (1..65535)

```

```

UNITS          "second"
MAX-ACCESS    read-create
STATUS        current
DESCRIPTION
    "Operational Timeout. This is the timeout period for
    the DSG packets during normal operation of the DSG client.
    Default value is 600 seconds."
DEFVAL { 600 }
 ::= { dsgIfTimerEntry 3 }

dsgIfTimerTdsg3 OBJECT-TYPE
SYNTAX        Unsigned32 (0..65535)
UNITS          "second"
MAX-ACCESS    read-create
STATUS        current
DESCRIPTION
    "Two-way retry timer. This is the retry timer that
    determines when the DSG client attempts to reconnect
    with the DSG Agent and established two-way connectivity.
    Default value is 300 seconds. The value 0 indicates that
    the client will continuously retry two-way operation."
DEFVAL { 300 }
 ::= { dsgIfTimerEntry 4 }

dsgIfTimerTdsg4 OBJECT-TYPE
SYNTAX        Unsigned32 (0..65535)
UNITS          "second"
MAX-ACCESS    read-create
STATUS        current
DESCRIPTION
    "One-way retry timer. The retry timer that determines
    when the client attempts to rescan for a DOCSIS
    downstream channel that contains DSG packets after a
    dsgIfTimerTdsg1 or dsgIfTimerTdsg2 timeout.
    Default value is 1800 seconds. The value 0 indicates that
    the client will immediately begin scanning upon
    dsgIfTimerTdsg1 or dsgIfTimerTdsg2 timeout."
DEFVAL { 1800 }
 ::= { dsgIfTimerEntry 5 }

dsgIfTimerRowStatus OBJECT-TYPE
SYNTAX        RowStatus
MAX-ACCESS    read-create
STATUS        current
DESCRIPTION
    "The status of the row."
 ::= { dsgIfTimerEntry 6 }

-----
--The IF Tunnel Downstream Stats Table is indexed by the DSG Tunnel
--Index & the ifIndex of the downstream. It contains the packet and byte
--counters for each tunnel. In addition for 3.0 devices it contains the
--DSID used to label the tunnel traffic
-----

dsgIfTunnelDsStatsTable OBJECT-TYPE
SYNTAX        SEQUENCE OF DsgIfTunnelDsStatsEntry
MAX-ACCESS    not-accessible
STATUS        current
DESCRIPTION
    "The IF Tunnel Downstream Stats Table contains
    the packet and byte counters for the tunnel. It also
    contains the DSID used by the tunnel traffic."
 ::= { dsgIfTunnelDsStats 1 }

dsgIfTunnelDsStatsEntry OBJECT-TYPE
SYNTAX        DsgIfTunnelDsStatsEntry
MAX-ACCESS    not-accessible
STATUS        current
DESCRIPTION
    "An entry in the DSG IF Tunnel Downstream Stats Table.

```

```

        An entry in this table exists for each dsgIfTunnelIndex
        and an ifIndex of docsCableDownstream(128)."
```

INDEX { dsgIfTunnelIndex,
ifIndex }

```
 ::= { dsgIfTunnelDsStatsTable 1 }
```

DsgIfTunnelDsStatsEntry ::= SEQUENCE {
dsgIfTunnelDsStatsPkts Counter64,
dsgIfTunnelDsStatsOctets Counter64,
dsgIfTunnelDsStatsDsid Dsid
}

dsgIfTunnelDsStatsPkts OBJECT-TYPE
SYNTAX Counter64
UNITS "packets"
MAX-ACCESS read-only
STATUS current
DESCRIPTION
"This attribute indicates the count of the number of
packets transmitted in this tunnel"
 ::= { dsgIfTunnelDsStatsEntry 1 }

dsgIfTunnelDsStatsOctets OBJECT-TYPE
SYNTAX Counter64
UNITS "bytes"
MAX-ACCESS read-only
STATUS current
DESCRIPTION
"This attribute indicates the count of the number of
octets transmitted in this tunnel "
 ::= { dsgIfTunnelDsStatsEntry 2 }

dsgIfTunnelDsStatsDsid OBJECT-TYPE
SYNTAX Dsid
MAX-ACCESS read-only
STATUS current
DESCRIPTION
"When operating with Multicast DSID Forwarding (MDF)
enabled, this object contains the DSID value with which the
CMTS labels the DSG Tunnel traffic. If no DSID has been
created for this tunnel then this object returns 0.
When MDF is disabled this object returns 0. Pre-3.0 DOCSIS
devices are not required to instantiate this object."
 ::= { dsgIfTunnelDsStatsEntry 3 }

```
--
-- Conformance definitions
--
```

dsgIfConformance OBJECT IDENTIFIER ::= { dsgIfMIB 4 }

dsgIfGroups OBJECT IDENTIFIER ::= { dsgIfConformance 1 }

dsgIfCompliances OBJECT IDENTIFIER ::= { dsgIfConformance 2 }

dsgIfBasicCompliance MODULE-COMPLIANCE
STATUS current
DESCRIPTION
"The compliance statement for DOCSIS Set-top Gateway
systems."

MODULE -- dsgIfMIB

```
-- conditionally mandatory groups
```

GROUP dsgIfClassifierGroup
DESCRIPTION
"Mandatory in DOCSIS Set-top Gateway systems."

GROUP dsgIfBaseGroup
DESCRIPTION
"Mandatory in DOCSIS Set-top Gateway systems."

GROUP dsgIfDCDGroup

DESCRIPTION

"Mandatory in DOCSIS Set-top Gateway systems."

::= { dsgIfCompliances 1 }

dsgIfClassifierGroup OBJECT-GROUP

```
OBJECTS {
    dsgIfClassPriority,
    dsgIfClassSrcIpAddrType,
    dsgIfClassSrcIpAddr,
    dsgIfClassSrcIpPrefixLength,
    dsgIfClassDestIpAddressType,
    dsgIfClassDestIpAddress,
    dsgIfClassDestPortStart,
    dsgIfClassDestPortEnd,
    dsgIfClassRowStatus,
    dsgIfClassIncludeInDCD
}
```

STATUS current

DESCRIPTION

"A collection of objects providing the classifier configuration."

::= { dsgIfGroups 1 }

dsgIfBaseGroup OBJECT-GROUP

```
OBJECTS {
    dsgIfTunnelGroupIndex,
    dsgIfTunnelClientIdListIndex,
    dsgIfTunnelMacAddress,
    dsgIfTunnelServiceClassName,
    dsgIfTunnelRowStatus,
    dsgIfTunnelGrpDsIfIndex,
    dsgIfTunnelGrpRulePriority,
    dsgIfTunnelGrpUcidList,
    dsgIfTunnelGrpVendorParamId,
    dsgIfTunnelGrpRowStatus,
    dsgIfDownTimerIndex,
    dsgIfDownVendorParamId,
    dsgIfDownChannelListIndex,
    dsgIfDownEnabledDCD
}
```

STATUS current

DESCRIPTION

"A collection of objects providing DSG Tunnel and Channel configuration."

::= { dsgIfGroups 2 }

dsgIfDCDGroup OBJECT-GROUP

```
OBJECTS {
    dsgIfClientIdType,
    dsgIfClientIdValue,
    dsgIfClientVendorParamId,
    dsgIfClientRowStatus,
    dsgIfVendorOUI,
    dsgIfVendorValue,
    dsgIfVendorRowStatus,
    dsgIfChannelDsFreq,
    dsgIfChannelRowStatus,
    dsgIfTimerTdsg1,
    dsgIfTimerTdsg2,
    dsgIfTimerTdsg3,
    dsgIfTimerTdsg4,
    dsgIfTimerRowStatus
}
```

STATUS current

DESCRIPTION

"A collection of objects providing Timers configuration."

::= { dsgIfGroups 3 }

END

Annex B

DOCSIS set-top gateway set-top device MIB definition

(This annex forms an integral part of this Recommendation)

```
DSG-IF-STD-MIB DEFINITIONS ::= BEGIN
IMPORTS
    MODULE-IDENTITY,
    OBJECT-TYPE,
    NOTIFICATION-TYPE,
    Integer32,
    Unsigned32,
    Counter32
        FROM SNMPv2-SMI
        -- RFC 2578

    OBJECT-GROUP,
    NOTIFICATION-GROUP,
    MODULE-COMPLIANCE
        FROM SNMPv2-CONF
        -- RFC 2580

    MacAddress
        FROM SNMPv2-TC
        -- RFC 2579

    InetAddressType,
    InetAddress,
    InetAddressPrefixLength,
    InetPortNumber
        FROM INET-ADDRESS-MIB
        -- RFC 3291

    IfPhysAddress
        FROM IF-MIB
        -- RFC 2863

    docsDevEvLevel,
    docsDevEvId,
    docsDevEvText
        FROM DOCS-CABLE-DEVICE-MIB
        -- RFC 4639

    docsIfCmCmtsAddress,
    docsIfDocsisBaseCapability,
    docsIfCmStatusDocsisOperMode,
    docsIfCmStatusModulationType
        FROM DOCS-IF-MIB
        -- RFC 4546 (OSSiv3.0 for DOCSIS 3.0)

    Dsid
        FROM DSG-IF-MIB

    clabProjDocsis
        FROM CLAB-DEF-MIB;

dsgIfStdMib MODULE-IDENTITY
    LAST-UPDATED "200806260000Z" -- June 26, 2008"
    ORGANIZATION "CableLabs DSG Working Group"
    CONTACT-INFO
        "
            Postal: Cable Television Laboratories, Inc.
                   858 Coal Creek Circle
                   Louisville, Colorado 80027
                   U.S.A.
            Phone : +1 303-661-9100
            Fax   : +1 303-661-9199
            E-mail: "
    DESCRIPTION
        "This MIB module provides the management objects of
        the DOCSIS Set-top Gateway (DSG) client controller
        CM component for DSG operations of Set-top devices."
    REVISION "200806260000Z" -- June 26, 2008
    DESCRIPTION
        "This revision is published as part of the CableLabs
        DOCSIS Set-top Gateway (DSG) Interface
        Specification CM-SP-DSG-I12."

    REVISION "200702230000Z" -- February 23, 2007
    DESCRIPTION
        "This revision is published as part of the CableLabs
        DOCSIS Set-top Gateway (DSG) Interface
        Specification CM-SP-DSG-I10."
```

```

REVISION      "200607280000Z" -- July 28, 2006
DESCRIPTION
    "This revision is published as part of the CableLabs
    DOCSIS Set-top Gateway (DSG) Interface
    Specification CM-SP-DSG-I08."

```

```
 ::= { clabProjDocsis 4 }
```

```

-----
--
-- DSG eCM MIB objects that represent the DSG Configuration parameters
-- Tunnels information and list of available downstream channels
-- carrying the Set-top box content.
--
-----

```

```

dsgIfStdNotifications      OBJECT IDENTIFIER ::= { dsgIfStdMib 0 }
dsgIfStdMibObjects         OBJECT IDENTIFIER ::= { dsgIfStdMib 1 }
dsgIfStdConfig             OBJECT IDENTIFIER ::= { dsgIfStdMibObjects 1 }
dsgIfStdTunnelFilter       OBJECT IDENTIFIER ::= { dsgIfStdMibObjects 2 }
dsgIfStdDsgChannelList     OBJECT IDENTIFIER ::= { dsgIfStdMibObjects 3 }

```

```

-----
-- DSG eCM Scalar objects
-----

```

```

dsgIfStdDsgMode OBJECT-TYPE
    SYNTAX      INTEGER {
        none (0),
        basic(1),--deprecated
        advanced(2)
    }
    MAX-ACCESS  read-only
    STATUS      current
    DESCRIPTION
        "The DSG Mode of operation of this device.
        The value "none" indicates that the eCM is
        not performing DSG operations."
    ::= { dsgIfStdConfig 1 }

```

```

dsgIfStdTdsg1 OBJECT-TYPE
    SYNTAX      Unsigned32
    UNITS       "seconds"
    MAX-ACCESS  read-only
    STATUS      current
    DESCRIPTION
        "The configured value for the Tdsg1 timer."
    DEFVAL { 2 }
    ::= { dsgIfStdConfig 2 }

```

```

dsgIfStdTdsg2 OBJECT-TYPE
    SYNTAX      Unsigned32
    UNITS       "seconds"
    MAX-ACCESS  read-only
    STATUS      current
    DESCRIPTION
        "The configured value for the Tdsg2 timer."
    DEFVAL { 600 }
    ::= { dsgIfStdConfig 3 }

```

```

dsgIfStdTdsg3 OBJECT-TYPE
    SYNTAX      Unsigned32
    UNITS       "seconds"
    MAX-ACCESS  read-only
    STATUS      current
    DESCRIPTION
        "The configured value for the Tdsg3 timer."
    DEFVAL { 300 }
    ::= { dsgIfStdConfig 4 }

```

```

dsgIfStdTdsg4 OBJECT-TYPE
    SYNTAX      Unsigned32
    UNITS       "seconds"
    MAX-ACCESS  read-only
    STATUS      current
    DESCRIPTION
        "The configured value for the Tdsg4 timer."
    DEFVAL { 1800 }
    ::= { dsgIfStdConfig 5 }

dsgIfStdTdsg1Timeouts OBJECT-TYPE
    SYNTAX      Counter32
    MAX-ACCESS  read-only
    STATUS      current
    DESCRIPTION
        "The number of times Tdsg1 expired in the DSG eCM since
        last reboot."
    ::= { dsgIfStdConfig 6 }

dsgIfStdTdsg2Timeouts OBJECT-TYPE
    SYNTAX      Counter32
    MAX-ACCESS  read-only
    STATUS      current
    DESCRIPTION
        "The number of times Tdsg2 expired in the DSG eCM since
        last reboot."
    ::= { dsgIfStdConfig 7 }

dsgIfStdTdsg3Timeouts OBJECT-TYPE
    SYNTAX      Counter32
    MAX-ACCESS  read-only
    STATUS      current
    DESCRIPTION
        "The number of times Tdsg3 expired in the DSG eCM since
        last reboot."
    ::= { dsgIfStdConfig 8 }

dsgIfStdTdsg4Timeouts OBJECT-TYPE
    SYNTAX      Counter32
    MAX-ACCESS  read-only
    STATUS      current
    DESCRIPTION
        "The number of times Tdsg4 expired in the DSG eCM since
        last reboot."
    ::= { dsgIfStdConfig 9 }

```

```

-----
-- Active Tunnel filters, one row per Tunnel classifier
-- (or tunnel for those that do not have classifiers)
-----

```

```

dsgIfStdTunnelFilterTable OBJECT-TYPE
    SYNTAX      SEQUENCE OF DsgIfStdTunnelFilterEntry
    MAX-ACCESS  not-accessible
    STATUS      current
    DESCRIPTION
        "A Table with the DSG tunnels the DSG eCM is filtering
        and forwarding to the DSG Clients."
    ::= { dsgIfStdTunnelFilter 1 }

```

```

dsgIfStdTunnelFilterEntry OBJECT-TYPE
    SYNTAX      DsgIfStdTunnelFilterEntry
    MAX-ACCESS  not-accessible
    STATUS      current
    DESCRIPTION
        "The DSG eCM will have one entry for each DSG Tunnel
        Filter. A DSG eCM in Advanced mode will have at least one
        such Filter for each DSG classifier, and at least one such
        Filter for each DSG Tunnel that lacks a DSG classifier
        (i.e., the DSG Tunnel MAC address is the only relevant
        filtering parameter). Entries

```

are created when the eCM is instructed to begin forwarding particular DSG Tunnels by the DSG Client Controller. Entries are deleted when the eCM is no longer instructed to forward those particular DSG Tunnels by the DSG Client Controller."

```
INDEX { dsgIfStdTunnelFilterIndex }
 ::= { dsgIfStdTunnelFilterTable 1 }
```

```
DsgIfStdTunnelFilterEntry ::= SEQUENCE {
  dsgIfStdTunnelFilterIndex      Unsigned32,
  dsgIfStdTunnelFilterApplicationId Integer32,
  dsgIfStdTunnelFilterMacAddress  MacAddress,
  dsgIfStdTunnelFilterIpAddressType InetAddressType,
  dsgIfStdTunnelFilterSrcIpAddr   InetAddress,
  dsgIfStdTunnelFilterSrcIpMask   InetAddress,
  dsgIfStdTunnelFilterDestIpAddr  InetAddress,
  dsgIfStdTunnelFilterDestPortStart InetPortNumber,
  dsgIfStdTunnelFilterDestPortEnd InetPortNumber,
  dsgIfStdTunnelFilterPkts        Counter32,
  dsgIfStdTunnelFilterOctets      Counter32,
  dsgIfStdTunnelFilterTimeActive  Counter32,
  dsgIfStdTunnelFilterTunnelId    Unsigned32,
  dsgIfStdTunnelFilterDsid        Dsid,
  dsgIfStdTunnelFilterClientIdType INTEGER,
  dsgIfStdTunnelFilterClientIdValue OCTET STRING
}
```

```
dsgIfStdTunnelFilterIndex OBJECT-TYPE
  SYNTAX      Unsigned32
  MAX-ACCESS  not-accessible
  STATUS      current
  DESCRIPTION
    "The unique index of entries in this table."
  ::= { dsgIfStdTunnelFilterEntry 1 }
```

```
dsgIfStdTunnelFilterApplicationId OBJECT-TYPE
  SYNTAX      Integer32 (-1 | 0.. 65535)
  MAX-ACCESS  read-only
  STATUS      deprecated
  DESCRIPTION
    "The ID of the application to which this DSG Tunnel is to be forwarded. This object returns -1 for: DSG Tunnels that do not have an associated Application ID or for DSG Tunnels for which the Application ID is unknown. In an OpenCable Host, this object returns '0' for a DSG Tunnel whose client resides on the Card. This object has been replaced by the dsgIfStdTunnelFilterClientIdType and dsgIfStdTunnelFilterClientIdValue objects."
  DEFVAL { -1 }
  ::= { dsgIfStdTunnelFilterEntry 2 }
```

```
dsgIfStdTunnelFilterMacAddress OBJECT-TYPE
  SYNTAX      MacAddress
  MAX-ACCESS  read-only
  STATUS      current
  DESCRIPTION
    "The destination MAC Address associated with this tunnel entry."
  ::= { dsgIfStdTunnelFilterEntry 3 }
```

```
dsgIfStdTunnelFilterIpAddressType OBJECT-TYPE
  SYNTAX      InetAddressType
  MAX-ACCESS  read-only
  STATUS      current
  DESCRIPTION
    "The type of InetAddress for dsgIfStdTunnelFilterSrcIpAddr, dsgIfStdTunnelFilterSrcIpMask and dsgIfStdTunnelFilterDestIpAddr."
  ::= { dsgIfStdTunnelFilterEntry 4 }
```

```
dsgIfStdTunnelFilterSrcIpAddr OBJECT-TYPE
```



```

SYNTAX      InetAddress
MAX-ACCESS  read-only
STATUS      current
DESCRIPTION
    "The source IP Address associated to this tunnel for the
    DSG eCM filtering and forwarding process. A value of zero
    indicates that source IP Address filtering does not apply.
    The type of this address is determined by the value of the
    dsgIfStdTunnelFilterIpAddressType object."
DEFVAL { '00000000'h }
::= { dsgIfStdTunnelFilterEntry 5 }

dsgIfStdTunnelFilterSrcIpMask OBJECT-TYPE
SYNTAX      InetAddress
MAX-ACCESS  read-only
STATUS      current
DESCRIPTION
    "The Source IP Mask to be used along with
    dsgIfStdTunnelFilterSrcIpAddr for filtering
    and forwarding of DSG Tunnel traffic.
    The type of this address is determined by the value of the
    dsgIfStdTunnelFilterIpAddressType object."
DEFVAL { 'FFFFFFFF'h }
::= { dsgIfStdTunnelFilterEntry 6 }

dsgIfStdTunnelFilterDestIpAddr OBJECT-TYPE
SYNTAX      InetAddress
MAX-ACCESS  read-only
STATUS      current
DESCRIPTION
    "The destination IP Address associated to this tunnel for
    the DSG eCM filtering and forwarding process. A value of
    zero indicates that destination IP Address filtering does
    not apply. The type of this address is determined by the
    value of the dsgIfStdTunnelFilterIpAddressType object."
DEFVAL { '00000000'h }
::= { dsgIfStdTunnelFilterEntry 7 }

dsgIfStdTunnelFilterDestPortStart OBJECT-TYPE
SYNTAX      InetPortNumber
MAX-ACCESS  read-only
STATUS      current
DESCRIPTION
    "The lower UDP port value to be matched for this tunnel."
DEFVAL { 0 }
::= { dsgIfStdTunnelFilterEntry 8 }

dsgIfStdTunnelFilterDestPortEnd OBJECT-TYPE
SYNTAX      InetPortNumber
MAX-ACCESS  read-only
STATUS      current
DESCRIPTION
    "The upper UDP port value to be matched for this tunnel."
DEFVAL { 65535 }
::= { dsgIfStdTunnelFilterEntry 9 }

dsgIfStdTunnelFilterPkts OBJECT-TYPE
SYNTAX      Counter32
UNITS       "packets"
MAX-ACCESS  read-only
STATUS      current
DESCRIPTION
    "The total number of Packets being classified and filtered
    for this tunnel entry since creation of the entry."
::= { dsgIfStdTunnelFilterEntry 10 }

dsgIfStdTunnelFilterOctets OBJECT-TYPE
SYNTAX      Counter32
UNITS       "octets"
MAX-ACCESS  read-only
STATUS      current

```

DESCRIPTION

"The total number of octets being classified and filtered for this tunnel entry since creation of the entry."

::= { dsgIfStdTunnelFilterEntry 11 }

dsgIfStdTunnelFilterTimeActive OBJECT-TYPE

SYNTAX Counter32

UNITS "seconds"

MAX-ACCESS read-only

STATUS current

DESCRIPTION

"The total number of seconds that this tunnel entry has been instantiated."

::= { dsgIfStdTunnelFilterEntry 12 }

dsgIfStdTunnelFilterTunnelId OBJECT-TYPE

SYNTAX Unsigned32 (0 | 1..255)

MAX-ACCESS read-only

STATUS current

DESCRIPTION

"In DSG Advanced Mode, this is the tunnel identifier passed to the DSG eCM by the DSG-Client Controller for this Tunnel Filter entry. This value may correspond to the DSG Rule ID from the DCD message. "

DEFVAL { 0 }

::= { dsgIfStdTunnelFilterEntry 13 }

dsgIfStdTunnelFilterDsid OBJECT-TYPE

SYNTAX Dsid

MAX-ACCESS read-only

STATUS current

DESCRIPTION

"When operating with Multicast DSID Forwarding (MDF) enabled, this object contains the DSID value obtained from the DA-to-DSID TLV in the MDD. If no DSID has been advertised for this tunnel MAC address then this object returns 0. When MDF is disabled, this object returns 0. Pre-3.0 DOCSIS devices are not required to instantiate this object."

::= { dsgIfStdTunnelFilterEntry 14 }

dsgIfStdTunnelFilterClientIdType OBJECT-TYPE

SYNTAX INTEGER {
cableCard(0),
broadcast(1),
macAddress(2),
caSystemId(3),
applicationId(4)
}

MAX-ACCESS read-only

STATUS current

DESCRIPTION

"The Client Identification type. The value of cableCard(0) describes a filter requested by the CableCARD on an OpenCable Host. A DSG client id of type broadcast(1) describes a filter for an industry standard flow identified by a DSG Broadcast ID. A DSG client id of type macAddress(2) describes a filter for a flow identified by a well known MAC Address. A DSG client id of type caSystemId(3) describes a filter for a flow identified by a CA_system_ID. A DSG client id of type applicationId(4) describes a flow identified by an application ID."

::= { dsgIfStdTunnelFilterEntry 15 }

dsgIfStdTunnelFilterClientIdValue OBJECT-TYPE

SYNTAX OCTET STRING (SIZE(6))

MAX-ACCESS read-only

STATUS current

DESCRIPTION

"The Client Identification Value. The content depends on the value of the dsgIfStdTunnelFilterClientIdType. For dsgIfStdTunnelFilterClientIdType of type cableCard(0), this object will return the empty (i.e., zero length) string."

For `dsgIfStdTunnelFilterClientIdType` of a type `broadcast(1)`, this object will have a 16-bit value whether or not it is a length 0 or length 2 broadcast ID. If the value is 0, then the encoded TLV in the DCD would be the original, zero length, broadcast ID. If the value is specified in Table 5-2, then the TLV in the DCD would be a length 2 broadcast ID followed by the value.

For `dsgIfStdTunnelFilterClientIdType` of a type `macAddress(2)`, this object is a well known MAC address.

For `dsgIfStdTunnelFilterClientIdType` of a type `caSystemId(3)`, this object is a CA System ID.

For `dsgIfStdTunnelFilterClientIdType` of a type `applicationId(4)`, this object is an application ID.

Client IDs representing types `broadcast(1)`, `caSystemId(3)` or `applicationId(4)` are encoded in DCD messages as Unsigned integers and configured in this object as 6 octet string with the 2 LSB for the client ID value, e.g., an `applicationId 2048 (0x0800)` is encoded as `'000000000800'h.`"

REFERENCE

"DOCSIS Set-top Gateway (DSG) Interface"
`::= { dsgIfStdTunnelFilterEntry 16 }`

-- DSG Channel List Table, one row per DSG Channel Frequency provided
-- in the DCD message.

`dsgIfStdDsgChannelListTable` OBJECT-TYPE

SYNTAX SEQUENCE OF `DsgIfStdDsgChannelListEntry`
MAX-ACCESS not-accessible
STATUS current
DESCRIPTION

"This table contains the list of DSG channels provided to the DSG eCM for use in scanning."

`::= { dsgIfStdDsgChannelList 1 }`

`dsgIfStdDsgChannelListEntry` OBJECT-TYPE

SYNTAX `DsgIfStdDsgChannelListEntry`
MAX-ACCESS not-accessible
STATUS current
DESCRIPTION

"The conceptual row for this table. The DSG eCM creates an entry per each downstream channel provided in the DCD message. An entry is deleted when removed from the DCD message."

INDEX { `dsgIfStdDsgChannelListIndex` }
`::= { dsgIfStdDsgChannelListTable 1 }`

`DsgIfStdDsgChannelListEntry` ::= SEQUENCE {
`dsgIfStdDsgChannelListIndex` Unsigned32,
`dsgIfStdDsgChannelListFrequency` Unsigned32
}

`dsgIfStdDsgChannelListIndex` OBJECT-TYPE

SYNTAX Unsigned32
MAX-ACCESS not-accessible
STATUS current
DESCRIPTION

"The unique identifier for entries in this table"

`::= { dsgIfStdDsgChannelListEntry 1 }`

`dsgIfStdDsgChannelListFrequency` OBJECT-TYPE

SYNTAX Unsigned32
UNITS "Hertz"
MAX-ACCESS read-only
STATUS current
DESCRIPTION

"The downstream channel center frequency of this entry."

`::= { dsgIfStdDsgChannelListEntry 2 }`

```

--
-- Notification Definitions
--

dsgIfStdUpstreamEnabledNotify NOTIFICATION-TYPE
  OBJECTS {
    docsDevEvLevel,
    docsDevEvId,
    docsDevEvText,
    ifPhysAddress,
    docsIfCmCmtsAddress,
    docsIfDocsisBaseCapability,
    docsIfCmStatusDocsisOperMode,
    docsIfCmStatusModulationType
  }
  STATUS      current
  DESCRIPTION
    "Indicates the eCM is being instructed to have the upstream
    transmitter enabled. This notification is sent after CM
    registration.
    Note that the objects docsIfDocsisBaseCapability,
    docsIfCmStatusDocsisOperMode and
    docsIfCmStatusModulationType may not be supported in some
    situations (e.g., for 1.1 CMs in 1.0 mode these objects are
    optional, for 3.0 CMs docsIfCmStatusDocsisOperMode and
    docsIfCmStatusModulationType are deprecated). If that is the case, the above
varbind objects
    are indicated as noSuchName or noSuchObject for
    SNMPv1 and SNMPv2 notification PDUs respectively."
    ::= { dsgIfStdNotifications 1 }

dsgIfStdUpstreamDisabledNotify NOTIFICATION-TYPE
  OBJECTS {
    docsDevEvLevel,
    docsDevEvId,
    docsDevEvText,
    ifPhysAddress,
    docsIfCmCmtsAddress,
    docsIfDocsisBaseCapability,
    docsIfCmStatusDocsisOperMode,
    docsIfCmStatusModulationType
  }
  STATUS      current
  DESCRIPTION
    "Indicates the CM is being instructed to have the upstream
    transmitter disabled. This notification is only sent when
    the CM is registered and prior to disable the upstream
    transmitter. Note that the objects
    docsIfDocsisBaseCapability, docsIfCmStatusDocsisOperMode
    and docsIfCmStatusModulationType may not be supported in
    some situations (e.g., for 1.1 CMs in 1.0 mode these objects
    are optional, for 3.0 CMs docsIfCmStatusDocsisOperMode and
    docsIfCmStatusModulationType are deprecated).
    If that is the case the above varbind
    objects are indicated as noSuchName or noSuchObject for
    SNMPv1 and SNMPv2 notification PDUs respectively."
    ::= { dsgIfStdNotifications 2 }

dsgIfStdTdsg2TimeoutNotify NOTIFICATION-TYPE
  OBJECTS {
    docsDevEvLevel,
    docsDevEvId,
    docsDevEvText,
    ifPhysAddress,
    docsIfCmCmtsAddress,
    docsIfDocsisBaseCapability,
    docsIfCmStatusDocsisOperMode,
    docsIfCmStatusModulationType
  }
  STATUS      current
  DESCRIPTION

```

```

    "Notifies that the eCM has a timeout Tdsg2.
    Note that the objects docsIfDocsisBaseCapability,
    docsIfCmStatusDocsisOperMode and
    docsIfCmStatusModulationType may not be supported in some
    situations (e.g., for 1.1 CMs in 1.0 mode these objects are
    optional, for 3.0 CMs docsIfCmStatusDocsisOperMode and
    docsIfCmStatusModulationType are deprecated).
    If that is the case the above varbind objects
    are indicated as noSuchName or noSuchObject for
    SNMPv1 and SNMPv2 notification PDUs respectively."
 ::= { dsgIfStdNotifications 3 }

--
-- Conformance definitions
--
dsgIfStdConformance OBJECT IDENTIFIER ::= { dsgIfStdMib 2 }
dsgIfStdCompliances OBJECT IDENTIFIER ::= { dsgIfStdConformance 1 }
dsgIfStdGroups      OBJECT IDENTIFIER ::= { dsgIfStdConformance 2 }

dsgIfStdBasicCompliance MODULE-COMPLIANCE
    STATUS          current
    DESCRIPTION
        "The compliance statement for DOCSIS Set-top Gateway eCMs."

MODULE -- dsgIfStdMIB

    -- mandatory groups

MANDATORY-GROUPS {
    dsgIfStdConfigGroup,
    dsgIfStdNotifyGroup
}
 ::= { dsgIfStdCompliances 1 }

dsgIfStdConfigGroup OBJECT-GROUP
    OBJECTS {
        dsgIfStdDsgMode,
        dsgIfStdTdsg1,
        dsgIfStdTdsg2,
        dsgIfStdTdsg3,
        dsgIfStdTdsg4,
        dsgIfStdTdsg1Timeouts,
        dsgIfStdTdsg2Timeouts,
        dsgIfStdTdsg3Timeouts,
        dsgIfStdTdsg4Timeouts,
        dsgIfStdTunnelFilterMacAddress,
        dsgIfStdTunnelFilterIpAddressType,
        dsgIfStdTunnelFilterSrcIpAddr,
        dsgIfStdTunnelFilterSrcIpMask,
        dsgIfStdTunnelFilterDestIpAddr,
        dsgIfStdTunnelFilterDestPortStart,
        dsgIfStdTunnelFilterDestPortEnd,
        dsgIfStdTunnelFilterPkts,
        dsgIfStdTunnelFilterOctets,
        dsgIfStdTunnelFilterTimeActive,
        dsgIfStdTunnelFilterTunnelId,
        dsgIfStdTunnelFilterDsid,
        dsgIfStdTunnelFilterClientIdType,
        dsgIfStdTunnelFilterClientIdValue,
        dsgIfStdDsgChannelListFrequency
    }
    STATUS          current
    DESCRIPTION
        "A collection of configuration elements provided in DCD
        messages and DSG operations."
 ::= { dsgIfStdGroups 1 }

```

```
dsgIfStdNotifyGroup NOTIFICATION-GROUP
  NOTIFICATIONS { dsgIfStdUpstreamEnabledNotify,
                  dsgIfStdUpstreamDisabledNotify,
                  dsgIfStdTdsg2TimeoutNotify
                }
  STATUS          current
  DESCRIPTION
    "The collection of DSG notifications that the eCM reports
     as part of the Set-top device"
  ::= { dsgIfStdGroups 2 }
END
```

Annex C

Format and content for DSG eCM event, SYSLOG, and SNMP trap extensions

(This annex forms an integral part of this Recommendation)

To facilitate device provisioning and fault management, the DSG eCM MUST support the DOCSIS Event extensions defined in this annex.

This annex is an extension of Annex D Format and Content for Event, SYSLOG, and SNMP Trap (normative) of [ANSI/SCTE 79-2]. The eCM MUST conform to the requirements of [ANSI/SCTE 79-2] Section 7.4, Fault management, pertaining to these events, unless otherwise explicitly indicated in this annex.

C.1 DSG eCM event extensions description

"CM event" is used in this clause to reference Annex D of [ANSI/SCTE 79-2].

The DSG eCM Events are based on the DSG notifications described in 5.4.2.1 and 5.4.2.2, which can be categorized in the following types:

- DSG eCM to DSG Client Controller (CC) Events: (DSG eCM → CC) The eCM communicates to the DSG Client Controller information such as the eCM operational mode and conditions on the RFI side of the CMTS.
- DSG Client Controller to DSG eCM Events: (DSG CC → eCM) The DSG Client Controller uses DSG channel/DCD information to notify the eCM of operational requirements or actions.
- DSG eCM Internal Events: The DSG eCM State Transition Diagrams indicate various events that affect operation of the eCM.

Other DSG eCM events are specific to DSG operations. One example is the event generated when operators trigger DOCSIS Secure Software Download (SSDI) for a DSG eCM when the eCM does not support this DOCSIS feature (see C.1.2).

NOTE – Herein, the abbreviation CC is used to refer to the DSG Client Controller.

Table C.1 indicates the relationship between the DSG eCM events and the DSG Client control/eCM notifications. The Event definitions are in clause C.2.

Table C.1 – DSG notifications and eCM events relations

Notification direction	Notification	DSG eCM event error code set
DSG CC → eCM	Start DSG Advanced Mode	G01.1
DSG CC → eCM	Disable upstream transmitter	G01.2
DSG CC → eCM	Enable upstream transmitter	G01.3
DSG CC → eCM	Not Valid. Hunt for new DSG Channel	G01.4
DSG eCM internal	Tdsg1 Timeout	G02.1
DSG eCM internal	Tdsg2 Timeout	G02.2
DSG eCM internal	Tdsg3 Timeout	G02.3
DSG eCM internal	Tdsg4 Timeout	G02.4
DSG eCM → CC	Downstream Scan Completed	G03.0
DSG eCM internal	Valid DSG Channel	G03.1
DSG eCM internal	DCD Present	G03.2
DSG eCM → CC	2-Way OK, UCID	G04.0
DSG eCM → CC	Entering One-way Mode	G04.1
DSG eCM → CC	Cannot forward 2 Way traffic, NACO <val>, Max CPE <val>	G04.2

C.1.1 DSG eCM event processes

All but one of the DOCSIS DSG event extensions are associated with the processes discussed in the following subclauses.

C.1.1.1 DSG eCM event process "dsgOper"

The DSG Event extensions herein designated as "dsgOper" cover events generated during either initialization or operation. These event processes are divided into two sub-processes: DSG OPERATION and DSG TIMEOUT. The Error Code Set used for these events are G01 and G02.

C.1.1.2 DOCSIS event process "dsgInit"

In DOCSIS the event process "Init" refers to the CM initialization and registration processes. The DSG Event extensions associated with the "dsgInit" process are divided into two DOCSIS sub-processes, DOWNSTREAM ACQUISITION, OBTAIN UPSTREAM PARAMETERS and REGISTRATION.

The DSG extensions for DOWNSTREAM ACQUISITION use Error Code Set G03, while the DSG extensions for OBTAIN UPSTREAM PARAMETERS and REGISTRATION use Error Code Set G04.

Note that DOCSIS OSSI specs need to be aware of the usage of Error Code Set G when extending DOCSIS Event Error Code Sets.

C.1.2 eCM event processes

Events in this category may reuse DOCSIS standard Events Process and sub-process and are assigned to Error Code Set G05.

C.2 DSG DOCSIS events extensions

Table C.2 – DSG DOCSIS events extensions

Process	Sub-process	CM priority	Event message	Message notes and details	Error code set	Event ID	Trap name
eCM STB operation							
dsgOper	DSG operation	Informational	Start DSG Advanced Mode		G01.1	71000101	
dsgOper	DSG operation	Warning	Disable upstream transmitter	send event before disabling upstream	G01.2	71000102	DsgIfStdUpstreamDisabledNotify
dsgOper	DSG operation	Warning	Enable upstream transmitter	send event upon successful re-registration	G01.3	71000103	dsgIfStdUpstreamEnabledNotify
dsgOper	DSG operation	Warning	Not valid, Hunt for new DSG channel		G01.4	71000104	
dsgOper	DSG timeout	Warning	Tdsg1 Timeout		G02.1	71000201	
dsgOper	DSG timeout	Warning	Tdsg2 Timeout		G02.2	71000202	dsgIfStdTdsg2TimeoutNotify
dsgOper	DSG timeout	Informational	Tdsg3 Timeout		G02.3	71000203	
dsgOper	DSG timeout	Critical	Tdsg4 Timeout		G02.4	71000204	
eCM downstream acquisition							
dsgInit	Downstream acquisition	Warning	Downstream Scan Completed		G03.0	71000300	
dsgInit	Downstream acquisition	Informational	Valid DSG Channel	Only logged when in DSG Channel Validation State	G03.1	71000301	
dsgInit	Downstream acquisition	Informational	DCD Present, DS	Only logged when in DSG Channel Validation State	G03.2	71000302	

Table C.2 – DSG DOCSIS events extensions

Process	Sub-process	CM priority	Event message	Message notes and details	Error code set	Event ID	Trap name
eCM upstream parameters							
dsgInit	Obtain upstream parameters	Informational	2-Way OK, UCID <P1>		G04.0	71000400	
			NOTE – P1 = UCID, upstream channel ID				
dsgInit	Obtain upstream parameters	Critical	Entering One-way Mode		G04.1	71000401	
dsgInit	REGISTRATION	Warning	Cannot forward 2-Way traffic, NACO <P1>, Max CPE <P2>	P1 = NACO value, P2 = Max CPE value from configuration file	G04.2	71000402	
Deprecated Events (See Annex C of [eDOCSIS] for new Events)							
SW Upgrade	SW upgrade general failure	Notice	DOCSIS SSD not supported		G05.1	71000500	

Annex D

Delivery of MPEG-2 sections in the broadcast tunnel

(This annex forms an integral part of this Recommendation)

The Broadcast Tunnel is intended to carry data for consumption by all devices regardless of manufacturer and CA vendor. To achieve this, a standardized encapsulation must be used on all Broadcast Tunnels where MPEG-2 sections are delivered. This annex specifies an encapsulation for the carriage of MPEG-2 sections over all Broadcast Tunnels.

D.1 MPEG-2 section encapsulation

If MPEG-2 sections (e.g., [ITU-T J.94]) are sent on the DSG Broadcast Tunnel, then these sections MUST be encapsulated by the DSG Server in UDP [RFC 768] over IPv4 [RFC 791] utilizing a new header (BT Header) embedded within the UDP datagram. The Broadcast Tunnel (BT) Header is defined in Table D.1. Sections MUST be packed by the DSG Server as one section per UDP datagram. A section packed by the DSG Server MUST NOT exceed a size of 4096 bytes.

Figure D.1 depicts the MPEG-2 section encapsulated within a UDP over IPv4 packet.

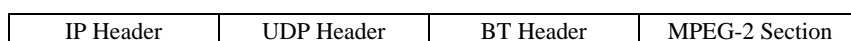

Figure D.1 – Section encapsulation

Table D.1 – BT header

Bt_header () {	Bits	Bit number/ Description
header_start	8	uimsbf
version	3	uimsbf
last_segment	1	bslbf
segment_number	4	uimsbf
id_number	16	uimsbf
}		

Where:

- header_start = this shall have a fixed value of 0xff. This identifies the presence of the BT Header allowing systems based on UDP section encapsulation to be migrated to the encapsulation defined here. ISO 13818-1 defines 0xff to be a forbidden table id.
- version = defines the version number of the BT Header. This shall be 0x01.
- last_segment = defines whether this segment is the last segment of a segmented section. When set the segment is the last one for the given id_number.
- segment_number = defines the number of the current segment for the given id_number. A value of 0 indicates this is the first segment. If the segment_number = 0 and the last_segment is set then the section has not been segmented and the UDP datagram contains a complete section.

- `id_number` = number assigned to each section delivered thus allowing the device to correlate segments that are applicable to a particular section in the event that segmentation of the section was required. The `id_number` is defined within the context of the UDP stream. Therefore, all segments belonging to the same section are identified by having the same source IP address, source port number, destination IP address, destination port and `id_number`.

If the resultant IP datagram will exceed the network MTU, the DSG Server **MUST** perform segmentation of the MPEG-2 table at the UDP layer and populate the segmentation values of the BT header accordingly. When segmenting the table, all segments except the last **MUST** be of equal size and **SHOULD** be the maximum size possible without exceeding the MTU. Reassembly of segments is the responsibility of the DSG Client. The DSG Server **SHOULD** minimize segmentation where possible.

NOTE – Many tables based on the MPEG-2 section syntax can be split across multiples sections. Therefore, by restricting the section size to below the MTU and creating multiple sections to carry the data, it is possible to minimize segmentation.

D.2 Layer 4 multiplexing

Typically MPEG-2 sections are encapsulated within MPEG-2 transport packets. These packets contain a PID which is used for demultiplexing the transport stream. When the MPEG-2 sections are encapsulated as described above, the association between Table Id (contained in the section) and the PID is lost as no PID information is carried within the datagram. If such an association is required, Table Ids can be assigned specific multicast IP addresses and/or specific UDP ports within the Broadcast Tunnel where the addresses/ports conceptually represent PIDs. It is not within the scope of DSG to define how the DSG Client Controller is provisioned with this information.

For example, if the DSG Client Controller is provisioned accordingly and the DSG Client requests SI/EAS tables from the DSG Client Controller using PID and Table Id to identify the J.94 and EAS Alert Message traffic flows, the DSG Client Controller is required to map between the PID and Table Id and the multicast address/port on which the requested flow is located and pass the applicable flow(s) to the DSG Client.

Annex E

Delivery of MPEG-2 Sections in Application Tunnels

(This annex forms an integral part of this Recommendation)

[OC-SP-OCAP1.0] and OpenCable Common Download define an encapsulation for the carriage of MPEG-2 sections over certain DSG application tunnels. This header is required by the implementation to support the carriage of DSMCC object and data carousels (as defined in [OC-SP-OCAP1.0]) over DSG application tunnels.

If MPEG-2 sections are sent on a DSG application tunnel as part of a carousel, then the DSG Server MUST encapsulate and send the sections within UDP over IPv4 utilizing the DSG_Carousel_Header. The consumer of these sections will expect this header to be present at the beginning of every UDP datagram within DSG application tunnels that carry DSMCC object or data carousels. This header should be immediately followed by a complete MPEG section. Each UDP packet should contain the DSG_Carousel_Header and a complete MPEG section. Since IP datagram fragmentation is not allowed, this necessarily limits the MPEG-2 section length to less than the DOCSIS MTU.

Table E.1 – DSG Carousel Header

Syntax	Bits	Type	Value	Comment
DSG_Carousel_Header() {				
version	2	bslbf	0x1	The version number of the DSG_Carousel_Header. This shall be 0x1.
reserved	1	bslbf	0x1	
MPEG_transport_PID	13	uimsbf	+	This field carries the MPEG transport stream PID information for the MPEG section. DSG tunnels that use this header do not contain full MPEG TS encapsulation; however, the PID information is carried on the DSG stream. This allows for a DSG stream that carries MPEG sections to be filtered by MPEG PID value.
}				

Appendix I

Parsing the MIB in the DSG agent

(This appendix does not form an integral part of this Recommendation)

The DOCSIS Set-Top Gateway MIB (DSG-IF-MIB) is illustrated in Figure I.1. The figure illustrates the relationships between the several tables in the MIB.

This appendix details the manner in which the MIB data can be parsed in the Agent to form the DCD message on each downstream. The format and data contained within the MIB are specified within the MIB documentation. If this informative appendix differs from the normative MIB documentation, the MIB documentation predominates.

The figure shows nine tables:

- dsgIfClassifierTable;
- dsgIfTunnelTable;
- dsgIfTunnelGrpToChannelTable;
- dsgIfDownstreamTable;
- dsgIfClientIdTable;
- dsgIfVendorParamTable;
- dsgIfChannelListTable;
- dsgIfTimerTable;
- docsQoSServiceClassTable (actually in the DOCS-QOS-MIB).

Numbers in parentheses (51) indicate a TLV type as shown in Table 5-1, "Summary of DCD TLV Parameters". This notation is used throughout the rest of this appendix [DOCSIS-RFI] as an aid to tracking text relevant to specific TLVs. The TLV types are documented in Annex C of the [DOCSIS-RFI] Recommendation.

Here is the mapping between the TLVs shown in Table I.1 and the MIB objects.

Table I.1 – Mapping table TLVs and MIB objects

TLV type	Table 5-1 name	MIB object/(or other method)
23	Downstream Packet Classification Encoding	
23.2	Classifier Identifier	dsgIfClassId
23.5	Classifier Priority	dsgIfClassPriority
23.9	IP Packet Classification Encodings	
23.9.3	Source IP Address	dsgIfClassSrcIpAddr
23.9.4	Source IP Mask	computed from dsgIfClassSrcIpPrefixLength
23.9.5	Destination IP Address	dsgIfClassDestIpAddress
23.9.9	Dest TCP/UDP Port Start	dsgIfClassDestPortStart
23.9.10	Dest TCP/UDP Port End	dsgIfClassDestPortEnd
50	DSG Rule	
50.1	DSG Rule Identifier	(computed during parsing)

Table I.1 – Mapping table TLVs and MIB objects

TLV type	Table 5-1 name	MIB object/(or other method)
50.2	DSG Rule Priority	dsgIfTunnelGrpRulePriority
50.3	DSG UCID List	dsgIfTunnelGrpUcidList
50.4	DSG Client ID	
50.4.1	DSG Broadcast	dsgIfClientIdType
50.4.2	DSG Well-Known Mac Addr	dsgIfClientIdType/Value
50.4.3	CA System ID	dsgIfClientIdType/Value
50.4.4	Application ID	dsgIfClientIdType/Value
50.5	DSG Tunnel Address	dsgIfTunnelMacAddress
50.6	DSG Classifier Identifier	dsgIfClassId
50.43	DSG Rule Vendor-Specific Params	dsgIfVendorOUI/Value
51	DSG Configuration	
51.1	DSG Channel List	dsgIfChannelDsFreq
51.2	DSG Initialization Timeout (Tdsg1)	dsgIfTimerTdsg1
51.3	DSG Operational Timeout (Tdsg2)	dsgIfTimerTdsg2
51.4	DSG Two-Way Retry Timer (Tdsg3)	dsgIfTimerTdsg3
51.5	DSG One-Way Retry Timer (Tdsg4)	dsgIfTimerTdsg4
51.43	DSG Config-Specific Parameters	dsgIfVendorOUI/Value

The DCD message that is unique for an individual downstream is constructed using one row from the dsgIfDownstreamTable chosen with index {IfIndex}. The remainder of this appendix describes how one individual DCD message is parsed from the MIB. This process can be repeated for each DCD message.

The following procedure outlines how to assemble a DCD message from the MIB. The procedure moves through the MIB from the starting point (let us call it the 'root') to a single 'leaf' on the tree. At each juncture, TLVs are added to the DCD message. Along that journey from the root to the leaf, the procedure calls for iteration to select 'branches' not taken. Bear in mind then, that the procedure below must be used iteratively (in places) to construct all of the Rules and Classifiers that must go into the final DCD message. Where iteration is called for, the notation (*iteration*) is used.

The goal is to assemble a DCD message populated with TLVs listed in Table. Start assembling a DCD message using index {IfIndex} and finding one row in the dsgIfDownstreamTable.

It is worth noting here that the dsgIfDownstreamTable contains an entry for dsgIfDownEnableDCD. This value is used via SNMP to control the Agent as specified in the DSG specification. It does not have a direct counterpart entry in the DCD message. Because a DCD containing a tunnel cannot be disabled, this object is used only to enable/disable DCD messages on channels that are not carrying DSG Tunnels. Such channels might then carry DSG Configuration TLVs, and in particular, the DSG Channel List.

I.1 DSG Configuration TLVs (51)

The `dsgIfDownstreamTable` contains the information necessary to construct the DSG Configuration TLV. Add a DSG Configuration TLV (51) to the DCD message if any of the following TLVs are added to the DCD message.

- *DSG Channel List (51.1)*
 - The `dsgIfDownstreamTable` has the index `{dsgIfDownChannelListIndex}`, which (when it exists) points to the proper rows of downstream channels in the `dsgIfChannelListTable`. Use the second index `{dsgIfChannelIndex}` to walk through those rows. Add each channel frequency to the DCD via an instance of TLV 51.1.
 - When zero, the `dsgIfDownChannelListIndex` indicates that no TLV 51.1 should be added to the DCD.
- *DSG Timeouts*
 - The `dsgIfDownstreamTable` has the index `{dsgIfDownTimerIndex}`, which (when non-zero) points to the proper set of timer values in the `dsgIfTimerTable`. Add all four timer values to the DCD (even if some take default values):
 - DSG Initialization Timeout (Tdsg1) (51.2);
 - DSG Operational Timeout (Tdsg2) (51.3);
 - DSG Two-Way Retry Timer (Tdsg3) (51.4);
 - DSG One-Way Retry Timer (Tdsg4) (51.5).
 - When zero, the `dsgIfDownTimerIndex` indicates that no DSG Timeout TLVs (51.2, 51.3, 51.4, 51.5) should be added to the DCD.
- *DSG Config Specific Parameters (51.43)*
 - The `dsgIfDownstreamTable` has the index `{dsgIfDownVendorParamId}`, which points to the proper rows of Vendor-Specific Parameter values in the `dsgIfVendorParamTable`. Use the second index `{dsgIfVendorIndex}` to walk through the Vendor-Specific Parameters in those rows. The `dsgIfVendorValue` object is a string of octets inserted immediately following the TLV 43.8 (Vendor ID). The VSP TLV structure is: 43, L, 8, 3, `dsgIfVendorOUI`, `dsgIfVendorValue`. The length byte "L" equals the length of `dsgIfVendorValue` plus 5 bytes. Add a TLV 51.43 to the DCD for each corresponding row.

I.2 DSG Rule (50)

The DCD can contain zero or more DSG Rules, each Rule corresponding to a DSG Tunnel.

Tunnel Group membership

- The first step in populating the DCD message with DSG Rules is to determine which Tunnel Groups the downstream channel belongs to. The concept of Tunnel Groups is introduced only in the MIB in order to simplify the configuration. Tunnel Groups are not visible in the DCD message, nor are they explicitly linked to other concepts in this Recommendation. A downstream channel may belong to zero or more Tunnel Groups. The `dsgIfTunnelGrpToChannelTable` encodes the Tunnel Group membership for each downstream channel.
- For each row in `dsgIfTunnelGrpToChannelTable` where the entry for `dsgIfTunnelGrpDsIfIndex` matches the downstream index `{IfIndex}`, the corresponding `dsgIfTunnelGrpIndex` indicates a Tunnel Group to which this downstream channel belongs. Additionally, each row contains the DSG Rule Priority (`dsgIfTunnelGrpRulePriority`), DSG UCID List (`dsgIfTunnelGrpUcidList`), and potentially some instances of the DSG Rule

Vendor-Specific Parameters (via `dsgIfTunnelGrpVendorParamId`) that apply to ALL DSG Rules for this Tunnel Group.

Once the Tunnel Group membership is known, the DSG Agent can begin building DSG Rules. Iterating through each Tunnel Group to which the downstream channel belongs (*iteration*), the DSG Agent will add a TLV 50 for each associated DSG Tunnel (i.e., each row in the `dsgIfTunnelTable` with the appropriate `dsgIfTunnelGroupIndex`).

To start a DSG Rule, add a DSG Rule TLV (50) to the DCD message. The following paragraphs within this DSG Rule subclause only cover the parsing and assembly of a single DSG Rule within the DCD message. For each DSG Rule created in the DCD, these procedures must be repeated (*iteration*) for each DSG Tunnel in the Tunnel Group, and for each Tunnel Group to which the downstream channel belongs.

- DSG Rule Identifier (50.1) – The Rule Identifiers are unique per DCD message. The Agent assigns the DSG Rule Identifier.
- DSG Rule Priority (50.2) – Using the value of DSG Rule Priority from the `dsgIfTunnelGrpToChannelTable`, add it to the DSG Rule.
- DSG UCID List (50.3) – Using the value of `dsgIfTunnelGrpUcidList` from the `dsgIfTunnelGrpToChannelTable`, add it to the DSG Rule.
- DSG Client ID (50.4) – The row in the `dsgIfTunnelTable` contains `dsgIfTunnelClientIdListIndex` which is used to index into `dsgIfClientIdTable` to fetch DSG Client IDs for the DSG Rule. Using index `{dsgIfClientIdIndex}`, add every valid DSG Client ID in the row of `dsgClientIdTable` to the DSG Rule. These Client IDs may be any or all of the following and should all be added to the DSG Rule.
 - DSG Broadcast (50.4.1)
 - DSG Well-Known MAC Address (50.4.2)
 - CA System ID (50.4.3)
 - Application ID (50.4.4)
- Additionally, the Client ID list may contain index `{dsgIfClientVendorParamId}` which indexes to a (set of) row(s) in the `dsgIfVendorParamTable` that will be used to populate the DSG Rule Vendor-Specific Parameters TLV (50.43) below.
- DSG Tunnel Address (50.5) – The row in `dsgIfTunnelTable` contains `dsgIfTunnelMacAddress`. Add it to the DSG Rule.
- DSG Classifier Identifier (50.6) – For all rows in the `dsgIfClassifierTable` that are indexed by this `dsgIfTunnelIndex`, and that also have `dsgIfClassIncludeInDCD` set to true, the corresponding index `{dsgIfClassId}` is added to the DSG Rule via TLV 50.6.
- DSG Rule Vendor-Specific Parameters (50.43) – The DSG Rule could have zero or more lists of vendor-specific parameters (each with one or more VSPs) associated with it. The lists are indicated via a Vendor Param ID index. There are multiple sources for this ID. The first source could be the value of index `{dsgIfTunnelGrpVendorParamId}` from the `dsgIfTunnelGrpToChannelTable`. The second source, as mentioned above, could be the value of index `{dsgIfClientVendorParamId}` in any row in the `dsgIfClientTable` that is associated with this DSG Rule. This set of Vendor Param IDs is then used as a set of indexes into the `dsgIfVendorParamTable`. Use the second index `{dsgIfVendorIndex}` to walk through the individual Vendor-Specific Parameters for each of the Vendor Param IDs in the `dsgIfVendorParamTable`. The `dsgIfVendorValue` object is a string of octets inserted immediately following the TLV 43.8 (Vendor ID). The VSP TLV structure is: 43, L, 8, 3, `dsgIfVendorOUI`, `dsgIfVendorValue`. The length byte "L" equals the length of `dsgIfVendorValue` plus 5 bytes. Each row becomes an individual instance of TLV 50.43 that is added to the DCD.

It is worth noting here that the `dsgIfTunnelTable` contains an object for `dsgIfTunnelServiceClass`. This object does not contribute data for the DCD message. It is used to provide Quality of Service for the DSG Tunnel via a Named Service Class (and the associated QoS Parameter Set defined in the `docsQosServiceClassTable`).

I.3 DownStream Packet Classification Encoding (23)

The DCD can contain one or more DSG Classifiers. Once the DSG Rules have been built for the DCD, it is a simple matter of walking through those DSG Rules and, for every instance of the DSG Classifier Identifier (TLV 50.6), add a classifier to the DCD message starting with the Classification Encoding (TLV 23). Each classifier will contain the following sub-TLVs:

- Classifier Identifier (23.2) – Add the index {`dsgIfClassID`} directly to the DSG Rule as the Classifier ID.
- Classifier Rule Priority (23.5) – The row in `dsgIfClassifierTable` contains `dsgIfClassPriority`. Add it to the DSG Rule.
- IP Packet Classification Encodings (23.9) – Classifiers may contain one or more of the following TLVs:
 - Source IP Address (23.9.3) – The row in `dsgIfClassifierTable` contains `dsgIfClassSrcIpAddr`. Add it to the DSG Rule.
 - Source IP Mask (23.9.4) – The row in `dsgIfClassifierTable` contains `dsgIfClassSrcIpPrefixLength`. Add it to the DSG Rule.
 - Destination IP Address (23.9.5) – The row in `dsgIfClassifierTable` contains `dsgIfClassDestIpAddress`. Add it to the DSG Rule.
 - Destination TCP/UDP Port Start (23.9.9) – The row in `dsgIfClassifierTable` contains `dsgIfClassDestPortStart`. Add it to the DSG Rule.
 - Destination TCP/UDP Port End (23.9.10) – The row in `dsgIfClassifierTable` contains `dsgIfClassDestPortEnd`. Add it to the DSG Rule.

I.4 Iteration

This completes one 'path' through the MIB as mentioned above. Seek out the notations marked (*iteration*) to complete the assembly of the DCD message from the MIB.

I.5 Order of data entry into the MIB

No one correct method exists for entering data into the Agent MIB. In some cases, an Agent toolset may be provided to build the MIB in a prescribed manner. If no such guidance is provided, consider the following.

Since the MIB has many indexes and an ordered data structure, it may be quicker to enter data in an orderly sequence. The arrows in Figure I.1 show the use of the indexes from table-to-table. Consider working backwards against the flow of the arrows as data is entered. The following list of tables illustrates one possible method of entering data in an orderly sequence.

- `dsgIfVendorParamTable`;
- `dsgIfChannelListTable`;
- `dsgIfTimerTable`;
- `dsgIfClientIdTable`;
- `docsQosServiceClassTable` (actually in the DOCS-QOS-MIB);
- `dsgIfDownstreamTable`;
- `dsgIfTunnelGrpToChannelTable`;

- dsgIfTunnelTable;
- dsgIfClassifierTable.

I.6 Building the MIB from a model of communication paths – (example)

Figure I.2 illustrates how to design the MIB given a drawing of data flowing down tunnels. This figure shows only one hypothetical example of a MIB design; it does not represent a generalized data structure (like Figure I.1 does). Figure I.2 illustrates the scratch notes that might be drawn up early in the design of the MIB. IP packets filter through the classifiers at the top of Figure I.2 and move down through various tunnels that enter downstream channels at the bottom of the figure.

NOTE – The solid arrows in Figure I.2 show the flow of data, as indicated by the notation "Data flow >>" in the top left.

Figure I.2 was drawn using the table copied directly from Figure I.1. The top row shows four different classifiers. While these four classifiers all have the same structure as Figure I.1, they can all contain different TLVs for classifying IP packets, as needed for the data flows they control.

Note that various MIB tables have been omitted from Figure I.2, namely:

- docsQosServiceClassTable;
- dsgIfClientTable;
- dsgIfVendorParamTable;
- dsgIfChannelListTable;
- dsgIfTimerTable.

Since these tables are largely used to populate individual tables that are shown in Figure I.2, they have been left out of the figure to keep the drawing cleaner. When using this graphical method to design a MIB, do not forget to include information from these missing tables.

In this example, we want to design three tunnels as indicated by the three entries in the dsgIfTunnelTable in the second row. The data flow will be as follows:

- IP packets matching the first two classifiers both flow into the first tunnel (on the top left). That tunnel is mapped into two different downstream channels one and two via the dsgIfTunnelGrpToChannelTable.
- IP packets matching the third classifier enter the second tunnel and into the second and third downstream channels.
- IP packets matching the fourth classifier enter the third tunnel and into the second and third downstream channels.
- Summary – Downstream one will contain tunnel 1; downstream two will contain tunnels 1 through 3; and downstream three will contain tunnels 2 and 3.

To build the MIB, populate the boxes in Figure I.2 and collapse the boxes (horizontally) into individual tables of the MIB. Do not forget to build the other tables that were omitted from Figure I.2 (listed above). Use the recommendations in the clause above entitled "Order of data entry into the MIB" to put the data into the MIB. It should make things simpler.

How then to build the MIB objects and tables for this particular example? There may be multiple ways to do this, including the following method. Figure I.3 serves a dual purpose. It will show how DCD Rules are found in the graphical representation of a design. The figure also shows values that might be assigned to the indexes to organize the objects within the MIB. The index values referred to in the discussion immediately below can be seen in Figure I.3 contained in brackets, i.e., [index]. The values chosen for the indexes can be assigned in the manner shown, as one of many possibilities.

First, the following five tables in the MIB, omitted from Figure I.2, can be populated with object data to suit the application:

- docsQosServiceClassTable;
- dsgIfClientTable;
- dsgIfVendorParamTable;
- dsgIfChannelListTable;
- dsgIfTimerTable.

dsgIfDownStreamChannelTable – This table will have three entries, one for each of the downstreams shown in the bottom of Figure I.2. The indexes can be 1, 2, and 3.

dsgIfTunnelGrpToChannelTable – This table will have four entries.

- The first two objects comprise the first entry, each with a first index of [1] and sub-indexes of [1] and [2] for the first two downstreams. Each downstream will have the index {dsgIfTunnelGrpDsIfIndex} set equal to the IfIndex of the corresponding downstream in dsgIfDownstreamChannelTable.
- The third and fourth objects comprise the second entry, each with a first index of [2] and sub-indexes of [1] and [2] for the last two downstreams. Each downstream will have the index {dsgIfTunnelGrpDsIfIndex} set equal to the IfIndex of the corresponding downstream in dsgIfDownstreamChannelTable.

dsgIfTunnelTable – This table will have three entries, one for each tunnel, with indexes [1] through [3].

dsgIfClassifierTable – In this example, this table will have three entries. The first two objects comprise the first entry with a primary index [1] and sub-indexes of [1] and [2] for the two classifiers of tunnel one. The second and third entries, with primary indexes [2] and [3], each contain single classifiers and one sub-index. The sub-indexes are the Classifier IDs.

I.7 DCD rules from this example

Figures I.3, I.4, I.5, and I.6 illustrate the formation of DCD Rules in our example MIB.

- Downstream one, Rule 1 – Figure I.3 shows Rule 1, the only Rule for downstream 1. The dotted line on the left of the figure shows the Rule formation as denoted by "<< Rule 1". Formally speaking, the dotted line that goes up to the dsgIfClassifierTable is not part of the Rule, but shows the association of the classifiers to the Rule.
- Downstream two, Rule 1 – Figure I.4 shows Rule 1 for downstream 2. It gets data from the first tunnel.
- Downstream two, Rule 2 – Figure I.5 shows Rule 2 for downstream 2. It gets data from the second tunnel.
- Downstream two, Rule 3 – Figure I.6 shows Rule 3 for downstream 2. It gets data from the third tunnel.
- Downstream three Rules – There are no figures illustrating the two rules for downstream 3. These two rules are very similar in construct to Rules 2 and 3 of downstream two and are left as an exercise for the reader. Downstream three should get data from the second and third tunnels.

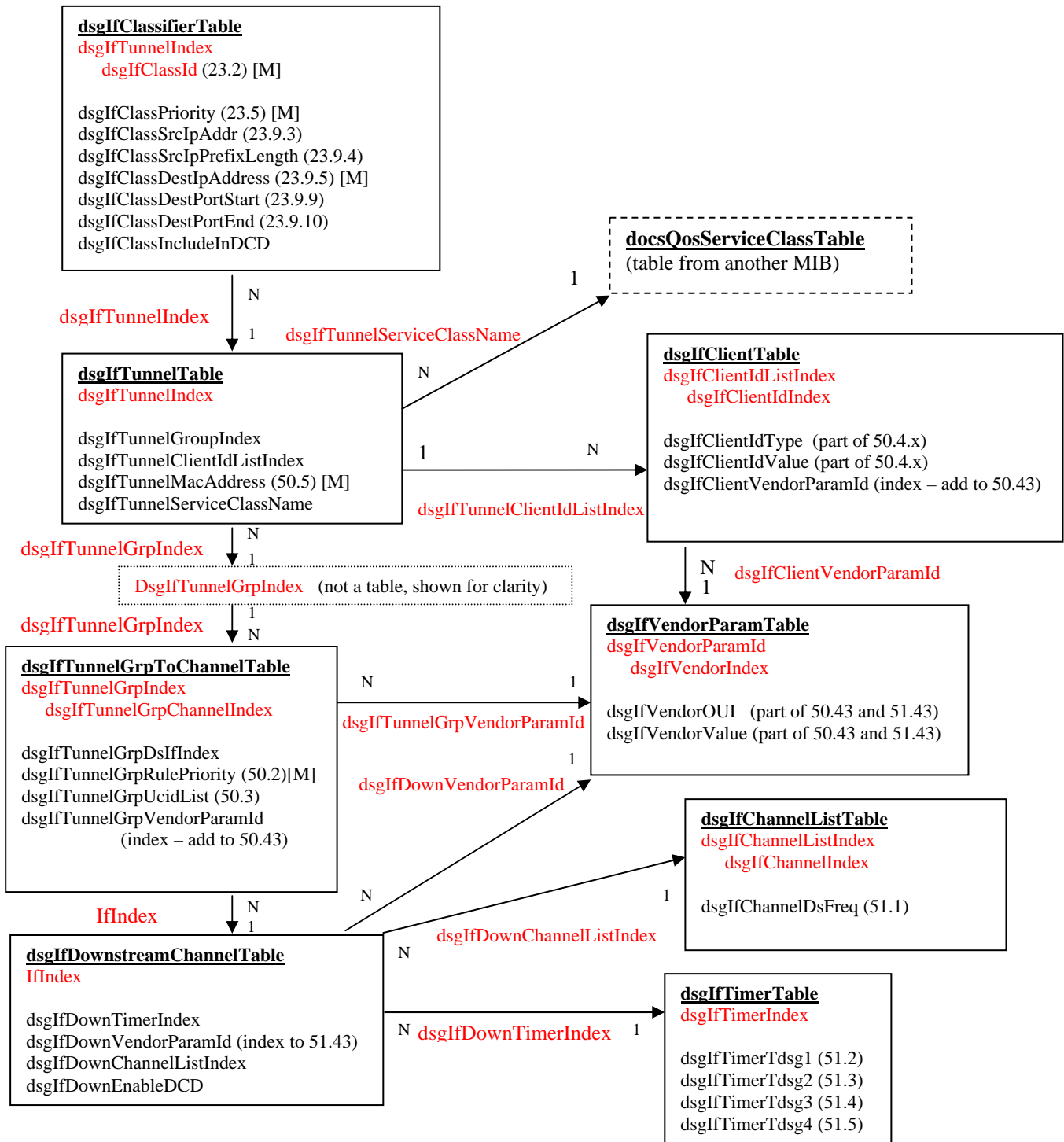

[M] – Means 'Mandatory' as defined in Table 5-1.

Figure I.1 – MIB structure

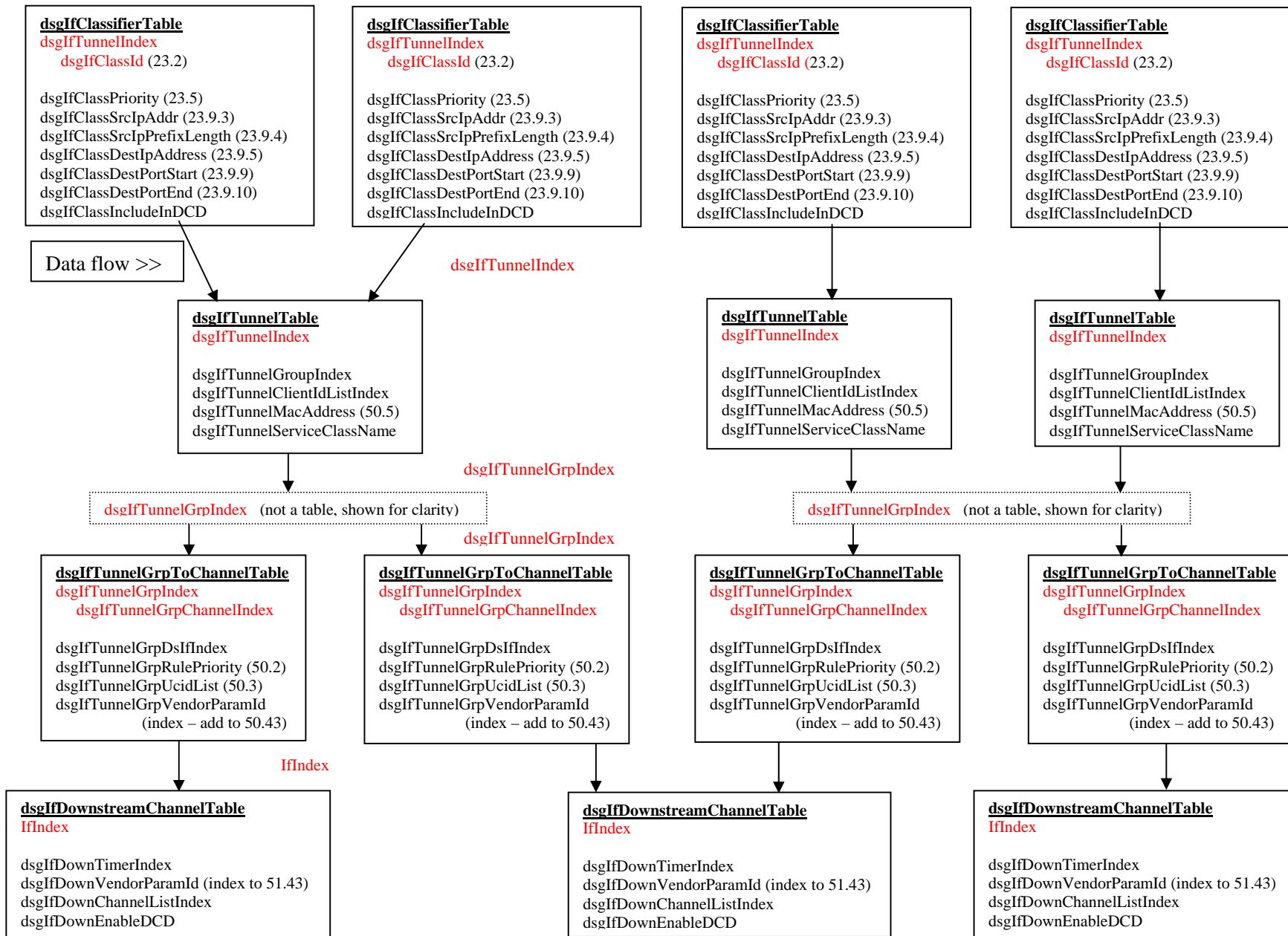

Figure I.2 – Example of designing

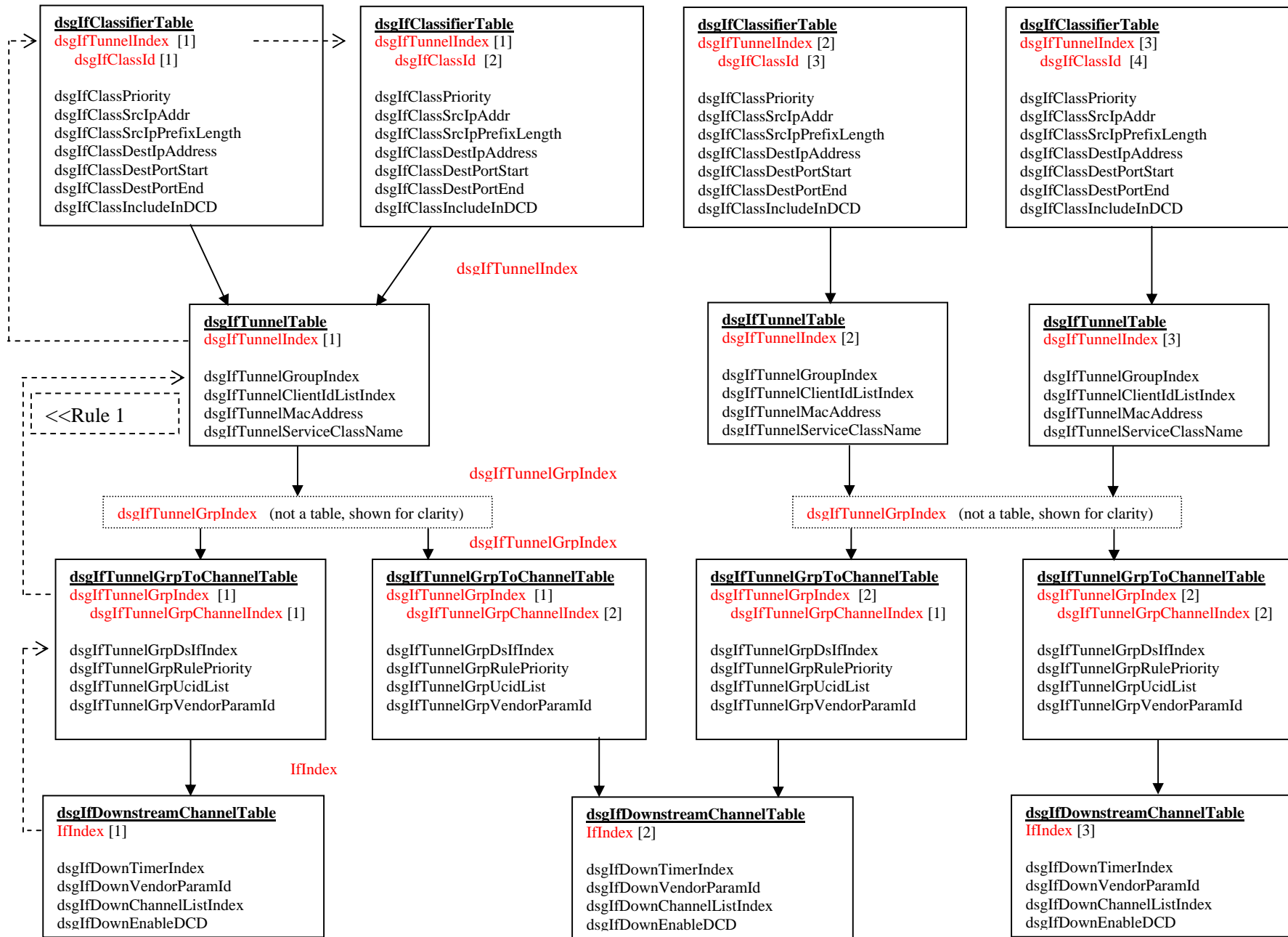

Figure I.3 – DS1, Rule 1 tunnels

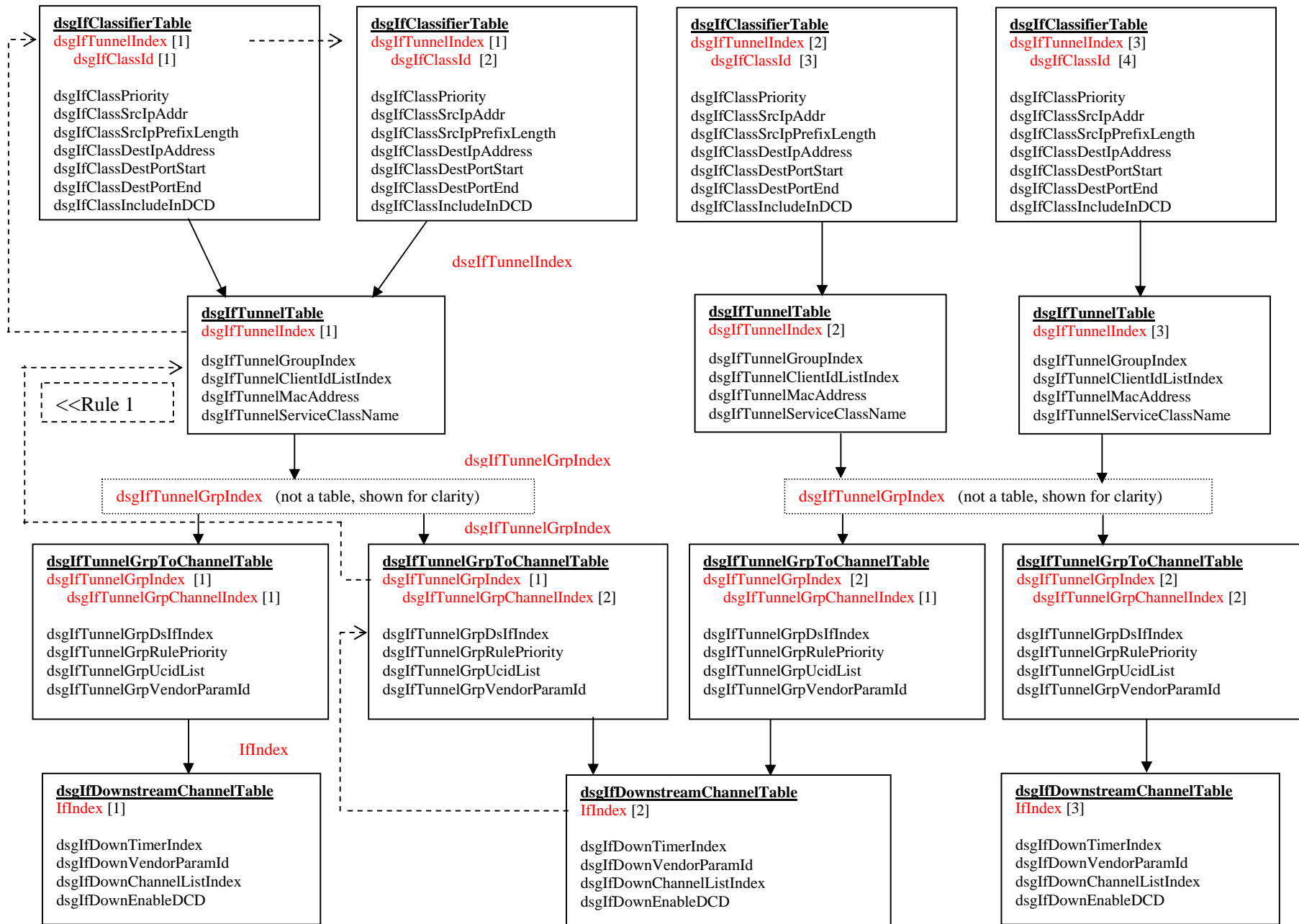

Figure I.4 – DS2, Rule 1

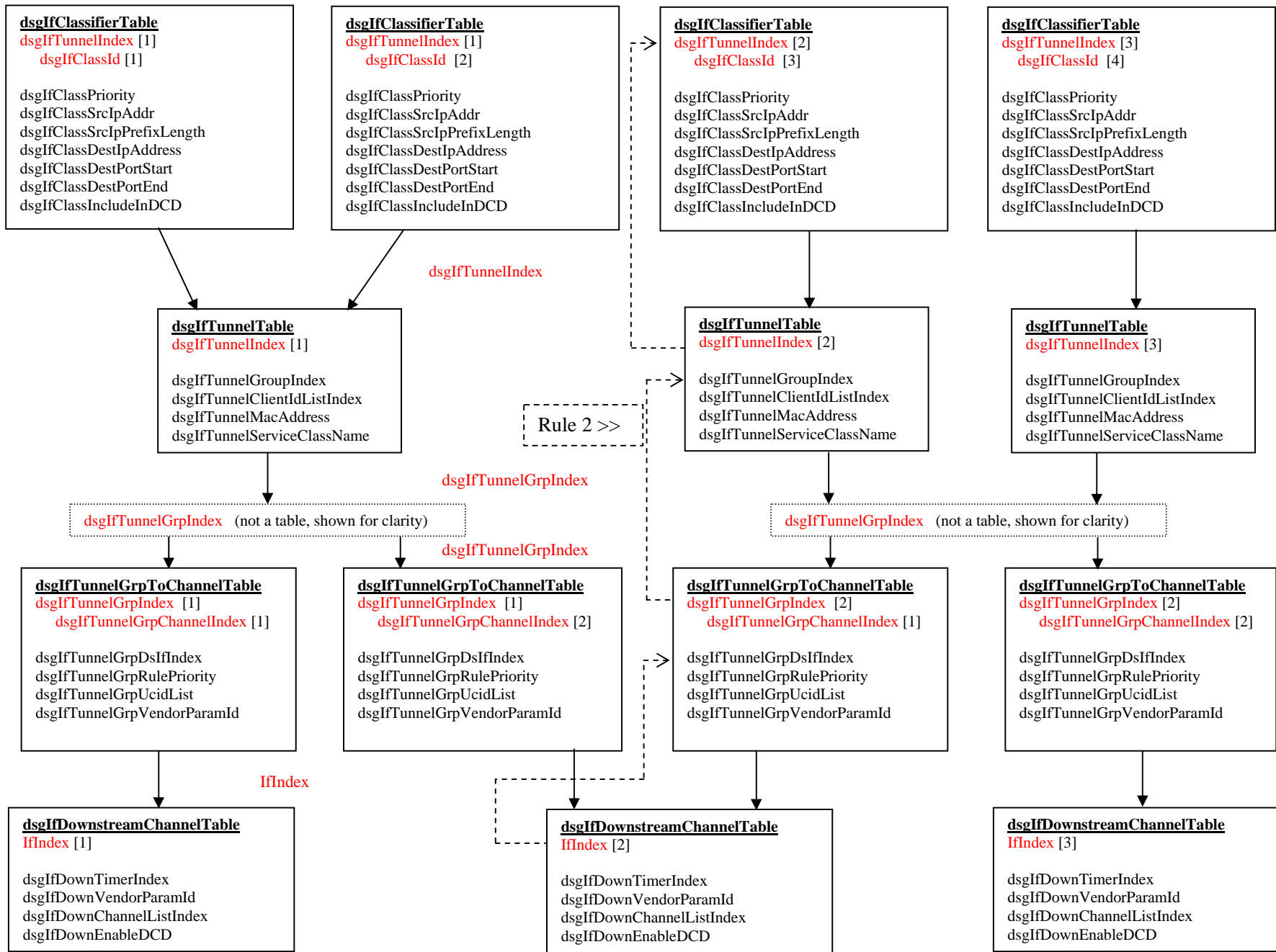

Figure I.5 – DS2, Rule 2

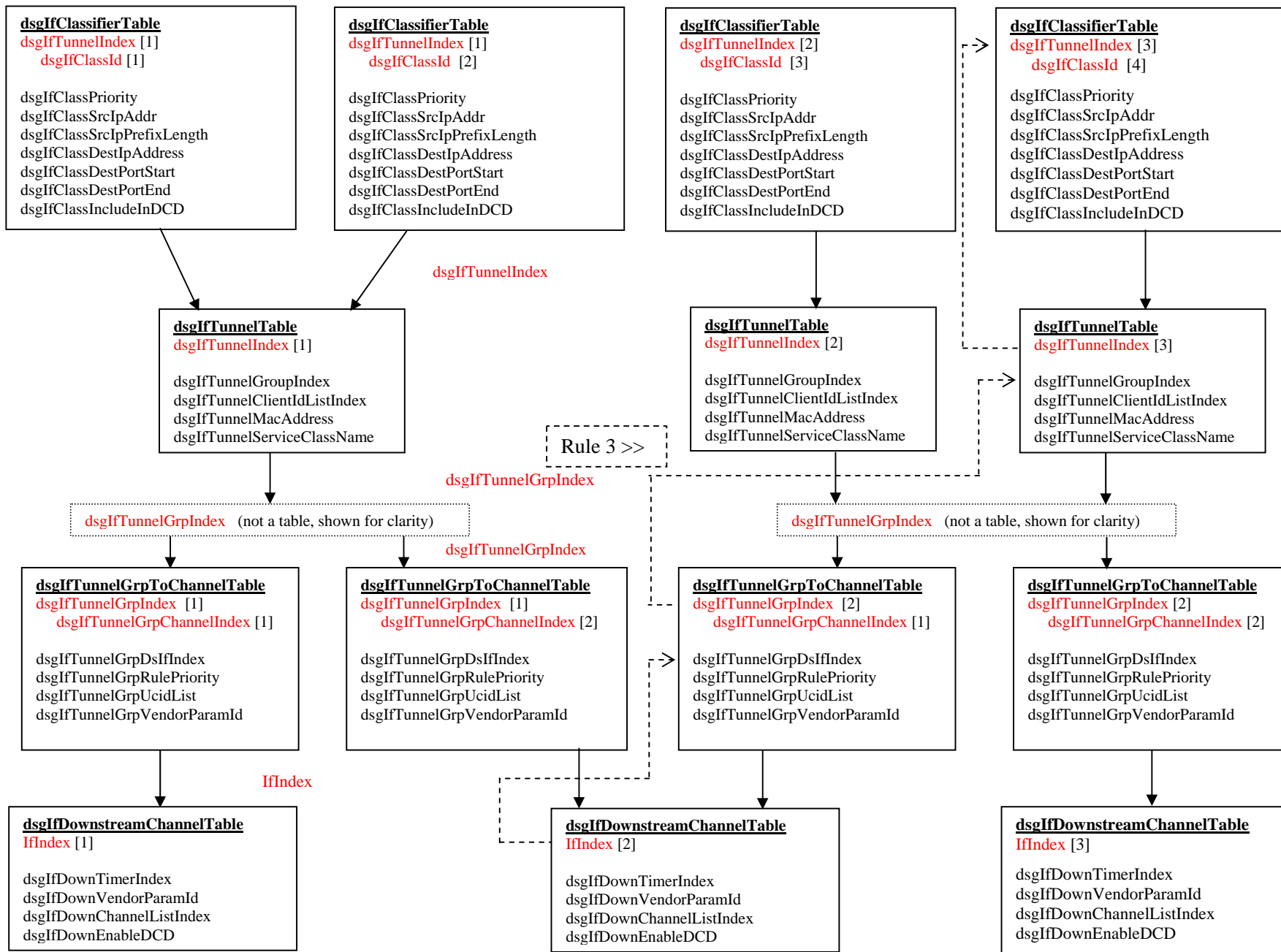

Figure I.6 – DS2, Rule 3

Bibliography

- [b-OC-CC-IF] OpenCable™ CableCARD™ Interface Specification, OC-SP-CC-IF-I18-041119, November 19, 2004, <http://www.opencable.com/>
- [b-OC-HOST-CFR] OpenCable™ Host Device 2.0 Core Functional Requirements, OC-SP-HOST2.0-CFR-I02-041119, <http://www.opencable.com/>

SERIES OF ITU-T RECOMMENDATIONS

Series A	Organization of the work of ITU-T
Series D	General tariff principles
Series E	Overall network operation, telephone service, service operation and human factors
Series F	Non-telephone telecommunication services
Series G	Transmission systems and media, digital systems and networks
Series H	Audiovisual and multimedia systems
Series I	Integrated services digital network
Series J	Cable networks and transmission of television, sound programme and other multimedia signals
Series K	Protection against interference
Series L	Construction, installation and protection of cables and other elements of outside plant
Series M	Telecommunication management, including TMN and network maintenance
Series N	Maintenance: international sound programme and television transmission circuits
Series O	Specifications of measuring equipment
Series P	Telephone transmission quality, telephone installations, local line networks
Series Q	Switching and signalling
Series R	Telegraph transmission
Series S	Telegraph services terminal equipment
Series T	Terminals for telematic services
Series U	Telegraph switching
Series V	Data communication over the telephone network
Series X	Data networks, open system communications and security
Series Y	Global information infrastructure, Internet protocol aspects and next-generation networks
Series Z	Languages and general software aspects for telecommunication systems