

International Telecommunication Union

ITU-T

TELECOMMUNICATION
STANDARDIZATION SECTOR
OF ITU

K.27

(03/2015)

SERIES K: PROTECTION AGAINST INTERFERENCE

Bonding configurations and earthing inside a telecommunication building

Recommendation ITU-T K.27

ITU-T



Recommendation ITU-T K.27

Bonding configurations and earthing inside a telecommunication building

Summary

Recommendation ITU-T K.27 provides the procedures for implementing the bonding between metallic bodies and the earthing connections inside a telecommunication building. It provides the bonding configurations and earthing in order to achieve protection against electric shock and to minimize damage of the telecommunication equipment due to lightning flashes, as well as to limit interference between telecommunication equipment installed in the same building. Examples of the metallic bodies considered in this Recommendation are: equipment frame, shield of cables, metallic structure of the building, protective earth conductor, bonding conductors, earthing electrodes. This Recommendation provides several possibilities of bonding configurations and discusses their advantages and disadvantages. The theory of bonding and earthing is also presented and is used as rationale for the development of the procedures.

History

Edition	Recommendation	Approval	Study Group	Unique ID*
1.0	ITU-T K.27	1991-03-18	V	11.1002/1000/1397
2.0	ITU-T K.27	1996-05-08	5	11.1002/1000/3349
3.0	ITU-T K.27	2015-03-01	5	11.1002/1000/12405

* To access the Recommendation, type the URL <http://handle.itu.int/> in the address field of your web browser, followed by the Recommendation's unique ID. For example, <http://handle.itu.int/11.1002/1000/11830-en>.

FOREWORD

The International Telecommunication Union (ITU) is the United Nations specialized agency in the field of telecommunications, information and communication technologies (ICTs). The ITU Telecommunication Standardization Sector (ITU-T) is a permanent organ of ITU. ITU-T is responsible for studying technical, operating and tariff questions and issuing Recommendations on them with a view to standardizing telecommunications on a worldwide basis.

The World Telecommunication Standardization Assembly (WTSA), which meets every four years, establishes the topics for study by the ITU-T study groups which, in turn, produce Recommendations on these topics.

The approval of ITU-T Recommendations is covered by the procedure laid down in WTSA Resolution 1.

In some areas of information technology which fall within ITU-T's purview, the necessary standards are prepared on a collaborative basis with ISO and IEC.

NOTE

In this Recommendation, the expression "Administration" is used for conciseness to indicate both a telecommunication administration and a recognized operating agency.

Compliance with this Recommendation is voluntary. However, the Recommendation may contain certain mandatory provisions (to ensure, e.g., interoperability or applicability) and compliance with the Recommendation is achieved when all of these mandatory provisions are met. The words "shall" or some other obligatory language such as "must" and the negative equivalents are used to express requirements. The use of such words does not suggest that compliance with the Recommendation is required of any party.

INTELLECTUAL PROPERTY RIGHTS

ITU draws attention to the possibility that the practice or implementation of this Recommendation may involve the use of a claimed Intellectual Property Right. ITU takes no position concerning the evidence, validity or applicability of claimed Intellectual Property Rights, whether asserted by ITU members or others outside of the Recommendation development process.

As of the date of approval of this Recommendation, ITU had not received notice of intellectual property, protected by patents, which may be required to implement this Recommendation. However, implementers are cautioned that this may not represent the latest information and are therefore strongly urged to consult the TSB patent database at <http://www.itu.int/ITU-T/ipr/>.

© ITU 2015

All rights reserved. No part of this publication may be reproduced, by any means whatsoever, without the prior written permission of ITU.

Table of Contents

	Page
1 Scope.....	1
2 References.....	1
3 Definitions	2
3.1 Terms defined elsewhere	2
3.2 Terms defined in this Recommendation.....	3
4 Abbreviations and acronyms	4
5 Conventions	4
6 Principles of bonding and earthing	5
6.1 Summary of theory	5
6.2 Implementation principles	6
6.3 Protection against electric shock	8
6.4 Protection against lightning.....	8
6.5 Functional earthing.....	9
7 Power distribution.....	9
7.1 AC power distribution	9
7.2 DC power distribution	10
8 Comparison between IBN and mesh-BN installations	11
9 Maintenance of bonding networks.....	12
10 Examples of connecting equipment configurations to the CBN	12
Annex A – Brief theory of bonding and earthing networks.....	13
A.1 Overview	13
Annex B – Examples of bonding configurations	16
B.1 Mesh-BN	16
B.2 Mesh-IBN with a bonding mat configuration	18
B.3 Star or sparse mesh-IBN with isolation of DC power return	20
Bibliography.....	23

Introduction

The transition from analogue to complex digital telecommunication systems has indicated inadequacies with earthing techniques of the past and has therefore caused renewed interest in bonding and earthing techniques and their impact on electromagnetic compatibility (EMC). Consequently, there is a need for an ITU-T Recommendation on bonding configurations and earthing inside a telecommunication building.

Within the field of EMC, regulations restricting electromagnetic emissions must be satisfied, and for acceptable performance, equipment must possess a specific level of immunity. Electromagnetic compatibility may be achieved by the construction of a common, earthed, conductive shielding network or structure referred to as the common bonding network (CBN). The CBN is the principal bonding and earthing network inside the building. The CBN may be augmented with nested shielding structures having "single point" connections to the CBN. These single point connected structures will be referred to as isolated bonding networks (IBNs). In a telecommunication building, the bonding and earthing network takes the form of the CBN, to which equipment is attached by multiple connections (mesh-BN) or by a single point connection (IBN). The selection of the bonding configuration has an important influence on the responsibility for achieving EMC. A defined bonding configuration permits clear, structured cable routing and earthing. It facilitates control of electromagnetic emissions and immunity, which is especially important for buildings containing newly installed and existing equipment. A comparison of these approaches (IBN and mesh-BN), including their attributes as functions of frequency are discussed in clause 8 and Annex A. As part of its shielding function, the bonding and earthing network provides for personnel safety and lightning protection, and helps control electrostatic discharge (ESD).

Since several different bonding and earthing configurations have been used, and it is desirable to promote standardization by defining generic versions of these configurations. Although there are differences among the configurations, there are many important common aspects. These are discussed in this Recommendation. In addition, three example configurations are described.

Recommendation ITU-T K.27

Bonding configurations and earthing inside a telecommunication building

1 Scope

Experience in the operation of telecommunication centres shows that the use of a bonding and earthing network that is coordinated with equipment capability and with electrical protection devices, has the following attributes:

- promotes personnel safety and reduces fire hazards;
- enables signalling with earth return;
- minimizes service interruptions and equipment damage;
- minimizes radiated and conducted electromagnetic emissions;
- reduces radiated and conducted electromagnetic susceptibility;
- improves system tolerance to discharge of electrostatic energy, and lightning interference.

Within this framework, this Recommendation:

- a) is a guide to bonding and earthing of telecommunication equipment in telephone exchanges and similar telecommunication switching centres;
- b) is intended to comply with safety requirements imposed by [IEC 60364-4-41] and [IEC 60364-5-54] or national standardizing bodies on AC power installations;
- c) can be used for installation of new telecommunication centres, and, if possible, for expansion and replacement of systems in existing centres;
- d) treats coordination with external lightning protection, but does not provide details of protective measures specific to telecommunication buildings;
- e) addresses the shielding contribution of the effective elements of the building;
- f) addresses shielding provided by cabinets, cable trays and cable shields;
- g) is intended to encourage EMC planning, which should include bonding and earthing arrangements that accommodate installation tests and routine diagnostics;
- h) does not include:
 - required values of surge current immunity and insulation withstand voltages;
 - limits of radiated and conducted electromagnetic emission or immunity;
 - techniques for verifying and maintaining bonding and earthing networks.

2 References

The following ITU-T Recommendations and other references contain provisions which, through reference in this text, constitute provisions of this Recommendation. At the time of publication, the editions indicated were valid. All Recommendations and other references are subject to revision; users of this Recommendation are therefore encouraged to investigate the possibility of applying the most recent edition of the Recommendations and other references listed below. A list of the currently valid ITU-T Recommendations is regularly published. The reference to a document within this Recommendation does not give it, as a stand-alone document, the status of a Recommendation.

- [ITU-T K.20] Recommendation ITU-T K.20 (2011), *Resistibility of telecommunication equipment installed in a telecommunication centre to overvoltages and overcurrents*.

- [IEC 60050-604] IEC 60050-604 (1987), *International Electrotechnical Vocabulary. Chapter 604: Generation, transmission and distribution of electricity – Operation.*
- [IEC 60050-826] IEC 60050-826 (2004), *International Electrotechnical Vocabulary. Part 826: Electrical installations.*
- [IEC 60364-4-41] IEC 60364-4-41 (2005), *Low-voltage electrical installations – Part 4-41: Protection for safety – Protection against electric shock.*
- [IEC 60364-5-54] IEC 60634-5-54 (2011), *Amendment 1 – Low-voltage electrical installations – Part 5-54: Selection and erection of electrical equipment – Earthing arrangements and protective conductors.*
- [IEC 62305-3] IEC 62305-3 (2010), *Protection against lightning - Part 3: Physical damage to structures and life hazard.*

3 Definitions

In this Recommendation, definitions with respect to earthing already introduced by the IEC in [IEC 60050-604] and [IEC 60050-826] are used to maintain conformity. For convenience, they are reproduced in clause 3.1. Definitions specific to telecommunication installations, and not covered by the IEC, are added in clause 3.2.

3.1 Terms defined elsewhere

This Recommendation uses the following terms defined elsewhere:

3.1.1 earth [IEC 60050-826]: The conductive mass of the earth, whose electric potential at any point is conventionally taken as equal to zero (in some countries the term "ground" is used instead of "earth").

3.1.2 earth electrode [IEC 60050-826]: A conductive part or a group of conductive parts in intimate contact with and providing an electrical connection with earth.

3.1.3 earthing conductor [IEC 60050-826]: A protective conductor connecting the main earthing terminal or bar to the earth electrode.

3.1.4 earthing network [IEC 60050-604]: The part of an earthing installation that is restricted to the earth electrodes and their interconnections.

3.1.5 equipotential bonding [IEC 60050-826]: Electrical connection putting various exposed conductive parts and extraneous conductive parts at a substantially equal potential.

3.1.6 equipotential bonding conductor [IEC 60050-826]: A protective conductor for ensuring equipotential bonding.

3.1.7 main earthing terminal [IEC 60050-826]: A terminal or bar provided for the connection of protective conductors, including equipotential bonding conductors and conductors for functional earthing, if any, to the means of earthing.

3.1.8 neutral conductor (N) [IEC 60050-826]: A conductor connected to the neutral point of a system and capable of contributing to the transmission of electrical energy.

3.1.9 protective conductor (PE) [IEC 60050-826]: A conductor required by some measures for protection against electric shock by electrically connecting any of the following parts:

- exposed conductive parts;
- extraneous conductive parts;
- main earthing terminal;

- earth electrode;
- earthed point of the source or artificial neutral.

3.1.10 PEN conductor [IEC 60050-826]: An earthed conductor combining the functions of both protective conductor and neutral conductor.

3.2 Terms defined in this Recommendation

The definitions of BN configurations are illustrated in Figures 1 and 2.

This Recommendation defines the following terms:

3.2.1 bonding network (BN): A set of interconnected conductive structures that provides an electromagnetic shield for electronic systems and personnel at frequencies from DC to low RF. The term "electromagnetic shield", denotes any structure used to divert, block or impede the passage of electromagnetic energy. In general, a BN need not be connected to earth but all BNs considered in this Recommendation will have an earth connection.

3.2.2 common bonding network (CBN): The CBN is the principal means for effecting bonding and earthing inside a telecommunication building. It is the set of metallic components that are intentionally or incidentally interconnected to form the principal bonding network (BN) in a building. These components include: structural steel or reinforcing rods, metallic plumbing, AC power conduit, protective conductors (PEs), cable racks and bonding conductors. The CBN always has a mesh topology and is connected to the earthing network.

3.2.3 common DC return (DC-C): A DC power system in which the return conductor is connected to the surrounding bonding network (BN) at many locations. This BN could be either a mesh-BN (resulting in a DC-C-MBN system) or an isolated bonding network (IBN) (resulting in a DC-C-IBN system). More complex configurations are possible (see clause 7.2).

3.2.4 isolated bonding network (IBN): A bonding network that has a single point connection (SPC) to either the common bonding network or another isolated bonding network. All IBNs considered here will have a connection to earth via the SPC.

3.2.5 isolated DC return (DC-I): A DC power system in which the return conductor has a single point connection to a bonding network (BN). More complex configurations are possible, see clause 7.2.

3.2.6 mesh-BN (MBN): A bonding network in which all associated equipment frames, racks and cabinets, and usually, the DC power return conductor, are bonded together as well as at multiple points to the CBN. Consequently, the mesh-BN augments the common bonding network (CBN).

3.2.7 mesh-IBN: A type of isolated bonding network (IBN) in which the components of the IBN (e.g., equipment frames) are interconnected to form a mesh-like structure. This may, for example, be achieved by multiple interconnections between cabinet rows, or by connecting all equipment frames to a metallic grid (a "bonding mat") extending beneath the equipment. The bonding mat is, of course, insulated from the adjacent common bonding network (CBN). If necessary the bonding mat could include vertical extensions, resulting in an approximation to a Faraday-cage. The spacing of the grid is chosen according to the frequency range of the electromagnetic environment.

3.2.8 single point connection (SPC): The unique location in an IBN where a connection is made to the CBN. In reality, the SPC is not a "point" but, of necessity, has sufficient size to accommodate the connection of conductors. Usually, the SPC takes the form of a copper bus-bar. If cable shields or coaxial outer conductors are to be connected to the SPC, the SPC could be a frame with a grid or sheet metal structure.

3.2.9 SPC window (SPCW): The interface or transition region between an isolated bonding network (IBN) and the common bonding network (CBN). Its maximum dimension is typically 2 metres. The SPC bus-bar (SPCB), or frame, lies within this region and provides the interface between

IBN and CBN. Conductors (e.g., cable shields or DC return conductors) that enter a system block and connect to its IBN must enter via the SPCW and connect to the SPCB or frame.

3.2.10 star-IBN: A type of isolated bonding network (IBN) comprising clustered or nested IBNs sharing a common single point connection (SPC).

3.2.11 system block: All the equipment whose frames and associated conductive parts form a defined bonding network (BN).

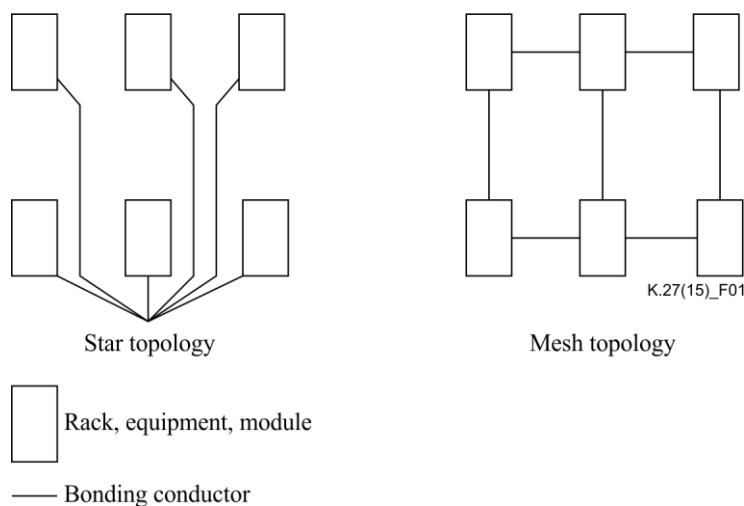

Figure 1 – Bonding network configurations forming a system block

4 Abbreviations and acronyms

This Recommendation uses the following abbreviations and acronyms:

- BN Bonding Network
- CBN Common Bonding Network
- EMC ElectroMagnetic Compatibility
- ESD ElectroStatic Discharge
- IBN Isolated Bonding Network
- MBN Mesh-Bonding Network
- N Neutral
- PCB Printed Circuit Board
- PEN Protective (earth) and Neutral conductor
- SPC Single Point Connection
- SPCB Single Point Connection Bus bar
- SPCW Single Point Connection Window

5 Conventions

None.

6 Principles of bonding and earthing

6.1 Summary of theory

Bonding and earthing refer to the construction and maintenance of bonding networks (BNs) and their connection to earth. In this Recommendation, the acronym BN implies that a connection to earth exists. Also, BN is used to refer to common bonding networks (CBNs) and isolated bonding networks (IBNs) collectively.

The primary purpose of a BN is to help shield people and equipment from the adverse effects of electromagnetic energy in the DC to low RF range. Typical energy sources of concern are lightning, and AC and DC power faults. Of generally lesser concern are quasi steady-state sources such as AC power harmonics, and "function sources" such as clock signals from digital equipment. All of these sources will be referred to generically as "emitters". People and equipment that suffer adversely from the energy from the emitters will be referred to as "susceptors". The coupling between a particular emitter and a particular susceptor may be characterized by a transfer function. The purpose of a BN is to reduce the magnitude of the transfer function to an acceptable level. This may be achieved by appropriate design of the CBN, and the mesh-BNs (MBNs) and IBNs attached to that CBN. Theoretical and quantitative aspects are discussed in Annex A. Practical aspects are discussed below.

Other purposes of a BN are to function as a "return" conductor in some signalling applications, and as a path for power fault currents. The capability of the BN to handle large currents helps to rapidly de-energize faulted power circuits. Also the BN, and its connection to earth, is used in "ground return" signalling (see clause 6.5).

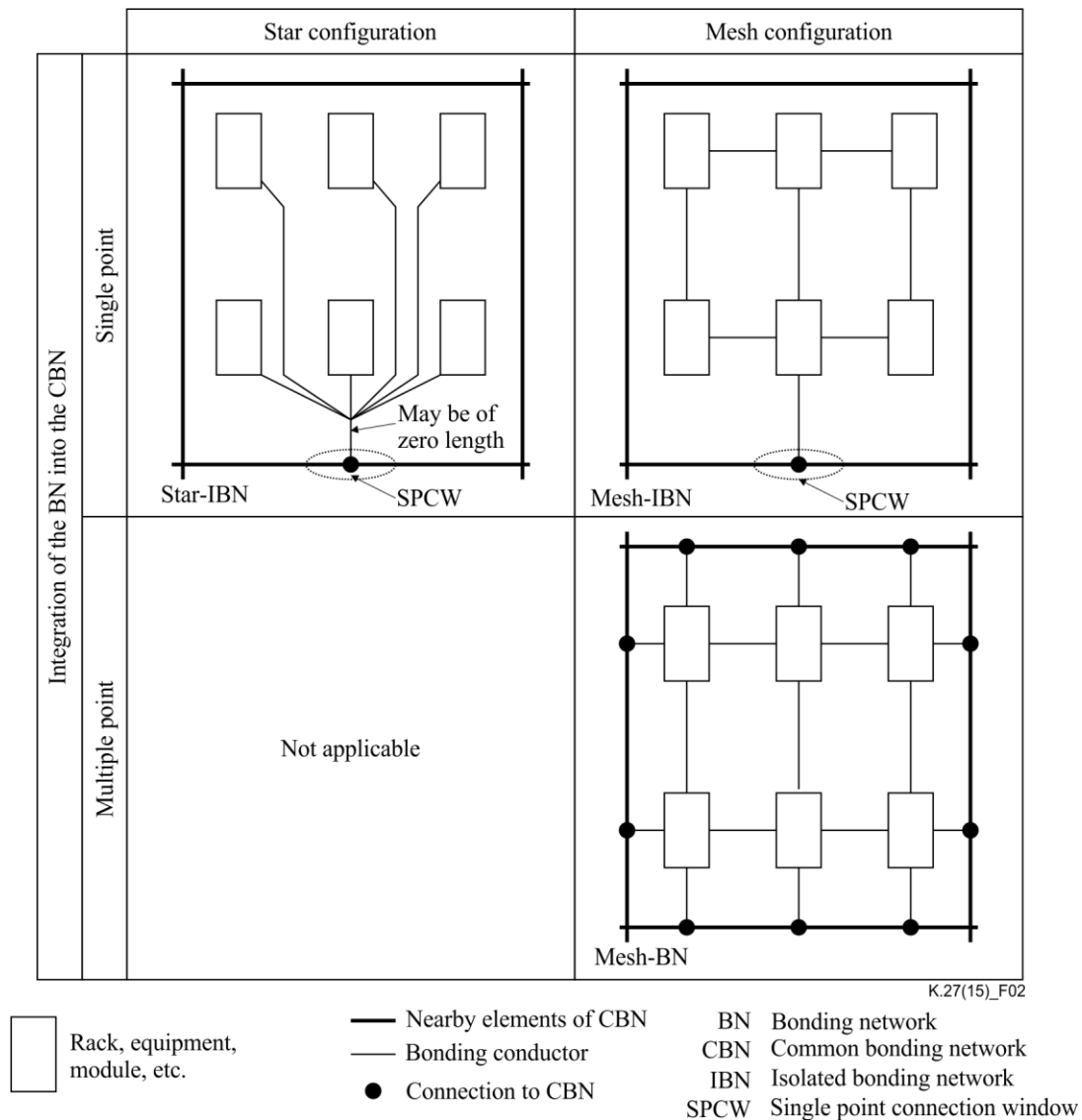

Figure 2 – Connection of system block to the CBN

6.2 Implementation principles

6.2.1 Implementation principles for the CBN

The theoretical concepts of Annex A are confirmed by practical experience and lead to the general principles listed below. A consequence of applying these principles is that the number of conductors and interconnections in the CBN is increased until adequate shielding is achieved. Concerning the important issue of electric shock, the following implementation principles apply to mitigation of electric shock as well as to equipment malfunction. Electric shock is discussed further in clause 6.3.

- a) All elements of the CBN shall be interconnected. Multiple interconnections resulting in a three-dimensional mesh are especially desirable. Increasing the number of CBN conductors and their interconnections increases the CBN shielding capability and extends the upper frequency limit of this capability.
- b) It is desirable that the egress points for all conductors leaving the building (including the earthing conductor), be located close together. In particular, the AC power entrance facilities, telecommunication cable entrance facilities, and the earthing conductor entry point, should be close together.

- c) The facility should be provided with a main earthing terminal located as close as possible to the AC power and telecommunication cable entrance facilities. The main earthing terminal shall connect to:
 - an earthing electrode(s) via a conductor of shortest length;
 - the neutral conductor of the AC power feed (in TN systems);
 - cable shields (at the cable entrance) either directly or via arresters or capacitors if required by corrosion considerations.
- d) The CBN shall be connected to the main earthing terminal. Multiple conductors between CBN and the main earthing terminal are desirable.
- e) As contributors to the shielding capability of the CBN, interconnection of the following items of the CBN is important:
 - metallic structural parts of the building including I-beams and concrete reinforcement where accessible;
 - cable supports, trays, racks, raceways and AC power conduit.
- f) The coupling of surges into indoor cabling (signal or power) is reduced, in general, by running the cables in close proximity to CBN elements. However, in the case of external surge sources, the currents in the CBN will tend to be greater in peripheral CBN conductors. This is especially true of lightning down-conductors. Thus, it is best to avoid routing cables in the periphery of the building. When this is unavoidable, metallic ducts that fully enclose the cables may be needed. In general, the shielding effect of cable trays, etc., is especially useful, and metallic ducts or conduit that fully enclose the cables provide near perfect shielding.
- g) In steel frame high-rise buildings, advantage may be taken of the shielding effect that the steel frame provides against lightning strokes. For cables extending between floors, maximum shielding is obtained by locating the cables near the centre of the building. However, as implied above, cables enclosed in metallic ducts may be located anywhere.
- h) Where the facility to use over-voltage primary protection [ITU-T K.20] on telecommunication wires is provided, it should have a low impedance connection to the cable shield, if it exists, and also to the surrounding CBN.
- i) Over-voltage protectors may be provided at the AC power entrance facility if the telecommunication building is located in an area where power lines are exposed to lightning. These protectors should be bonded with low impedance to the CBN.
- j) Mechanical connections, in a protection path of the CBN, whose electrical continuity is questionable shall be bypassed by jumpers that are visible to inspectors. These jumpers shall comply with IEC requirements for safety. However, for EMC applications, the jumpers should have low impedance.
- k) The CBN facilitates the bonding of cable shields or outer conductors of coaxial cables at both ends by providing a low impedance path in parallel and in proximity to the cable shields and outer conductors. Thus, most of the current driven by potential differences is carried by the highly conductive members of the CBN. Disconnection of one cable shield for inspection should minimally affect the current distribution in the CBN.

6.2.2 Implementation principles for a mesh-BN

The main feature of a mesh-BN is the interconnection, at many points, of cabinets and racks of telecommunication and other electrical equipment, and also multiple interconnections to the CBN.

If the outer conductor of a coaxial cable interconnection between mesh-BN equipment has multiple connections to the CBN, it may need additional shielding. If the shielding provided by a cable tray is

insufficient, additional shielding may be provided by use of shielded coaxial cable ("triax"), enclosing ducts, or conduit.

Bonding methods, in increasing order of EMC quality are: screw fastenings, spot welds, and welded seams. The highest level of EMC shielding is provided by equipment cabinets and any sheet-metal enclosures within these cabinets.

A proven countermeasure to undesirable emission or reception of electromagnetic energy, especially at high frequencies, is a shield that totally encloses the electronic circuit. Effective shielding of cables, especially when the shields are extensions of shielding cabinets, depends on shielding material, shield geometry, and especially the connection of the shield to the cabinet panels at which the shield terminates.

It is easy to add shielding to a mesh-BN configuration. The need for additional shielding may arise for example, if a broadcast transmitter were installed nearby.

In some situations, it may be advantageous to augment the mesh-BN by connecting all equipment frames of a system block to a conductive grid (a bonding mat) located either below or above a collection of equipment cabinets. This optional use of a bonding mat is shown in Figure B.1.

6.2.3 Implementation principles for an IBN

The main feature of an IBN is that it is isolated from the surrounding CBN except for a single point connection where conductors entering the system block enter via the transition region between the IBN and CBN (see definition of single point connection window (SPCW)).

Within the confines of an IBN, the importance of multiple interconnections between cabinets and racks, etc., depends on the details of DC power distribution and signal interconnection. For example, if the DC power return conductor has multiple connections to cabinet frames, then multiple interconnection of cabinet frames and racks is desirable for the following reason: it will tend to reduce surge coupling in the event of a DC fault in equipment within the IBN.

Concerning cable shields of twisted pair cables, if a shield is left open-circuit at the end that terminates on IBN equipment, while the other end is connected to the CBN, surges in the CBN may result in induced common mode surges on the pairs in that cable. If those pairs terminate on devices that can operate satisfactorily in the presence of a steady state common mode (e.g., opto-isolators, transformers, or surge protectors), and if those devices can also withstand common mode surges, then there may be an advantage in having the electrostatic shielding afforded by an open circuited shield.

In the case of coaxial cable, the outer conductor will, of necessity, terminate on the interface circuits at each end. Interface circuits containing transformers or opto-isolators may be used to isolate the outer conductor. If a shielded cable or waveguide enters the IBN from the CBN, the most generally effective strategy is to connect each end of the shield or waveguide to the equipment frame and to bond the shield or waveguide to the single point connection.

6.3 Protection against electric shock

A densely interconnected BN, together with its connection to earth, substantially reduces the likelihood of significant voltages appearing between adjacent metallic components. However, additional measures need to be taken, especially in regard to AC power distribution (see clause 7.1). [IEC 60364-4-41] and [IEC 60364-5-54] discuss protection against electric shock, and installations should conform to its recommendations.

6.4 Protection against lightning

A CBN conforming to clause 6.2.1 should adequately shield against lightning surges arriving at the building on conductors such as cable shields and power lines. However, in the event of a direct stroke to the building, the CBN may not provide sufficient shielding. Consequently, buildings without steel frames or reinforcements may require external lightning protection; especially so if the building has

a radio tower on its roof. Concerning the protective measures against the effects of a direct lightning stroke to a building, refer to [IEC 62305-3]. Where necessary to further reduce risk, these protective measures may have to be enhanced, e.g., by conductive roof layers, closer spacing of down-conductors, interconnection of the reinforcement of concrete buildings, and interconnection of metallic façade elements. It is advantageous to introduce all conductive elements of services, e.g., cables and pipes, into the building at one location and in close proximity.

6.5 Functional earthing

Telecommunication techniques sometimes use circuits for signalling with earth return, e.g., lines with ground start, three wire inter-exchange connection, etc. Equipment interconnected by these circuits needs functional earthing. The signalling range is normally determined by the resistance of the current path. Most of this resistance is contributed by the earth electrodes. The performance provided by the earthing network via the main earthing terminal is generally sufficient for this signalling purpose.

7 Power distribution

AC and DC power distribution in telecommunication buildings should be designed to limit coupling to telecommunication circuits arising from:

- mutual impedance of shared conductors;
- mutual inductive coupling (especially during short circuit conditions);
- common source impedances.

7.1 AC power distribution

It is recommended that the indoor mains installation within a telecommunication building be of type TN-S in order to improve the EMC performance of the telecommunication installation. This requires that there shall be no protective (earth) and neutral (PEN) conductor within the building. Consequently, a three-phase network within a telecommunication building is, physically, a five-wire installation (L1, L2, L3, N, PE).

Depending on the type of outdoor mains distribution network serving a telecommunication building, one of the following requirements shall apply:

- a) Service by a TN-S section of the outdoor mains distribution network:
 - 1) solely the protective conductor (PE) shall be connected to the main earthing terminal (see Figure 3, mode 1).
- b) Service by a TN-C section of the outdoor mains distribution network:
 - 1) the PEN conductor shall be connected to the main earthing terminal only;
 - 2) from the main earthing terminal to and within customer locations inside the building, the neutral conductor (N) shall be treated as a live conductor;
 - 3) a dedicated PE shall be provided (see Figure 3, mode 2).
- c) Service by a TT or IT section of the outdoor mains distribution network:
 - 1) the PE shall be derived via the main earthing terminal from the earthing network;
 - 2) the dimensioning of the PE shall follow the rules of the TN-S system.

If the outdoor mains distribution is of type IT or TT, a separation transformer dedicated to that building allows for the recommended TN-S installation. In this case the indoor mains installation must conform to Figure 3, mode 1.

7.2 DC power distribution

In telecommunication buildings, DC power is generally distributed from a centralized DC power plant, with the positive terminal connected to the CBN. This polarity is chosen to minimize corrosion in the outside cable plant. There may be exceptions for specific transmission systems.

The DC power return network may be connected to its surrounding BNs at a single point only. This case will be referred to as an "isolated DC return" system (DC-I).

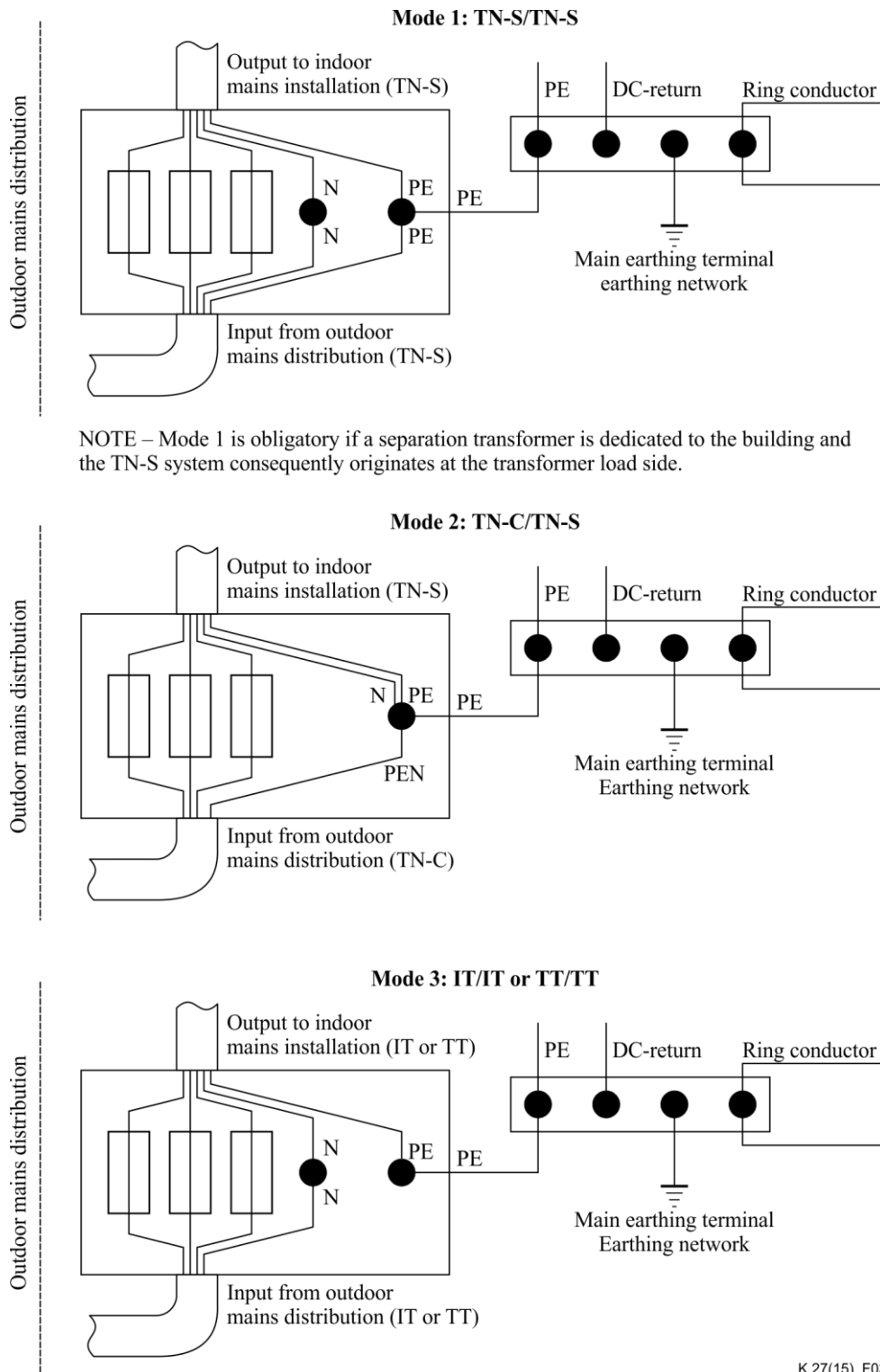

Figure 3 – Arrangements for the transition from the outdoor mains distribution system to the indoor AC distribution systems other than TN-S

Alternatively, the DC return may connect to the BN at multiple points (in which case some DC current will be conducted by the BN). This system will be referred to as a "DC return common to a BN" and denoted by "DC-C-BN". Typical configurations are DC-C-CBN (DC return common to the CBN), and DC-C-IBN (DC return common only to an IBN). Also, a DC return could, for example, traverse both the CBN and an IBN, and be common to the CBN but isolated from the IBN. This case is denoted by DC-C-CBN: DC-I-IBN. These are discussed in Annex B. Other more complicated interconnections of BNs and DC returns are also in use.

The advantage of a DC-C-BN system is that it cannot support a DC feed common-mode and hence unwanted coupling via this mode cannot occur. On the other hand, there will be coupling between the BN and the DC feed. The advantage of the DC-I-IBN system is that it avoids BN to DC feed coupling. However, it supports a common-mode and may introduce unwanted coupling. The choice between the two systems depends on the overall design strategy. Some recommendations are given below.

A DC-C-CBN feed may be used in systems in which the DC feed-to-CBN coupling has been minimized by the following measures:

- DC feed conductors have large cross-sections enabling them to carry high currents with minimal temperature rise;
- voltage drop at maximum load current is low;
- there is low source impedance, and low mutual impedance between the branches of the DC feed system.

The use of a DC-I feed results in a much lower DC feed-to-CBN coupling and is preferable in DC distribution networks designed with:

- loads in more than one system of electronic equipment (i.e., shared battery plant); and
- loads that are sensitive to transients occurring during short circuit conditions.

8 Comparison between IBN and mesh-BN installations

The advantage of installing equipment in an IBN is that a high level of shielding is attainable from DC through tens of kHz or perhaps hundreds of kHz depending on the size of the IBN (see clause A.1.2). The reason is that, within this frequency range, the single point connection between the IBN and CBN results in negligible current flowing between CBN and IBN. Some digital switches are designed specifically for installation within an IBN.

Mesh-IBNs and star-IBNs are both currently in use. Clause B.2 describes a mesh-IBN in the form of a "bonding-mat", and clause B.3 describes a star-IBN system. Sparsely interconnected mesh-IBNs have also been used successfully, and this is mentioned in clause B.3.

To limit the risk of electric shock between an IBN and the surrounding CBN, it is necessary to limit the size of the IBN (both horizontal and vertical extent). Passageways that form the boundary between IBN and CBN, should have a minimum width imposed.

Disadvantages of IBN installation are cable routing restrictions and the additional expense (compared to mesh-BN) of maintaining the isolation.

The advantage of installing equipment in a mesh-BN configuration is that equipment frames may be connected to the surrounding CBN without restriction. Also, shielded cables and coaxial cables may be routed, and their shields or outer conductors connected to cabinet frames, without restriction. If the CBN design and equipment susceptibility has been coordinated, the CBN provides shielding from DC through several megahertz. A mesh-BN installation also has maintenance advantages as described in clause 9.

A disadvantage of the mesh-BN installation is the need for quantitative design procedures and appropriate immunity data for equipment.

9 Maintenance of bonding networks

One advantage of mesh-BN installation is that small changes that occur in the CBN generally have only a small effect on its shielding capability. Moreover, when necessary, additional shielding may be obtained by introduction of additional conductors (e.g., bonding conductors, cable trays, and conduit). Such modifications are usually straightforward.

IBN systems are more difficult to maintain, because craft-person activity is liable to result in inadvertent interconnections between IBN and CBN, violating the desired single point connection, and introducing surge currents into the IBN. Closely related to this is maintenance of DC-I power systems. Verification of single point connection in a DC-I system is facilitated if this connection is made with a conductor, around which, a DC clamp-on ammeter can be clamped. Zero current confirms single point connection.

It is recommended that systematic verification be performed on all bonding configurations and earthing connections inside a telecommunication building.

10 Examples of connecting equipment configurations to the CBN

The bonding configuration that is used depends upon the type of equipment to be connected to the CBN.

The following three examples are described in Annex B:

- 1) mesh-BN (see clause B.1);
- 2) mesh-IBN with a bonding mat configuration (see clause B.2);
- 3) star, or sparse mesh-IBN with isolation of DC power return (see clause B.3).

Annex A

Brief theory of bonding and earthing networks

(This annex forms an integral part of this Recommendation.)

A.1 Overview

The basic theoretical notions of shielding apply to the entire electromagnetic spectrum extending from DC through microwave frequencies. The essence of these basic notions is represented by the circuit model of Figure A.1 a). The description of energy sources as "emitters", and susceptible equipment (and people) as "susceptors" is taken from [b-Keiser]. In Figure A.1 a), V_{em} is the frequency domain representation of the emitter (e.g., a Laplace or Fourier transform), and Z_{em} is the emitter source impedance. The susceptor is represented by its impedance Z_{su} . The electromagnetic interaction between emitter and susceptor is modelled by a two-port network (port A with terminals A0, and A1, and port B with terminals B0, and B1). In Figure A.1 a) this two-port is represented by a T-network, but a π representation is often useful, as is a Norton equivalent for the emitter.

Although Figure A.1 a) is a simplification of reality, it is usually an adequate model for any specific emitter-susceptor pair. Moreover, it can be used as the starting point whenever a more complex model is necessary.

Figure A.1 a) illuminates the two main strategies for increasing the shielding of the susceptor from the emitter: the "short-circuit" and "open-circuit" strategies. It is clear that if Z_C is zero, no energy from the emitter V_{em} can reach the susceptor and $V_{su} = 0$. The energy that leaves the emitter is "reflected by the short-circuit" and dissipates in the resistive components of Z_{em} and Z_A . (Energy can also be returned to the source but this is not significant here.) Similarly, it is clear that if either Z_A or Z_B are infinite in magnitude (i.e., open circuit), no emitter energy will reach the susceptor (and again $V_{su} = 0$). In this case, the energy that leaves the emitter is reflected by the open circuit. Suppose Z_B is the open circuit. Then $Z_B = \infty$, and the energy will dissipate in the resistive parts of Z_{em} , Z_A and Z_C . Note that in general, V_{su} and all impedances are functions of frequency.

The two-port in Figure A.1 a) (A1, A0, B1, B0) will be referred to as the shielding network relative to some specific emitter and susceptor. If a different emitter or susceptor were considered, new impedance functions Z_A , Z_B and Z_C would apply.

A most useful characterization of the shielding network is a frequency domain transfer function. Here, the transfer function $T(\omega)$ will be defined as either $I_{sut}(\omega)/V_{em}(\omega)$ or $V_{su}(\omega)/V_{em}(\omega)$. Thus $T(\omega)$, as defined here, is a function of Z_{em} and Z_{su} as well as Z_A , Z_B and Z_C .

To summarize, for each emitter-susceptor pair there is a transfer function, $T(\omega)$, that characterizes the shielding network.

Returning to the topic of shielding strategies, note that in general, perfect short and open circuits are not possible to achieve, since the best implementations possess inductance and capacitance respectively. As a result, instead of perfect shielding, the most that can be achieved is a transfer function, $T(\omega)$, whose magnitude is less than some prescribed value over some prescribed frequency range.

A.1.1 Application to BNs in general

In typical bonding networks, resistive components are small, and for transient events with spectra in the 1 kHz to 1 MHz range, the shielding network is primarily inductive. Consequently, the general representation of Figure A.1 a) reduces to Figure A.1 b). As noted above, the specific component values depend on a particular emitter-susceptor pair. However, the L_A , L_B and L_C in Figure A.1 b) are constants; they are not functions of frequency. An observation of fundamental importance is as follows: Increasing the number of conductors and interconnections in the BN (especially in the region

lying between the emitter and susceptor) will, in general, reduce L_C and hence reduce the transfer function of the BN relative to that emitter-susceptor pair. In the limiting case, the susceptor could be given near-total shielding by enclosing it in an unbroken sheet of metal (i.e., a Faraday cage).

A susceptor may be characterized by a "susceptibility threshold" $I_{sut}(\omega)$, or $V_{sut}(\omega)$. Sinusoidal excitation will be assumed, but the following theory may be adaptable to pulse excitation. As an example, consider as a susceptor, equipment whose frame is connected to the CBN at several points. Choose one of these points to be the test point. Suppose the CBN connection at the test point is made by a conductor, around which split-core transformers can be clamped for purposes of excitation and current measurement. Let the current at the test point be sinusoidal with angular frequency ω and amplitude $I_{su}(\omega)$. [$I_{sut}(\omega)$ real and positive.]

Suppose that for each ω , an $I_{sut}(\omega)$ is found such that the equipment functions normally for those $I_{su}(\omega)$ that satisfy:

$$I_{su}(\omega) < I_{sut}(\omega) \text{ for } \omega_1 < \omega < \omega_2$$

and functions abnormally for $I_{su}(\omega)$ that fails to satisfy this inequality. Then $I_{sut}(\omega)$ is the equipment susceptibility threshold for the frequency range $[\omega_1, \omega_2]$, and for that specific test point and connection configuration.

Also, suppose a worst-case emitter has been characterized (e.g., let V_{em} be that worst case), then the design of a bonding and earthing network may now be expressed quantitatively as follows: for every emitter-susceptor pair of concern, the network's transfer function shall satisfy the following inequality:

$$|T(\omega)V_{em}(\omega)| < I_{sut}(\omega) \text{ for } \omega_1 < \omega < \omega_2$$

Where:

ω_1 and ω_2 specify the frequency range of concern. Typically, $\omega_1 \sim 0$ and $\omega_2 \sim 1$ MHz.

Note that $I_{sut}(\omega)$ is specific to a particular test point, and to the particular configuration of equipment-to-CBN interconnections. It may not apply if the equipment or its interconnections are modified.

A.1.2 Some important features of IBNs

Isolated bonding networks use an open-circuit shielding strategy. However, because IBNs are invariably installed within an enclosing CBN, short and open circuit strategies operate in cascade as shown in Figure A.1 c). Here, node B2 could, for example, represent the frame of an equipment (Z_{su}) that is isolated except for a single point connection to the CBN at node B0. Node B1 represents all of the immediately surrounding CBN metalwork. Capacitor C represents the capacitance between the equipment frame and the surrounding CBN. Figure A.1 c) shows clearly that for low frequencies, $|T(\omega)|$ will be small (it has a zero at $\omega = 0$), but at a sufficiently high frequency there will be one or more resonances where $|T(\omega)|$ will have maxima. In the neighbourhood of these resonant frequencies, shielding will be poor. However, if there are no significant emitters in these spectral regions, or if the equipment has additional shielding that is effective in these spectral regions, then no malfunctions will occur.

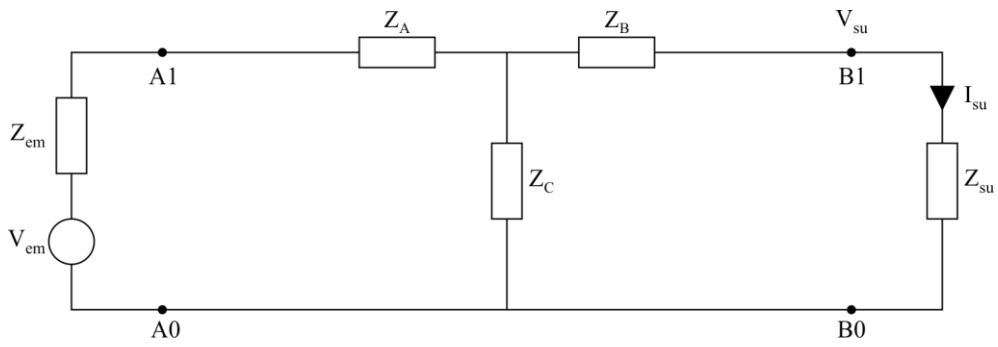

a) Fundamental shielding model

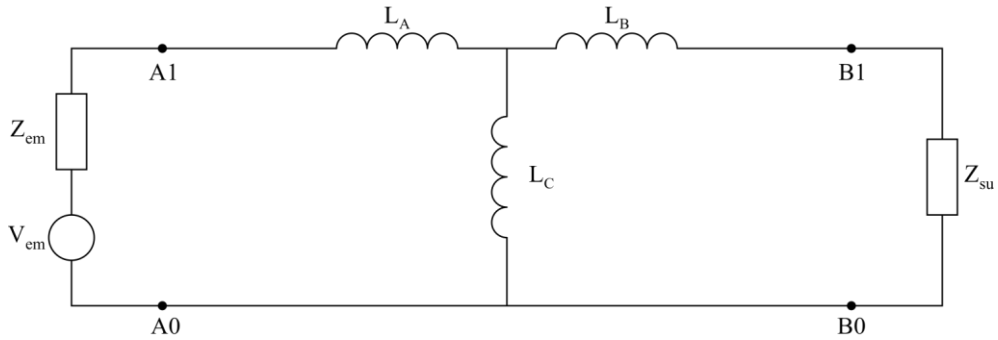

b) Shielding model for intra-CBN coupling

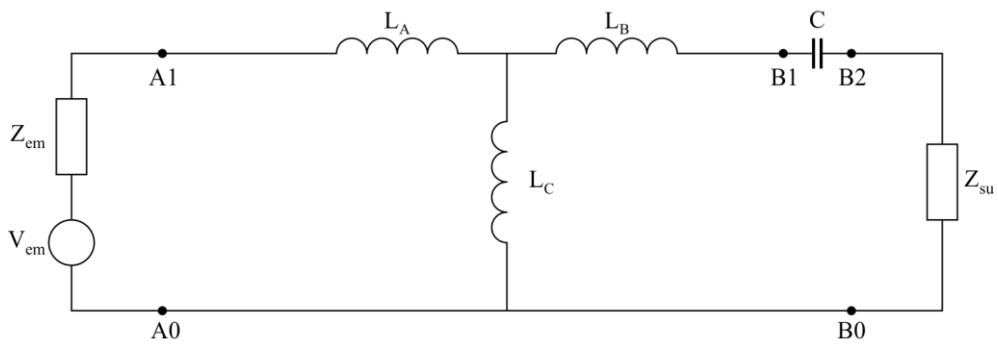

c) Shielding model for CBN-IBN coupling

K.27(15)_FA.1

Figure A.1 – Shielding model representations

Annex B

Examples of bonding configurations

(This annex forms an integral part of this Recommendation.)

B.1 Mesh-BN

A mesh-BN is a densely interconnected BN in which equipment frames are an extension of the CBN. In this example, which is shown in Figure B.1, the DC power system is of type DC C-MBN.

The DC power system operating at relatively high voltages (e.g., 400 V DC) shall be balanced about earth (positive and negative) by a resistive divider, whose centre point is connected to earth as shown in Figure B.1.

B.1.1 Components of a mesh-BN

In mesh-BNs, extensive interconnection among the following conductive elements is recommended:

- cabinets and cable racks of telecommunication and peripheral equipment;
- frames of all systems housed within the telecommunication building;
- the protective conductor PE of the TN-S type AC power installation;
- all metal parts, which according to [IEC 60364-5-54] must be connected to the protective conductor;
- the main earthing terminal, including earthing conductors and earth electrodes;
- each DC power return conductor along its entire length.

Multiple interconnections between CBN and each DC return along its entire length is usually a feature of the mesh-BN configuration. The DC return conductor of such a configuration may be entrusted with the functions of protective conductor for systems associated with AC loads or sockets, provided that continuity and reliability complies with [IEC 60364-5-54].

B.1.2 General design objectives

Safety requirements supersede all other requirements. To ensure continuity of bonding conductors, reliable connection methods shall be used, e.g., crimping, welding. However, if several options exist for fulfilling safety requirements, only that one shall be used which best coordinates with EMC requirements.

B.1.2.1 Non-telecommunication installations

Within the whole telecommunication building, there shall be no exception from the TN-S-type AC power installation [IEC 60364-5-54]. This requires, except at the main earthing terminal for a TN-C to TN-S transition at the entrance of the building, that the neutral conductor and protective conductor are nowhere interconnected in the building, neither in permanently connected equipment, nor in equipment connected by plug and socket.

B.1.2.2 Telecommunication equipment and systems

Telecommunication equipment with electronic circuitry is generally provided with a "potential reference" metallization that extends widely over the surface of the printed circuit boards (PCBs). If PCBs are connectorized, a number of pins are used to interconnect to adjoining cabling, backplanes, or motherboards. At this interface there starts the interconnection to the mesh-BN via equipment frames, shelf-racks, etc.

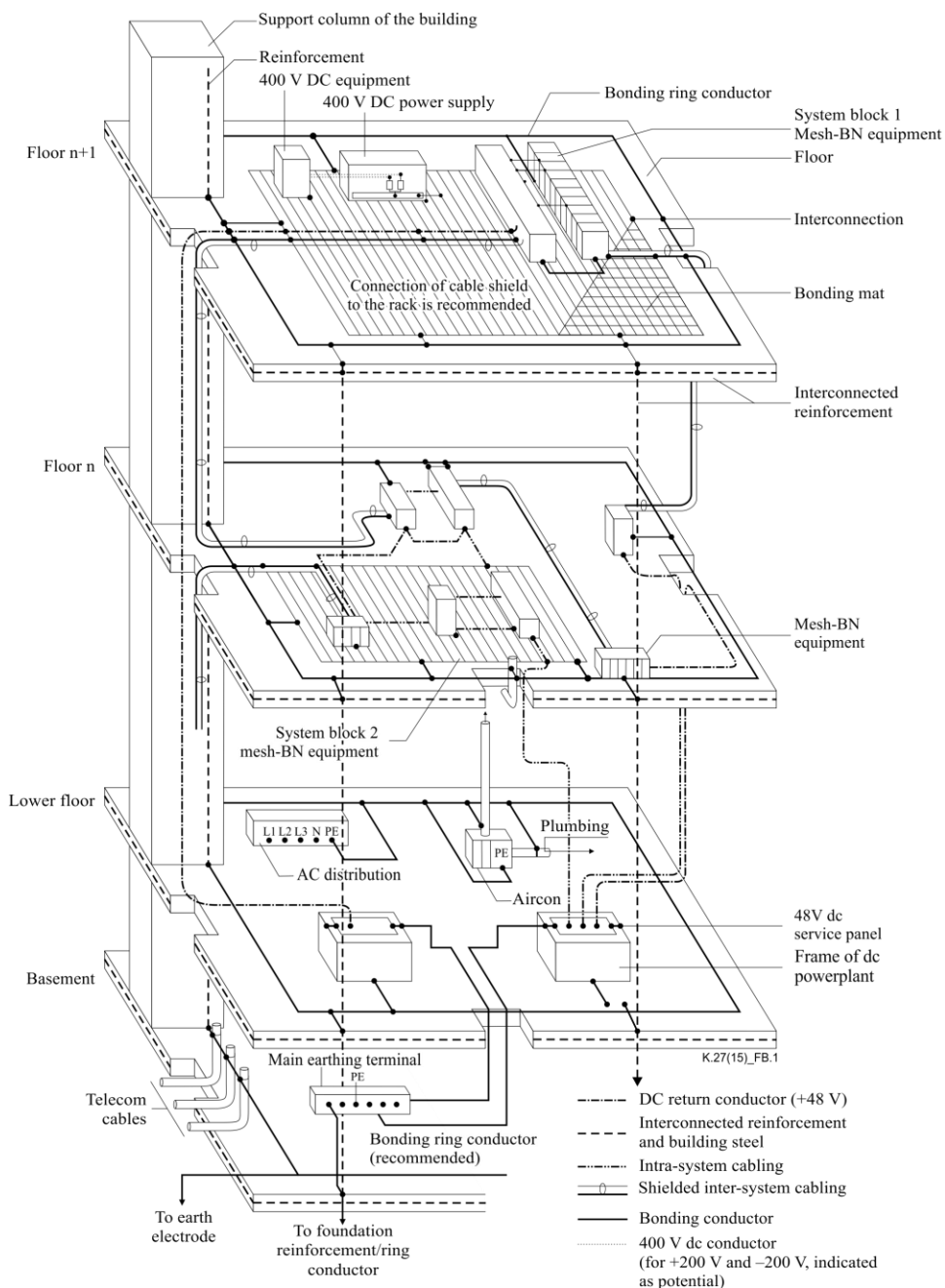

Figure B.1 – Mesh-BN installation inside a telecommunication building

The equipment racks shall be interconnected by low impedance leads or copper bars. Since the mesh-BN technique usually incorporates the DC return conductor into the CBN, the leads or bars can serve as the DC return. The leads or bars of each row have to be interconnected via the shortest route to minimize inductance. One or more DC return conductors may be used to interconnect the system to the centralized common power distribution cabinet or an intermediate power distribution panel. It is recommended that these leads be paired in close proximity with the corresponding negative DC power feed leads to reduce loop areas and enhance EMC. Small gauge DC power conductors should be twisted.

DC/DC converters generally have one input conductor and one output conductor connected to the mesh-BN. There may be exceptions in specific equipment.

An independent AC power supply network, derived from the DC supply by DC/AC converters, is best implemented as a TN-S type [IEC 60364-5-54].

Unrestricted fastening of the system to the floor and walls provides, in general, sufficient bypassing of stray capacitance for acceptable EMC performance of the system.

B.1.3 Cabling

Regarding EMC, cables can act as antennas, and support common modes that can transport extraneous energy into otherwise well-designed equipment. This antenna and common-mode propagation phenomenon can be mitigated by proper routing and shielding.

Routing of indoor cabling shall be in close proximity to conductive elements of the CBN and follow the shortest possible path. The shielding afforded by interconnected cable racks, trays, raceways, etc., shall be intentionally used. This shielding is effective only if it is continuous.

B.1.4 EMC performance

Equipment in an appropriately designed mesh-BN configuration, together with the use of DC power distribution with a return that is common to the mesh-BN (i.e., DC-C-MBN), is known to give acceptable EMC performance.

The incorporation of DC power return conductors into the mesh-BN limits voltage drops caused by short circuit currents in the DC power distribution network.

B.2 Mesh-IBN with a bonding mat configuration

A high level of shielding may be obtained by connecting all equipment frames within a system-block into a bonding-mat configuration. This configuration is isolated from the surrounding CBN. The result is a very effective type of mesh-IBN; an example is shown in Figure B.2.

The technical goals of this installation method are:

- a) prevention of CBN currents from flowing in the bonding-mat or any other part of the system-block;
- b) achievement of satisfactory EMC performance by controlled interconnection of system-blocks;
- c) provision of bonding and cabling facilities that allow for:
 - systematic EMC planning;
 - use of well-defined and reproducible EMC test methods.

The DC power system operating at relatively high voltages (e.g., 400 V DC) shall be balanced about earth (positive and negative) by a resistive divider, whose centre point is connected to earth as shown in Figure B.2.

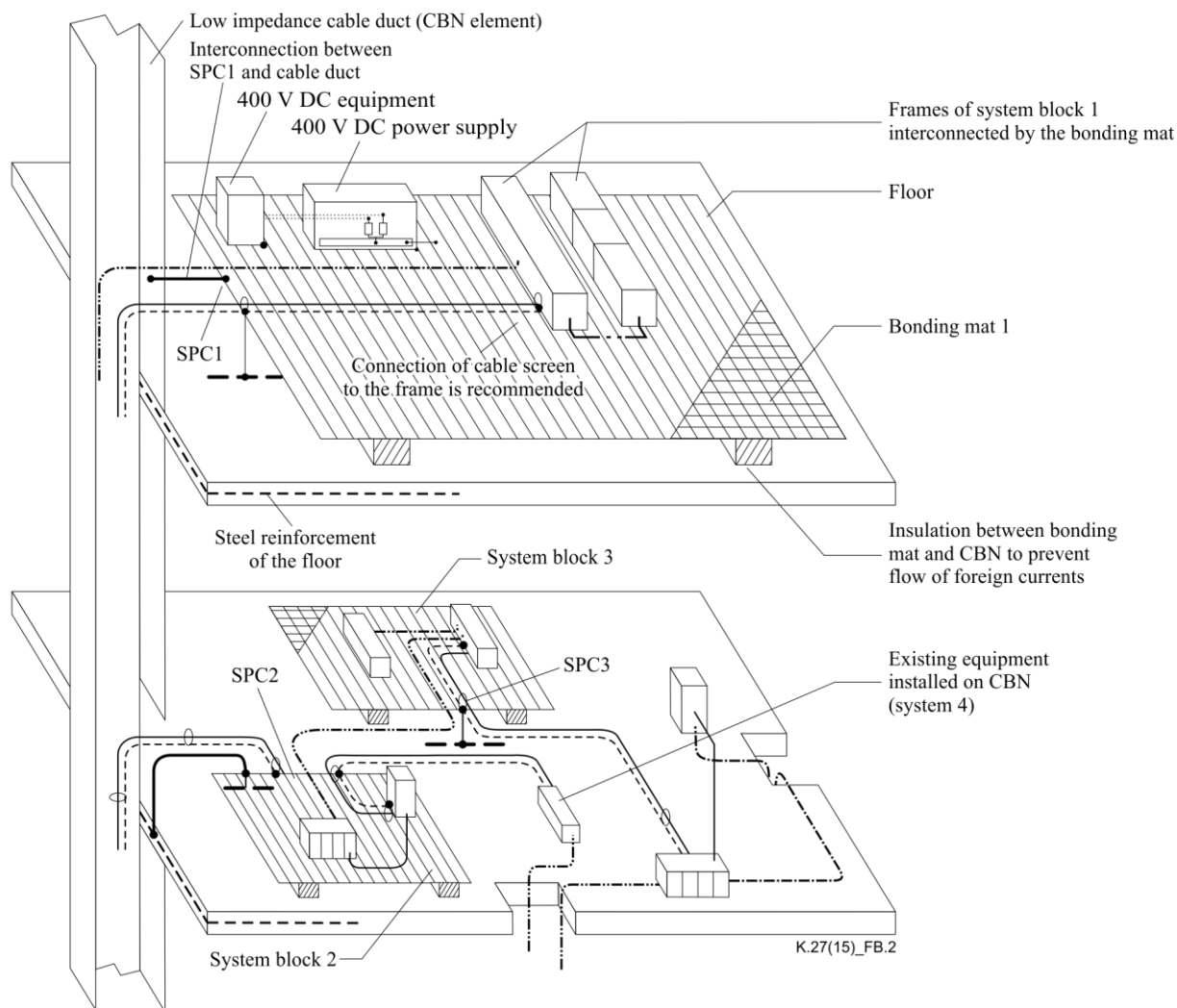

- SPC Single point connection
- Equipotential bonding conductor
- - - Steel reinforcement
- · - · - Unshielded intra- or inter-system cabling
- ○ - ○ - Shielded intra- or inter-system cabling
- 400 V dc conductor (for +200 V and -200 V, indicated as potential)
- · · Dots along the edge at a bonding mat denote its SPC.
- Inter-system cabling entering the system block must enter close to the SPC.

NOTE 1 – System blocks 1, 2 and 3 are new installations conforming to the mesh-IBN method. They may be connected to existing installations (system 4) that use any method of bonding.

NOTE 2 – The SPC is the only metallic interface between the mesh-IBN and the CBN. It must be directly connected to the reinforcement of the floor. All conductors that are bonded to the mesh-IBN must be connected to the SPC (e.g., cable screens, battery return).

Figure B.2 – Mesh-IBN with bonding mat

B.2.1 Equipment configuration

The system block comprises equipment agreed upon by the operating agencies and manufacturer(s) to be interconnected to the mesh-IBN (Figure 2). (Note that this agreement facilitates assignment of responsibility to either the supplier or the operating agency.)

Peripheral equipment denotes equipment location beyond the boundaries of the system block, but which relies functionally on a connection to the IBN.

Equipment serving air conditioning, lighting, etc., is considered to be external to the system block and may be installed or operated as part of the CBN of the building.

However, provision for the following is recommended:

- protective earthing;
- AC power distribution;
- DC power distribution up to the SPC, with the DC power return conductor(s) incorporated into the CBN (DC-C-CBN).

B.2.1.1 Single point connection

It is recommended that the SPC be established in the vicinity of its system, serving as the only connection between IBN and CBN.

B.2.1.2 Cabling

All conductors and cables connecting to the system block shall pass near to the SPC (i.e., through the SPC window). Metalwork near the system block shall be bonded to the SPC to avoid electric shock or flash-over in the event of a lightning strike to the building. Installation of a distribution frame at the SPC is recommended since this facilitates connection of cable shields to the SPC. It is recommended that the shields of all cables passing the SPC be connected to the SPC.

Alien cables crossing the area of the IBN must be spaced sufficiently apart from cables connecting to the SPC and the system block.

B.2.1.3 Equipment powered by external AC sources

Equipment with IEC class II certification (no PE connected) may be used without restriction within the system block area or at its periphery.

Equipment with IEC class I certification (relying on PE protection methods) shall be powered via isolating transformers, if not connected to DC/AC converters or AC power sockets belonging to the system block.

B.2.2 EMC performance

Equipment in an appropriately designed mesh-IBN configuration, together with the use of the DC power distribution with a return that is common to the mesh-IBN (i.e., DC-C-IBN), is known to give acceptable EMC performance.

B.3 Star or sparse mesh-IBN with isolation of DC power return

In this configuration, the framework of the switch is connected to form either a star or a mesh-IBN (see Figure 1). The cabinet framework and metallic panels are the major components of this IBN (there is no bonding mat). This type of IBN (whether star or mesh) will be denoted by "frame-IBN". The mesh topology is typically achieved by the cross-aisle interconnections afforded by cable trays. The result is a "sparse-mesh" IBN. The single point interconnection between a "frame-IBN" and the CBN is made at the SPC bus-bar located within the SPCW. The SPCW has a fixed dimension that allows the SPCB to be of sufficient size for connecting conductors, while limiting the voltage drop across the SPCB in the event of lightning surges or power system faults.

An example of this configuration (in its star form) is shown in Figure B.3. The DC feed section leaving the power plant is isolated (i.e., of type DC-I-CBN). This feed splits into a DC-I-IBN feed serving the frame-IBN equipment (the system block), and a DC-C-CBN feed serving mesh-IBN equipment. For the branch feeding the mesh-IBN equipment, a connection between DC return and CBN is made at the SPCB. Beyond the SPCW, this branch is of type DC-C-CBN (i.e., it has multiple connections to the CBN). The DC feed to the frame-IBN equipment need not pass through the SPCW since, within the frame-IBN, it is isolated. However, it is advantageous if most of the DC feed cable is in close proximity to bonding conductors, because this will reduce surge voltages that appear across the isolation barriers of the DC/DC converters on which the DC feed terminates.

To summarize, the main features of the system are:

- insulation of the frame-IBN from the surrounding CBN;
- connection of the frame-IBN to the CBN only at the SPCB;
- isolation of the DC return within the frame-IBN and between the power plant and the SPCW.

Systems of this type (both star and mesh configurations) have shown satisfactory EMC performance.

Note that this example demonstrates how a bonding and earthing network combines, in one building, systems using IBNs and mesh-BNs. The example also shows how all systems may share one DC power plant.

The DC power system operating at relatively high voltages (e.g., 400 V DC) shall be balanced about earth (positive and negative) by a resistive divider, whose centre point is connected to earth as shown in Figure B.3.

B.3.1 The DC power return configuration

In the DC power system, the frame-IBN branch and the power plant branch are isolated, resulting in no conductive coupling from the CBN in these branches. However, surges (e.g., lightning and short circuit fault currents) arising in the DC-C-CBN branch (that feeds mesh-BN equipment) can couple *indirectly* into the frame-IBN equipment via the common source impedance presented by the power plant and the DC-I-CBN section. This impedance is kept to a low value by running the -48 V conductors and DC return conductors in close proximity.

The bonding conductor from the SPCB to the frame of the power plant is run in close proximity to all DC feed conductors in the DC-I-CBN section. This reduces DC feed common-mode surge voltages at the power plant and enables fault clearing in the event of a fault between -48 V and frame in the power plant.

B.3.2 System installation

Cable shields from outside the IBN that terminate within the IBN (i.e., on the system block) have their shields:

- a) bonded to the frame-IBN and to no other point (such cables shall not extend more than one floor from the SPC); or
- b) bonded to the frame-IBN, bonded to the SPCB, and, outside of the system block, bonded to the CBN.

Sub-systems that are part of the system block should be located within one floor of the SPC of the main system. This avoids excessive voltage differences between the extremities of the IBN and nearby CBN.

Peripheral equipment that is to use an IBN and that is located more than one floor from the SPC of the main system shall use a dedicated SPC that is within one floor. The equipment shall be powered through an isolation barrier, e.g., by using DC/DC or AC/DC converters.

The isolation barrier inside any DC power equipment must have sufficient voltage withstand capability to meet local authority requirements. Installation and wiring of converters should comply with these isolation requirements.

Framework of equipment, and metal structural components, in a CBN that is located within two metres of an IBN should be bonded to the SPCB for reasons of personnel safety.

Other equipment that is in the telecommunication building, and that uses the mesh-BN configuration, is installed using the techniques of clause B.1, with or without an isolated DC return.

B.3.3 Maintainability of isolated bonding networks

IBNs need careful installation and ongoing surveillance to assure isolation. Also, the use of an isolated DC power return may require ongoing monitoring to check its isolation, especially if maintenance work is performed on different or mixed configurations by the same personnel. Violation of isolation during, or as a consequence of, maintenance work, may lead to failures in system operation or even to physical damage during lightning or power fault events.

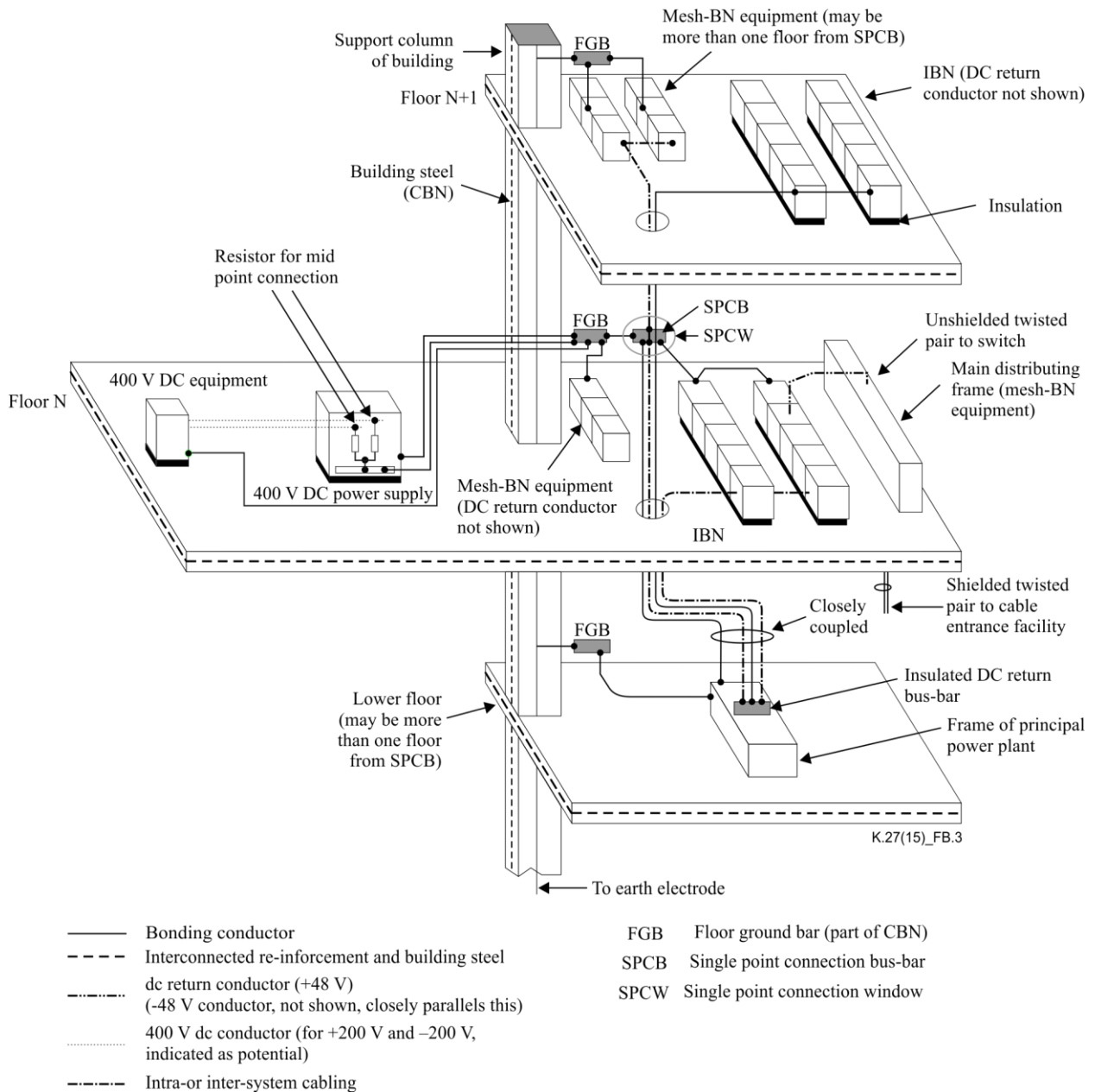

Figure B.3 – Star-IBN with isolation of DC power return

Bibliography

- [b-Keiser] Keiser, B.E. (1987), *Principles of Electromagnetic Compatibility*, 3rd edition, Norwood, MA, Artech House.

SERIES OF ITU-T RECOMMENDATIONS

Series A	Organization of the work of ITU-T
Series D	General tariff principles
Series E	Overall network operation, telephone service, service operation and human factors
Series F	Non-telephone telecommunication services
Series G	Transmission systems and media, digital systems and networks
Series H	Audiovisual and multimedia systems
Series I	Integrated services digital network
Series J	Cable networks and transmission of television, sound programme and other multimedia signals
Series K	Protection against interference
Series L	Construction, installation and protection of cables and other elements of outside plant
Series M	Telecommunication management, including TMN and network maintenance
Series N	Maintenance: international sound programme and television transmission circuits
Series O	Specifications of measuring equipment
Series P	Terminals and subjective and objective assessment methods
Series Q	Switching and signalling
Series R	Telegraph transmission
Series S	Telegraph services terminal equipment
Series T	Terminals for telematic services
Series U	Telegraph switching
Series V	Data communication over the telephone network
Series X	Data networks, open system communications and security
Series Y	Global information infrastructure, Internet protocol aspects and next-generation networks
Series Z	Languages and general software aspects for telecommunication systems