

International Telecommunication Union

ITU-T

TELECOMMUNICATION
STANDARDIZATION SECTOR
OF ITU

K.83

(01/2022)

SERIES K: PROTECTION AGAINST INTERFERENCE

Monitoring of electromagnetic field levels

Recommendation ITU-T K.83

ITU-T



Recommendation ITU-T K.83

Monitoring of electromagnetic field levels

Summary

Recommendation ITU-T K.83 gives guidance on how to make long-term measurements for the monitoring of electromagnetic fields (EMF) in the selected areas that are under public concern, in order to show that EMFs are under control and under the limits. The purpose of this Recommendation is to provide the general public, clear and easily available data concerning electromagnetic field levels in the form of results of continuous measurement.

History

Edition	Recommendation	Approval	Study Group	Unique ID*
1.0	ITU-T K.83	2011-03-09	5	11.1002/1000/11037
1.1	ITU-T K.83 (2011) Amd.1	2014-07-29	5	11.1002/1000/12224
2.0	ITU-T K.83	2020-06-29	5	11.1002/1000/14295
3.0	ITU-T K.83	2022-01-13	5	11.1002/1000/14875

Keywords

EMF, EMF monitoring system.

* To access the Recommendation, type the URL <http://handle.itu.int/> in the address field of your web browser, followed by the Recommendation's unique ID. For example, <http://handle.itu.int/11.1002/1000/11830-en>.

FOREWORD

The International Telecommunication Union (ITU) is the United Nations specialized agency in the field of telecommunications, information and communication technologies (ICTs). The ITU Telecommunication Standardization Sector (ITU-T) is a permanent organ of ITU. ITU-T is responsible for studying technical, operating and tariff questions and issuing Recommendations on them with a view to standardizing telecommunications on a worldwide basis.

The World Telecommunication Standardization Assembly (WTSA), which meets every four years, establishes the topics for study by the ITU-T study groups which, in turn, produce Recommendations on these topics.

The approval of ITU-T Recommendations is covered by the procedure laid down in WTSA Resolution 1.

In some areas of information technology which fall within ITU-T's purview, the necessary standards are prepared on a collaborative basis with ISO and IEC.

NOTE

In this Recommendation, the expression "Administration" is used for conciseness to indicate both a telecommunication administration and a recognized operating agency.

Compliance with this Recommendation is voluntary. However, the Recommendation may contain certain mandatory provisions (to ensure, e.g., interoperability or applicability) and compliance with the Recommendation is achieved when all of these mandatory provisions are met. The words "shall" or some other obligatory language such as "must" and the negative equivalents are used to express requirements. The use of such words does not suggest that compliance with the Recommendation is required of any party.

INTELLECTUAL PROPERTY RIGHTS

ITU draws attention to the possibility that the practice or implementation of this Recommendation may involve the use of a claimed Intellectual Property Right. ITU takes no position concerning the evidence, validity or applicability of claimed Intellectual Property Rights, whether asserted by ITU members or others outside of the Recommendation development process.

As of the date of approval of this Recommendation, ITU had not received notice of intellectual property, protected by patents/software copyrights, which may be required to implement this Recommendation. However, implementers are cautioned that this may not represent the latest information and are therefore strongly urged to consult the appropriate ITU-T databases available via the ITU-T website at <http://www.itu.int/ITU-T/ipr/>.

© ITU 2022

All rights reserved. No part of this publication may be reproduced, by any means whatsoever, without the prior written permission of ITU.

Table of Contents

	Page
1	Scope 1
2	References..... 1
3	Definitions 1
4	Abbreviations and acronyms 4
5	Physical quantities, units, and constants..... 4
6	General process..... 4
6.1	Description of the general method 5
6.2	Exposure limits 6
7	Frequency selective measurement procedure 7
7.1	Frequency sub-ranges 7
7.2	Automatic level range determination 7
7.3	Measurement of frequency bands..... 7
7.4	Measurement of special services 8
7.5	Result evaluation 8
7.6	Measurement equipment, general requirements..... 8
7.7	Measurement probe 9
7.8	Measurement instrument 9
7.9	Measurement control 9
7.10	Mechanical and protective housing 9
8	Broadband measurement procedure 9
8.1	Measuring equipment 9
8.2	Measurement probe 10
8.3	Measurement instrument 10
8.4	Protection..... 10
8.5	Measurement method 10
8.6	Measurement of exposure to multiple sources or frequencies 11
9	Uncertainty 11
10	Report on the measurement results..... 12
	Appendix I – Links to the official websites with results of the EMF monitoring 14
	Appendix II – Examples of the existing websites with EMF monitoring results 18
II.1	EMF monitoring system in Serbia..... 18
II.2	EMF monitoring system in Korea (Republic of)..... 19
II.3	EMF monitoring system in Panama 21
II.4	EMF monitoring system in Uruguay 22
II.5	EMF monitoring system in Colombia 22
II.6	EMF monitoring system in France 23
II.7	EMF monitoring system in Greece..... 25

	Page
II.8 EMF monitoring system in Italy.....	30
II.9 EMF monitoring system in Catalonia (Spain).....	31
II.10 EMF monitoring system in Poland.....	32
Bibliography.....	34

Introduction

Recommendation ITU-T K.83 presents the basis for the implementation of continuous measurement systems for electromagnetic emissions, in order to constitute a common practice at the international level for these types of continuous measurements.

Electromagnetic fields are imperceptible and unknown to the general public. This unawareness and imperceptibility generate distrust and rejection among the population, which can result in social conflicts and lead to delays in the deployment of new wireless technologies.

One solution to these problems can be the control of the electromagnetic emissions by taking measurements and having proper communication. Measurements turn emissions into something objective and, when presented to the public in an understandable format it helps diminish the unawareness and helplessness of the public.

The measurements of electromagnetic fields described in this Recommendation meet three requirements: must be objective, reliable, and continuous. The objectivity of the measurements is achieved whenever a public and/or independent body carries out the taking of the measurements and manages their publication. Reliability derives from compliance with international norms and standards regarding the measurement of electromagnetic fields and by an accredited calibration of the measuring equipment. The continuous taking of objective and reliable measurements (24/365) provides permanent monitoring of emissions and maximum transparency.

For years, in various parts of the world, broadband systems have been used for the continuous measurement of electromagnetic fields with satisfactory results, increasing citizens' confidence in governments and reducing their fear and ignorance regarding electromagnetic emissions. An alternative is the frequency selective measurement systems which should be applied to meet particular requirements. Other Recommendations, such as [b-ITU-T K.52], [b-ITU-T K.61] and [b-ITU-T K.70], provide guidance on measurement methods that can be used to achieve a compliance assessment as these are also effective approaches to reduce concerns that have been undertaken by some countries.

Recommendation ITU-T K.83

Monitoring of electromagnetic field levels

1 Scope

This Recommendation specifies the methods and characteristics of the monitoring system to be used for the continuous monitoring of electromagnetic fields emitted by radio transmitters, both in broadband and in frequency selective measurement systems, in order to assess the long-term exposure of people to electromagnetic fields in the band of 9 kHz-300 GHz.

2 References

The following ITU-T Recommendations and other references contain provisions which, through reference in this text, constitute provisions of this Recommendation. At the time of publication, the editions indicated were valid. All Recommendations and other references are subject to revision; users of this Recommendation are therefore encouraged to investigate the possibility of applying the most recent edition of the Recommendations and other references listed below. A list of the currently valid ITU-T Recommendations is regularly published. The reference to a document within this Recommendation does not give it, as a stand-alone document, the status of a Recommendation.

- [ITU-T K.113] Recommendation ITU-T K.113 (2015), *Generation of radiofrequency electromagnetic field level maps*.
- [EN 50413] BS EN 50413:2019, *Basic standard on measurement and calculation procedures for human exposure to electric, magnetic and electromagnetic fields (0 Hz - 300 GHz)*.
- [IEC 62232] IEC 62232:2017, *Determination of RF field strength, power density and SAR in the vicinity of radiocommunication base stations for the purpose of evaluating human exposure*.
- [IEC 62311] IEC 62311:2019, *Assessment of electronic and electrical equipment related to human exposure restrictions for electromagnetic fields (0 Hz-300 GHz)*.
- [IEEE C95.3] IEEE C95.3-2021, *IEEE Recommended Practice for Measurements and Computations of Electric, Magnetic, and Electromagnetic Fields with Respect to Human Exposure to Such Fields, 0 Hz to 300 GHz*.
- [ISO/IEC Guide] ISO/IEC Guide 98-3:2008 – *Uncertainty of measurement – Part 3: Guide to the expression of uncertainty in measurement (GUM:1995)*.

3 Definitions

This Recommendation defines the following terms:

3.1 averaging time (t_{avg}): Appropriate time over which exposure is averaged for purposes of determining compliance with the limits.

3.2 electric field strength (E): Magnitude of a field vector at a point that represents the force (F) on a small test charge (q) divided by the charge:

$$E = \frac{F}{q}$$

The electric field strength is expressed in units of volt per metre (V/m).

3.3 exposure: Exposure occurs whenever a person is exposed to electric, magnetic, or electromagnetic fields.

3.4 exposure ratio: The assessed exposure parameter at a specified location for each operating frequency of a radio source, expressed as the fraction of the related limit.

For assessments against reference levels [b-ICNIRP 1998]:

Between 9 kHz and 10 MHz:

$$ER = MAX \left[\left(\frac{E}{EL} \right), \left(\frac{H}{HL} \right) \right]$$

Between 100 kHz and 300 GHz:

$$ER = MAX \left[\left(\frac{E}{EL} \right)^2, \left(\frac{H}{HL} \right)^2 \right]$$

or between 10 MHz and 300 GHz:

$$ER = \left(\frac{S}{SL} \right)$$

where:

ER is the exposure ratio at each operating frequency for the source

EL is the investigation E-field limit at frequency *f*

HL is the investigation H-field limit at frequency *f*

SL is the equivalent plane-wave power density limit at frequency *f*

E is the assessed E-field at frequency *f* for the source

H is the assessed H-field at frequency *f* for the source

S is the assessed equivalent plane-wave power density at frequency *f* for the source

f is each operating frequency of the source

ER is applicable to limits based on the national regulations, or if they are not defined in the International Commission on Non-Ionizing Radiation Protection (ICNIRP) principles.

3.5 far-field region: Region of the field of an antenna where the radial field distribution is essentially dependent inversely on the distance from the antenna. In this region, the field has a predominantly plane-wave character, i.e., locally uniform distribution of electric field and magnetic field in planes transverse to the direction of propagation.

NOTE – In the far-field region, the vectors of the electric field *E* and the magnetic field *H* are perpendicular to each other, and the quotient between the value of the electric field strength *E* and the magnetic field strength *H* is constant and equals the impedance of free space Z_0 .

3.6 impedance of free space: The impedance of free space Z_0 is defined as the square root of the free space permeability μ_0 divided by the permittivity of free space ϵ_0 :

$$Z_0 = \sqrt{\frac{\mu_0}{\epsilon_0}} \approx 120\pi \cdot \Omega \approx 377\Omega$$

3.7 linearity: Maximum deviation over the measurement range of the measured quantity from the closest linear reference curve defined over the range.

3.8 magnetic field strength (H): The magnitude of a field vector in a point that results in a force (F) on a charge q moving with the velocity v :

$$F = q(v \times \mu H)$$

The magnetic field strength is expressed in units of amperes per meter (A/m).

3.9 modulation: The process of modifying the amplitude, phase and/or frequency of a periodic waveform to convey information.

3.10 near-field region: Region generally in proximity to an antenna or other radiating structure, in which the electric and magnetic fields do not have a substantially plane-wave character but vary considerably from point to point. The near-field region is further subdivided into the reactive near-field region, which is closest to the radiating structure and that contains most or nearly all of the stored energy, and the radiating near-field region where the radiation field predominates over the reactive field but lacks substantial plane-wave character and is complex in structure.

3.11 permeability (μ): Magnetic permeability of a material is defined by the magnetic flux density B divided by the magnetic field strength H :

$$\mu = \frac{\|\vec{B}\|}{\|\vec{H}\|}$$

where μ is the permeability of the medium expressed in henry per metre (H/m).

3.12 permittivity (ϵ): Property of a dielectric material (e.g., biological tissue). In the case of an isotropic material, it is defined by the electrical flux density D divided by the electrical field strength E :

$$\epsilon = \frac{\|\vec{D}\|}{\|\vec{E}\|}$$

The permittivity is expressed in units of farads per metre (F/m).

3.13 power density (S): Radiant power incident perpendicular to a surface, divided by the area of the surface. The power density is expressed in units of watt per square metre (W/m²).

3.14 relevant source: A radio source which at a given measurement point, has an exposure ratio larger than 0.05.

3.15 root mean square (rms): Effective value or rms value obtained by taking the square root of the average of the square of the value of the periodic function taken throughout one period.

3.16 total exposure ratio (TER) [IEC 62232]: The total exposure ratio is the maximum value of the sum of exposure ratios of the equipment under test and all relevant sources over the frequency range 9 kHz to 300 GHz.

$$TER = ER_{EUT} + ER_{RS}$$

where:

ER_{EUT} is the assessed exposure ratio from the equipment under test

ER_{RS} is the assessed exposure ratio of all the relevant sources

3.17 unperturbed field: Field that exists in a space in the absence of a person or an object that could influence the field.

NOTE – The field measured or calculated with a person or object present may differ considerably.

4 Abbreviations and acronyms

This Recommendation uses the following abbreviations and acronyms:

CDMA	Code Division Multiple Access
DVB-T	Digital Video Broadcasting – Terrestrial
EMF	Electromagnetic Field
ER	Exposure Ratio
LTE	Long Term Evolution (4G)
NR	New Radio (5G)
RBW	Resolution Bandwidth
RMS	Root Mean Square
TER	Total Exposure Ratio
WCDMA	Wideband CDMA

5 Physical quantities, units, and constants

The internationally accepted SI-units are used throughout this Recommendation.

Quantity	Symbol	Unit	Dimension
Current density	J	ampere per square metre	A/m ²
Electric field strength	E	volt per metre	V/m
Electric flux density	D	coulomb per square metre	C/m ²
Frequency	f	hertz	Hz
Magnetic field strength	H	ampere per metre	A/m
Magnetic flux density	B	tesla (Vs/m ²)	T
Permeability	μ	henry per metre	H/m
Permittivity	ε	farad per metre	F/m
Wavelength	λ	metre	m
<i>Physical constant</i>		<i>Magnitude</i>	
Speed of light in a vacuum	c	2'997 × 10 ⁸ m/s	
Permittivity of free space	ε ₀	8'854 × 10 ⁻¹² F/m	
Permeability of free space	μ ₀	4π × 10 ⁻⁷ H/m	
Impedance of free space	Z ₀	377 ohms (approx. 120 πΩ)	

6 General process

This Recommendation defines the methods that shall be used to determine the total exposure ratio (TER) over a certain period to perform a time dependent evaluation of EMF exposure. Two methods are recommended: using the frequency selective measurement or using the broadband measurement.

The frequency selective measurement procedure is based on [EN 50413] and [IEC 62311].

The broadband measuring method is based on [EN 50413] and [IEC 62311]. It allows obtaining the total radiation level in the form of electric field strength (E) in the frequency band of interest, averaged over a certain period. If the measurement is performed in the near-field region, then the evaluation of the total radiation level for the magnetic field strength (H) is necessary.

This method is applicable in those cases where the total summation of the emissions of a said frequency band is required to be measured. It allows obtaining a rapid measure of the total emission level of the band at a low cost.

The broadband method should not be applied:

- If it is necessary to know the radiation levels by frequency.
- If the value given exceeds the minimum reference level in the frequency band to be measured.
- If the sensitivity of the equipment is not low enough to obtain a radiation value, but the legislation in force requires giving a radiation value.
- To measure frequencies under 100 kHz since the total summation of the emissions is not a valid method for these frequencies.

6.1 Description of the general method

The measurement is continuously and automatically carried out over the targeted frequency range operating in the considered area.

If the measurement is carried out within the reactive near field (distance $< \max(\lambda, D, D^2/(4\lambda))$ – where λ is the wavelength and D is the maximum size of the antenna) of the relevant emitters ($ER > 0.05$), the validity of the measurement result should be justified by a detailed analysis.

NOTE – For a distance of 10 m, the conditions for radiating near field or far field are met for all emitters above 30 MHz.

The range for low frequency measurements is from 0 Hz up to 100 kHz and the range for high frequency measurements is from 100 kHz up to 300 GHz [EN 50413].

In the case of low frequency fields, electric (E) and magnetic (H) fields must be assessed separately.

In the case of high frequency fields and far-field conditions, either electric (E), magnetic (H) or power density (S) may be used for the assessment.

In the case of near-field conditions, both electric (E) and magnetic (H) field components must be assessed.

Figure 1 gives an overview of the procedure for a site.

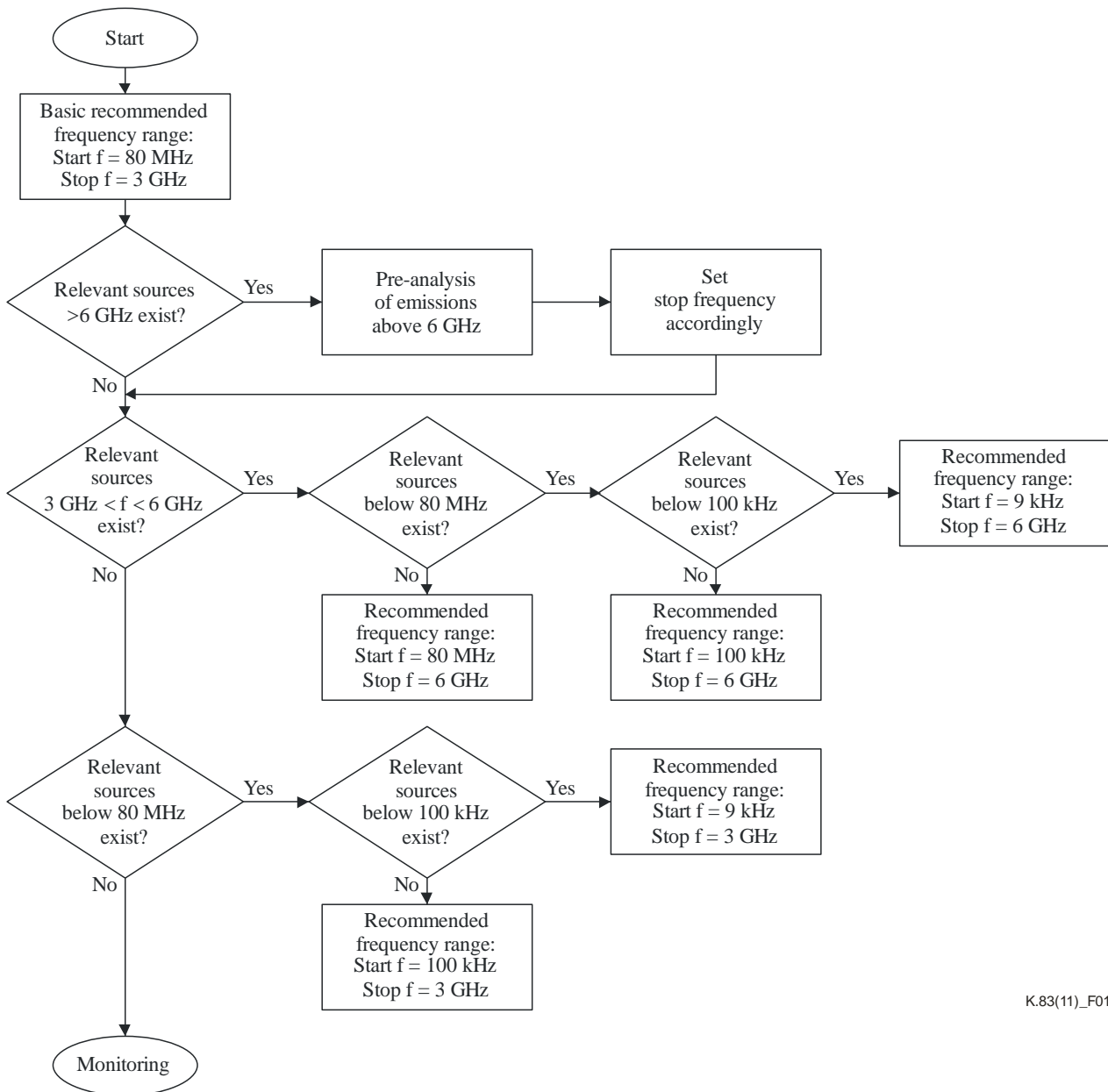

K.83(11)_F01

Figure 1 – Site evaluation procedure

6.2 Exposure limits

The limits for general public exposure specified in the national regulations, or if they do not exist in the ICNIRP, limits as well as conditions for simultaneous exposure to multiple frequency fields shall apply for the purposes of this Recommendation.

From such derived field strengths E_i , the TER for the complete frequency range is derived:

In the case of [b-ICNIRP 1998] guidelines, the total exposure ratio (TER) criteria refers to the electrical stimulation effects ($a = 87 \text{ V/m}$); El is the frequency dependent limit):

$$\sum_{i=1\text{Hz}}^{1\text{MHz}} \frac{E_i}{El_i} + \sum_{i=1\text{MHz}}^{10\text{MHz}} \frac{E_i}{a} \leq 1$$

The total exposure criteria refers to the thermal effect circumstances ($c = 87/f^{1/2}$ V/m, El is the frequency dependent limit):

$$\sum_{i=9\text{kHz}}^{1\text{MHz}} \left(\frac{E_i}{c} \right)^2 + \sum_{i=1\text{MHz}}^{300\text{GHz}} \left(\frac{E_i}{El_i} \right)^2 \leq 1$$

7 Frequency selective measurement procedure

The measurement consists of repeated measurement cycles, each representing one measurement result. Each cycle consists of the steps according to Figure 2.

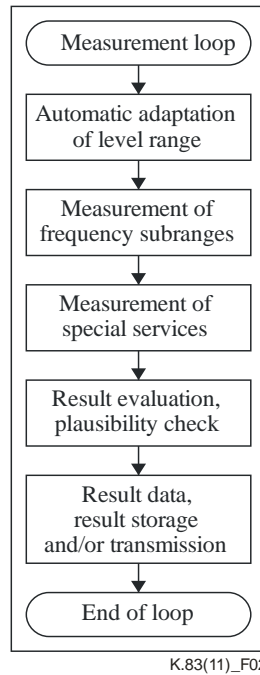

Figure 2 – Measurement loop

7.1 Frequency sub-ranges

The frequency range is divided into sub-ranges depending on the region.

For each sub-band, the maximum detectable level is at least the limit value. The minimum detectable level is required in case no emissions above the threshold value are present. It can be achieved with adopted settings of, e.g., attenuation, bandwidth. An instantaneous dynamic range of 60 dB must be achieved for each level setting. Another signal present in any other sub-range and bigger than 25% or at least 3 MHz off the measurement frequency must cause no overload or measurement error if its field strength is below the exposure limit.

7.2 Automatic level range determination

The parameters (e.g., attenuation, preamplifier) for each sub-range are adopted automatically during each cycle to achieve the best possible sensitivity without signal distortion due to overload (e.g., in preamplifiers, mixers) from other emitters in the same or other sub-bands.

7.3 Measurement of frequency bands

For each frequency band, the measurement should be done using a detector according to the national regulations. If there are no national regulations, then the RMS level should be used according to the ICNIRP guidelines. The measurement time for each band is chosen according to the typical time behaviour of the emitters. The measurement is repeated with increasing sensitivity (e.g., smaller

bandwidth) as long as no emission above and less than two emissions below the threshold are detected and the minimum detectable level is not reached. The noise floor of the measurement system is discriminated independent from the sensitivity setting and therefore not used as a measurement value.

7.4 Measurement of special services

Special services, e.g., broadband services such as wideband code division multiple access (WCDMA) and digital video broadcasting – terrestrial (DVB-T), signals with high crest factors and radar signals are measured with specific settings (at least zero span, measurement time and signal adopted bandwidth). Depending on the signal type, RMS or peak detector shall be used [IEC 62232].

A result value obtained here at a frequency f_0 replaces the swept measurement achieved in clause 7.3 in the frequency range $f_0 \pm \frac{1}{2}$ resolution bandwidth (RBW).

An extrapolation of the field strength at maximum traffic of a cellular network is not carried out.

7.5 Result evaluation

Measurement result consists of values achieved according to clauses 7.2 and 7.3 that fulfil the criteria of clause 6.2 stored as relevant emissions and used for the TER calculation.

For a plausibility check and the detection of unusual transmissions (e.g., broadband interferers), bandwidth and field strength limits can be defined for every frequency band. If the emission is outside the limit, a warning is added for the operator. In case no limit is defined for a frequency range, or the measurement is not possible (e.g., insufficient S/N for determination of occupied bandwidth), the plausibility check is skipped for this frequency. The next measurement cycle is started independently from the plausibility check result.

NOTE – In case of automatic data transmission and central data management, the plausibility check can also be centralized.

As additional information date, time, actual measurement position, ambient temperature and humidity, system status and warnings are added to the measurement result.

This result is stored internally (offline evaluation) or transmitted automatically via a data link to a server (online evaluation).

7.6 Measurement equipment, general requirements

The measurement equipment consists of the following parts:

- Measurement probe.
- Frequency selective measuring instrument, which processes the signal from the probe and indicates the value of the EM field quantity.
- Measurement automation.
- Mechanical and protective housing.

The system parameters, as defined in this clause, are valid for the completely assembled unit as installed on site.

The measurement equipment shall be calibrated as a complete system at the measurement frequencies according to [IEC 62232]. The calibration shall take into account the high crest factor of some signals or combinations of signals.

7.7 Measurement probe

Isotropic measurement shall be used to determine the field value used to assess the human exposure. The isotropy shall be analysed according to [IEC 62232], and the isotropy deviation shall be less than 2.5 dB in the frequency range up to 3 GHz and less than 3.5 dB for 3 to 6 GHz. In the extended frequency range 3 to 6 GHz and above, the isotropy may increase to 3.5 dB.

The measurement is carried out at a height of concern (typically 1.5 m above floor level). If the frequency range is split into more than one probe, field probes below 130 MHz may be mounted within a height range of 1.3 m to 1.7 m.

The size of each probe should be smaller than 150 mm. Interaction between the probes, radome and the measurement equipment shall be taken into account for isotropy, sensitivity and measurement uncertainty evaluation.

If active probes are used, 1 dB compression point must be higher than the measurement range.

7.8 Measurement instrument

The measurement range of the instrumentation is required to be in accordance with the field strengths to be measured. The sensitivity should be sufficient to determine the lowest level, to be measured within the accuracy at that level, as stated by the instrument's manufacturer. By a preselector, strong emissions in other frequency bands are suppressed. Preamplifiers shall be used only after the preselector to avoid unrecognized overload effects. The frequency range of the measuring equipment should be sufficient to cover the frequencies of the EM field sources to be characterized.

For the measurement of special services, the radio bandwidth should cover 10 Hz to 10 MHz, including channel filters for typical services, e.g., WCDMA, DVB-T, long term evolution (4G) (LTE), new radio (5G) (NR).

7.9 Measurement control

The measurement control shall monitor the system status. In case of a detected interruption in the measurement procedure, the system shall recover on its own, start the measurement cycle again and send out a warning. The results of the interrupted measurement cycle are deleted and the results of completed cycles stay valid. In case of a detected hardware failure, the measurement is set to invalid.

7.10 Mechanical and protective housing

The measuring equipment shall be appropriate to the environmental conditions (e.g., temperature, humidity, wind speed, vibration) to be expected during the monitoring period at the measurement site.

8 Broadband measurement procedure

8.1 Measuring equipment

To take the broadband measurement, the instrument to be used consists of an equipment that has a broadband probe and measures the electromagnetic field. This equipment will consist of:

- Broadband probe.
- Measurement instrument, which processes the signal from the probe and provides the measurement of the field strength.
- Protection.

It is essential that the measuring equipment must provide the RMS (*root mean square*) value of the electric field strength to compare the levels measured with the exposure limits.

The measuring equipment should be calibrated as a whole, and the said calibration should be registered.

8.2 Measurement probe

The broadband probe provides an independent measurement of the frequency, which integrates all of the emissions in the desired frequency band. One must use a broadband probe that covers the band of interest. This probe must be isotropic, and the isotropic deviation must be less than 2.5 dB for frequencies up to 3 GHz, and less than 3.5 dB for higher frequencies. Each one of the three field components must be measured possibly at the same time to have a correct total field result. Besides, the probe must have a dynamic range adapted to the levels that one wants to measure.

The deviation of the measurement due to the variation of the response of the probe with the frequency must be less than ± 3 dB for the interest frequency band.

The catchment area of the probe should be sufficiently separated from the readout unit through a high impedance connection and low permittivity materials that minimize the interaction between the field and the connection circuitry.

8.3 Measurement instrument

The function of the measurement instrument is to calculate the field level based on the information given by the probe. The sensitivity of the equipment must be sufficient to discriminate the minimum desired field level with adequate precision. Similarly, the dynamic range of the equipment should be adapted to the measurements to be taken.

The probe and the measurement instrument as a whole should provide the RMS (*root mean square*) value of the field strength.

Besides, the measurement instrument should manage the automation of the measurements for them to be continuous, with the sampling and the defined average periods. A sampling rate of at least one second is recommended and the average period should be six minutes, as specified by [b-ICNIRP 1998], and it should be continuous or "sliding" over time, to avoid losing data, as specified by [IEEE C95.3]. It should have an adequate storage capacity for measurements, which in any case should exceed one week.

It is also responsible for monitoring the status of the system, generating alarms in case of any anomaly in the operation.

8.4 Protection

The measuring equipment should be adapted to environmental conditions (temperature, humidity, rainfall, wind, etc.) that can be expected at the location point. To this end, we will employ a properly conditioned mechanical protection.

8.5 Measurement method

The procedure to be followed is:

8.5.1 Selection of the probe

Firstly, it is important to correctly choose the measurement probe, so that it should adapt to both the frequency margin and the necessary dynamic range of the field strength.

Probes offer absolute field values, without frequency information. It will be necessary to compare the obtained value, which is the total strength field of all the spectral components in the bandwidth to be measured, with the minimum value of the exposure limit. It is interesting to observe that the bandwidth of the probe should be adjusted as closely as possible to the bandwidth to be measured, so that the minimum exposure limit coincides with that of the frequencies that we want to measure.

8.5.2 Selection of the measurement site

The measurement should be taken at a height of concern (typically 1.5 m above the floor level). Thus, the measuring equipment should be located so that the catchment area of the probe is located at that height.

The measurement point should be chosen so that it represents the highest level of exposure that a person may be subjected to, taking into account all the possible sources of emissions. This maximum can be determined either empirically through a quick scan with a field measuring equipment, or by a calculation of the theoretical propagation from nearby transmitting antennas. It is important to keep the probe away from metal surfaces (several times the diameter of the probe) to avoid coupling effects that would distort the measurement.

The measured field value must correspond to the "undisturbed" field. This means, all possible influences of assembling on the field should be minimized. To this end, the equipment should be assembled on a non-conductive support, with low permittivity, and any possible metallic fittings should be far enough from the probe. Besides, one should take all the necessary measures so that while measuring any moving object or person may not approach the equipment.

8.5.3 Automatic taking of the measurements

The equipment should operate autonomously once it is put into operation. The same equipment will manage the taking of the measurements and its automation so that the measurements will be continuous and uninterrupted.

Field measurements should be an average of duration to be defined by the national regulations, or six minutes should be used according to the [b-ICNIRP 1998] guidelines. Each measurement should be stored in the equipment memory, pending to be recovered by the system manager.

8.6 Measurement of exposure to multiple sources or frequencies

Exposure to a single frequency is an ideal case. The most general case is that of the exposure to various sources or a single source with various frequencies. Considering this general case, it can, however, be easily proved mathematically that if the value measured by the equipment does not exceed the most restrictive exposure limit in the frequency band to be measured, then the contributions at different frequencies will also be below the said limit, since:

$$E_{tot} = \sqrt{\sum_{i=1}^n E_i^2}$$

9 Uncertainty

The uncertainties shall be estimated in compliance with methods described in [EN 50413], [IEC 62232], and [ISO/IEC Guide]. The contributions to the total uncertainty of the measurement can be obtained through the appropriate measurements performed on the equipment, or according to the manufacturer's specifications that can be taken as tolerances with the rectangular distribution.

The expanded uncertainty with a confidence interval of 95% [EN 50413], [IEC 62232], and [ISO/IEC Guide] shall not exceed 4 dB.

The contributions of each component of uncertainty shall be registered with their name, probability distribution, sensitivity coefficient and uncertainty value. The results shall be recorded in a table as described in Table 1. The combined uncertainty shall then be evaluated according to the following formula:

$$u_c = \sqrt{\sum_{i=1}^m c_i^2 \cdot u_i^2}$$

where c_i is the weighting coefficient (sensitivity coefficient). The expanded uncertainty shall be evaluated using a confidence interval of 95%. The coverage factor to be employed is 1.96, which is provided by the confidence interval of 95% for a near-normal distribution, typical in most measurements.

Table 1 gives a practical guideline to set up an uncertainty budget for EMF measurements.

There may be other uncertainties, which are not listed, and some of the listed uncertainties may not be present or may not be significant in the overall assessment.

Table 1 – Uncertainty assessment

Error sources	Description	Uncertainty value % uv_i	Probability distribution	Divisor k_i	c_i	Standard uncertainty % $u_i = uv_i/k_i$
Measurement equipment						
Calibration	[IEC 62232]		Normal	1 or k	1	
Isotropy	[IEC 62232]		Normal	1 or k	1	
Linearity	[IEC 62232]		Rectangular	$\sqrt{3}$	1	
Measurement device			Normal	1 or k	1	
Noise			Normal	1	1	
Mismatch	[IEC 62232]		U-shape	$\sqrt{2}$	1	
Influence of temperature and humidity on the measurement equipment	[IEC 62232]		Rectangular	$\sqrt{3}$	1	
Environmental parameters						
Perturbation by environment			Rectangular	$\sqrt{3}$	1	
Influence of the body	[IEC 62232]		Rectangular			
Post-processing						
Spatial averaging	[IEC 62232]		Rectangular	$\sqrt{3}$	1	
Combined standard uncertainty			$u_c = \sqrt{\sum_{i=1}^m c_i^2 \cdot u_i^2}$			
Expanded uncertainty (confidence interval of 95%)			Normal			$u_e = 1.96 \cdot u_c$

10 Report on the measurement results

As stated in the introduction, taking measurements is as important as the correct communication of the results to solve public concerns about electromagnetic radiation.

Therefore, when communicating the results of the measurements taken, the following aspects should be taken into account:

- **Comprehensibility:** Results should be clear and comprehensible for the general public, without excessive technicalities. It is important to show the results compared with the applicable limit values.

- **Accessibility:** Results should be published on the Internet, and access to them should be easy for the general public; that is to say, the link should be accessed from home pages and not from the inside pages of a website with a difficult access.
- **Details:** All the possible information about how the measurements are taken should be provided:
 - measurement location (by its geographical positioning on a map [ITU-T K.113]),
 - description of the measurement site,
 - date and time,
 - description of the measurement method: broadband, frequency selective, average time, position of the probe, etc.,
 - identify the measurement equipment,
 - record the calibration details for any instrumentation used,
 - identify who has done the assessment,
 - record when and where the assessment was performed,
 - record the relevant sources considered and associated parameters,
 - include the value of the parameters used in the assessment and any assumptions made,
 - record the results of the total exposure ratio measurements.

Appendix I

Links to the official websites with results of the EMF monitoring

(This appendix does not form an integral part of this Recommendation.)

As an example, Tables I.1 and I.2 contain an alphabetical list of the links to the official websites of the regulatory agencies in which the information with results of the EMF monitoring are presented. Table I.3 lists the links to the official websites of the regulatory agencies where results of EMF measurements are presented.

Table I.1 – Links to the websites with results of EMF monitoring (Governments)

Country	Institution	Website	Contact details
Argentine Republic	Universidad Nacional de La Plata	https://itma-cem.unlp.edu.ar	Calle 50 esq 115 Piso 3 (1900) La Plata, Argentina Telephone: 542 214 236 609 E-mail: monitorcem@cespi.unlp.edu.ar
Republic of Colombia	ANE (Agencia Nacional del Espectro) – National spectrum agency of Colombia	http://smrni.ane.gov.co/es/public/colombia/	Calle 93 # 17-45 Floor 4. Bogotá D.C. Postal code: 110221 Telephone: 57 16 000 030 E-mail: contactenos@ane.gov.co
Republic of El Salvador	ITU pilot project, SIGET (Superintendencia General de Electricidad y Telecomunicaciones)	http://rni.siget.gob.sv/ http://www.siget.gob.sv/rni http://www.siget.gob.sv/rni/cartas/ http://rni.siget.gob.sv/gmap/ElSalvador.html	Sexta décima Calle Poniente y 37Av. Sur #2001, Col. Flor Blanca, San Salvador, El Salvador Telephone: 503 22 574 438 E-mail: info@siget.gob.sv
Federal Republic of Germany	Federal network agency. Fourteen monitoring stations available on request and relocated after three months.	http://emf3.bundesnetzagentur.de/ams.html	Bundesnetzagentur Section 414 Postfach 80 01 D-55 003 Mainz E-mail: monitoring@bnetza.de
Hungary	National media and communications authority (NMIA)	http://emirpub-prod.nmhh.hu/pubrendszer-web/eszmog/meresiAdatok.jhtm	
Italy	ARPAE (Regional agency for the prevention, environment and energy)	https://www.arpae.it/ https://www.arpae.it/dettaglio_generale.asp?id=2618&idlivello=1534	Via Po, 5 – 40139 – Bologna (Bologna) Telephone: 05 16 223 811
State of Israel	Israel ministry of environmental protection	https://www.gov.il/he/departments/guides/radio_frequency_radiation?chapterIndex=4 http://www.monitem.co.il/gmap/index.html	Israel ministry of environmental protection https://www.ehf.org.il/he/radiation
Republic of Korea	Korea communications agency	http://118.37.76.251:9080/download.htm	760, Bitgaram-ro, Naju-si, Jeollanam-do, Korea

Table I.1 – Links to the websites with results of EMF monitoring (Governments)

Country	Institution	Website	Contact details
		this application is available for mobile phones.	Telephone: 82-61-350-1604 Mobile: 821 088 600 845 E-mail: geo0707@kca.kr
Republic of Panama	Autoridad Nacional de los Servicios Públicos, ASEP (Public services national authority)	http://170.82.247.23/es/public/asep-panama/	0816-01235, Zona 5 Panamá. Telephone: 50 75 084 500 E-mail: atencionalusuario@asep.gob.pa
Republic of Poland	Instytut Telekomunikacji – Państwowy Instytut Badawczy	https://si2pem.gov.pl/	ul. Szachowa 1 04-894 Warszawa Telephone.: 48 225 128 100 E-mail: info@itl.waw.pl
Romania	ANCOM http://www.ancom.org.ro	http://www.monitor-emf.ro/en/map/	2 Delea Noua Street Bucharest 3, Postal Code 030925, Bucharest, Romania Telephone: 03 72 845 845 (Free) Line: 08 00 855 855 E-mail: sesizare@ancom.org.ro
Spain – Catalonia	Generalitat de Catalunya (Telecommunication and information technologies centre)	http://governancaradioelectrica.gencat.cat/web/guest/home	Carrer de Salvador Espriu, 45-51 08908 L'Hospitalet de Llobregat Telephone: 935 574 000
Turkey	Bilgi Teknolojileri ve İletişim Kurumu (Information and communication technologies authority, ICTA)	http://ema-olcum.btk.gov.tr	Bilgi Teknolojileri ve İletişim Kurumu Eskişehir Yolu 10. Km No: 276 Posta Kodu: 06 530 Çankaya / Ankara Telephone: 03 122 947 200 https://www.btk.gov.tr/iletisim
Eastern Republic of Uruguay	URSEC (Communication services regulatory unit)	http://201.217.159.117:8085/gmap/index.html	www.ursec.gub.uy
Republic of Serbia	Regulatory agency for electronic communications and postal services	http://emf.ratel.rs/eng/index	RATEL Palmotićeve 2, 11103 Belgrade, Republic of Serbia Telephone: 01 13 242 673 E-mail: ratel@ratel.rs

Table I.2 – Links to the websites with results of EMF monitoring (non-Government)

Country	Institution	Website	Contact details
Principality of Andorra	Andorra telecom	https://www.andorratelecom.com/en/public-action/social-activity/electromagnetic-field/	https://www.andorratelecom.com/en/contact/
France & Belgium	Observatoire des Ondes (Exem)	https://www.observatoiredesondes.com/fr/carte-des-ondes/	EXEM, 39 Avenue Crampel 31400 Toulouse Telephone: 330 561 629 636
Greece	Mobile radiocommunications laboratory of the National Technical University of Athens (NTUA) and the radiocommunications laboratory of the Aristotle University of Thessaloniki	http://www.pedion24.gr/en/results_en.jsp	Mail address: Mobile Radiocommunicarion Lab 9, Iroon Polytechniou Str GR15773, Zografou campus Athens, Greece Telephone: 302 107 724 196 E-mail: pedion24@mobile.ntua.gr Fax: 302 107 723 851
Spain	Vitoria-Gasteiz city council	https://www.vitoria-gasteiz.org/wb021/was/contentoAction.do?lang=en&locale=en&idioma=en&uid=6a6e93ad11a9a62c81b7fd7	Ayuntamiento de Vitoria-Gasteiz Plaza España 1, 01001 Vitoria-Gasteiz. informacion@vitoria-gasteiz.org
Confederation of Switzerland	Cantons of Uri, Schwyz, Obwalden, Nidwalden, Luzern and Zug	http://e-smogmessung.ch/i4Def.aspx?tabindex=0&tabid=437	

Table I.3 – Links to websites with other EMF results (not monitoring)

Country	Institution	Website	Contact details
Federative Republic of Brazil	ANATEL	https://www.anatel.gov.br/dados/medicoes-de-campo-eletromagnetico	National telecommunication agency SAUS Q. 6 Bloco E 10º Andar Brasilia – DF – Brazil. Zip code 70070-940. Agostinho Linhares de Souza Filho / Stevan Grubisic E-mail: Linhares@anatel.gov.br / Stevan@anatel.gov.br
France	Agence Nationale des Fréquences	https://www.cartoradio.fr/#/	Agence Nationale des Fréquences 78 avenue du Général de Gaulle 94704 Maisons-Alfort.
Ireland	Commission for communications regulation (ComReg)	http://www.comreg.ie/licensing_and_services/nir.554.444.html <i>(Sample of sites measured yearly since. Initially 400 sites in 2003-04 and down to 40 sites in 2012.)</i>	Commission for communications regulation, One dockland central, Guild street, Dublin, D01 E4X0 Email: consumerline@comreg.ie
Spain	Ministry of economic affairs and digital transformation (Secretaría de Estado de Telecomunicaciones e Infraestructuras digitales)	https://geoportal.minetur.gob.es/VCTEL/vcne.do	P.º de la Castellana, 162. 28046 – Madrid Telephone: 34 912 582 852
United Kingdom of Great Britain and Northern Ireland	OFCOM	https://www.ofcom.org.uk/phones-telecoms-and-internet/coverage/mobile-operational-enquiries/audit-info	

Appendix II

Examples of the existing websites with EMF monitoring results¹

(This appendix does not form an integral part of this Recommendation.)

This appendix gives examples of the results presented in the websites dedicated to EMF monitoring.

II.1 EMF monitoring system in Serbia

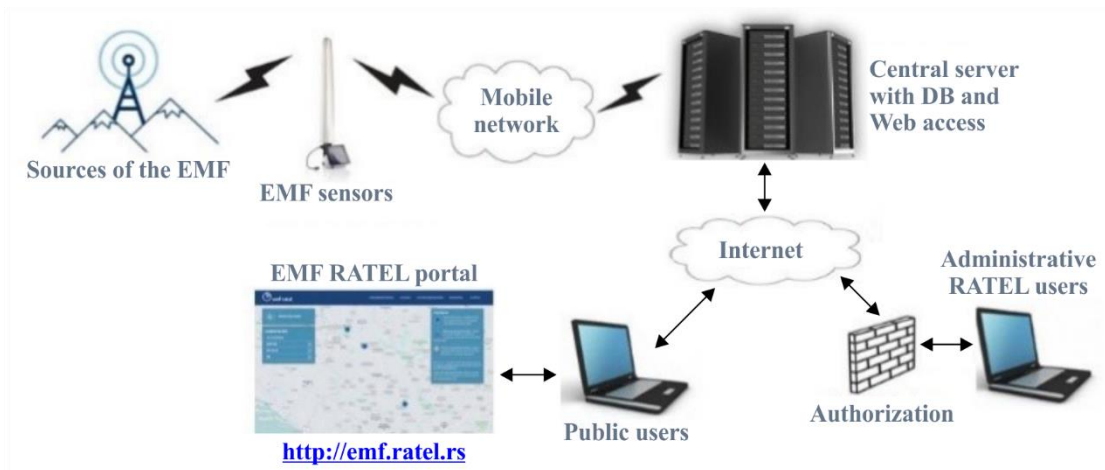

K.83(20)_FII.1

Figure II.1 – RATEL EMF monitoring system overview

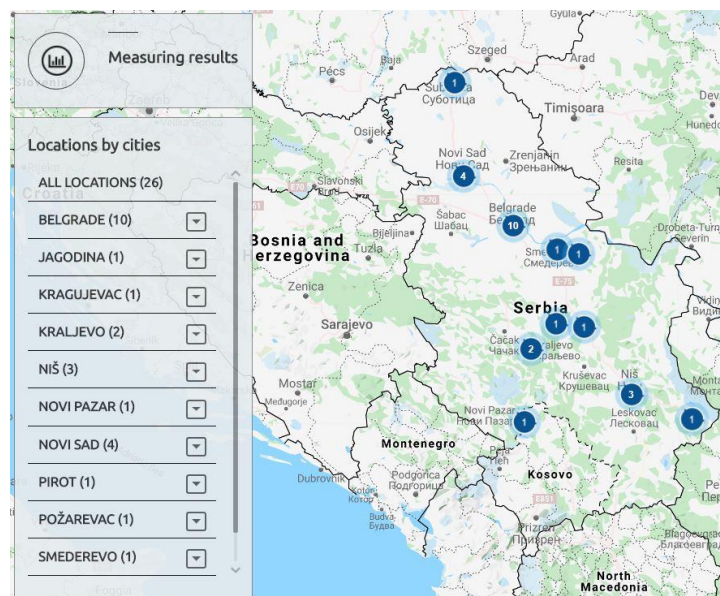

Figure II.2 – Measuring stations' positions on the interactive map

¹ The designations employed and the presentation of material of maps included in this appendix do not imply the expression of any opinion whatsoever on the part of ITU and of the Secretariat of the ITU concerning the legal status of the country, territory, city or area or its authorities, or concerning the delimitation of its frontiers or boundaries.



Figure II.3 – Student dormitory "4.april", Belgrade – Field and exposure levels

II.2 EMF monitoring system in Korea (Republic of)

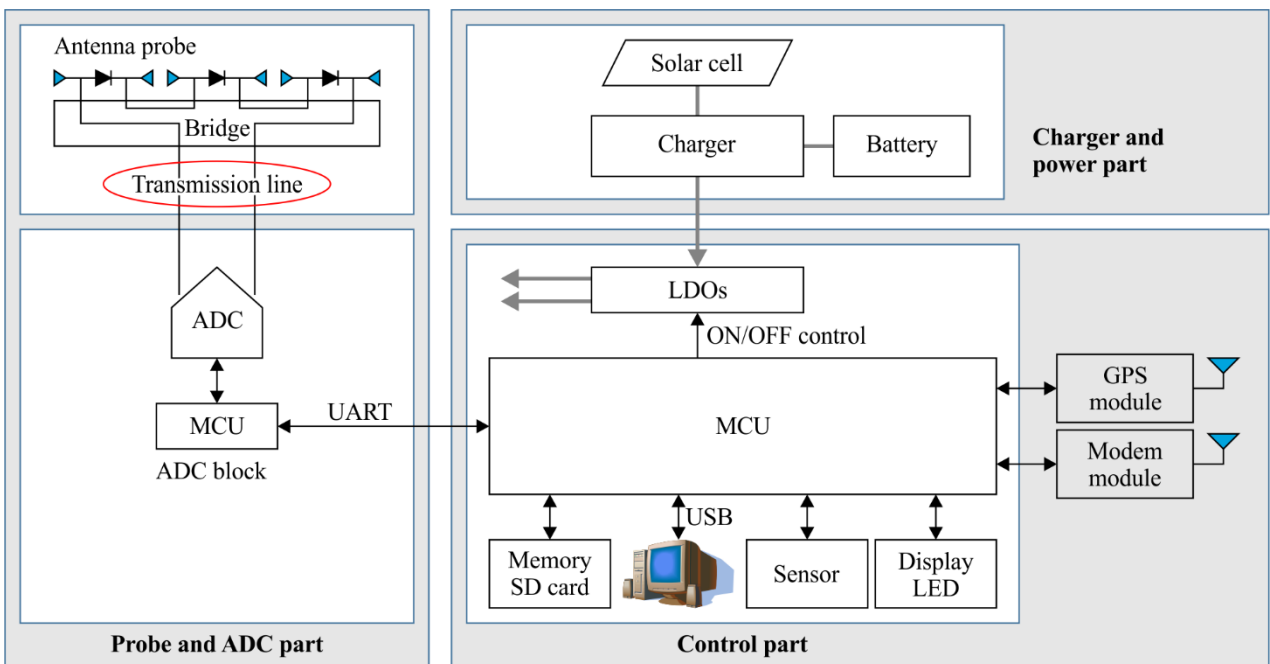

K.83(20)_FII.4

Figure II.4 – Broadband EMF area monitor block diagram

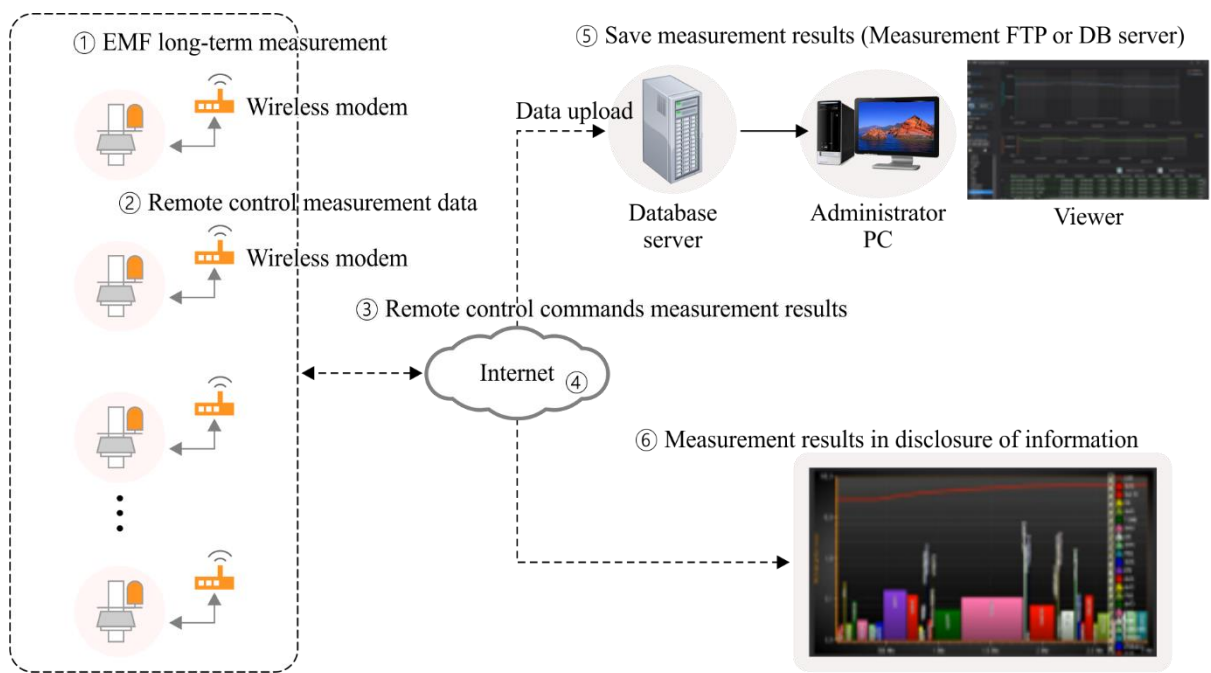

K.83(20)_FIL.5

Figure II.5 – Frequency selective EMF area monitoring architecture system

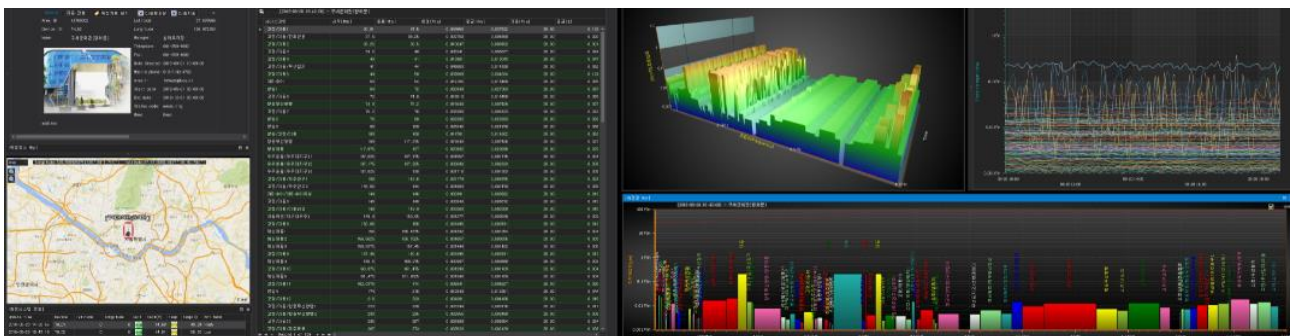

Figure II.6 – Frequency selective EMF monitoring analysis (Korea KCA)

II.3 EMF monitoring system in Panama

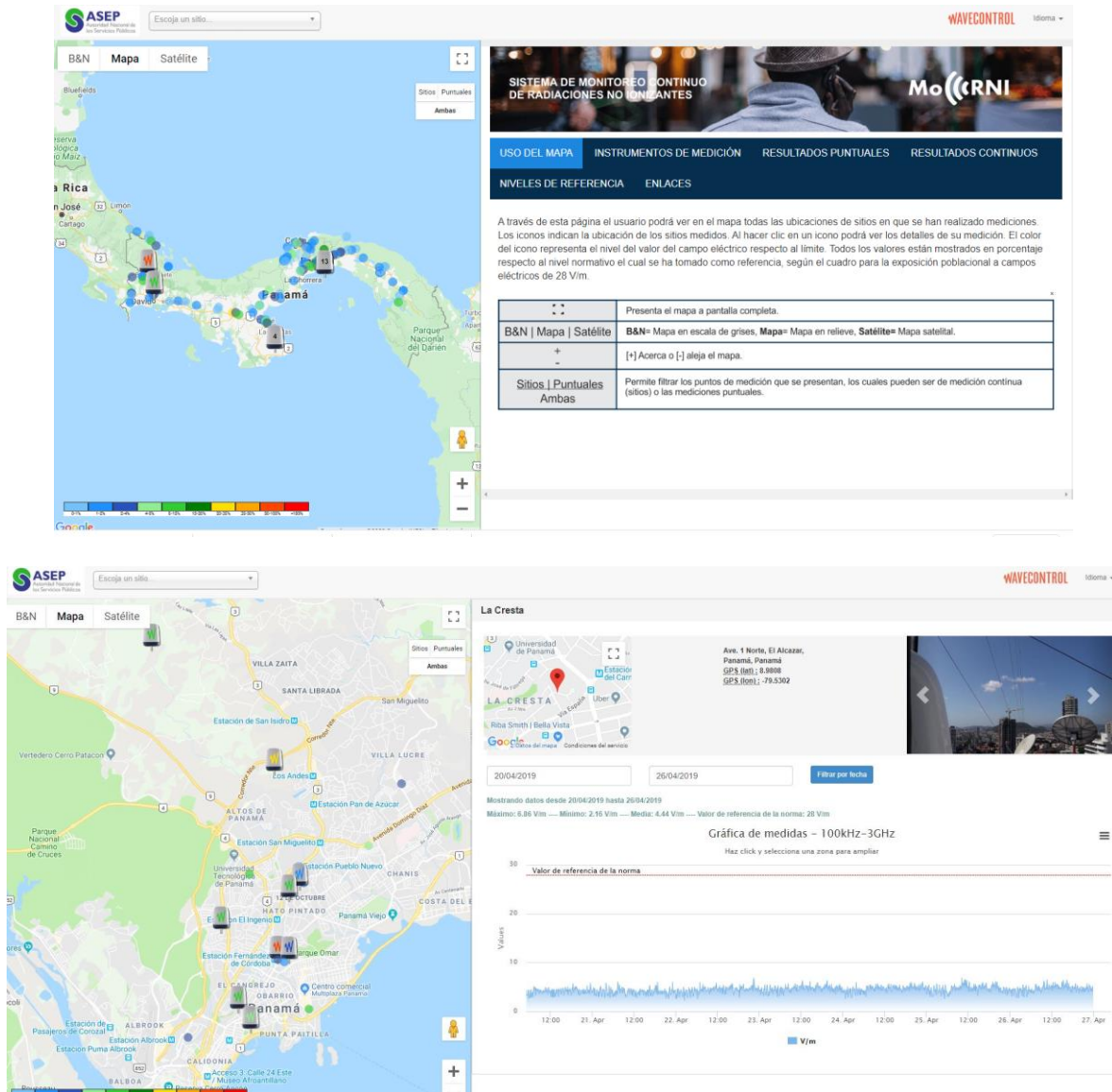

Figure II.7 – EMF monitoring system in Panama

II.4 EMF monitoring system in Uruguay

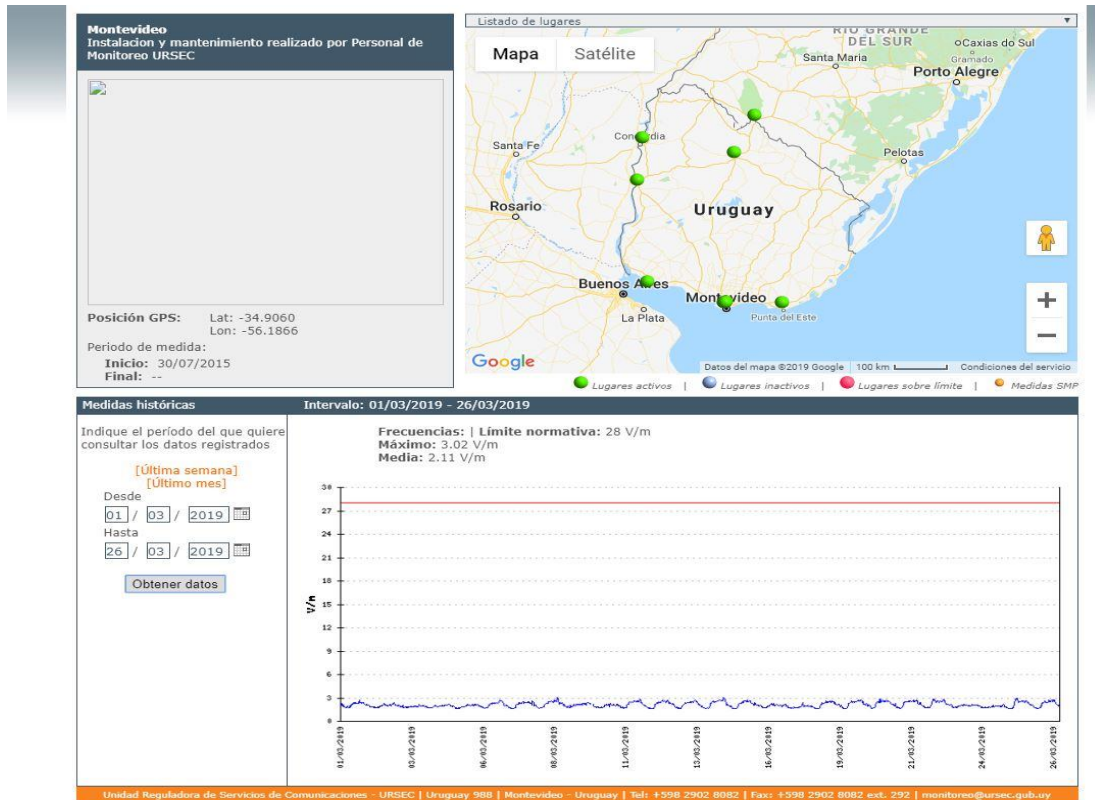

Figure II.8 – EMF monitoring system in Uruguay

II.5 EMF monitoring system in Colombia

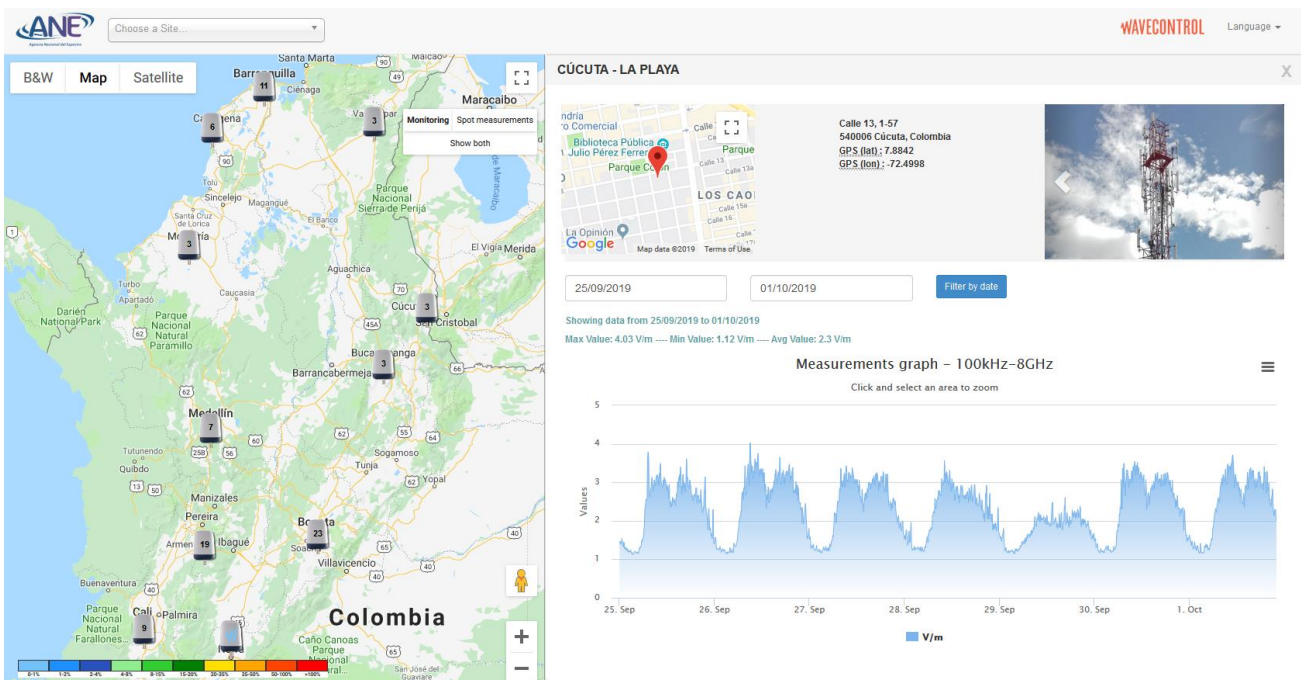

Figure II.9 – EMF monitoring system in Colombia

II.6 EMF monitoring system in France

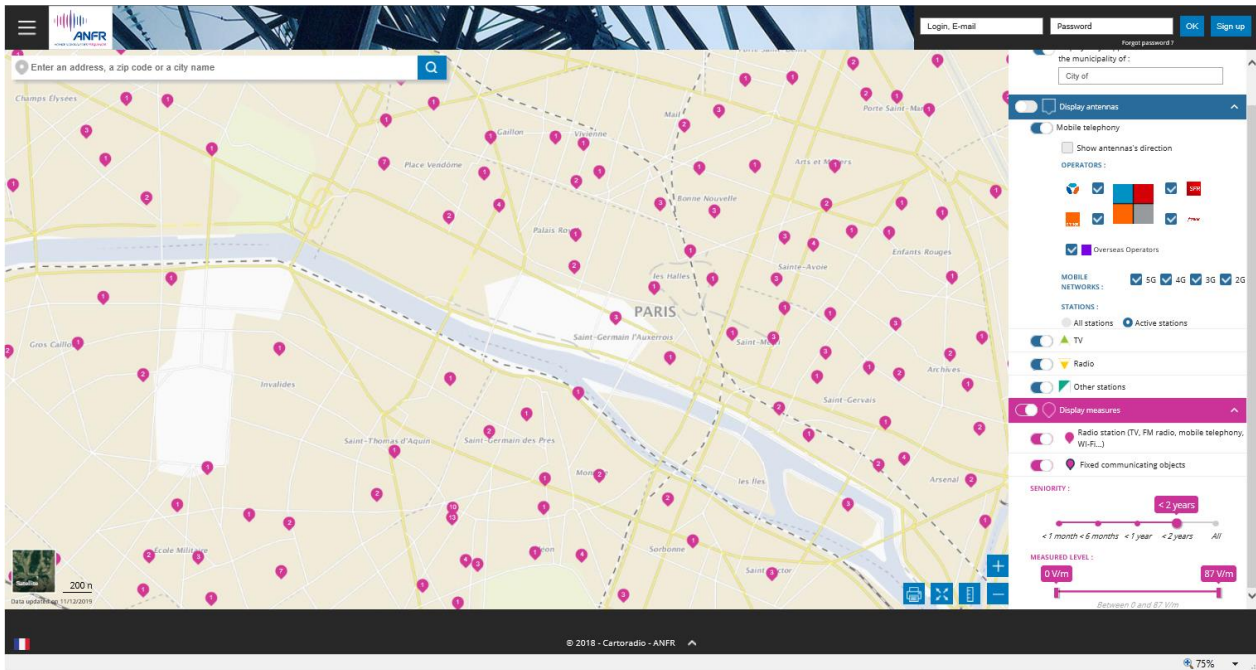

Figure II.10 – Screen with the location of the mobile base stations

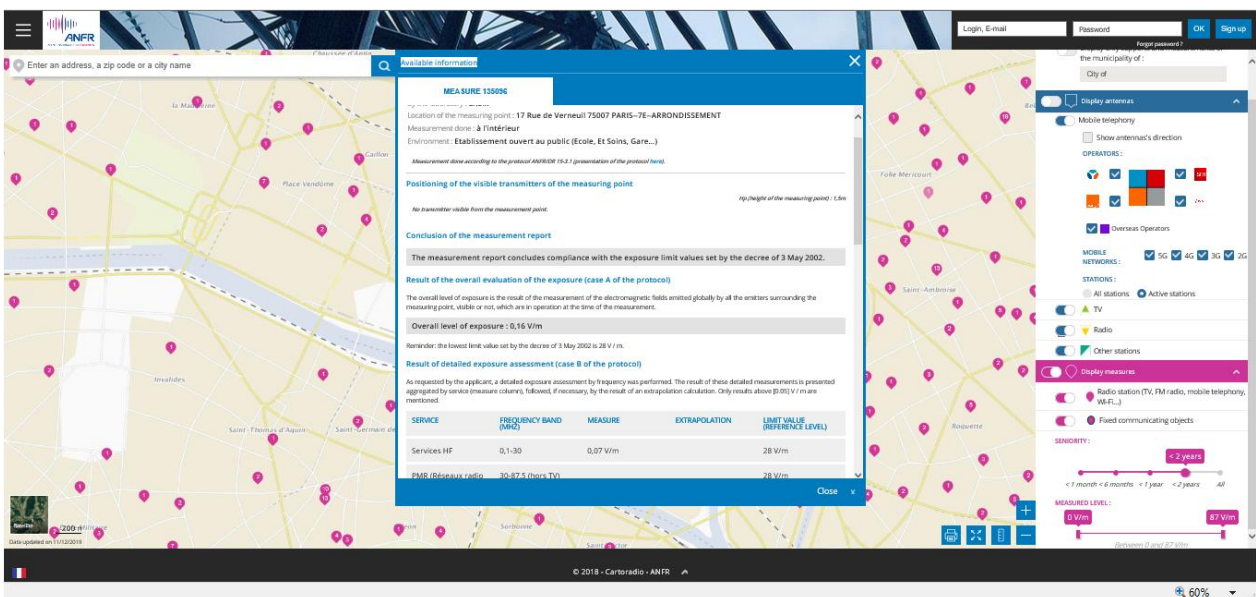

Figure II.11 – Example of the menu

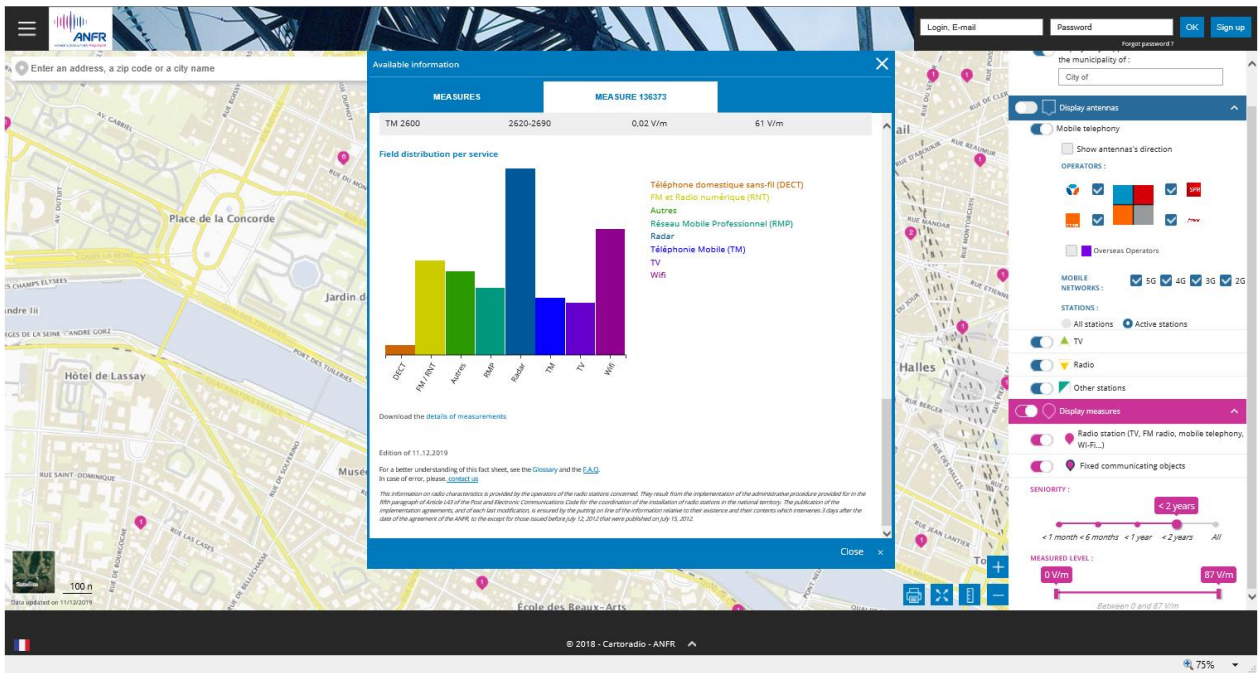

Figure II.12 – Example of the results of the EMF monitoring

II.7 EMF monitoring system in Greece

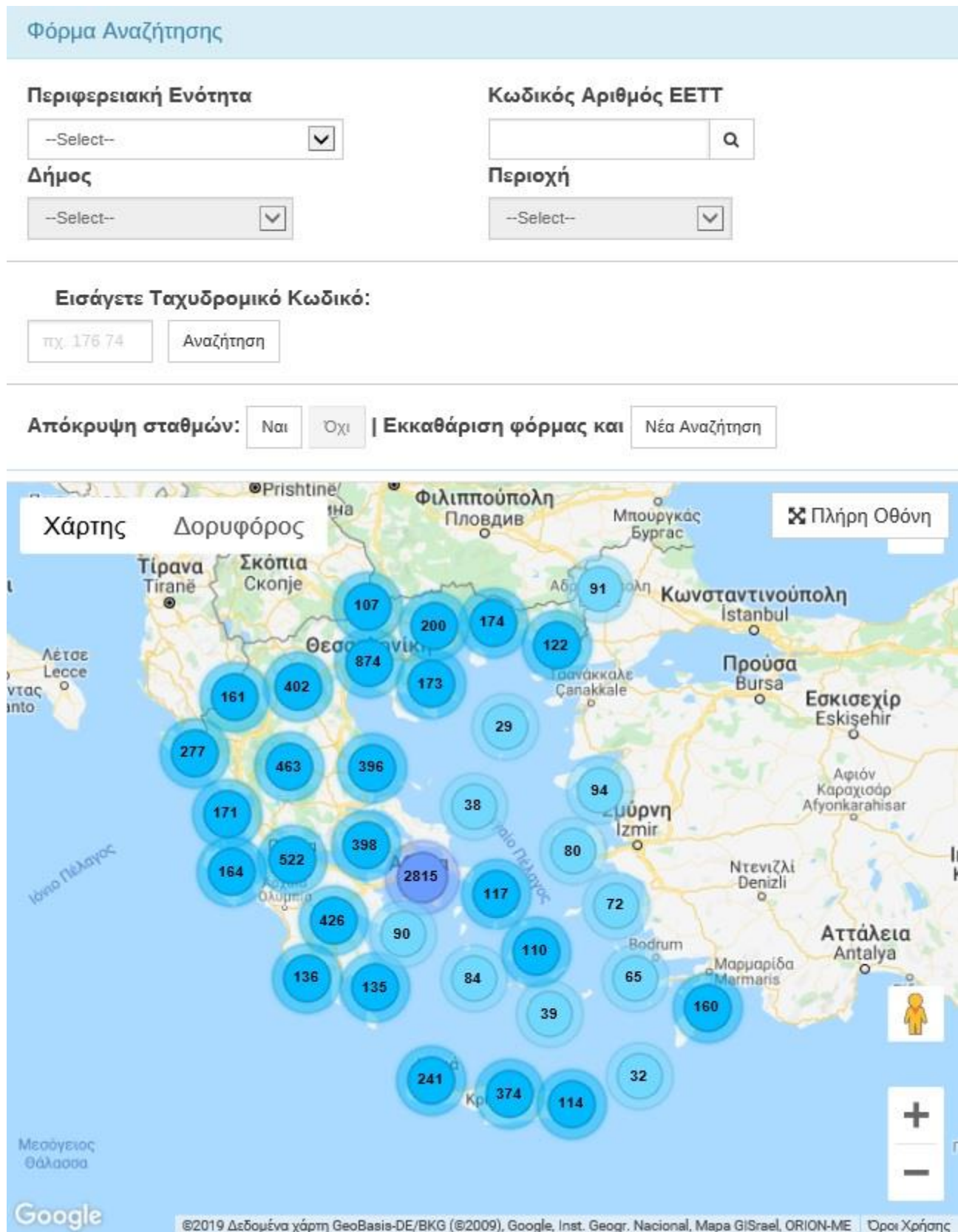

Figure II.13 – In situ measurement results available to the public

Φόρμα Αναζήτησης

Περιφερειακή Ενότητα
 ΠΕΙΡΑΙΩΣ

Κωδικός Αριθμός ΕΕΤΤ

Δήμος
 --Select--

Περιοχή
 --Select--

Εισάγετε Ταχυδρομικό Κωδικό:

Απόκρυψη σταθμών: Ναι Όχι | **Εκκαθάριση φόρμας και**

Πίνακας Αποτελεσμάτων

Κωδικός Αριθμός :	1400035
Κάτοχος :	COSMOTE - Κινητές Τηλεπικοινωνίες Α.Ε
Κωδική Ονομασία :	PENTHS
Διεύθυνση :	ΕΠΙ ΤΗΣ ΛΕΩΦ. ΘΗΒΩΝ
T.K. :	18543
Αδειοδότηση :	Δείτε τα στοιχεία της αδειοδότησης

Μέτρηση στις 23.12.2009

Μέτρηση στις 24.10.2015

Μέτρηση στις 03.10.2017

Κωδικός Αριθμός :	1200049
Κάτοχος :	WIND ΕΛΛΑΣ Τηλεπικοινωνίες ΑΕΒΕ
Κωδική Ονομασία :	ΚΕΡΑΤΣΙΝΙ 2
Διεύθυνση :	ΓΡΗΓ. ΛΑΜΠΡΑΚΗ 382 ΓΑΛΙΛΑΙΟΥ
T.K. :	18758
Αδειοδότηση :	Δείτε τα στοιχεία της αδειοδότησης

Μέτρηση στις 01.07.2008

Μέτρηση στις 02.03.2012

Μέτρηση στις 25.11.2018

Κωδικός Αριθμός :	1400030
Κάτοχος :	COSMOTE - Κινητές Τηλεπικοινωνίες Α.Ε
Κωδική Ονομασία :	ΚΕΡΑΤΣΙΝΙ T/K
Διεύθυνση :	ΙΠΠΟΚΡΑΤΟΥΣ 5-7
T.K. :	18756
Αδειοδότηση :	Δείτε τα στοιχεία της αδειοδότησης

Μέτρηση στις 01.07.2008

Μέτρηση στις 17.11.2010

Μέτρηση στις 24.11.2018

Κωδικός Αριθμός :	1014148
Κάτοχος :	VODAFONE
Κωδική Ονομασία :	ΑΦΕΝΤΟΥΛΙ AVE
Διεύθυνση :	Λ. ΑΦΕΝΤΟΥΛΗ 20Α ΠΕΙΡΑΙΑΣ
T.K. :	18536

Figure II.14 – Map with location of the EMF sources



ΕΤΟΙΧΕΙΑ ΣΤΑΘΜΟΥ

Παραγωγή σταθμού Κατόπιν συνάντησης, που πραγματοποιήθηκε από την εταιρεία SHINE TECHNOLOGIES ΟΕ διαπιστώθηκε ότι στη συμβολή των οδών ΓΡΗΓ. ΛΑΜΠΡΑΚΗ 382 ΚΑΙ ΓΑΛΛΙΑΔΟΥ, στα όρια Κορασιένου - Δραπετσώνος, στα νομό ΑΤΤΙΚΗΣ, στην ταρτίνα εγκατάστασης υπάρχει υπάρχουσα εγκατάσταση παραδοσιακής παραμόρφωσης κρητικής τεχνολογίας της εταιρείας WIND ΕΛΛΑΣ ΑΕΕΕ και άλλου ταρτίνα. Αποφασίστηκε να αφαιρεθεί ένα στην εν λόγω θέση διαπιστώθηκε η ύπαρξη 1 καλύτερης εγκατάστασης, γύρω από άξονα 2.5 ταρτίνα μέτρα.

Προγραμματισμένους μετρήσεις στις ακόλουθα σημεία παρατηρούνται στα σταθμούς:

- Σταθμό 1** Στην ταρτίνα εγκατάστασης κέρσης στην οδό Ανε. Μήτρικου 108, σε οριζόντια αντίσταση 25 ταρτίνα μέτρων βόρεια βορειοανατολικά από το κερματοστάσιο της εταιρείας WIND ΕΛΛΑΣ ΑΕΕΕ.
- Σταθμό 2** Στην ταρτίνα εγκατάστασης κέρσης στην οδό Ανε. Μήτρικου 108, σε οριζόντια αντίσταση 25 ταρτίνα μέτρων βόρεια από το κερματοστάσιο της εταιρείας WIND ΕΛΛΑΣ ΑΕΕΕ.
- Σταθμό 3** Στην ταρτίνα βόρεια κέρσης στην οδό Ανε. Μήτρικου 112, σε οριζόντια αντίσταση 25 ταρτίνα μέτρων βόρεια βορειοανατολικά από το κερματοστάσιο της εταιρείας WIND ΕΛΛΑΣ ΑΕΕΕ.
- Σταθμό 4** Στην ταρτίνα δυτική κέρσης στην οδό Γαλιάνου 2, σε οριζόντια αντίσταση 40 ταρτίνα μέτρων νότια νοτιοδυτικά από το κερματοστάσιο της εταιρείας WIND ΕΛΛΑΣ ΑΕΕΕ.
- Σταθμό 5** Επί του εδάφους, στην οδό Γρ. Αχαρνών 337, σε οριζόντια αντίσταση 40 ταρτίνα μέτρων ανατολικά νοτιοανατολικά από το κερματοστάσιο της εταιρείας WIND ΕΛΛΑΣ ΑΕΕΕ.
- Σταθμό *** Στην ταρτίνα δυτική κέρσης στην οδό Γραβιώνος Αχαρνών 337. Στην ταρτίνα βόρεια κέρσης στην οδό Γραβιώνος Αχαρνών 363.
- Σταθμό *** Στην ταρτίνα δυτική κέρσης στην οδό Ανε. Μήτρικου 117.
- Σταθμό *** Στην ταρτίνα βόρεια κέρσης στην οδό Ανε. Μήτρικου 106. Στην ταρτίνα εγκατάστασης κέρσης στην οδό Ανε. Μήτρικου 109.

* Δεε κατεύθυνση ανέμου ή πλάγιου άνεμου.

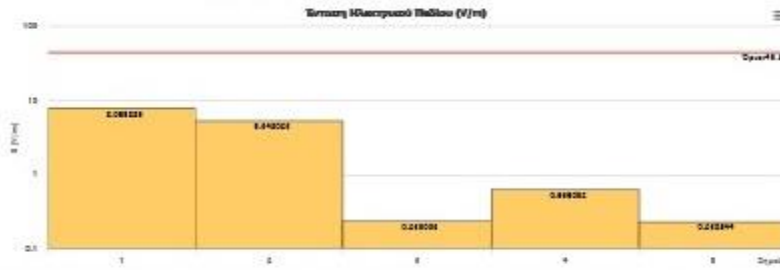

Το αποτέλεσμα της μετρήσεως με διαγράμμιση από τον εξοπλισμό παρατηρείται σε όλες τις ταρτίνες όπως φαίνεται παρακάτω. Το αποτέλεσμα είναι ανεπαρκές για να υποστηρίξει την παραγωγή ενέργειας στην ταρτίνα.

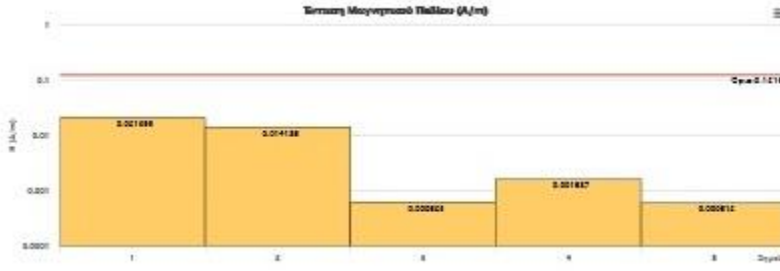

Το αποτέλεσμα της μετρήσεως με διαγράμμιση από τον εξοπλισμό παρατηρείται σε όλες τις ταρτίνες όπως φαίνεται παρακάτω. Το αποτέλεσμα είναι ανεπαρκές για να υποστηρίξει την παραγωγή ενέργειας στην ταρτίνα.

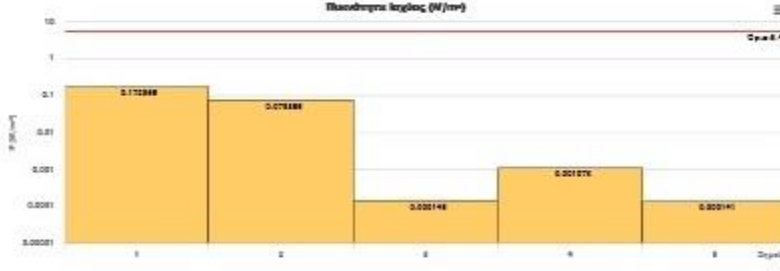

Το αποτέλεσμα της μετρήσεως με διαγράμμιση από τον εξοπλισμό παρατηρείται σε όλες τις ταρτίνες όπως φαίνεται παρακάτω. Το αποτέλεσμα είναι ανεπαρκές για να υποστηρίξει την παραγωγή ενέργειας στην ταρτίνα.

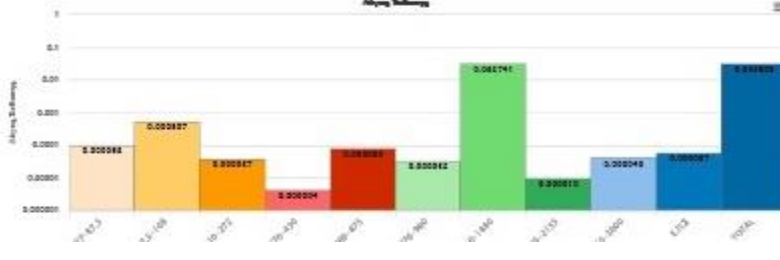

Figure II.15 – Results of EMF monitoring

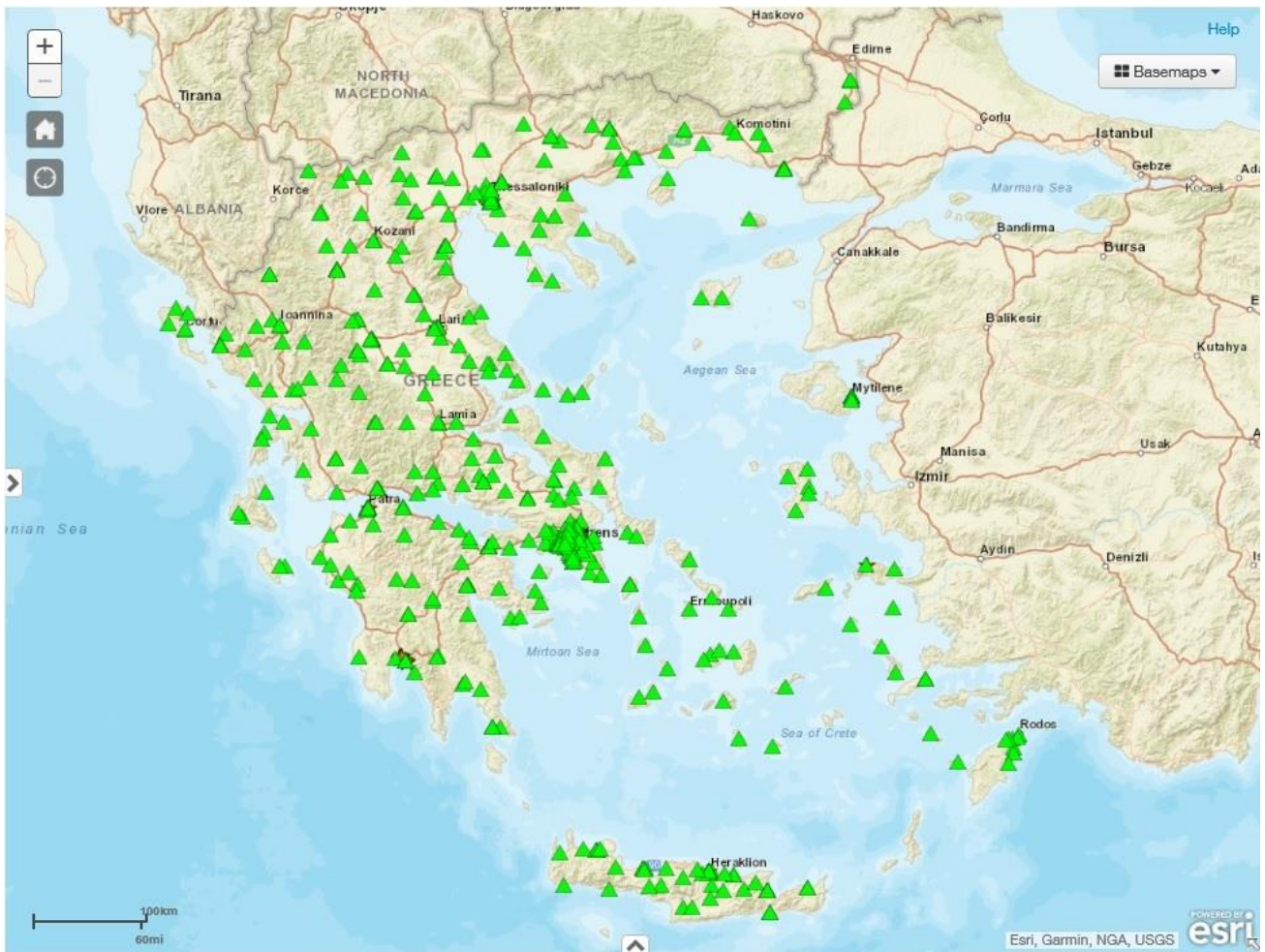
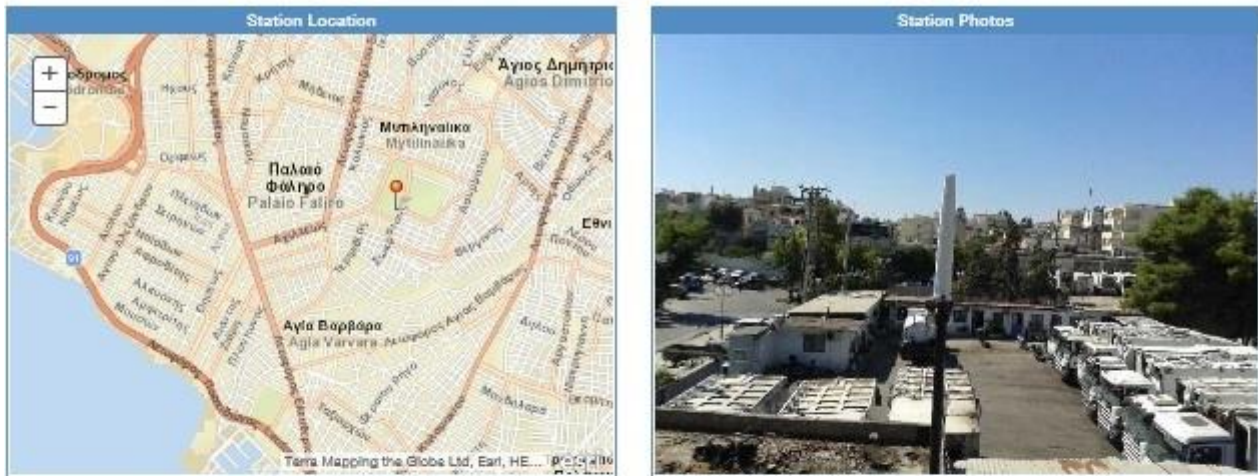

Figure II.16 – Location of the EMF measurement points

Depot of Palaio Faliro Municipality



Station Information	
Address	Sokratous kai Ag. Petrou
Municipality	Palaiou Falirou
Prefecture	Notiou Tomea Athinon
Active since	22-09-2016 08:02:30
Last update	12-12-2019
Measurement files captured by handheld device	Click here

Electric Field Strength			
Frequency Bands (MHz)	Frequency Band Limit (V/m)*	Average Value (V/m)	Peak Value (V/m)
Broadband Zone	21.7	0.69	0.77
EGSM-900	31.8	0.11	0.12
EGSM-1800	45.1	0.14	0.17
UMTS	47.2	0.13	0.16



Figure II.17 – Results of the EMF measurement

II.8 EMF monitoring system in Italy

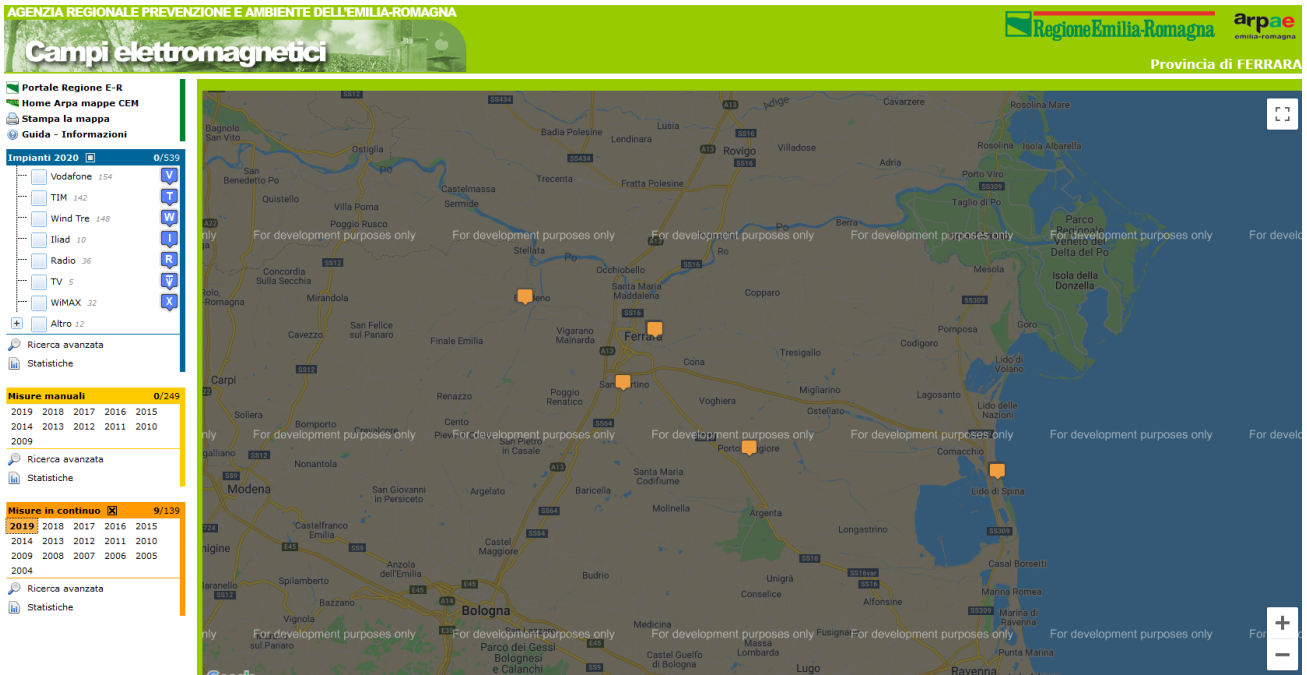

Figure II.18 – Main page of the system

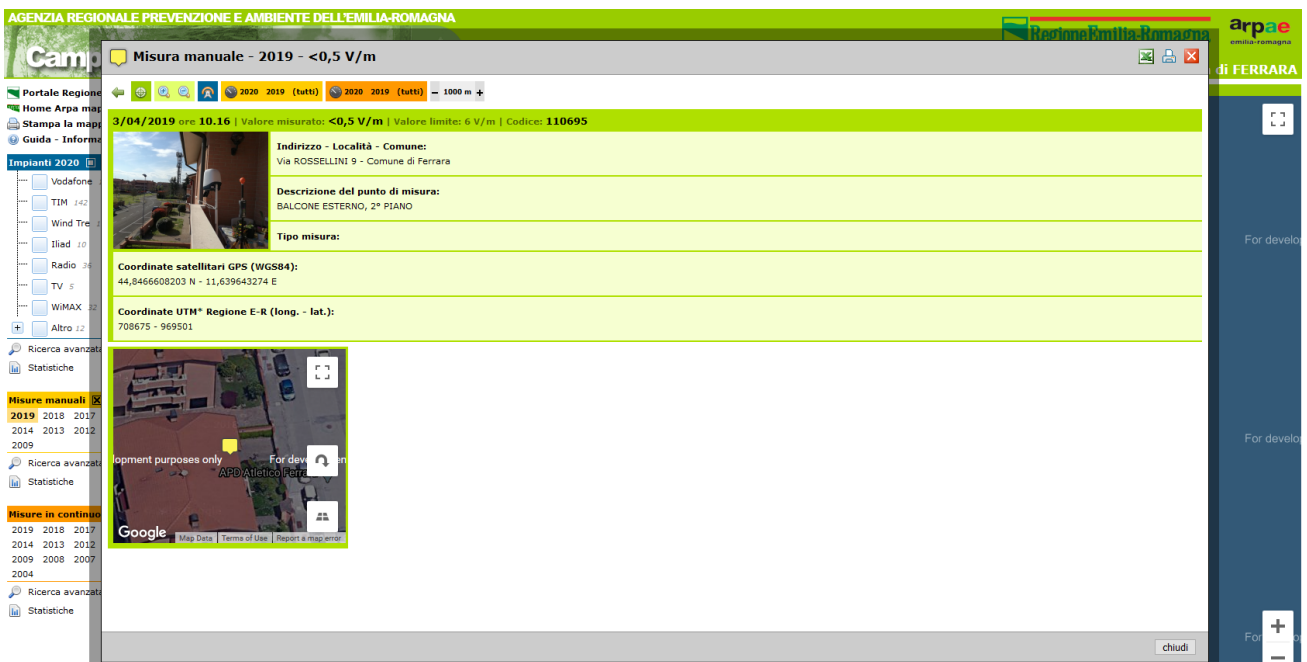

Figure II.19 – Example of the result of the measurement

II.9 EMF monitoring system in Catalonia (Spain)

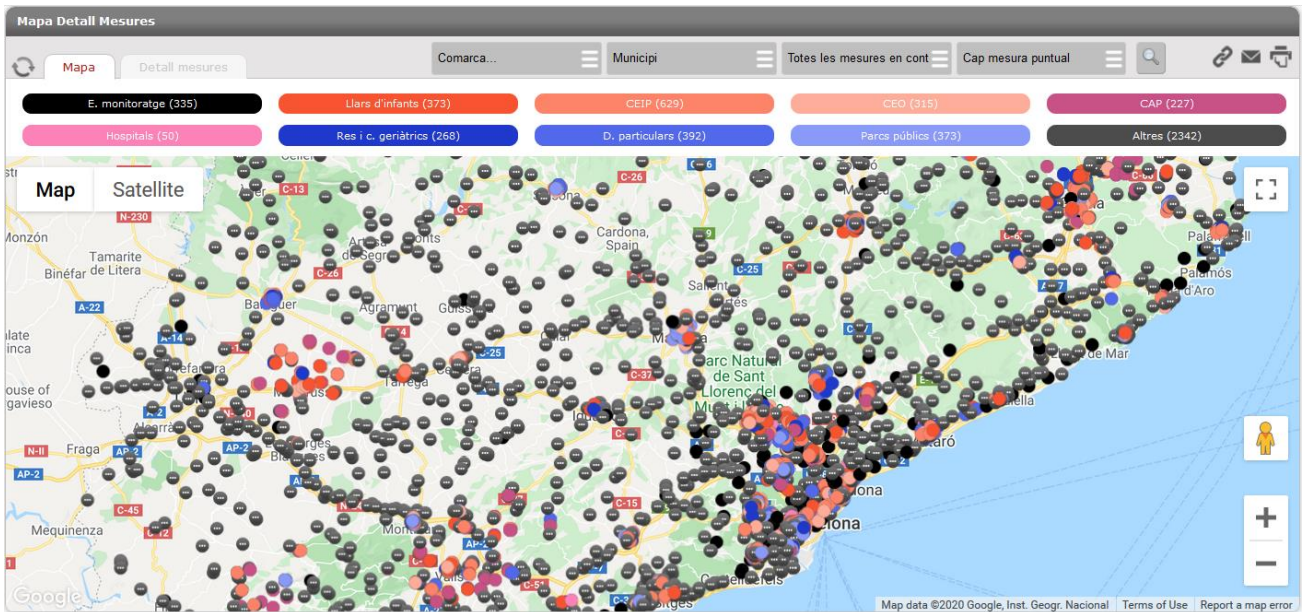

Figure II.20 – Main page of the system

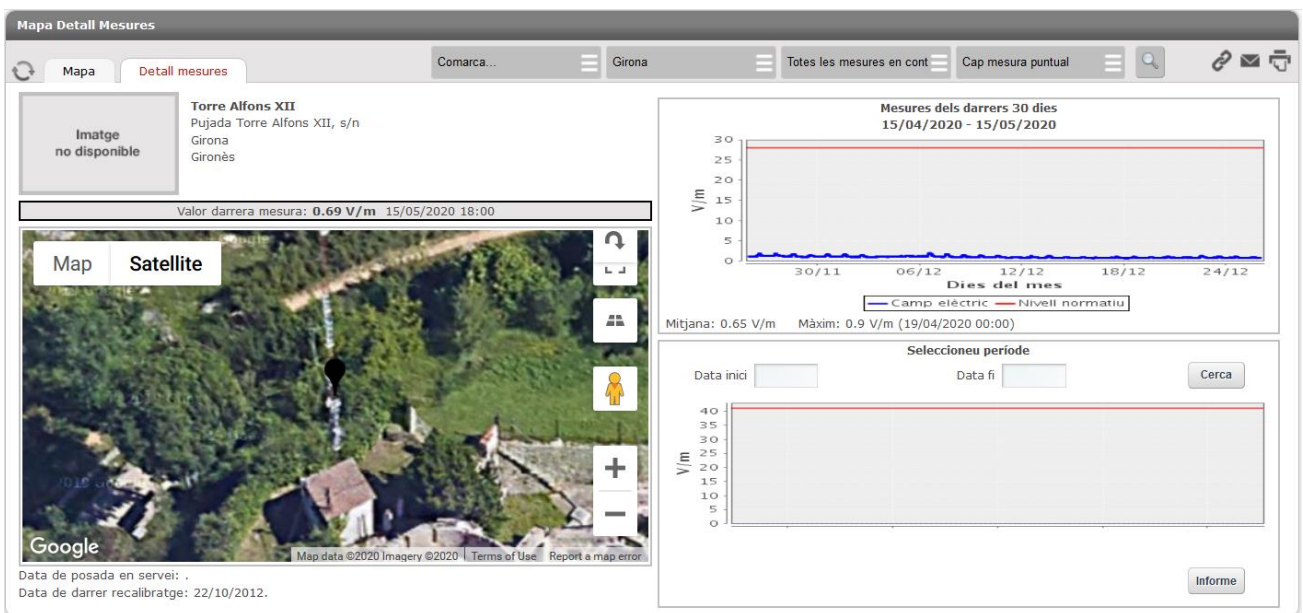

Figure II.21 – Example of the result of measurement

II.10 EMF monitoring system in Poland

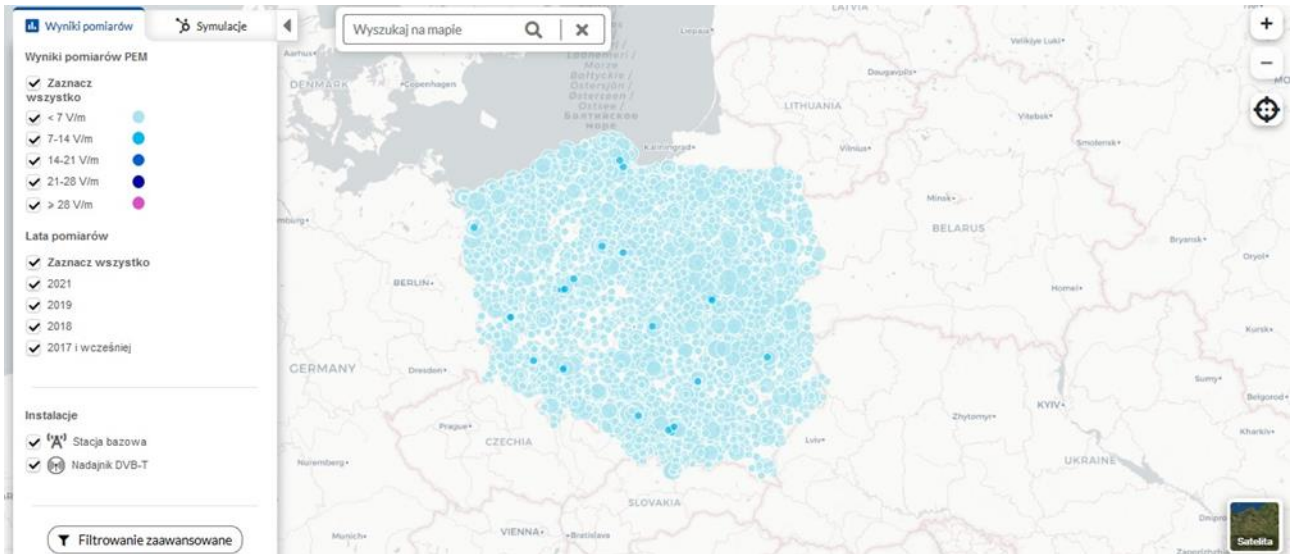

Figure II.22 – Main page of the system

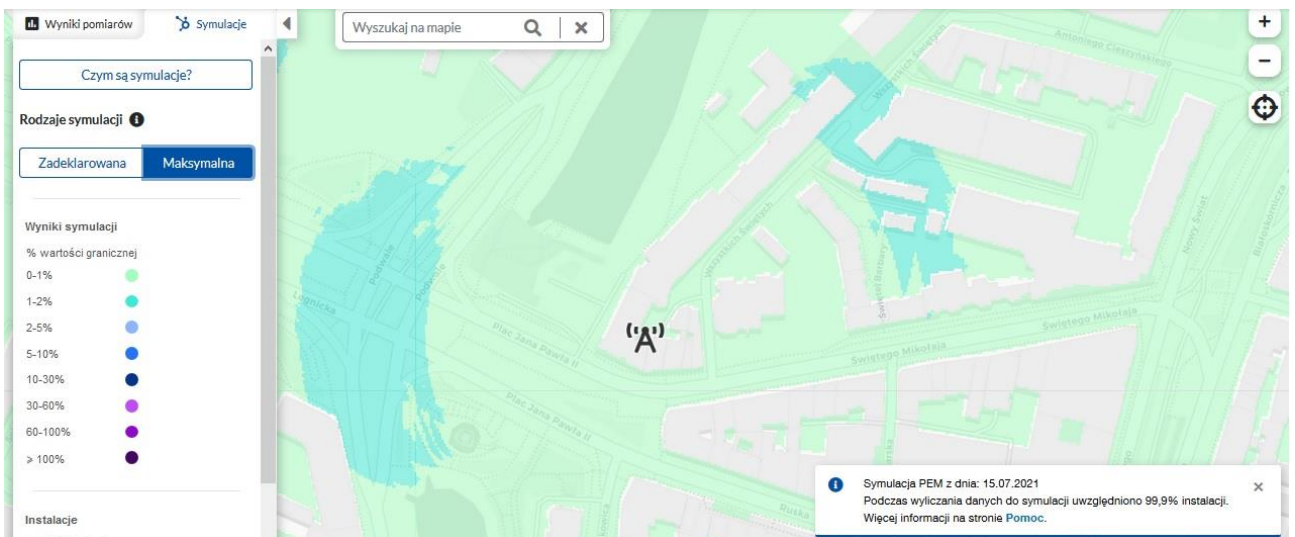

Figure II.23 – Example of the result of simulations of the FR EMF distribution

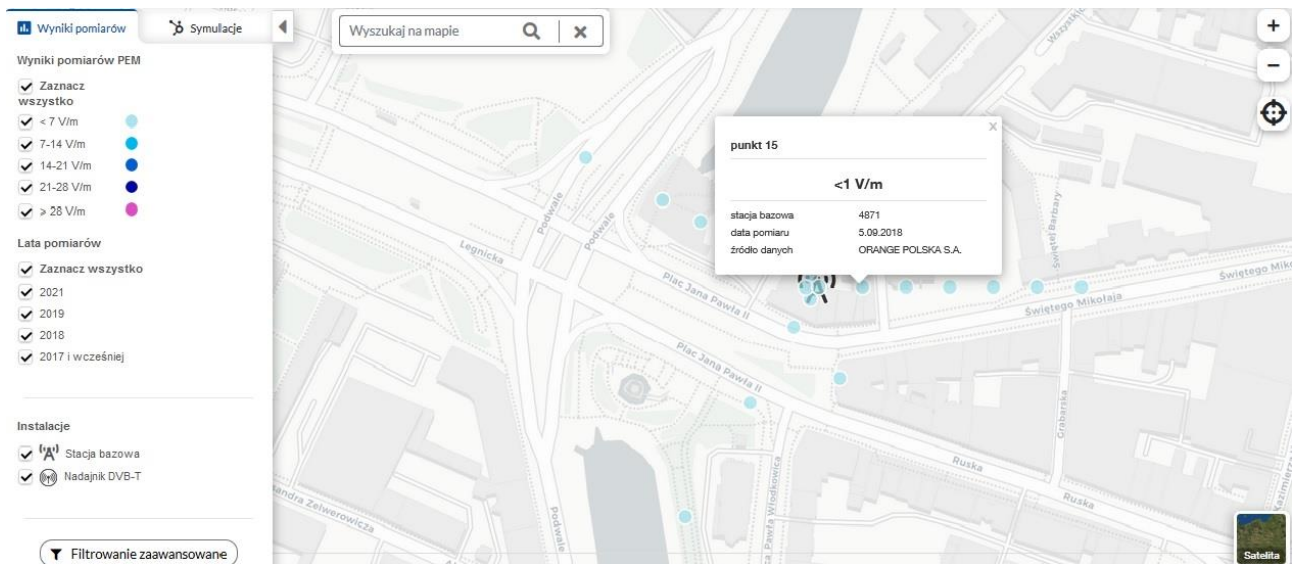

Figure II.24 – Example of the result of measurement

Bibliography

- [b-ITU-T K.52] Recommendation ITU-T K.52 (2021), *Guidance on complying with limits for human exposure to electromagnetic fields.*
- [b-ITU-T K.61] Recommendation ITU-T K.61 (2018), *Guidance on measurement and numerical prediction of electromagnetic fields for compliance with human exposure limits for telecommunication installations.*
- [b-ITU-T K.70] Recommendation ITU-T K.70 (2020), *Mitigation techniques to limit human exposure to EMFs in the vicinity of radiocommunication stations.*
- [b-ICNIRP 1998] ICNIRP (1998), *Guidelines for Limiting Exposure to Time-Varying Electric, Magnetic and Electromagnetic Fields (up to 300 GHz).*
<<https://www.icnirp.org/cms/upload/publications/ICNIRPemfgdl.pdf>>
- [b-ICNIRP 2020] ICNIRP (2020), *Guidelines for Limiting Exposure to Electromagnetic Fields (100 kHz to 300 GHz). Health Physics, Volume 118, Issue , pp. 483-524.*
<<https://pubmed.ncbi.nlm.nih.gov/32167495/>>

SERIES OF ITU-T RECOMMENDATIONS

Series A	Organization of the work of ITU-T
Series D	Tariff and accounting principles and international telecommunication/ICT economic and policy issues
Series E	Overall network operation, telephone service, service operation and human factors
Series F	Non-telephone telecommunication services
Series G	Transmission systems and media, digital systems and networks
Series H	Audiovisual and multimedia systems
Series I	Integrated services digital network
Series J	Cable networks and transmission of television, sound programme and other multimedia signals
Series K	Protection against interference
Series L	Environment and ICTs, climate change, e-waste, energy efficiency; construction, installation and protection of cables and other elements of outside plant
Series M	Telecommunication management, including TMN and network maintenance
Series N	Maintenance: international sound programme and television transmission circuits
Series O	Specifications of measuring equipment
Series P	Telephone transmission quality, telephone installations, local line networks
Series Q	Switching and signalling, and associated measurements and tests
Series R	Telegraph transmission
Series S	Telegraph services terminal equipment
Series T	Terminals for telematic services
Series U	Telegraph switching
Series V	Data communication over the telephone network
Series X	Data networks, open system communications and security
Series Y	Global information infrastructure, Internet protocol aspects, next-generation networks, Internet of Things and smart cities
Series Z	Languages and general software aspects for telecommunication systems