

International Telecommunication Union

ITU-T

TELECOMMUNICATION
STANDARDIZATION SECTOR
OF ITU

L.75

(05/2008)

SERIES L: CONSTRUCTION, INSTALLATION AND
PROTECTION OF CABLES AND OTHER ELEMENTS OF
OUTSIDE PLANT

**Test, acceptance and maintenance methods of
copper subscriber pairs**

Recommendation ITU-T L.75



Recommendation ITU-T L.75

Test, acceptance and maintenance methods of copper subscriber pairs

Summary

The new generation of digital subscriber line (xDSL) demands definition of new requirements and test and maintenance methods.

The test method, the object of Recommendation ITU-T L.75, aims at simplifying the task of measuring metallic cables and broadband access networks and at ensuring the integrity of services carried over them.

Source

Recommendation ITU-T L.75 was approved on 29 May 2008 by ITU-T Study Group 6 (2005-2008) under Recommendation ITU-T A.8 procedure.

Keywords

Copper cable requirements for broadband transmission, indoor and outside broadband networks qualification, xDSL.

FOREWORD

The International Telecommunication Union (ITU) is the United Nations specialized agency in the field of telecommunications, information and communication technologies (ICTs). The ITU Telecommunication Standardization Sector (ITU-T) is a permanent organ of ITU. ITU-T is responsible for studying technical, operating and tariff questions and issuing Recommendations on them with a view to standardizing telecommunications on a worldwide basis.

The World Telecommunication Standardization Assembly (WTSA), which meets every four years, establishes the topics for study by the ITU-T study groups which, in turn, produce Recommendations on these topics.

The approval of ITU-T Recommendations is covered by the procedure laid down in WTSA Resolution 1.

In some areas of information technology which fall within ITU-T's purview, the necessary standards are prepared on a collaborative basis with ISO and IEC.

NOTE

In this Recommendation, the expression "Administration" is used for conciseness to indicate both a telecommunication administration and a recognized operating agency.

Compliance with this Recommendation is voluntary. However, the Recommendation may contain certain mandatory provisions (to ensure e.g. interoperability or applicability) and compliance with the Recommendation is achieved when all of these mandatory provisions are met. The words "shall" or some other obligatory language such as "must" and the negative equivalents are used to express requirements. The use of such words does not suggest that compliance with the Recommendation is required of any party.

INTELLECTUAL PROPERTY RIGHTS

ITU draws attention to the possibility that the practice or implementation of this Recommendation may involve the use of a claimed Intellectual Property Right. ITU takes no position concerning the evidence, validity or applicability of claimed Intellectual Property Rights, whether asserted by ITU members or others outside of the Recommendation development process.

As of the date of approval of this Recommendation, ITU had not received notice of intellectual property, protected by patents, which may be required to implement this Recommendation. However, implementers are cautioned that this may not represent the latest information and are therefore strongly urged to consult the TSB patent database at <http://www.itu.int/ITU-T/ipr/>.

© ITU 2009

All rights reserved. No part of this publication may be reproduced, by any means whatsoever, without the prior written permission of ITU.

CONTENTS

	Page
1 Scope	1
2 References.....	1
3 Definitions	1
4 Abbreviations and acronyms	1
5 Conventions	2
6 Metallic cables and access network test, acceptance and maintenance methods, intended for service quality assurance.....	2
6.1 Spectral emulation method (SEM) foundation.....	2
6.2 Test and acceptance procedures	2
6.3 Maintenance	3
Appendix I – Traditional test methods and SEM comparison	4
I.1 Introduction	4
I.2 Spectral emulation method (SEM).....	7
I.3 Two methods comparison.....	9
I.4 Method validation.....	10
Appendix II – Brazilian experience	11
II.1 Network architecture	11
II.2 Test and acceptance procedure.....	15
Bibliography.....	16

Recommendation ITU-T L.75

Test, acceptance and maintenance methods of copper subscriber pairs

1 Scope

This Recommendation describes a methodology to qualify metallic cables for broadband use, before and after their installation on access networks. The qualification process is based on measurements of transmission rate (TR) carried out on the worst possible use condition of the cables, i.e., when all pairs are transmitting at the same time.

This methodology is known as the spectral emulation method (SEM) and can be applied to qualify modern broadband networks and old telephone networks used to carry xDSL signals.

2 References

The following ITU-T Recommendations and other references contain provisions which, through reference in this text, constitute provisions of this Recommendation. At the time of publication, the editions indicated were valid. All Recommendations and other references are subject to revision; users of this Recommendation are therefore encouraged to investigate the possibility of applying the most recent edition of the Recommendations and other references listed below. A list of the currently valid ITU-T Recommendations is regularly published. The reference to a document within this Recommendation does not give it, as a stand-alone document, the status of a Recommendation.

[ITU-T G.992.5] Recommendation ITU-T G.992.5 (2005), *Asymmetric digital subscriber line (ADSL) transceivers – Extended bandwidth ADSL2 (ADSL2plus)*.

[ITU-T G.993.2] Recommendation ITU-T G.993.2 (2006), *Very high speed digital subscriber line transceivers 2 (VDSL2)*.

3 Definitions

None.

4 Abbreviations and acronyms

This Recommendation uses the following abbreviations and acronyms:

ADSL	Asymmetric Digital Subscriber Line
B	Bandwidth
DSLAM	Digital Subscriber Line Access Multiplexer
FEXT	Far-End CrossTalk
IL	Insertion Loss
IPTV	Internet Protocol TeleVision
NEXT	Near-End CrossTalk
N-PSD	Noise Power Spectral Density
PSD	Power Spectrum Density
PSELFEXT	Power Sum Equal Level Far-End CrossTalk
PSNEXT	Power Sum Near-End CrossTalk
SEM	Spectral Emulation Method

S/N	Signal-to-Noise ratio
TR	Transmission Rate
VP	Victim Pair
xDSL	General representation for Digital Subscriber Line

5 Conventions

None.

6 Metallic cables and access network test, acceptance and maintenance methods, intended for service quality assurance

6.1 Spectral emulation method (SEM) foundation

Crosstalk is a critical factor in channel capacity evaluation. The summation of all crosstalk (unwanted) signals coupling in a determinate cable pair from all other pairs is the main factor that increases noise. In order to evaluate this parameter, power sum calculations are performed using near- and far-end crosstalk measurements. Annex A shows a drawback associated with these measurements and calculations and the advantage of the SEM.

SEM is based on Nyquist and Shannon theories, which state that the channel capacity is related to bandwidth, signal-to-noise ratio, and the number of symbols used to modulate each carrier (tone).

$$\text{Nyquist: } C = 2 B \log_2 n$$

$$\text{Shannon: } C = B \log_2 [1 + S/N]$$

B: Bandwidth

S/N: Signal-to-noise ratio

n: number of symbols

SEM consists of feeding all cable pairs, except the one selected as a victim pair (VP), with controlled xDSL signals. Transmission rate (TR), noise power spectral density (N-PSD) and signal-to-noise ratio (S/N) on the VP are then measured, instead of evaluating cross-talk, power-sums, impedance, return loss, insertion loss, capacitance, resistance, resistance unbalance, capacitance unbalance, etc. The impact of all these parameters will be reflected in the TR measurements. This process is repeated, switching the VP, until all cable pairs have been measured.

6.2 Test and acceptance procedures

Acceptance of all access networks used with xDSL systems is recommended before providing any wideband service. To do that, test performance must be executed on groups of up to 600 pairs.

Also, before installing any new cable on a new network, all pairs, in groups of up to 100 pairs, are recommended to be measured to avoid detecting problems when they are already installed.

A 100-pair test procedure is based on the following algorithm:

- a) Feed pairs number 2 to 100, at the near-end side, with non-coherent signals, with power spectrum density (PSD) limited according to the xDSL technology being evaluated (e.g., Figure B.1 of [ITU-T G.992.5] defines the PSD mask limit for an ADSL2plus operation; see also [ITU-T G.993.2] for VDSL PSD definition). At the far-end side, these pairs must be properly terminated on a resistive load defined as the xDSL impedance level (e.g., 100 Ω for ADSL2plus). Those pairs are called disturbing pairs.
- b) Connect one DSLAM port at the near-end side and a modem at the other side of the pair number 1, selected as the VP. Pair 1 is, then, the pair under test.

- c) Measure the VP TR and S/N. Save these measurements on a database.
- d) Disable DSLAM port and switch the VP far-end side from the modem to a spectrum analyser. Measure and save the N-PSD on the database.
- e) Select another VP and switch it to the set DSLAM/modem. It becomes the new VP. Feed the former VP with the full bandwidth spectrum signal, as in the first step a.
- f) Repeat steps c and d until all pairs have been measured.
- g) The minimum test report must include:
 - i) Cable identification.
 - ii) Cable length.
 - iii) Local temperature. When testing cables on laboratories, room temperature must be controlled and stabilized in the range of $20 \pm 5^{\circ}\text{C}$. Care must be taken to ensure that the cable internal temperature has reached room temperature.
 - iv) A graphic and a list of all pairs and their respective TRs and S/Rs, ordered from the one with the highest TR (fastest pair) to the one with the lowest TR (slowest pair).
 - v) N-PSD must be kept saved on the database for maintenance purposes, addressed in step d above.

The test procedure for networks is similar, except that the far-end side pairs can be located in distinct ending boxes or cabinets. Remote test modules, capable of being remotely controlled, must be used to switch the far-end side of the pairs to modems, terminating loads and spectrum analysers.

Automatic test equipment is recommended to: speed up the test process; save test reports in a database for traceability and statistics purposes; and to guarantee the necessary reliability.

In the case of cable tests, it is mandatory to measure both cable sides in order to evaluate the upstreams and downstreams for xDSL applications.

For network tests, once cables have been previously measured, downstream measurement is enough.

The requirements shall be expressed as the minimum TR value, and agreed between the supplier and customer.

See Appendix I for a comparison of this method with other traditional methods.

6.3 Maintenance

After testing, comparing results with requirements and accepting the network, broadband service can then be provided and, then, a reliable service quality *maintenance* strategy must be carried out. A proper form to implement it is to enquire periodically the TR of each working port of all DSLAMs, compare them with values obtained during the acceptance process, and alarm in cases of performance degradation and faults.

Inspection points, capable of switching any pair to a test bus, are recommended to be installed on terminal boxes and cabinets. They will provide easy access to cables (or wires) connected to both sides of the boxes or cabinets when field maintenance becomes necessary. TR, S/N and, especially N-PSD, can be measured and compared to the previous measurements collected during the network acceptance.

Additional to the above-mentioned measurements, impulsive noise is also recommended to be measured and saved on the database, especially due to its importance to Internet protocol television (IPTV) service quality.

Appendix I

Traditional test methods and SEM comparison

I.1 Introduction

Depending on the type of multiplex used on a determined DSL technology, frequency or time, it is necessary to measure, in cables and access networks, far-end crosstalk (FEXT), near-end crosstalk (NEXT) or both.

NEXT is a measure of the unwanted signal coupling from a transmitter at the near-end into neighbouring pairs measured at the near-end side. NEXT is measured for all pair combinations in a cable group.

Power sum NEXT (PSNEXT) calculation takes into account the combined crosstalk on a receive pair from all near-end disturber pairs operating simultaneously.

Similarly, equal level far-end crosstalk (ELFEXT) is the measure of the unwanted signal coupling from a transmitter at the far-end into neighbouring pairs measured at the near-end. Power sum ELFEXT (PSELFEXT) is calculated based on the combined crosstalk on a receive pair from all far-end disturbers operating simultaneously.

It is important to notice that ELFEXT is actually the far-end crosstalk (FEXT) minus disturbing pair insertion loss (IL).

To calculate the PSNEXT of a 100-pair cable, it is necessary to measure the cross-talk of the 2-combination of those 100 pairs. The number of k -combinations (each of size k) from a set S with n elements (size n) can be determined with the binomial coefficient:

$$\binom{n}{k} = \frac{n!}{k!(n-k)!}$$

Calculating this binomial for $n=100$ and $k=2$, results in 4950 combinations.

Besides that, the total number of frequency points within the specified bandwidth shall be a minimum of 100 times the number of decades covered by the frequency range.

As an example, for a 0.1-8 MHz xDSL cable, it will be necessary to measure for each of the 4950 pair combinations, a minimum of 200 frequency points, resulting in 990 000 measurements.

For PSELFEXT, the problem is worse. As ELFEXT between, for example, pair n and pair p – $\text{ELFEXT}_{(n,p)}$ – is different from $\text{ELFEXT}_{(p,n)}$, the latter should also be measured, doubling the total number of crosstalk measurements. It is also necessary to measure the 100-pair attenuations. Taking all that into account, 2 000 000 frequency measurements will have to be done just to calculate ELFEXT and PSELFEXT.

Considering this fact, even with automatic test systems, it is impractical to evaluate PSELFEXT and PSNEXT on all cables that come out of a production line. Normally, cable manufacturers test only samples of groups on samples of cables. In other words, cables are poorly evaluated when they need, for the purpose of data transmission, to be fully evaluated.

Figures I.1, I.2 and I.3 illustrate the plots of 100-pair PSNEXT, IL and PSELFEXT of an 8 MHz xDSL cable.

Insertion loss

Worse case [dB/100 m]: 1.01 Frequency [kHz]: 300.00 Specification [dB/100 m]: 1.40 Margin [dB/100 m]: 0.39

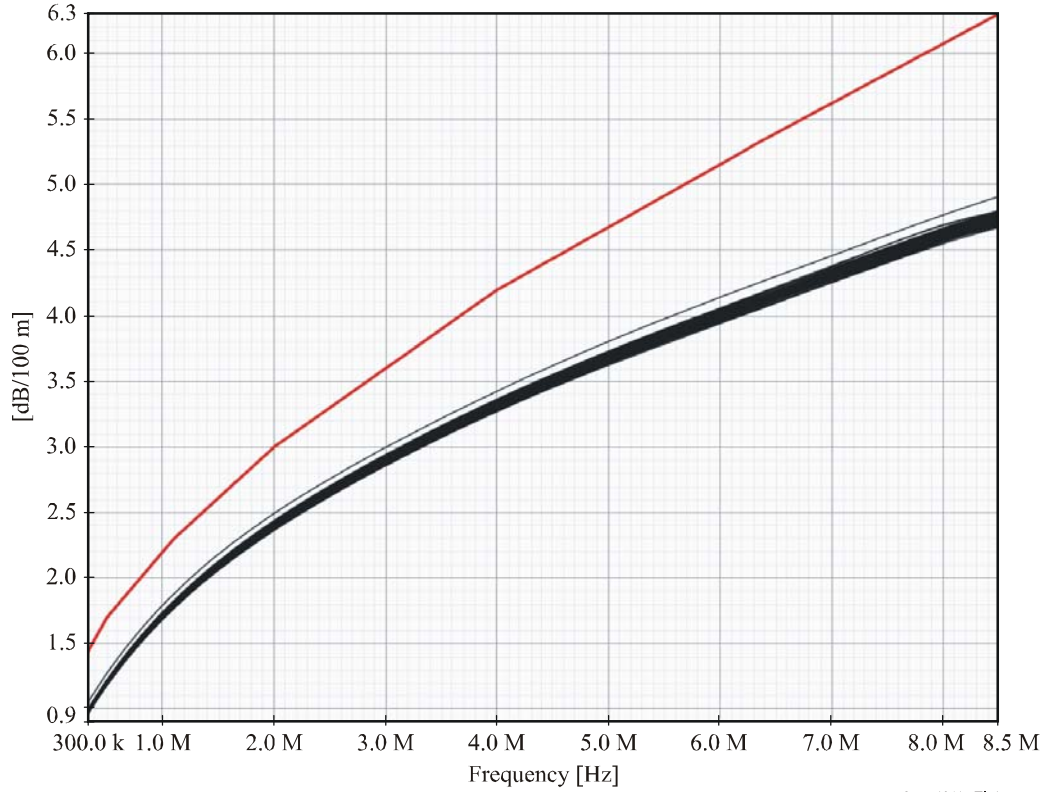

L.75(08)_Fl.1

Figure I.1 – Insertion Loss of 8 MHz xDSL cable

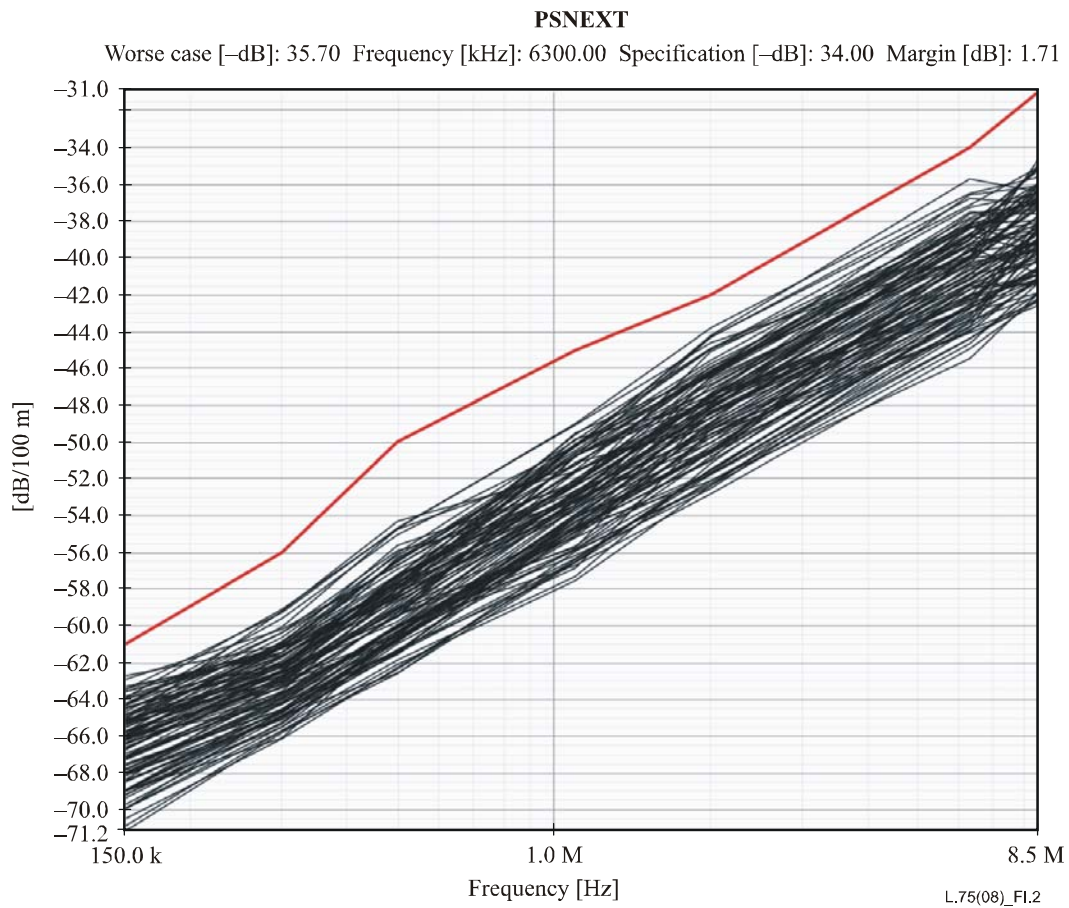

Figure I.2 – PSNEXT

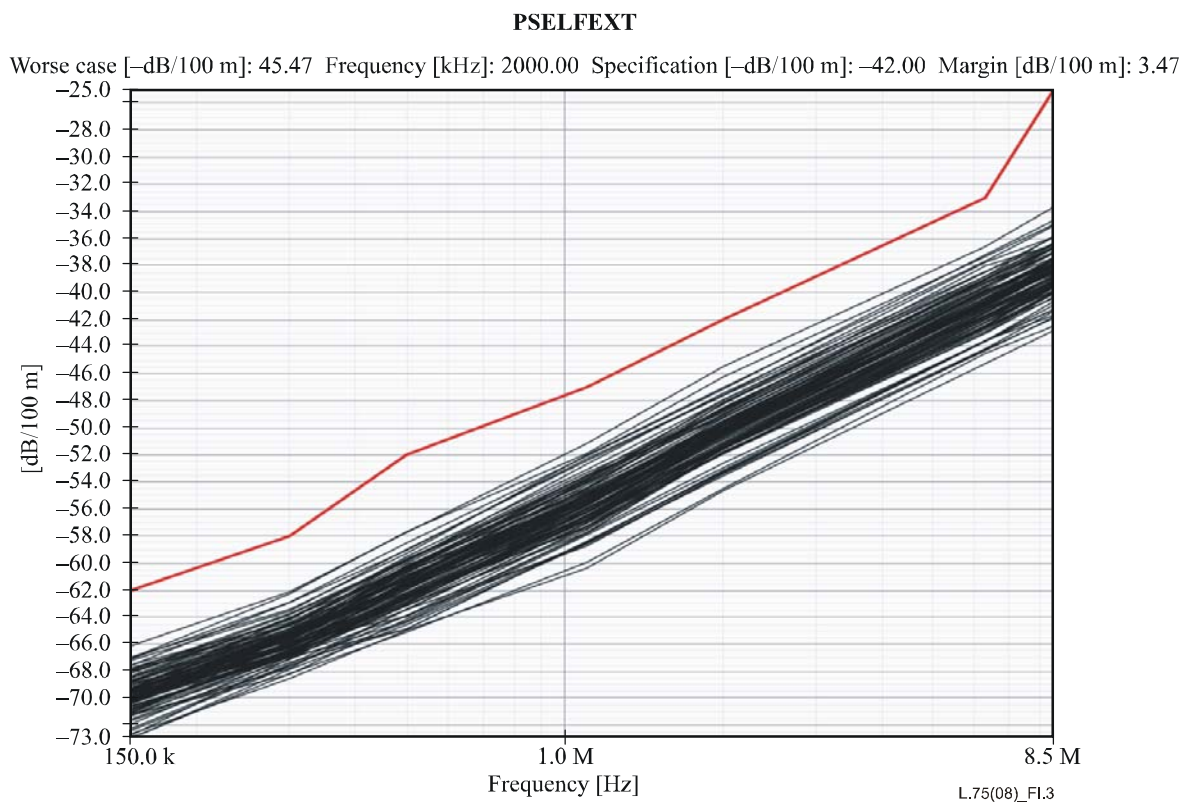

Figure I.3 – PSELFEXT

I.2 Spectral emulation method (SEM)

In this method, power sum can then be indirectly measured, not calculated. Figure I.4 shows a 25-pair cable loaded with emulated modem signals at one end and pair #1 has been measured at the other end.

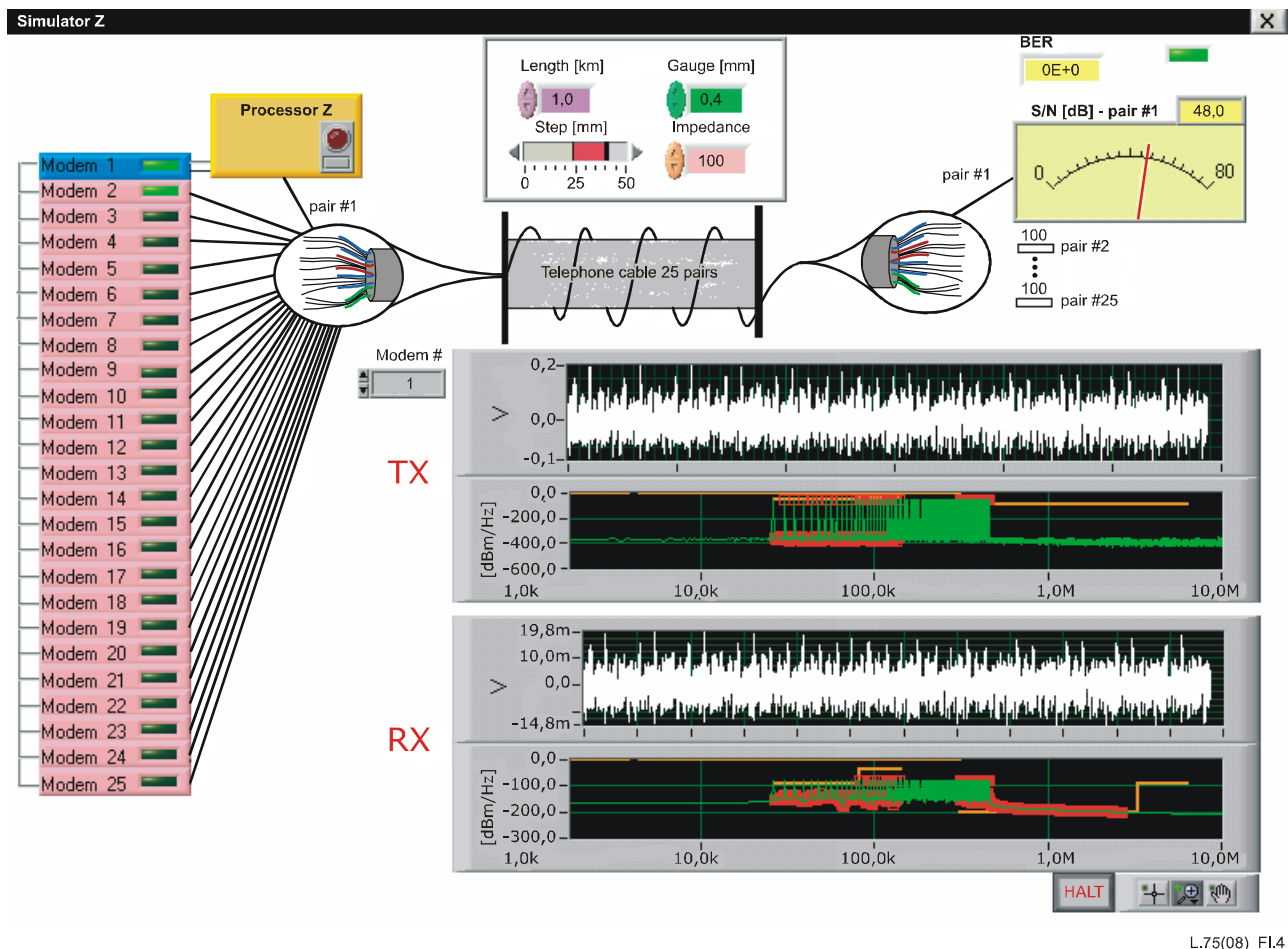
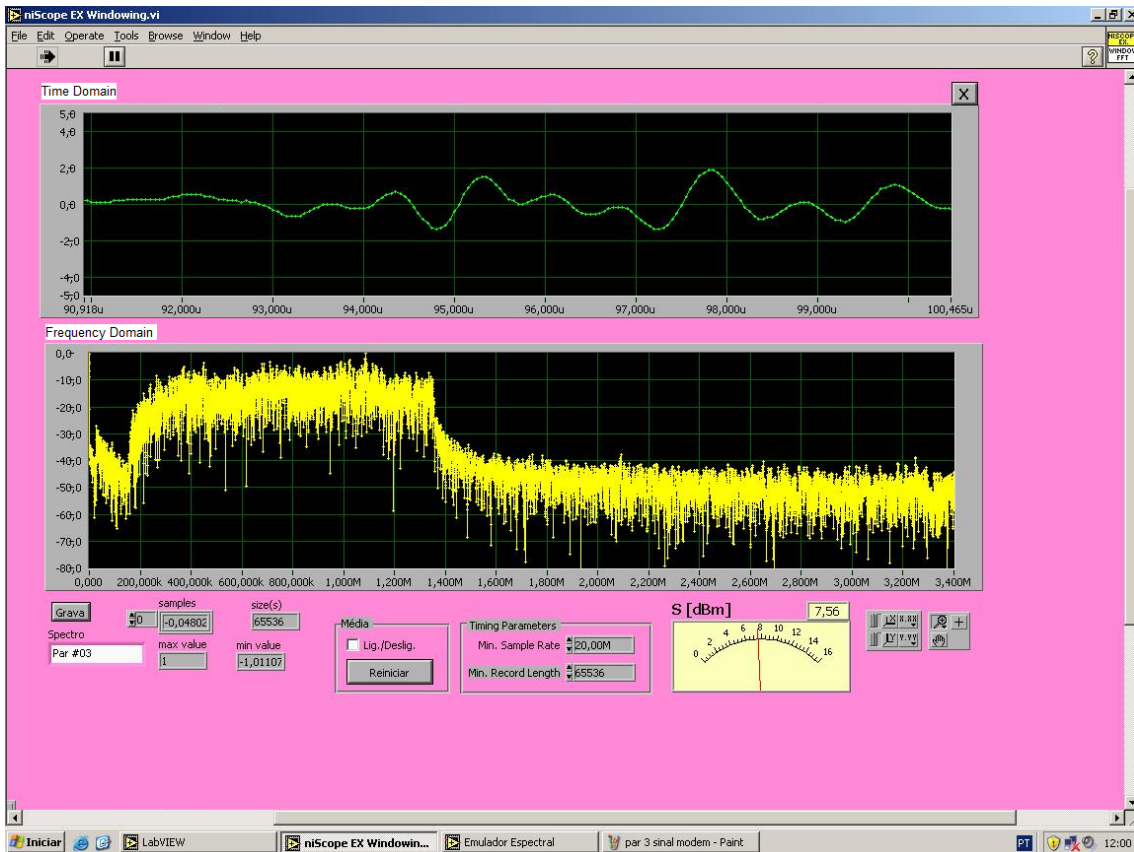

Figure I.4 – S/N measurement in a loaded cable

Additionally, when data rates for the upstream and downstream directions are measured, the effect of all cable parameters (insertion and return losses, impedance mismatch, unbalance, crosstalk, etc.) combined together will be reflected in the obtained results.

Figure I.5-a is a copy of a signal used to load one pair measured in the time and frequency domain (envelope). Figure I.5-b shows another signal with more detail: a zoom in over the time domain signal and no average on the frequency domain representation.



a) ADSL signal in time and frequency domain (averaged)

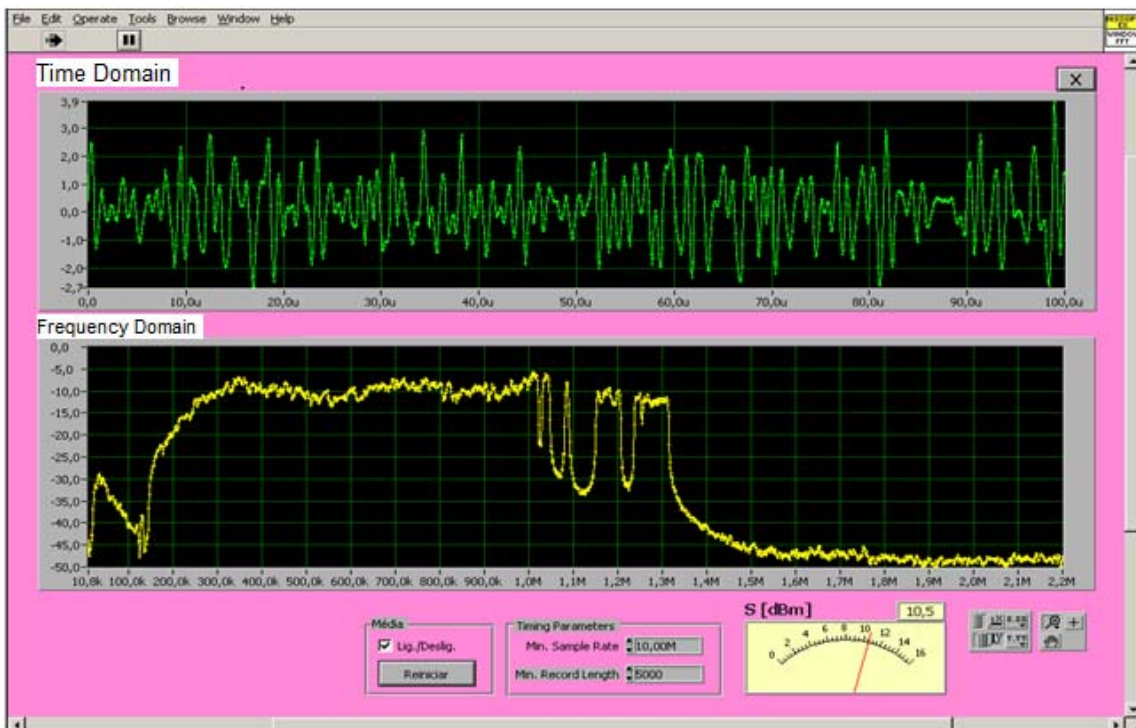

b)

Figure I.5 – Signal in time and frequency domain

Figure I.6 shows the downstream data rate (kbit/s) as a function of the number of transmitting disturbing pairs, obtained on a broadband access network using ADSL2plus technology.

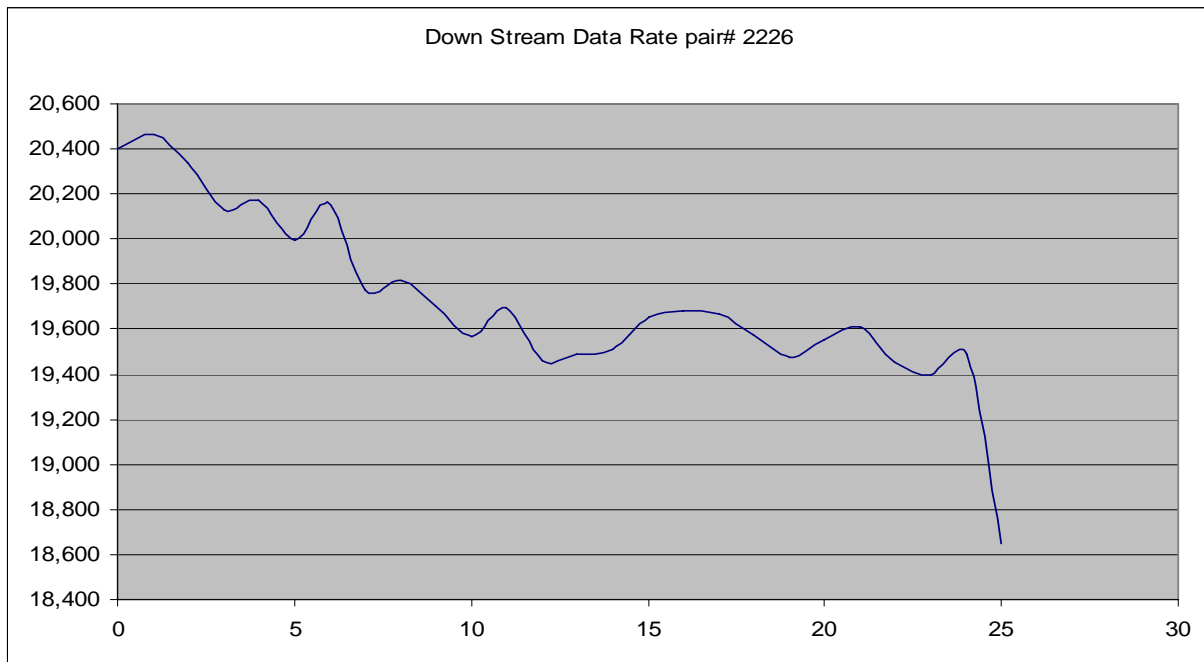

Figure I.6 – Downstream transmission rate

Notice the importance of measuring the cable loaded. The data rate varied from 20.4 Mbit/s when the pair was the only one transmitting, to 18.7 Mbit/s when all 25 pairs were loaded and interfering mutually.

I.3 Two methods comparison

With the cable loaded direct data rate measurement method for a 100-pair cable group, 99 pairs are fed with non-coherent modem signals, whilst one is taken for upstream and downstream measurement. This process is repeated 100 times until all pairs have been measured.

The comparison is: 2 000 000 measurements to determine just the PSELFEXT against 100 for upstream plus 100 for downstream.

The basic difference consists in the way the cable is fed. Usually, for IL, NEXT and ELFEXT, network analysers with two ports are used, one port set as a frequency generator and the other as a power meter.

On the other hand, with the cable loaded direct data rate measurement method, all pairs of a group, but the one been measured, are loaded at the same time with signals from independent "generators". These independent signals consist of frequency tones, appropriately spaced, modulated, and covering the bandwidth of the DSL technique used.

Due to the fact that the number of measurements is 10 000 smaller when compared to the conventional power sum evaluation, the time test is drastically reduced, allowing cable manufacturers to test the whole production for quality assurance purposes and allowing telecommunication carriers to assess the performance of their broadband access networks.

I.4 Method validation

The validation process was carried out comparing results obtained with the proposed method, using spectral emulators and real DSLAM-modem connections for different types of cable, length and DSL modulation schemes.

Figure I.7 shows one of these comparisons made on an installed 3 km cable using ADSL2.

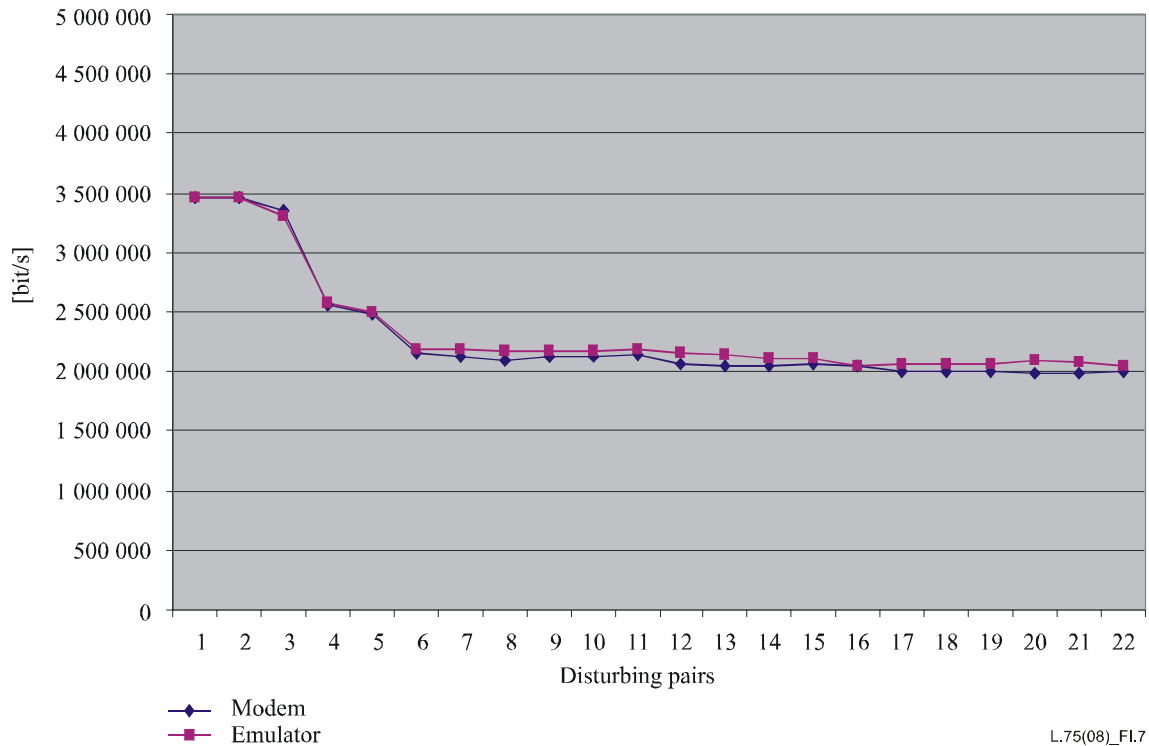

L.75(08)_FI.7

Figure I.7 – Methods comparison

As can be seen, real results can be predicted precisely and they are indeed valuable for telecommunication carriers.

Appendix II

Brazilian experience

(This appendix does not form an integral part of this Recommendation)

Introduction

The spectral emulation method (SEM) has been used for cable and access network test and acceptance purposes by one of the Brazilian long-distance and local carriers. Top-of-the-line equipment, modern xDSL cables and accessories are used in every new broadband network constructed to implement a modern access network in Brazil.

II.1 Network architecture

The photograph in Figure II.1 shows one area where the broadband network installation is being carried out in the city of Rio de Janeiro.



Figure II.1 – Initial installation area in Rio de Janeiro

These networks consist of optical rings feeding remote access units (URA), in a fibre-to-the cabinet (FTTC) architecture (Figure II.2).

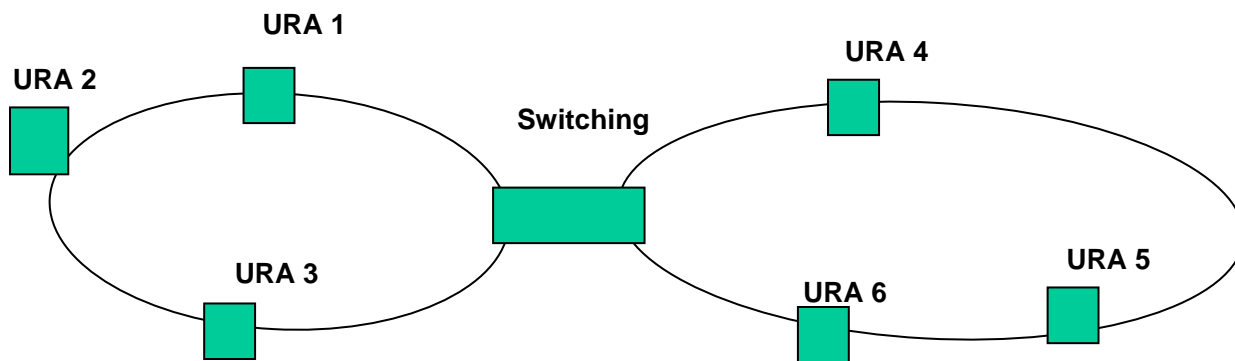

Figure II.2 – FTTC architecture

The URAs are assembled with mini-DSLAMs connected to high performance xDSL cables.

These cables of 50 to 1200 pairs end up at the terminal boxes (TAR) or at the high density connecting frames (CDG).

Client modems are then connected using special xDSL wires (Figure II.3).

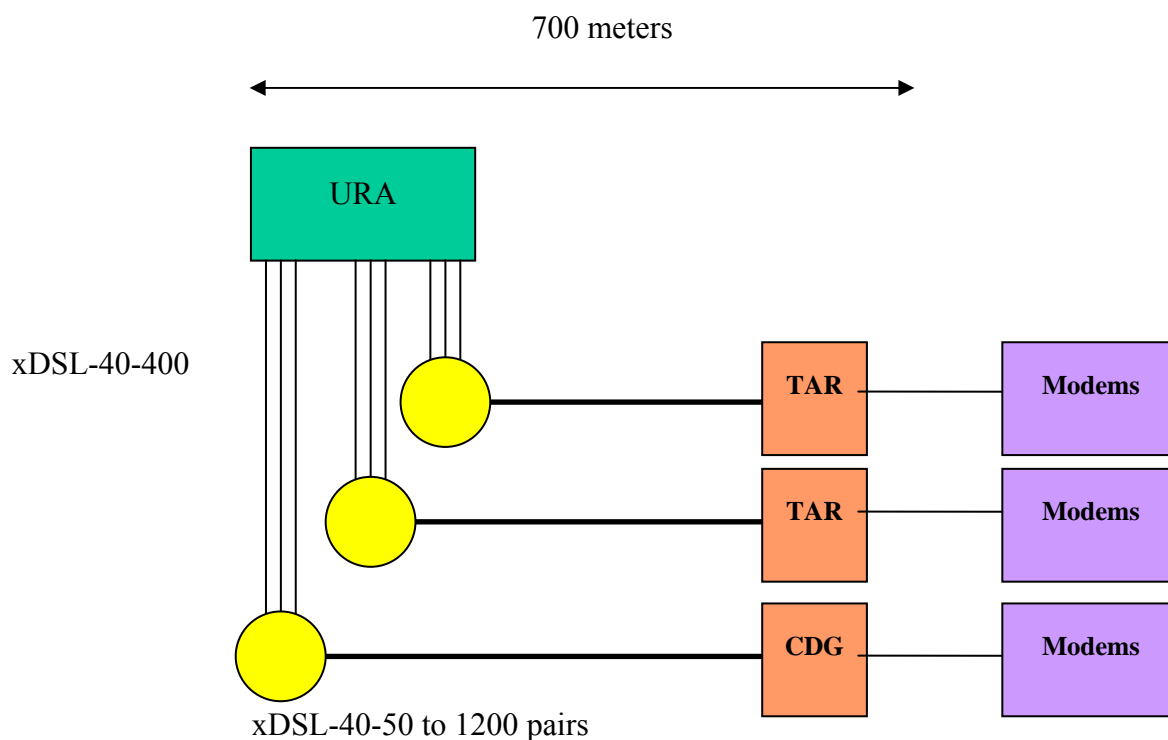

Figure II.3 – Broadband access network

Figures II.4-II.8 show the URA and the TAR.



Figure II.4 – Remote access unit (URA)

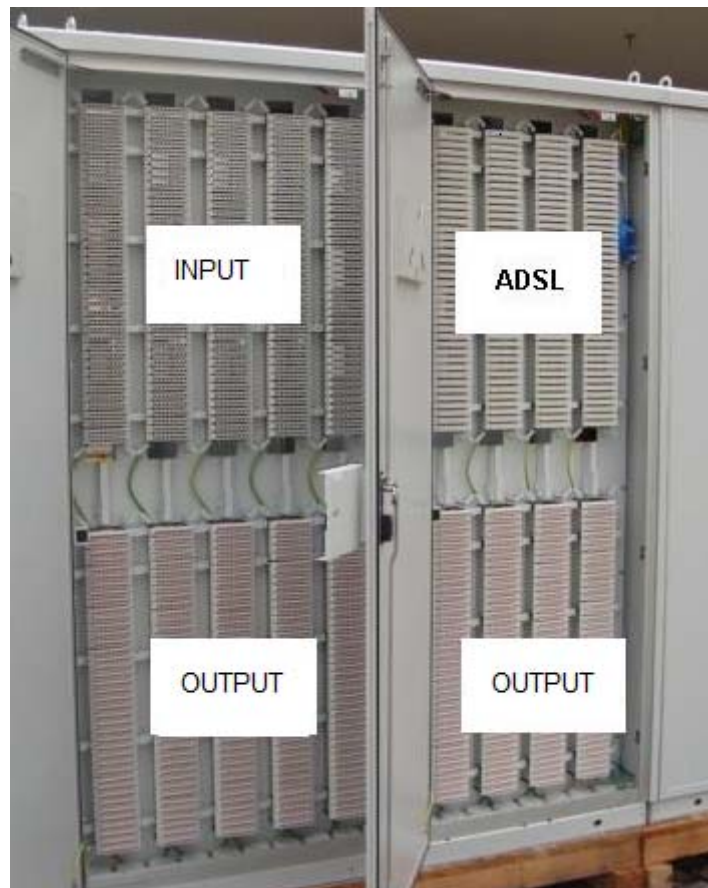

Figure II.5 – Inside the remote access unit (URA)

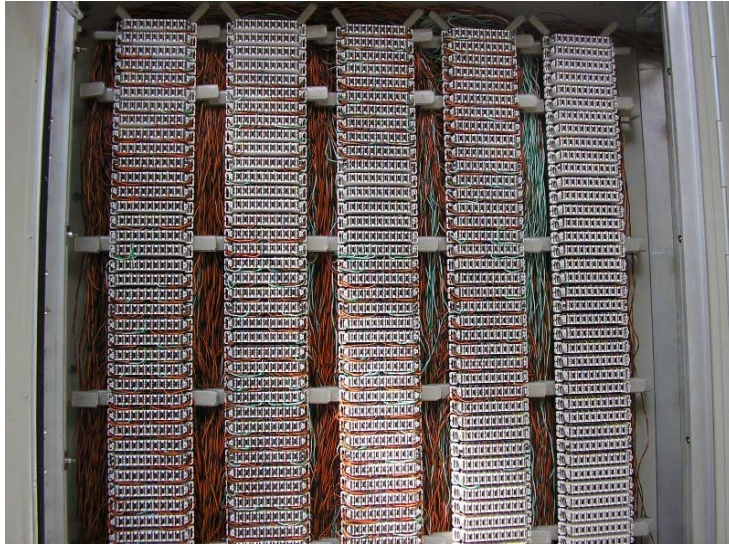

Figure II.6 – Connecting terminals

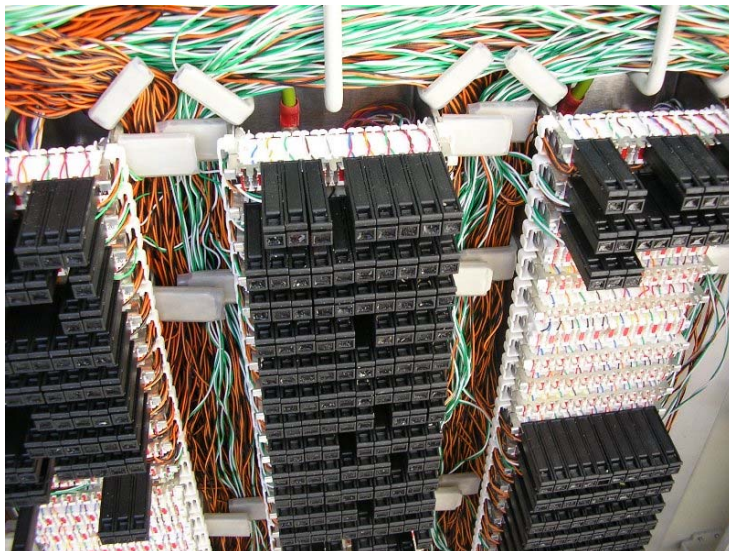

Figure II.7 – Protection modules



Figure II.8 – Terminal box (TAR)

II.2 Test and acceptance procedure

To assess high quality service, it is necessary to test all cables (upstream and downstream) at the near and far-end prior to installation.

After installation, the whole access network must be measured again (downstream only) to ensure that every pair of the system meets the requirements.

Figure II.9 shows the downstream data rate as a function of the number of interfering pairs, obtained on a broadband access network using ADSL2plus technology.

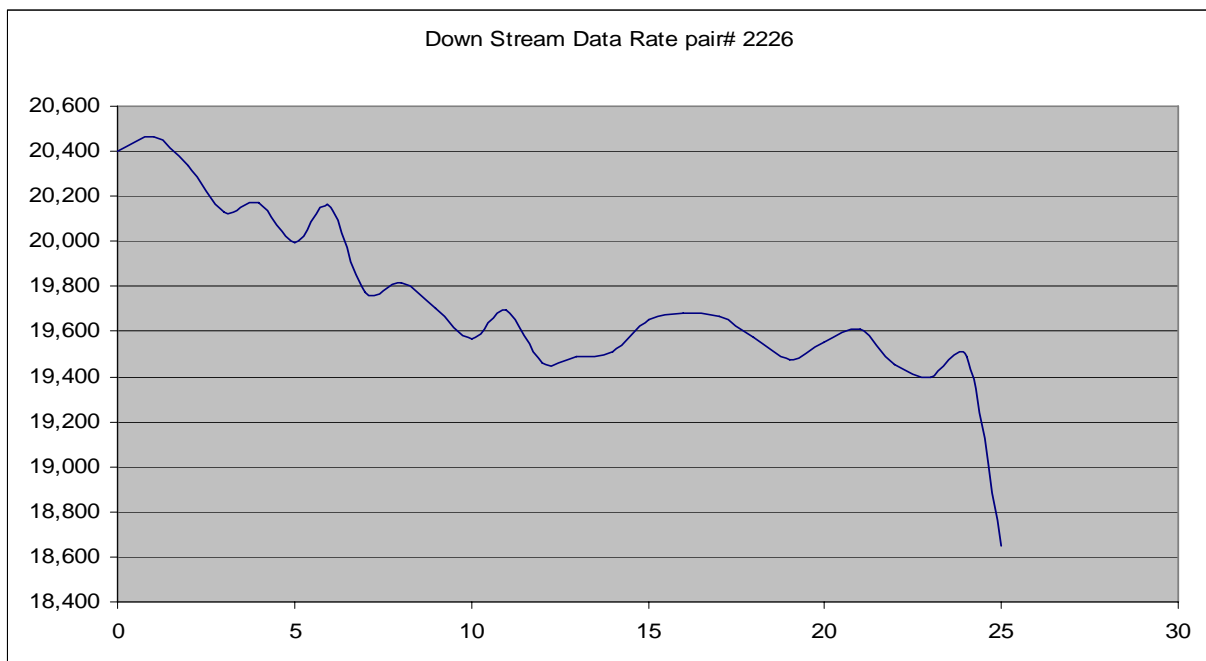

Figure II.9 – Downstream transmission rate

Bibliography

- [b-ITU-T G.117] Recommendation ITU-T G.117 (1996), *Transmission aspects of unbalance about earth.*
- [b-ITU-T G.961] Recommendation ITU-T G.961 (1993), *Digital transmission system on metallic local lines for ISDN basic rate access.*
- [b-ITU-T G.991.1] Recommendation ITU-T G.991.1 (1998), *High bit rate digital subscriber line (HDSL) transceivers.*
- [b-ITU-T G.991.2] Recommendation ITU-T G.991.2 (2003), *Single-pair high-speed digital subscriber line (SHDSL) transceivers.*
- [b-ITU-T G.992.1] Recommendation ITU-T G.992.1 (1999), *Asymmetric digital subscriber line (ADSL) transceivers.*
- [b-ITU-T G.992.2] Recommendation ITU-T G.992.2 (1999), *Splitterless asymmetric digital subscriber line (ADSL) transceivers.*
- [b-ITU-T G.992.3] Recommendation ITU-T G.992.3 (2005), *Asymmetric digital subscriber line transceivers 2 (ADSL2).*
- [b-ITU-T G.992.4] Recommendation ITU-T G.992.4 (2002), *Splitterless asymmetric digital subscriber line transceivers 2 (splitterless ADSL2).*
- [b-ITU-T G.993.1] Recommendation ITU-T G.993.1 (2004), *Very high speed digital subscriber line transceivers (VDSL).*
- [b-ITU-T G.994.1] Recommendation ITU-T G.994.1 (2003), *Handshake procedures for digital subscriber line (DSL) transceivers.*
- [b-ITU-T G.995.1] Recommendation ITU-T G.995.1 (2001), *Overview of digital subscriber line (DSL) Recommendations.*
- [b-ITU-T G.996.1] Recommendation ITU-T G.996.1 (2001), *Test procedures for digital subscriber line (DSL) transceivers.*
- [b-ITU-T G.997.1] Recommendation ITU-T G.997.1 (2006), *Physical layer management for digital subscriber line (DSL) transceivers.*
- [b-ITU-T G.9954] Recommendation ITU-T G.9954 (2005), *Phoneline networking transceivers – Enhanced physical, media access, and link layer specifications.*
- [b-ITU-T I.361] Recommendation ITU-T I.361 (1999), *B-ISDN ATM layer specification.*
- [b-ITU-T I.432.1] Recommendation ITU-T I.432.1 (1999), *B-ISDN user-network interface – Physical layer specification: General characteristics.*
- [b-ITU-T O.9] Recommendation ITU-T O.9 (1999), *Measuring arrangements to assess the degree of unbalance about earth.*
- [b-ITU-T T.35] Recommendation ITU-T T.35 (2000), *Procedure for the allocation of ITU-T defined codes for non-standard facilities.*
- [b-D 4566-98] American Society for Testing and Materials D 4566-98, *Standard Test Methods for Electrical Performance Properties of Insulations and Jackets for Telecommunications Wire and Cable.*

- [b-IEC 62255] IEC 62255-series (2003), *Multicore and symmetrical pair/quad cables for broadband digital communications (high bit rate digital access telecommunication networks) – Outside plant cables.*
<[http://webstore.iec.ch/webstore/webstore.nsf/searchview/?searchView=&Query=iec 62255](http://webstore.iec.ch/webstore/webstore.nsf/searchview/?searchView=&Query=iec%2062255)>
- [b-ISO 8601:2000] ISO 8601:2000, *Data elements and interchange formats – Information interchange – Representation of dates and times.*
<http://www.iso.org/iso/iso_catalogue/catalogue_tc/catalogue_detail.htm?csnumber=26780>

SERIES OF ITU-T RECOMMENDATIONS

Series A	Organization of the work of ITU-T
Series D	General tariff principles
Series E	Overall network operation, telephone service, service operation and human factors
Series F	Non-telephone telecommunication services
Series G	Transmission systems and media, digital systems and networks
Series H	Audiovisual and multimedia systems
Series I	Integrated services digital network
Series J	Cable networks and transmission of television, sound programme and other multimedia signals
Series K	Protection against interference
Series L	Construction, installation and protection of cables and other elements of outside plant
Series M	Telecommunication management, including TMN and network maintenance
Series N	Maintenance: international sound programme and television transmission circuits
Series O	Specifications of measuring equipment
Series P	Telephone transmission quality, telephone installations, local line networks
Series Q	Switching and signalling
Series R	Telegraph transmission
Series S	Telegraph services terminal equipment
Series T	Terminals for telematic services
Series U	Telegraph switching
Series V	Data communication over the telephone network
Series X	Data networks, open system communications and security
Series Y	Global information infrastructure, Internet protocol aspects and next-generation networks
Series Z	Languages and general software aspects for telecommunication systems