



INTERNATIONAL TELECOMMUNICATION UNION

**ITU-T**

TELECOMMUNICATION  
STANDARDIZATION SECTOR  
OF ITU

**M.1540**

(10/94)

**MAINTENANCE: DESIGNATIONS  
AND INFORMATION EXCHANGE**

---

**EXCHANGE OF INFORMATION  
FOR PLANNED OUTAGES  
OF TRANSMISSION SYSTEMS**

**ITU-T Recommendation M.1540**

(Previously "CCITT Recommendation")

---

## FOREWORD

The ITU-T (Telecommunication Standardization Sector) is a permanent organ of the International Telecommunication Union (ITU). The ITU-T is responsible for studying technical, operating and tariff questions and issuing Recommendations on them with a view to standardizing telecommunications on a worldwide basis.

The World Telecommunication Standardization Conference (WTSC), which meets every four years, establishes the topics for study by the ITU-T Study Groups which, in their turn, produce Recommendations on these topics.

The approval of Recommendations by the Members of the ITU-T is covered by the procedure laid down in WTSC Resolution No. 1 (Helsinki, March 1-12, 1993).

ITU-T Recommendation M.1540 was revised by ITU-T Study Group 4 (1993-1996) and was approved under the WTSC Resolution No. 1 procedure on the 15th of October 1994.

---

## NOTE

In this Recommendation, the expression "Administration" is used for conciseness to indicate both a telecommunication administration and a recognized operating agency.

© ITU 1995

All rights reserved. No part of this publication may be reproduced or utilized in any form or by any means, electronic or mechanical, including photocopying and microfilm, without permission in writing from the ITU.

## CONTENTS

	<i>Page</i>
1 General .....	1
2 Planned outages of international analogue, PDH and SDH transmission systems.....	1
3 Planned outages of national transmission systems, which affect international leased and special circuits....	3
Reference.....	3



## **EXCHANGE OF INFORMATION FOR PLANNED OUTAGES OF TRANSMISSION SYSTEMS**

*(Published as M.221 in 1976; revised and renumbered as M.490 in 1984;  
revised and renumbered as M.1540 in 1994)*

### **1 General**

*Planned outages* of transmission systems are required to allow planned work to be done with the minimum impairment to the service concerned. All tests, measurements, rearrangements, etc., which are not attributed directly to a failure – and are known in advance – are considered to be *planned work*. Such work will include installation of new equipment, routine maintenance, work on power supply equipment and in some cases, work for the clearance of faults which at first could only be remedied provisionally (mainly cable faults).

In the event of planned work which results in the complete or partial interruption in a transmission system, efforts are at first made to reroute the telecommunication traffic as required. If special restoration plans exist for cases of faults, these plans can also be used in the event of planned outages. Should rerouting be impossible, planned work is generally carried out during periods of light traffic, e.g. at night. To allow appropriate measures to be taken, all stations affected by the planned outage must be informed in good time.

### **2 Planned outages of international analogue, PDH and SDH transmission systems**

When an Administration plans the outage of an international transmission system, it should inform all other Administrations in whose territories the links terminate. This information should be given by telex, fax, etc. at least three working days in advance.<sup>1)</sup> When an outage is expected to affect QOS to a customer, it is deemed necessary to notify the Administrations at least 17 days in advance. An example is given in Figure 1. There are cases in which more than three days are necessary, such as those involving extensive rearrangements. If, in exceptional cases, a three-day notice cannot be given, advice should be given by telephone so as to ensure that the Administrations concerned still have sufficient time to take the appropriate steps. Planned outages should not be carried out if notice cannot be given and received at least 24 hours in advance.

In practice, Administrations have entrusted different entities, i.e. either their international centres or their technical services with the exchange of information for planned outages. Therefore, it is essential that each Administration states clearly to whom reports on outages are to be sent<sup>2)</sup>. In any case, the technical service of an Administration should be aware of the outages planned in its own country, and try to reduce their impact on international services to a minimum. Passing on of the information within the area of an Administration, e.g. to the control stations for leased and special circuits, or to the users of leased circuits, is done according to the national practice.

---

<sup>1)</sup> The time limit of three working days is not intended to affect other agreements in special cases, e.g. a notification time of two weeks in planned outages of submarine cable systems.

<sup>2)</sup> Normally such information is exchanged between the System Availability Information Points (see Recommendation M.721).

from: -----  
to: -----

Because of urgent work in our country the following groups and supergroups will be out of service from 20th March 23:00 to 21st March 06:00 (gmt):

ffm - luxemburg 6003  
ffm - paris 6002  
ffm - oslo 1202  
ffm - rotterdam 6002, 6005  
ffm - amsterdam 6002  
amsterdam - budapest 1201  
ffm - london 1214, 1246  
dusseldorf - milano 6001  
regards.

FIGURE 1/M.1540

**Example of a telex message concerning a planned outage of international groups and supergroups**

### **3 Planned outages of national transmission systems, which affect international leased and special circuits**

In the international centres, international leased and special circuits are frequently through-connected in the voice-frequency band and routed to the destination via national group links. An outage of these group links leads to a break in the international circuit. In this cases, informing the circuit control station and the users is of particular importance in order to avoid unnecessary fault location in the other country.

If an outage is planned for a national system within the area of the Administration being entrusted with the terminal sub-control function for a circuit, the circuit control station should be informed direct or via the two transmission maintenance points (international line) (see Recommendation M.1014 [1] or via the technical service so as to enable the control station to inform the user in good time. In addition, it may be advisable that the terminal sub-control station informs the user as its end of the circuit of the planned outage, since an exchange of information between the users at both ends of the circuit is not always possible. Figure 2 illustrates the possible flow of information for this case.

A similar procedure should be applied if a planned outage of a national system in a transit country affects an international leased or special circuit.

If an outage is planned for a national system within the area of an Administration having control functions for a circuit, it is recommended that the sub-control station be advised in order to avoid unnecessary queries in the event of a fault report being submitted by the user in the distant country concerned. The transmission maintenance point (international line) in its own country should be informed in any case.

#### **Reference**

- [1] CCITT Recommendation *Transmission maintenance point (international line) (TMP-IL)*, Rec. M.1014.

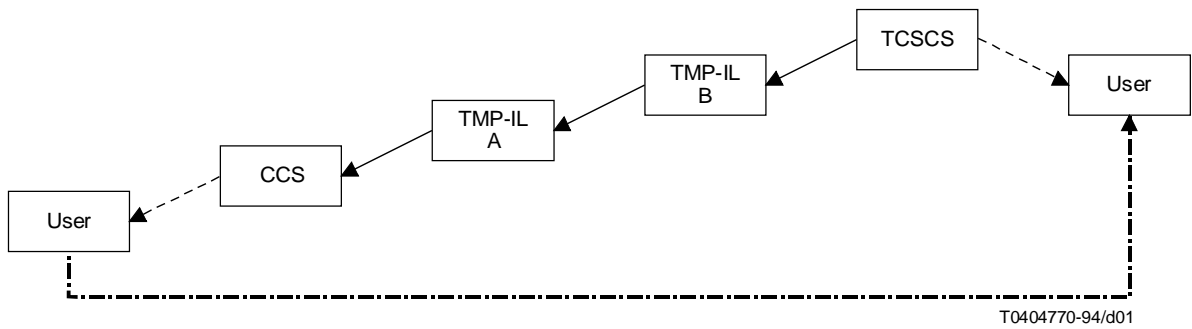
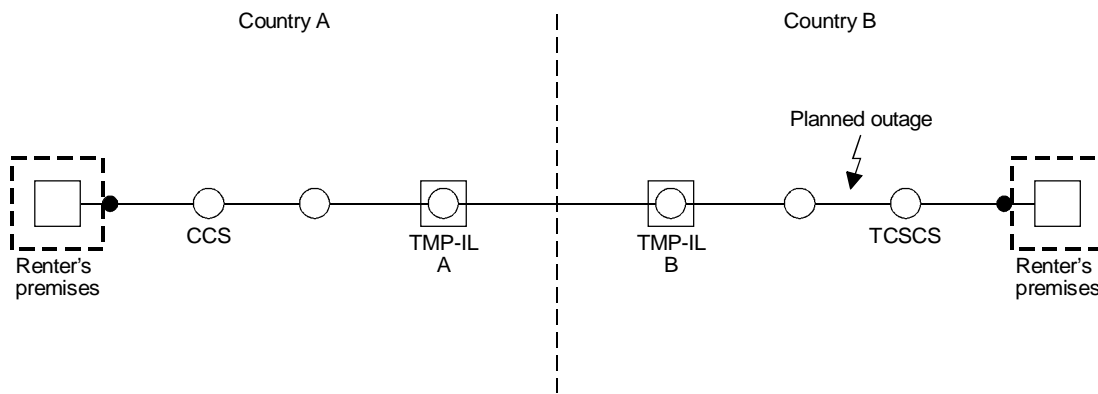

T0404770-94/d01





-  International centre
  -  National repeater station
  - CCS    Circuit control station
  - TCSCS    Terminal circuit sub-control station
  - TMP-IL    Transmission maintenance point – International line
-  Information flow between TCSCS and CCS
  -  Additional information flow
  -  Information flow between users

FIGURE 2/M.1540

**Example of a possible information flow in case of planned outage of a national transmission system affecting an international leased circuit**