



INTERNATIONAL TELECOMMUNICATION UNION

ITU-T

TELECOMMUNICATION
STANDARDIZATION SECTOR
OF ITU

P.370

(08/96)

SERIES P: TELEPHONE TRANSMISSION QUALITY

Subscribers' lines and sets

Coupling Hearing Aids to Telephone sets

ITU-T Recommendation P.370

(Previously "CCITT Recommendation")

ITU-T P-SERIES RECOMMENDATIONS
TELEPHONE TRANSMISSION QUALITY

Vocabulary and effects of transmission parameters on customer opinion of transmission quality	P.10-P.29
Subscribers' lines and sets	P.300-P.399
Subscribers' lines and sets	P.30-P.39
Transmission standards	P.40-P.49
Objective measuring apparatus	P.500-P.599
Objective measuring apparatus	P.50-P.59
Objective electro-acoustical measurements	P.60-P.69
Measurements related to speech loudness	P.70-P.79
Methods for objective and subjective assessment of quality	P.800-P.999
Methods for objective and subjective assessment of quality	P.80-P.99

For further details, please refer to ITU-T List of Recommendations.

FOREWORD

The ITU-T (Telecommunication Standardization Sector) is a permanent organ of the International Telecommunication Union (ITU). The ITU-T is responsible for studying technical, operating and tariff questions and issuing Recommendations on them with a view to standardizing telecommunications on a worldwide basis.

The World Telecommunication Standardization Conference (WTSC), which meets every four years, establishes the topics for study by the ITU-T Study Groups which, in their turn, produce Recommendations on these topics.

The approval of Recommendations by the Members of the ITU-T is covered by the procedure laid down in WTSC Resolution No. 1 (Helsinki, March 1-12, 1993).

ITU-T Recommendation P.370, was prepared by ITU-T Study Group 12 (1993-1996) and was approved under the WTSC Resolution No. 1 procedure on the 30th of August 1996.

NOTE

In this Recommendation, the expression "Administration" is used for conciseness to indicate both a telecommunication administration and a recognized operating agency.

© ITU 1997

All rights reserved. No part of this publication may be reproduced or utilized in any form or by any means, electronic or mechanical, including photocopying and microfilm, without permission in writing from the ITU.

CONTENTS

	<i>Page</i>
1 Scope	1
2 Normative references	1
3 Definitions and abbreviations.....	2
3.1 Definitions	2
3.2 Abbreviations.....	2
4 Magnetic field strength around the earcap of telephone handsets which provide for coupling to hearing aids	2
4.1 Introduction	2
4.2 Magnetic field strength measurements and recommended values	3
4.2.1 Calibration of acoustic receive level	3
4.2.2 Magnetic field strength level.....	4
4.2.3 Linearity of the magnetic field strength	4
4.2.4 Measurement of frequency characteristics.....	4
4.3 Probe coil.....	5
4.3.1 Dimensions	5
4.3.2 Calibration of the probe coil	5
4.3.3 Distortion	5
5 Characteristics of telephone sets that provide additional amplification for the benefit of hearing impaired users	6
5.1 Introduction	6
5.2 Sending characteristics	6
5.2.1 Sensitivity	6
5.2.2 Frequency response.....	6
5.3 Receiving characteristics	7
5.3.1 Sensitivity	7
5.3.2 Frequency response.....	7
5.3.3 Restoring normal receive amplification	7
5.4 Sidetone	7
6 Electrical coupling of telephone sets to hearing aids	8
6.1 Introduction	8
6.2 Electrical characteristics	8
6.2.1 Point of connection in the telephone set	8
6.2.2 Electrical characteristics at interconnection point.....	8
6.3 Interconnection with the telephone set	9
6.3.1 Connector type	9
6.3.2 Connector position	9
6.4 Safety issues.....	9
Annex A – Measurement of an acousto-magnetic adapter generating a magnetic field.....	10
A.1 Measurement procedures	10
A.2 Magnetic field requirements	10
A.3 Physical properties.....	10
Appendix I – Examples of frequency characteristics of hearing aids coupled to telephones	10
Appendix II – Bibliography.....	15

SUMMARY

This Recommendation has been updated from Recommendation P.37, Coupling Hearing Aids to Telephone sets.

Clause 4 covers inductive coupling and is technically similar to the original Recommendation P.37. Clause 4 however now includes the relevant figures that were previously referred out to other Recommendations. It presents recommended levels and frequency characteristics for the inductive field at the telephone earphone relative to a sound level presented at the same earphone.

Clause 5 covers additional amplification that may be provided for the benefit of hearing impaired users, and only editorial changes have been made to the text originally contained in Recommendation P.37. Limits for the additional amplification and range of volume control are given. Frequency response is also covered.

Clause 6 introduces the possibility of electrical coupling of a telephone set to a hearing aid. It is compatible with IEC Publication 118 Part 6, which covers the characteristics of hearing aid electrical input circuits. The electrical output level relative to the sound level in the same telephone's earphone is given in this Recommendation, together with frequency response, source impedance and maximum output level.

Technically this Recommendation is compatible with similar documents recently drafted within ETSI covering the same subjects.

FOREWORD

It is recognized that there is a sizeable proportion of telephone users that have difficulty in conversing over a telephone connection due to hearing loss. To alleviate these difficulties special means have been provided in many national systems to enable hearing impaired users to couple their hearing aids inductively to the telephone receiver, and a number of national/international specifications define characteristics for this form of coupling. Clause 4 addresses the requirements for successful inductive coupling of hearing aids to telephone sets.

Furthermore, it is also recognized that many hearing impaired users are able to have satisfactory telephone conversations while coupling their hearing aids acoustically to the telephone receiver, or even using the telephone handset without a hearing aid. This latter situation is possible due to the fact that under good conditions a telephone connection can be louder than a face-to-face conversation over a one-metre air path by up to 30 dB. Provision of additional amplification in the mouth-to-ear path can greatly increase the proportion of telephone conversations involving hearing impaired users that are rated "good". Clause 5 addresses this form of coupling.

Certain national standards also exist to enable direct electrical connection of hearing aids to telephone apparatus. This form of coupling is addressed in clause 6, and has been written to be compatible with the IEC Publication 118-6, 1984, covering the characteristics of electrical input circuits for hearing aids.

NOTES

1 Care should be taken when designing hearing aids to include sufficient immunity to radio frequency interference to avoid disturbances arising from the detection of radio signals emitted by cordless and mobile telephones.

2 Tests have shown that telephone earphones having low acoustic impedance, which exhibit less low frequency loss due to leakage effects, couple acoustically very well into hearing aids by presenting a much flatter overall frequency characteristic to the ear of the user than conventional earphones having high acoustic impedance.

COUPLING HEARING AIDS TO TELEPHONE SETS

(Geneva, 1996)

1 Scope

Clause 4 applies to telephone handsets having supra-aural earphones that can be connected to the Public Switched Telephone Network (PSTN) or the Integrated Services Digital Network (ISDN) which are intended for direct application to the ear (e.g. traditional handsets, operators' headsets) and which provide a magnetic field for coupling to hearing aids. It specifies the level, linearity and frequency dependence of the magnetic field strength produced by the handset and characteristics for the calibrated probe coil.

Clause 5 specifies the electro-acoustic performance characteristics of telephony terminals which are intended for direct application to the ear (e.g. traditional handsets, operators' headsets) and which provide, at the earphone, additional amplification in the receiving direction compared with the Receiving Loudness Rating (RLR) specified in the requirements of the national system.

Clause 6 specifies the electrical characteristics for the electrical coupling of the telephony function, implemented telecommunication terminal equipment, to hearing aids. It specifies the level and frequency response relative to the acoustic output at the earphone, also the noise and maximum level.

Annex A specifies the measuring method for an acousto-magnetic adapter that converts the acoustic output of an associated telephone receiver to a magnetic field, in accordance with 4.2.1 and 4.2.2, that can be received by the magnetic pick-up coil in a hearing aid.

2 Normative references

The following Recommendations, and other references contain provisions which, through reference in this text, constitute provisions of this Recommendation. At the time of publication, the editions indicated were valid. All Recommendations and other references are subject to revision; all users of this Recommendation are therefore encouraged to investigate the possibility of applying the most recent edition of the Recommendations and other references listed below. A list of the currently valid ITU-T Recommendations is regularly published.

- IEC Publication 118-6: 1984, *Hearing aids – Part 6: Characteristics of electrical input circuits for hearing aids*.
- ITU-T Recommendation P.10 (1993), *Vocabulary of terms on telephone transmission quality and telephone sets*.
- IEC Publication 118-4: 1981, *Hearing aids – Part 4: Magnetic field strength in audio-frequency induction loops for hearing aid purposes*.
- IEC Publication 118-1: 1995, *Hearing aids – Part 1: Hearing aids with induction pick-up coil input*.
- ITU-T Recommendation P.340 (1996), *Transmission characteristics of hands-free telephones*.
- ITU-T Recommendation G.121 (1993), *Loudness Ratings (LRs) of national systems*.
- IEC Publication 130-8: 1976, *Connectors for frequencies below 3 MHz – Part 8: Concentric connectors for audio circuits in radio receivers*.
- IEC Publication 268-11: 1987, *Sound system equipment – Part 11: Application of connectors for the interconnection of sound system equipment*.
- ITU-T Recommendation P.57 (1993), *Artificial ears*.
- CCITT Recommendation P.48 (1988), *Specification for an intermediate reference system*.

¹⁾ Previously Recommendation P.37.

3 Definitions and abbreviations

3.1 Definitions

The relevant definitions given in Recommendation P.10 apply along with the following:

3.1.1 level of magnetic field strength: the maximum level of the magnetic field strength and its measurement are given in 4.2.2. The units are amperes per metre (A/m).

3.1.2 plane of measurement: A plane parallel to the earcap at a distance of 10 mm.

3.1.3 The adapter plane: It is defined as the plane formed by the contacting points of a flat surface against the surface of the acousto-magnetic adapter opposite the earcap connection.

3.2 Abbreviations

For the purposes of this Recommendation, the following abbreviations are used.

AGC	Automatic Gain Control
DRP	Drum Reference Point
ERP	Ear Reference Point
HATS	Head and Torso Simulator
IEC	International Electrotechnical Commission
IRS	Intermediate Reference System
ISDN	Integrated Services Digital Network
LSTR	Listener Sidetone Rating
OLR	Overall Loudness Rating
p_e	Sound pressure level at the ERP
PSTN	Public Switched Telephone Network
RLR	Receiving Loudness Rating
SLR	Sending Loudness Rating
STMR	Sidetone Masking Rating
TCL	Terminal Coupling Loss

4 Magnetic field strength around the earcap of telephone handsets which provide for coupling to hearing aids

4.1 Introduction

Magnetic induction systems incorporated in telephone handsets generate an alternating magnetic field with spatial characteristics which make the field detectable by hearing aids equipped with induction pick-up coils.

Reception of an audio-frequency signal via an induction pick-up coil can often allow an acceptable signal-to-noise ratio to be achieved in cases where the acoustical reception would otherwise be degraded by background noise.

The magnetic field strength which enables induction pick-up coils in hearing aids to function effectively must be high enough to produce an acceptable signal-to-noise ratio but not so high as to cause overloading of the hearing aid.

The value of the magnetic field strength recommended in this Recommendation has been chosen so that these requirements are met as far as possible. (See Bibliography [1] for a discussion on end-to-end levels that can be expected for hearing aid users coupled inductively to a telephone set. This can be compared with the preferred listening levels for users having normal hearing [2]).

Information on the measurement of an acoustic-magnetic adapter generating a magnetic field is found in Annex A.

4.2 Magnetic field strength measurements and recommended values

4.2.1 Calibration of acoustic receive level

Using the measurement configuration shown in Figure 1 for analogue telephones, Figure 2 for digital telephones, the drive level of the oscillator shall be adjusted to produce a sound pressure level of -14 dBPa (80 dB SPL) at 1000 Hz. This drive level shall be used for determining the level and frequency characteristics of the magnetic field strength.

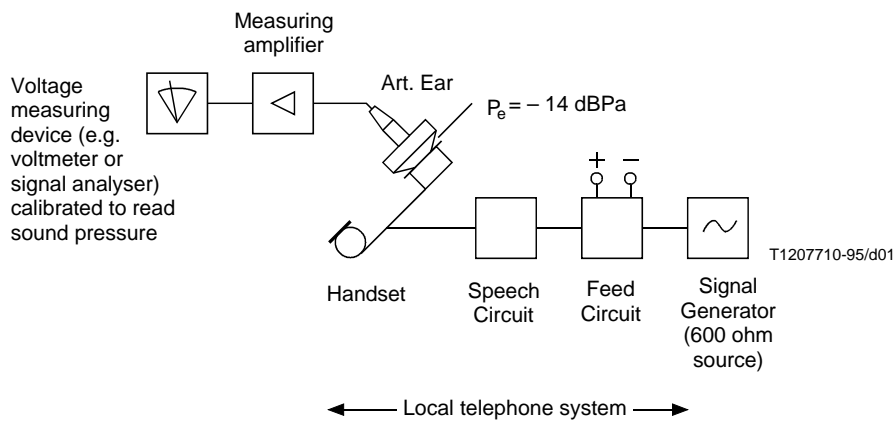

FIGURE 1/P.370

Setting the sound pressure level p_e in the artificial ear for an analogue for telephone set

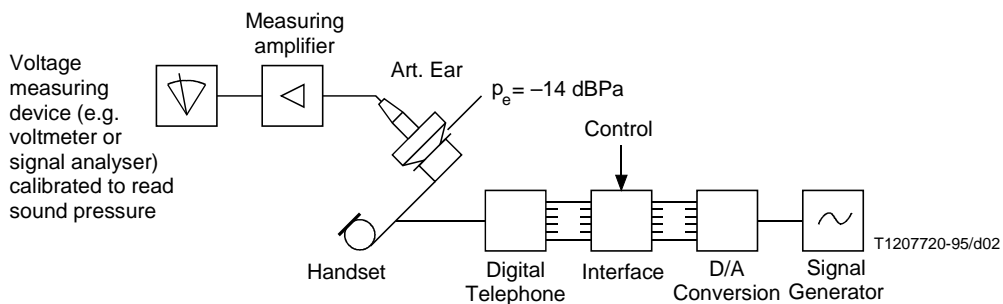

FIGURE 2/P.370

Setting the sound pressure level p_e in the artificial ear for a digital telephone set

4.2.2 Magnetic field strength level

Place the centre of the calibrated probe coil (see 4.3) in the plane of measurement and orientate it in any direction for maximum coupling. Determine the magnetic field strength at 1000 Hz using the drive level as given in 4.2.1.

Recommended range of values for the magnetic field strength is:

$$-17 \text{ to } -30 \text{ dB relative to 1 A/m.}$$

NOTE – For effective performance, hearing aids with magnetic pick-up coils primarily intended for coupling to magnetic loops in auditoria in accordance with IEC Publication 118-4 are likely to require a field strength in the upper end of the range, i.e. -17 to -25 dB relative to 1 A/m.

4.2.3 Linearity of the magnetic field strength

With the probe coil positioned as in 4.2.2, increase the 1000 Hz drive level specified in 4.2.1 by 20 dB and measure the resulting magnetic field strength.

The field strength should increase by $20 \text{ dB} \pm 1 \text{ dB}$.

4.2.4 Measurement of frequency characteristics

With probe coil positioned as in 4.2.2, and the 1000 Hz drive level specified in 4.2.1, vary the frequency from 300 Hz to 5000 Hz for analogue telephones and to the upper frequency limit for digital telephones (4000 or 7000 Hz) as appropriate and measure the resulting field strength. The magnetic field strength frequency characteristics shall fit within the template shown in Figure 3.

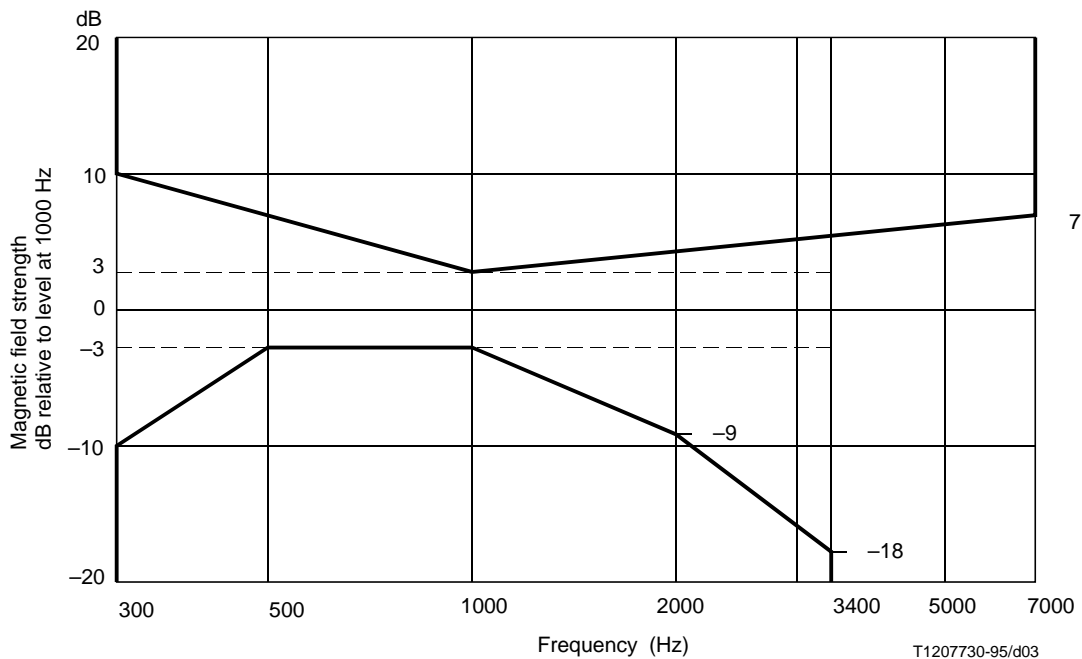

NOTE – Preferred frequency characteristics are within the dotted lines (± 3 dB). Range of acceptable characteristics is within the solid lines.

FIGURE 3/P.370
Magnetic field strength characteristics

4.3 Probe coil

4.3.1 Dimensions

To minimize the loss of resolution when measuring the magnetic field strength, the following **maximum** dimensions are recommended for the calibrated coil:

Core:	length:	13.5 mm
	cross-section:	1.5 × 2.5 mm
Winding:	length:	11 mm
	cross-section:	2.5 × 3.5 mm

The winding shall be shorter than the core.

NOTES

1 The magnetic field may be non-homogeneous within distances comparable to the length of the probe coil. The introduction of magnetic core material may also redirect the magnetic field contours. Typically the sensitivity of the probe coil will increase with frequency at 6 dB/octave.

2 The probe coil may be combined with frequency correcting elements to obtain a flat frequency response over the range of interest.

3 The North American Standard EIA/TIA RS 504 [3], as included in the FCC Rules, Part 68.316 [4], refers to a commercially available probe coil meeting the requirements of this Recommendation.

4.3.2 Calibration of the probe coil

In order to calibrate the probe, a homogeneous magnetic field of known intensity shall be available. The magnetic field strength at the centre of a square loop of one turn with a side of “a” metres and carrying a current of “i” amperes is given by:

$$H = \frac{2\sqrt{2}}{\pi} \cdot \frac{i}{a} \quad A/m$$

The dimension “a” should be 0.5 m or more to ensure that the field at the centre is sufficiently well defined in magnitude and direction.

In practice, it may be advantageous to construct the loop having several turns to reduce the current from the source. Essentially, constant current conditions should be maintained over the test frequency range, for example driving the coil from a low impedance generator through a series resistor having at least 100 times the impedance of the coil over the frequency range of interest. If the current drive is monitored during the calibration process, any variations can be taken into account when deriving the probe coil sensitivity.

The test space shall be remote from any field disturbing magnetic material or other material in which eddy currents can be induced, so causing a field disturbance.

The sensitivity as a function of frequency of the probe coil shall be measured as the induced voltage over both leads of the probe coil with an accuracy of ±0.5 dB. This voltage is the standard in relation to the applied current per metre and shall be used for the measurement of the requirements specified in 4.2.2.

The total harmonic distortion of the magnetic field shall be less than 1%.

NOTE – Further helpful information is given in IEC Publication 118-1.

4.3.3 Distortion

The total harmonic distortion of the probe coil shall be less than 2%, when measuring the field strength up to +2 dB relative to 1 A/m.

5 Characteristics of telephone sets that provide additional amplification for the benefit of hearing impaired users

5.1 Introduction

This clause specifies the requirements for telephones with receive amplification intended to aid the hearing impaired. A significant proportion of the population is disabled by varying degrees of hearing loss, often associated with a reduction of speech discrimination ability. Amplification can only replace the lost sensitivity.

The group most likely to receive the greatest benefit from the use of a telephone with additional receive amplification are those with moderate to severe hearing losses in the range of 35 dB to 80 dB.

In setting the numerical values in this Recommendation, consideration has been given to the fact that the sound pressure levels at the ear during a telephone conversation can be up to 30 dB above those occurring in normal face-to-face conversation (at one metre distance). As hearing impaired people do not necessarily have elevated thresholds of loudness discomfort, some form of output limitation will be required. Recent work has indicated that Automatic Gain Control (AGC) may provide a better automatic means of limitation than peak clipping. In addition, it is recognized that the frequency response to give maximum intelligibility to some hearing impaired people may require shaping.

Two types of application are envisaged. Firstly, where the telephone will be used by persons with a range of hearing acuity, secondly, where the telephone is to be used in the main by a hearing impaired person. In the first, it may be preferable to arrange that the additional amplification is brought into use by the operation of a latching switch that automatically resets the gain to nominal level when the handset is replaced in its rest position. In the second case it will be advantageous to maintain the receive amplification (the level of which is selected by means of a volume control set by the hearing impaired user) when the handset is replaced. The use of voice switched attenuation, perhaps 10 dB to 12 dB, may be necessary to provide protection against instability, in particular for the first case, and could also improve the discrimination against the ambient noise received through the sidetone path.

It is estimated that with the provision of additional amplification to the levels recommended below, possibly up to 80% of hearing impaired users would benefit even when not using their hearing aids to couple to the telephone set. If a hearing aid is worn in addition and inductive coupling is also provided, then the proportion of hearing impaired users who will be able to have satisfactory telephone conversations will increase further. It is, however, pointed out that with a high gain setting selected, the sound level and/or inductive field at the earphone may be considerably higher than normally experienced by hearing aid microphones and/or inductive pick-up coils and, on short telephone connections in particular, there is a very real danger of overloading the input stages of the hearing aid.

The inclusion of additional receiving amplification does not reduce or replace existing technical standards that apply to a handset. Additional receiving amplification can be combined with other additional functionality, such as inductive coupling or additional earpieces, provided specifically for people with special needs.

5.2 Sending characteristics

5.2.1 Sensitivity

It is recommended that when the user is talking, the Sending Loudness Rating (SLR) remains at a constant value set by the requirements of the national system, irrespective of any receive amplification selected.

If voice switching is used in the interests of preserving stability margins and/or Terminal Coupling Loss (TCL) under difficult operating conditions, it is recommended that the switched attenuation be the minimum required for the purpose, e.g. approximately equal to that required to offset any increased receiving amplification selected.

5.2.2 Frequency response

It is recommended that the sending frequency response is maintained according to the requirements of the national system irrespective of any increased receive amplification selected.

5.3 Receiving characteristics

5.3.1 Sensitivity

In respect of the receive sensitivity, it is recommended that when no additional amplification is selected the Receiving Loudness Rating (RLR) requirements of the national system are met.

With additional receive amplification selected, the RLR may be set up to 20 dB more negative (louder) than the nominal requirements of the national system.

It shall be permissible to set the RLR up to 15 dB more positive (quieter) than the nominal requirements of the national system.

If additional amplification is provided in association with voice switching functions then the principles outlined in 4.6/P.340 are recommended. The depth of switched attenuation should be kept to a minimum in the interests of good speech quality but should be sufficient to maintain stability, return loss and TCL requirements.

5.3.2 Frequency response

When no additional amplification is selected, it is recommended that the receive frequency response meets the requirements of the national system.

With additional amplification selected, under some conditions and for particular hearing impaired users, it may be appropriate to provide special frequency shaping. For example, shaping could be provided to compensate for the loss of low frequencies caused by earcap leakage effects that occur with most types of telephone earphone. Earphones having low acoustic impedance are an exception to this (see Note 2, Foreword). An alternative shaping might be to provide additional gain at high frequencies to compensate for their loss over long local subscriber lines. Any frequency shaping provided could be by means of an additional control.

NOTE – In practice, when coupling to a hearing aid inductively or acoustically, the low frequencies are normally missing, and for acoustic coupling to conventional earphones there is usually a slope of 12 to 18 dB per octave at frequencies below the first mechanical resonance, often around 1500 Hz. Some examples are shown in Appendix I.

5.3.3 Restoring normal receive amplification

Option A – Telephones to be used by any user

At the termination of the telephone conversation any additional amplification selected shall be cancelled and the nominal RLR values restored by the action of replacing the handset to its rest position, or an equivalent action.

Option B – Telephones to be used mainly by a hearing impaired user

For the benefit of a hearing impaired user frequently using the terminal, the option may be provided for the additional amplification selected during a telephone conversation to be locked in position. If this option is provided, additional measures to ensure stability with maximum gain selected may be necessary.

5.4 Sidetone

It is recommended that sidetone levels (STMR, LSTR) indicated in Recommendation G.121 be provided when additional amplification is not in use.

With additional amplification selected, it will normally only be possible to maintain recommended sidetone levels if voice switching techniques are used.

6 Electrical coupling of telephone sets to hearing aids

6.1 Introduction

This clause covers the possibility of electrical coupling from a telephone set to a hearing aid. It is intended to be compatible with the IEC Publication 118-6, which covers the characteristics of electrical input ports for hearing aids.

It is also envisaged that it could be used in other applications that require electrical connection to the PSTN, for example to couple into other non-telephony amplification systems such as public address, or recording systems. Another alternative would be the direct electrical connection to a hearing aid transducer or headset, given that the device had sufficient sensitivity. This clause may also find application for mobile apparatus and apparatus having cordless handsets that provide for electrical coupling to hearing aids. Some of the applications envisaged would need to address safety and/or protection issues and, although these and the applications themselves do not come within the scope of ITU Recommendations, attention is drawn to them here for information.

6.2 Electrical characteristics

Unless otherwise stated all the requirements given below are for the volume control (if present) set to give the maximum output.

6.2.1 Point of connection in the telephone set

It is recommended that the interconnection to the hearing aid be taken from the electrical path to the handset earphone so that the sidetone path is coupled into the hearing aid. It is also recommended that it shall not be possible to inject a signal into the telecommunication network from this point.

6.2.2 Electrical characteristics at interconnection point

In what follows it is assumed that the load normally applied by a hearing aid input circuit will be 2000 ohms resistive.

6.2.2.1 Calibration of the acoustic receive level

Using the measurement configuration shown in Figure 1 for analogue telephones and Figure 2 for digital telephones, the drive level of the oscillator shall be adjusted to produce a sound level of -14 dBPa at 1000 Hz at the ERP (Ear Reference Point). This drive level shall be used for measuring the impedance, sensitivity and frequency characteristics recommended below.

6.2.2.2 Impedance

The modulus of the electrical source impedance between the frequencies of 300 and 4000 Hz shall be less than 1000 ohms for all settings of the volume control (if present).

6.2.2.3 Sensitivity

With the drive level of the oscillator set as in 6.2.2.1 above, at 1000 Hz, the electrical output at 1000 Hz shall be -35 ± 5 dBV. With the volume control (if present) set to minimum the electrical output shall be between 15 dB and 30 dB lower than the output at the maximum setting.

6.2.2.4 Frequency characteristic

With the drive level of the oscillator set as in 6.2.2.1 above, the frequency response at the telephone electrical interconnection point, when loaded with 2 k Ω , shall be equal to the sensitivity at 1000 Hz ± 3 dB over the range 300 to 4000 Hz and ± 5 dB over the range 100 to 300 Hz for all settings of the volume control (if present).

6.2.2.5 Noise

With the oscillator in 6.2.2.1 replaced by a 600 ohm resistor the noise level at the electrical interconnection point shall be less than -70 dBVp r.m.s.

6.2.2.6 Maximum output

With the oscillator in 6.2.2.1 set to give $+20$ dBV r.m.s. the maximum output at the electrical interconnection point shall be limited to 0 dBV.

6.2.2.7 Insulation

In order to prevent direct electrical connection with the PSTN it is recommended that the interconnection point be electrically isolated by use of, for example, a transformer. It is recommended that the insulation provided should meet the requirements of the national system.

6.3 Interconnection with the telephone set

6.3.1 Connector type

The connection shall be by means of a socket which is compatible with a miniature coaxial, stereo jack plug, type 130-8 IEC, conforming to IEC 268-11. Normally the socket shall be of 3.5 mm diameter. Alternatively, for compact telephone sets such as cordless or mobile telephones, the socket may be of 2.5 mm diameter.

6.3.2 Connector position

It is recommended that the connector socket should be positioned on the telephone for high visibility and ease of inserting the plug. This means that the socket should be placed on the front edge, front top side or on the front sides of the subset housing. The socket should be placed so that the plug and lead will not interfere with the normal operation of the telephone, i.e. lifting/replacing the handset, dialling, inserting coins or cards, or any other functions. On public telephones it is important that the socket is not positioned on a horizontal surface making it susceptible to the ingress of fluids or other contaminants. Telephones and mobile telephones with cordless handsets shall not have the connector on the handset but on the body of the subset.

One-piece telephones, cordless telephones and mobile telephones which have no separate handset, the socket should be positioned so that the plug and the lead will not interfere with the normal operation of the instrument, i.e. holding it, dialling, charging batteries, or any other function.

6.4 Safety issues

It is recommended that other safety issues associated with the interconnection point should meet the requirements of the national system.

Annex A

Measurement of an acousto-magnetic adapter generating a magnetic field

(This annex forms an integral part of this Recommendation)

A.1 Measurement procedures

Measurements are made in accordance with this Recommendation.

The output sound pressure level of the telephone receiver is measured against the artificial ear without the acousto-magnetic adapter being mounted.

The characteristics of the magnetic field of the acousto-magnetic adapter are measured when mounted on the actual telephone receiver.

NOTE – In reporting results, the type of telephone set used should be specified.

A.2 Magnetic field requirements

The magnetic field produced by the adapter when fitted to a handset should meet the level and frequency characteristic requirements given in 4.2.1 and 4.2.2.

A.3 Physical properties

Desirable physical properties of the acousto-magnetic adapter are:

- easy to place on the earcap and remove again;
- a firm contact to the earcap so that the acousto-magnetic adapter and the telephone handset can be used as an integral unit;
- forming a good and well-defined acoustic coupling to the earcap (see Note);
- the surface of the acousto-magnetic adapter defining the adapter plane should be flat or should have a shape easily defining the adapter plane;
- the adapter plane should be approximately parallel to the earcap plane;
- the magnetic field produced by the adapter should be orientated so that the magnetic coupling to the hearing aid is only to a small extent dependent on the position of the hearing aid.

NOTE – The inner diameter of an acoustic seal is recommended to be equal to the edge diameter of the IEC 318 artificial ear (see Recommendation P.57).

Appendix I

Examples of frequency characteristics of hearing aids coupled to telephones

(This appendix does not form an integral part of this Recommendation)

Figures I.1 to I.9 have been taken from [1] and illustrate the signals arriving at the Drum Reference Point (DRP) of a Head And Torso Simulator (HATS). Figure I.2 refers to the IRS (see Recommendation P.48) sending and receiving ends joined directly together and having an OLR by definition of 0 dB. All other figures are for a British Telecom Tribune set coupled to various UK hearing aids, (except where the Beocom telephone is mentioned) driven from the equivalent of the IRS send end with 10 dB additional loss. Thus the “connection” is what might be termed “typical” having an OLR approximating to 10 dB, i.e. similar to the ITU-T long-term aim for OLR.

Note particularly the rising frequency characteristics under all coupled conditions.

Telephony

Sound level @ MRP	Loss	Sound level @ ERP
89.3 dBSPL (pure tone)	1.1 dB	88.2 dBSPL (1 kHz)
88.8 dBSPL (Speech)	5.5 dB	83.3 dBSPL (0.2 to 4 kHz)

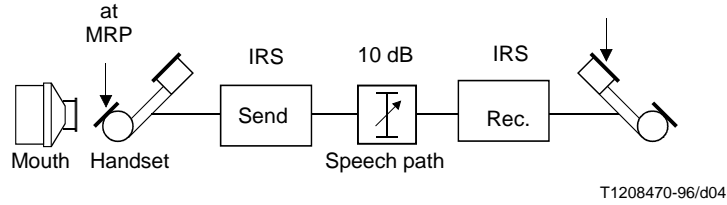

Metre air path

89.3 dBSPL (Speech) (100-8000 Hz)	30.2 dB	59.1 dBSPL (Free field)
	29.0 dB	63.3 dBSPL (including room & head effects)
88.8 dBSPL (Speech) (200-4000 Hz)	28.9 dB	62.9 dBSPL (including room & head effects)

FIGURE I.1/P.370

Speech mouth to ear losses for a typical telephone connection, having an OLR of 10 dB, and a metre air path

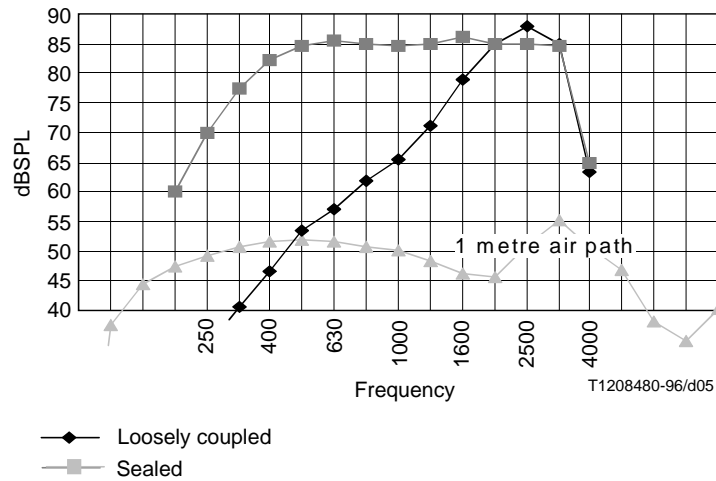

FIGURE I.2/P.370

Comparison of speech via a telephone and 1-metre air path

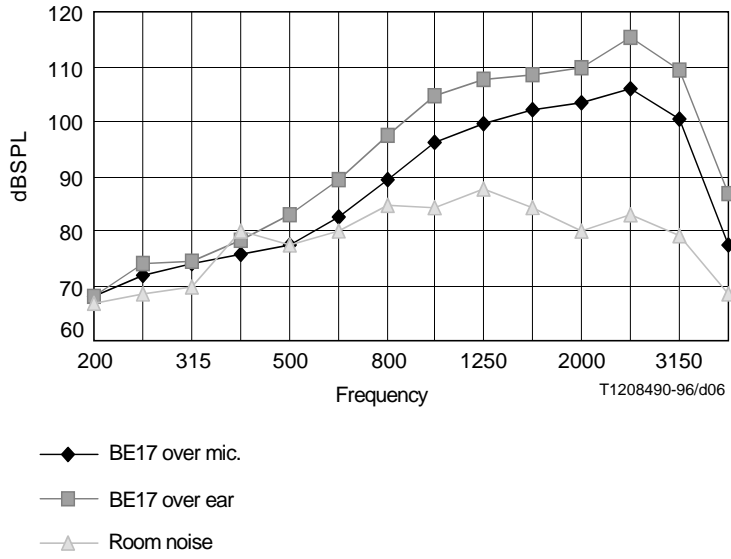

FIGURE I.3/P.370

Acoustic coupling – effect of position

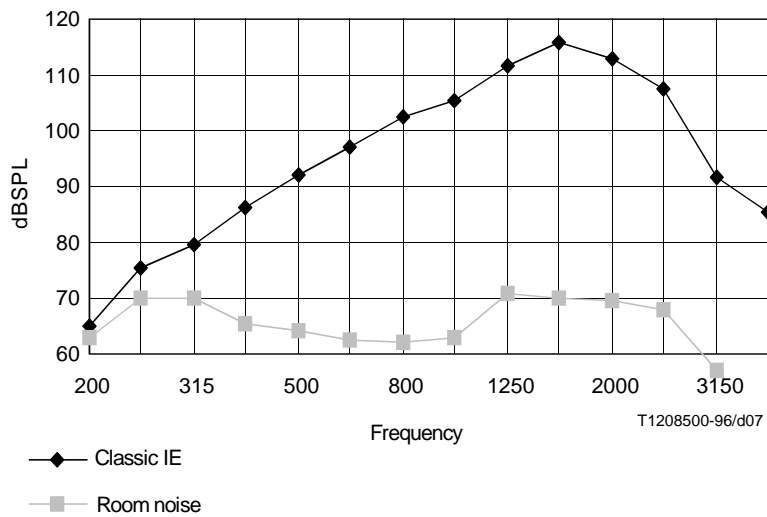

FIGURE I.4/P.370

Acoustic coupling – in the ear aid (Classic)

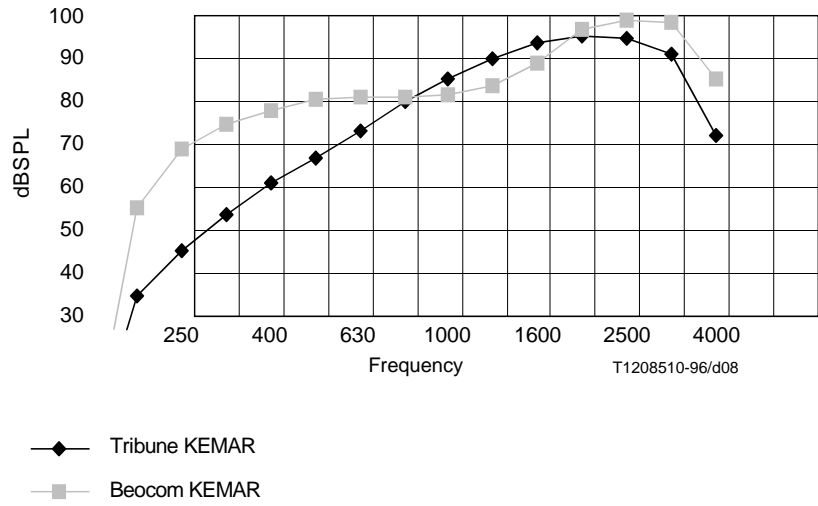

FIGURE I.5/P.370

Effect of low acoustic impedance on response

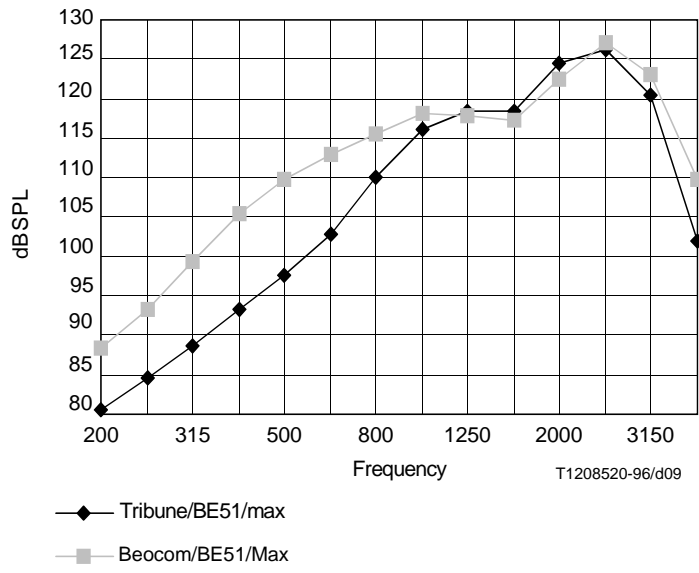

FIGURE I.6/P.370

Effect of low acoustic impedance on coupling to BE51 hearing aid

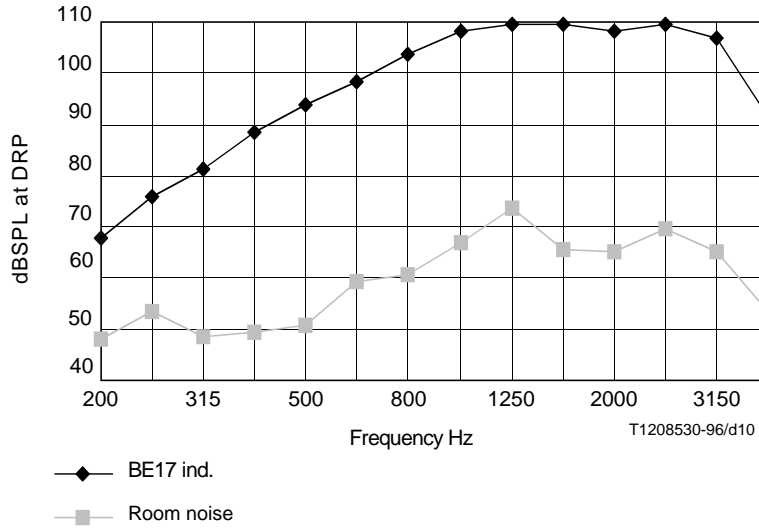

FIGURE I.7/P.370
Inductive coupling – BE17 aid over a typical connection

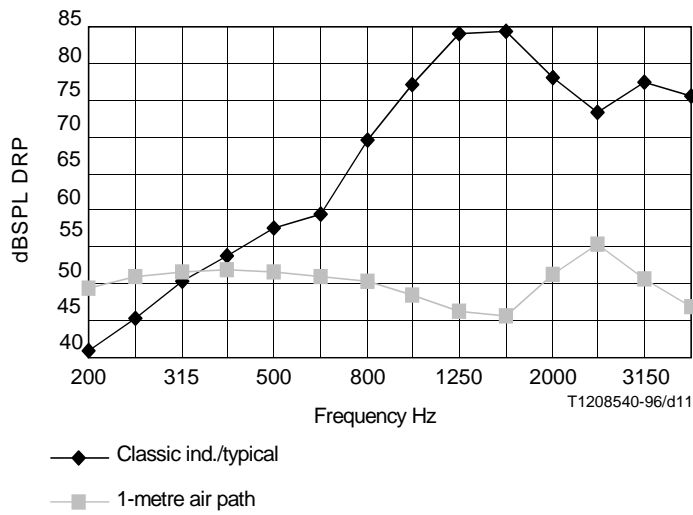

FIGURE I.8/P.370
Inductively coupled Classic in the ear aid over a typical connection

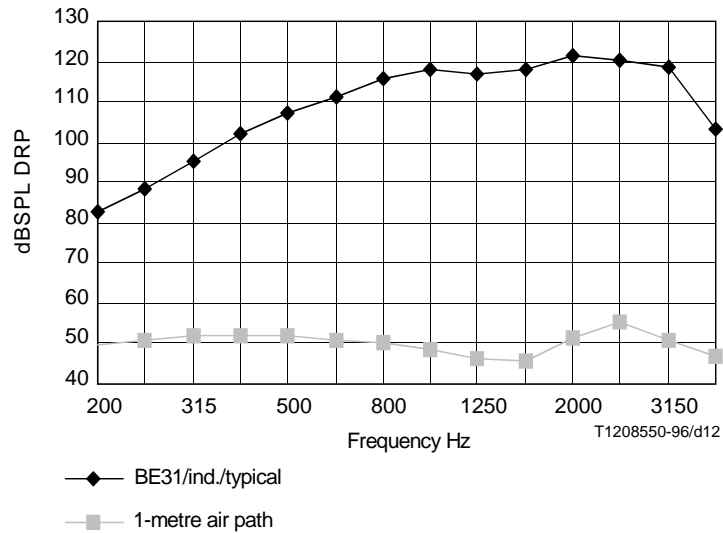

FIGURE I.9/P.370
Inductively coupled BE31 aid over a typical connection

Appendix II

Bibliography

(This appendix does not form an integral part of this Recommendation)

- [1] BARNES (G.J.): What do we hear through the telephone?, *British Society of Audiologists*, Leeds, April 1996.
- [2] GLEISS, (N.): Preferred listening levels in telephony, *Tele Engl. Ed.*, No. 2, 1974.
- [3] EIA/TIA RS 504: *North American Standard*.
- [4] FCC Rules, Part 68.316.

ITU-T RECOMMENDATIONS SERIES

- Series A Organization of the work of the ITU-T
- Series B Means of expression
- Series C General telecommunication statistics
- Series D General tariff principles
- Series E Telephone network and ISDN
- Series F Non-telephone telecommunication services
- Series G Transmission systems and media
- Series H Transmission of non-telephone signals
- Series I Integrated services digital network
- Series J Transmission of sound-programme and television signals
- Series K Protection against interference
- Series L Construction, installation and protection of cables and other elements of outside plant
- Series M Maintenance: international transmission systems, telephone circuits, telegraphy, facsimile and leased circuits
- Series N Maintenance: international sound-programme and television transmission circuits
- Series O Specifications of measuring equipment
- Series P Telephone transmission quality**
- Series Q Switching and signalling
- Series R Telegraph transmission
- Series S Telegraph services terminal equipment
- Series T Terminal equipments and protocols for telematic services
- Series U Telegraph switching
- Series V Data communication over the telephone network
- Series X Data networks and open system communication
- Series Z Programming languages