

International Telecommunication Union

ITU-T

TELECOMMUNICATION
STANDARDIZATION SECTOR
OF ITU

P.57

(06/2021)

SERIES P: TELEPHONE TRANSMISSION QUALITY,
TELEPHONE INSTALLATIONS, LOCAL LINE
NETWORKS

Objective measuring apparatus

Artificial ears

Recommendation ITU-T P.57

ITU-T



ITU-T P-SERIES RECOMMENDATIONS

TELEPHONE TRANSMISSION QUALITY, TELEPHONE INSTALLATIONS, LOCAL LINE NETWORKS

Vocabulary and effects of transmission parameters on customer opinion of transmission quality	P.10–P.19
Voice terminal characteristics	P.30–P.39
Reference systems	P.40–P.49
Objective measuring apparatus	P.50–P.59
Objective electro-acoustical measurements	P.60–P.69
Measurements related to speech loudness	P.70–P.79
Methods for objective and subjective assessment of speech quality	P.80–P.89
Voice terminal characteristics	P.300–P.399
Objective measuring apparatus	P.500–P.599
Measurements related to speech loudness	P.700–P.709
Methods for objective and subjective assessment of speech and video quality	P.800–P.899
Audiovisual quality in multimedia services	P.900–P.999
Transmission performance and QoS aspects of IP end-points	P.1000–P.1099
Communications involving vehicles	P.1100–P.1199
Models and tools for quality assessment of streamed media	P.1200–P.1299
Telemeeting assessment	P.1300–P.1399
Statistical analysis, evaluation and reporting guidelines of quality measurements	P.1400–P.1499
Methods for objective and subjective assessment of quality of services other than speech and video	P.1500–P.1599

For further details, please refer to the list of ITU-T Recommendations.

Recommendation ITU-T P.57

Artificial ears

Summary

Recommendation ITU-T P.57 specifies the electro-acoustical characteristics of artificial ears to be used for telephonometric measurements. Four devices are specified: a telephone band type for measurements on traditional telephone sets, an insert earphone type, a type faithfully reproducing the characteristics of the human ear and a type faithfully reproducing the characteristics of the human ear including an average adult human ear canal.

History

Edition	Recommendation	Approval	Study Group	Unique ID*
1.0	ITU-T P.57	1993-03-12	XII	11.1002/1000/1747
2.0	ITU-T P.57	1996-08-30	12	11.1002/1000/3636
3.0	ITU-T P.57	2002-07-14	12	11.1002/1000/6082
3.1	ITU-T P.57 (2002) Cor. 1	2005-01-27	12	11.1002/1000/7827
4.0	ITU-T P.57	2005-11-29	12	11.1002/1000/8676
5.0	ITU-T P.57	2009-04-29	12	11.1002/1000/9732
6.0	ITU-T P.57	2011-12-14	12	11.1002/1000/11457
7.0	ITU-T P.57	2021-02-13	12	11.1002/1000/14599
8.0	ITU-T P.57	2021-06-13	12	11.1002/1000/14662

Keywords

Quality of service measurement, speech quality.

* To access the Recommendation, type the URL <http://handle.itu.int/> in the address field of your web browser, followed by the Recommendation's unique ID. For example, <http://handle.itu.int/11.1002/1000/11830-en>.

FOREWORD

The International Telecommunication Union (ITU) is the United Nations specialized agency in the field of telecommunications, information and communication technologies (ICTs). The ITU Telecommunication Standardization Sector (ITU-T) is a permanent organ of ITU. ITU-T is responsible for studying technical, operating and tariff questions and issuing Recommendations on them with a view to standardizing telecommunications on a worldwide basis.

The World Telecommunication Standardization Assembly (WTSA), which meets every four years, establishes the topics for study by the ITU-T study groups which, in turn, produce Recommendations on these topics.

The approval of ITU-T Recommendations is covered by the procedure laid down in WTSA Resolution 1.

In some areas of information technology which fall within ITU-T's purview, the necessary standards are prepared on a collaborative basis with ISO and IEC.

NOTE

In this Recommendation, the expression "Administration" is used for conciseness to indicate both a telecommunication administration and a recognized operating agency.

Compliance with this Recommendation is voluntary. However, the Recommendation may contain certain mandatory provisions (to ensure, e.g., interoperability or applicability) and compliance with the Recommendation is achieved when all of these mandatory provisions are met. The words "shall" or some other obligatory language such as "must" and the negative equivalents are used to express requirements. The use of such words does not suggest that compliance with the Recommendation is required of any party.

INTELLECTUAL PROPERTY RIGHTS

ITU draws attention to the possibility that the practice or implementation of this Recommendation may involve the use of a claimed Intellectual Property Right. ITU takes no position concerning the evidence, validity or applicability of claimed Intellectual Property Rights, whether asserted by ITU members or others outside of the Recommendation development process.

As of the date of approval of this Recommendation, ITU had received notice of intellectual property, protected by patents/software copyrights, which may be required to implement this Recommendation. However, implementers are cautioned that this may not represent the latest information and are therefore strongly urged to consult the appropriate ITU-T databases available via the ITU-T website at <http://www.itu.int/ITU-T/ipr/>.

© ITU 2021

All rights reserved. No part of this publication may be reproduced, by any means whatsoever, without the prior written permission of ITU.

Table of Contents

		Page
1	Scope and object.....	1
	1.1 Scope	1
	1.2 Object	1
2	References.....	1
3	Definitions	2
	3.1 Terms defined elsewhere.....	2
	3.2 Terms defined in this Recommendation.....	2
4	Abbreviations and acronyms	4
5	Conventions	5
6	Artificial ear types	5
	6.1 Type 1 artificial ear	5
	6.2 Type 2 artificial ear	6
	6.3 Type 3 artificial ear	8
	6.4 Type 4 artificial ear	19
	6.5 Calibration of the artificial ears type 1 and type 3.2	43
	6.6 Performance verification of the artificial ears types 2, 3.1, 3.3 and 3.4.....	46
	6.7 Atmospheric reference conditions.....	46
	6.8 General requirements.....	46
	6.9 Ear-drum reference point to ear reference point correction	46
7	Idle noise floor.....	46
Annex A – A practical procedure for determination of the acoustic input impedance of artificial ears		48
	A.1 Introduction	48
	A.2 Calibration of the impedance probe	49
	A.3 Artificial ear calibration	50
Annex B – Cross sectional areas of type 4.3 artificial ear		51
	B.1 Cross sections of the concha bottom	51
	B.2 Cross sectional areas of the ear canal and concha bottom.....	52
	B.3 Cross sectional areas of the pinna simulator	58
Annex C – Cross sectional areas of Type 4.4 artificial ear.....		83
	C.1 Cross sections of the concha bottom	83
	C.2 Cross sectional areas of the ear canal and concha bottom.....	83
	C.3 Cross sectional areas of the pinna simulator	87
Appendix I – Comparative acoustical input impedance measurements on the artificial ears Types 3.3 and 3.4 and on human ears.....		88
	I.1 Introduction	88
	I.2 Data overview.....	88
	I.3 Artificial ear measurements.....	89

	Page
I.4 Human ear measurements.....	90
I.5 Comparison between human and artificial ear measurements	98
Appendix II – Illustration of the mobile phone-shaped impedance probe used in Appendix I.....	106
Bibliography.....	108

Recommendation ITU-T P.57

Artificial ears

1 Scope and object

1.1 Scope

This Recommendation specifies the artificial ears for telephonometric use. Four types are recommended, covering the different transducers, types, sizes and technologies.

The methods of use of the artificial ears are outside the scope of this Recommendation; however, some general rules are provided about the application force and the positioning of transducers.

1.2 Object

Four types of artificial ears are defined:

- 1) a telephone-band type for measurements on traditional telephone sets;
- 2) a type for measuring insert earphones;
- 3) a type which faithfully reproduces the acoustic characteristics of the median human ear;
- 4) a type which faithfully reproduces the acoustic characteristics of median human ear, including an anatomically shaped ear canal.

2 References

The following ITU-T Recommendations and other references contain provisions which, through reference in this text, constitute provisions of this Recommendation. At the time of publication, the editions indicated were valid. All Recommendations and other references are subject to revision; users of this Recommendation are therefore encouraged to investigate the possibility of applying the most recent edition of the Recommendations and other references listed below. A list of the currently valid ITU-T Recommendations is regularly published. The reference to a document within this Recommendation does not give it, as a stand-alone document, the status of a Recommendation.

[ITU-T P.64] Recommendation ITU-T P.64 (2019), *Determination of sensitivity/frequency characteristics of local telephone systems.*

[ITU-T P.79] Recommendation ITU-T P.79 (2007), *Calculation of loudness ratings for telephone sets.*

[ITU-T P.380] Recommendation ITU-T P.380 (2003), *Electro-acoustic measurements on headsets.*

[IEC 60318-1] IEC 60318-1:2009, *Electroacoustics – Simulators of human head and ear – Part 1: Ear simulator for the measurement of supra-aural and circumaural earphones.*
<http://webstore.iec.ch/webstore/webstore.nsf/ArtNum_PK/43309?OpenDocument>

[IEC 60318-4] IEC 60318-4:2010, *Electroacoustics – Simulators of human head and ear – Part 4: Occluded-ear simulator for the measurement of earphones coupled to the ear by means of ear inserts.*
<http://webstore.iec.ch/webstore/webstore.nsf/ArtNum_PK/43703?OpenDocument>

[b-IEC 61260-1] IEC 61260-1:2014, *Electroacoustics – Octave-band and fractional-octave-band filters – Part 1: Specifications.*
<<https://webstore.iec.ch/publication/5063>>

3 Definitions

3.1 Terms defined elsewhere

None.

3.2 Terms defined in this Recommendation

This Recommendation defines the following terms:

3.2.1 acoustically closed earphones (nominally sealed): Earphones which are intended to prevent any acoustic coupling between the external environment and the ear canal.

3.2.2 acoustically open earphones (nominally unsealed): Earphones which intentionally provide an acoustic path between the external environment and the ear canal.

3.2.3 artificial ear: A device for the calibration of earphones incorporating an acoustic coupler and a calibration microphone for the measurement of sound pressure, and having an overall acoustic impedance similar to that of the average human ear over a given frequency band.

3.2.4 circum-aural earphones: Earphones which enclose the pinna and seat on the surrounding surface of the head. Contact to the head is normally maintained by compliant cushions. Circum-aural earphones may touch but not significantly compress the pinna (see Figure 1).

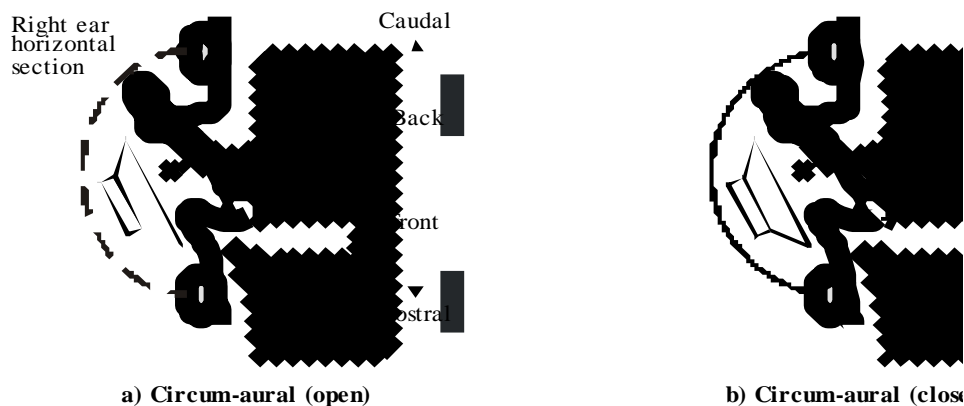

Figure 1 – Circum-aural earphones

3.2.5 ear canal entrance point (EEP): A point located at the centre of the ear canal opening.

3.2.6 ear canal extension: Cylindrical cavity extending the simulation of the ear canal provided by the occluded-ear simulator out of the concha cavity.

3.2.7 ear reference point (ERP): A virtual point for geometric reference located at the entrance to the listener's ear, traditionally used for calculating telephonometric loudness ratings.

3.2.8 ear simulator: Device for measuring the output sound pressure of an earphone under well-defined loading conditions in a specified frequency range. It consists essentially of a principal cavity, acoustic load networks and a calibrated microphone. The location of the microphone is chosen so that the sound pressure at the microphone corresponds approximately to the sound pressure existing at the human ear-drum.

3.2.9 ear-drum reference point (DRP): A point located at the end of the ear canal, corresponding to the ear-drum position.

3.2.10 insert earphones: Earphones which are intended to partially or completely enter the ear canal (see Figure 2).

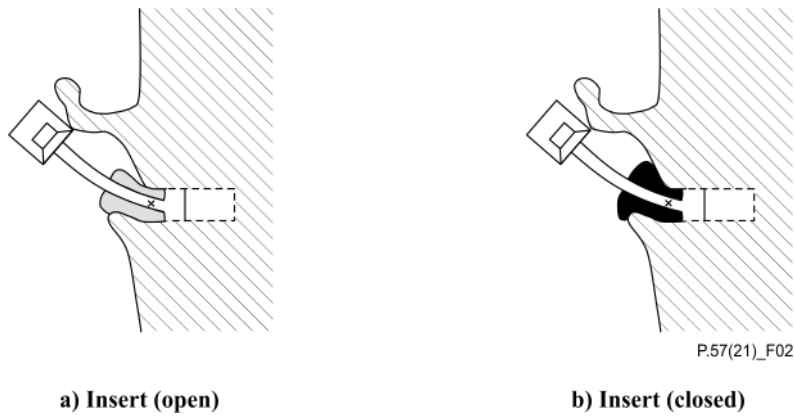

Figure 2 – Insert earphones

3.2.11 intra-concha earphones: Earphones which are intended to rest within the concha cavity of the ear. They have an external diameter (or maximum dimension) of less than 25 mm but are not made to enter the ear canal (see Figure 3).

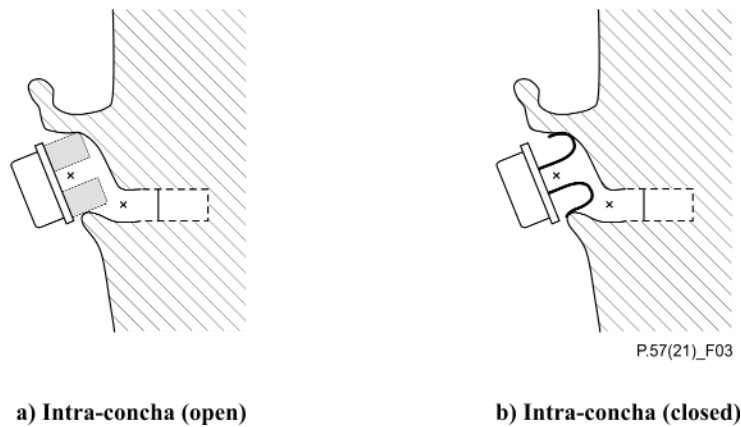

Figure 3 – Intra-concha earphones

3.2.12 occluded-ear simulator: Ear simulator which simulates the inner part of the ear canal, from the tip of an ear insert to the ear-drum.

3.2.13 pinna simulator: A device which has the approximate shape of dimensions of a median adult human pinna.

3.2.14 supra-aural earphones: Earphones which rest upon the pinna and have an external diameter (or maximum dimension) of at least 45 mm (see Figure 4).

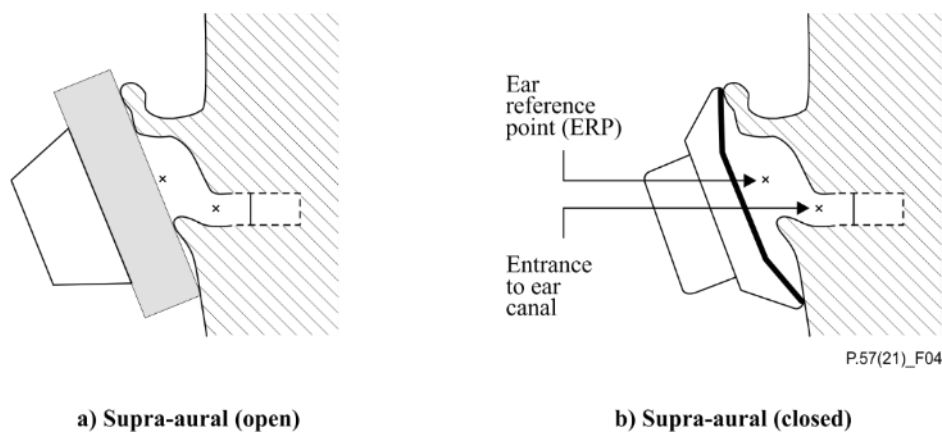

Figure 4 – Supra-aural earphones

3.2.15 supra-concha earphones: Earphones which are intended to rest upon the ridges of the concha cavity and have an external diameter (or maximum dimension) greater than 25 mm and less than 45 mm (see Figure 5).

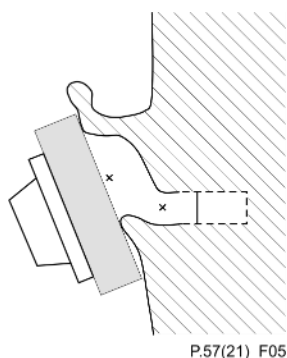

Figure 5 – Supra-concha (open) earphones

3.2.16 effective volume: equivalent volume of air of the acoustic compliance of the ear simulator formed by the cavity (terminated by the reference plane) and the microphone at a frequency of 500 Hz.

4 Abbreviations and acronyms

This Recommendation uses the following abbreviations and acronyms:

ANOVA	Analysis Of Variance
CAD	Computer Aided Design
CL	Centre of Lips
DRP	ear-Drum Reference Point
EEP	Ear canal Entrance Point
ERP	Ear Reference Point
HATS	Head And Torso Simulator
LRGP	Loudness Rating Guard-ring Position

5 Conventions

None.

6 Artificial ear types

The fundamental purpose of an artificial ear is to test a receiver under conditions that most closely approximate actual use by real persons. The recommendations that follow are based upon the manner in which the receivers are intended to be used. Modifications to an artificial ear or test procedure shall not be made. To avoid alteration of the specified concha volume and/or leak, flexible sealing material, such as putty, shall not be used.

Of the artificial ears defined below, those with a flexible pinna are intended to most closely resemble the manner in which the receivers are intended to be used.

In the narrow-band (100 Hz to 4 kHz), the type 3.3 artificial ear resembles the human ear most closely and is the preferred choice, irrespective of the device to be tested.

Use of artificial ears type 1 and 3.2 is limited to their scope of usability, described below.

Comparative acoustic impedance measurements of the artificial ear types and human ears were conducted on a large scale and are shown in Appendix I.

For super-wideband and full-band applications, the type 4.3 artificial ear resembles the human ear most closely and is the preferred choice, irrespective of the device to be tested. As an alternative, the type 4.4 artificial ear can be used for most telecommunication applications as well.

6.1 Type 1 artificial ear

The type 1 artificial ear is specified in [IEC 60318-1].

It is recommended that the type 1 artificial ear should only be used as a legacy ear simulator for measurements on large, supra-aural or supra-concha, hard-cap, conically symmetrical receivers, which naturally seal to the simulator rim, intended for narrow-band telephony applications (100 Hz to 4 kHz). The type 1 artificial ear should not be used for receivers that do not meet these specifications.

The acoustic input impedance and the frequency sensitivity response of the type 1 artificial ear are determined with reference to the ERP as specified in clause 6.4. The nominal modulus of the impedance curve and the corresponding tolerance limits are given in Table 1.

Table 1 – Acoustical impedance for type 1 artificial ear (IEC 60318)

Frequency (Hz)	Acoustical imp. (dB re 1 Pa s/m ³)	Tolerance (± dB)	Frequency (Hz)	Acoustical imp. (dB re 1 Pa s/m ³)	Tolerance (± dB)
100	145.6	1	950	134.5	1
106	145.3	1	1000	134.0	1
112	145.0	1	1060	133.4	1
118	144.6	1	1120	132.8	1
125	144.3	1	1180	132.2	1
132	144.0	1	1250	131.7	1
140	143.7	1	1320	131.1	1
150	143.4	1	1400	130.6	1
160	143.2	1	1500	130.1	1
170	143.0	1	1600	129.6	1

Table 1 – Acoustical impedance for type 1 artificial ear (IEC 60318)

Frequency (Hz)	Acoustical imp. (dB re 1 Pa s/m ³)	Tolerance (± dB)	Frequency (Hz)	Acoustical imp. (dB re 1 Pa s/m ³)	Tolerance (± dB)
180	143.0	1	1700	129.4	1
190	142.9	1	1800	129.2	1
200	142.8	1	1900	129.2	1
212	142.9	1	2000	129.3	1
224	142.9	1	2120	129.5	1
236	143.1	1	2240	129.7	1
250	143.2	1	2360	129.8	1
265	143.4	1	2500	129.8	1
280	143.5	1	2650	129.6	1
300	143.7	1	2800	129.2	1
315	143.6	1	3000	128.6	1
335	143.7	1	3150	127.9	1
355	143.6	1	3350	127.0	1
375	143.3	1	3550	125.9	1
400	143.0	1	3750	124.8	1
425	142.7	1	4000	123.2	1
450	142.2	1	4250	121.5	1
475	141.7	1	4500	119.5	1
500	141.3	1	4750	117.1	1
530	140.7	1	5000	114.2	1
560	140.1	1	5300	109.6	1
600	139.4	1	5600	104.7	1
630	138.9	1	6000	109.6	1
670	138.3	1	6300	113.6	1
710	137.6	1	6700	117.0	1
750	137.1	1	7100	119.5	1
800	136.4	1	7500	121.3	1
850	135.7	1	8000	123.2	1
900	135.1	1			

NOTE 1 – The type 1 artificial ear is not suitable for measuring low acoustic-impedance earphones.

NOTE 2 – The type 1 artificial ear is defined for simulating the acoustic load of the human ear under no leakage conditions. For receive loudness rating calculations according to [ITU-T P.79], it is recommended that measured data be corrected using the real ear loss correction L_E provided in Table 2 of [ITU-T P.79].

NOTE 3 – It is recommended to use an application force between 5 N and 10 N for placing ear-caps against type 1 artificial ears. The force applied in measurements shall always be reported.

6.2 Type 2 artificial ear

The type 2 artificial ear is specified in [IEC 60318-4].

It is recommended that the type 2 artificial ear should be used for measurements on insert earphones, both sealed and unsealed.

The sound pressure measured by the type 2 artificial ear is referred to the ear-drum reference point (DRP). The correction function given in Tables 2-a (1/3 octave band measurements) and 2-b (1/12 octave band and sine measurements) shall be used for converting data to the ear reference point (ERP) when it is required to calculate loudness ratings or check results against specifications based on measurements referring to the ERP.

NOTE – For receive loudness rating calculations according to [ITU-T P.79], the real ear loss correction L_E should be as specified in [ITU-T P.380].

Table 2-a – S_{DE} – Third octave measurements

Frequency (Hz)	S_{DE} (dB)	Frequency (Hz)	S_{DE} (dB)
100	0.0	1000	-1.7
125	0.0	1250	-2.6
160	0.0	1600	-4.2
200	0.0	2000	-6.5
250	-0.3	2500	-9.4
315	-0.2	3150	-10.3
400	-0.5	4000	-6.6
500	-0.6	5000	-3.2
630	-0.7	6300	-3.3
800	-1.1	8000	-16.0
		(10 000)	(-14.4)

S_{DE} : The transfer function DRP to ERP
 S_{DE} : $20 \log_{10} (P_E/P_D)$
 where:
 P_E : Sound pressure at the ERP
 P_D : Sound pressure at the DRP
 NOTE – The values in this table apply to 1/3 octave band measurements only.

Table 2-b – S_{DE} – Twelfth octave measurements

Frequency (Hz)	S_{DE} (dB)	Frequency (Hz)	S_{DE} (dB)	Frequency (Hz)	S_{DE} (dB)	Frequency (Hz)	S_{DE} (dB)
92	0.1	290	-0.3	917	-1.3	2901	-11.0
97	0.0	307	-0.2	972	-1.4	3073	-10.5
103	0.0	325	-0.2	1029	-1.8	3255	-10.2
109	0.0	345	-0.2	1090	-2.0	3447	-9.1
115	0.0	365	-0.4	1155	-2.3	3652	-8.0
122	0.0	387	-0.5	1223	-2.4	3868	-6.9
130	0.0	410	-0.4	1296	-2.6	4097	-5.8
137	0.0	434	-0.6	1372	-3.1	4340	-5.0

Table 2-b – S_{DE} – Twelfth octave measurements

Frequency (Hz)	S _{DE} (dB)	Frequency (Hz)	S _{DE} (dB)	Frequency (Hz)	S _{DE} (dB)	Frequency (Hz)	S _{DE} (dB)
145	0.0	460	-0.3	1454	-3.3	4597	-4.2
154	0.0	487	-0.7	1540	-3.9	4870	-3.3
163	0.0	516	-0.6	1631	-4.4	5158	-2.7
173	-0.1	546	-0.6	1728	-4.8	5464	-2.4
183	-0.1	579	-0.6	1830	-5.3	5788	-2.4
193	0.0	613	-0.6	1939	-6.0	6131	-2.5
205	0.1	649	-0.8	2053	-6.9	6494	-3.3
218	0.0	688	-0.8	2175	-7.5	6879	-4.5
230	-0.1	729	-1.0	2304	-8.1	7286	-5.9
244	-0.2	772	-1.1	2441	-9.1	7718	-9.0
259	-0.3	818	-1.1	2585	-9.5	8175	-14.2
274	-0.3	866	-1.2	2738	-10.4	8659	-20.7

NOTE – The frequencies listed are the 1/12 octave centre frequencies specified in [IEC 61260-1]. The values apply to 1/12 octave band measurements as well as sine-based measurements. S_{DE} may be determined for immediate frequencies by interpolation on a (log f) versus (lin dB) basis.

6.3 Type 3 artificial ear

The type 3 artificial ear consists of the IEC 60318-4 occluded-ear simulator, to which is added an ear canal extension terminated with a pinna simulation device. Three pinna simulators are recommended, providing the suitable coupling arrangements for measuring different transducer types. The type 3 artificial ear configurations are classified as follows:

- Type 3.1 Concha bottom simulator.
- Type 3.2 Simplified pinna simulator.
- Type 3.3 Pinna simulator (anatomically shaped).
- Type 3.4 Pinna simulator (simplified).

NOTE – Acoustically, open earphones equipped with soft cushions should be positioned against the type 3 artificial ear with the same force as applied in normal use. The force applied in measurements shall always be reported.

6.3.1 Type 3.1 – Concha bottom simulator

The concha bottom simulation is realized in the type 3.1 artificial ear by a flat plate termination of the 10.0 mm ear canal extension.

It is recommended that the type 3.1 artificial ear should be used for measurements on intra-concha earphones, designed for sitting on the bottom of the concha cavity.

The sound pressure measured by the type 3.1 artificial ear is referred to the ear-drum reference point (DRP). The correction function given in Tables 2-a (1/3 octave band measurements) and 2-b (1/12 octave band and sine measurements) shall be used for converting data to the ear reference point (ERP) when it is required to calculate loudness ratings or check results against specifications based on measurements referred to the ERP.

NOTE – For receive loudness rating calculations according to [ITU-T P.79], the real ear loss correction L_E should be set to zero.

6.3.2 Type 3.2 – Simplified pinna simulator

The pinna simulation is realized in the type 3.2 artificial ear by a cavity terminating the 10.0 mm ear canal extension. A well-defined leak from the cavity to the exterior simulates the average human ear loss for telephone handsets which are held either firmly (low leak version) or loosely (high leak version) against the human ear. The construction of the leak may differ depending on the specific application of the type 3.2 artificial ear (see Figure 6 and Tables 3-a and 3-b).

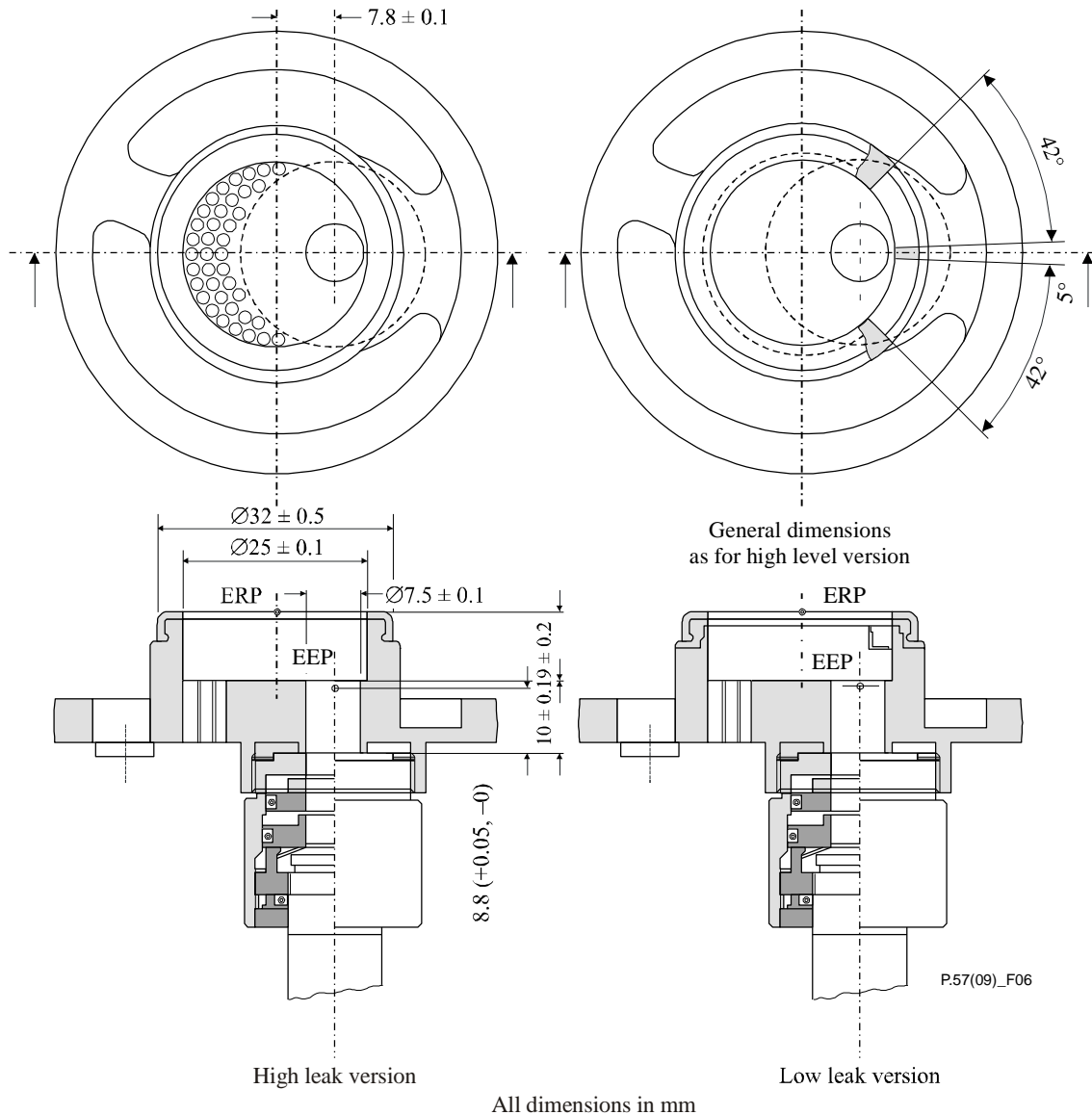

Figure 6 – Example of high leak and low leak simplified pinna simulators for use in an LRGP test head

Table 3-a – Leakage simulation, realized using a slit (type 3.2 artificial ear)

Leakage grade	Use	Slit depth (mm)	Slit height (mm)	Opening angle (degrees)
Low	LRGP/HATS	2.8 ± 0.2	0.26 ± 0.01	84 ± 1
High	HATS	1.9 ± 0.2	0.50 + 0.01 – 0.03	240 ± 1

**Table 3-b – Leakage simulation, realized using cylindrical holes
(type 3.2 artificial ear)**

Leakage grade	Use	Number of holes	Diameter (mm)	Depth (mm)
High	LRGP	33	1.7	8.5 ± 0.2
		6	1.8	8.5 ± 0.2

It is recommended that the type 3.2 artificial ear with a high- or low-grade leak should be used for measurements on supra-aural or supra-concha, hard-cap receivers, which naturally seal to the simulator rim, intended for both narrow-band and wideband telephony applications (100 Hz to 8 kHz). It is also recommended for measurements on low acoustic impedance receivers.

The acoustic input impedance and the frequency sensitivity response of the type 3.2 artificial ear are determined with reference to the ERP as specified in clause 6.4. The nominal modulus of the impedance curve and the corresponding tolerance limits are given in Tables 4-a, 4-b and 4-c.

NOTE 1 – The leakage grade ("high" or "low") adopted in measurements shall be reported. The low-grade leak intends to simulate real ear loss for a receiver pressed firmly to the ear, while the high-grade leak intends to simulate real ear loss for a loosely coupled receiver.

NOTE 2 – The type 3.2 artificial ear emulates the human ear canal, with the microphone diaphragm at the eardrum position. Hence, in addition to the particular microphone characteristics, the frequency sensitivity response of the artificial ear includes an individual ERP to DRP transfer function. It is essential, therefore, that measurement values are corrected for the frequency sensitivity response calibration data (open ear condition) provided with the particular artificial ear used.

NOTE 3 – For receive loudness rating calculations according to [ITU-T P.79], the real ear loss correction L_E should be set to zero.

NOTE 4 – The ERP to DRP transfer function depends significantly on the acoustic loading of the ear. For diagnostic purposes (e.g., to interpret differences to measurements made using the type 1 artificial ear), the type 3.2 artificial ear may be supplied with calibration data recorded under closed-ear conditions or other well-defined acoustical terminations.

NOTE 5 – The flat plate termination of the ear canal extension provided by the type 3.2 artificial ear is a possible implementation of the type 3.1 artificial ear.

NOTE 6 – The type 3.2 artificial ear is only intended for use with earphones designed to operate in close contact with the real pinna.

NOTE 7 – All dimensions determining the acoustic leak are for guidance only. They may be modified slightly for different commercial designs in order to obtain the nominal acoustic input impedance.

NOTE 8 – It is recommended to use an application force between 5 N and 10 N for placing hard ear-caps against the type 3.2 artificial ear. The force applied in the measurements shall always be reported.

NOTE 9 – For receivers that do not naturally seal to the simulator rim, an adaptor may be created for the specific geometry of the receiver. This adaptor may be machined or injection moulded and shall not alter the specified concha volume or leak. The adaptor shall be made from a material which cannot be altered, shaped or modified by the person performing the testing.

All leakage-related dimensions are for guidance only – see also Figure 6. Practical implementation must always be optimized with respect to the acoustical specifications.

**Table 4-a – Acoustical impedance, resonance, and Q-factors
(type 3.2 – low and high leak)**

	Q-factor	Resonance (Hz)	Magnitude (dB)
Low leak	1.81	713.8	140.4
Tolerance (±)	0.18	25.0	1.0
High leak	3.5	1570.0	138.8
Tolerance (±)	0.35	50.0	1.5

Table 4-b – Acoustical impedance (type 3.2 – low leak)

Frequency (Hz)	Acoustical imp. (dB re 1 Pa s/m³)	Tolerance (± dB)	Frequency (Hz)	Acoustical imp. (dB re 1 Pa s/m³)	Tolerance (± dB)
100	125.77	4.00	950	137.18	1.00
106	126.07	4.00	1000	136.33	1.00
112	126.18	4.00	1060	135.34	1.00
118	126.28	4.00	1120	134.40	1.00
125	126.44	4.00	1180	133.48	1.00
132	126.60	4.00	1250	132.46	1.00
140	126.74	4.00	1320	131.48	1.00
150	127.26	4.00	1400	130.40	1.00
160	127.27	4.00	1500	129.10	1.00
170	127.42	3.73	1600	127.85	1.00
180	127.79	3.47	1700	126.69	1.00
190	127.89	3.23	1800	125.58	1.00
200	128.10	3.00	1900	124.46	1.00
212	128.44	3.00	2000	123.45	1.00
224	128.71	3.00	2120	122.38	1.26
236	129.01	3.00	2240	121.22	1.51
250	129.31	3.00	2360	119.99	1.74
265	129.66	2.75	2500	118.69	2.00
280	130.08	2.51	2650	117.60	2.00
300	130.46	2.21	2800	116.99	2.00
315	130.92	2.00	3000	117.47	2.00
335	131.50	2.00	3150	117.91	2.00
355	132.02	2.00	3350	118.74	2.00
375	132.52	2.00	3550	119.23	2.00
400	133.23	2.00	3750	118.77	2.00
425	133.95	1.73	4000	116.22	2.00
450	134.72	1.47	4250	111.62	2.27
475	135.32	1.23	4500	108.19	2.53

Table 4-b – Acoustical impedance (type 3.2 – low leak)

Frequency (Hz)	Acoustical imp. (dB re 1 Pa s/m ³)	Tolerance (± dB)	Frequency (Hz)	Acoustical imp. (dB re 1 Pa s/m ³)	Tolerance (± dB)
500	136.08	1.00	4750	111.36	2.77
530	136.97	1.00	5000	114.89	3.00
560	137.78	1.00	5300	117.80	3.00
600	138.75	1.00	5600	119.87	3.00
630	139.45	1.00	6000	121.93	3.00
670	140.13	1.00	6300	123.19	3.00
710	140.32	1.00	6700	124.61	3.00
750	140.30	1.00	7100	125.81	3.00
800	139.76	1.00	7500	126.90	3.00
850	138.99	1.00	8000	128.12	3.00
900	138.09	1.00			

Table 4-c – Acoustical impedance (type 3.2 – high leak)

Frequency (Hz)	Acoustical imp. (dB re 1 Pa s/m ³)	Tolerance (± dB)	Frequency (Hz)	Acoustical imp. (dB re 1 Pa s/m ³)	Tolerance (± dB)
100	105.4	4.0	950	127.7	1.5
106	105.9	4.0	1000	128.4	1.5
112	106.2	4.0	1060	129.4	1.5
118	106.7	4.0	1120	130.5	1.5
125	107.3	4.0	1180	131.7	1.5
132	107.7	4.0	1250	133.3	1.5
140	108.3	4.0	1320	134.9	1.5
150	108.9	4.0	1400	137.2	1.5
160	109.6	4.0	1500	138.1	1.5
170	110.1	3.7	1600	138.1	1.5
180	110.6	3.5	1700	137.1	1.5
190	111.1	3.2	1800	135.8	1.5
200	111.5	3.0	1900	134.0	1.5
212	112.1	3.0	2000	133.0	1.5
224	112.4	3.0	2120	130.7	2.0
236	113.0	3.0	2240	128.3	2.0
250	113.4	3.0	2360	126.3	2.0
265	114.0	2.8	2500	124.2	2.0
280	114.5	2.5	2650	122.6	2.0
300	115.0	2.2	2800	121.5	2.0
315	115.5	2.0	3000	121.7	2.0

Table 4-c – Acoustical impedance (type 3.2 – high leak)

Frequency (Hz)	Acoustical imp. (dB re 1 Pa s/m ³)	Tolerance (± dB)	Frequency (Hz)	Acoustical imp. (dB re 1 Pa s/m ³)	Tolerance (± dB)
335	116.1	2.0	3150	121.9	2.0
355	116.6	2.0	3350	122.6	2.0
375	117.1	2.0	3550	123.3	2.0
400	117.7	2.0	3750	123.4	2.0
425	118.4	1.5	4000	121.7	2.0
450	118.8	1.5	4250	118.2	2.3
475	119.3	1.5	4500	113.8	2.5
500	120.0	1.5	4750	110.9	2.8
530	120.6	1.5	5000	113.6	3.0
560	121.1	1.5	5300	116.6	3.0
600	121.9	1.5	5600	118.9	3.0
630	122.3	1.5	6000	121.3	3.0
670	123.0	1.5	6300	122.7	3.0
710	123.6	1.5	6700	124.3	3.0
750	124.4	1.5	7100	125.7	3.0
800	125.2	1.5	7500	126.9	3.0
850	126.1	1.5	8000	128.3	3.0
900	126.9	1.5			

6.3.3 Type 3.3 – Pinna simulator

The type 3.3 artificial ear is realized by terminating the real ear canal extension with the pinna simulator defined in this Recommendation (see Figures 7-a, 7-b, 7-c and 7-d). The dots in Figure 7-b are located on a vertical axis through the ear canal entrance point. The pinna simulator shall be made from a high-quality elastomer, the hardness of which – measured at the surface 15 mm forward to the ear canal opening – should be $35 \pm 6^\circ$ Shore-OO. Measurement techniques are described in [b-ISO 48-4] and [b-ASTM D2240-15].

It is recommended that the type 3.3 artificial ear be used for measurements on all types of devices.

The sound pressure measured by the type 3.3 artificial ear is referring to the ear-drum reference point (DRP). The correction function given in Tables 2-a (1/3 octave band measurements) and 2-b (1/12 octave band and sine measurements) shall be used for converting data to the ear reference point (ERP) when it is required to calculate loudness ratings or check results against specifications based on measurements referring to the ERP.

NOTE 1 – For receive loudness rating calculations according to [ITU-T P.79], the real ear loss correction L_E should be set to zero.

NOTE 2 – The application force of hard ear-caps against the type 3.3 pinna simulator should preferably be about 10 N. The force applied in the measurements shall always be reported.

NOTE 3 – HATS with flexible pinna simulators are the only artificial ears recommended for headset measurements as described in [ITU-T P.380]. However, in case other types of artificial ears are used and draw different measurement results against type 3.3 artificial ears, the results from type 3.3 artificial ears shall take precedence.

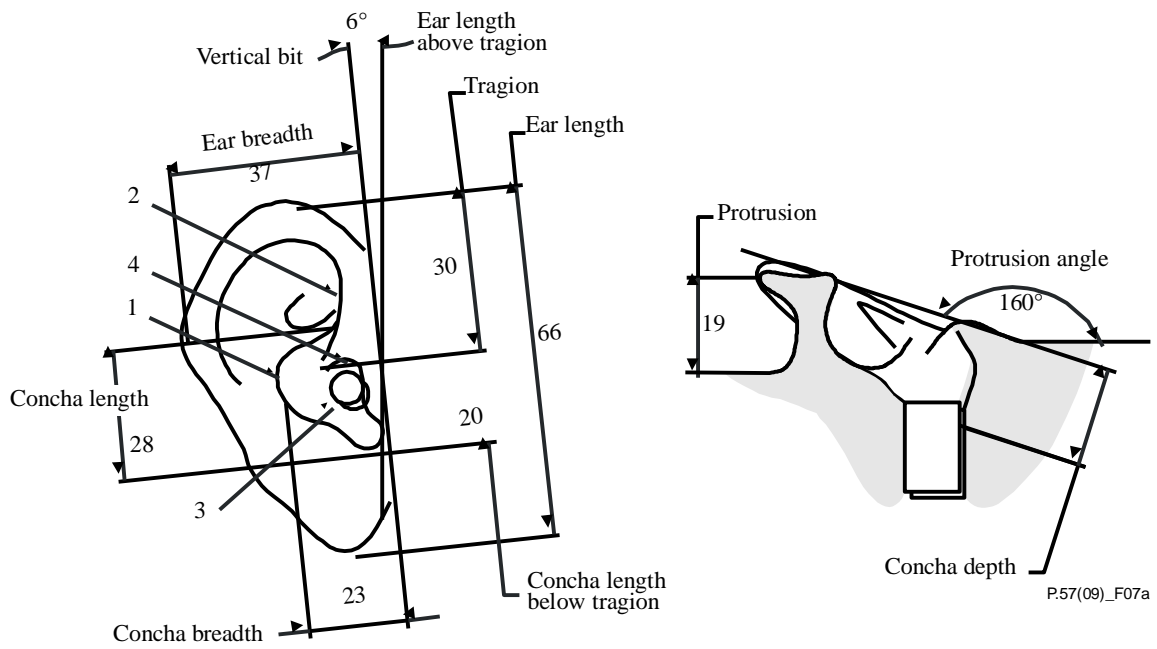

a) Cross-view

b) Cross section

- 1 Anti-helix
- 2 Crus of helix
- 3 Concha
- 4 Tragion

NOTE – Not to scale; units in mm.

Figure 7-a – Anatomically shaped pinna simulator

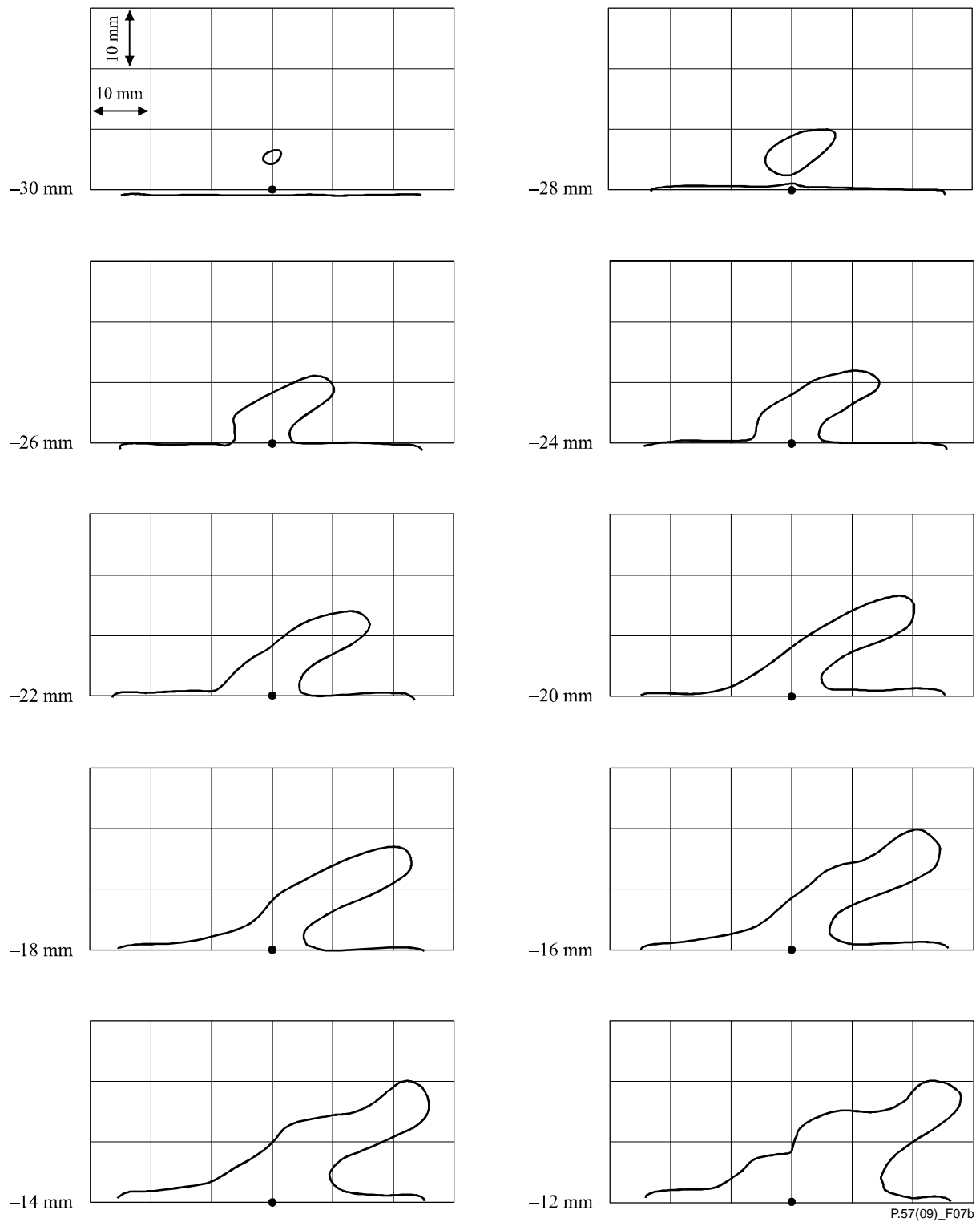

Figure 7-b – Pinna simulator cross-sections

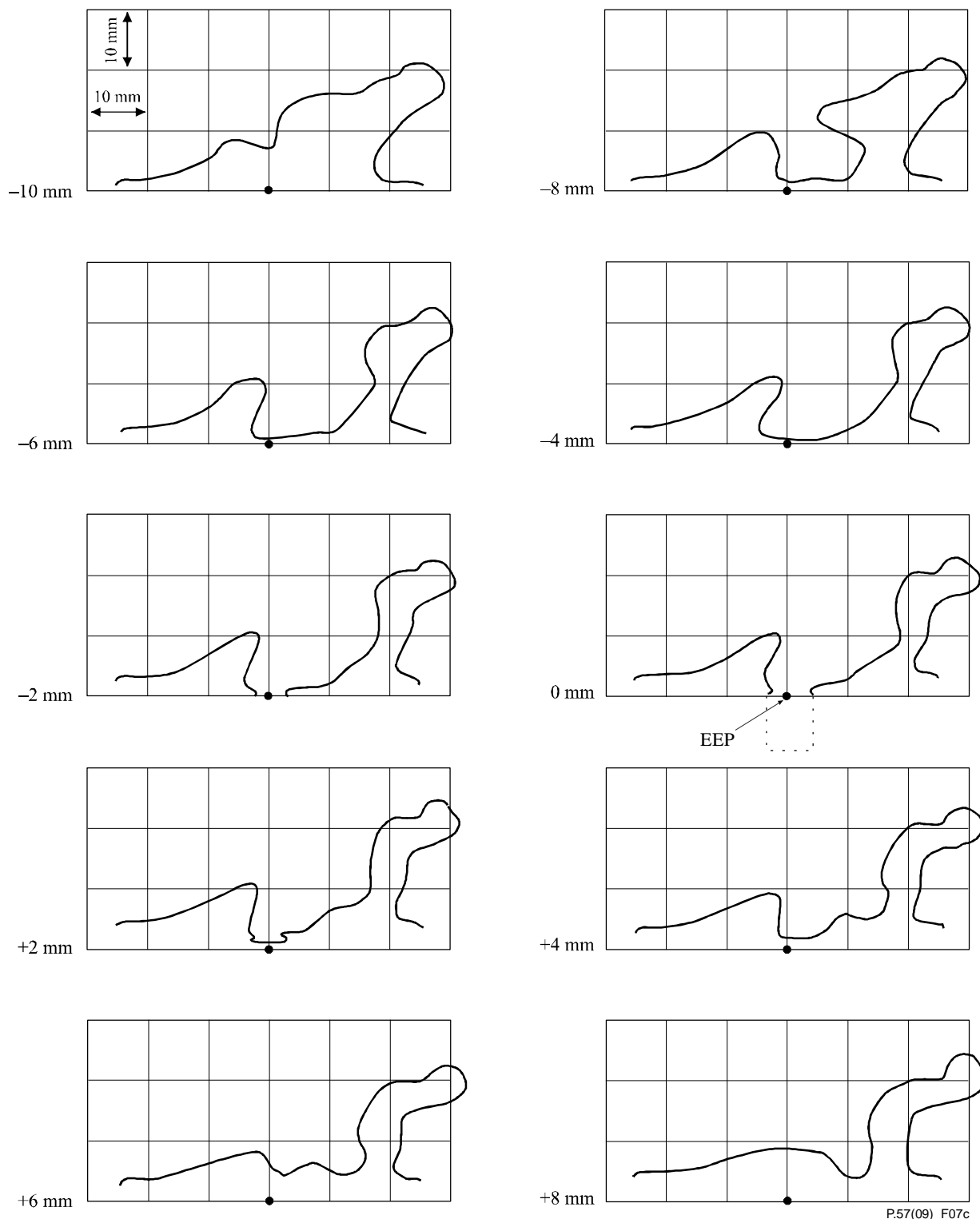

Figure 7-c – Pinna simulator cross-sections

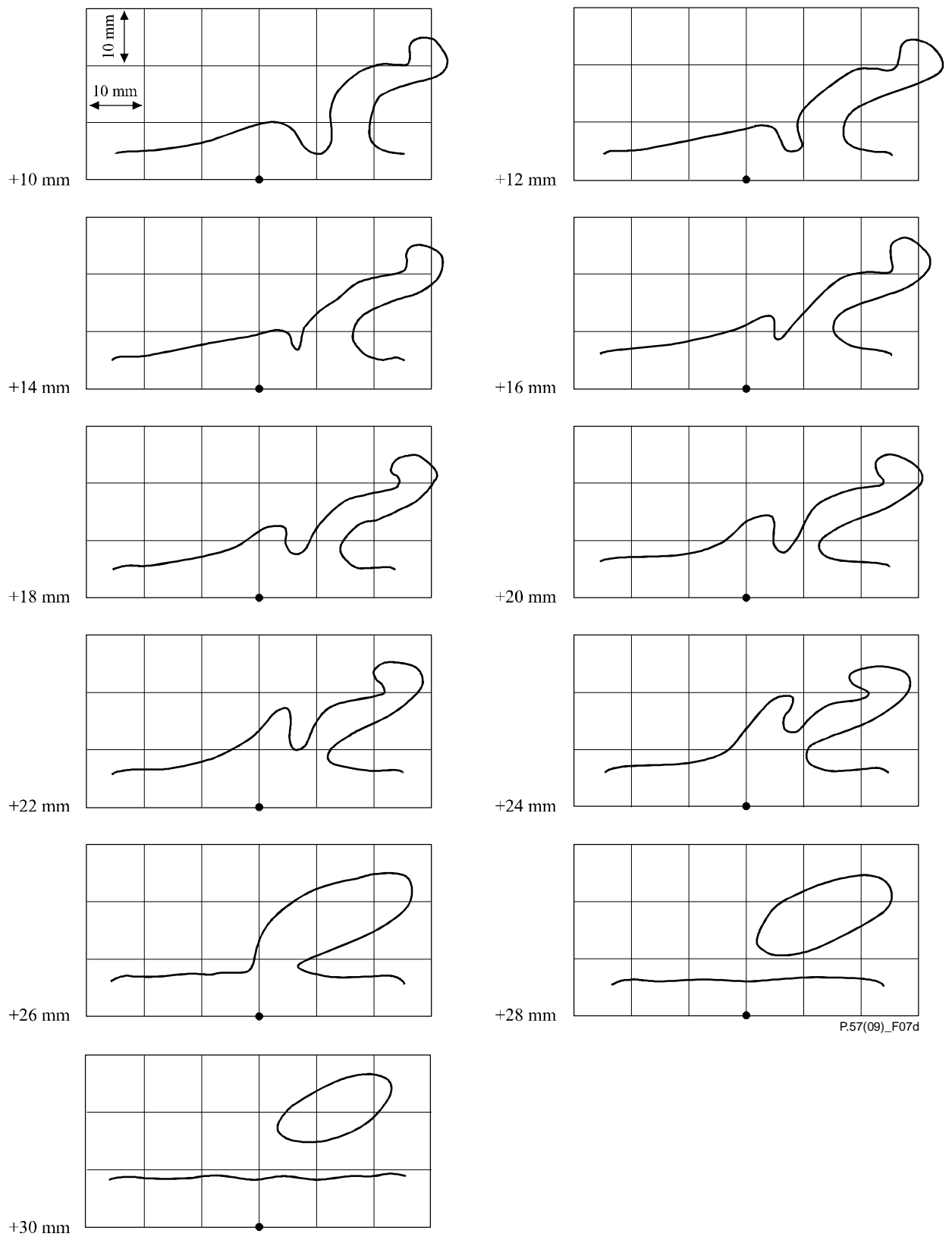

Figure 7-d – Pinna simulator cross-sections

6.3.4 Type 3.4 – Pinna simulator (simplified)

The pinna simulation is realized in the type 3.4 artificial ear by terminating the drum reference plane of the type 2 artificial ear with an ear canal extension and a simplified pinna (see Figure 8). The pinna shall be made from an elastomer with a Shore-A hardness of 25 ± 2 at $20^\circ \text{C} \pm 2^\circ \text{C}$.

It is recommended that the type 3.4 artificial ear be used as an alternative to the type 3.3 for measurements on all types of devices except supra-concha headsets, supra-aural headsets and forward facing intra-concha headsets (acoustic outlets that do not face the ear canal). The type 3.4 artificial ear is intended to reproduce the typical handset leakage occurring in real use for pressure forces in the range of 1 N and 13 N.

The sound pressure measured by the type 3.4 artificial ear is referred to the ear-drum reference point (DRP). The correction function given in Tables 2-a (1/3 octave band measurements) and 2-b (1/12 octave bands and sine measurements) shall be used for converting data to the ear reference point (ERP) when it is required to calculate loudness ratings or check results against specifications based on measurements referred to the ERP.

NOTE – For receive loudness rating calculations according to [ITU-T P.79], the real ear loss correction L_E should be set to zero.

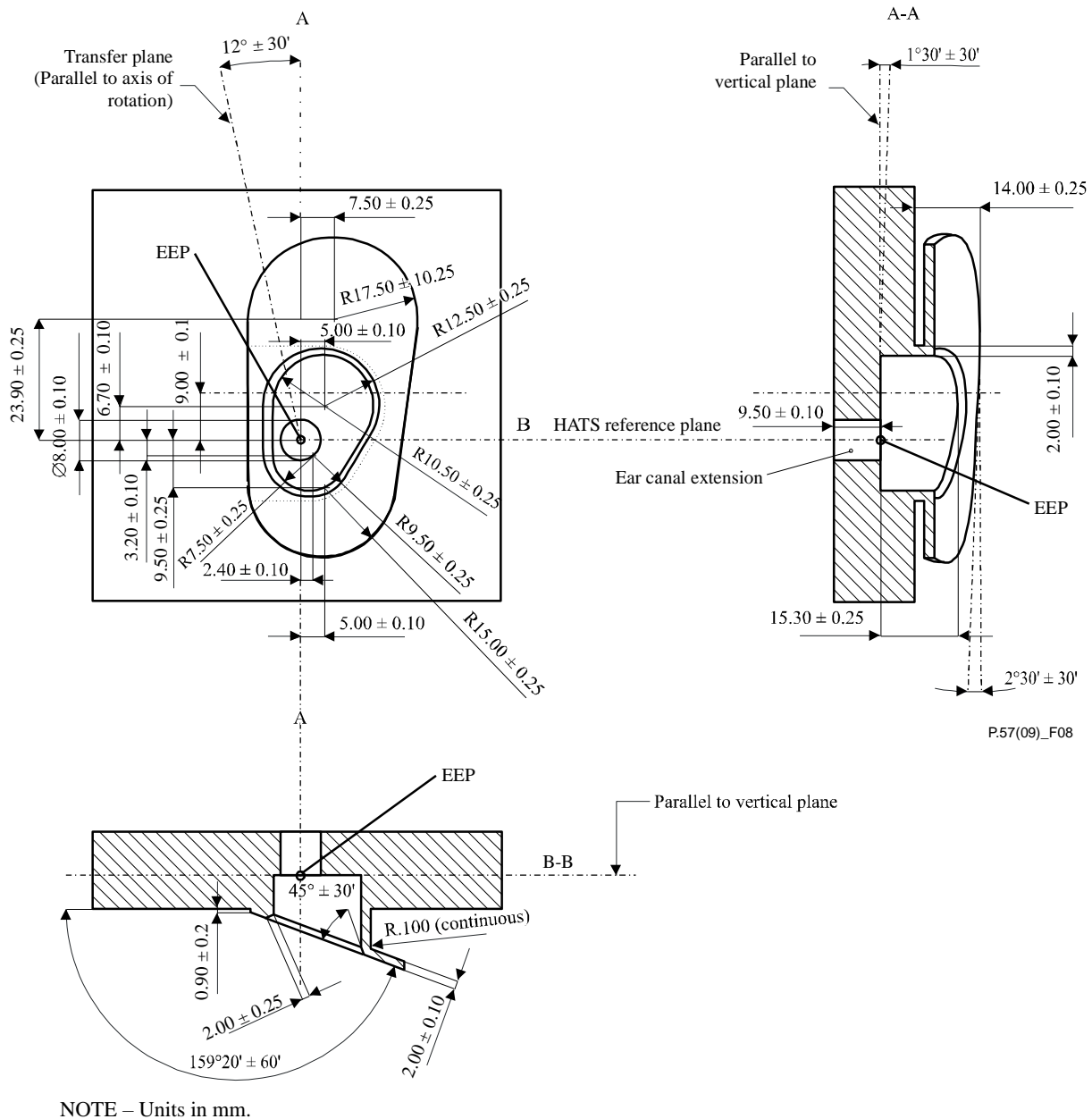

Figure 8 – Type 3.4 artificial ear

6.4 Type 4 artificial ear

The type 4 artificial ear consists of the anatomically shaped ear canal and concha bottom ear simulator which can be used as a stand-alone device for measurements on insert earphones, both sealed and unsealed – or to which is added a pinna simulation device for measuring different transducer types. The type 4 artificial ear configurations are classified as follows:

Type 4.1 – For further study.

Type 4.2 – For further study.

Type 4.3 – Anatomically shaped Type 3.3 based pinna simulator with fully human shaped ear canal.

Type 4.4 – Anatomically shaped Type 3.3 based pinna simulator with partly human shaped ear canal.

6.4.1 Type 4.1 ear simulator

For further study.

6.4.2 Type 4.2 ear simulator

For further study.

6.4.3 Type 4.3 ear simulator

6.4.3.1 Overview

The type 4.3 artificial ear is realized by terminating the anatomical ear canal simulator with the pinna simulator defined in this Recommendation (see Figure 9). The pinna simulator shall be made from a high-quality elastomer, the hardness of which – measured at the surface 15 mm forward to the ear canal opening – should be $35 \pm 6^\circ$ Shore-OO. Measurement techniques are described in [b-ISO 48-4] and [b-ASTM D2240-15].

NOTE 1 – The application force of hard ear-caps against the type 4.3 pinna simulator should preferably be about 10 N. The force applied in the measurements shall always be reported.

NOTE 2 – HATS with flexible pinna simulators are the only artificial ears recommended for headset measurements as described in [ITU-T P.380]. However, in case artificial ears of type 1, 2 or 3 are used, and if different measurement results are obtained compared to the type 4.3 artificial ears, the results from type 4.3 artificial ears shall take precedence.

NOTE 3 – A comparison between the type 4.3 pinna simulator and the type 3.3 pinna simulator will reveal a difference between the two at the region where the transition from concha bottom to the ear canal takes place. In the type 3.3 the concha bottom constitutes an almost plane surface which connects to the cylindrical shaped ear canal in an approximately 90-degree angle. In the type 4.3 the concha bottom has been modified in order to obtain smooth and continuous transition to the anatomically shaped ear canal.

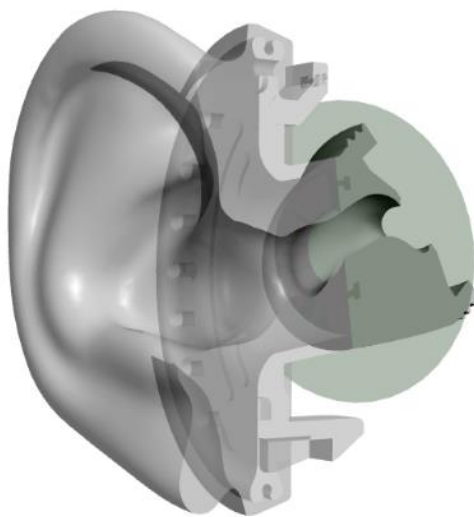

Figure 9 – The type 4.3 ear simulator, showing an average human ear canal with the type 3.3 based pinna simulator attached

6.4.3.2 Ear-drum reference point to ear reference point correction

The sound pressure measured by the type 4.3 artificial ear refers to the ear-drum reference point (DRP). The correction function given in Tables 5-a (1/3 octave band measurements) and 5-b (1/12 octave band and sine measurements) shall be used for converting data to the ear reference point (ERP) when it is required to calculate loudness ratings or check results against specifications based on measurements referring to the ERP.

NOTE 1 – For receive loudness rating calculations according to [ITU-T P.79], the real ear loss correction L_E should be set to zero.

Table 5-a – S_{DE} – Third octave measurements

Frequency (Hz)	S _{DE} (dB)	Frequency (Hz)	S _{DE} (dB)
20	0.00	630	-1.26
25	0.00	800	-1.67
31.5	0.00	1000	-1.93
40	0.00	1250	-2.30
50	-0.01	1600	-3.80
63	-0.01	2000	-6.12
80	-0.02	2500	-8.93
100	-0.03	3150	-11.34
125	-0.05	4000	-8.65
160	-0.09	5000	-5.69
200	-0.15	6300	-8.73
250	-0.24	8000	-7.22
315	-0.40	10000	-15.35
400	-0.61	12500	-13.16
500	-0.89	16000	-4.27
		20000	+4.63

S_{DE} is the transfer function DRP to ERP
 $S_{DE} = 20 \log_{10} (P_E/P_D)$
 where:
 P_E Sound pressure at the ERP
 P_D Sound pressure at the DRP
 NOTE – The values in this table apply to 1/3 octave band measurements only.

Table 5-b – S_{DE} – Twelfth octave measurements

Frequency (Hz)	S _{DE} (dB)	Frequency (Hz)	S _{DE} (dB)	Frequency (Hz)	S _{DE} (dB)
20	0.00	200	-0.15	2000	-6.00
21	0.00	212	-0.17	2120	-6.73
22	0.00	224	-0.19	2240	-7.42
24	0.00	236	-0.21	2360	-8.00
25	0.00	250	-0.24	2500	-8.82
27	0.00	265	-0.27	2650	-9.71
28	0.00	280	-0.31	2800	-10.49
30	0.00	300	-0.35	3000	-11.34
32	0.00	315	-0.39	3150	-11.71
34	0.00	335	-0.44	3350	-11.61
36	0.00	355	-0.49	3550	-10.85
38	0.00	375	-0.54	3750	-9.81

Table 5-b – S_{DE} – Twelfth octave measurements

Frequency (Hz)	S _{DE} (dB)	Frequency (Hz)	S _{DE} (dB)	Frequency (Hz)	S _{DE} (dB)
40	0.00	400	-0.61	4000	-8.41
43	-0.01	425	-0.67	4250	-7.29
45	-0.01	450	-0.74	4500	-6.41
48	-0.01	475	-0.81	4750	-5.83
50	-0.01	500	-0.88	5000	-5.42
53	-0.01	530	-0.96	5300	-5.39
56	-0.01	560	-1.05	5600	-5.75
60	-0.01	600	-1.16	6000	-6.89
63	-0.01	630	-1.25	6300	-8.16
67	-0.01	670	-1.36	6700	-10.34
71	-0.02	710	-1.47	7100	-11.62
75	-0.02	750	-1.57	7500	-9.18
80	-0.02	800	-1.68	8000	-5.77
85	-0.02	850	-1.76	8500	-3.77
90	-0.03	900	-1.83	9000	-5.26
95	-0.03	950	-1.88	9500	-10.76
100	-0.03	1000	-1.92	10000	-16.52
106	-0.04	1060	-1.97	10600	-18.86
112	-0.04	1120	-2.04	11200	-17.09
118	-0.05	1180	-2.13	11800	-13.62
125	-0.05	1250	-2.26	12500	-11.63
132	-0.06	1320	-2.44	13200	-11.86
140	-0.07	1400	-2.71	14000	-12.42
150	-0.08	1500	-3.10	15000	-5.96
160	-0.09	1600	-3.73	16000	-2.05
170	-0.10	1700	-4.43	17000	1.06
180	-0.11	1800	-4.96	18000	-4.01
190	-0.13	1900	-5.43	19000	-3.29
				20000	-6.61

NOTE – The frequencies listed are the 1/12 octave centre frequencies specified in [IEC 61260-1]. The values apply to 1/12 octave band measurements as well as sine-based measurements. S_{DE} may be determined for immediate frequencies by interpolation on a (log f) versus (lin dB) basis.

6.4.3.3 Transfer impedance

For calibration of the ear simulator a reference volume shall be used. The effective acoustical volume of the reference volume should be reported. Table 5-c provides data where the transfer impedance has been measured using a reference volume of 1.63 cm³ (+/- 0,10 cm³). The transfer impedance of the ear canal simulator is measured between the reference plane as shown in Figure 10 (see also clause 6.4.3.4) and the DRP. The magnitude for transfer impedance and tolerances versus frequency are provided in Table 5-c.

NOTE 1 – It should be noted that alternative methods for calibration of the ear simulator can be used. In such situations the method should be stated.

NOTE 2 – At 500 Hz, the magnitude of the acoustic transfer impedance 27.7 MPa·s/m³ corresponds to the magnitude of the effective volume of the ear simulator 1.63 ± 0,10 cm³.

Table 5-c – Transfer impedance (times f) for type 4.3 ear simulator relative to the reference frequency 500 Hz for a nominal effective volume of 1.63 cm³ (±0.10 cm³)

Frequency (Hz)	Transfer imp. x f Rel. 500 Hz	Tol. upper (dB)	Tol. lower (dB)	Frequency (Hz)	Transfer imp. x f Rel. 500 Hz	Tol. upper (dB)	Tol. lower (dB)
20	-4.56	+2.4	-1.1	670	0.42	+0.9	-1.1
21	-4.50	+2.4	-1.1	710	0.59	+0.9	-1.1
22	-4.32	+2.2	-1.3	750	0.78	+0.8	-1.2
24	-4.15	+2.2	-1.3	800	1.04	+0.8	-1.2
25	-4.14	+2.4	-1.1	850	1.38	+0.7	-1.3
27	-3.97	+2.2	-1.3	900	1.74	+0.7	-1.3
28	-3.87	+2.2	-1.3	950	2.14	+0.7	-1.3
30	-3.71	+2.2	-1.3	1000	2.56	+0.7	-1.3
32	-3.61	+2.2	-1.3	1060	3.07	+0.7	-1.3
34	-3.46	+2.1	-1.4	1120	3.58	+0.8	-1.2
36	-3.34	+2.1	-1.4	1180	4.06	+0.8	-1.2
38	-3.20	+2.1	-1.4	1250	4.57	+0.9	-1.1
40	-3.06	+2.0	-1.5	1320	5.02	+0.9	-1.1
43	-2.93	+1.5	-1.5	1400	5.45	+1.0	-1.0
45	-2.80	+1.5	-1.5	1500	5.88	+1.0	-1.0
48	-2.65	+1.5	-1.5	1600	6.22	+1.1	-0.9
50	-2.56	+1.5	-1.5	1700	6.51	+1.1	-0.9
53	-2.42	+1.5	-1.5	1800	6.75	+1.1	-0.9
56	-2.30	+1.4	-1.6	1900	6.98	+1.1	-0.9
60	-2.15	+1.4	-1.6	2000	7.19	+1.1	-0.9
63	-2.05	+1.4	-1.6	2120	7.45	+1.1	-0.9
67	-1.93	+1.4	-1.6	2240	7.71	+1.1	-0.9
71	-1.83	+1.4	-1.6	2360	7.96	+1.1	-0.9
75	-1.69	+1.4	-1.1	2500	8.27	+1.1	-0.9
80	-1.58	+0.9	-1.1	2650	8.59	+1.1	-0.9
85	-1.48	+0.9	-1.1	2800	8.91	+1.2	-0.8
90	-1.38	+0.9	-1.1	3000	9.31	+1.2	-0.8
95	-1.30	+0.9	-1.1	3150	9.58	+1.2	-0.8
100	-1.22	+0.9	-1.1	3350	9.91	+1.2	-0.8
106	-1.11	+0.9	-1.1	3550	10.21	+1.2	-0.8
112	-1.03	+0.9	-1.1	3750	10.47	+1.2	-0.8
118	-0.98	+0.9	-1.1	4000	10.77	+1.2	-0.8
125	-0.89	+0.9	-1.1	4250	11.05	+1.2	-0.8

Table 5-c – Transfer impedance (times f) for type 4.3 ear simulator relative to the reference frequency 500 Hz for a nominal effective volume of 1.63 cm³ (± 0.10 cm³)

Frequency (Hz)	Transfer imp. x f Rel. 500 Hz	Tol. upper (dB)	Tol. lower (dB)	Frequency (Hz)	Transfer imp. x f Rel. 500 Hz	Tol. upper (dB)	Tol. lower (dB)
132	-0.83	+0.9	-1.1	4500	11.33	+1.2	-0.8
140	-0.77	+0.9	-1.1	4750	11.61	+1.1	-0.9
150	-0.70	+0.9	-1.1	5000	11.90	+1.1	-1.4
160	-0.64	+0.9	-1.1	5300	12.29	+1.1	-1.4
170	-0.58	+0.9	-1.1	5600	12.71	+1.5	-1.5
180	-0.55	+0.9	-1.1	6000	13.34	+1.7	-1.6
190	-0.51	+1.0	-1.0	6300	13.88	+1.6	-1.6
200	-0.47	+1.0	-1.0	6700	14.68	+1.8	-1.7
212	-0.43	+1.0	-1.0	7100	15.58	+1.7	-2.8
224	-0.40	+1.0	-1.0	7500	16.61	+2.1	-2.9
236	-0.37	+1.0	-1.0	8000	18.10	+1.9	-3.1
250	-0.34	+1.0	-1.0	8500	19.87	+2.7	-3.3
265	-0.31	+1.0	-1.0	9000	21.96	+2.9	-4.1
280	-0.28	+1.0	-1.0	9500	24.40	+2.6	-4.4
300	-0.26	+1.0	-1.0	10000	26.96	+2.4	-4.6
315	-0.23	+1.0	-1.0	10600	28.39	+3.7	-2.8
335	-0.22	+1.0	-1.0	11200	27.18	+4.5	-3.7
355	-0.18	+1.0	-1.0	11800	24.82	+5.2	-4.1
375	-0.17	+1.0	-1.0	12500	22.56	+4.2	-3.8
400	-0.13	+1.0	-1.0	13200	20.98	+3.4	-4.6
425	-0.10	+1.0	-1.0	14000	19.91	+3.1	-4.9
450	-0.07	+1.0	-1.0	15000	19.34	+2.8	-7.2
475	-0.04	+1.0	-1.0	16000	19.50	+2.6	-7.4
500	0.00	+1.0	-1.0	17000	20.76	+3.0	-8.0
530	0.05	+1.0	-1.0	18000	23.28	+5.1	-7.9
560	0.11	+1.0	-1.0	19000	28.36	+6.8	-9.2
600	0.21	+0.9	-1.1	20000	32.11	+4.6	-11.4
630	0.29	+0.9	-1.1				

6.4.3.4 Geometry of the ear simulator

6.4.3.4.1 Overview

The geometry of the ear canal is specified by extracting cross sectional areas of the canal normal to a curved axis following the centre of the ear canal as illustrated in the green planes of Figure 10. The centre line is calculated from a surface model of the average human ear canal geometry. In brief, it is determined as the weighted shortest paths to a maximal sphere inscribed in the object, the surface model of the ear canal.

Table 6 – The x_m, y_m, z_m coordinates of the ear canal centre line and EEP projections of the concha bottom

Centre line [mm]	x_m	y_m	z_m	Cross section
0	103.67	39.29	50.71	
0.5	103.81	39.76	50.69	0.5 mm
DRP	105.5	42.02	53.76	
1	103.98	40.23	50.76	
1.5	104.13	40.68	50.91	
2	104.27	41.11	51.12	2 mm
2.5	104.43	41.53	51.34	
3	104.58	41.93	51.59	
3.5	104.73	42.34	51.84	
4	104.87	42.77	52.04	4 mm
4.5	104.97	43.23	52.21	
5	105.06	43.71	52.33	
5.5	105.13	44.19	52.43	
6	105.2	44.68	52.5	6 mm
6.5	105.3	45.17	52.53	
7	105.43	45.65	52.54	
7.5	105.48	46.14	52.6	
8	105.56	46.64	52.62	8 mm
8.5	105.63	47.12	52.58	
9	105.63	47.61	52.56	
9.5	105.64	48.11	52.5	
10	105.61	48.6	52.45	10 mm
10.5	105.63	49.08	52.32	
11	105.67	49.54	52.12	
11.5	105.72	49.99	51.92	
12	105.75	50.46	51.74	12 mm
12.5	105.78	50.93	51.56	
13	105.83	51.37	51.34	
13.5	105.88	51.82	51.13	
14	105.93	52.26	50.9	14 mm
14.5	106	52.7	50.67	
15	106.07	53.11	50.4	
15.5	106.15	53.51	50.11	
16	106.2	53.92	49.84	16 mm
16.5	106.23	54.34	49.57	
17	106.21	54.76	49.3	
Ref. Plane (17.33)	106.18	55.04	49.13	

Table 6 – The x_m, y_m, z_m coordinates of the ear canal centre line and EEP projections of the concha bottom

Centre line [mm]	x_m	y_m	z_m	Cross section
17.5	106.17	55.18	49.03	
18	106.09	55.6	48.78	18 mm
18.5	105.97	56.02	48.54	
19	105.81	56.44	48.31	
19.5	105.64	56.83	48.06	
20	105.45	57.22	47.82	20 mm
20.5	105.21	57.61	47.62	
21	104.97	57.97	47.37	
21.5	104.69	58.33	47.16	
22	104.39	58.67	46.96	22 mm
22.5	104.08	59.03	46.8	
23	103.77	59.39	46.65	
23.5	103.46	59.74	46.48	
24	103.16	60.1	46.31	24 mm
24.5	102.87	60.47	46.14	
25	102.6	60.84	45.96	
25.5	102.35	61.24	45.8	
26	102.14	61.67	45.65	26 mm
26.5	101.99	62.11	45.48	
27	101.9	62.56	45.28	
27.5	101.87	63.03	45.11	
28	101.89	63.51	44.96	28 mm
EEP Projection 29.5 mm	103.90	64.07	42.59	29.5 mm
EEP Projection 31 mm	103.99	65.49	42.14	31 mm
EEP	104	66	42.99	
EEP Projection 32.5 mm	103.97	67.01	41.78	32.5 mm
ERP	110	77.73	40.8	

6.4.3.4.3 Unit vectors for each cross section of the ear canal

In order to align the cross section in 3D space on HATS, three unit vectors are assigned to each section on the centre line as illustrated in Figure 11:

\hat{c}_e : normal vector of each cross section pointing towards the tip of the ear canal along the centre line;

\hat{a}_e and \hat{b}_e : two unit vectors in the plane of each cross section perpendicular to \hat{c}_e .

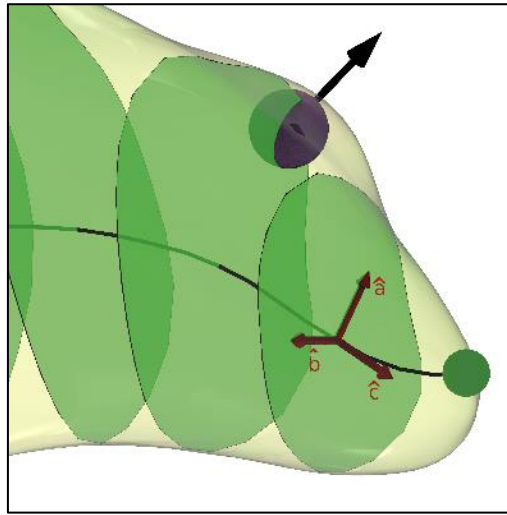

Figure 11 – Illustration of the three unit vectors \hat{a}_e , \hat{b}_e , \hat{c}_e assigned to each cross section. \hat{a}_e and \hat{b}_e are in the plane of the cross section, \hat{b}_e is parallel with HATS reference plane and \hat{c}_e points in the direction of the centre line towards the tip of the ear canal

The unit-vector \hat{b}_e is defined always to be parallel with HATS reference plane as well as the $x_m - y_m$ plane of the coordinate system of Figure 11 and can be found as:

$$\hat{b}_e = \frac{\hat{c}_e \times \hat{z}}{|\hat{c}_e \times \hat{z}|}$$

where \hat{z} is a unit-vector in the z_m direction. The other unit-vector \hat{a}_e of each cross section can then be found as

$$\hat{a}_e = \frac{\hat{b}_e \times \hat{c}_e}{|\hat{b}_e \times \hat{c}_e|}$$

By using the unit vectors as defined, sufficient information is now available to align each cross section correctly on the centre line defined in Table 6.

In a similar manner unit vectors are assigned to the EEP projection points defined in Table 6 for the cross sections of the concha bottom.

In Table 7 the x_m , y_m , z_m coordinates of the three unit vectors for all cross sections of the ear canal and concha bottom are given.

Table 7 – The x_m , y_m , z_m coordinates of the three unit vectors of all cross sections in the ear canal and concha bottom aligned on the centre line

Cross section	$\hat{a}_e(x_m, y_m, z_m)$ [mm]	$\hat{b}_e(x_m, y_m, z_m)$ [mm]	$\hat{c}_e(x_m, y_m, z_m)$ [mm]
0.5 mm	0.00	-0.98	-0.22
	-0.01	0.22	-0.98
	1.00	0.00	-0.01
2 mm	-0.18	-0.93	-0.31
	-0.46	0.36	-0.81
	0.87	0.00	-0.49
4 mm	-0.12	-0.95	-0.28

Table 7 – The x_m, y_m, z_m coordinates of the three unit vectors of all cross sections in the ear canal and concha bottom aligned on the centre line

Cross section	$\hat{a}_e(x_m, y_m, z_m)$ [mm]	$\hat{b}_e(x_m, y_m, z_m)$ [mm]	$\hat{c}_e(x_m, y_m, z_m)$ [mm]
	-0.36	0.30	-0.88
	0.92	0.00	-0.38
6 mm	-0.01	-0.99	-0.15
	-0.08	0.15	-0.99
	1.00	0.00	-0.08
8 mm	-0.01	-0.98	-0.20
	-0.07	0.20	-0.98
	1.00	0.00	-0.07
10 mm	0.00	-1.00	-0.01
	0.22	0.01	-0.98
	0.98	0.00	0.22
12 mm	0.01	-1.00	-0.03
	0.37	0.03	-0.93
	0.93	0.00	0.37
14 mm	0.06	-0.99	-0.12
	0.48	0.13	-0.87
	0.87	0.00	0.49
16 mm	0.02	-1.00	-0.03
	0.44	0.04	-0.90
	0.90	0.00	0.44
Ref. Plane	-0.05	-1.00	0.08
	0.56	-0.09	-0.82
	0.82	0.00	0.57
18 mm	-0.11	-0.97	0.20
	0.47	-0.23	-0.85
	0.87	0.00	0.49
20 mm	-0.18	-0.87	0.45
	0.32	-0.49	-0.81
	0.93	0.00	0.37
22 mm	-0.18	-0.76	0.63
	0.21	-0.65	-0.73
	0.96	0.00	0.28
24 mm	-0.22	-0.78	0.58
	0.28	-0.63	-0.73
	0.93	0.00	0.36
26 mm	-0.15	-0.91	0.39

Table 7 – The x_m, y_m, z_m coordinates of the three unit vectors of all cross sections in the ear canal and concha bottom aligned on the centre line

Cross section	$\hat{a}_e(x_m, y_m, z_m)$ [mm]	$\hat{b}_e(x_m, y_m, z_m)$ [mm]	$\hat{c}_e(x_m, y_m, z_m)$ [mm]
	0.33	-0.42	-0.84
	0.93	0.00	0.37
28 mm	0.03	-1.00	-0.09
	0.33	0.09	-0.94
	0.94	0.00	0.33
(29.5 mm)	0.02	-1.00	-0.05
	0.29	0.05	-0.96
	0.96	0.00	0.29
(31 mm)	0.00	-1.00	-0.01
	0.26	0.01	-0.97
	0.97	0.00	0.26
(32.5 mm)	-0.01	-1.00	0.03
	0.21	-0.03	-0.98
	0.98	0.00	0.21

6.4.3.4.4 Cross sectional areas of the ear canal and concha bottom

The cross sectional areas of the ear canal and the concha bottom as illustrated in Figure 10 in the plane of the two unit vectors \hat{b}_e, \hat{a}_e . They are as illustrated in Figure 11 and are plotted in Figure 12 and listed in tables in clause B.2.

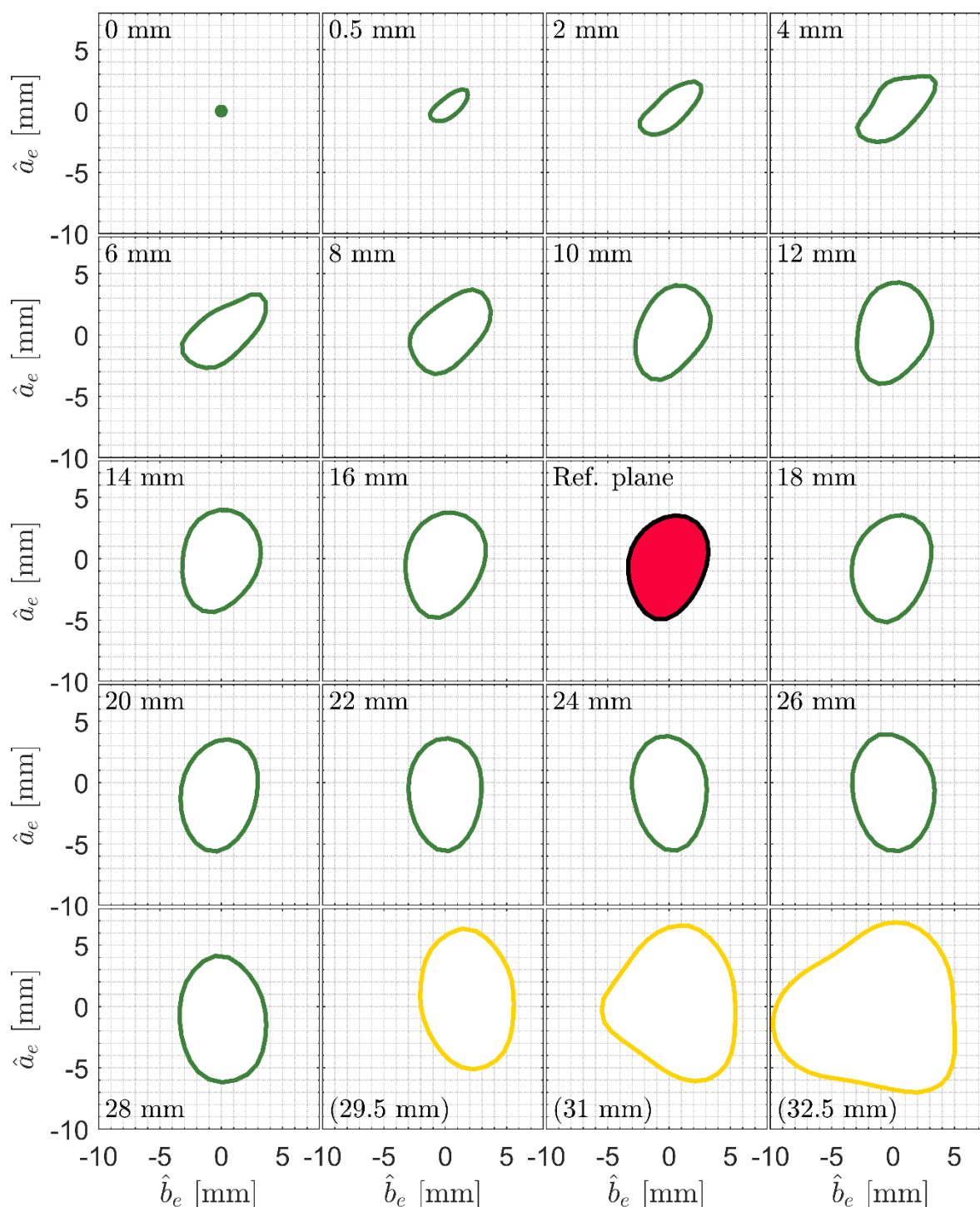

Figure 12 – Cross sectional areas in the \hat{b}_e, \hat{a}_e plane of the two unit vectors

6.4.3.4.5 Geometry of anatomically shaped pinna simulator

The type 4.3 artificial ear is achieved by adding a type 3.3 based pinna simulator device to the concha bottom of the ear simulator. To obtain a well-defined transition from type 3.3 to type 4.3 pinna, the method described in clauses 6.4.3.4.1 to 6.4.3.4.4 has been extended to obtain closely spaced cross sections of the geometry of the pinna simulator device as illustrated by the blue planes in Figure 13.

In contrast to Figures 7-b and 7-c, where the type 3.3 pinna is sliced horizontally, the type 4.3 pinna is sliced in parallel planes and tilted by 8.1 degrees relative to the vertical plane of HATS. These cross sections are parallel with the cheek of HATS and corresponds to the vertical tilt of the ear-cap vector of the handset position for HATS as defined in Annex E of [ITU-T P.64]. Thereby the first blue plane

of the pinna is closely located to and can be connected to the last yellow plane of the concha bottom, as illustrated in Figure 13.

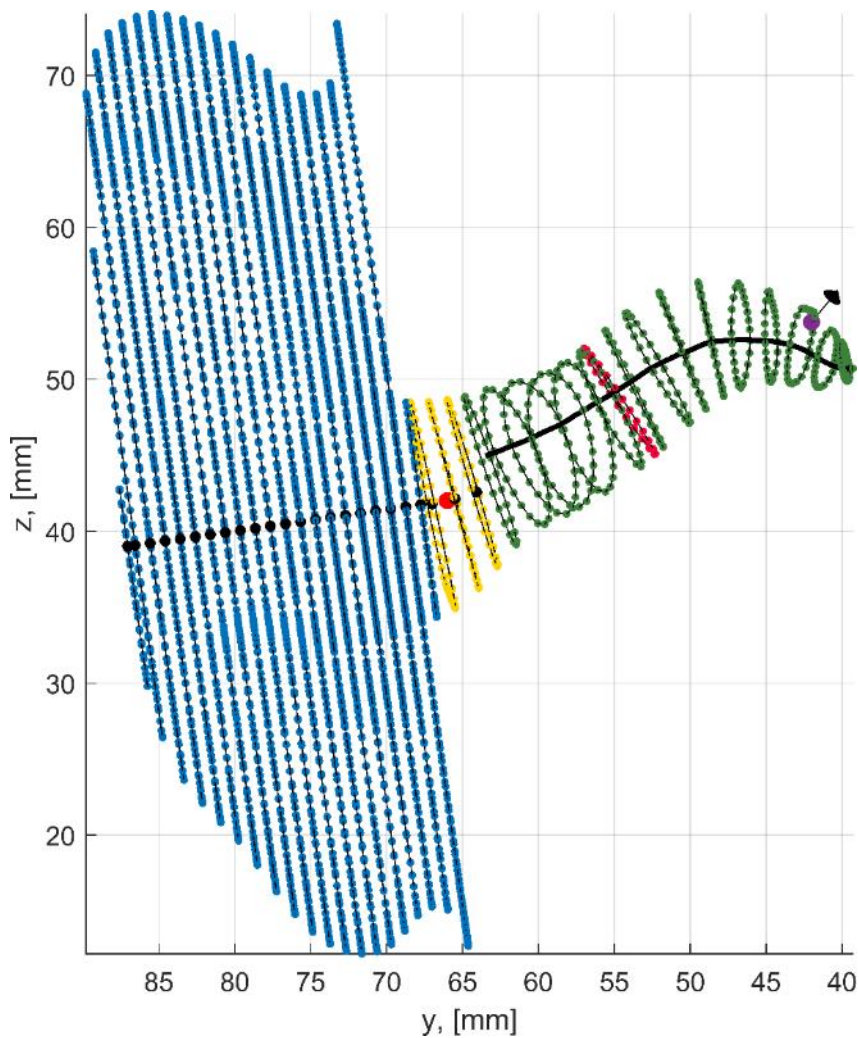

Figure 13-a – Points on the periphery of the cross-sectional areas of the anatomically shaped ear canal, concha bottom and pinna simulator of the type 4.3 ear simulator. The green and yellow cross sections represent the ear canal and concha bottom, the red cross section is the reference plane of the ear canal. The purple point is the DRP and the vector is the normal vector of the measurement plane. The blue cross sections represent the pinna.

The black line is the centre line, the red dot is EEP and the black dots are the projections of EEP onto each plane.

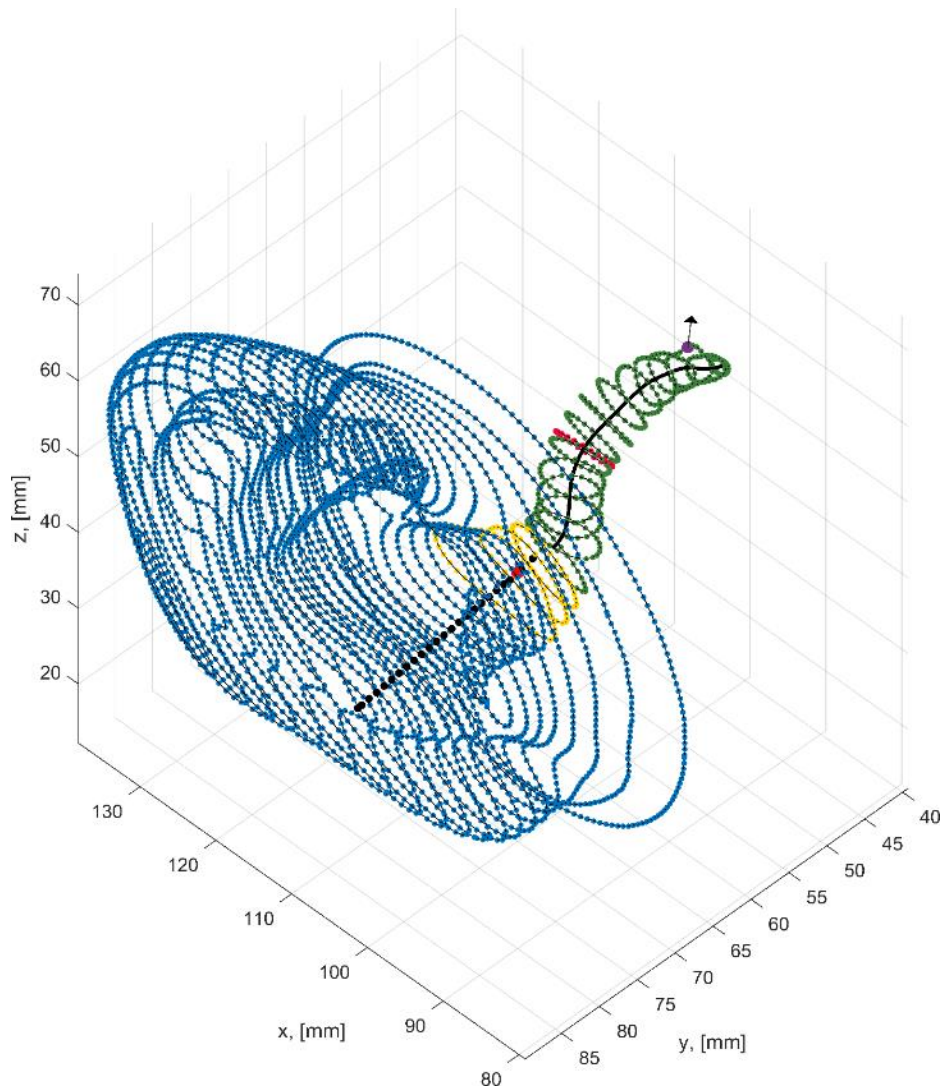

Figure 13-b – A different viewing angle of Figure 13-a

6.4.3.4.6 Coordinates of the EEP projections for the pinna simulator

The origin coordinate for the cross section of the pinna, as illustrated by the black dot in each of the blue planes in Figure 13, is found from perpendicular projections from each plane to the EEP, following the method as described in clause B.1 for the cross sections of the concha bottom. The distance indicates the parallel distance between each plane relative to the cheek of HATS.

Table 8 – The x_m , y_m , z_m coordinates of the EEP projections for the pinna simulator

Relative distance from cheek plane of HATS [mm]	x_m	y_m	z_m
-1	104.00	67.75	41.75
0	104.00	68.74	41.61
1	104.00	69.73	41.47
2	104.00	70.72	41.33
3	104.00	71.71	41.19
4	104.00	72.70	41.04
5	104.00	73.69	40.90
6	104.00	74.68	40.76

Table 8 – The x_m , y_m , z_m coordinates of the EEP projections for the pinna simulator

Relative distance from cheek plane of HATS [mm]	x_m	y_m	z_m
7	104.00	75.67	40.62
8	104.00	76.66	40.48
9	104.00	77.65	40.34
10	104.00	78.64	40.20
11	104.00	79.63	40.06
12	104.00	80.62	39.92
13	104.00	81.61	39.77
14	104.00	82.60	39.63
15	104.00	83.59	39.49
16	104.00	84.58	39.35
17	104.00	85.57	39.21
18	104.00	86.56	39.07
18.5	104.00	87.06	39.00

6.4.3.4.7 Unit vector for the cross section of the pinna simulator

In order to align the cross section of the pinna in 3D space on HATS, the three unit vectors as defined in clause 3.2 is assigned to each cross section of the pinna simulator. As the cross sections of the pinna are all parallel, as illustrated by the blue planes of Figure 13, the same three unit vector apply for all cross sections of the pinna.

In Table 9, the x_m , y_m , z_m coordinates of the three unit vectors are applicable for all cross sections of the pinna simulator, aligned at the EEP projection points of Table 9, as illustrated by the black dots of the blue planes shown in Figure 13.

Table 9 – The x_m , y_m , z_m coordinates of the three unit vectors applicable for all cross sections of the pinna aligned at the EEP projection points

$\hat{a}_e(x_m, y_m, z_m)$ [mm]	$\hat{b}_e(x_m, y_m, z_m)$ [mm]	$\hat{c}_e(x_m, y_m, z_m)$ [mm]
0	-1	0
0.14	0	-0.99
0.99	0	0.14

6.4.3.4.8 Cross sectional areas of the pinna simulator

The cross sectional areas of the pinna as illustrated in Figure 13 in the plane of the two unit vectors \hat{b}_e, \hat{a}_e as defined in clause 6.4.3.4.3 are plotted in Figure 14 and listed in tables in clause B.3. The type 4.3 pinna is sliced in cross sections with 1mm between each plane due to the complex anatomy of the pinna compared to the ear canal and concha bottom. The blue areas in Figure 14 indicate the solid areas of the pinna, and the white areas indicate air. The red dot placed at the origin of each plot is the projection of the EEP onto that particular plane as listed in Table 8 and illustrated in Figure 13 by the black dot in the blue planes of the pinna.

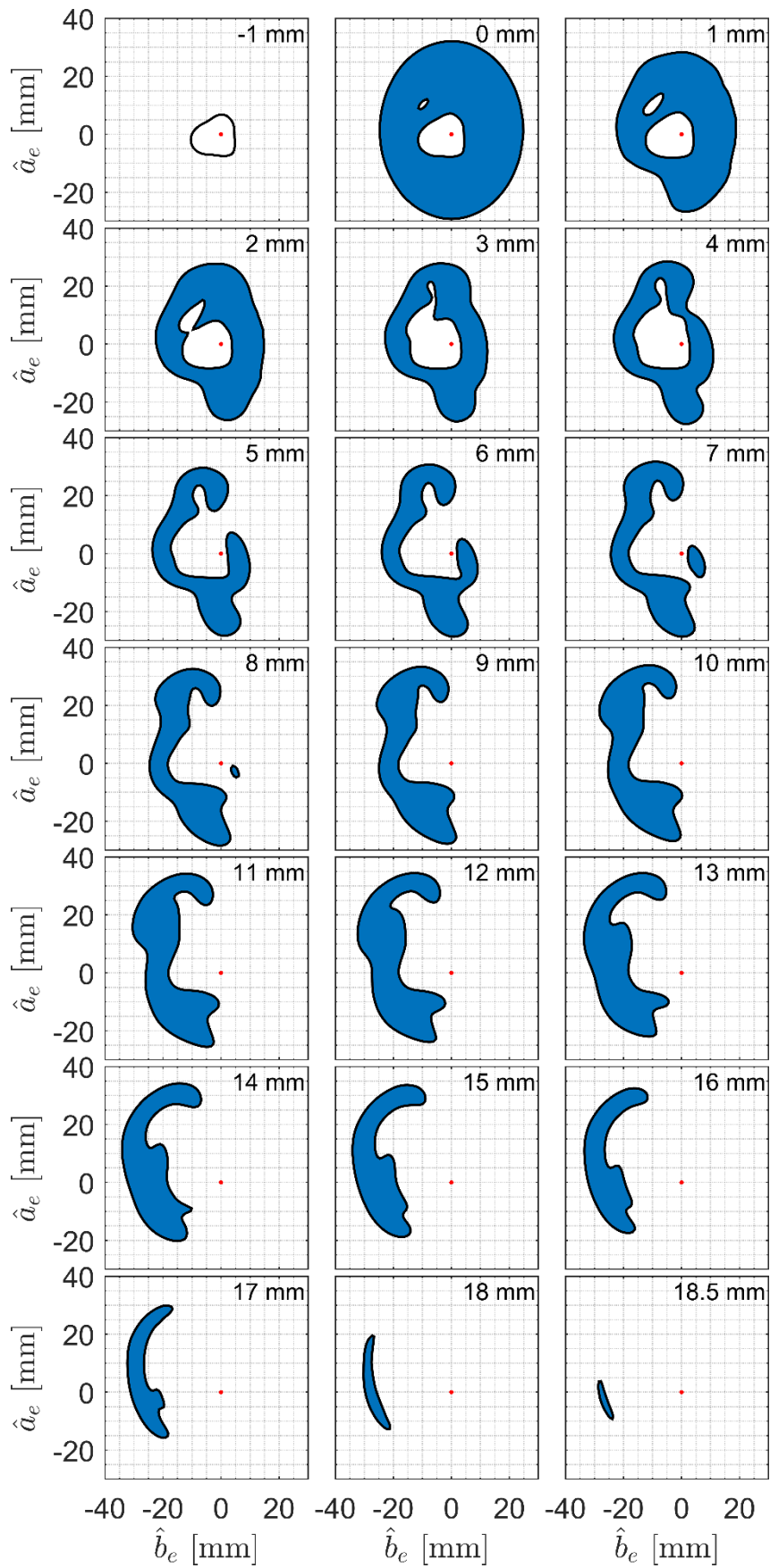

Figure 14 – Cross sectional areas of the pinna in the \hat{b}_e, \hat{a}_e plane of the two unit vectors

6.4.4 Type 4.4 ear simulator

6.4.4.1 Overview

The type 4.4 artificial ear can be used as an alternative to the type 4.3 ear simulator for almost all types of applications. It consists of the same pinna, concha bottom and ear canal entry as the type 4.3 up to the reference plane. The remaining inner part of the ear canal between reference plane and DRP is based on [IEC 60318-4], and consists of a transition piece and a cylindrically shaped cavity.

The type 4.4 artificial ear can be used for all types of devices, except for deep intra-concha or insert devices, which extend beyond the reference plane. In such cases, the type 4.3 ear simulator shall be used.

NOTE 1 – The application force of hard ear-caps against the type 4.4 pinna simulator should preferably be about 10 N. The force applied in the measurements shall always be reported.

NOTE 2 – HATS with flexible pinna simulators are the only artificial ears recommended for headset measurements as described in [ITU-T P.380]. However, in case artificial ears of type 1, 2 or 3 are used, and if different measurement results are obtained compared to the type 4.4 artificial ears, the results from the type 4.4 artificial ears shall take precedence.

6.4.4.2 Ear-drum reference point to ear reference point correction

The sound pressure measured by the type 4.4 artificial ear refers to the ear-drum reference point (DRP). The correction function given in Tables 5-a (1/3 octave band measurements) and 5-b (1/12 octave band and sine measurements) shall be used for converting data to the ear reference point (ERP) when it is required to calculate loudness ratings or to check results against specifications based on measurements referring to the ERP.

NOTE – For receive loudness rating calculations according to [ITU-T P.79], the real ear loss correction L_E should be set to zero.

6.4.4.3 Transfer impedance

The transfer impedance of the ear canal simulator is slightly different as for type 4.3 ear simulator (see clause 6.4.3.3), and is measured between the reference plane, as shown in Figure 15, and the DRP. The magnitude for transfer impedance and tolerances versus frequency are provided in Table 10.

NOTE 1 – At 500 Hz, the magnitude of the acoustic transfer impedance $27.7 \text{ MPa}\cdot\text{s}/\text{m}^3$ corresponds to the magnitude of the effective volume of the ear simulator $1.63 \pm 0.10 \text{ cm}^3$.

NOTE 2 – The nominal transfer impedance in Table 10 is that of the Type 4.3 ear simulator, whereas the upper tolerance from 20 Hz to 180 Hz and the lower tolerances at 20 kHz has been extended to accommodate the Type 4.4 ear simulator.

Table 10 – Transfer impedance (times f) for type 4.4 ear simulator relative to the reference frequency 500 Hz for a nominal effective volume of $1.63 \text{ cm}^3 (\pm 0.10 \text{ cm}^3)$

Frequency (Hz)	Transfer imp. x f Rel. 500 Hz	Tol. upper (dB)	Tol. lower (dB)	Frequency (Hz)	Transfer imp. x f Rel. 500 Hz	Tol. upper (dB)	Tol. lower (dB)
20	-4.56	+6.2	-1.1	670	0.42	+0.9	-1.1
21	-4.50	+6.1	-1.1	710	0.59	+0.9	-1.1
22	-4.32	+6.1	-1.3	750	0.78	+0.8	-1.2
24	-4.15	+6.0	-1.3	800	1.04	+0.8	-1.2
25	-4.14	+5.7	-1.1	850	1.38	+0.7	-1.3
27	-3.97	+5.8	-1.3	900	1.74	+0.7	-1.3

Table 10 – Transfer impedance (times f) for type 4.4 ear simulator relative to the reference frequency 500 Hz for a nominal effective volume of 1.63 cm³ (± 0.10 cm³)

Frequency (Hz)	Transfer imp. x f Rel. 500 Hz	Tol. upper (dB)	Tol. lower (dB)	Frequency (Hz)	Transfer imp. x f Rel. 500 Hz	Tol. upper (dB)	Tol. lower (dB)
28	-3.87	+5.7	-1.3	950	2.14	+0.7	-1.3
30	-3.71	+5.5	-1.3	1000	2.56	+0.7	-1.3
32	-3.61	+5.4	-1.3	1060	3.07	+0.7	-1.3
34	-3.46	+5.4	-1.4	1120	3.58	+0.8	-1.2
36	-3.34	+5.2	-1.4	1180	4.06	+0.8	-1.2
38	-3.20	+5.1	-1.4	1250	4.57	+0.9	-1.1
40	-3.06	+5.1	-1.5	1320	5.02	+0.9	-1.1
43	-2.93	+4.9	-1.5	1400	5.45	+1.0	-1.0
45	-2.80	+4.8	-1.5	1500	5.88	+1.0	-1.0
48	-2.65	+4.7	-1.5	1600	6.22	+1.1	-0.9
50	-2.56	+4.6	-1.5	1700	6.51	+1.1	-0.9
53	-2.42	+4.4	-1.5	1800	6.75	+1.1	-0.9
56	-2.30	+4.4	-1.6	1900	6.98	+1.1	-0.9
60	-2.15	+4.3	-1.6	2000	7.19	+1.1	-0.9
63	-2.05	+4.2	-1.6	2120	7.45	+1.1	-0.9
67	-1.93	+4.0	-1.6	2240	7.71	+1.1	-0.9
71	-1.83	+3.9	-1.6	2360	7.96	+1.1	-0.9
75	-1.69	+3.3	-1.1	2500	8.27	+1.1	-0.9
80	-1.58	+3.2	-1.1	2650	8.59	+1.1	-0.9
85	-1.48	+3.1	-1.1	2800	8.91	+1.2	-0.8
90	-1.38	+3.0	-1.1	3000	9.31	+1.2	-0.8
95	-1.30	+2.9	-1.1	3150	9.58	+1.2	-0.8
100	-1.22	+2.8	-1.1	3350	9.91	+1.2	-0.8
106	-1.11	+2.7	-1.1	3550	10.21	+1.2	-0.8
112	-1.03	+2.6	-1.1	3750	10.47	+1.2	-0.8
118	-0.98	+2.6	-1.1	4000	10.77	+1.2	-0.8
125	-0.89	+2.5	-1.1	4250	11.05	+1.2	-0.8
132	-0.83	+2.4	-1.1	4500	11.33	+1.2	-0.8
140	-0.77	+2.4	-1.1	4750	11.61	+1.1	-0.9
150	-0.70	+2.3	-1.1	5000	11.90	+1.1	-1.4
160	-0.64	+2.2	-1.1	5300	12.29	+1.1	-1.4
170	-0.58	+2.2	-1.1	5600	12.71	+1.5	-1.5
180	-0.55	+2.2	-1.1	6000	13.34	+1.7	-1.6
190	-0.51	+1.0	-1.0	6300	13.88	+1.6	-1.6
200	-0.47	+1.0	-1.0	6700	14.68	+1.8	-1.7
212	-0.43	+1.0	-1.0	7100	15.58	+1.7	-2.8

Table 10 – Transfer impedance (times f) for type 4.4 ear simulator relative to the reference frequency 500 Hz for a nominal effective volume of 1.63 cm³ (± 0.10 cm³)

Frequency (Hz)	Transfer imp. x f Rel. 500 Hz	Tol. upper (dB)	Tol. lower (dB)	Frequency (Hz)	Transfer imp. x f Rel. 500 Hz	Tol. upper (dB)	Tol. lower (dB)
224	-0.40	+1.0	-1.0	7500	16.61	+2.1	-2.9
236	-0.37	+1.0	-1.0	8000	18.10	+1.9	-3.1
250	-0.34	+1.0	-1.0	8500	19.87	+2.7	-3.3
265	-0.31	+1.0	-1.0	9000	21.96	+2.9	-4.1
280	-0.28	+1.0	-1.0	9500	24.40	+2.6	-4.4
300	-0.26	+1.0	-1.0	10000	26.96	+2.4	-4.6
315	-0.23	+1.0	-1.0	10600	28.39	+3.7	-2.8
335	-0.22	+1.0	-1.0	11200	27.18	+4.5	-3.7
355	-0.18	+1.0	-1.0	11800	24.82	+5.2	-4.1
375	-0.17	+1.0	-1.0	12500	22.56	+4.2	-3.8
400	-0.13	+1.0	-1.0	13200	20.98	+3.4	-4.6
425	-0.10	+1.0	-1.0	14000	19.91	+3.1	-4.9
450	-0.07	+1.0	-1.0	15000	19.34	+2.8	-7.2
475	-0.04	+1.0	-1.0	16000	19.50	+2.6	-7.4
500	0.00	+1.0	-1.0	17000	20.76	+3.0	-8.0
530	0.05	+1.0	-1.0	18000	23.28	+5.1	-7.9
560	0.11	+1.0	-1.0	19000	28.36	+6.8	-9.5
600	0.21	+0.9	-1.1	20000	32.11	+4.6	-13.4
630	0.29	+0.9	-1.1				

6.4.4.4 Geometry of the ear simulator

6.4.4.4.1 Overview

The geometry of the ear canal for type 4.4 is two-folded: the first part consists of the same pinna, concha bottom and ear canal entry as specified for type 4.3 (see clause 6.4.3.4) up to the reference plane (see Figure 15). The second part consists of a transition piece and a cylindrically shaped cavity, which is shown in Figure 17.

Since the main part of the inner ear canal has a cylindric shape, a short transition piece of 1 mm length shall be used. The centre line and cross-sections are provided in the following clauses in a similar way as in clause 6.4.3, but with a much higher resolution (steps of 0.25 mm).

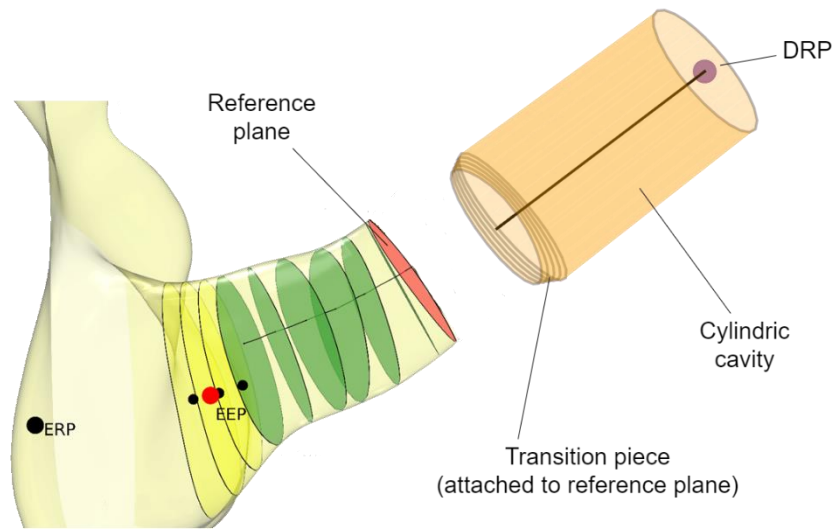

Figure 15 – Cross sectional areas of the anatomically shaped ear canal and concha bottom of the type 4.4 ear simulator

The major part of the inner ear canal is realized as a cylindric cavity and is similar to the principal cavity in the ear simulator described in [IEC 60318-4], which is used for the type 3.3 ear. Figure 16 shows the full geometry, which also includes two additional volumes. The DRP is located at the end plane of the cylinder and has the same orientation as the centre line.

The following dimensions of the cylindric cavity shall be considered for an implementation:

- The diameter D of the principal cavity shall be 7.50 mm with a tolerance of ± 0.1 mm.
- The length L of the principal cavity shall be dimensioned to produce a half-wavelength resonance of the sound pressure at 11.2 kHz with a tolerance of ± 1.0 kHz (see also definition of transfer impedance in clause 6.4.3.3) of the whole inner ear canal part (including the transition piece).
- The length L of the principal cavity shall be 14.25 mm (excluding the transition piece). A tolerance of ± 0.5 mm allows an adjustment regarding the resonance frequency.

To meet the transfer impedance requirement, two volumes V_1 and V_2 as indicated in Figure 16 may be required.

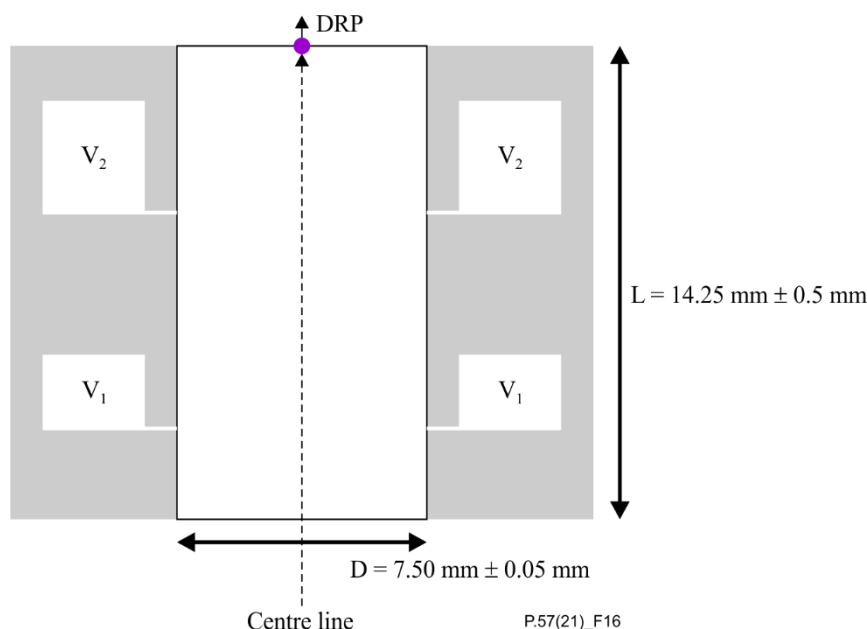

Figure 16 – Geometry of cylindrical cavity of the inner part of the ear canal

6.4.4.4.2 Coordinates of the centre line and the concha bottom

The coordinates of the centre line and the concha bottom are defined in the same way as for type 4.3 ear simulator (see clause 6.4.3.4.2) in Table 11. In contrast to the ear canal geometry of the type 4.3 ear, the specification of the centre line for type 4.4 ear is defined at several non-equidistant positions due to the following reasons:

- The cylindrical cavity is already completely defined by radius (7.5 mm) and length (14.25 mm), see Figure 16.
- The resolution of the transition piece (14.25 to 15.25 mm) is provided in a higher resolution (0.25 mm) to ensure that the anatomically shaped ear canal entry is seamlessly attached.
- To exactly meet the same coordinates and cross-section definitions as in clause 6.4.3.4.2 for the ear canal entry, the centre line after the transition piece (15.42 mm) is aligned to the centre line position 17.5 mm of type 4.3.

Table 11 – The x_m , y_m , z_m coordinates of the ear canal centre line and EEP projections of the concha bottom for type 4.4

Centre line [mm]	x_m	y_m	z_m	Comment
0	107.32	43.36	57.25	DRP plane
14.25	106.38	54.14	49.57	Connection to cylindrical cavity
14.5	106.33	55.12	49.46	Transition piece
14.75	106.28	55.09	49.35	Transition piece
15	106.23	55.07	49.24	Transition piece
15.25	106.18	55.04	49.13	Reference Plane
15.42	106.17	55.18	49.03	(equals 17.5 mm of type 4.3)
15.92	106.09	55.6	48.78	
16.42	105.97	56.02	48.54	
16.92	105.81	56.44	48.31	
17.42	105.64	56.83	48.06	
17.92	105.45	57.22	47.82	

Table 11 – The x_m, y_m, z_m coordinates of the ear canal centre line and EEP projections of the concha bottom for type 4.4

Centre line [mm]	x_m	y_m	z_m	Comment
18.42	105.21	57.61	47.62	
18.92	104.97	57.97	47.37	
19.42	104.69	58.33	47.16	
19.92	104.39	58.67	46.96	
20.42	104.08	59.03	46.8	
20.92	103.77	59.39	46.65	
21.42	103.46	59.74	46.48	
21.92	103.16	60.1	46.31	
22.42	102.87	60.47	46.14	
22.92	102.6	60.84	45.96	
23.42	102.35	61.24	45.8	
23.92	102.14	61.67	45.65	
24.42	101.99	62.11	45.48	
24.92	101.9	62.56	45.28	
25.42	101.87	63.03	45.11	
25.92	101.89	63.51	44.96	(equals 28 mm of type 4.3)
	103.90	64.07	42.59	EEP Projection #1
	103.99	65.49	42.14	EEP Projection #2
	104	66	42.99	EEP
	103.97	67.01	41.78	EEP Projection #3
	110	77.73	40.8	ERP

6.4.4.4.3 Unit vectors for each cross section of the ear canal

The unit vectors for each cross section of the ear canal are defined in the same way as for type 4.3 ear simulator (see clause 6.4.3.4.3). In Table 12, the x_m, y_m, z_m coordinates of the three unit vectors for all cross sections of the ear canal entry and concha bottom are given. Note that the unit vector is the same for all cross-sections in the inner part of the ear canal.

Table 12 – The x_m, y_m, z_m coordinates of the three unit vectors of all cross sections in the ear canal and concha bottom aligned on the centre line

Cross section [mm]	$\hat{a}_e(x_m, y_m, z_m)$ [mm]	$\hat{b}_e(x_m, y_m, z_m)$ [mm]	$\hat{c}_e(x_m, y_m, z_m)$ [mm]
DRP Plane (0) to Ref. Plane (15.25)	-0.05	-1.00	0.08
	0.56	-0.09	-0.82
	0.82	0.00	0.57
15.92	-0.11	-0.97	0.20
	0.47	-0.23	-0.85
	0.87	0.00	0.49
17.92	-0.18	-0.87	0.45

Table 12 – The x_m, y_m, z_m coordinates of the three unit vectors of all cross sections in the ear canal and concha bottom aligned on the centre line

Cross section [mm]	$\hat{a}_e(x_m, y_m, z_m)$ [mm]	$\hat{b}_e(x_m, y_m, z_m)$ [mm]	$\hat{c}_e(x_m, y_m, z_m)$ [mm]
	0.32	-0.49	-0.81
	0.93	0.00	0.37
19.92	-0.18	-0.76	0.63
	0.21	-0.65	-0.73
	0.96	0.00	0.28
21.92	-0.22	-0.78	0.58
	0.28	-0.63	-0.73
	0.93	0.00	0.36
23.92	-0.15	-0.91	0.39
	0.33	-0.42	-0.84
	0.93	0.00	0.37
25.92	0.03	-1.00	-0.09
	0.33	0.09	-0.94
	0.94	0.00	0.33
EEP Projection #1	0.02	-1.00	-0.05
	0.29	0.05	-0.96
	0.96	0.00	0.29
EEP Projection #2	0.00	-1.00	-0.01
	0.26	0.01	-0.97
	0.97	0.00	0.26
EEP Projection #3	-0.01	-1.00	0.03
	0.21	-0.03	-0.98
	0.98	0.00	0.21

6.4.4.4.4 Cross sectional areas of the ear canal and concha bottom

The cross-sectional areas of the ear canal entry and concha bottom are the same as for type 4.3 ear simulator (see clause 6.4.3.4.4 and clause B.2). Only the areas from the reference plane to the outer concha bottom are applicable.

Figure 17 illustrates the cross-sectional areas of the ear canal entry and concha bottom in the plane of the two unit vectors \hat{b}_e, \hat{a}_e as illustrated in Figure 11. Tabular data of the cross-sections are provided in clause C.2.

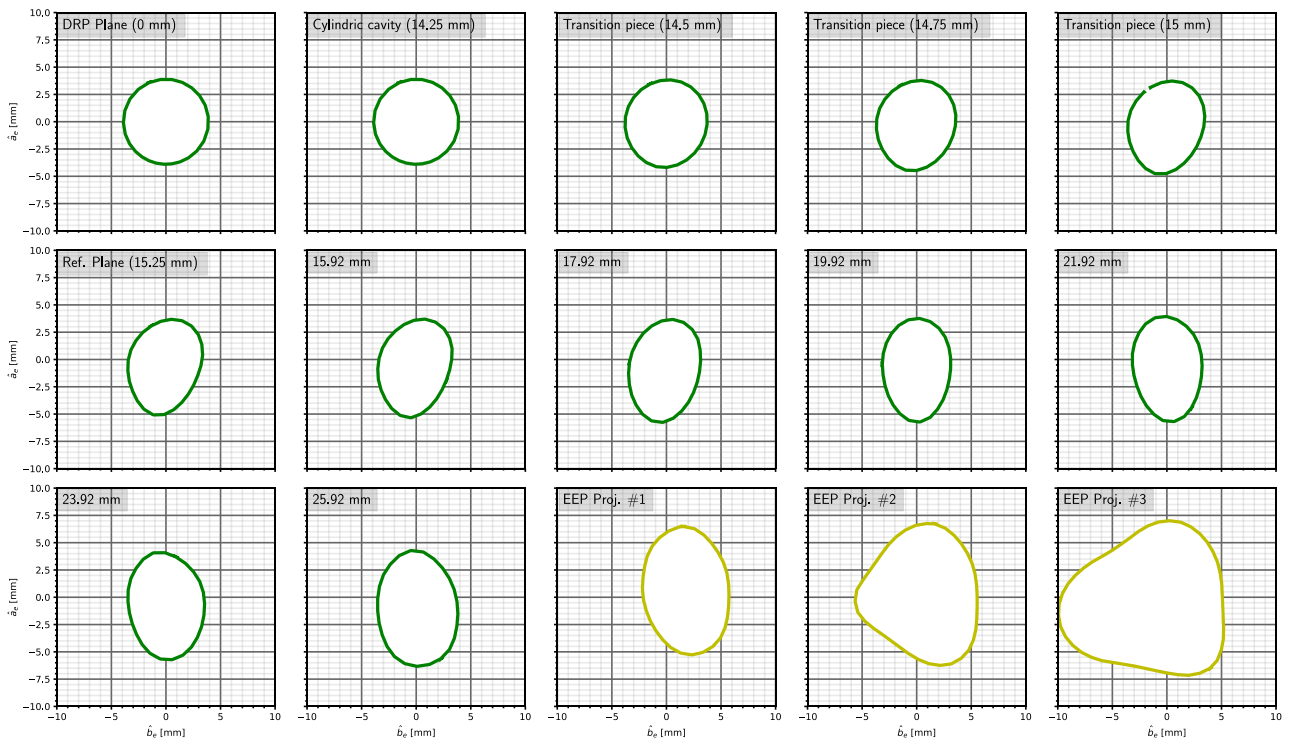

Figure 17 – Cross sectional areas in the \hat{b}_e, \hat{a}_e plane of the two unit vectors

6.4.4.4.5 Geometry of anatomically shaped Pinna Simulator

The geometry of anatomically shaped pinna simulator is the same as for type 4.3 ear simulator (see clause 6.4.3.4.5).

6.4.4.4.6 Coordinates of the EEP projections

The coordinates of the EEP projections of the pinna simulator are the same as for type 4.3 ear simulator (see clause 6.4.3.4.6 and clause B.1/C.1).

6.4.4.4.7 Unit vector for the cross section of the pinna simulator

The unit vectors for the cross section of the pinna simulator are the same as for type 4.3 ear simulator (see clause 6.4.3.4.7).

6.4.4.4.8 Cross sectional areas of the pinna simulator

The cross-sectional areas of the pinna simulator are the same as for type 4.3 ear simulator (see clause 6.4.3.4.8 and clause B.3/C.3).

6.5 Calibration of the artificial ears type 1 and type 3.2

6.5.1 Performance testing of the IEC 60318-4 occluded-ear simulator (type 3.2 only)

The proper performance of the IEC 60318-4 occluded-ear simulator, which is an integral part of the type 3.2 artificial ear, is essential to the performance of the complete artificial ear.

NOTE – Performance testing and calibration of the occluded-ear simulator are specified in [IEC 60318-4].

6.5.2 Frequency sensitivity response

The artificial ear to be calibrated is mounted in a large plane baffle. The sound pressure is measured immediately in front of the ERP using a probe microphone with its probe tip (diameter less than 1.5 mm) positioned at the ear reference plane as indicated in Figure 18.

The frequency sensitivity response (open ear condition) is then defined as the ratio between the output of the artificial ear and the corresponding sound pressure at the ERP recorded by the probe microphone when subjected to a plane incident wave perpendicular to the baffle.

NOTE 1 – The frequency sensitivity response has a very low sensitivity to the positioning of the sound source. In practice, therefore, more compact calibration set-ups may be realized with or without correction of the results, depending on the required calibration accuracy.

NOTE 2 – The frequency sensitivity response under closed ear conditions may be measured using the calibration set-up for acoustic input impedance described in clause 6.4.3. It is determined as the ratio between the output of the artificial ear and the sound pressure recorded by the probe microphone at the ERP.

NOTE 3 – The frequency sensitivity response shall normally be determined within the range of atmospheric reference conditions given in clause 6.6 at the frequencies listed in Table 2-b. The actual atmospheric conditions shall be reported. When the artificial ear operating conditions are significantly different from the reference conditions, the calibration of the frequency sensitivity response should, if possible, be performed under the operating conditions.

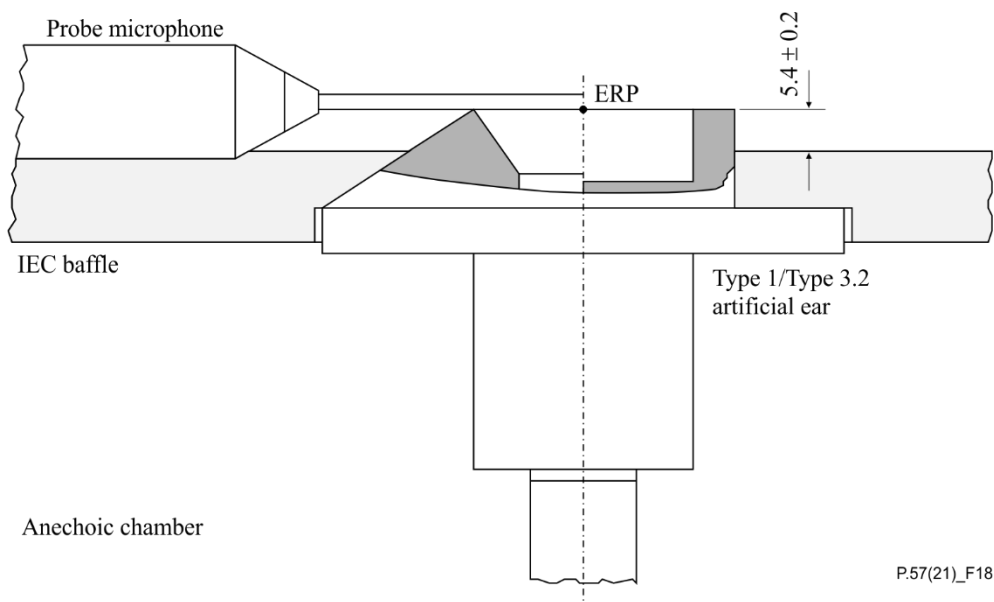

Figure 18 – Set-up for measuring the frequency sensitivity response (open ear conditions) of type 1 and type 3.2 artificial ears

6.5.3 Acoustic input impedance

A 1/2" working-standard pressure microphone (IEC WS2P) with its protection grid mounted is placed in a flat surface and concentrically applied and sealed to the artificial ear for use as a constant volume velocity source, driving the artificial ear at the ERP. The corresponding sound pressure at the ERP shall be measured using a probe microphone with its probe tip (diameter less than 1.5 mm) positioned at the ERP. The distance between the microphone grid and the pickup point of the ear simulator shall be less than 1 mm. A practical implementation of a calibration device is shown in Figure 19.

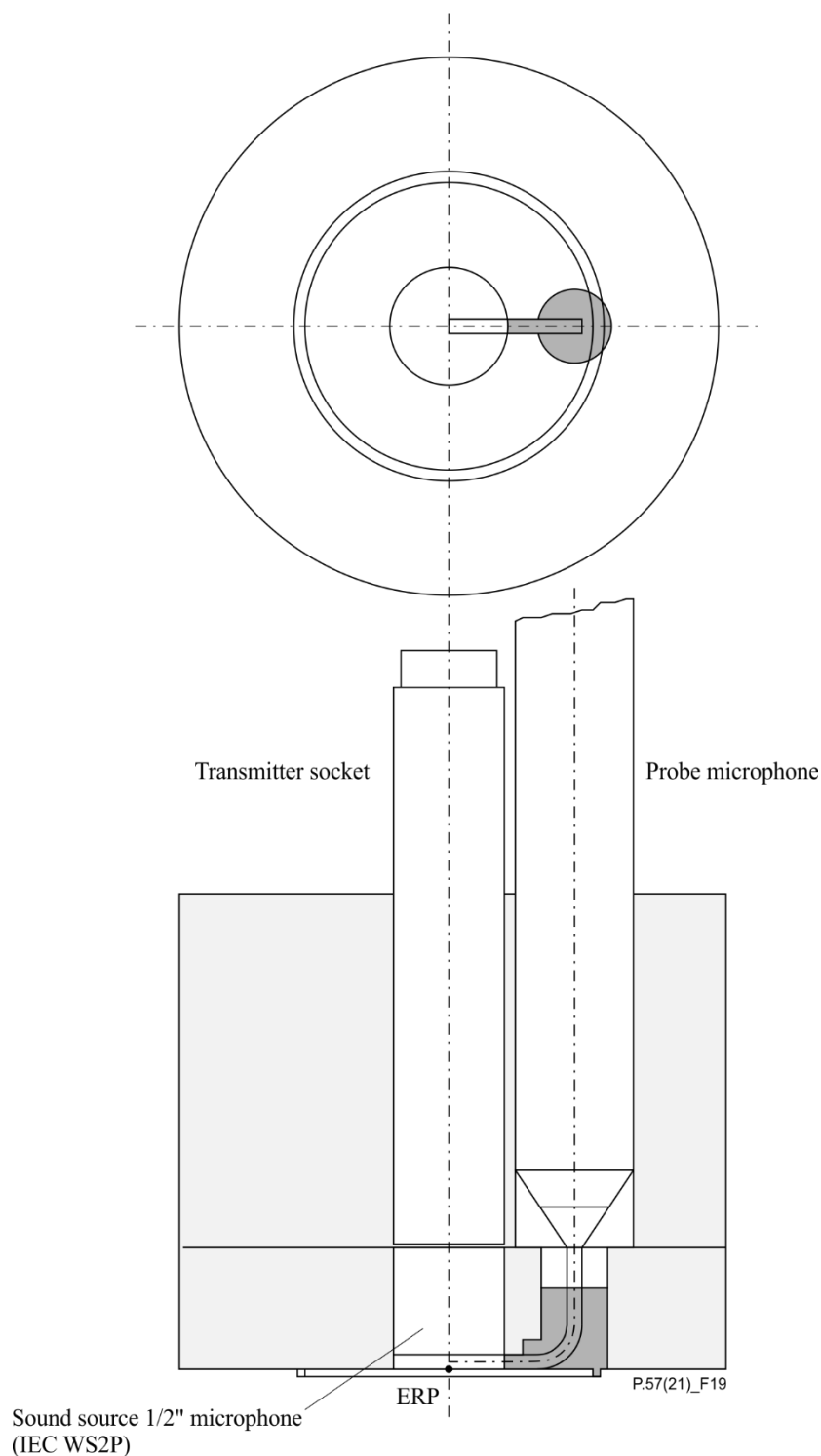

Figure 19 – Practical implementation of a calibration device (impedance probe) for measuring acoustical input impedance of type 1 and type 3.2 artificial ears

The acoustic input impedance is then defined as the ratio between the sound pressure recorded by the probe microphone and the volume velocity generated by the 1/2" microphone.

NOTE – The acoustic input impedance shall be determined within the range of atmospheric reference conditions given in clause 6.6. The actual conditions shall be reported.

Annex A contains a practical description of a procedure which allows complete calibration based on a calibrated reference microphone and a calibrated volume.

6.6 Performance verification of the artificial ears types 2, 3.1, 3.3 and 3.4

These types of artificial ears do not provide a well-defined ERP, as they either do not simulate the pinna or feature a flexible pinna which may cause the frequency sensitivity response and acoustical input impedance to change as a function of application pressure. Thus, an actual calibration with respect to frequency sensitivity response as well as acoustic input impedance is not relevant.

The performance verification of these artificial ears, therefore, relies exclusively on the performance testing and calibration of the occluded ear simulator as specified in [IEC 60318-4] in combination with a verification of the mechanical properties of the pinna simulator (Types 3.3 and 3.4 only).

6.7 Atmospheric reference conditions

It is recommended that measurements using artificial ears be performed under the following reference conditions:

Static pressure: 101.3 ± 3.0 kPa;

Temperature: $23 \pm 3^\circ$ C;

Humidity: $60 \pm 20\%$.

NOTE – When it is required to perform measurements under other atmospheric conditions, the actual conditions shall be reported.

6.8 General requirements

The metallic parts composing the artificial ears shall be made of non-magnetic material.

NOTE – The IEC WS2P microphones used in the artificial ears may contain magnetic material.

6.9 Ear-drum reference point to ear reference point correction

While type 2, 3.3 and 3.4 artificial ears are calibrated by applying a known acoustic pressure to the DRP, Types 1 and 3.2 are calibrated by applying a known acoustic pressure to the ERP. As a consequence, the acoustic pressure measured by means of Types 2, 3.3 and 3.4 shall be referred to the ERP by means of the standardized correction functions reported in Tables 2-a and 2-b, while the pressure measured by Types 1 and 3.2 is directly referring to the ERP.

NOTE – The individual calibration of Types 1 and 3.2 can either be provided by the manufacturer in terms of the overall electro-acoustic sensitivity from the ERP to the electric output of the measurement microphone built into the artificial ear, or in terms of the level correction between the acoustic pressure measured by the built-in microphone and the pressure at the ERP. The latter approach is preferable as it allows for an easier routine check of the artificial ear's calibration.

7 Idle noise floor

Certain measurement applications require a low self-noise of the acoustic test equipment, including the ear simulators.

For this purpose and in addition to the layout, design and acoustic properties of all artificial ears described in clause 6, an optional low noise requirement can be defined based on the lower threshold of hearing as defined in [ISO 389-7] and shown in Figure 20.

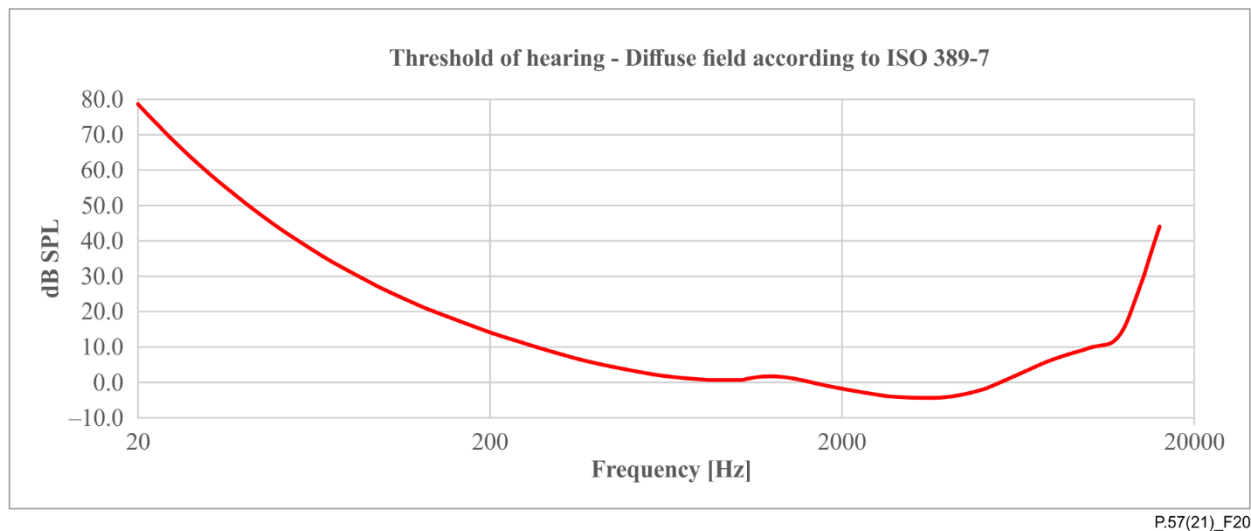

Figure 20 – Hearing threshold according to [ISO 389-7]

Requirements

The idle noise level in each frequency band shall be below the hearing threshold under diffuse-field conditions as defined from 20 Hz to 16 kHz in Table 1 of [ISO 389-7].

In case individual test specifications do not require noise-sensitive measurements for frequencies higher than 10 kHz, ears simulators used may deviate from the above requirements in the frequency range above 10 kHz.

For binaural applications, left and right ear simulator shall meet this requirement.

Test method

- 1) The artificial ear under test is placed in an acoustically treated measurement chamber, either stand-alone or mounted on a HATS.
- 2) The idle noise is analysed over at a time period of at least 10 s with appropriate measurement equipment.
- 3) Diffuse-field correction according to Table 3 of [ITU-T P.58] shall be applied to the analysis in 1/3rd octave bands (row B) according to [IEC 61260-1].
- 4) The requirement and the measured idle noise versus bands is evaluated for each frequency according to the frequency range required by the individual test specification, but at least up to 10 kHz.

Annex A

A practical procedure for determination of the acoustic input impedance of artificial ears

(This annex forms an integral part of this Recommendation.)

A.1 Introduction

The procedure described in this annex allows accurate and traceable calibration of the acoustic input impedance of artificial ears type 1 and type 3.2 as required in clause 6.4.3. Additionally, the calibration set-up allows determination of the closed condition frequency sensitivity response of the artificial ears.

The procedure relies on the availability of a laboratory-standard 1/2" pressure microphone (IEC LS2P) calibrated with respect to its frequency sensitivity response, and a calibrated reference volume.

The set-up required to perform the measurements is shown in Figure A.1. It is based upon an audio frequency response analyser and an impedance probe consisting of a 1/2" working-standard pressure microphone (IEC WS2P) used as transmitter, and a probe microphone used as receiver (see Figure 10).

The reference microphone and the reference volume are used to determine the relative frequency sensitivity responses of the transmitter and probe microphones in the impedance probe prior to the calibration of the artificial ear itself. For this purpose, the reference microphone is mounted in a calibration unit, positioned as closely as possible to the probe tip integrated in the impedance probe.

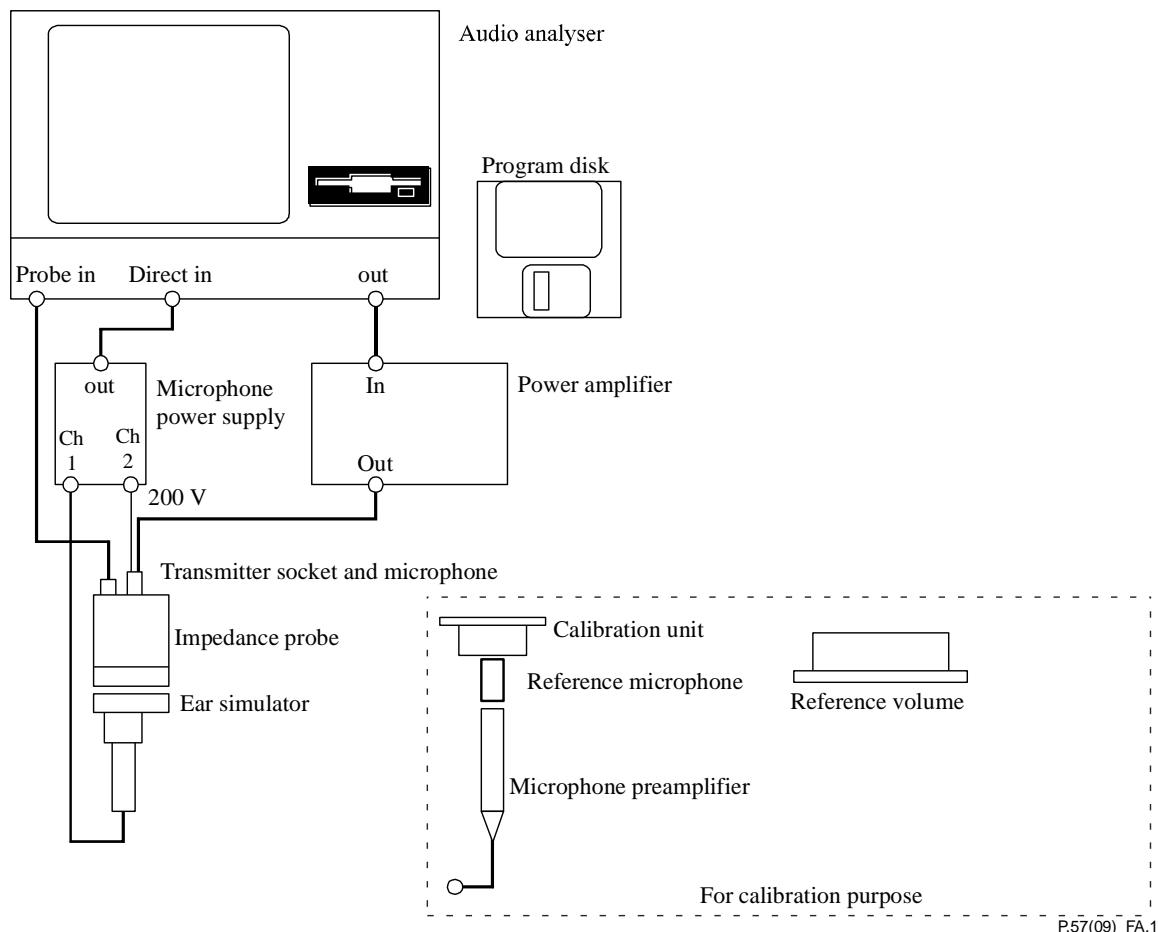

P.57(09)_FA.1

Figure A.1 – Measurement set-up

A.2 Calibration of the impedance probe

A.2.1 Frequency response of the probe microphone

The reference microphone (Figure A.1) is mounted in the calibration unit and the calibration unit is placed in a suitable test bench. The impedance probe is attached to the calibration unit and the reference microphone is now used to calibrate the probe microphone. This is done by measuring the frequency response of the probe microphone relative to the frequency response of the reference microphone. The signal is delivered by the transmitter microphone of the impedance probe. The absolute frequency response of the probe microphone in [V/Pa] is then obtained as follows:

$$H_{\text{Prb.Abs}}(f) = \left[\frac{V_{\text{O,Prb}}(f)}{V_{\text{O,Ref}}(f)} \right] \cdot H_{\text{RefCal}}(f)$$

where:

- $H_{\text{Prb.Abs}}(f)$: Absolute frequency response of the probe microphone
- $V_{\text{O,Prb}}(f)$: Probe microphone output voltage in calibration unit
- $V_{\text{O,Ref}}(f)$: Reference microphone output voltage in calibration unit
- $H_{\text{RefCal}}(f)$: Absolute calibrated reference microphone response.

A.2.2 Relative frequency response of the transmitter microphone

Apart from a constant factor, the transmitter microphone capsule in the impedance probe has the same frequency sensitivity when used as a volume source as it does during its normal use as a receiver. Hence, the same method and set-up used for the probe microphone calibration is used to calibrate the transmitter microphone of the impedance probe. The only difference is that now the reference microphone delivers the signal, and the calibrated probe microphone is used to calibrate the transmitter microphone which, in this case, is used as a receiver:

$$H_{\text{Tr.Abs.Mic}}(f) = \left[\frac{V_{\text{O,Tr}}(f)}{V_{\text{O,Prb}}(f)} \right] \cdot H_{\text{Prb.Abs}}(f)$$

where:

- $H_{\text{Tr.Abs.Mic}}(f)$: Absolute microphone frequency response of the transmitter microphone
- $V_{\text{O,Prb}}(f)$: Probe microphone output voltage in calibration unit
- $V_{\text{O,Tr}}(f)$: Transmitter microphone output voltage in calibration unit
- $H_{\text{Prb.Abs}}(f)$: Absolute frequency response of the probe microphone (as measured above).

The frequency response of the transmitter microphone, relative to the sensitivity at a reference frequency (f_0), when used as a volume velocity source is then:

$$H_{\text{Tr.Rd.Src}}(f) = \frac{H_{\text{Tr.Abs.Mic}}(f)}{H_{\text{Tr.Abs.Mic}}(f_0)} \cdot (f/f_0)$$

where the term (f/f_0) relates to the fact that the transmit sensitivity is expressed in terms of volume velocity rather than volume.

A.2.3 Absolute sensitivity of the transmitter microphone as a volume velocity source

The additional factor describing the absolute sensitivity of the transmitter microphone, when used as a volume velocity source, remains to be determined. This factor is found by measuring the sound pressure level produced by the transmitter microphone in the reference volume. The reference volume is placed in the test bench and the impedance probe is attached to the reference volume. The nominal

acoustical impedance in [Pa s/m³] equals one divided by the acoustic compliance (C_a) of the reference volume:

$$Z_{a,Ref} \cdot V_{oF} = \frac{1}{j\omega_a} = \frac{\rho c^2}{j\omega V}$$

It is recommended that the reference volume has a size comparable to the volume of the artificial ears. For a known excitation voltage, $V_{i,Tr.Mic}$, the sound pressure, $p_{Pr.Mic}$, is measured at a low frequency (f_0) where the frequency response of the transmitter microphone is frequency independent and the reference volume behaves as an ideal compliance. The absolute sensitivity factor of the transmitter microphone in [m³/Vs] is calculated as follows:

$$S_{Tr.Src} = \frac{p_{Pr.Mic}(f_0)}{[Z_{a,Ref} \cdot V_{oF}(f_0) \cdot V_{i,Tr.Mic}(f_0)]}$$

Thus the absolute sensitivity of the transmitter microphone, when used as a volume velocity source, is:

$$H_{Tr.Abs.Src}(f) = H_{Tr.Rel.Src}(f) \cdot S_{Tr.Src}$$

A.3 Artificial ear calibration

A.3.1 Determination of acoustical impedance

During the measurements, the artificial ear is placed in a suitable test bench (not shown in Figure A.1). Referring to Figure A.1 the impedance probe is attached to the artificial ear. With the transmitter microphone providing the volume velocity $q(f)$, the sound pressure $p_{ERP}(f)$ at the ERP is measured by the probe microphone of the impedance probe:

$$Z_{Ear,ERP}(f) = \frac{p_{ERP}(f)}{q(f)} = \frac{\left[\frac{V_{O,PrbMic}(f)}{H_{Prb.Abs}(f)} \right]}{\left[\frac{V_{i,Tr.Src}(f)}{H_{Tr.Abs.Src}(f)} \right]}$$

where:

$V_{i,Tr.Src}(f)$: Input voltage to the transmitter microphone used as a volume velocity source

$V_{O,PrbMic}(f)$: Output voltage of the probe microphone.

A.3.2 Determination of closed condition sound pressure sensitivity

The same set-up is used as for the determination of acoustic input impedance, but the output voltage of the artificial ear relative to the sound pressure at the ERP is measured:

$$H_{Ear,Closed Cond.}(f) = \frac{V_{O,Ear}(f)}{\left[\frac{V_{O,PrbMic}(f)}{H_{Prb.Abs}(f)} \right]}$$

Annex B

Cross sectional areas of type 4.3 artificial ear

(This annex forms an integral part of this Recommendation.)

B.1 Cross sections of the concha bottom

As illustrated in Figure 10, two cross section planes have been evenly distributed, between the 28 mm plane and the last plane of the concha bottom. These planes have been determined using the algorithm outlined below.

First, the green plane at 28 mm and the last plane are characterized by a point and a normal vector as summarized in Table B.1.

Table B.1 – The points and normal vectors describing the 28 mm plane and the last plane of the ear canal

Plane	Description	x [mm]	y [mm]	z [mm]
28 mm plane	Point in plane, $\mathbf{r}_{\text{First}}$	101.89	63.51	44.96
	Normal vector of plane, $\hat{\mathbf{n}}_{\text{First}}$	-0.088	0.939	-0.333
Last plane of the concha bottom	Point in plane, \mathbf{r}_{Last}	101.77	67.44	44.11
	Normal vector of plane, $\hat{\mathbf{n}}_{\text{Last}}$	-0.032	0.977	0.210

To find the shortest distance from $\mathbf{r}_{\text{First}}$ to the last plane the equation for a plane is used:

$$\hat{\mathbf{n}} \cdot (\mathbf{r} - \mathbf{r}_0) = 0,$$

where $\hat{\mathbf{n}}$ is the normal unit vector of the plane, \mathbf{r}_0 is a point in the plane and \mathbf{r} is the set of all points fulfilling the equation. The shortest distance between the centre line point at 28 mm to the last plane of the ear canal is then given by:

$$D_{\text{First-Last}} = \frac{|\hat{\mathbf{n}}_{\text{Last}} \cdot \mathbf{r}_{\text{First}} - \hat{\mathbf{n}}_{\text{Last}} \cdot \mathbf{r}_{\text{Last}}|}{|\hat{\mathbf{n}}_{\text{Last}}|}$$

The point in the last plane closest to the 28 mm centre line point is thus given by:

$$\mathbf{r}_{\text{Last}} = \mathbf{r}_{\text{First}} + \hat{\mathbf{n}}_{\text{Last}} D_{\text{First-Last}}$$

The point \mathbf{r}_{Last} given in Table B.1 is the point in the last plane closest to the 28 mm centre line point. In order to find planes in-between the two planes in Table B.1, a point in each plane is first determined. This is done by evenly distributing points on the straight line between $\mathbf{r}_{\text{First}}$ and \mathbf{r}_{Last} in the following way:

$$\mathbf{r}_i = \mathbf{r}_{\text{First}} + (\mathbf{r}_{\text{Last}} - \mathbf{r}_{\text{First}}) \frac{i}{N_{\text{planes}}+1}$$

where N_{planes} is the number of planes added between the two planes and $i = 1..N_{\text{planes}}$. A similar approach is used in order to determine the normal vectors of the planes between the two planes:

$$\mathbf{n}_i = \mathbf{n}_{\text{First}} + (\mathbf{n}_{\text{Last}} - \mathbf{n}_{\text{First}}) \frac{i}{N_{\text{planes}}+1}$$

In this way the orientations of the interpolated planes are linearly dependent on the orientation of the 28 mm centre line plane and the last plane of the ear canal.

The points in the planes found using this algorithm are not the points used as origin in the 2D plots of Figure 12 for the three yellow planes. For those planes EEP have been projected into the planes and the projected EEP points are then used as the origin in Figure 12.

The projected EEP points are found in the following way. First the perpendicular signed distance between EEP and the plane is found:

$$D_{\text{EEP-Plane}} = \frac{\hat{\mathbf{n}}_{\text{Plane}} \cdot \mathbf{r}_{\text{EEP}} - \hat{\mathbf{n}}_{\text{Plane}} \cdot \mathbf{r}_{\text{Plane}}}{|\hat{\mathbf{n}}_{\text{Plane}}|}$$

where $\hat{\mathbf{n}}_{\text{Plane}}$ is the normal vector of the plane, \mathbf{r}_{EEP} is the EEP point (104,66,42) and $\mathbf{r}_{\text{Plane}}$ is any point in the plane. The projection of the EEP point on to the plane is then simply given as:

$$\text{EEP Projection} = \mathbf{r}_{\text{EEP}} - \hat{\mathbf{n}}_{\text{Plane}} D_{\text{EEP-Plane}}$$

B.2 Cross sectional areas of the ear canal and concha bottom

The cross sectional areas of the ear canal and the concha bottom as described in clauses 6.4.3.4.2, 6.4.3.4.3 and 6.4.3.4.4 and illustrated in Figure 10 in the plane of the two unit vectors $\hat{\mathbf{b}}_e, \hat{\mathbf{a}}_e$ as illustrated in Figure 11 are listed in Table B.2. The cross sections along the centre line (the green planes) are given with 25 points on the periphery in each, corresponding to a spacing better than or equal to 1.1 mm. The cross sections of the concha bottom (the yellow planes) are larger and given with a spacing of 1 mm between the points. These tables are the basis for the plots shown in Figure 12.

Table B.2 – Tabular values for the cross sectional areas of the ear canal and concha bottom

Cross section 0.5 mm		Cross section 2 mm		Cross section 4 mm	
$\hat{\mathbf{a}}_e$	$\hat{\mathbf{b}}_e$	$\hat{\mathbf{a}}_e$	$\hat{\mathbf{b}}_e$	$\hat{\mathbf{a}}_e$	$\hat{\mathbf{b}}_e$
-0.76	-0.89	-1.72	-0.37	1.74	-1.04
-0.82	-0.55	-1.89	-0.91	2.27	-0.54
-0.80	-0.20	-1.91	-1.47	2.57	0.13
-0.70	0.13	-1.73	-2.00	2.69	0.85
-0.54	0.43	-1.30	-2.36	2.74	1.58
-0.33	0.71	-0.76	-2.36	2.85	2.30
-0.11	0.98	-0.30	-2.04	2.82	3.02
0.13	1.22	0.09	-1.62	2.32	3.47
0.40	1.44	0.48	-1.22	1.61	3.37
0.69	1.63	0.89	-0.83	0.97	3.03
1.00	1.78	1.30	-0.44	0.36	2.63
1.34	1.83	1.66	0.00	-0.22	2.18
1.67	1.77	1.94	0.49	-0.78	1.71
1.76	1.44	2.16	1.01	-1.31	1.20
1.70	1.10	2.33	1.55	-1.81	0.67
1.58	0.77	2.40	2.10	-2.21	0.06
1.41	0.47	2.11	2.58	-2.46	-0.63
1.22	0.19	1.55	2.61	-2.51	-1.36
1.01	-0.09	1.03	2.41	-2.38	-2.07
0.78	-0.35	0.55	2.10	-2.00	-2.69
0.56	-0.62	0.11	1.75	-1.35	-2.93
0.33	-0.87	-0.33	1.39	-0.70	-2.62
0.06	-1.10	-0.74	1.00	-0.15	-2.14
-0.25	-1.24	-1.13	0.59	0.45	-1.73

Cross section 0.5 mm	
\hat{a}_e	\hat{b}_e
-0.57	-1.17

Cross section 2 mm	
\hat{a}_e	\hat{b}_e
-1.46	0.13

Cross section 4 mm	
\hat{a}_e	\hat{b}_e
1.11	-1.40

Cross section 6 mm	
\hat{a}_e	\hat{b}_e
2.32	0.28
2.61	1.01
2.94	1.72
3.30	2.43
3.26	3.18
2.67	3.64
1.89	3.64
1.15	3.39
0.47	3.00
-0.14	2.51
-0.72	1.98
-1.29	1.44
-1.82	0.87
-2.29	0.24
-2.62	-0.47
-2.68	-1.25
-2.50	-2.00
-2.08	-2.67
-1.47	-3.14
-0.70	-3.19
-0.03	-2.80
0.55	-2.27
1.10	-1.71
1.60	-1.10
2.00	-0.43

Cross section 8 mm	
\hat{a}_e	\hat{b}_e
3.18	0.71
3.54	1.44
3.70	2.24
3.42	2.99
2.77	3.48
1.99	3.70
1.18	3.65
0.42	3.36
-0.28	2.91
-0.89	2.39
-1.51	1.84
-2.09	1.27
-2.63	0.66
-3.04	-0.05
-3.19	-0.84
-2.91	-1.60
-2.35	-2.20
-1.66	-2.62
-0.89	-2.89
-0.08	-2.85
0.64	-2.47
1.26	-1.93
1.81	-1.32
2.31	-0.68
2.76	0.01

Cross section 10 mm	
\hat{a}_e	\hat{b}_e
-2.21	1.45
-1.57	2.03
-0.91	2.57
-0.19	3.04
0.61	3.33
1.47	3.39
2.29	3.17
3.03	2.73
3.63	2.12
3.99	1.35
4.03	0.50
3.75	-0.30
3.23	-0.98
2.57	-1.52
1.83	-1.97
1.05	-2.34
0.24	-2.61
-0.61	-2.75
-1.46	-2.75
-2.30	-2.55
-3.06	-2.15
-3.57	-1.48
-3.65	-0.64
-3.33	0.15
-2.81	0.84

Cross section 12 mm		Cross section 14 mm		Cross section 16 mm	
\hat{a}_e	\hat{b}_e	\hat{a}_e	\hat{b}_e	\hat{a}_e	\hat{b}_e
3.82	-1.19	-1.38	2.79	-2.33	2.36
4.19	-0.37	-2.17	2.31	-3.12	1.83
4.28	0.54	-2.88	1.72	-3.83	1.19
4.04	1.40	-3.53	1.05	-4.43	0.45
3.48	2.10	-4.04	0.28	-4.80	-0.42
2.74	2.62	-4.35	-0.59	-4.74	-1.35
1.91	3.00	-4.26	-1.50	-4.19	-2.11
1.02	3.18	-3.75	-2.26	-3.38	-2.62
0.12	3.14	-2.96	-2.75	-2.49	-2.96
-0.74	2.88	-2.08	-3.05	-1.57	-3.18
-1.52	2.43	-1.16	-3.18	-0.62	-3.26
-2.24	1.86	-0.24	-3.17	0.33	-3.17
-2.89	1.23	0.68	-3.05	1.25	-2.92
-3.47	0.53	1.58	-2.82	2.11	-2.50
-3.89	-0.27	2.43	-2.44	2.83	-1.90
-3.98	-1.16	3.16	-1.86	3.38	-1.13
-3.60	-1.97	3.68	-1.09	3.72	-0.24
-2.88	-2.51	3.96	-0.20	3.75	0.71
-2.03	-2.82	3.94	0.73	3.49	1.62
-1.13	-2.93	3.61	1.60	2.94	2.39
-0.22	-2.92	2.99	2.29	2.18	2.96
0.68	-2.82	2.22	2.82	1.29	3.26
1.57	-2.62	1.35	3.14	0.33	3.30
2.42	-2.31	0.42	3.23	-0.60	3.13
3.19	-1.84	-0.50	3.10	-1.49	2.80

Cross section Ref. Plane		Cross section 18 mm		Cross section 20 mm	
\hat{a}_e	\hat{b}_e	\hat{a}_e	\hat{b}_e	\hat{a}_e	\hat{b}_e
2.94	-1.27	-1.83	2.63	-0.30	-3.24
2.37	-2.02	-2.70	2.24	0.64	-3.00
1.65	-2.62	-3.52	1.75	1.52	-2.57
0.82	-3.07	-4.25	1.14	2.31	-2.00
-0.09	-3.31	-4.85	0.39	2.95	-1.26
-1.03	-3.34	-5.19	-0.49	3.39	-0.39
-1.96	-3.21	-4.99	-1.40	3.52	0.57
-2.86	-2.91	-4.38	-2.14	3.26	1.50
-3.70	-2.50	-3.60	-2.68	2.64	2.26
-4.44	-1.92	-2.73	-3.08	1.80	2.74
-4.93	-1.12	-1.81	-3.32	0.84	2.94
-4.90	-0.20	-0.86	-3.37	-0.13	2.98
-4.47	0.64	0.09	-3.25	-1.11	2.88
-3.84	1.34	0.99	-2.95	-2.06	2.67
-3.10	1.92	1.81	-2.46	-2.98	2.34
-2.29	2.40	2.50	-1.81	-3.84	1.89
-1.42	2.77	3.07	-1.04	-4.62	1.29
-0.53	3.06	3.44	-0.17	-5.25	0.55
0.40	3.21	3.55	0.78	-5.61	-0.35
1.34	3.14	3.29	1.69	-5.48	-1.31
2.22	2.83	2.71	2.44	-4.90	-2.09
2.95	2.24	1.89	2.92	-4.10	-2.65
3.41	1.42	0.97	3.14	-3.21	-3.04
3.53	0.50	0.02	3.10	-2.26	-3.25
3.35	-0.43	-0.92	2.92	-1.28	-3.32

Cross section 22 mm		Cross section 24 mm		Cross section 26 mm	
\hat{a}_e	\hat{b}_e	\hat{a}_e	\hat{b}_e	\hat{a}_e	\hat{b}_e
-0.43	-3.00	-4.35	2.12	3.56	0.84
0.53	-2.91	-5.11	1.50	2.99	1.69
1.45	-2.64	-5.54	0.64	2.24	2.41
2.30	-2.18	-5.45	-0.32	1.38	2.96
3.01	-1.54	-4.89	-1.12	0.41	3.28
3.49	-0.71	-4.15	-1.76	-0.61	3.39
3.61	0.24	-3.30	-2.25	-1.64	3.33
3.34	1.16	-2.38	-2.61	-2.65	3.12
2.76	1.93	-1.44	-2.87	-3.60	2.75
1.98	2.48	-0.47	-3.01	-4.47	2.22
1.07	2.81	0.51	-3.01	-5.18	1.47
0.12	2.96	1.47	-2.82	-5.57	0.53
-0.84	2.96	2.37	-2.43	-5.51	-0.48
-1.80	2.84	3.15	-1.85	-5.01	-1.38
-2.74	2.62	3.68	-1.03	-4.24	-2.06
-3.64	2.28	3.79	-0.06	-3.34	-2.56
-4.47	1.79	3.50	0.87	-2.39	-2.94
-5.18	1.15	2.95	1.67	-1.40	-3.20
-5.58	0.28	2.22	2.32	-0.38	-3.33
-5.44	-0.66	1.34	2.77	0.65	-3.31
-4.87	-1.42	0.39	3.00	1.65	-3.08
-4.11	-2.02	-0.59	3.07	2.56	-2.62
-3.26	-2.46	-1.57	3.01	3.37	-1.98
-2.34	-2.76	-2.53	2.84	3.92	-1.13
-1.39	-2.93	-3.47	2.55	3.93	-0.11

Cross section 28 mm	
\hat{a}_e	\hat{b}_e
-5.51	2.16
-4.71	2.92
-3.70	3.36
-2.62	3.58
-1.52	3.67
-0.42	3.59
0.66	3.34
1.67	2.90
2.59	2.29
3.39	1.53
4.00	0.61
4.13	-0.47
3.69	-1.47
2.92	-2.26
2.00	-2.86
0.95	-3.22
-0.14	-3.38
-1.24	-3.38
-2.34	-3.25
-3.41	-2.97
-4.43	-2.54
-5.32	-1.89
-5.94	-0.99
-6.18	0.08
-6.01	1.18

Cross section 29.5 mm	
\hat{a}_e	\hat{b}_e
6.33	1.54
6.14	2.51
5.58	3.34
4.86	4.02
4.04	4.60
3.16	5.07
2.21	5.39
1.23	5.54
0.23	5.58
-0.77	5.55
-1.77	5.45
-2.74	5.23
-3.65	4.82
-4.39	4.16
-4.90	3.31
-5.13	2.34
-4.97	1.36
-4.49	0.49
-3.79	-0.23
-3.00	-0.83
-2.13	-1.33
-1.20	-1.70
-0.24	-1.95
0.76	-2.05
1.76	-2.00
2.75	-1.86
3.71	-1.62
4.61	-1.17
5.36	-0.52
5.94	0.29
6.30	1.22

Cross section 31 mm	
\hat{a}_e	\hat{b}_e
6.57	1.62
6.20	2.54
5.57	3.32
4.82	3.97
3.97	4.51
3.07	4.93
2.11	5.20
1.12	5.34
0.12	5.39
-0.88	5.39
-1.88	5.36
-2.88	5.28
-3.85	5.06
-4.76	4.65
-5.47	3.99
-5.96	3.13
-6.09	2.15
-5.94	1.16
-5.57	0.23
-5.06	-0.62
-4.47	-1.44
-3.88	-2.24
-3.29	-3.05
-2.72	-3.87
-2.09	-4.64
-1.31	-5.26
-0.35	-5.49
0.63	-5.34
1.47	-4.81
2.29	-4.23
3.10	-3.65
3.92	-3.07
4.72	-2.47
5.43	-1.77
6.02	-0.97
6.44	-0.06
6.60	0.92

Cross section 32.5 mm	
\hat{a}_e	\hat{b}_e
-6.38	3.86
-6.82	2.97
-7.00	1.99
-6.94	0.99
-6.78	0.00
-6.58	-0.98
-6.37	-1.95
-6.16	-2.93
-5.99	-3.92
-5.83	-4.91
-5.67	-5.89
-5.37	-6.84
-4.92	-7.74
-4.30	-8.52
-3.54	-9.16
-2.64	-9.60
-1.66	-9.78
-0.66	-9.73
0.29	-9.43
1.16	-8.93
1.91	-8.28
2.57	-7.53
3.14	-6.71
3.63	-5.84
4.14	-4.98
4.71	-4.15
5.29	-3.34
5.89	-2.54
6.40	-1.68
6.75	-0.74
6.86	0.25
6.73	1.24
6.31	2.14
5.70	2.93
4.94	3.59
4.09	4.10
3.17	4.49
2.20	4.74
1.21	4.87
0.21	4.92
-0.79	4.96
-1.79	5.00
-2.79	5.04
-3.79	5.02
-4.77	4.84
-5.70	4.48

B.3 Cross sectional areas of the pinna simulator

The cross sectional areas of the pinna simulator as described in clauses 6.4.3.4.2 to 6.4.3.4.8 and illustrated in Figure 14 in the plane of the two unit vectors \hat{b}_e, \hat{a}_e as defined in clause 6.4.3.4.3 are listed in Table B.3. The cross sections are given with a spacing on the periphery of 1mm between the points. These tables are the basis for the plots shown in Figure 14.

The distance from each cross-section plane to the chin of HATS is given in the heading of each table. For some distances there are multiple tables associated. In that case the table denoted pinna plane X mm – 1 contains the points for the outer edge of the plane, whereas the tables denoted pinna plane X mm – 2 and pinna plane X mm – 3 contains the points for the non-solid areas within the outer edge (white areas in Figure 14). The exception is the first table for the -1 mm plane, where there is no solid area – thus the area within the points is air and is coloured white in Figure 14.

Table B.3 – Tabular values for the cross sectional areas of the pinna simulator

Pinna plane – 1 mm			
\hat{a}_e	\hat{b}_e	\hat{a}_e	\hat{b}_e
6.52	1.61	-6.93	-5.27
6.80	0.66	-7.01	-4.28
6.78	-0.34	-6.99	-3.28
6.53	-1.31	-7.20	-2.31
6.10	-2.21	-7.32	-1.31
5.55	-3.04	-7.41	-0.32
4.98	-3.86	-7.49	0.68
4.46	-4.72	-7.48	1.68
3.97	-5.59	-7.29	2.65
3.52	-6.48	-6.90	3.57
3.02	-7.35	-6.18	4.23
2.43	-8.15	-5.23	4.54
1.75	-8.89	-4.24	4.70
0.97	-9.51	-3.24	4.73
0.10	-10.00	-2.24	4.72
-0.84	-10.33	-1.24	4.65
-1.83	-10.44	-0.24	4.64
-2.82	-10.34	0.76	4.61
-3.78	-10.05	1.75	4.56
-4.64	-9.55	2.74	4.41
-5.38	-8.87	3.70	4.13
-6.00	-8.10	4.60	3.69
-6.46	-7.21	5.39	3.08
-6.78	-6.26	6.07	2.36

Pinna plane 0 mm – 1									
\hat{a}_e	\hat{b}_e	\hat{a}_e	\hat{b}_e	\hat{a}_e	\hat{b}_e	\hat{a}_e	\hat{b}_e	\hat{a}_e	\hat{b}_e
-5.31	24.05	26.68	14.15	23.81	-16.97	-9.28	-23.11	-29.07	2.33
-4.32	24.22	27.33	13.38	23.03	-17.59	-10.23	-22.80	-28.93	3.32
-3.33	24.36	27.93	12.59	22.23	-18.19	-11.17	-22.46	-28.72	4.30
-2.34	24.48	28.48	11.75	21.41	-18.76	-12.10	-22.09	-28.49	5.27
-1.35	24.61	29.02	10.91	20.57	-19.30	-13.02	-21.70	-28.19	6.22
-0.36	24.74	29.52	10.05	19.71	-19.81	-13.93	-21.29	-27.85	7.16
0.64	24.81	29.99	9.16	18.83	-20.28	-14.83	-20.85	-27.47	8.09
1.64	24.80	30.41	8.25	17.94	-20.74	-15.72	-20.38	-27.05	9.00
2.64	24.78	30.79	7.33	17.04	-21.19	-16.59	-19.89	-26.60	9.89
3.64	24.77	31.16	6.40	16.14	-21.61	-17.44	-19.37	-26.11	10.76
4.63	24.65	31.44	5.44	15.22	-22.00	-18.28	-18.83	-25.58	11.61
5.62	24.49	31.66	4.47	14.29	-22.37	-19.10	-18.25	-25.04	12.45
6.60	24.33	31.85	3.48	13.35	-22.71	-19.91	-17.67	-24.45	13.25
7.59	24.17	32.00	2.50	12.39	-23.01	-20.73	-17.09	-23.81	14.03
8.58	24.02	32.09	1.50	11.43	-23.30	-21.47	-16.42	-23.12	14.75
9.56	23.85	32.12	0.50	10.47	-23.55	-22.21	-15.75	-22.42	15.46
10.53	23.61	32.11	-0.50	9.49	-23.78	-22.89	-15.02	-21.70	16.16
11.50	23.36	32.06	-1.50	8.52	-23.99	-23.52	-14.25	-20.95	16.82
12.45	23.05	31.95	-2.49	7.53	-24.17	-24.16	-13.48	-20.19	17.47
13.40	22.73	31.79	-3.48	6.54	-24.32	-24.78	-12.69	-19.40	18.07
14.35	22.42	31.59	-4.46	5.55	-24.44	-25.35	-11.87	-18.59	18.66
15.29	22.07	31.35	-5.43	4.56	-24.54	-25.90	-11.04	-17.77	19.23
16.21	21.69	31.07	-6.39	3.56	-24.62	-26.40	-10.17	-16.92	19.76
17.11	21.24	30.74	-7.33	2.56	-24.66	-26.87	-9.29	-16.04	20.24
18.00	20.79	30.37	-8.26	1.56	-24.69	-27.29	-8.38	-15.17	20.73
18.88	20.33	29.95	-9.17	0.56	-24.67	-27.69	-7.46	-14.27	21.17
19.75	19.83	29.50	-10.06	-0.44	-24.63	-28.04	-6.52	-13.36	21.58
20.60	19.30	29.00	-10.93	-1.43	-24.56	-28.36	-5.58	-12.44	21.97
21.43	18.75	28.48	-11.78	-2.43	-24.48	-28.62	-4.61	-11.51	22.34
22.26	18.19	27.90	-12.59	-3.43	-24.37	-28.86	-3.64	-10.57	22.68
23.06	17.58	27.29	-13.39	-4.42	-24.23	-29.03	-2.66	-9.63	23.03
23.83	16.94	26.65	-14.16	-5.40	-24.07	-29.13	-1.66	-8.67	23.31
24.56	16.27	25.98	-14.90	-6.38	-23.88	-29.20	-0.66	-7.71	23.58
25.29	15.59	25.29	-15.62	-7.36	-23.65	-29.20	0.34	-6.73	23.79
25.99	14.87	24.56	-16.30	-8.32	-23.39	-29.17	1.33	-5.75	23.97

Pinna plane 0 mm – 2			
\hat{a}_e	\hat{b}_e	\hat{a}_e	\hat{b}_e
4.69	-6.07	-7.34	2.40
4.21	-6.94	-6.91	3.30
3.68	-7.79	-6.19	3.98
3.07	-8.59	-5.22	4.20
2.41	-9.34	-4.23	4.37
1.69	-10.03	-3.24	4.43
0.90	-10.64	-2.24	4.42
0.03	-11.12	-1.24	4.36
-0.94	-11.36	-0.24	4.33
-1.94	-11.44	0.76	4.29
-2.93	-11.37	1.76	4.24
-3.90	-11.13	2.75	4.10
-4.79	-10.69	3.70	3.81
-5.53	-10.02	4.59	3.36
-6.15	-9.23	5.38	2.75
-6.69	-8.39	6.06	2.02
-7.09	-7.48	6.65	1.21
-7.37	-6.52	7.12	0.34
-7.52	-5.53	7.18	-0.66
-7.58	-4.53	6.95	-1.62
-7.53	-3.54	6.60	-2.55
-7.66	-2.55	6.14	-3.44
-7.72	-1.55	5.65	-4.31
-7.72	-0.55	5.17	-5.19
-7.72	0.45	4.70	-6.07
-7.62	1.44		

Pinna plane 0 mm – 3	
\hat{a}_e	\hat{b}_e
11.47	-9.80
10.80	-10.54
9.97	-11.09
9.02	-11.36
8.61	-10.62
9.07	-9.73
9.74	-9.00
10.55	-8.41
11.44	-7.97
12.12	-8.37
11.78	-9.31

Pinna plane 1 mm – 1							
\hat{a}_e	\hat{b}_e	\hat{a}_e	\hat{b}_e	\hat{a}_e	\hat{b}_e	\hat{a}_e	\hat{b}_e
11.30	17.11	25.43	-11.38	-8.59	-18.93	-23.27	9.42
12.27	16.89	24.87	-12.21	-9.20	-18.13	-22.59	10.16
13.20	16.56	24.22	-12.97	-9.76	-17.31	-21.88	10.86
14.10	16.12	23.53	-13.69	-10.32	-16.48	-21.18	11.57
14.99	15.70	22.82	-14.39	-10.88	-15.65	-20.42	12.23
15.78	15.16	22.04	-15.01	-11.34	-14.76	-19.64	12.85
16.61	14.62	21.18	-15.53	-11.72	-13.84	-18.88	13.50
17.51	14.20	20.30	-16.00	-12.09	-12.91	-18.08	14.10
18.48	13.95	19.41	-16.45	-12.45	-11.97	-17.23	14.63
19.39	13.54	18.52	-16.91	-12.82	-11.04	-16.42	15.21
20.29	13.11	17.62	-17.35	-13.21	-10.12	-15.51	15.61
21.20	12.70	16.72	-17.79	-13.63	-9.22	-14.58	15.99
22.06	12.19	15.83	-18.24	-14.15	-8.37	-13.66	16.37
22.86	11.59	14.93	-18.68	-14.80	-7.60	-12.69	16.60
23.57	10.89	14.03	-19.11	-15.57	-6.98	-11.70	16.75
24.23	10.14	13.12	-19.53	-16.46	-6.53	-10.70	16.79
24.85	9.36	12.21	-19.94	-17.38	-6.14	-9.72	16.98
25.41	8.53	11.30	-20.35	-18.31	-5.76	-8.75	17.17
25.94	7.68	10.38	-20.75	-19.22	-5.35	-7.76	17.35
26.45	6.82	9.45	-21.11	-20.13	-4.95	-6.80	17.62
26.92	5.94	8.51	-21.45	-21.06	-4.60	-5.82	17.80
27.33	5.03	7.55	-21.75	-22.00	-4.26	-4.84	18.00
27.67	4.09	6.59	-22.00	-22.94	-3.91	-3.88	18.29
27.95	3.13	5.61	-22.20	-23.86	-3.51	-2.90	18.44
28.18	2.16	4.62	-22.35	-24.73	-3.02	-1.90	18.50
28.31	1.16	3.62	-22.42	-25.50	-2.39	-0.92	18.68
28.31	0.16	2.62	-22.44	-26.06	-1.57	0.07	18.81
28.27	-0.83	1.62	-22.42	-26.44	-0.65	1.07	18.79
28.19	-1.83	0.62	-22.34	-26.60	0.34	2.07	18.72
28.05	-2.82	-0.37	-22.21	-26.65	1.34	3.07	18.71
27.88	-3.81	-1.35	-22.05	-26.62	2.34	4.06	18.78
27.68	-4.79	-2.33	-21.82	-26.50	3.33	5.06	18.76
27.46	-5.76	-3.30	-21.57	-26.29	4.31	6.04	18.56
27.22	-6.73	-4.26	-21.31	-25.98	5.26	7.00	18.30
26.95	-7.69	-5.21	-20.99	-25.58	6.17	7.97	18.05
26.65	-8.65	-6.13	-20.60	-25.08	7.04	8.95	17.84
26.30	-9.58	-7.02	-20.14	-24.52	7.87	9.89	17.52
25.90	-10.50	-7.86	-19.60	-23.91	8.66	10.83	17.18

Pinna plane 1 mm – 2			
\hat{a}_e	\hat{b}_e	\hat{a}_e	\hat{b}_e
-7.80	0.73	5.13	-6.89
-7.51	1.69	4.57	-7.72
-7.08	2.59	4.00	-8.54
-6.43	3.34	3.37	-9.32
-5.53	3.71	2.73	-10.08
-4.56	3.97	2.01	-10.77
-3.57	4.11	1.23	-11.40
-2.58	4.13	0.37	-11.90
-1.58	4.11	-0.58	-12.20
-0.58	4.04	-1.57	-12.35
0.42	4.01	-2.57	-12.35
1.42	3.96	-3.56	-12.23
2.41	3.84	-4.51	-11.94
3.37	3.58	-5.37	-11.44
4.28	3.16	-6.08	-10.73
5.09	2.58	-6.63	-9.90
5.82	1.90	-7.11	-9.03
6.52	1.18	-7.48	-8.10
7.19	0.44	-7.74	-7.13
7.53	-0.49	-7.91	-6.15
7.60	-1.49	-8.00	-5.15
7.38	-2.46	-8.00	-4.15
7.10	-3.42	-8.03	-3.15
6.69	-4.33	-8.05	-2.16
6.21	-5.21	-7.99	-1.16
5.68	-6.05	-7.93	-0.16

Pinna plane 1 mm – 3	
\hat{a}_e	\hat{b}_e
12.01	-10.34
11.36	-11.10
10.62	-11.76
9.83	-12.39
9.00	-12.94
8.05	-13.20
7.10	-12.94
6.59	-12.12
6.72	-11.13
7.15	-10.24
7.80	-9.49
8.53	-8.80
9.30	-8.16
10.11	-7.58
10.96	-7.06
11.86	-6.61
12.81	-6.31
13.79	-6.33
14.11	-7.15
13.68	-8.05
13.15	-8.90
12.53	-9.68

Pinna plane 2 mm – 1							
\hat{a}_e	\hat{b}_e	\hat{a}_e	\hat{b}_e	\hat{a}_e	\hat{b}_e	\hat{a}_e	\hat{b}_e
-12.73	-9.98	16.71	-17.08	18.01	9.97	-17.36	11.00
-12.41	-10.92	17.61	-16.63	17.05	10.24	-18.24	10.53
-12.13	-11.88	18.50	-16.19	16.08	10.50	-19.14	10.09
-11.83	-12.84	19.40	-15.75	15.11	10.75	-20.04	9.66
-11.51	-13.79	20.30	-15.32	14.16	11.06	-20.94	9.23
-11.13	-14.71	21.19	-14.87	13.23	11.43	-21.85	8.80
-10.67	-15.60	22.05	-14.35	12.34	11.82	-22.71	8.29
-10.14	-16.44	22.84	-13.74	11.44	12.25	-23.53	7.72
-9.56	-17.26	23.58	-13.07	10.50	12.60	-24.26	7.04
-8.93	-18.04	24.29	-12.36	9.58	12.83	-24.89	6.26
-8.26	-18.78	24.93	-11.59	8.66	13.21	-25.45	5.44
-7.51	-19.44	25.47	-10.75	7.72	13.56	-25.86	4.53
-6.65	-19.95	25.93	-9.86	6.76	13.82	-26.15	3.57
-5.79	-20.46	26.33	-8.95	5.82	14.16	-26.30	2.58
-4.89	-20.91	26.70	-8.02	4.86	14.45	-26.26	1.58
-3.98	-21.30	27.01	-7.07	3.87	14.56	-26.06	0.61
-3.03	-21.63	27.28	-6.11	2.87	14.55	-25.76	-0.35
-2.07	-21.91	27.49	-5.13	1.88	14.63	-25.33	-1.25
-1.10	-22.15	27.63	-4.14	0.89	14.78	-24.79	-2.09
-0.12	-22.33	27.71	-3.14	-0.11	14.82	-24.10	-2.81
0.87	-22.44	27.73	-2.14	-1.10	14.72	-23.31	-3.42
1.87	-22.50	27.72	-1.14	-2.10	14.71	-22.45	-3.93
2.87	-22.49	27.69	-0.14	-3.10	14.67	-21.54	-4.35
3.87	-22.44	27.58	0.85	-4.07	14.48	-20.61	-4.71
4.86	-22.31	27.37	1.83	-5.06	14.35	-19.67	-5.04
5.84	-22.11	27.04	2.77	-6.05	14.24	-18.72	-5.36
6.80	-21.83	26.66	3.70	-7.04	14.05	-17.76	-5.64
7.74	-21.48	26.17	4.56	-8.03	13.95	-16.80	-5.92
8.66	-21.11	25.59	5.38	-9.01	13.78	-15.86	-6.25
9.58	-20.70	24.92	6.12	-10.00	13.76	-14.98	-6.73
10.47	-20.25	24.19	6.80	-11.00	13.72	-14.21	-7.36
11.36	-19.79	23.39	7.41	-11.99	13.56	-13.56	-8.12
12.25	-19.34	22.56	7.96	-12.93	13.23	-13.10	-9.01
13.14	-18.88	21.71	8.49	-13.87	12.90	-12.74	-9.94
14.03	-18.42	20.83	8.96	-14.78	12.51		
14.92	-17.97	19.91	9.35	-15.63	12.00		
15.82	-17.52	18.97	9.68	-16.50	11.52		

Pinna plane 2 mm – 2			
\hat{a}_e	\hat{b}_e	\hat{a}_e	\hat{b}_e
6.14	-6.89	-4.65	-13.00
5.63	-7.75	-5.54	-12.55
5.32	-8.70	-6.30	-11.91
5.00	-9.64	-6.90	-11.11
5.73	-9.47	-7.36	-10.22
6.54	-8.89	-7.73	-9.30
7.42	-8.41	-7.98	-8.33
8.28	-7.90	-8.16	-7.35
9.15	-7.41	-8.29	-6.35
10.05	-6.97	-8.36	-5.36
10.96	-6.57	-8.37	-4.36
11.89	-6.19	-8.38	-3.36
12.83	-5.85	-8.32	-2.36
13.80	-5.63	-8.22	-1.36
14.80	-5.68	-8.09	-0.37
15.22	-6.40	-7.87	0.60
14.60	-7.18	-7.48	1.52
14.00	-7.97	-6.94	2.36
13.44	-8.81	-6.21	3.03
12.87	-9.63	-5.29	3.39
12.27	-10.42	-4.33	3.67
11.61	-11.18	-3.34	3.82
10.93	-11.91	-2.34	3.84
10.20	-12.60	-1.34	3.80
9.44	-13.25	-0.34	3.72
8.61	-13.80	0.65	3.67
7.72	-14.26	1.65	3.58
6.76	-14.50	2.63	3.40
5.76	-14.47	3.57	3.06
4.84	-14.10	4.46	2.61
4.21	-13.35	5.28	2.03
4.01	-12.38	6.08	1.43
3.86	-11.41	6.87	0.82
2.94	-11.64	7.51	0.06
2.08	-12.14	7.93	-0.84
1.19	-12.59	8.09	-1.83
0.27	-12.99	7.97	-2.82
-0.69	-13.26	7.66	-3.77
-1.69	-13.36	7.30	-4.70
-2.68	-13.33	6.86	-5.60
-3.67	-13.20	6.38	-6.47

Pinna plane 3 mm – 1							
\hat{a}_e	\hat{b}_e	\hat{a}_e	\hat{b}_e	\hat{a}_e	\hat{b}_e	\hat{a}_e	\hat{b}_e
-12.63	-9.81	15.20	-17.56	18.47	6.54	-15.38	8.60
-12.30	-10.75	16.08	-17.10	17.47	6.56	-16.31	8.24
-12.03	-11.72	16.97	-16.65	16.47	6.54	-17.30	8.11
-11.77	-12.68	17.87	-16.21	15.47	6.54	-18.30	8.13
-11.51	-13.65	18.77	-15.78	14.49	6.69	-19.30	8.16
-11.19	-14.59	19.68	-15.36	13.54	7.01	-20.30	8.15
-10.80	-15.51	20.59	-14.94	12.65	7.47	-21.30	8.08
-10.34	-16.40	21.49	-14.50	11.81	8.01	-22.28	7.89
-9.81	-17.25	22.35	-13.99	10.97	8.56	-23.22	7.55
-9.23	-18.06	23.16	-13.41	10.13	9.10	-24.09	7.06
-8.56	-18.81	23.95	-12.79	9.26	9.60	-24.84	6.40
-7.82	-19.48	24.67	-12.10	8.38	10.06	-25.46	5.62
-7.03	-20.08	25.32	-11.34	7.47	10.47	-25.99	4.77
-6.17	-20.61	25.85	-10.50	6.53	10.81	-26.37	3.85
-5.29	-21.07	26.32	-9.61	5.58	11.14	-26.62	2.88
-4.38	-21.48	26.73	-8.70	4.63	11.46	-26.74	1.89
-3.44	-21.84	27.11	-7.78	3.66	11.69	-26.65	0.90
-2.49	-22.13	27.43	-6.83	2.68	11.85	-26.35	-0.06
-1.52	-22.38	27.65	-5.86	1.69	12.03	-25.94	-0.97
-0.54	-22.60	27.79	-4.86	0.71	12.21	-25.42	-1.83
0.44	-22.76	27.84	-3.87	-0.28	12.31	-24.80	-2.60
1.44	-22.85	27.82	-2.87	-1.28	12.34	-24.06	-3.27
2.44	-22.88	27.73	-1.87	-2.28	12.41	-23.23	-3.83
3.44	-22.82	27.59	-0.88	-3.27	12.38	-22.34	-4.29
4.43	-22.69	27.38	0.10	-4.27	12.34	-21.42	-4.68
5.41	-22.51	27.08	1.05	-5.27	12.29	-20.49	-5.04
6.37	-22.23	26.70	1.98	-6.26	12.17	-19.53	-5.33
7.30	-21.87	26.23	2.86	-7.26	12.05	-18.56	-5.56
8.22	-21.47	25.66	3.67	-8.24	11.90	-17.59	-5.79
9.11	-21.02	24.96	4.39	-9.24	11.80	-16.62	-6.06
9.98	-20.52	24.18	5.01	-10.21	11.59	-15.69	-6.43
10.84	-20.02	23.31	5.52	-11.15	11.25	-14.82	-6.91
11.70	-19.51	22.39	5.90	-12.04	10.78	-14.03	-7.53
12.57	-19.00	21.44	6.21	-12.87	10.24	-13.38	-8.28
13.43	-18.50	20.46	6.42	-13.69	9.67	-12.89	-9.15
14.31	-18.02	19.47	6.50	-14.52	9.10		

Pinna plane 3 mm – 2			
\hat{a}_e	\hat{b}_e	\hat{a}_e	\hat{b}_e
-0.77	-14.25	8.35	-4.84
-1.77	-14.25	8.63	-5.77
-2.77	-14.17	9.57	-6.01
-3.76	-14.00	10.56	-5.91
-4.72	-13.76	11.54	-5.72
-5.65	-13.40	12.52	-5.53
-6.45	-12.79	13.51	-5.35
-7.05	-11.99	14.50	-5.25
-7.50	-11.10	15.50	-5.29
-7.83	-10.16	16.49	-5.46
-8.07	-9.19	17.48	-5.55
-8.25	-8.21	18.48	-5.65
-8.39	-7.22	19.47	-5.79
-8.46	-6.22	20.44	-6.03
-8.51	-5.22	21.30	-6.52
-8.51	-4.22	21.51	-7.43
-8.48	-3.22	20.80	-8.09
-8.41	-2.22	19.82	-8.24
-8.32	-1.23	18.86	-7.97
-8.15	-0.24	17.99	-7.47
-7.87	0.72	17.13	-6.98
-7.39	1.59	16.18	-6.69
-6.72	2.33	15.20	-6.85
-5.88	2.86	14.35	-7.38
-4.95	3.23	13.71	-8.14
-3.97	3.41	13.18	-8.99
-2.98	3.49	12.67	-9.85
-1.98	3.47	12.11	-10.67
-0.98	3.41	11.48	-11.45
0.01	3.29	10.80	-12.19
1.01	3.19	10.10	-12.90
1.99	3.03	9.35	-13.56
2.96	2.78	8.55	-14.16
3.90	2.43	7.70	-14.69
4.80	2.01	6.81	-15.14
5.72	1.62	5.86	-15.45
6.65	1.23	4.87	-15.56
7.49	0.71	3.88	-15.49
8.19	0.00	2.94	-15.15
8.64	-0.88	2.08	-14.65
8.73	-1.88	1.15	-14.29
8.66	-2.88	0.15	-14.23
8.45	-3.85		

Pinna plane 4 mm – 1							
\hat{a}_e	\hat{b}_e	\hat{a}_e	\hat{b}_e	\hat{a}_e	\hat{b}_e	\hat{a}_e	\hat{b}_e
-10.88	9.44	-16.90	-6.72	10.91	-20.15	22.01	4.08
-11.74	8.93	-15.95	-7.02	11.75	-19.61	21.01	4.12
-12.52	8.31	-15.05	-7.45	12.59	-19.08	20.03	3.95
-13.22	7.59	-14.22	-8.00	13.45	-18.56	19.07	3.67
-13.78	6.77	-13.51	-8.71	14.31	-18.05	18.13	3.33
-14.36	5.96	-12.96	-9.54	15.19	-17.58	17.22	2.92
-15.16	5.36	-12.55	-10.45	16.08	-17.13	16.31	2.50
-16.13	5.19	-12.23	-11.40	16.99	-16.70	15.39	2.11
-17.08	5.50	-11.95	-12.36	17.90	-16.30	14.44	1.79
-17.97	5.95	-11.69	-13.32	18.83	-15.93	13.45	1.66
-18.84	6.44	-11.42	-14.28	19.76	-15.57	12.46	1.77
-19.73	6.90	-11.10	-15.23	20.69	-15.20	11.58	2.22
-20.67	7.24	-10.70	-16.15	21.63	-14.84	10.91	2.95
-21.65	7.39	-10.25	-17.04	22.54	-14.44	10.39	3.81
-22.65	7.39	-9.72	-17.89	23.42	-13.97	9.89	4.68
-23.64	7.23	-9.12	-18.69	24.27	-13.43	9.33	5.50
-24.56	6.85	-8.44	-19.42	25.04	-12.80	8.68	6.26
-25.38	6.28	-7.69	-20.08	25.75	-12.09	7.97	6.97
-26.08	5.57	-6.89	-20.68	26.36	-11.30	7.19	7.59
-26.68	4.77	-6.03	-21.20	26.90	-10.46	6.35	8.13
-27.11	3.87	-5.15	-21.66	27.36	-9.57	5.47	8.62
-27.44	2.92	-4.23	-22.06	27.76	-8.66	4.57	9.05
-27.64	1.94	-3.29	-22.39	28.08	-7.71	3.65	9.44
-27.63	0.95	-2.33	-22.68	28.32	-6.74	2.73	9.82
-27.38	-0.02	-1.36	-22.91	28.48	-5.75	1.77	10.10
-26.97	-0.93	-0.38	-23.11	28.53	-4.76	0.79	10.33
-26.47	-1.79	0.61	-23.25	28.45	-3.76	-0.18	10.55
-25.84	-2.57	1.61	-23.32	28.28	-2.77	-1.17	10.71
-25.11	-3.25	2.61	-23.30	28.05	-1.80	-2.16	10.84
-24.31	-3.85	3.60	-23.22	27.74	-0.85	-3.16	10.91
-23.47	-4.40	4.59	-23.06	27.33	0.06	-4.16	10.94
-22.59	-4.86	5.56	-22.81	26.84	0.93	-5.16	10.93
-21.68	-5.28	6.51	-22.50	26.26	1.75	-6.15	10.84
-20.76	-5.67	7.44	-22.13	25.59	2.48	-7.14	10.70
-19.82	-6.01	8.34	-21.71	24.81	3.11	-8.12	10.50
-18.85	-6.27	9.22	-21.22	23.94	3.59	-9.07	10.20
-17.88	-6.49	10.07	-20.70	22.99	3.90	-10.00	9.83

Pinna plane 4 mm – 2			
\hat{a}_e	\hat{b}_e	\hat{a}_e	\hat{b}_e
14.70	-7.30	-6.21	2.56
13.84	-7.79	-5.24	2.81
13.18	-8.54	-4.25	2.89
12.69	-9.41	-3.25	2.91
12.22	-10.29	-2.25	2.90
11.69	-11.14	-1.25	2.84
11.06	-11.91	-0.25	2.75
10.39	-12.65	0.74	2.66
9.66	-13.34	1.73	2.52
8.90	-13.98	2.71	2.32
8.09	-14.58	3.68	2.07
7.26	-15.13	4.65	1.83
6.41	-15.65	5.64	1.68
5.50	-16.07	6.63	1.60
4.55	-16.37	7.61	1.38
3.56	-16.53	8.52	0.97
2.57	-16.51	9.23	0.28
1.60	-16.26	9.61	-0.63
0.67	-15.88	9.90	-1.59
-0.26	-15.53	10.15	-2.56
-1.23	-15.29	10.51	-3.48
-2.22	-15.13	11.30	-4.08
-3.20	-14.97	12.24	-4.41
-4.18	-14.75	13.22	-4.60
-5.12	-14.42	14.21	-4.76
-6.01	-13.97	15.20	-4.92
-6.75	-13.31	16.18	-5.08
-7.24	-12.44	17.17	-5.21
-7.62	-11.52	18.17	-5.27
-7.89	-10.56	19.17	-5.32
-8.07	-9.57	20.17	-5.42
-8.21	-8.58	21.13	-5.66
-8.32	-7.59	22.03	-6.09
-8.38	-6.59	22.67	-6.84
-8.42	-5.59	22.67	-7.81
-8.44	-4.59	21.97	-8.51
-8.44	-3.59	21.09	-8.98
-8.43	-2.59	20.11	-9.15
-8.40	-1.59	19.13	-8.99
-8.29	-0.60	18.21	-8.61
-8.07	0.38	17.38	-8.05
-7.71	1.30	16.55	-7.50
-7.07	2.07	15.60	-7.20

Pinna plane 5 mm

\hat{a}_e	\hat{b}_e	\hat{a}_e	\hat{b}_e	\hat{a}_e	\hat{b}_e	\hat{a}_e	\hat{b}_e	\hat{a}_e	\hat{b}_e
-13.41	-9.81	22.43	-15.75	22.98	-6.37	-8.15	-6.97	-9.83	8.89
-12.87	-10.65	23.39	-15.47	23.55	-7.18	-8.20	-5.97	-10.72	8.44
-12.49	-11.57	24.30	-15.07	23.49	-8.14	-8.26	-4.98	-11.52	7.84
-12.17	-12.52	25.17	-14.57	22.80	-8.85	-8.31	-3.98	-12.20	7.11
-11.90	-13.48	25.98	-13.98	21.92	-9.32	-8.36	-2.98	-12.75	6.28
-11.62	-14.44	26.72	-13.31	20.98	-9.63	-8.40	-1.98	-13.27	5.42
-11.31	-15.40	27.39	-12.57	19.99	-9.75	-8.41	-0.98	-13.83	4.60
-10.94	-16.33	28.00	-11.78	19.00	-9.59	-8.36	0.02	-14.58	3.94
-10.51	-17.23	28.50	-10.91	18.06	-9.25	-8.23	1.01	-15.52	3.62
-10.01	-18.09	28.91	-10.00	17.19	-8.77	-7.83	1.92	-16.50	3.75
-9.44	-18.91	29.22	-9.05	16.34	-8.24	-7.08	2.55	-17.43	4.12
-8.79	-19.68	29.45	-8.08	15.42	-7.84	-6.10	2.72	-18.31	4.58
-8.08	-20.38	29.58	-7.09	14.43	-7.80	-5.10	2.65	-19.17	5.10
-7.30	-21.00	29.62	-6.09	13.53	-8.20	-4.11	2.50	-20.03	5.61
-6.46	-21.54	29.56	-5.09	12.84	-8.92	-3.11	2.49	-20.91	6.08
-5.58	-22.01	29.38	-4.11	12.27	-9.74	-2.12	2.42	-21.84	6.44
-4.67	-22.43	29.06	-3.16	11.80	-10.62	-1.12	2.34	-22.82	6.66
-3.73	-22.78	28.69	-2.23	11.29	-11.48	-0.13	2.22	-23.82	6.69
-2.78	-23.07	28.26	-1.33	10.68	-12.28	0.87	2.10	-24.79	6.47
-1.81	-23.32	27.74	-0.48	10.00	-13.01	1.86	1.98	-25.69	6.03
-0.83	-23.50	27.11	0.30	9.26	-13.67	2.85	1.85	-26.50	5.45
0.17	-23.63	26.41	1.01	8.47	-14.29	3.85	1.81	-27.17	4.71
1.16	-23.68	25.60	1.60	7.67	-14.88	4.85	1.88	-27.69	3.86
2.16	-23.67	24.70	2.03	6.85	-15.46	5.83	2.07	-28.08	2.94
3.16	-23.58	23.74	2.30	6.02	-16.02	6.73	2.47	-28.31	1.97
4.14	-23.41	22.75	2.43	5.13	-16.48	7.30	3.25	-28.38	0.97
5.11	-23.17	21.75	2.42	4.21	-16.88	7.17	4.23	-28.25	-0.02
6.07	-22.88	20.77	2.24	3.26	-17.18	6.71	5.11	-27.96	-0.97
7.01	-22.52	19.81	1.98	2.28	-17.36	6.08	5.89	-27.51	-1.87
7.92	-22.11	18.86	1.65	1.29	-17.29	5.34	6.56	-26.96	-2.70
8.81	-21.65	17.97	1.21	0.32	-17.07	4.52	7.13	-26.31	-3.46
9.67	-21.15	17.12	0.68	-0.62	-16.71	3.66	7.65	-25.60	-4.16
10.52	-20.62	16.30	0.10	-1.56	-16.37	2.77	8.10	-24.82	-4.78
11.36	-20.08	15.56	-0.56	-2.51	-16.08	1.84	8.47	-24.00	-5.35
12.21	-19.55	14.93	-1.34	-3.48	-15.82	0.90	8.82	-23.12	-5.83
13.06	-19.03	14.63	-2.28	-4.44	-15.53	-0.05	9.11	-22.22	-6.26
13.93	-18.54	14.86	-3.25	-5.34	-15.12	-1.02	9.37	-21.31	-6.67
14.82	-18.08	15.45	-4.04	-6.15	-14.53	-1.99	9.59	-20.39	-7.06
15.71	-17.63	16.29	-4.57	-6.79	-13.77	-2.98	9.77	-19.45	-7.42
16.62	-17.22	17.24	-4.89	-7.24	-12.88	-3.97	9.88	-18.49	-7.69
17.57	-16.90	18.22	-5.11	-7.54	-11.93	-4.97	9.92	-17.51	-7.91
18.53	-16.60	19.21	-5.24	-7.76	-10.95	-5.97	9.87	-16.53	-8.10
19.49	-16.33	20.20	-5.36	-7.91	-9.96	-6.96	9.74	-15.56	-8.34
20.47	-16.13	21.18	-5.55	-8.02	-8.97	-7.94	9.54	-14.64	-8.72
21.45	-15.96	22.14	-5.84	-8.10	-7.97	-8.89	9.25	-13.84	-9.31

Pinna plane 6 mm									
\hat{a}_e	\hat{b}_e	\hat{a}_e	\hat{b}_e	\hat{a}_e	\hat{b}_e	\hat{a}_e	\hat{b}_e	\hat{a}_e	\hat{b}_e
-14.54	-10.11	22.04	-17.53	24.09	-7.02	-7.85	-7.26	-11.63	5.60
-13.78	-10.75	23.03	-17.40	24.40	-7.95	-7.91	-6.26	-12.23	4.81
-13.19	-11.56	24.01	-17.21	23.94	-8.81	-8.00	-5.26	-12.87	4.04
-12.76	-12.46	24.96	-16.89	23.12	-9.37	-8.11	-4.27	-13.56	3.32
-12.42	-13.40	25.86	-16.47	22.21	-9.78	-8.22	-3.27	-14.37	2.73
-12.08	-14.34	26.71	-15.94	21.25	-10.08	-8.33	-2.28	-15.32	2.42
-11.75	-15.28	27.48	-15.30	20.27	-10.24	-8.45	-1.29	-16.31	2.46
-11.41	-16.22	28.18	-14.60	19.27	-10.22	-8.58	-0.30	-17.27	2.75
-11.01	-17.14	28.82	-13.83	18.29	-10.03	-8.73	0.69	-18.18	3.15
-10.54	-18.02	29.36	-12.98	17.35	-9.69	-8.79	1.69	-19.07	3.61
-10.01	-18.87	29.81	-12.09	16.46	-9.24	-8.55	2.65	-19.95	4.09
-9.40	-19.67	30.18	-11.16	15.56	-8.81	-7.83	3.31	-20.85	4.53
-8.74	-20.41	30.42	-10.19	14.58	-8.62	-6.85	3.35	-21.76	4.93
-8.02	-21.10	30.60	-9.21	13.60	-8.79	-5.90	3.03	-22.68	5.34
-7.21	-21.69	30.71	-8.21	12.76	-9.31	-4.99	2.63	-23.63	5.63
-6.35	-22.20	30.71	-7.22	12.06	-10.03	-4.02	2.37	-24.63	5.66
-5.46	-22.65	30.66	-6.22	11.51	-10.86	-3.03	2.24	-25.61	5.48
-4.53	-23.03	30.46	-5.24	10.99	-11.72	-2.04	2.10	-26.53	5.09
-3.59	-23.36	30.15	-4.29	10.40	-12.53	-1.05	2.00	-27.31	4.48
-2.63	-23.63	29.76	-3.37	9.71	-13.24	-0.05	1.95	-27.92	3.69
-1.65	-23.83	29.31	-2.48	8.94	-13.89	0.95	1.90	-28.35	2.79
-0.66	-23.96	28.78	-1.63	8.15	-14.49	1.95	1.86	-28.60	1.83
0.34	-24.01	28.17	-0.84	7.33	-15.07	2.94	1.93	-28.71	0.83
1.34	-24.00	27.46	-0.13	6.50	-15.62	3.90	2.20	-28.62	-0.16
2.34	-23.91	26.67	0.47	5.64	-16.14	4.75	2.73	-28.40	-1.13
3.32	-23.74	25.77	0.92	4.78	-16.64	5.07	3.64	-28.06	-2.07
4.30	-23.51	24.82	1.22	3.90	-17.12	4.77	4.59	-27.62	-2.97
5.26	-23.23	23.83	1.35	2.98	-17.53	4.18	5.39	-27.07	-3.81
6.20	-22.91	22.83	1.36	2.03	-17.81	3.44	6.06	-26.45	-4.59
7.13	-22.55	21.84	1.28	1.04	-17.93	2.62	6.64	-25.77	-5.33
8.04	-22.13	20.86	1.04	0.04	-17.84	1.76	7.14	-25.05	-6.02
8.93	-21.68	19.92	0.72	-0.93	-17.61	0.86	7.58	-24.28	-6.65
9.81	-21.20	19.02	0.29	-1.88	-17.29	-0.06	7.97	-23.44	-7.20
10.68	-20.70	18.20	-0.28	-2.82	-16.94	-1.00	8.30	-22.55	-7.64
11.55	-20.21	17.47	-0.97	-3.74	-16.57	-1.96	8.58	-21.63	-8.04
12.43	-19.73	16.92	-1.80	-4.66	-16.16	-2.93	8.82	-20.70	-8.42
13.32	-19.29	16.72	-2.77	-5.52	-15.66	-3.92	8.99	-19.76	-8.76
14.24	-18.88	17.02	-3.71	-6.25	-14.98	-4.91	9.08	-18.82	-9.08
15.16	-18.50	17.72	-4.42	-6.78	-14.14	-5.91	9.07	-17.85	-9.35
16.10	-18.16	18.61	-4.87	-7.13	-13.20	-6.91	8.96	-16.87	-9.53
17.06	-17.88	19.56	-5.19	-7.34	-12.22	-7.88	8.72	-15.89	-9.70
18.04	-17.70	20.53	-5.43	-7.50	-11.24	-8.81	8.36	-14.91	-9.91
19.04	-17.60	21.50	-5.66	-7.63	-10.25	-9.67	7.85		
20.04	-17.58	22.46	-5.92	-7.72	-9.25	-10.43	7.20		
21.04	-17.57	23.36	-6.36	-7.79	-8.25	-11.06	6.43		

Pinna plane 7 mm – 1							
\hat{a}_e	\hat{b}_e	\hat{a}_e	\hat{b}_e	\hat{a}_e	\hat{b}_e	\hat{a}_e	\hat{b}_e
-27.32	3.84	2.43	-24.08	27.27	-0.22	2.03	-17.92
-27.97	3.08	3.40	-23.85	26.36	0.20	1.06	-18.19
-28.41	2.19	4.36	-23.57	25.39	0.44	0.07	-18.23
-28.63	1.21	5.31	-23.27	24.40	0.57	-0.93	-18.13
-28.71	0.22	6.26	-22.94	23.40	0.54	-1.90	-17.90
-28.61	-0.77	7.19	-22.56	22.41	0.40	-2.85	-17.58
-28.40	-1.75	8.10	-22.17	21.44	0.16	-3.76	-17.16
-28.07	-2.70	9.02	-21.76	20.51	-0.20	-4.63	-16.69
-27.66	-3.61	9.91	-21.32	19.66	-0.72	-5.45	-16.11
-27.20	-4.49	10.82	-20.89	18.96	-1.43	-6.15	-15.40
-26.68	-5.34	11.73	-20.47	18.46	-2.29	-6.63	-14.53
-26.10	-6.16	12.65	-20.10	18.38	-3.27	-6.91	-13.58
-25.47	-6.94	13.60	-19.78	18.83	-4.15	-7.06	-12.59
-24.79	-7.67	14.56	-19.51	19.58	-4.81	-7.17	-11.59
-24.05	-8.35	15.54	-19.30	20.46	-5.28	-7.27	-10.60
-23.26	-8.95	16.53	-19.17	21.39	-5.65	-7.34	-9.60
-22.40	-9.47	17.53	-19.16	22.35	-5.95	-7.40	-8.60
-21.52	-9.93	18.53	-19.25	23.29	-6.28	-7.47	-7.60
-20.61	-10.36	19.51	-19.41	24.18	-6.73	-7.56	-6.61
-19.71	-10.78	20.50	-19.59	24.89	-7.42	-7.66	-5.61
-18.77	-11.14	21.49	-19.73	25.20	-8.35	-7.82	-4.63
-17.81	-11.42	22.48	-19.82	24.73	-9.20	-8.00	-3.64
-16.84	-11.66	23.48	-19.78	23.87	-9.69	-8.17	-2.66
-15.87	-11.88	24.47	-19.61	22.94	-10.06	-8.35	-1.67
-14.91	-12.17	25.41	-19.30	21.98	-10.36	-8.60	-0.71
-14.11	-12.76	26.31	-18.86	21.01	-10.59	-8.95	0.23
-13.50	-13.54	27.14	-18.31	20.03	-10.77	-9.38	1.13
-13.00	-14.41	27.91	-17.67	19.03	-10.80	-9.91	1.98
-12.53	-15.29	28.62	-16.97	18.04	-10.69	-10.64	2.66
-12.10	-16.19	29.24	-16.18	17.07	-10.44	-11.57	2.97
-11.67	-17.09	29.80	-15.35	16.13	-10.11	-12.53	2.73
-11.19	-17.97	30.30	-14.49	15.18	-9.79	-13.39	2.22
-10.66	-18.82	30.73	-13.58	14.19	-9.63	-14.23	1.68
-10.08	-19.63	31.07	-12.65	13.21	-9.79	-15.16	1.33
-9.44	-20.40	31.35	-11.69	12.33	-10.25	-16.15	1.26
-8.75	-21.13	31.56	-10.71	11.58	-10.91	-17.13	1.43
-8.00	-21.79	31.71	-9.72	10.95	-11.69	-18.08	1.74
-7.18	-22.36	31.75	-8.72	10.34	-12.48	-19.00	2.14
-6.31	-22.84	31.66	-7.72	9.66	-13.21	-19.90	2.57
-5.40	-23.27	31.49	-6.74	8.90	-13.86	-20.81	2.99
-4.47	-23.63	31.25	-5.77	8.09	-14.44	-21.73	3.38
-3.52	-23.93	30.94	-4.82	7.25	-14.98	-22.65	3.77
-2.54	-24.14	30.54	-3.90	6.40	-15.51	-23.58	4.15
-1.55	-24.29	30.04	-3.04	5.54	-16.03	-24.53	4.45
-0.55	-24.35	29.48	-2.21	4.68	-16.53	-25.52	4.57
0.45	-24.33	28.83	-1.45	3.82	-17.04	-26.49	4.37
1.44	-24.24	28.09	-0.79	2.94	-17.51		

Pinna plane 7 mm – 2	
\hat{a}_e	\hat{b}_e
-7.73	5.32
-6.98	4.66
-6.21	4.02
-5.43	3.40
-4.57	2.89
-3.63	2.55
-2.66	2.30
-1.68	2.13
-0.68	2.18
0.31	2.29
1.31	2.35
2.23	2.69
2.71	3.54
2.42	4.48
1.79	5.25
1.04	5.91
0.22	6.48
-0.66	6.96
-1.57	7.36
-2.51	7.71
-3.48	7.96
-4.47	8.07
-5.47	8.06
-6.46	7.93
-7.38	7.56
-8.09	6.87
-8.14	5.90

Pinna plane 8 mm – 1							
\hat{a}_e	\hat{b}_e	\hat{a}_e	\hat{b}_e	\hat{a}_e	\hat{b}_e	\hat{a}_e	\hat{b}_e
-28.23	1.00	5.61	-23.25	26.75	-0.47	-0.65	-18.34
-28.40	0.02	6.56	-22.93	25.78	-0.27	-1.64	-18.22
-28.38	-0.98	7.50	-22.59	24.78	-0.20	-2.61	-17.95
-28.22	-1.96	8.44	-22.25	23.79	-0.30	-3.52	-17.55
-27.96	-2.93	9.38	-21.90	22.81	-0.49	-4.38	-17.05
-27.63	-3.87	10.31	-21.56	21.86	-0.82	-5.19	-16.45
-27.27	-4.80	11.27	-21.25	20.99	-1.30	-5.89	-15.74
-26.82	-5.70	12.23	-20.98	20.29	-2.01	-6.38	-14.88
-26.33	-6.57	13.21	-20.81	19.86	-2.90	-6.65	-13.92
-25.83	-7.43	14.21	-20.72	19.94	-3.88	-6.77	-12.92
-25.28	-8.27	15.21	-20.76	20.47	-4.72	-6.85	-11.93
-24.68	-9.07	16.20	-20.90	21.23	-5.36	-6.91	-10.93
-24.05	-9.85	17.16	-21.15	22.10	-5.85	-6.96	-9.93
-23.37	-10.57	18.11	-21.48	23.02	-6.25	-7.00	-8.93
-22.65	-11.27	19.02	-21.88	23.94	-6.64	-7.07	-7.93
-21.90	-11.93	19.95	-22.25	24.82	-7.11	-7.16	-6.94
-21.12	-12.55	20.91	-22.54	25.53	-7.81	-7.30	-5.95
-20.29	-13.12	21.90	-22.66	25.93	-8.71	-7.46	-4.96
-19.45	-13.67	22.89	-22.61	25.75	-9.67	-7.67	-3.98
-18.57	-14.13	23.87	-22.41	24.92	-10.20	-7.91	-3.01
-17.66	-14.54	24.82	-22.09	23.97	-10.50	-8.15	-2.04
-16.72	-14.89	25.72	-21.65	22.98	-10.69	-8.47	-1.09
-15.79	-15.25	26.56	-21.12	22.01	-10.90	-8.92	-0.21
-14.88	-15.68	27.34	-20.49	21.03	-11.11	-9.52	0.60
-14.04	-16.21	28.08	-19.82	20.05	-11.31	-10.23	1.29
-13.27	-16.85	28.76	-19.08	19.06	-11.44	-11.10	1.77
-12.61	-17.60	29.40	-18.32	18.06	-11.46	-12.09	1.83
-11.99	-18.38	30.00	-17.52	17.06	-11.36	-13.01	1.45
-11.36	-19.16	30.54	-16.68	16.08	-11.17	-13.83	0.88
-10.74	-19.94	31.02	-15.80	15.11	-10.94	-14.68	0.36
-10.07	-20.69	31.43	-14.89	14.12	-10.77	-15.63	0.07
-9.37	-21.40	31.81	-13.96	13.13	-10.80	-16.62	0.03
-8.62	-22.07	32.12	-13.01	12.18	-11.10	-17.60	0.23
-7.82	-22.67	32.35	-12.04	11.33	-11.63	-18.54	0.58
-6.96	-23.17	32.51	-11.05	10.60	-12.31	-19.47	0.95
-6.06	-23.60	32.60	-10.06	9.89	-13.01	-20.39	1.33
-5.13	-23.96	32.59	-9.06	9.12	-13.66	-21.31	1.73
-4.17	-24.26	32.47	-8.07	8.31	-14.23	-22.23	2.13
-3.20	-24.46	32.25	-7.09	7.46	-14.76	-23.15	2.52
-2.20	-24.59	31.95	-6.14	6.59	-15.26	-24.08	2.87
-1.21	-24.65	31.59	-5.21	5.73	-15.76	-25.03	3.17
-0.21	-24.62	31.14	-4.31	4.86	-16.27	-26.02	3.24
0.79	-24.54	30.65	-3.44	4.00	-16.78	-26.95	2.88
1.78	-24.39	30.06	-2.64	3.14	-17.28	-27.67	2.20
2.75	-24.16	29.33	-1.96	2.25	-17.75	-28.14	1.32
3.71	-23.88	28.54	-1.35	1.32	-18.11		
4.66	-23.57	27.68	-0.83	0.35	-18.31		

Pinna plane 8 mm – 2	
\hat{a}_e	\hat{b}_e
-4.45	6.01
-4.89	5.21
-4.36	4.37
-3.52	3.84
-2.59	3.47
-1.61	3.48
-0.83	4.06
-1.21	4.94
-1.98	5.57
-2.91	5.94
-3.89	6.11

Pinna plane 9 mm							
\hat{a}_e	\hat{b}_e	\hat{a}_e	\hat{b}_e	\hat{a}_e	\hat{b}_e	\hat{a}_e	\hat{b}_e
10.65	-12.76	-20.09	-0.22	-2.20	-24.92	33.22	-8.91
9.82	-13.32	-21.02	0.16	-1.20	-24.92	33.03	-7.93
9.00	-13.89	-21.94	0.54	-0.20	-24.86	32.74	-6.97
8.16	-14.43	-22.87	0.92	0.80	-24.76	32.36	-6.05
7.29	-14.92	-23.80	1.29	1.78	-24.59	31.91	-5.15
6.40	-15.38	-24.75	1.59	2.76	-24.36	31.41	-4.29
5.52	-15.85	-25.74	1.66	3.72	-24.10	30.83	-3.47
4.65	-16.34	-26.65	1.26	4.68	-23.81	30.13	-2.77
3.78	-16.84	-27.33	0.54	5.64	-23.52	29.33	-2.17
2.91	-17.34	-27.67	-0.39	6.60	-23.24	28.46	-1.66
2.01	-17.77	-27.78	-1.38	7.56	-22.97	27.55	-1.27
1.07	-18.10	-27.71	-2.38	8.53	-22.72	26.57	-1.06
0.09	-18.29	-27.53	-3.36	9.50	-22.50	25.57	-1.01
-0.91	-18.31	-27.27	-4.33	10.49	-22.33	24.57	-1.08
-1.90	-18.18	-26.94	-5.27	11.48	-22.25	23.60	-1.31
-2.85	-17.88	-26.56	-6.20	12.48	-22.32	22.67	-1.67
-3.74	-17.42	-26.16	-7.11	13.45	-22.57	21.85	-2.23
-4.56	-16.86	-25.72	-8.01	14.38	-22.92	21.27	-3.03
-5.28	-16.16	-25.26	-8.90	15.27	-23.37	21.15	-4.01
-5.86	-15.35	-24.78	-9.77	16.09	-23.95	21.55	-4.91
-6.25	-14.43	-24.26	-10.63	16.90	-24.53	22.20	-5.67
-6.44	-13.45	-23.71	-11.46	17.75	-25.05	23.00	-6.27
-6.51	-12.46	-23.13	-12.28	18.67	-25.45	23.88	-6.73
-6.54	-11.46	-22.51	-13.06	19.64	-25.68	24.77	-7.20
-6.57	-10.46	-21.86	-13.82	20.64	-25.70	25.60	-7.75
-6.60	-9.46	-21.15	-14.53	21.63	-25.58	26.27	-8.49
-6.65	-8.46	-20.43	-15.22	22.59	-25.31	26.73	-9.37
-6.74	-7.46	-19.69	-15.89	23.54	-24.99	26.80	-10.36
-6.88	-6.47	-18.91	-16.51	24.46	-24.61	26.26	-11.17
-7.07	-5.49	-18.08	-17.07	25.35	-24.15	25.31	-11.45
-7.28	-4.51	-17.23	-17.60	26.19	-23.61	24.31	-11.50
-7.53	-3.55	-16.35	-18.09	26.99	-23.01	23.31	-11.52
-7.83	-2.59	-15.47	-18.55	27.73	-22.34	22.31	-11.59
-8.19	-1.66	-14.57	-19.00	28.43	-21.63	21.32	-11.72
-8.69	-0.80	-13.68	-19.44	29.08	-20.86	20.33	-11.90
-9.33	-0.03	-12.82	-19.95	29.69	-20.08	19.35	-12.07
-10.09	0.62	-11.99	-20.51	30.27	-19.26	18.36	-12.19
-11.00	1.02	-11.19	-21.11	30.80	-18.41	17.36	-12.25
-11.99	1.01	-10.40	-21.72	31.31	-17.55	16.36	-12.21
-12.88	0.57	-9.61	-22.34	31.76	-16.66	15.36	-12.13
-13.66	-0.05	-8.80	-22.92	32.16	-15.74	14.37	-12.00
-14.45	-0.66	-7.94	-23.44	32.52	-14.81	13.38	-11.91
-15.32	-1.14	-7.04	-23.87	32.83	-13.86	12.39	-12.00
-16.30	-1.36	-6.12	-24.26	33.08	-12.89	11.44	-12.31
-17.29	-1.28	-5.16	-24.54	33.20	-11.90		
-18.25	-0.99	-4.19	-24.76	33.29	-10.90		
-19.17	-0.61	-3.19	-24.87	33.31	-9.90		

Pinna plane 10 mm							
\hat{a}_e	\hat{b}_e	\hat{a}_e	\hat{b}_e	\hat{a}_e	\hat{b}_e	\hat{a}_e	\hat{b}_e
-3.92	-25.29	33.70	-13.18	11.64	-13.25	-19.99	-1.85
-2.92	-25.34	33.80	-12.18	10.68	-13.52	-20.91	-1.47
-1.92	-25.33	33.83	-11.18	9.76	-13.92	-21.84	-1.11
-0.92	-25.29	33.81	-10.18	8.87	-14.38	-22.78	-0.76
0.08	-25.21	33.71	-9.19	7.99	-14.84	-23.73	-0.44
1.07	-25.09	33.50	-8.21	7.09	-15.29	-24.71	-0.26
2.06	-24.93	33.19	-7.26	6.19	-15.72	-25.67	-0.47
3.04	-24.74	32.78	-6.35	5.29	-16.16	-26.40	-1.14
4.02	-24.53	32.30	-5.48	4.39	-16.60	-26.77	-2.06
4.98	-24.28	31.73	-4.65	3.50	-17.05	-26.84	-3.05
5.96	-24.07	31.09	-3.89	2.60	-17.49	-26.76	-4.05
6.94	-23.87	30.35	-3.22	1.68	-17.87	-26.55	-5.03
7.94	-23.76	29.51	-2.67	0.72	-18.14	-26.28	-5.99
8.94	-23.73	28.60	-2.25	-0.28	-18.25	-25.97	-6.94
9.92	-23.87	27.65	-1.96	-1.27	-18.20	-25.61	-7.87
10.85	-24.25	26.66	-1.85	-2.25	-17.99	-25.25	-8.80
11.66	-24.82	25.66	-1.90	-3.16	-17.57	-24.83	-9.72
12.40	-25.50	24.67	-2.08	-4.01	-17.05	-24.41	-10.62
13.12	-26.19	23.74	-2.43	-4.76	-16.39	-23.97	-11.52
13.89	-26.83	22.92	-2.99	-5.34	-15.58	-23.51	-12.40
14.68	-27.43	22.40	-3.83	-5.75	-14.67	-23.00	-13.27
15.57	-27.90	22.39	-4.82	-6.02	-13.71	-22.47	-14.11
16.53	-28.18	22.79	-5.72	-6.14	-12.71	-21.91	-14.94
17.52	-28.30	23.43	-6.49	-6.19	-11.71	-21.31	-15.74
18.52	-28.33	24.21	-7.12	-6.23	-10.72	-20.67	-16.51
19.51	-28.24	25.03	-7.69	-6.27	-9.72	-20.01	-17.26
20.49	-28.04	25.84	-8.27	-6.32	-8.72	-19.31	-17.97
21.45	-27.76	26.58	-8.94	-6.42	-7.72	-18.56	-18.64
22.40	-27.43	27.16	-9.75	-6.57	-6.73	-17.80	-19.28
23.32	-27.06	27.52	-10.68	-6.78	-5.76	-16.99	-19.87
24.23	-26.65	27.60	-11.67	-7.05	-4.79	-16.14	-20.41
25.11	-26.16	27.28	-12.61	-7.33	-3.83	-15.28	-20.91
25.95	-25.62	26.53	-13.24	-7.64	-2.88	-14.39	-21.37
26.75	-25.02	25.55	-13.29	-8.09	-1.99	-13.49	-21.81
27.50	-24.36	24.58	-13.04	-8.65	-1.17	-12.59	-22.24
28.21	-23.66	23.60	-12.83	-9.36	-0.46	-11.69	-22.68
28.88	-22.92	22.61	-12.74	-10.21	0.05	-10.79	-23.11
29.52	-22.15	21.61	-12.76	-11.18	0.25	-9.89	-23.54
30.12	-21.35	20.61	-12.84	-12.14	0.00	-8.98	-23.95
30.69	-20.53	19.62	-12.95	-12.95	-0.58	-8.05	-24.33
31.22	-19.68	18.62	-13.05	-13.65	-1.29	-7.11	-24.67
31.72	-18.81	17.63	-13.12	-14.37	-1.98	-6.15	-24.94
32.17	-17.92	16.63	-13.16	-15.20	-2.53	-5.17	-25.14
32.58	-17.01	15.63	-13.18	-16.15	-2.83	-4.18	-25.27
32.93	-16.07	14.63	-13.17	-17.15	-2.80		
33.25	-15.12	13.63	-13.14	-18.12	-2.56		
33.52	-14.16	12.63	-13.14	-19.06	-2.22		

Pinna plane 11 mm							
\hat{a}_e	\hat{b}_e	\hat{a}_e	\hat{b}_e	\hat{a}_e	\hat{b}_e	\hat{a}_e	\hat{b}_e
-22.96	-13.40	16.27	-30.48	23.36	-5.12	-4.75	-15.92
-22.54	-14.31	17.26	-30.40	23.54	-6.09	-5.26	-15.05
-22.06	-15.19	18.25	-30.27	24.02	-6.96	-5.60	-14.11
-21.57	-16.06	19.24	-30.08	24.65	-7.74	-5.82	-13.14
-21.05	-16.91	20.21	-29.84	25.36	-8.44	-5.93	-12.15
-20.48	-17.73	21.15	-29.52	26.11	-9.10	-6.01	-11.15
-19.87	-18.53	22.07	-29.13	26.83	-9.80	-6.09	-10.15
-19.25	-19.31	22.98	-28.71	27.46	-10.58	-6.16	-9.16
-18.57	-20.05	23.88	-28.28	27.88	-11.48	-6.27	-8.16
-17.86	-20.75	24.76	-27.80	28.06	-12.46	-6.45	-7.18
-17.10	-21.40	25.61	-27.28	28.01	-13.46	-6.63	-6.19
-16.29	-21.98	26.43	-26.70	27.69	-14.40	-6.93	-5.24
-15.44	-22.51	27.22	-26.09	27.19	-15.26	-7.28	-4.31
-14.56	-22.99	27.95	-25.41	26.50	-15.98	-7.62	-3.36
-13.66	-23.43	28.64	-24.69	25.55	-16.15	-8.11	-2.49
-12.75	-23.84	29.29	-23.92	24.66	-15.71	-8.74	-1.72
-11.82	-24.21	29.91	-23.14	23.78	-15.22	-9.51	-1.08
-10.89	-24.56	30.51	-22.34	22.84	-14.88	-10.44	-0.74
-9.94	-24.88	31.08	-21.52	21.87	-14.67	-11.43	-0.81
-8.98	-25.17	31.61	-20.67	20.87	-14.54	-12.27	-1.32
-8.02	-25.45	32.10	-19.80	19.88	-14.45	-12.95	-2.05
-7.05	-25.66	32.55	-18.91	18.88	-14.41	-13.55	-2.85
-6.06	-25.83	32.95	-17.99	17.88	-14.37	-14.19	-3.62
-5.07	-25.95	33.31	-17.06	16.88	-14.36	-14.94	-4.28
-4.07	-26.01	33.62	-16.11	15.88	-14.35	-15.86	-4.65
-3.07	-26.04	33.89	-15.14	14.88	-14.37	-16.86	-4.63
-2.07	-26.03	34.07	-14.16	13.88	-14.40	-17.83	-4.40
-1.07	-25.99	34.19	-13.17	12.88	-14.40	-18.78	-4.10
-0.07	-25.92	34.22	-12.17	11.88	-14.42	-19.73	-3.78
0.92	-25.83	34.20	-11.17	10.89	-14.50	-20.67	-3.43
1.92	-25.72	34.12	-10.17	9.91	-14.70	-21.61	-3.09
2.91	-25.60	33.94	-9.19	8.95	-15.00	-22.56	-2.77
3.90	-25.48	33.68	-8.23	8.03	-15.37	-23.53	-2.57
4.90	-25.42	33.32	-7.29	7.11	-15.76	-24.52	-2.65
5.90	-25.43	32.85	-6.41	6.19	-16.16	-25.25	-3.29
6.88	-25.59	32.32	-5.57	5.26	-16.54	-25.51	-4.25
7.80	-25.99	31.67	-4.81	4.35	-16.94	-25.53	-5.25
8.57	-26.62	30.93	-4.14	3.42	-17.31	-25.41	-6.24
9.27	-27.33	30.09	-3.60	2.48	-17.66	-25.22	-7.22
9.97	-28.05	29.18	-3.18	1.53	-17.97	-24.96	-8.18
10.69	-28.74	28.22	-2.92	0.55	-18.15	-24.66	-9.14
11.49	-29.34	27.22	-2.81	-0.45	-18.17	-24.33	-10.08
12.36	-29.83	26.23	-2.85	-1.44	-18.01	-24.00	-11.02
13.30	-30.18	25.25	-3.07	-2.38	-17.69	-23.62	-11.95
14.27	-30.39	24.34	-3.47	-3.27	-17.24	-23.21	-12.86
15.27	-30.49	23.64	-4.17	-4.08	-16.65		

Pinna plane 12 mm							
\hat{a}_e	\hat{b}_e	\hat{a}_e	\hat{b}_e	\hat{a}_e	\hat{b}_e	\hat{a}_e	\hat{b}_e
27.68	-16.13	-6.52	-8.24	-14.11	-24.65	28.48	-25.99
27.29	-17.05	-6.72	-7.26	-13.23	-25.13	29.14	-25.24
26.78	-17.91	-6.96	-6.29	-12.31	-25.53	29.78	-24.48
26.21	-18.73	-7.29	-5.35	-11.37	-25.88	30.39	-23.68
25.55	-19.48	-7.70	-4.44	-10.42	-26.19	30.97	-22.86
24.83	-20.17	-8.17	-3.56	-9.46	-26.47	31.53	-22.03
24.02	-20.76	-8.82	-2.80	-8.49	-26.71	32.04	-21.18
23.07	-21.05	-9.66	-2.26	-7.51	-26.90	32.51	-20.29
22.31	-20.56	-10.63	-2.11	-6.52	-27.06	32.94	-19.39
22.03	-19.60	-11.56	-2.44	-5.53	-27.17	33.33	-18.47
21.62	-18.69	-12.24	-3.17	-4.53	-27.24	33.64	-17.52
20.99	-17.92	-12.80	-4.00	-3.53	-27.25	33.92	-16.56
20.19	-17.31	-13.25	-4.89	-2.53	-27.28	34.15	-15.59
19.31	-16.84	-13.68	-5.79	-1.54	-27.31	34.31	-14.60
18.37	-16.49	-14.27	-6.59	-0.54	-27.32	34.42	-13.61
17.41	-16.25	-15.17	-7.00	0.46	-27.36	34.47	-12.61
16.42	-16.06	-16.16	-6.98	1.46	-27.43	34.40	-11.61
15.43	-15.94	-17.13	-6.77	2.45	-27.60	34.27	-10.62
14.43	-15.87	-18.10	-6.49	3.40	-27.89	34.07	-9.64
13.43	-15.83	-19.06	-6.21	4.31	-28.30	33.78	-8.68
12.43	-15.79	-20.00	-5.90	5.15	-28.84	33.41	-7.76
11.44	-15.76	-20.96	-5.59	5.95	-29.44	32.92	-6.88
10.44	-15.76	-21.92	-5.35	6.74	-30.06	32.33	-6.08
9.44	-15.87	-22.91	-5.37	7.52	-30.68	31.62	-5.38
8.46	-16.05	-23.62	-6.04	8.36	-31.22	30.79	-4.81
7.50	-16.31	-23.87	-7.00	9.26	-31.66	29.90	-4.37
6.55	-16.63	-23.88	-8.00	10.20	-31.98	28.94	-4.08
5.60	-16.95	-23.77	-8.99	11.18	-32.17	27.96	-3.93
4.66	-17.28	-23.59	-9.97	12.18	-32.28	26.96	-3.91
3.70	-17.58	-23.35	-10.94	13.18	-32.33	25.99	-4.13
2.73	-17.84	-23.07	-11.91	14.18	-32.30	25.10	-4.58
1.76	-18.05	-22.78	-12.86	15.17	-32.23	24.40	-5.26
0.77	-18.17	-22.43	-13.80	16.17	-32.13	24.28	-6.23
-0.23	-18.16	-22.07	-14.73	17.15	-31.97	24.48	-7.20
-1.21	-17.97	-21.69	-15.66	18.13	-31.75	24.88	-8.12
-2.15	-17.62	-21.28	-16.57	19.10	-31.50	25.43	-8.95
-3.03	-17.15	-20.83	-17.46	20.05	-31.20	26.02	-9.76
-3.85	-16.59	-20.34	-18.33	20.99	-30.86	26.63	-10.55
-4.56	-15.88	-19.81	-19.18	21.92	-30.48	27.26	-11.32
-5.12	-15.06	-19.27	-20.02	22.82	-30.05	27.77	-12.18
-5.53	-14.15	-18.68	-20.83	23.70	-29.58	28.10	-13.12
-5.80	-13.19	-18.02	-21.58	24.56	-29.07	28.17	-14.12
-5.96	-12.20	-17.33	-22.30	25.41	-28.54	27.99	-15.10
-6.08	-11.21	-16.58	-22.96	26.23	-27.97	27.71	-16.06
-6.21	-10.22	-15.80	-23.58	27.02	-27.36		
-6.33	-9.22	-14.97	-24.15	27.77	-26.70		

Pinna plane 13 mm							
\hat{a}_e	\hat{b}_e	\hat{a}_e	\hat{b}_e	\hat{a}_e	\hat{b}_e	\hat{a}_e	\hat{b}_e
24.86	-21.34	-7.13	-8.66	-9.38	-27.94	31.18	-23.13
24.16	-22.05	-7.38	-7.69	-8.42	-28.22	31.73	-22.29
23.40	-22.70	-7.72	-6.75	-7.46	-28.50	32.23	-21.43
22.61	-23.31	-8.17	-5.86	-6.49	-28.76	32.69	-20.54
21.77	-23.86	-8.77	-5.06	-5.52	-28.98	33.10	-19.63
20.87	-24.30	-9.56	-4.47	-4.54	-29.20	33.47	-18.70
19.92	-24.58	-10.53	-4.53	-3.57	-29.43	33.79	-17.75
18.93	-24.77	-11.28	-5.18	-2.60	-29.66	34.04	-16.78
17.94	-24.77	-11.71	-6.08	-1.63	-29.91	34.24	-15.81
17.02	-24.39	-11.98	-7.04	-0.67	-30.21	34.37	-14.81
16.55	-23.55	-12.25	-8.01	0.27	-30.54	34.42	-13.82
16.74	-22.57	-12.64	-8.93	1.21	-30.87	34.43	-12.82
17.06	-21.63	-13.29	-9.67	2.14	-31.24	34.35	-11.82
17.28	-20.66	-14.25	-9.86	3.07	-31.62	34.16	-10.84
17.10	-19.68	-15.24	-9.74	3.99	-31.99	33.89	-9.88
16.46	-18.92	-16.22	-9.52	4.93	-32.34	33.55	-8.94
15.62	-18.39	-17.19	-9.27	5.88	-32.66	33.11	-8.04
14.71	-17.99	-18.16	-9.04	6.84	-32.95	32.53	-7.23
13.75	-17.69	-19.13	-8.81	7.81	-33.19	31.81	-6.53
12.78	-17.45	-20.12	-8.65	8.79	-33.37	30.97	-5.99
11.79	-17.30	-21.09	-8.79	9.78	-33.51	30.05	-5.60
10.80	-17.19	-21.72	-9.55	10.78	-33.58	29.09	-5.35
9.80	-17.13	-21.97	-10.51	11.78	-33.62	28.09	-5.26
8.80	-17.13	-21.98	-11.51	12.78	-33.61	27.10	-5.35
7.80	-17.22	-21.90	-12.51	13.77	-33.55	26.17	-5.70
6.82	-17.36	-21.73	-13.49	14.77	-33.42	25.45	-6.38
5.83	-17.56	-21.52	-14.47	15.76	-33.27	25.16	-7.33
4.86	-17.79	-21.28	-15.44	16.74	-33.08	25.25	-8.32
3.88	-18.00	-20.95	-16.38	17.71	-32.84	25.55	-9.27
2.90	-18.17	-20.59	-17.32	18.67	-32.57	25.94	-10.19
1.91	-18.29	-20.19	-18.24	19.62	-32.25	26.41	-11.08
0.91	-18.35	-19.76	-19.14	20.55	-31.88	26.85	-11.97
-0.09	-18.26	-19.29	-20.02	21.47	-31.49	27.25	-12.88
-1.06	-18.04	-18.78	-20.88	22.37	-31.06	27.61	-13.82
-1.99	-17.68	-18.22	-21.71	23.25	-30.58	27.79	-14.80
-2.88	-17.22	-17.61	-22.50	24.11	-30.07	27.70	-15.80
-3.72	-16.68	-16.95	-23.25	24.94	-29.52	27.51	-16.78
-4.49	-16.05	-16.24	-23.95	25.76	-28.94	27.16	-17.71
-5.16	-15.31	-15.49	-24.62	26.56	-28.34	26.72	-18.61
-5.69	-14.46	-14.71	-25.24	27.33	-27.70	26.24	-19.49
-6.08	-13.54	-13.88	-25.79	28.06	-27.02	25.69	-20.32
-6.33	-12.57	-13.03	-26.33	28.75	-26.30	25.07	-21.10
-6.50	-11.59	-12.16	-26.81	29.41	-25.55		
-6.70	-10.61	-11.25	-27.24	30.04	-24.77		
-6.89	-9.63	-10.32	-27.61	30.62	-23.96		

Pinna plane 14 mm							
\hat{a}_e	\hat{b}_e	\hat{a}_e	\hat{b}_e	\hat{a}_e	\hat{b}_e	\hat{a}_e	\hat{b}_e
24.89	-21.11	-6.56	-14.52	-7.79	-29.48	29.76	-25.17
24.27	-21.89	-7.12	-13.69	-6.85	-29.84	30.35	-24.36
23.61	-22.64	-7.57	-12.80	-5.91	-30.18	30.93	-23.55
22.88	-23.32	-8.03	-11.91	-4.97	-30.51	31.48	-22.71
22.09	-23.93	-8.48	-11.02	-4.03	-30.85	31.99	-21.85
21.27	-24.51	-8.93	-10.14	-3.08	-31.17	32.46	-20.97
20.40	-24.99	-9.78	-10.27	-2.13	-31.48	32.89	-20.07
19.47	-25.37	-10.23	-11.16	-1.19	-31.81	33.27	-19.14
18.51	-25.65	-10.59	-12.09	-0.23	-32.10	33.58	-18.19
17.53	-25.83	-11.14	-12.92	0.73	-32.38	33.84	-17.23
16.54	-25.97	-11.96	-13.47	1.69	-32.66	34.03	-16.25
15.54	-25.98	-12.94	-13.40	2.66	-32.91	34.14	-15.25
14.54	-25.89	-13.84	-12.97	3.63	-33.13	34.17	-14.25
13.57	-25.68	-14.71	-12.48	4.61	-33.34	34.13	-13.25
12.64	-25.30	-15.63	-12.08	5.59	-33.52	34.00	-12.26
11.93	-24.63	-16.60	-11.84	6.58	-33.69	33.80	-11.29
12.02	-23.67	-17.59	-11.75	7.56	-33.86	33.47	-10.34
12.52	-22.80	-18.58	-11.89	8.56	-34.00	33.02	-9.45
13.02	-21.93	-19.43	-12.39	9.55	-34.09	32.43	-8.65
13.21	-20.96	-19.92	-13.26	10.55	-34.11	31.69	-7.97
12.79	-20.08	-20.16	-14.23	11.55	-34.13	30.85	-7.43
12.01	-19.46	-20.21	-15.23	12.55	-34.12	29.93	-7.07
11.10	-19.06	-20.14	-16.22	13.55	-34.05	28.94	-6.90
10.14	-18.77	-19.96	-17.20	14.54	-33.94	27.95	-6.93
9.16	-18.56	-19.67	-18.16	15.53	-33.80	27.01	-7.25
8.17	-18.44	-19.32	-19.10	16.51	-33.60	26.29	-7.93
7.17	-18.37	-18.92	-20.02	17.48	-33.35	26.02	-8.88
6.17	-18.38	-18.47	-20.91	18.43	-33.06	26.00	-9.88
5.17	-18.45	-17.97	-21.77	19.38	-32.73	26.18	-10.86
4.18	-18.56	-17.42	-22.61	20.31	-32.36	26.42	-11.83
3.18	-18.64	-16.79	-23.39	21.22	-31.94	26.64	-12.80
2.18	-18.67	-16.13	-24.14	22.11	-31.49	26.85	-13.78
1.18	-18.64	-15.42	-24.84	22.98	-31.00	26.97	-14.78
0.19	-18.53	-14.69	-25.52	23.83	-30.48	26.99	-15.77
-0.78	-18.31	-13.91	-26.15	24.67	-29.93	26.92	-16.77
-1.72	-17.97	-13.11	-26.75	25.48	-29.34	26.68	-17.74
-2.63	-17.55	-12.27	-27.28	26.26	-28.72	26.33	-18.68
-3.50	-17.06	-11.42	-27.82	27.02	-28.07	25.90	-19.58
-4.34	-16.52	-10.54	-28.30	27.77	-27.41	25.37	-20.43
-5.17	-15.95	-9.63	-28.71	28.48	-26.71		
-5.90	-15.27	-8.72	-29.11	29.14	-25.95		

Pinna plane 15 mm							
\hat{a}_e	\hat{b}_e	\hat{a}_e	\hat{b}_e	\hat{a}_e	\hat{b}_e	\hat{a}_e	\hat{b}_e
-18.80	-16.37	10.21	-34.06	32.78	-11.36	8.25	-24.69
-18.84	-17.37	11.21	-34.07	32.22	-10.53	8.56	-23.76
-18.72	-18.36	12.21	-34.05	31.50	-9.84	9.08	-22.91
-18.49	-19.33	13.21	-33.98	30.67	-9.29	9.46	-21.99
-18.15	-20.27	14.21	-33.90	29.72	-8.97	9.33	-21.02
-17.75	-21.18	15.20	-33.76	28.72	-8.92	8.61	-20.34
-17.26	-22.06	16.18	-33.59	27.77	-9.18	7.71	-19.92
-16.70	-22.89	17.16	-33.37	27.05	-9.86	6.74	-19.66
-16.10	-23.68	18.12	-33.09	26.75	-10.80	5.75	-19.51
-15.44	-24.44	19.06	-32.76	26.66	-11.80	4.76	-19.43
-14.74	-25.15	19.99	-32.39	26.66	-12.80	3.76	-19.38
-14.01	-25.83	20.90	-31.98	26.65	-13.80	2.76	-19.30
-13.23	-26.46	21.79	-31.52	26.58	-14.80	1.77	-19.19
-12.44	-27.07	22.66	-31.03	26.44	-15.79	0.78	-19.05
-11.62	-27.64	23.51	-30.49	26.28	-16.77	-0.20	-18.83
-10.78	-28.18	24.34	-29.94	26.00	-17.73	-1.15	-18.54
-9.90	-28.67	25.15	-29.36	25.63	-18.66	-2.09	-18.18
-9.01	-29.12	25.94	-28.74	25.17	-19.55	-3.01	-17.79
-8.10	-29.54	26.69	-28.08	24.62	-20.38	-3.90	-17.34
-7.21	-29.98	27.42	-27.40	24.02	-21.18	-4.77	-16.85
-6.30	-30.40	28.13	-26.69	23.38	-21.95	-5.65	-16.36
-5.37	-30.76	28.79	-25.94	22.68	-22.66	-6.52	-15.88
-4.43	-31.11	29.44	-25.18	21.94	-23.33	-7.42	-15.45
-3.49	-31.45	30.04	-24.38	21.16	-23.97	-8.40	-15.24
-2.54	-31.77	30.60	-23.56	20.35	-24.54	-9.35	-15.50
-1.59	-32.07	31.15	-22.72	19.48	-25.04	-10.13	-16.12
-0.63	-32.35	31.66	-21.86	18.57	-25.45	-10.94	-16.67
0.34	-32.61	32.13	-20.98	17.63	-25.79	-11.92	-16.58
1.31	-32.84	32.57	-20.08	16.66	-26.05	-12.79	-16.10
2.28	-33.07	32.95	-19.16	15.68	-26.23	-13.60	-15.51
3.27	-33.26	33.23	-18.20	14.69	-26.34	-14.39	-14.90
4.25	-33.43	33.44	-17.22	13.69	-26.38	-15.25	-14.38
5.24	-33.58	33.59	-16.23	12.69	-26.37	-16.18	-14.06
6.23	-33.72	33.63	-15.23	11.69	-26.28	-17.18	-14.07
7.22	-33.85	33.55	-14.23	10.70	-26.14	-18.01	-14.60
8.22	-33.93	33.40	-13.25	9.74	-25.87	-18.55	-15.43
9.22	-34.00	33.17	-12.27	8.83	-25.46		

Pinna plane 16 mm					
\hat{a}_e	\hat{b}_e	\hat{a}_e	\hat{b}_e	\hat{a}_e	\hat{b}_e
-16.40	-16.20	18.61	-32.30	19.89	-24.19
-17.13	-16.86	19.54	-31.94	19.03	-24.69
-17.41	-17.81	20.46	-31.56	18.14	-25.15
-17.42	-18.81	21.36	-31.12	17.21	-25.51
-17.27	-19.79	22.24	-30.63	16.25	-25.80
-16.99	-20.75	23.08	-30.09	15.28	-26.02
-16.59	-21.66	23.91	-29.54	14.29	-26.21
-16.08	-22.53	24.73	-28.97	13.31	-26.35
-15.53	-23.36	25.51	-28.35	12.31	-26.45
-14.92	-24.15	26.26	-27.68	11.31	-26.47
-14.23	-24.87	26.98	-26.99	10.31	-26.45
-13.50	-25.55	27.67	-26.27	9.31	-26.38
-12.74	-26.21	28.34	-25.52	8.32	-26.27
-11.94	-26.81	28.97	-24.74	7.34	-26.07
-11.13	-27.39	29.57	-23.95	6.40	-25.74
-10.29	-27.93	30.13	-23.11	5.51	-25.29
-9.42	-28.43	30.65	-22.26	4.98	-24.48
-8.54	-28.90	31.11	-21.38	5.29	-23.55
-7.64	-29.35	31.54	-20.47	5.77	-22.67
-6.75	-29.79	31.93	-19.55	5.72	-21.71
-5.84	-30.20	32.23	-18.60	4.99	-21.05
-4.91	-30.58	32.41	-17.61	4.09	-20.62
-3.97	-30.93	32.50	-16.62	3.13	-20.34
-3.03	-31.27	32.49	-15.62	2.16	-20.10
-2.08	-31.59	32.33	-14.63	1.19	-19.86
-1.12	-31.87	32.01	-13.69	0.22	-19.59
-0.16	-32.13	31.51	-12.82	-0.74	-19.32
0.81	-32.36	30.83	-12.11	-1.68	-18.98
1.79	-32.56	29.93	-11.69	-2.62	-18.63
2.78	-32.74	28.94	-11.66	-3.55	-18.26
3.76	-32.90	28.06	-12.11	-4.47	-17.87
4.75	-33.04	27.51	-12.94	-5.39	-17.49
5.75	-33.16	27.16	-13.87	-6.34	-17.17
6.74	-33.27	26.88	-14.83	-7.33	-17.07
7.74	-33.36	26.62	-15.80	-8.22	-17.46
8.74	-33.41	26.31	-16.75	-8.77	-18.29
9.73	-33.46	25.94	-17.68	-9.46	-18.98
10.73	-33.48	25.46	-18.56	-10.44	-18.97
11.73	-33.47	24.94	-19.41	-11.35	-18.58
12.73	-33.42	24.33	-20.20	-12.21	-18.06
13.73	-33.35	23.66	-20.94	-13.03	-17.49
14.72	-33.22	22.98	-21.68	-13.84	-16.91
15.71	-33.05	22.29	-22.40	-14.69	-16.38
16.69	-32.85	21.55	-23.07	-15.64	-16.09
17.66	-32.60	20.73	-23.65		

Pinna plane 17 mm					
\hat{a}_e	\hat{b}_e	\hat{a}_e	\hat{b}_e	\hat{a}_e	\hat{b}_e
-4.81	-29.70	29.42	-21.01	0.93	-22.30
-3.88	-30.06	29.75	-20.06	0.50	-21.44
-2.93	-30.39	29.89	-19.07	-0.33	-20.88
-1.98	-30.70	29.83	-18.08	-1.24	-20.48
-1.02	-30.97	29.54	-17.13	-2.18	-20.14
-0.05	-31.20	28.71	-16.70	-3.13	-19.83
0.93	-31.42	27.86	-17.19	-4.11	-19.63
1.91	-31.61	27.11	-17.85	-5.10	-19.66
2.90	-31.77	26.44	-18.59	-5.53	-20.51
3.89	-31.90	25.85	-19.40	-5.94	-21.37
4.88	-32.01	25.16	-20.13	-6.92	-21.52
5.88	-32.10	24.42	-20.80	-7.91	-21.38
6.88	-32.17	23.72	-21.51	-8.86	-21.06
7.88	-32.23	23.06	-22.26	-9.76	-20.64
8.87	-32.26	22.32	-22.93	-10.64	-20.16
9.87	-32.28	21.50	-23.50	-11.49	-19.63
10.87	-32.27	20.64	-24.01	-12.33	-19.10
11.87	-32.23	19.75	-24.47	-13.21	-18.62
12.87	-32.18	18.84	-24.88	-14.13	-18.24
13.87	-32.11	17.91	-25.26	-15.10	-18.31
14.86	-31.97	16.96	-25.57	-15.69	-19.08
15.84	-31.78	16.00	-25.84	-15.74	-20.07
16.82	-31.57	15.02	-26.05	-15.53	-21.05
17.78	-31.30	14.04	-26.24	-15.13	-21.96
18.72	-30.96	13.05	-26.38	-14.61	-22.81
19.64	-30.56	12.06	-26.51	-14.02	-23.62
20.53	-30.11	11.06	-26.56	-13.37	-24.38
21.41	-29.63	10.06	-26.60	-12.64	-25.07
22.27	-29.12	9.06	-26.57	-11.89	-25.72
23.10	-28.57	8.06	-26.51	-11.09	-26.33
23.92	-28.00	7.07	-26.45	-10.26	-26.88
24.69	-27.36	6.07	-26.34	-9.42	-27.42
25.43	-26.69	5.09	-26.18	-8.55	-27.92
26.16	-26.00	4.11	-25.96	-7.67	-28.38
26.82	-25.25	3.15	-25.69	-6.77	-28.83
27.44	-24.47	2.22	-25.32	-5.86	-29.25
28.02	-23.65	1.35	-24.82	-4.95	-29.65
28.56	-22.81	0.62	-24.15		
29.02	-21.92	0.57	-23.22		

Pinna plane 18 mm			
\hat{a}_e	\hat{b}_e	\hat{a}_e	\hat{b}_e
-4.46	-28.41	9.25	-27.47
-3.52	-28.75	8.26	-27.35
-2.57	-29.06	7.26	-27.23
-1.61	-29.33	6.27	-27.11
-0.63	-29.56	5.28	-26.96
0.34	-29.78	4.30	-26.79
1.33	-29.95	3.31	-26.61
2.32	-30.06	2.33	-26.41
3.32	-30.16	1.36	-26.17
4.32	-30.22	0.40	-25.88
5.31	-30.26	-0.54	-25.57
6.31	-30.27	-1.49	-25.23
7.31	-30.24	-2.42	-24.87
8.31	-30.24	-3.36	-24.52
9.31	-30.22	-4.29	-24.16
10.31	-30.19	-5.22	-23.79
11.31	-30.15	-6.14	-23.40
12.31	-30.10	-7.07	-23.03
13.30	-29.99	-8.00	-22.67
14.29	-29.84	-8.92	-22.28
15.27	-29.64	-9.83	-21.87
16.25	-29.41	-10.72	-21.42
17.19	-29.09	-11.68	-21.12
18.09	-28.64	-12.64	-21.21
18.87	-28.02	-12.77	-22.14
19.55	-27.29	-12.30	-23.01
19.20	-26.67	-11.66	-23.78
18.20	-26.75	-10.96	-24.49
17.21	-26.88	-10.22	-25.16
16.22	-26.98	-9.41	-25.76
15.23	-27.11	-8.59	-26.32
14.23	-27.23	-7.73	-26.83
13.24	-27.33	-6.85	-27.30
12.25	-27.44	-5.96	-27.77
11.25	-27.49	-5.05	-28.18
10.25	-27.52		

Pinna plane 18.5 mm	
\hat{a}_e	\hat{b}_e
-4.09	-27.44
-3.15	-27.78
-2.20	-28.08
-1.22	-28.28
-0.24	-28.44
0.75	-28.61
1.74	-28.71
2.74	-28.65
3.72	-28.43
3.81	-27.79
2.89	-27.40
1.94	-27.11
0.97	-26.85
0.02	-26.54
-0.92	-26.21
-1.87	-25.88
-2.81	-25.54
-3.75	-25.21
-4.68	-24.85
-5.61	-24.46
-6.54	-24.11
-7.49	-23.79
-8.46	-23.54
-9.31	-23.82
-8.83	-24.67
-8.07	-25.31
-7.23	-25.85
-6.37	-26.37
-5.50	-26.84
-4.58	-27.25

Annex C

Cross sectional areas of Type 4.4 artificial ear

(This annex forms an integral part of this Recommendation.)

C.1 Cross sections of the concha bottom

The two additional cross-section planes around the EEP as illustrated in Figure 15 are determined in the same way as in clause B.1 for the type 4.3 ear.

C.2 Cross sectional areas of the ear canal and concha bottom

The cross sectional areas of the ear canal and the concha bottom as described in clauses 6.4.4.4.2, 6.4.4.4.3 and 6.4.4.4.4 and illustrated in Figure 15 in the plane of the two unit vectors \hat{b}_e, \hat{a}_e as illustrated in Figure 11 are listed in Table C.1. The cross sections along the centre line (the green planes) are given with 25 points on the periphery in each, corresponding to a spacing better than or equal to 1.1 mm. The cross sections of the concha bottom (the yellow planes) are larger and given with a spacing of 1 mm between the points. These tables are the basis for the plots shown in Figure 17.

Table C.1 – Tabular values for the cross sectional areas of the ear canal and concha bottom

DRP (0 mm) & cylindric cavity entry (14.25 mm)		14.5 mm		14.75 mm		15 mm	
\hat{a}_e	\hat{b}_e	\hat{a}_e	\hat{b}_e	\hat{a}_e	\hat{b}_e	\hat{a}_e	\hat{b}_e
3.44	-1.49	3.32	-1.43	3.19	-1.38	3.07	-1.32
2.86	-2.43	2.82	-2.23	2.67	-2.16	2.52	-2.09
2.00	-3.17	2.14	-2.88	1.97	-2.79	1.81	-2.71
0.97	-3.62	1.32	-3.35	1.16	-3.25	0.99	-3.16
-0.09	-3.75	0.42	-3.61	0.25	-3.51	0.08	-3.41
-1.10	-3.59	-0.52	-3.64	-0.69	-3.54	-0.85	-3.44
-1.95	-3.20	-1.44	-3.45	-1.61	-3.37	-1.78	-3.29
-2.62	-2.69	-2.29	-3.05	-2.48	-3.01	-2.66	-2.96
-3.10	-2.11	-3.03	-2.49	-3.25	-2.49	-3.47	-2.50
-3.44	-1.50	-3.61	-1.76	-3.89	-1.82	-4.16	-1.87
-3.65	-0.84	-3.98	-0.90	-4.29	-0.98	-4.61	-1.06
-3.75	-0.15	-4.04	0.04	-4.32	-0.04	-4.61	-0.12
-3.71	0.53	-3.82	0.94	-4.04	0.84	-4.25	0.74
-3.54	1.23	-3.38	1.76	-3.54	1.62	-3.69	1.48
-3.19	1.97	-2.77	2.47	-2.88	2.28	-2.99	2.10
-2.59	2.71	-2.01	3.02	-2.10	2.81	-2.20	2.60
-1.72	3.33	-1.15	3.39	-1.24	3.18	-1.34	2.97
-0.65	3.69	-0.23	3.58	-0.33	3.40	-0.43	3.23
0.45	3.72	0.71	3.55	0.60	3.43	0.50	3.32
1.46	3.45	1.61	3.29	1.51	3.24	1.42	3.19
2.31	2.96	2.41	2.82	2.35	2.82	2.28	2.83
2.98	2.27	3.06	2.14	3.02	2.18	2.98	2.21

Table C.1 – Tabular values for the cross sectional areas of the ear canal and concha bottom

DRP (0 mm) & cylindric cavity entry (14.25 mm)		14.5 mm		14.75 mm		15 mm	
3.46	1.45	3.50	1.31	3.47	1.35	3.44	1.39
3.71	0.52	3.68	0.39	3.63	0.43	3.58	0.46
3.72	-0.47	3.62	-0.54	3.53	-0.50	3.44	-0.47

Ref. Plane (15.25)	
\hat{a}_e	\hat{b}_e
2.94	-1.27
2.37	-2.02
1.65	-2.62
0.82	-3.07
-0.09	-3.31
-1.03	-3.34
-1.96	-3.21
-2.86	-2.91
-3.70	-2.50
-4.44	-1.92
-4.93	-1.12
-4.90	-0.20
-4.47	0.64
-3.84	1.34
-3.10	1.92
-2.29	2.40
-1.42	2.77
-0.53	3.06
0.40	3.21
1.34	3.14
2.22	2.83
2.95	2.24
3.41	1.42
3.53	0.50
3.35	-0.43

15.92 mm	
\hat{a}_e	\hat{b}_e
-1.83	2.63
-2.70	2.24
-3.52	1.75
-4.25	1.14
-4.85	0.39
-5.19	-0.49
-4.99	-1.40
-4.38	-2.14
-3.60	-2.68
-2.73	-3.08
-1.81	-3.32
-0.86	-3.37
0.09	-3.25
0.99	-2.95
1.81	-2.46
2.50	-1.81
3.07	-1.04
3.44	-0.17
3.55	0.78
3.29	1.69
2.71	2.44
1.89	2.92
0.97	3.14
0.02	3.10
-0.92	2.92

17.92 mm	
\hat{a}_e	\hat{b}_e
-0.30	-3.24
0.64	-3.00
1.52	-2.57
2.31	-2.00
2.95	-1.26
3.39	-0.39
3.52	0.57
3.26	1.50
2.64	2.26
1.80	2.74
0.84	2.94
-0.13	2.98
-1.11	2.88
-2.06	2.67
-2.98	2.34
-3.84	1.89
-4.62	1.29
-5.25	0.55
-5.61	-0.35
-5.48	-1.31
-4.90	-2.09
-4.10	-2.65
-3.21	-3.04
-2.26	-3.25
-1.28	-3.32

19.92 mm	
\hat{a}_e	\hat{b}_e
-0.43	-3.00
0.53	-2.91
1.45	-2.64
2.30	-2.18
3.01	-1.54
3.49	-0.71
3.61	0.24
3.34	1.16
2.76	1.93
1.98	2.48
1.07	2.81
0.12	2.96
-0.84	2.96
-1.80	2.84
-2.74	2.62
-3.64	2.28
-4.47	1.79
-5.18	1.15
-5.58	0.28
-5.44	-0.66
-4.87	-1.42
-4.11	-2.02
-3.26	-2.46
-2.34	-2.76
-1.39	-2.93

21.92 mm	
\hat{a}_e	\hat{b}_e
-4.35	2.12
-5.11	1.50
-5.54	0.64
-5.45	-0.32
-4.89	-1.12
-4.15	-1.76
-3.30	-2.25
-2.38	-2.61
-1.44	-2.87
-0.47	-3.01
0.51	-3.01
1.47	-2.82
2.37	-2.43
3.15	-1.85
3.68	-1.03
3.79	-0.06
3.50	0.87
2.95	1.67
2.22	2.32
1.34	2.77
0.39	3.00
-0.59	3.07
-1.57	3.01
-2.53	2.84
-3.47	2.55

23.92 mm	
\hat{a}_e	\hat{b}_e
3.56	0.84
2.99	1.69
2.24	2.41
1.38	2.96
0.41	3.28
-0.61	3.39
-1.64	3.33
-2.65	3.12
-3.60	2.75
-4.47	2.22
-5.18	1.47
-5.57	0.53
-5.51	-0.48
-5.01	-1.38
-4.24	-2.06
-3.34	-2.56
-2.39	-2.94
-1.40	-3.20
-0.38	-3.33
0.65	-3.31
1.65	-3.08
2.56	-2.62
3.37	-1.98
3.92	-1.13
3.93	-0.11

25.92 mm		EEP Projection #1		EEP Projection #2		EEP Projection #3	
\hat{a}_e	\hat{b}_e	\hat{a}_e	\hat{b}_e	\hat{a}_e	\hat{b}_e	\hat{a}_e	\hat{b}_e
-5.51	2.16	6.33	1.54	6.57	1.62	-6.38	3.86
-4.71	2.92	6.14	2.51	6.20	2.54	-6.82	2.97
-3.70	3.36	5.58	3.34	5.57	3.32	-7.00	1.99
-2.62	3.58	4.86	4.02	4.82	3.97	-6.94	0.99
-1.52	3.67	4.04	4.60	3.97	4.51	-6.78	0.00
-0.42	3.59	3.16	5.07	3.07	4.93	-6.58	-0.98
0.66	3.34	2.21	5.39	2.11	5.20	-6.37	-1.95
1.67	2.90	1.23	5.54	1.12	5.34	-6.16	-2.93
2.59	2.29	0.23	5.58	0.12	5.39	-5.99	-3.92
3.39	1.53	-0.77	5.55	-0.88	5.39	-5.83	-4.91
4.00	0.61	-1.77	5.45	-1.88	5.36	-5.67	-5.89
4.13	-0.47	-2.74	5.23	-2.88	5.28	-5.37	-6.84
3.69	-1.47	-3.65	4.82	-3.85	5.06	-4.92	-7.74
2.92	-2.26	-4.39	4.16	-4.76	4.65	-4.30	-8.52
2.00	-2.86	-4.90	3.31	-5.47	3.99	-3.54	-9.16
0.95	-3.22	-5.13	2.34	-5.96	3.13	-2.64	-9.60
-0.14	-3.38	-4.97	1.36	-6.09	2.15	-1.66	-9.78
-1.24	-3.38	-4.49	0.49	-5.94	1.16	-0.66	-9.73
-2.34	-3.25	-3.79	-0.23	-5.57	0.23	0.29	-9.43
-3.41	-2.97	-3.00	-0.83	-5.06	-0.62	1.16	-8.93
-4.43	-2.54	-2.13	-1.33	-4.47	-1.44	1.91	-8.28
-5.32	-1.89	-1.20	-1.70	-3.88	-2.24	2.57	-7.53
-5.94	-0.99	-0.24	-1.95	-3.29	-3.05	3.14	-6.71
-6.18	0.08	0.76	-2.05	-2.72	-3.87	3.63	-5.84
-6.01	1.18	1.76	-2.00	-2.09	-4.64	4.14	-4.98
		2.75	-1.86	-1.31	-5.26	4.71	-4.15
		3.71	-1.62	-0.35	-5.49	5.29	-3.34
		4.61	-1.17	0.63	-5.34	5.89	-2.54
		5.36	-0.52	1.47	-4.81	6.40	-1.68
		5.94	0.29	2.29	-4.23	6.75	-0.74
		6.30	1.22	3.10	-3.65	6.86	0.25
				3.92	-3.07	6.73	1.24
				4.72	-2.47	6.31	2.14
				5.43	-1.77	5.70	2.93
				6.02	-0.97	4.94	3.59
				6.44	-0.06	4.09	4.10
				6.60	0.92	3.17	4.49
						2.20	4.74
						1.21	4.87

25.92 mm

EEP Projection #1

EEP Projection #2

EEP Projection #3	
0.21	4.92
-0.79	4.96
-1.79	5.00
-2.79	5.04
-3.79	5.02
-4.77	4.84
-5.70	4.48

C.3 Cross sectional areas of the pinna simulator

The cross-sectional areas of the pinna simulator for the type 4.4 ear simulator are identical to the ones of type 4.3 and are provided in Table B.3.

Appendix I

Comparative acoustical input impedance measurements on the artificial ears Types 3.3 and 3.4 and on human ears

(This appendix does not form an integral part of this Recommendation.)

I.1 Introduction

This appendix presents an analysis of the ear impedance measurements made in the ITU-T round-robin test. An overview of the data from this test is presented in clause I.2 followed by a presentation of the measurements made on the type 3.3 and 3.4 artificial ears in clause I.3. Clause I.4 covers the analysis of the human ear measurements which includes two different approaches. A set of univariate analyses is applied first to assess the impedance variable in terms of variability and influence of the different factors for each frequency bin separately. A bivariate parametric analysis is then applied to describe the variability of the impedance and frequency variables for a set of frequency response extrema derived from the human ear measurements. Finally, a comparison between the set of human ear impedance measurements and the impedance measurements made on the type 3.3 and type 3.4 artificial ears is presented in clause I.5 for the two perspectives of univariate and the bivariate structural analyses.

I.2 Data overview

The data from the round-robin test comprised acoustic impedance measured using a phone-like impedance probe at each R40 (1/12th octave), as defined in [b-ISO 3], centre frequencies between 0.2–8 kHz for each test case.

Measurements made on artificial ear types according to this Recommendation at the standard measurement position according to [ITU-T P.64] included:

- 1) Measurements by Brüel & Kjær on a type 3.3 right artificial ear with separate test cases for application forces between 2 and 18 N increasing by 2 N steps.
- 2) Measurements by HEAD acoustics on a type 3.4 right artificial ear with separate test cases for application forces between 2 and 18 N increasing by 2 N steps.

This resulted in a total of 18 individual test cases from the 2 ear types (3.3, 3.4) × 9 application forces (2 N, 4 N, 6 N, 8 N, 10 N, 12 N, 14 N, 16 N, 18 N).

Measurements were also made on the ears of 60 male and 46 female human adult subjects, split between the organizations contributing to the tests. The organizational, geographical and age distribution of the human subjects are:

Contributor (country):

- Lab #1 – Nokia (Finland): 24 subjects
- Lab #2 – Brüel & Kjær (Denmark): 30 subjects
- Lab #3 – HEAD acoustics (Germany): 16 subjects
- Lab #4 – Motorola (USA): 16 subjects
- Lab #5 – Uniden (USA): 20 subjects

Age:

- 20-34 yrs: 38 subjects
- 35-49 yrs: 51 subjects
- ≥ 50 yrs: 17 subjects

Two separate measurements were made for each of the 106 human test subjects.

- 'Normal' application force of the handset against the users' ear, inferred from placement in a quiet environment (< 30 dBA background noise).
- 'Firm' application force of the handset against the users' ear, inferred from placement in a noisy environment (< 70 dBA hot noise present).

In both measurement cases, the user defined what application force was required.

This resulted in a total of 212 individual test cases from the 106 subjects (60 male, 46 female) \times 2 inferred application forces ('normal', 'firm').

No repetitions of test cases for the artificial or human ears were included.

I.3 Artificial ear measurements

Presented in this clause are the results of measurement on type 3.3 and type 3.4 artificial ears.

NOTE – Although not part of the planned test comparisons, results of measurement on type 3.2 low leak and 3.2 high leak ears are supplied as normative references in clause I.5.3.

I.3.1 HATS 3.3 ear

The set of measurements, made by Brüel & Kjær on a type 3.3 right artificial ear shown in Figure I.1, includes separate test cases for application forces between 2 and 18 N increasing by 2 N steps.

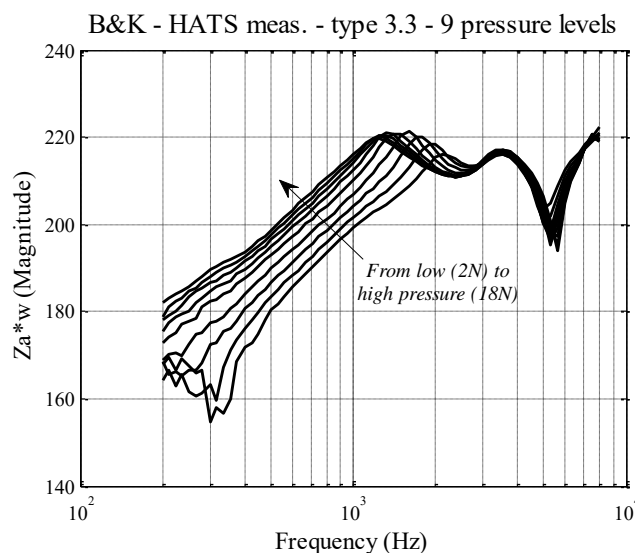

Figure I.1 – Measurement by Brüel & Kjær on a type 3.3 artificial ear with separate test cases for application forces between 2 and 18 N increasing by 2 N steps

I.3.2 HATS 3.4 ear

The set of measurements, made by HEAD acoustics on a type 3.4 artificial ear shown in Figure I.2, includes separate test cases for application forces between 2 and 18 N increasing by 2 N steps.

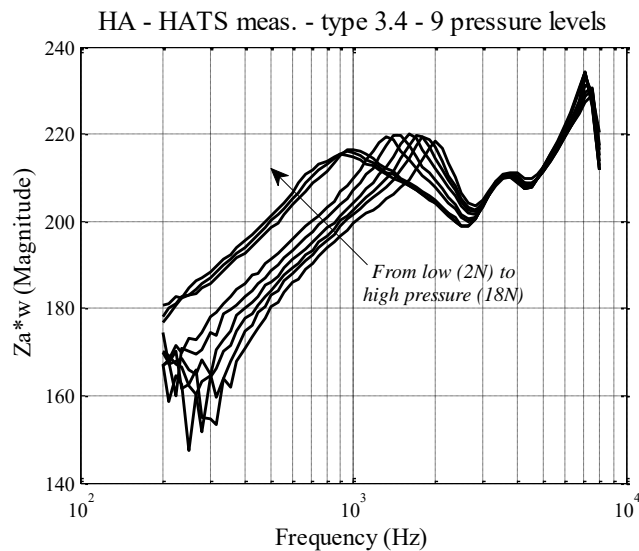

Figure I.2 – Measurement by HEAD acoustics on a type 3.4 artificial ear with separate test cases for application forces between 2 and 18 N increasing by 2 N steps

I.4 Human ear measurements

I.4.1 Univariate analysis of the human ear measurements

I.4.1.1 Descriptive statistics

Figure I.3 presents a statistical summary plot of the impedance versus 1/12th octave band for the normal (a) and firm (b) application force cases separately. Each of these graphs includes a box plot with potential outliers in red and extreme outliers in blue for each of the frequency bins individually. Figure I.3-a shows that the normal application force case contains a set of extreme outlying points, which have been identified as originating from two individual measurements (subjects #12 and #50). The firm application force case does not include any extreme outlying point. An identification of the outlier points from both cases (see graphs in clause I.5.4) highlighted that the outlier points in the two measurement sets are not due to one or several isolated measurements that would be clearly inconsistent with the general shape of this set of impedance measurements.

Figures I.4 and I.5 present an impedance versus frequency bin line chart of the raw data (left plot) and the mean and sample standard deviation (right plot) for the normal and firm application force cases separately. The graph of the raw data for the normal application force clearly shows the two extreme outlying cases highlighted above. Note that these two subjects (#12 and #50) were removed from the analysis presented in subsequent clauses. The standard deviation of the human ear measurements represented by the grey area in the right plots of Figures I.4 and I.5 illustrates the large variability in individual impedance at the different frequency bands.

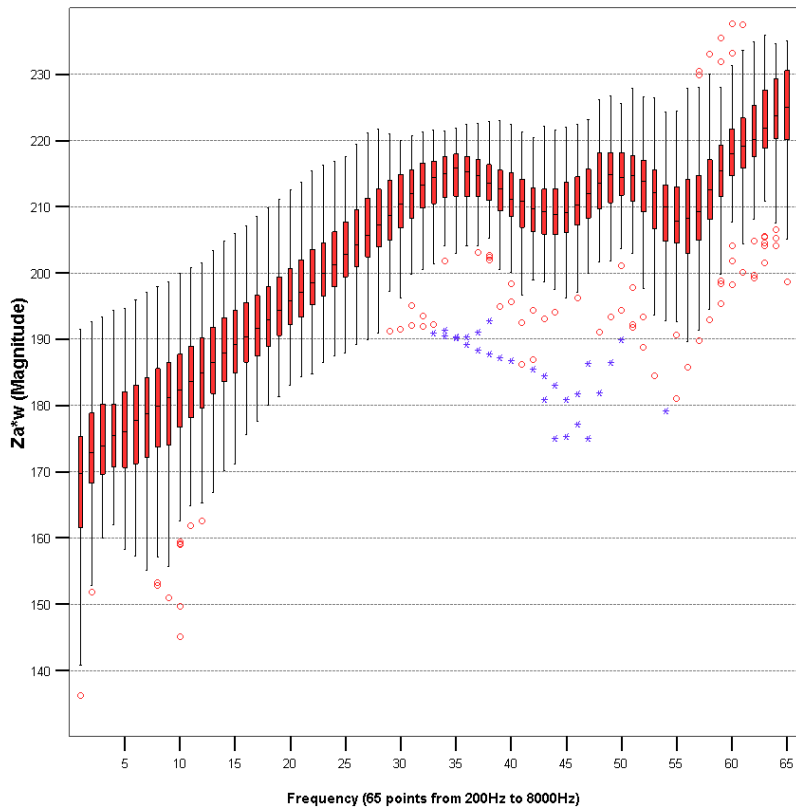

a)

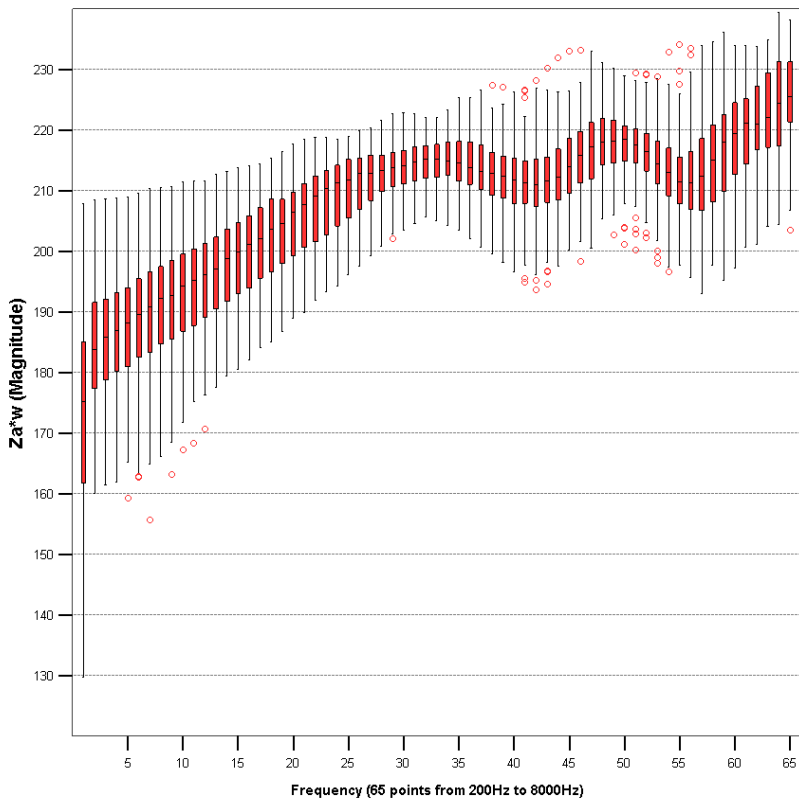

b)

Figure I.3 – Box plot with potential outliers (red circles) and extremes (blue stars) of the impedance versus 1/12th octave band for the normal (a) and firm (b) application force cases

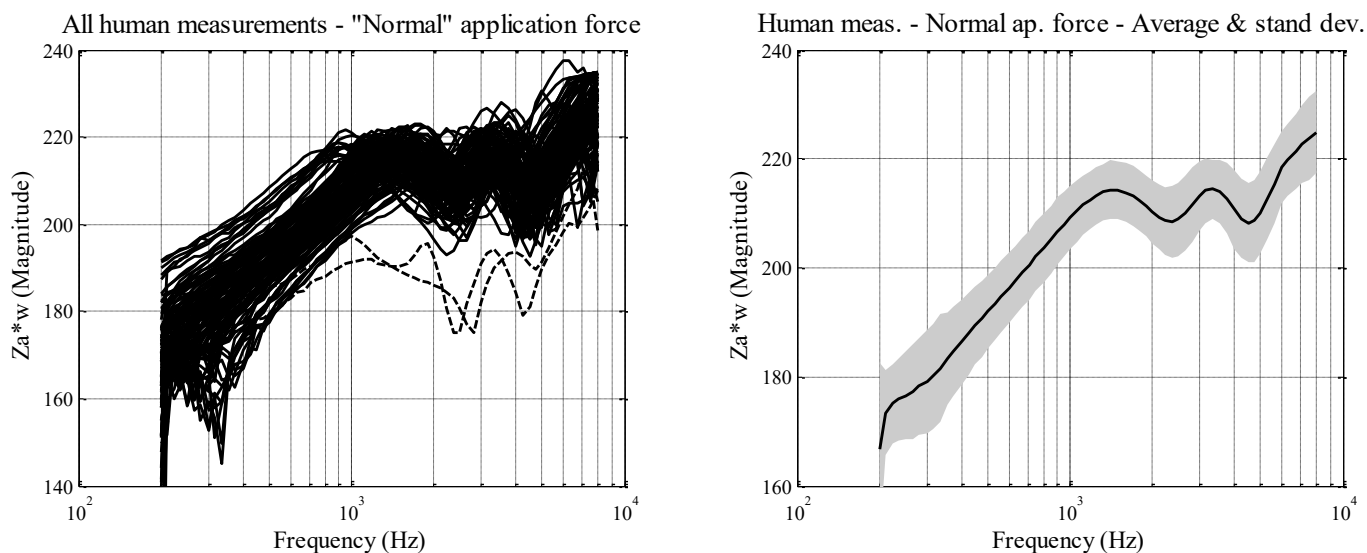

Figure I.4 – Impedance versus frequency bin line chart of the raw data (left plot) and the mean and sample standard deviation (right plot) for the normal application force case

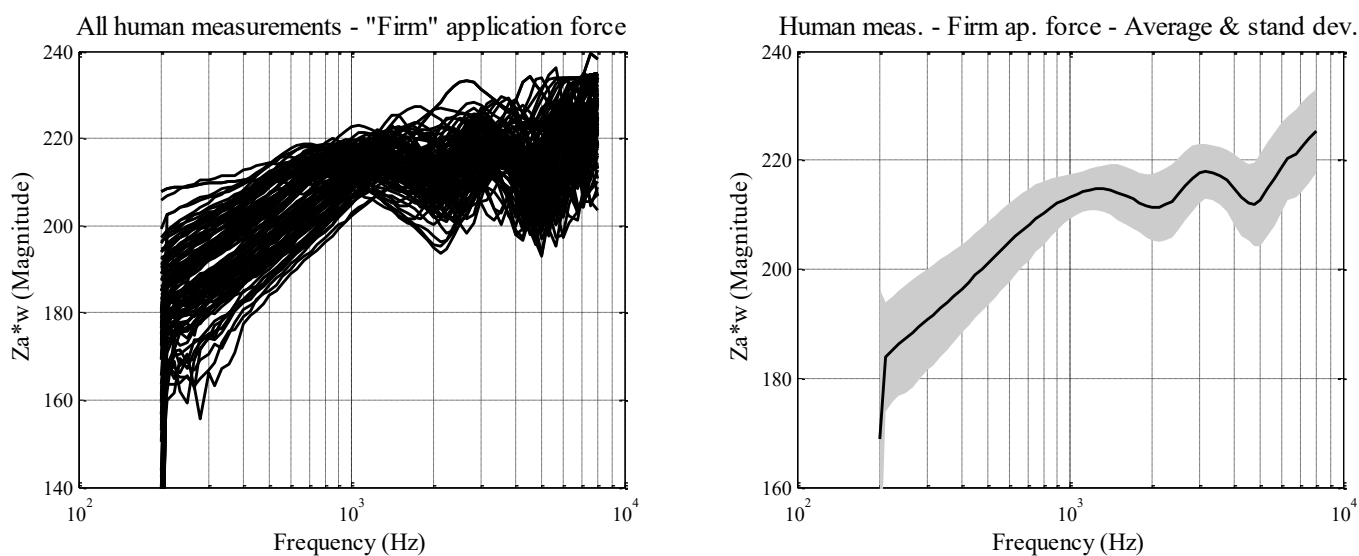

Figure I.5 – Impedance versus frequency bin line chart of the raw data (left plot) and the mean and sample standard deviation (right plot) for the firm application force case

I.4.1.2 Significance testing of experimental factors

An analysis of variance (ANOVA) was applied to each of 65 frequency bins separately considering the four following factors: Lab (five contributing organizations); Force (normal and firm application forces); Subject (104 measured individuals); Gender (male and female). The fact that a given individual was only measured in one laboratory and has one of the two genders has to be accounted for in the ANOVA by considering a nesting of factors. Two separate ANOVA models were considered to handle the nesting of the factor Subject in the factor Lab, on one hand, and the nesting of the factor Subject in the factor Gender, on the other side. The first set of ANOVA models includes the factors Lab, Force, Subject (Lab) and the interaction Lab * Force. The second ANOVA model includes the factors Gender, Force, Subject (Gender) and the interaction Gender * Force. For each of

these two ANOVA models, a summary table of the F-ratios and associated levels of significance for the different factors and interactions is presented for each frequency point in clause I.5.5. In this clause, impedance versus frequency bin line charts are used to display the impedance means and associated 95% confidence intervals about these means for the different factors. Also, significant levels for each ANOVA table in clause I.5.5 are shown to assess the confidence of the differences observed in these graphs.

Figure I.6 illustrates the effect of the factor Force, which is by far the largest for most frequency bins as can be seen from the ANOVA results shown in Tables I.2 and I.3 (clause I.5.5). The difference is clearly visible in Figure I.6 for the frequency range below 1.3 kHz and the range 2.1 kHz to 5 kHz.

The factor Lab (the five contributing organizations) has a much smaller effect than the factor Force as illustrated in the left plot of Figure I.7. The ANOVA results of Table I.2 also highlight some significant differences for this factor in the frequency range 1.9-2.3 kHz and around the frequency 4.2 kHz. Note, however, that the F-ratios are smaller than for the factor Force overall. The right plot of Figure I.7 illustrates the most salient example of the difference observed for this factor when comparing the laboratories Lab #2 and Lab #5. An additional plot is presented in Figure I.8 to compare human ear measurement means per region, i.e., between the three European laboratories (blue line) and the two North American laboratories (red line). This plot illustrates that differences between the two regions are not significant based on the overlapping 95% confidence intervals. The interaction Lab * Force in the ANOVA results shown in Table I.2 (clause I.5.5), shows a significant effect for the same frequency regions as those found for the factor Force. This effect is less important though, as can be seen from the relatively small F-ratios, but it indicates that the application force used by subjects for the two cases might have differed from one laboratory to another.

Considering finally the factor Gender, it appears that human ear measurements made on male and female subjects do not follow the exact same pattern. This difference is illustrated in the left plot of Figure I.9 and is also visible from the ANOVA results of Table I.3 in clause I.5.5. The factor Gender is significant in the region 1.5-2.3 kHz and 3.5-4.5 kHz with relatively high F-ratios. It can be seen however from Table I.3 that the interaction Gender * Force is not significant, except for a few isolated frequency bins, which indicates that the gender difference is not clearly related to a difference in application force. The right plot of Figure I.9 compares human ear measurement means per gender and per application force. This graph illustrates that differences seen between the two genders follow roughly the same pattern for the normal and firm application force cases.

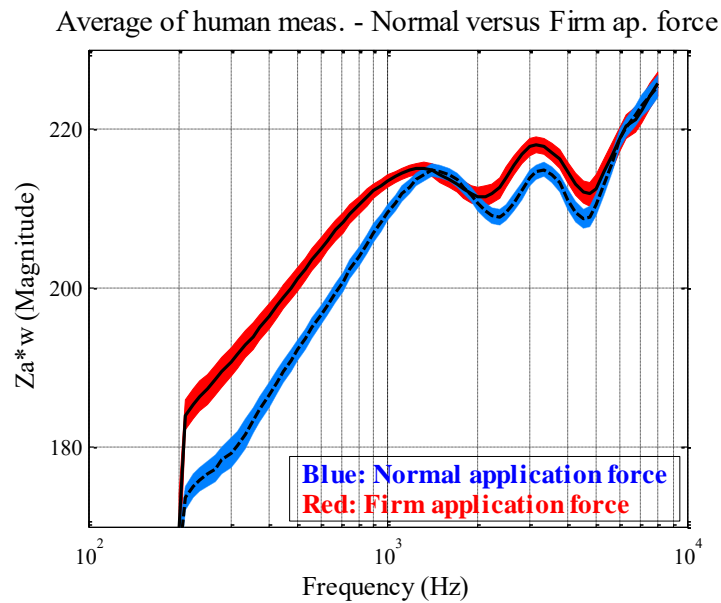
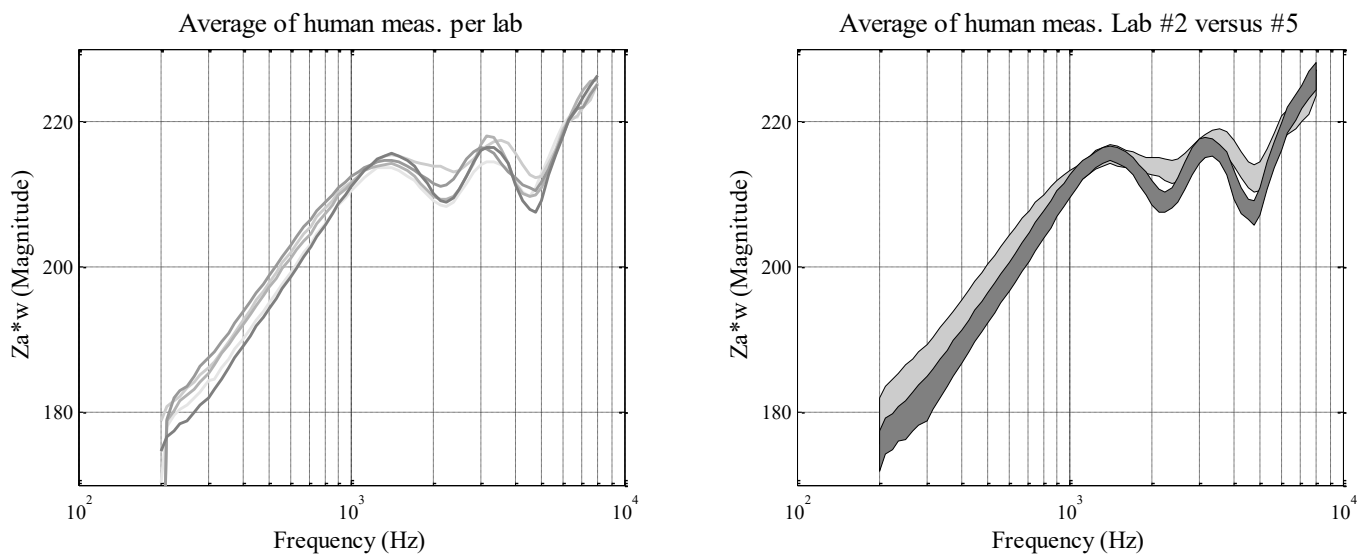
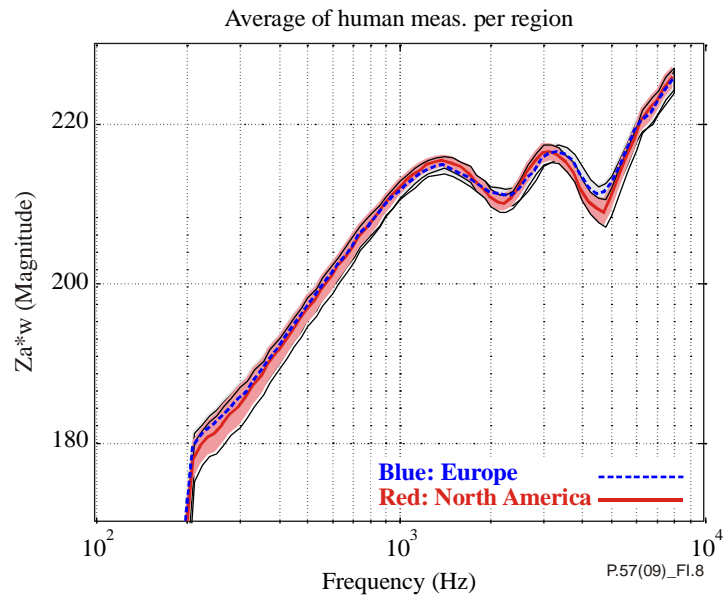

Figure I.6 – Comparison of human ear measurement means for the normal (blue curve) and firm (red curve) application force cases



NOTE – The left plot illustrates the level of differences between the five laboratories. The ANOVA table given in Table I.3 indicates that the factor Lab is significant for few frequency bins, which is visible when comparing the means and 95% confidence intervals of, e.g., the Labs #2 and #5, as illustrated in the right plot.

Figure I.7 – Comparison of human ear measurement means for the five contributing organizations (factor Lab)



NOTE – This plot illustrates that differences between the two regions are not significant based on the overlapping 95% confidence intervals.

Figure I.8 – Comparison of human ear measurement means per region, i.e., between the three European laboratories (blue line) and the two North American laboratories (red line)

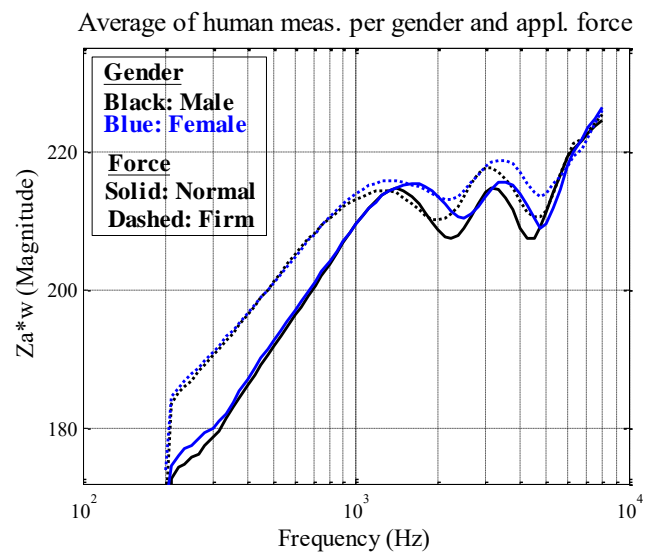
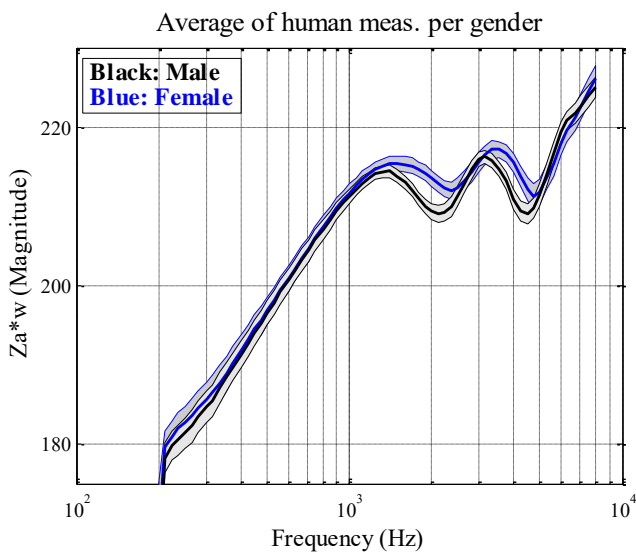

NOTE – Human ear measurement means per gender and application force (shown in the right plot) follow roughly the same pattern for the normal and firm application forces.

Figure I.9 – Comparison of human ear measurement means per gender (shown on the left plot) illustrating a significant difference between male and female measurements based on the non-overlapping 95% confidence intervals

I.4.2 Bivariate parametric analysis of the human ear measurements

I.4.2.1 Presentation of the analysis method

An inspection of the large set of human ear measurements made in this round-robin test reveals a common structure in the shape of the impedance response as a function of frequency. The curve formed by most of the individual impedance measurements shows a series of extrema which can be used as a basis for applying a structural analysis on this dataset. For this purpose, a routine to detect curve extrema was applied to all human ear measurements and a bivariate parametric analysis was then considered to describe the variability of the impedance and frequency variables for this set of frequency response extrema.

The routine used for the detection of curve extrema consists of an identification of maxima (response minima) in the curve, i.e., points that are preceded and followed by lower (response higher) values. The number of extrema detected from the set of 104 individual measurements in each of the two cases is reported in Table I.1. The automatic peak detection routine did not work 100% of the time because some curves did not follow the general shape of the dataset. Such curves lead to detected points that could be identified visually as clear outliers and were therefore removed from the dataset of extremum points. Table I.1 shows that the first two minima and maxima cover more than 90% of the individual measurements, except for the second minimum of the firm application force case, which includes only 70% of the individual measurements. The low values seen for the third maximum relates to the fact that this maximum lies around the 6-8 kHz region. As the impedance measurement was limited to 8 kHz in the present study, any maximum occurring above 8 kHz cannot be detected in this set of measurements. Therefore the information presented here for the third maximum should be interpreted with caution.

Table I.1 – Number of extrema detected from the set of 104 individual measurements for the normal and firm application force cases

Extremum index	Application force case			
	Normal		Firm	
	Maximum	Minimum	Maximum	Minimum
1	102	98	94	87
2	99	96	91	72
3	44		54	

I.4.2.2 Results of the parametric analysis

The resulting set of data points comprises the impedance and frequency values of each detected point; and the bivariate distribution of this dataset was studied for each extrema and application force case separately. A scatter plot of the extremum points is presented in Figure I.10 for the normal application force case (left plot) and the firm application force case (right plot). Three individual impedance responses are also included in this graph to illustrate how these clouds of points relate to the structural shape of the human ear impedance. To describe statistically each cloud of points, a bivariate mean was computed and an ellipse covering 95% of the data points was derived based on the Hotelling T-squared statistic. Figure I.11 illustrates the resulting structural representation of the individual human ear measurements for the normal application force case (left plot) and the firm application force case (right plot). This graph shows that the different clouds are relatively well discriminated. In Figure I.12, a comparison of the structural mean and the arithmetic mean is shown for the normal application force case (left plot) and the firm application force case (right plot). In these two plots, the size of the ellipses represents now the 95% confidence level for the mean value of the extrema, which can be compared to the 95% confidence interval of the arithmetic mean represented by the width of the blue and red curves in this figure. These two plots illustrate some differences in the

characteristics of the structural and arithmetic means for both the normal and firm application force cases. The frequency of the extrema relate relatively well with the two methods, except perhaps for the first maximum of the firm application force which shows a slight shift in frequency. However, the amplitude between two successive extrema (i.e., maximum impedance to minimum impedance) is about twice larger for the structural mean.

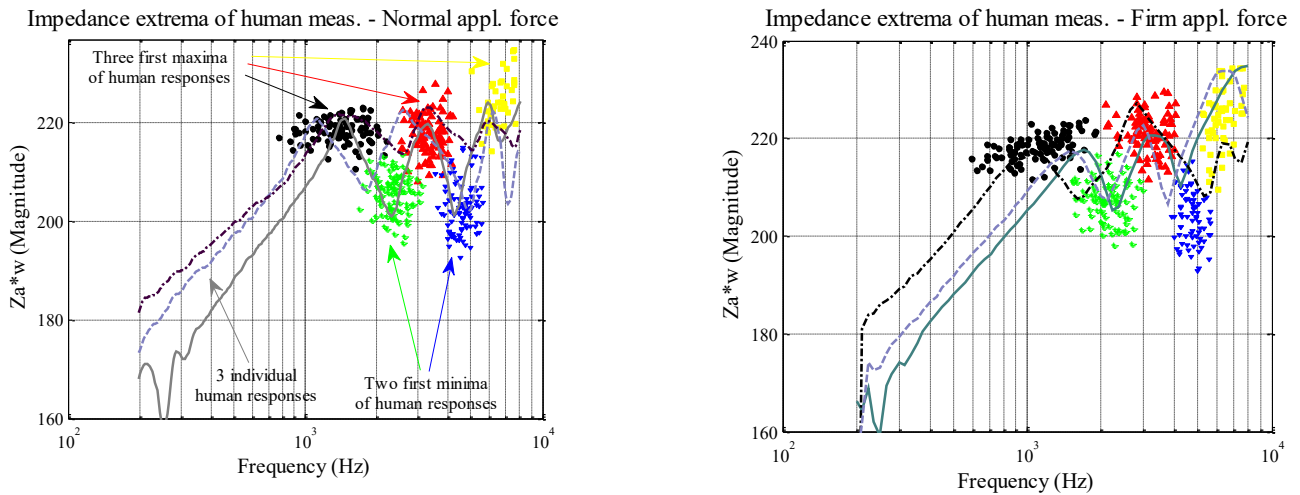

NOTE – The three individual impedance responses shown in these graphs illustrate how the clouds of points relate to the structural shape of the human ear impedance.

Figure I.10 – Scatter plot of the extremum points derived from the individual human ear impedance measurements for the normal application force case (left plot) and the firm application force case (right plot)

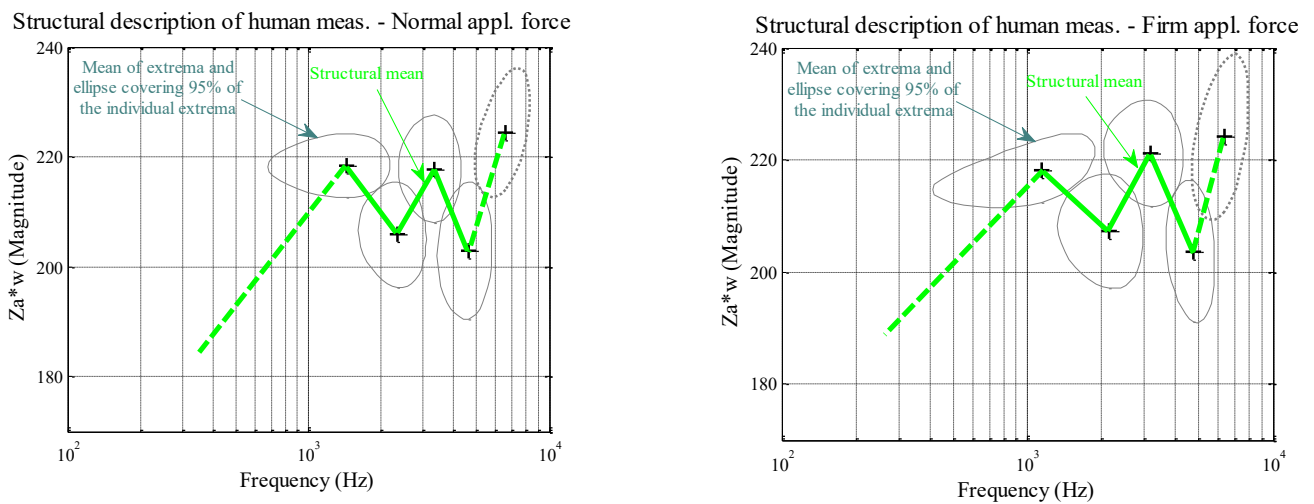

NOTE – The clouds of points shown in Figure I.10 are now represented by a bivariate mean and an ellipse covering 95% of the data points.

Figure I.11 – Structural representation of the individual human ear measurements for the normal application force case (left plot) and the firm application force case (right plot)

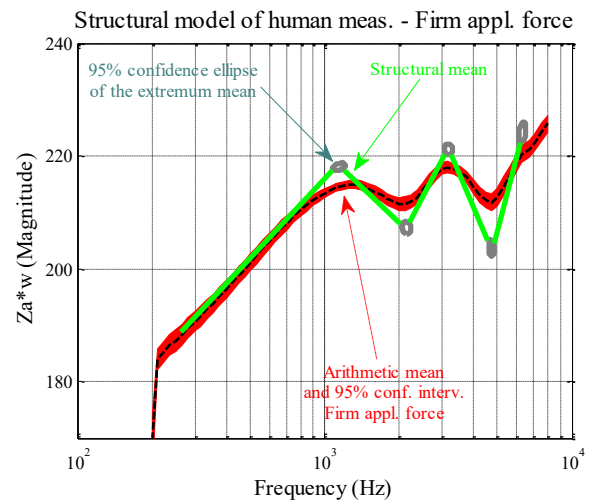
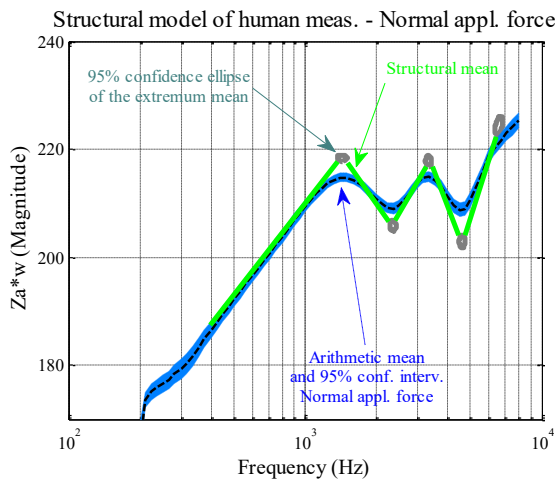

NOTE – The size of the ellipses represents now the 95% confidence level for the mean value of the extrema, which can be compared to the 95% confidence interval of the arithmetic mean represented by the width of the blue and red curves.

Figure I.12 – Comparison of the structural and arithmetic means of the individual human ear measurements for the normal application force case (left plot) and the firm application force case (right plot)

I.5 Comparison between human and artificial ear measurements

I.5.1 Univariate comparison of human and artificial ear measurements

The series of graphs presented in this clause summarizes the results of the set of round-robin test measurements made in this study from a univariate viewpoint. The graphs presented in Figures I.13 and I.14 compare the arithmetic means of the human ear measurements with the set of measurements made on the two artificial ear types at nine different application forces (from 2 to 18 N increasing by 2 N steps). Figure I.13 focuses on the measurements made on the artificial ear type 3.3 while Figure I.14 focuses on the type 3.4 ear. The curve shown on the left plot of each figure (blue curve) corresponds to the mean of the human ear measurements made with a normal application force and the curve shown on the right plot (red curve) corresponds to the mean of the human ear measurements made with a firm application force. The width of the red and blue curves represents the 95% confidence interval about the human ear measurement mean per frequency bin.

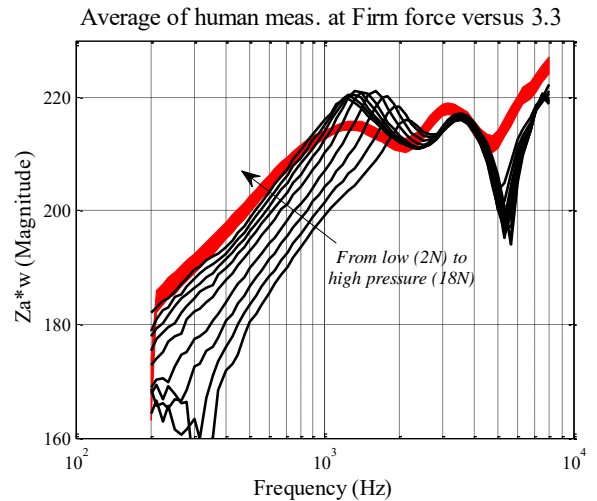
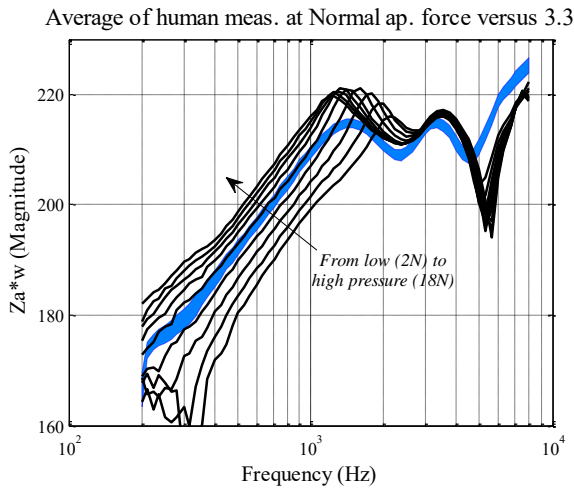

NOTE – The width of the red and blue curves represents the 95% confidence interval about the human ear measurement mean per frequency bin.

Figure I.13 – Comparison between the human ear measurements made with normal application force (left plot) and with firm application force (right plot) and the measurements made on the artificial ear type 3.3 at nine different application forces

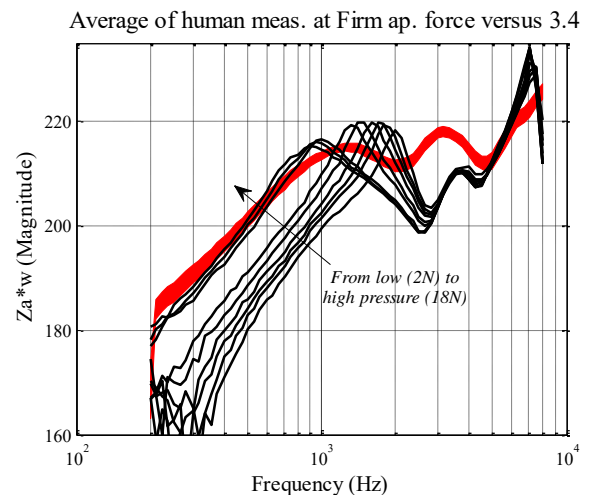
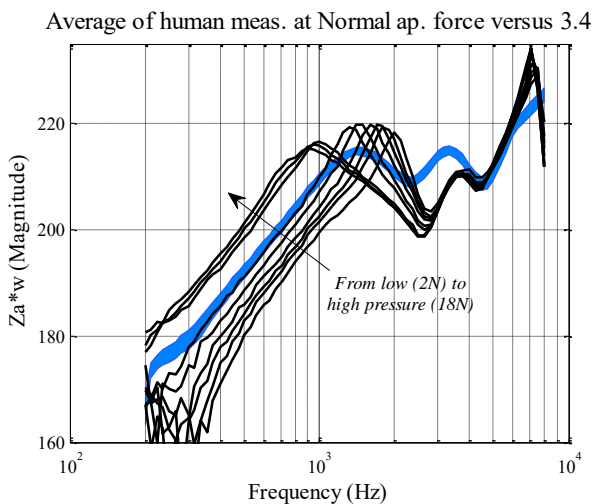

NOTE – The width of the red and blue curves represents the 95% confidence interval about the human ear measurement mean per frequency bin.

Figure I.14 – Comparison between the human ear measurements made with normal application force (left plot) and with firm application force (right plot) and the measurements made on the artificial ear type 3.4 at nine different application forces

I.5.2 Bivariate parametric comparison of human and artificial ear measurements

The series of graphs presented in this clause summarizes the results of the set of round-robin test measurements made in this study from a bivariate structural analysis viewpoint. The graphs presented in Figures I.15 and I.16 compare the structural model of the human ear measurements with the amplitude extrema of the two artificial ear types at nine different application forces (from 2 to 18 N increasing by 2 N steps). Figure I.15 focuses on the measurements made on the artificial ear type 3.3, while Figure I.16 focuses on the type 3.4 ear. The structural means shown in these graphs have been described in clause I.4.2, but it should be noted that the ellipses presented here describe the

distribution of the detected extrema, as in Figure I.11, and not the 95% confidence ellipse of the mean as in Figure I.12. These ellipses are better suited to visually check how well the amplitude extrema of a given artificial ear type and application force relates to the associated distribution of individual ear impedance extrema.

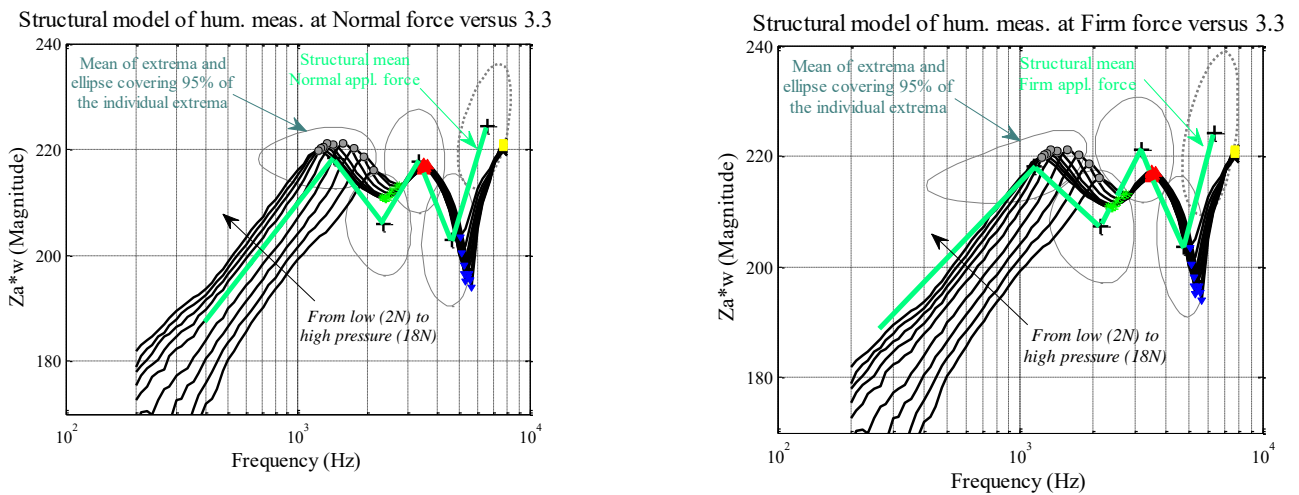

Figure I.15 – Comparison between the human ear measurements made with normal application force (left plot) and with firm application force (right plot) and the measurements made on the artificial ear type 3.3 at nine different application forces

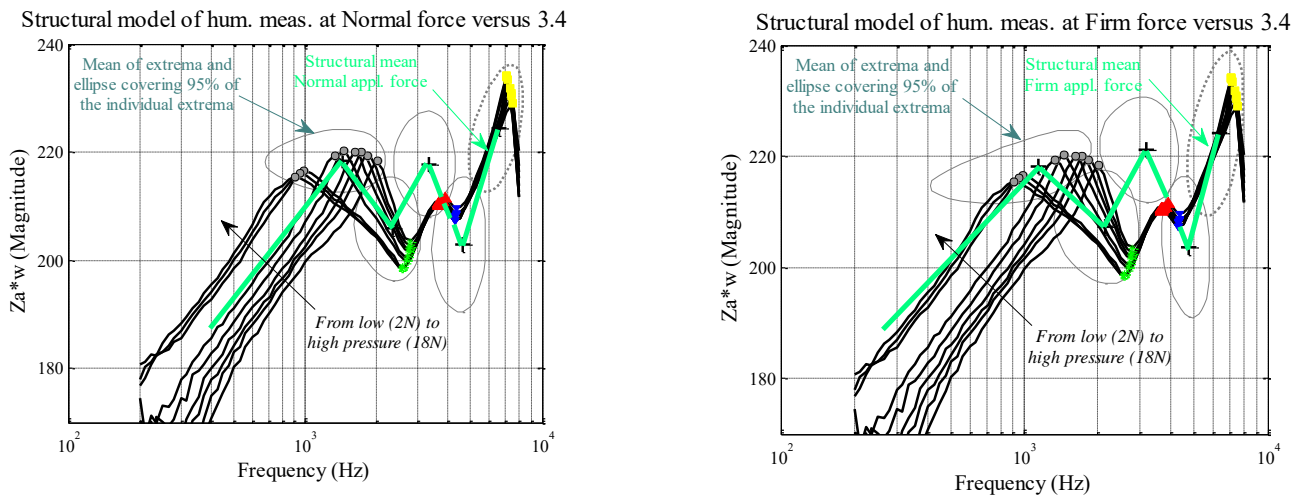
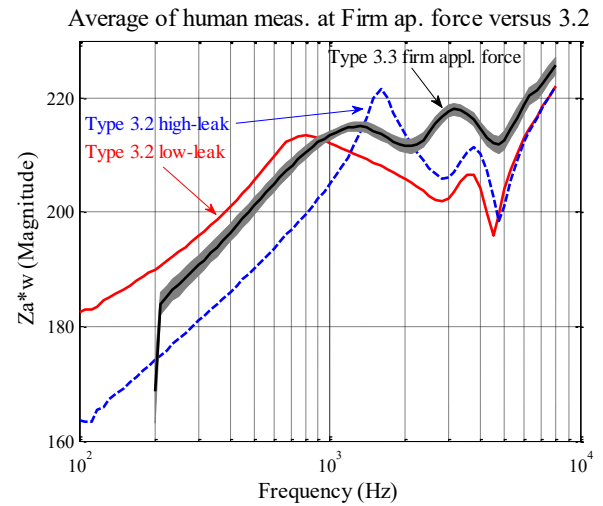
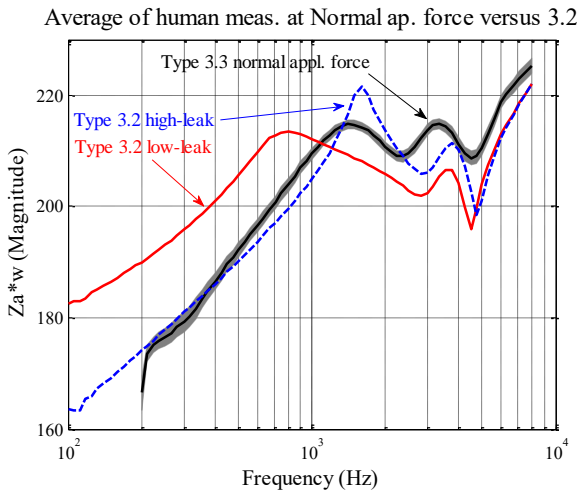

Figure I.16 – Comparison between the human ear measurements made with normal application force (left plot) and with firm application force (right plot) and the measurements made on the artificial ear type 3.4 at nine different application forces

I.5.3 Comparison between human measurements and type 3.2 artificial ear measurements

Included in this clause are the results of the human ear analysis described herein presented with the results of equivalent measurement on a type 3.2 low-leak (Figure I.17) and type 3.2 high-leak (Figure I.18) artificial ear. Artificial ear measurement data are supplied by Brüel & Kjær as a normative reference to the round-robin study results.



NOTE – The width of the gray curves represents the 95% confidence interval of the human ear measurement mean per frequency bin.

Figure I.17 – Comparison between the measurements made on the type 3.2 artificial ear and the human ear measurements made at normal application force (left plot) and at firm application force (right plot)

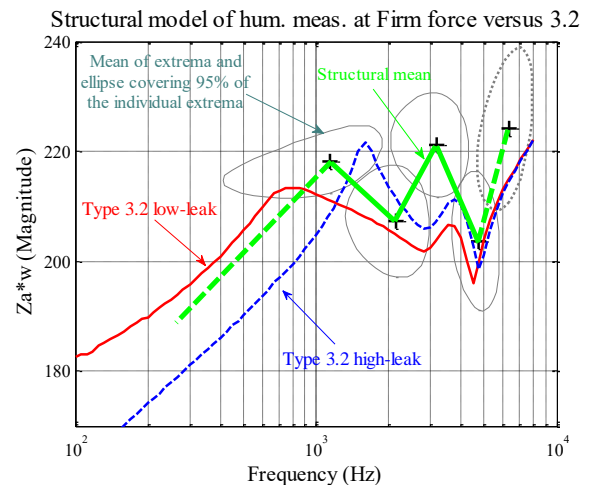
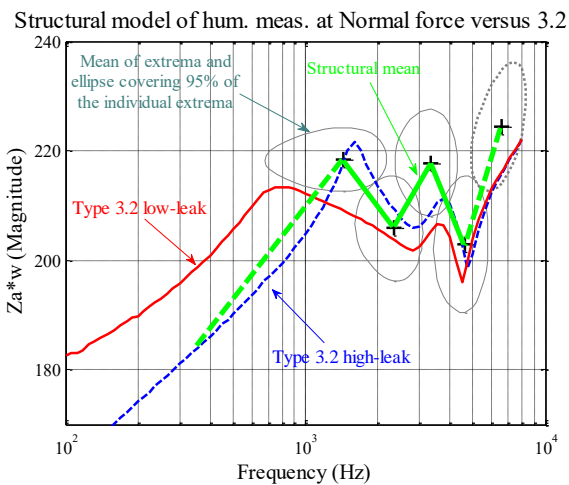
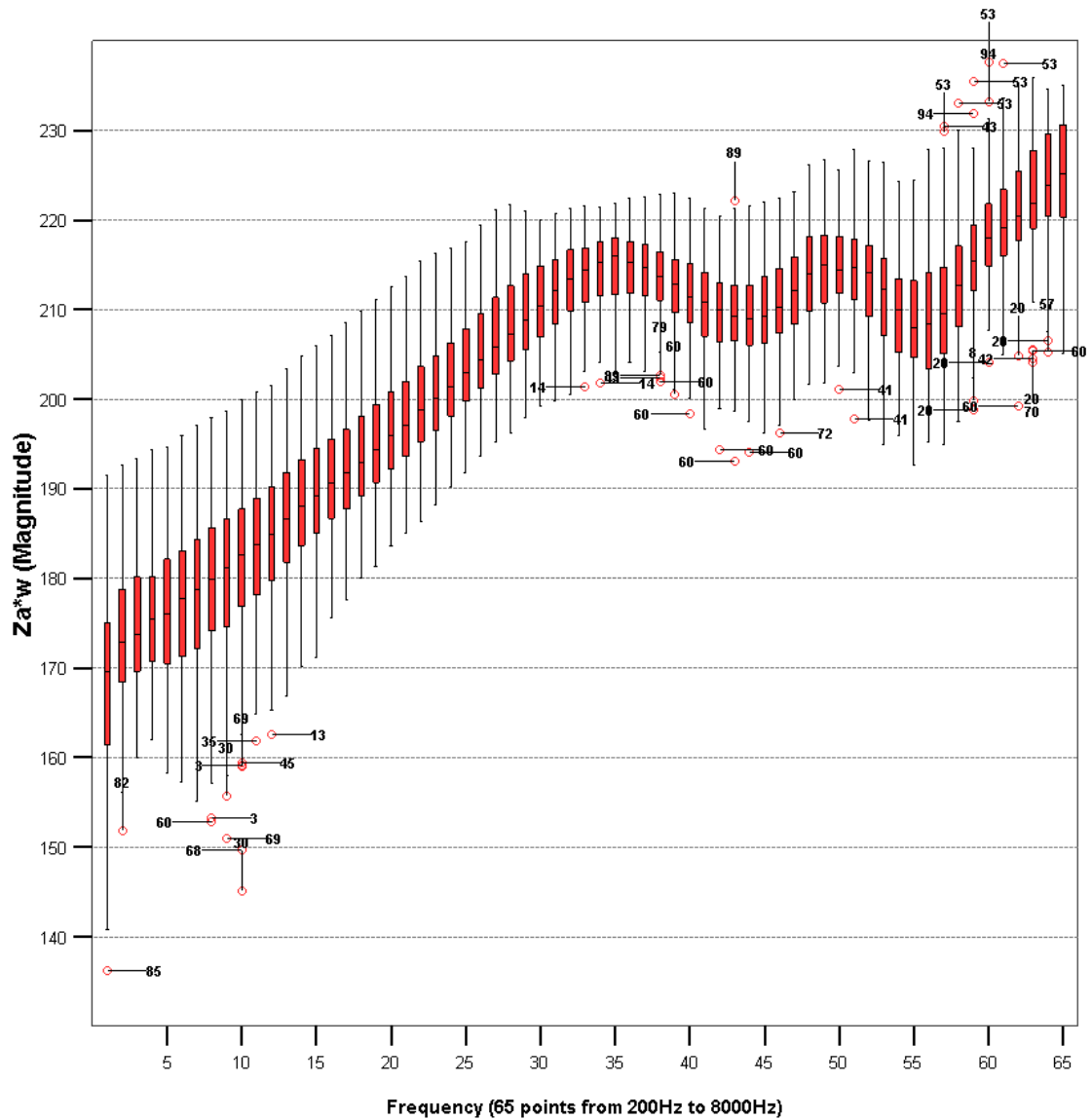

Figure I.18 – Comparison between the measurements made on the type 3.2 artificial ear and the structural model derived from the human ear measurements made at normal application force (left plot) and at firm application force (right plot)

I.5.4 Identification of outliers from the box plot analysis



NOTE – This box plot highlights the subject index of the outlier data points for the different frequency bins.

Figure I.19 – Human ear measurements in the normal application force case

I.5.5 Study of factor effects by univariate analysis of variance

Table I.2 – ANOVA applied separately to each frequency bin with the factors Lab (5 levels), Force (normal or firm), Subject (nested in Lab) and the interaction Lab × Force

Frequency	Lab		Force		Subject(Lab)		Lab*Force	
	F-ratio	Sig. Level	F-ratio	Sig. Level	F-ratio	Sig. Level	F-ratio	Sig. Level
200	14.05	***	0.07		2.42	***	9.52	***
212	0.87		194.66	***	4.14	***	6.09	***
224	1.19		252.54	***	5.48	***	7.37	***
236	1.09		262.33	***	5.72	***	7.04	***
250	1.17		266.93	***	6.13	***	8.42	***
265	1		292.44	***	6.54	***	8.07	***
280	1.16		289.59	***	6.77	***	7.08	***
300	1.15		312.74	***	7.06	***	6.27	***
315	1.03		318.61	***	7.5	***	6.8	***
335	1		271.04	***	6.53	***	5.53	***
355	1.19		303.78	***	6.76	***	6.13	***
375	1.27		306.91	***	6.9	***	6.67	***
400	1.44		314.48	***	6.68	***	6.72	***
425	1.51		307.64	***	6.61	***	6.08	***
450	1.57		313.85	***	6.63	***	6.74	***
475	1.64		311.82	***	6.55	***	6.53	***
500	1.74		313.5	***	6.53	***	6.32	***
530	1.74		309.54	***	6.48	***	6.22	***
560	1.79		295.51	***	6.32	***	5.58	***
600	1.82		280.43	***	6.02	***	5.04	***
630	1.79		276.86	***	5.92	***	4.46	**
670	1.69		253.77	***	5.73	***	3.67	**
710	1.56		230.31	***	5.44	***	3.34	*
750	1.45		204.23	***	5.08	***	2.78	*
800	1.26		168.08	***	4.46	***	2.02	
850	1.11		131.66	***	3.84	***	1.54	
900	0.98		98.74	***	3.24	***	1.17	
950	0.77		75.06	***	2.79	***	1.05	
1000	0.67		53.26	***	2.3	***	0.97	
1060	0.53		33.56	***	1.75	**	0.86	
1120	0.5		20.49	***	1.43	*	1.04	
1180	0.46		11.22	**	1.22		1.03	
1250	0.72		4.26	*	1.1		1.12	
1320	1.14		0.85		1.14		1.03	
1400	1.37		0.06		1.36		1.02	
1500	1.33		1.4		2.02	***	0.95	
1600	1.35		3.24		3.1	***	1.04	
1700	1.5		3.32		4.06	***	1.1	
1800	1.94		1.62		4.56	***	1.06	
1900	2.92	*	0.01		4.57	***	0.91	
2000	4.19	**	2.72		4.27	***	0.6	
2120	5.13	***	15.03	***	4.14	***	0.66	
2240	4.52	**	37.25	***	4.19	***	1.71	
2360	3.03	*	61.49	***	4.4	***	2.47	*
2500	1.9		90.8	***	4.99	***	3.08	*
2650	1.16		112.9	***	5.69	***	3.46	*
2800	0.81		110.26	***	5.61	***	3.92	**
3000	1		93.99	***	5.3	***	3.97	**
3150	1.74		73.31	***	4.75	***	3.08	*
3350	2.16		54.39	***	4.87	***	2.87	*
3550	2.16		52.21	***	6.13	***	3	*
3750	2.09		59.8	***	7.4	***	3.33	*
4000	2.45		59.15	***	6.77	***	4.02	**
4250	2.67	*	40.23	***	4.37	***	3.25	*
4500	2.46		24.17	***	2.62	***	2.6	*
4750	1.92		12.35	***	2.39	***	2.91	*
5000	1.15		5.11	*	2.24	***	1.83	
5300	0.44		2.61		2.51	***	0.66	
5600	0.26		0.97		2.65	***	0.4	
6000	0.24		0.01		2.86	***	0.47	
6300	0.05		0.28		2.69	***	0.71	
6700	0.41		0.1		3.05	***	1.07	
7100	0.42		0.29		3.5	***	1.01	
7500	0.49		0.04		3.55	***	1.02	
8000	0.11		0		3.64	***	1.36	

Significant levels are represented as follows: *, $P < 0.05$; **, $P < 0.01$; ***, $P < 0.001$.

Table I.3 – ANOVA applied separately to each frequency bin with the factors Gender (male or female), Force (normal or firm), Subject (nested in Gender) and the interaction Gender × Force

Frequency	Gender		Force		Subject(Gender)		Gender*Force	
	F-ratio	Sig. Level	F-ratio	Sig. Level	F-ratio	Sig. Level	F-ratio	Sig. Level
200	3.11		1.12		2.7	***	1.39	
212	0.83		154.63	***	3.43	***	0.37	
224	0.5		197.02	***	4.42	***	0.4	
236	0.88		212.18	***	4.66	***	1.02	
250	0.62		203.99	***	4.77	***	0.25	
265	0.71		227.42	***	5.17	***	1.54	
280	0.47		233.91	***	5.52	***	0.66	
300	0.28		261.01	***	5.9	***	0.31	
315	0.33		264.12	***	6.13	***	0.31	
335	0.12		237.12	***	5.55	***	0.01	
355	0.1		258.66	***	5.68	***	0.01	
375	0.13		256.6	***	5.72	***	0.23	
400	0.15		259.98	***	5.58	***	0.45	
425	0.12		259.59	***	5.64	***	0.39	
450	0.13		256.59	***	5.56	***	0.47	
475	0.07		256.78	***	5.56	***	0.62	
500	0.05		260.17	***	5.61	***	0.81	
530	0.05		256.53	***	5.61	***	1.2	
560	0.04		250.63	***	5.58	***	1.01	
600	0.01		242.4	***	5.43	***	1.13	
630	0.02		244.32	***	5.43	***	0.93	
670	0.04		231.23	***	5.37	***	0.85	
710	0.04		211.97	***	5.13	***	0.68	
750	0.06		191.94	***	4.84	***	0.31	
800	0.09		163.45	***	4.33	***	0.07	
850	0.12		131.71	***	3.77	***	0	
900	0.11		102.02	***	3.21	***	0.13	
950	0.15		80.16	***	2.76	***	0.43	
1000	0.22		58.52	***	2.29	***	0.78	
1060	0.42		38.46	***	1.73	**	1.13	
1120	0.56		24.14	***	1.41	*	1.33	
1180	0.78		14.14	***	1.19		1.21	
1250	1.07		6.24	*	1.08		1.57	
1320	1.19		1.94		1.16		1.97	
1400	1.93		0.08		1.38		2.41	
1500	4.29	*	0.42		2.01	***	2.1	
1600	8.97	**	1.68		2.91	***	0.95	
1700	14.81	***	1.93		3.61	***	0.15	
1800	20.78	***	0.94		3.92	***	0.07	
1900	23.28	***	0.01		4.05	***	1.01	
2000	21.04	***	2.67		4.16	***	2.96	
2120	15.19	***	13.44	***	4.43	***	4.69	*
2240	8.93	**	31.54	***	4.43	***	4.09	*
2360	3.93	*	52.23	***	4.41	***	2.08	
2500	1.06		79.06	***	4.75	***	0.53	
2650	0.11		99.94	***	5.22	***	0.01	
2800	0.06		96.8	***	5.01	***	0.1	
3000	0.13		84.83	***	4.78	***	0.89	
3150	0.05		71.82	***	4.58	***	1.58	
3350	2.7		55.36	***	4.65	***	0.57	
3550	7.42	**	52.43	***	5.55	***	0.13	
3750	11.98	***	55.3	***	6.33	***	0.02	
4000	16.43	***	48.86	***	5.54	***	0.64	
4250	15.9	***	34.94	***	3.71	***	0.26	
4500	8.05	**	23.84	***	2.42	***	0.26	
4750	1.46		14.56	***	2.35	***	3.54	
5000	0.09		7.59	**	2.32	***	6.23	*
5300	0.08		4.64	*	2.61	***	5.2	*
5600	0.91		1.48		2.65	***	1.42	
6000	1.14		0.01		2.81	***	0.08	
6300	1		0.03		2.62	***	0.98	
6700	0.22		0.59		3.02	***	1.61	
7100	0		0.72		3.46	***	1.2	
7500	0.19		0		3.49	***	0.67	
8000	0.83		0.18		3.46	***	0.75	

Significant levels are represented as follows: *, $P < 0.05$; **, $P < 0.01$; ***, $P < 0.001$.

Appendix II

Illustration of the mobile phone-shaped impedance probe used in Appendix I

(This appendix does not form an integral part of this Recommendation.)

Figures II.1 and II.2 illustrate the mobile phone-shaped impedance probe used in Appendix I.

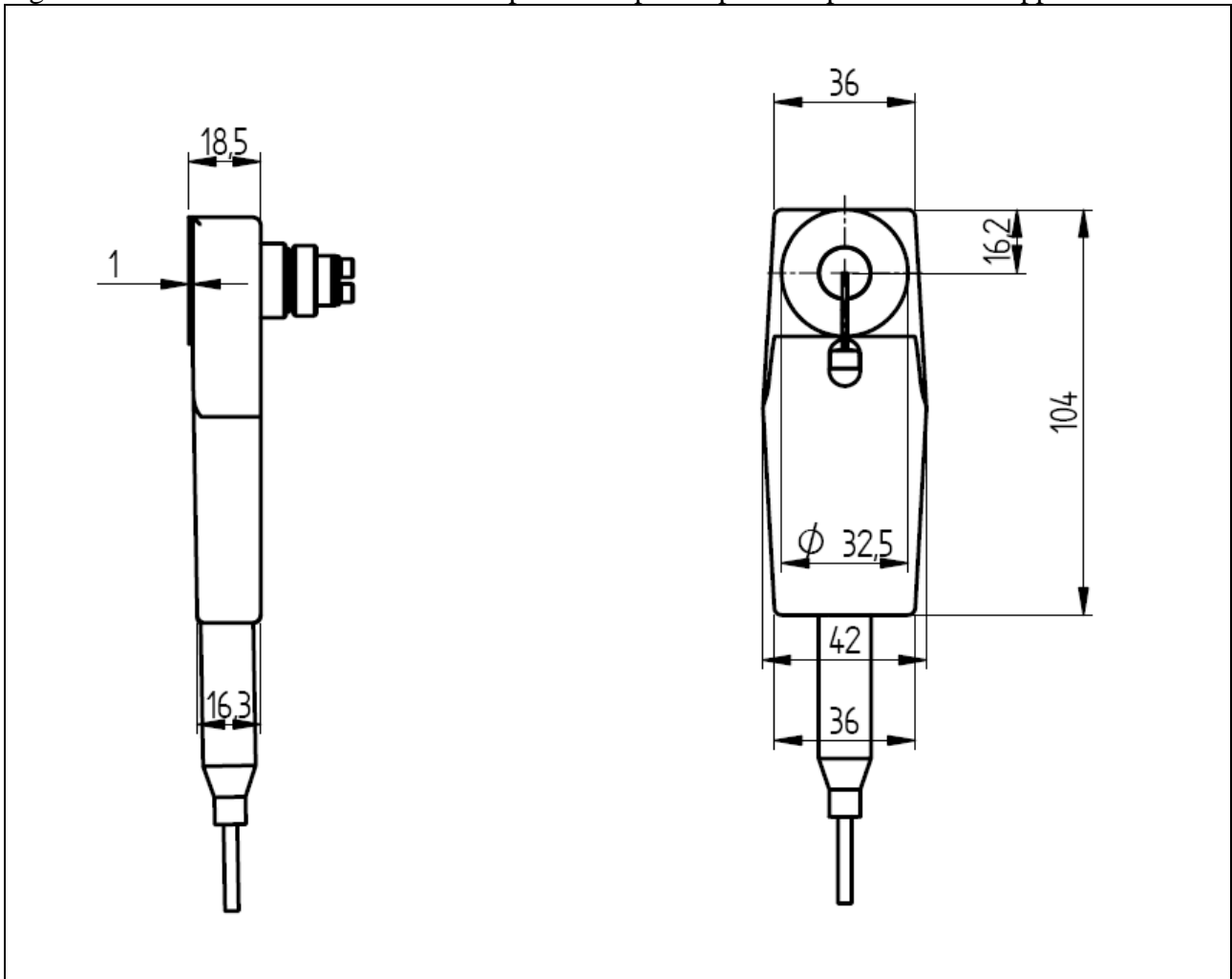

NOTE – All numbers indicate measures in mm.

Figure II.1 – The mobile phone shaped impedance probe viewed from the side and from the front

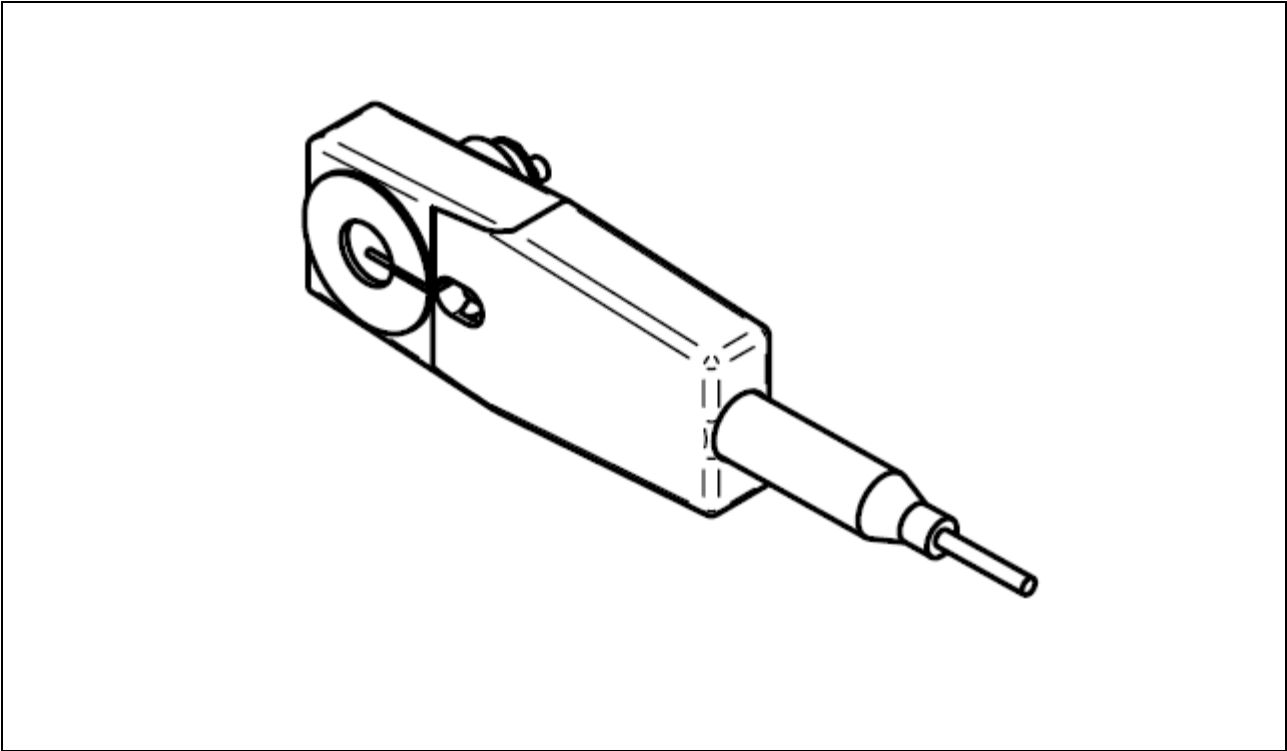

Figure II.2 – 3D view of the mobile phone-shaped impedance probe

Bibliography

- [b-ASTM D2240-15] ASTM D2240-15 (2021), *Standard Test Method for Rubber Property – Durometer Hardness*.
<<http://www.astm.org/Standards/D2240.htm>>
- [b-ISO 3] ISO 3:1973, *Preferred numbers – Series of preferred numbers*.
<http://www.iso.org/iso/iso_catalogue/catalogue_tc/catalogue_detail.htm?csnumber=3564>
- [b-ISO 48-4] ISO 48-4:2018, *Rubber, vulcanized or thermoplastic – Determination of hardness – Part 4: Indentation hardness by durometer method (Shore hardness)*.
<https://www.iso.org/standard/74969.html>

SERIES OF ITU-T RECOMMENDATIONS

Series A	Organization of the work of ITU-T
Series D	Tariff and accounting principles and international telecommunication/ICT economic and policy issues
Series E	Overall network operation, telephone service, service operation and human factors
Series F	Non-telephone telecommunication services
Series G	Transmission systems and media, digital systems and networks
Series H	Audiovisual and multimedia systems
Series I	Integrated services digital network
Series J	Cable networks and transmission of television, sound programme and other multimedia signals
Series K	Protection against interference
Series L	Environment and ICTs, climate change, e-waste, energy efficiency; construction, installation and protection of cables and other elements of outside plant
Series M	Telecommunication management, including TMN and network maintenance
Series N	Maintenance: international sound programme and television transmission circuits
Series O	Specifications of measuring equipment
Series P	Telephone transmission quality, telephone installations, local line networks
Series Q	Switching and signalling, and associated measurements and tests
Series R	Telegraph transmission
Series S	Telegraph services terminal equipment
Series T	Terminals for telematic services
Series U	Telegraph switching
Series V	Data communication over the telephone network
Series X	Data networks, open system communications and security
Series Y	Global information infrastructure, Internet protocol aspects, next-generation networks, Internet of Things and smart cities
Series Z	Languages and general software aspects for telecommunication systems