



INTERNATIONAL TELECOMMUNICATION UNION

**ITU-T**

TELECOMMUNICATION  
STANDARDIZATION SECTOR  
OF ITU

**Q.1902.3**

(07/2001)

SERIES Q: SWITCHING AND SIGNALLING

Specifications of signalling related to Bearer Independent  
Call Control (BICC)

---

**Bearer independent call control protocol  
(Capability Set 2) and Signalling System No. 7  
ISDN user part: Formats and codes**

ITU-T Recommendation Q.1902.3

---

ITU-T Q-SERIES RECOMMENDATIONS  
**SWITCHING AND SIGNALLING**

SIGNALLING IN THE INTERNATIONAL MANUAL SERVICE	Q.1–Q.3
INTERNATIONAL AUTOMATIC AND SEMI-AUTOMATIC WORKING	Q.4–Q.59
FUNCTIONS AND INFORMATION FLOWS FOR SERVICES IN THE ISDN	Q.60–Q.99
CLAUSES APPLICABLE TO ITU-T STANDARD SYSTEMS	Q.100–Q.119
SPECIFICATIONS OF SIGNALLING SYSTEMS No. 4 AND No. 5	Q.120–Q.249
SPECIFICATIONS OF SIGNALLING SYSTEM No. 6	Q.250–Q.309
SPECIFICATIONS OF SIGNALLING SYSTEM R1	Q.310–Q.399
SPECIFICATIONS OF SIGNALLING SYSTEM R2	Q.400–Q.499
DIGITAL EXCHANGES	Q.500–Q.599
INTERWORKING OF SIGNALLING SYSTEMS	Q.600–Q.699
SPECIFICATIONS OF SIGNALLING SYSTEM No. 7	Q.700–Q.799
Q3 INTERFACE	Q.800–Q.849
DIGITAL SUBSCRIBER SIGNALLING SYSTEM No. 1	Q.850–Q.999
PUBLIC LAND MOBILE NETWORK	Q.1000–Q.1099
INTERWORKING WITH SATELLITE MOBILE SYSTEMS	Q.1100–Q.1199
INTELLIGENT NETWORK	Q.1200–Q.1699
SIGNALLING REQUIREMENTS AND PROTOCOLS FOR IMT-2000	Q.1700–Q.1799
<b>SPECIFICATIONS OF SIGNALLING RELATED TO BEARER INDEPENDENT CALL CONTROL (BICC)</b>	<b>Q.1900–Q.1999</b>
BROADBAND ISDN	Q.2000–Q.2999

*For further details, please refer to the list of ITU-T Recommendations.*

**Bearer independent call control protocol (Capability Set 2) and  
Signalling System No. 7 ISDN user part: Formats and codes**

**Summary**

This Recommendation specifies the formats and codes of the Bearer Independent Call Control (BICC) protocol for the support of narrow-band ISDN services independent of the bearer technology and signalling message transport technology used. It also specifies ISDN user part messages and parameters required to support basic bearer services and supplementary services according to ITU-T Q.761.

**Source**

ITU-T Recommendation Q.1902.3 was prepared by ITU-T Study Group 11 (2001-2004) and approved under the WTSA Resolution 1 procedure on 2 July 2001. The modifications indicated in Corrigendum 1 (04/02) have already been included in this Recommendation.

## FOREWORD

The International Telecommunication Union (ITU) is the United Nations specialized agency in the field of telecommunications. The ITU Telecommunication Standardization Sector (ITU-T) is a permanent organ of ITU. ITU-T is responsible for studying technical, operating and tariff questions and issuing Recommendations on them with a view to standardizing telecommunications on a worldwide basis.

The World Telecommunication Standardization Assembly (WTSA), which meets every four years, establishes the topics for study by the ITU-T study groups which, in turn, produce Recommendations on these topics.

The approval of ITU-T Recommendations is covered by the procedure laid down in WTSA Resolution 1.

In some areas of information technology which fall within ITU-T's purview, the necessary standards are prepared on a collaborative basis with ISO and IEC.

## NOTE

In this Recommendation, the expression "Administration" is used for conciseness to indicate both a telecommunication administration and a recognized operating agency.

## INTELLECTUAL PROPERTY RIGHTS

ITU draws attention to the possibility that the practice or implementation of this Recommendation may involve the use of a claimed Intellectual Property Right. ITU takes no position concerning the evidence, validity or applicability of claimed Intellectual Property Rights, whether asserted by ITU members or others outside of the Recommendation development process.

As of the date of approval of this Recommendation, ITU had received notice of intellectual property, protected by patents, which may be required to implement this Recommendation. However, implementors are cautioned that this may not represent the latest information and are therefore strongly urged to consult the TSB patent database.

© ITU 2002

All rights reserved. No part of this publication may be reproduced or utilized in any form or by any means, electronic or mechanical, including photocopying and microfilm, without permission in writing from ITU.

## CONTENTS

	<b>Page</b>
1 Scope.....	1
2 References.....	1
3 Definitions .....	1
4 Abbreviations.....	1
5 General coding principles .....	3
5.1 Format of BICC messages .....	3
5.2 Format of ISDN user part messages .....	3
5.3 CIC.....	4
5.3.1 Call Instance Code (BICC only).....	4
5.3.2 Circuit Identification Code (ISUP only).....	4
5.4 Message type codes .....	5
5.5 Formatting principles.....	6
5.6 Mandatory fixed part .....	7
5.7 Mandatory variable part.....	7
5.8 Optional part .....	7
5.9 End of optional parameters octet .....	7
5.10 Order of transmission.....	7
5.11 Coding of the length indicator .....	8
5.12 Coding of the pointers.....	8
5.13 Coding of spare bits .....	9
5.14 National message types and parameters .....	9
5.15 Rules for the allocation of message type codes and parameter name codes.....	9
5.16 Meaning of "spare" and "reserved" codes .....	9
6 Parameters.....	9
6.1 Parameter names .....	9
6.2 Access delivery information .....	13
6.3 Access transport.....	13
6.4 Application transport parameter (APP) .....	14
6.5 Automatic congestion level .....	18
6.6 Backward call indicators.....	19
6.7 Backward GVNS .....	21
6.8 Call diversion information .....	21
6.9 Call diversion treatment indicators .....	22
6.10 Call history information.....	22

	<b>Page</b>
6.11 Call offering treatment indicators .....	22
6.12 Call reference (national use) .....	23
6.13 Call transfer number .....	23
6.14 Call transfer reference.....	25
6.15 Called directory number (national use) .....	25
6.16 Called IN number.....	27
6.17 Called party number.....	27
6.18 Calling geodetic location .....	29
6.18.1 Ellipsoid point shape description.....	30
6.18.2 Ellipsoid point with uncertainty shape description.....	31
6.18.3 Point with altitude and uncertainty shape description .....	31
6.18.4 Ellipse on the ellipsoid shape description.....	33
6.18.5 Ellipsoid circle sector shape description .....	34
6.18.6 Polygon shape description .....	35
6.18.7 Ellipsoid Point with Altitude shape description .....	36
6.18.8 Ellipsoid Point with Altitude and Uncertainty Ellipsoid shape description ..	36
6.18.9 Ellipsoid Arc.....	37
6.19 Calling party geodetic velocity information .....	38
6.19.1 Horizontal Velocity .....	39
6.19.2 Horizontal with Vertical Velocity .....	39
6.19.3 Horizontal Velocity with uncertainty .....	40
6.19.4 Horizontal with Vertical Velocity and Uncertainty.....	41
6.20 Calling party number .....	41
6.21 Calling party's category .....	43
6.22 Carrier selection information (national use) .....	44
6.23 Cause indicators .....	45
6.24 CCNR possible indicator .....	45
6.25 CCSS.....	45
6.26 Charged party identification (national use) .....	46
6.27 Circuit assignment map (ISUP only) .....	46
6.28 Circuit/CIC group supervision message type .....	46
6.29 Circuit/CIC state indicator (national use) .....	47
6.30 Closed user group interlock code.....	48
6.31 Coding decoding processing (ISUP only) .....	48
6.32 Collect call request.....	49
6.33 Conference treatment indicators .....	49
6.34 Connected number .....	50

	<b>Page</b>
6.35 Connection request (ISUP only).....	51
6.36 Continuity indicators.....	51
6.37 Correlation id.....	52
6.38 Display information.....	52
6.39 Echo control information.....	52
6.40 End of optional parameters.....	53
6.41 Event information.....	53
6.42 Facility indicator.....	54
6.43 Forward call indicators.....	54
6.44 Forward GVNS.....	55
6.45 Generic digits (national use).....	57
6.46 Generic notification indicator.....	58
6.47 Generic number.....	60
6.48 Global call reference.....	62
6.49 Hop counter.....	63
6.50 HTR information.....	63
6.51 Information indicators (national use).....	64
6.52 Information request indicators (national use).....	65
6.53 IN Service Compatibility.....	66
6.54 Inter-nodal Traffic Group Identifier.....	66
6.55 Location number.....	66
6.56 Loop prevention indicators.....	68
6.57 MCID request indicators.....	68
6.58 MCID response indicators.....	69
6.59 Message compatibility information.....	69
6.60 MLPP precedence.....	70
6.61 Nature of connection indicators.....	71
6.62 Network management controls.....	72
6.63 Network routing number (national use).....	72
6.64 Network specific facility (national use).....	73
6.65 Number portability forward information (network option).....	74
6.66 Optional backward call indicators.....	75
6.67 Optional forward call indicators.....	75
6.68 Original Called IN number.....	76
6.69 Original called number.....	76
6.70 Origination ISC point code.....	77

	<b>Page</b>	
6.71	Parameter compatibility information .....	77
6.72	Pivot capability .....	78
6.73	Pivot Counter .....	79
6.74	Pivot routing backward information .....	79
	6.74.1 Return to invoking exchange duration (national use).....	79
	6.74.2 Return to invoking exchange call identifier (national use).....	79
	6.74.3 Invoking pivot reason .....	79
6.75	Pivot routing forward information .....	80
	6.75.1 Return to invoking exchange possible (national use).....	80
	6.75.2 Return to invoking exchange call identifier (national use).....	80
	6.75.3 Performing pivot indicator.....	80
	6.75.4 Invoking pivot reason .....	81
6.76	Pivot routing indicators.....	81
6.77	Pivot status (national use).....	82
6.78	Propagation delay counter .....	82
6.79	Query on release capability (network option).....	83
6.80	Range and status .....	83
6.81	Redirect backward information (national use).....	84
	6.81.1 Return to invoking exchange duration.....	84
	6.81.2 Return to invoking exchange call identifier .....	84
	6.81.3 Invoking redirect reason .....	84
6.82	Redirect capability (national use) .....	85
6.83	Redirect counter (national use).....	85
6.84	Redirect forward information (national use) .....	85
	6.84.1 Return to invoking exchange possible.....	86
	6.84.2 Return to invoking exchange call identifier .....	86
	6.84.3 Performing redirect indicator.....	86
	6.84.4 Invoking redirect reason .....	87
6.85	Redirect status (national use).....	87
6.86	Redirecting number.....	87
6.87	Redirection information.....	88
6.88	Redirection number.....	89
6.89	Redirection number restriction .....	90
6.90	Remote operations (national use) .....	90
6.91	SCF id .....	98
6.92	Service activation.....	98
6.93	Signalling point code (national use) (ISUP only).....	99



	<b>Page</b>
6.94 Subsequent number .....	99
6.95 Suspend/resume indicators .....	99
6.96 Transit network selection (national use) .....	100
6.97 Transmission medium requirement .....	101
6.98 Transmission medium requirement prime .....	102
6.99 Transmission medium used .....	103
6.100 UID action indicators .....	103
6.101 UID capability indicators .....	103
6.102 User service information .....	104
6.103 User service information prime .....	104
6.104 User teleservice information .....	104
6.105 User-to-user indicators .....	105
6.106 User-to-user information .....	106
7 Messages .....	106
Annex A – Tables for handling of unrecognized parameter values .....	122
Annex B – General description of component encoding rules .....	130
B.1 General components structure .....	130
B.2 Tags .....	131
B.2.1 Tag class .....	131
B.2.2 Form of the information element .....	132
B.2.3 Tag code .....	132
B.3 Length of the contents .....	133
B.4 Contents .....	134
Annex C – Allocation of ISUP circuit identification codes .....	134



## ITU-T Recommendation Q.1902.3

### Bearer independent call control protocol (Capability Set 2) and Signalling System No. 7 ISDN user part: Formats and codes

#### 1 Scope

This Recommendation specifies the formats and codes of the Bearer Independent Call Control (BICC) protocol for the support of narrow-band ISDN services independent of the bearer technology and signalling message transport technology used. It also specifies ISDN user part messages and parameters required to support basic bearer services and supplementary services according to ITU-T Q.761. Where a message, a parameter, a parameter field or a parameter field value is not supported by one of the two protocols or they interpret a code point differently, it is indicated in this Recommendation.

#### 2 References

The following ITU-T Recommendations and other references contain provisions which, through reference in this text, constitute provisions of this Recommendation. At the time of publication, the editions indicated were valid. All Recommendations and other references are subject to revision; users of this Recommendation are therefore encouraged to investigate the possibility of applying the most recent edition of the Recommendations and other references listed below. A list of the currently valid ITU-T Recommendations is regularly published.

- [1] ITU-T Q.1902.1 (2001), *Bearer Independent Call Control protocol (Capability Set 2): Functional description*.

See ITU-T Q.1902.1 for all the references used within this Recommendation.

#### 3 Definitions

See ITU-T Q.1902.1.

#### 4 Abbreviations

This Recommendation uses the following abbreviations:

ASE	Application Service Element
ASN.1	Abstract Syntax Notation one
ATP	Access Transport Parameter
BCD	Binary Coded Decimal
CCBS	Completion of Calls to Busy Subscriber
CCNR	Completion of Calls on No Reply
CCSS	Completion of Calls Service Set-up
CIC	Call Instance Code
CIC	Circuit Identification Code
CUG	Closed User Group
DNIC	Data Network Identification Code

DPC	Destination Point Code
DSS1	Digital Subscriber Signalling System No. 1
ext.	Extension bit
FDM	Frequency Division Multiplex
GUG	GVNS User Group
GVNS	Global Virtual Network Service
HTR	Hard-To-Reach
IA5	International Alphabet No. 5
INAP	Intelligent Network Application Protocol
INN	Internal Network Number
ISC	International Switching Centre
ISDN	Integrated Services Digital Network
LFB	Look-ahead for Busy (from MLPP Supplementary Service)
LSB	Least Significant Bit
MCID	Malicious Call Identification
MLPP	Multi-Level Precedence and Preemption
MNIC	Mobile Network Identification Code
MSB	Most Significant Bit
NI	Network Identity
NI	Number Incomplete
NRN	Network Routing Number
O/E	Odd/Even
OPC	Originating Point Code
OPSP	Origination Participation Service Provider
PDU	Protocol Data Unit
PISN	Private ISDN
QoR	Query on Release
ROA	Registered Operating Agency
ROSE	Remote Operations Service Element
SCCP	Signalling Connection Control Part
SCF	Service Control Function
SLS	Signalling Link Selection
ST	End of pulsing signal (Stop Sending)
TAR	Temporary Alternative Routing
TCC	Telephony Country Code
TNRN	Terminating Network Routing Number
UID	User Interactive Dialogue

VPN Virtual Private Network

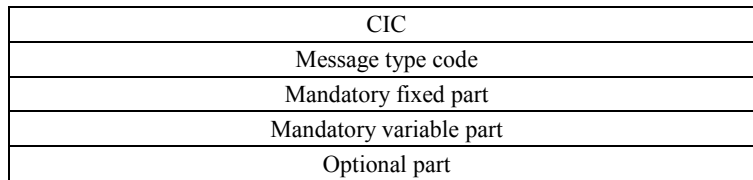
For further abbreviations, see ITU-T Q.1902.1.

## 5 General coding principles

### 5.1 Format of BICC messages

BICC messages are exchanged between peer protocol entities using the Generic Signalling Transport Service of the Signalling Transport Converter (STC) function, see ITU-T Q.2150.0. The BICC PDU consists of an integral number of octets and encompasses the following parts (see Figure 1):

- a) CIC;
- b) message type code;
- c) the mandatory fixed part;
- d) the mandatory variable part;
- e) the optional part, which may contain fixed length and variable length parameter fields.



**Figure 1/Q.1902.3 – BICC message (BICC PDU)**

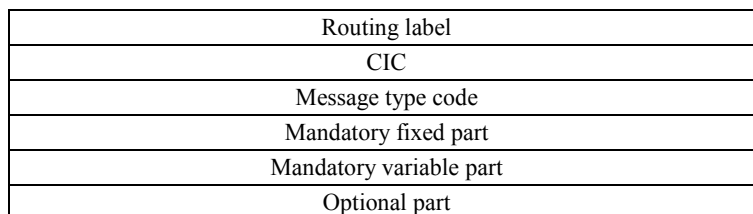
A description of the various parts is given in the following subclauses.

### 5.2 Format of ISDN user part messages

ISDN user part messages are carried on the signalling link by means of message signal units the format of which is described in 2.2/Q.703. The signalling information field of each message signal unit containing an ISDN user part message consists of the following parts (see Figure 2):

- a) routing label;
- b) CIC;
- c) message type code;
- d) the mandatory fixed part;
- e) the mandatory variable part;
- f) the optional part, which may contain fixed length and variable length parameter fields.

NOTE 1 – The service information octet, the routing label and circuit identification code are not included in the SCCP user data parameter transferred between the ISDN user part and signalling connection control part.



**Figure 2/Q.1902.3 – ISDN user part message**

The format and codes used for the routing label are described in 2.2/Q.704. For each individual circuit connection, the same routing label must be used for each message that is transmitted for that connection.

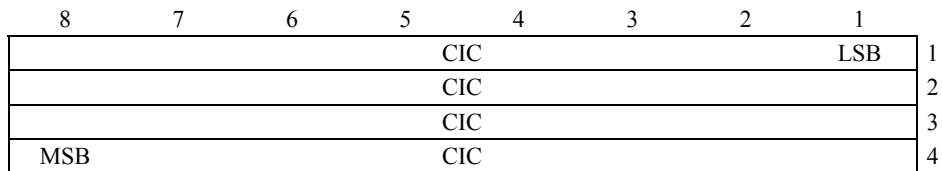
NOTE 2 – The SLS bits are set to the four least significant bits of the CIC.

### 5.3 CIC

The format and meaning of the CIC field is different in two protocols covered by this Recommendation. Its length, structure and usage are specified in the following subclauses. Throughout this Recommendation where CIC is mentioned, it should be interpreted depending on the protocol in which it is used. Furthermore, where a message, a parameter or a parameter field relates to either physical circuits controlled by ISDN user part or BICC instances the notation "circuit/CIC" is used.

#### 5.3.1 Call Instance Code (BICC only)

The Call Instance Code (CIC) in the BICC protocol is used to identify signalling relation between peer BICC entities and associate all the PDUs to that relation. The format of the CIC field in BICC is shown in Figure 3.

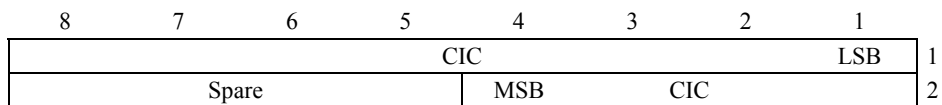


**Figure 3/Q.1902.3 – CIC field in BICC**

A bilateral agreement is required with regard to the CIC values provisioned. The total number of provisioned CIC values for any particular signalling association shall indicate the maximum number of peer-call signalling relations between the BICC peer entities.

#### 5.3.2 Circuit Identification Code (ISUP only)

The format of the Circuit Identification Code (CIC) in ISUP is shown in Figure 4.



**Figure 4/Q.1902.3 – CIC field in ISUP**

The allocation of circuit identification codes to individual circuits is determined by bilateral agreement and/or in accordance with applicable predetermined rules.

For international applications, the four spare bits of the circuit identification field are reserved for CIC extension, provided that bilateral agreement is obtained before any increase in size is performed. For national applications, the four spare bits can be used as required.

Allocations of circuit identification codes for certain applications are defined in Annex C.

## 5.4 Message type codes

The message type code consists of a one-octet field and is mandatory for all messages. The message type code uniquely defines the function and format of each BICC PDU and/or ISDN User Part message.

The allocation with reference to the appropriate descriptive tables in this Recommendation is summarized in Table 1. Code points marked as "ISUP only" in this table are reserved in BICC.

**Table 1/Q.1902.3 – Message type codes**

Message type	Reference	Code	Note
Address complete	Table 18	0 0 0 0 0 1 1 0	
Answer	Table 19	0 0 0 0 1 0 0 1	
Application transport	Table 20	0 1 0 0 0 0 0 1	
Blocking	Table 21	0 0 0 1 0 0 1 1	ISUP only
Blocking acknowledgement	Table 21	0 0 0 1 0 1 0 1	ISUP only
Call progress	Table 22	0 0 1 0 1 1 0 0	
Circuit/CIC group blocking	Table 23	0 0 0 1 1 0 0 0	
Circuit/CIC group blocking acknowledgement	Table 23	0 0 0 1 1 0 1 0	
Circuit/CIC group query (national use)	Table 24	0 0 1 0 1 0 1 0	
Circuit/CIC group query response (national use)	Table 25	0 0 1 0 1 0 1 1	
Circuit/CIC group reset	Table 24	0 0 0 1 0 1 1 1	
Circuit/CIC group reset acknowledgement	Table 26	0 0 1 0 1 0 0 1	
Circuit/CIC group unblocking	Table 23	0 0 0 1 1 0 0 1	
Circuit/CIC group unblocking acknowledgement	Table 23	0 0 0 1 1 0 1 1	
Charge information (national use)	(Note)	0 0 1 1 0 0 0 1	
Confusion	Table 27	0 0 1 0 1 1 1 1	
Connect	Table 28	0 0 0 0 0 1 1 1	
Continuity	Table 29	0 0 0 0 0 1 0 1	
Continuity check request	Table 21	0 0 0 1 0 0 0 1	ISUP only
Facility	Table 30	0 0 1 1 0 0 1 1	
Facility accepted	Table 31	0 0 1 0 0 0 0 0	
Facility reject	Table 32	0 0 1 0 0 0 0 1	
Facility request	Table 31	0 0 0 1 1 1 1 1	
Forward transfer	Table 33	0 0 0 0 1 0 0 0	
Identification request	Table 34	0 0 1 1 0 1 1 0	
Identification response	Table 35	0 0 1 1 0 1 1 1	
Information (national use)	Table 36	0 0 0 0 0 1 0 0	
Information request (national use)	Table 37	0 0 0 0 0 0 1 1	
Initial address	Table 38	0 0 0 0 0 0 0 1	
Loop back acknowledgement (national use)	Table 21	0 0 1 0 0 1 0 0	ISUP only
Loop prevention	Table 39	0 1 0 0 0 0 0 0	
Network resource management	Table 40	0 0 1 1 0 0 1 0	

**Table 1/Q.1902.3 – Message type codes**

Message type	Reference	Code	Note
Overload (national use)	Table 21	0 0 1 1 0 0 0 0	ISUP only
Pass-along (national use)	Table 41	0 0 1 0 1 0 0 0	ISUP only
Pre-release information	Table 42	0 1 0 0 0 0 1 0	
Release	Table 43	0 0 0 0 1 1 0 0	
Release complete	Table 44	0 0 0 1 0 0 0 0	
Reset circuit/CIC	Table 21	0 0 0 1 0 0 1 0	
Resume	Table 45	0 0 0 0 1 1 1 0	
Segmentation	Table 46	0 0 1 1 1 0 0 0	
Subsequent address	Table 47	0 0 0 0 0 0 1 0	
Subsequent Directory Number (national use)	Table 48	0 1 0 0 0 0 1 1	
Suspend	Table 45	0 0 0 0 1 1 0 1	
Unblocking	Table 21	0 0 0 1 0 1 0 0	ISUP only
Unblocking acknowledgement	Table 21	0 0 0 1 0 1 1 0	ISUP only
Unequipped CIC (national use)	Table 21	0 0 1 0 1 1 1 0	
User Part available	Table 49	0 0 1 1 0 1 0 1	ISUP only
User Part test	Table 49	0 0 1 1 0 1 0 0	ISUP only
User-to-user information	Table 50	0 0 1 0 1 1 0 1	
Reserved		0 0 0 0 1 0 1 0 0 0 0 0 1 0 1 1 0 0 0 0 1 1 1 1 0 0 1 0 0 0 1 0 0 0 1 0 0 0 1 1 0 0 1 0 0 1 0 1 0 0 1 0 0 1 1 0	used in 1984 version ( <i>Red Book</i> ) ISUP
Reserved		0 0 0 1 1 1 0 1 0 0 0 1 1 1 0 0 0 0 0 1 1 1 1 0 0 0 1 0 0 1 1 1	used in 1988 version ( <i>Blue Book</i> ) ISUP
Reserved		0 0 1 1 1 0 0 1 to 0 0 1 1 1 1 0 1	used in B-ISUP
Reserved for future extension		1 0 0 0 0 0 0 0	
NOTE – The format of this message is a national matter.			

## 5.5 Formatting principles

Each message consists of a number of PARAMETERS listed and described in clause 6. Each parameter has a NAME which is coded as a single octet (see Table 2). The length of a parameter may be fixed or variable, and a LENGTH INDICATOR of one octet for each parameter may be included as described below.



The detailed format is uniquely defined for each message type as described in clause 7.

Between parameters there should be no unused (i.e. dummy) octets.

A general format diagram is shown in Figure 5.

### **5.6 Mandatory fixed part**

Those parameters that are mandatory and of fixed length for a particular message type will be contained in the *mandatory fixed part*. The position, length and order of the parameters is uniquely defined by the message type; thus, the names of the parameters and the length indicators are not included in the message.

### **5.7 Mandatory variable part**

Mandatory parameters of variable length will be included in the *mandatory variable part*. Pointers are used to indicate the beginning of each parameter. Each pointer is encoded as a single octet. The name of each parameter and the order in which the pointers are sent is implicit in the message type. Parameter names are, therefore, not included in the message. The details of how pointers are encoded is found in 5.12. The number of parameters, and thus the number of pointers, is uniquely defined by the message type.

A pointer is also included to indicate the beginning of the optional part. If the message type indicates that no optional part is allowed, then this pointer will not be present. If the message type indicates that an optional part is possible (reflected by the presence of an "end of optional parameter" octet in Tables 18 through 50), but there is no optional part included in this particular message, then a pointer field containing all zeros will be used. It is recommended that all future message types with a mandatory variable part indicate that an optional part is allowed.

All the pointers are sent consecutively at the beginning of the mandatory variable part. Each parameter contains the parameter length indicator followed by the contents of the parameters. If there are no mandatory variable parameters, but optional parameters are possible, the start of optional parameters pointer (coded all "0"s if no optional parameter is present and coded "0000 0001" if any optional parameter is present) will be included.

### **5.8 Optional part**

The optional part consists of parameters that may or may not occur in any particular message type. Both fixed length and variable length parameters may be included. Unless it is explicitly stated to the contrary within this Recommendation, an optional parameter cannot occur multiple times within one message. Optional parameters may be transmitted in any order. Each optional parameter will include the parameter name (one octet) and the length indicator (one octet) followed by the parameter contents.

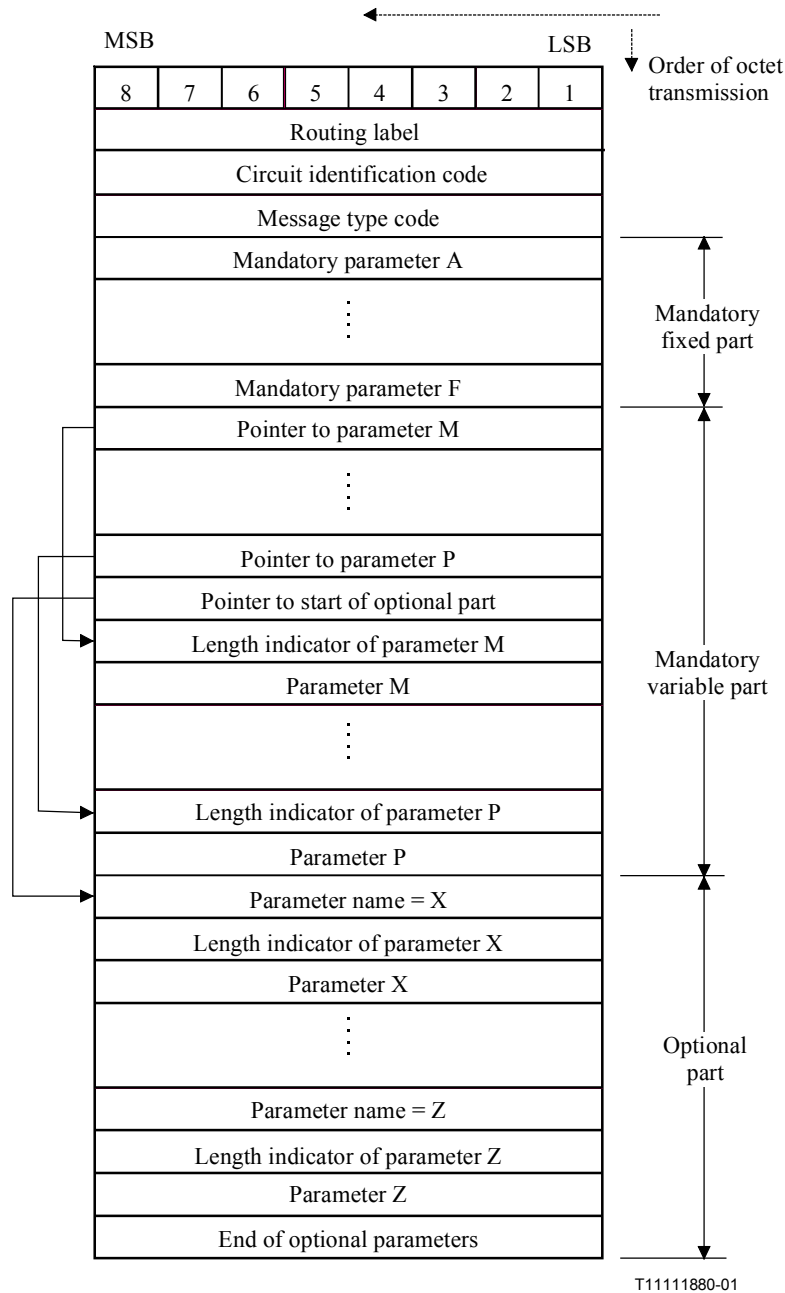
### **5.9 End of optional parameters octet**

If optional parameters are present and after all optional parameters have been sent, an "end of optional parameters" octet containing all zeros will be transmitted. If no optional parameter is present, an "end of optional parameters" octet is not transmitted.

### **5.10 Order of transmission**

Since all the fields consist of an integral number of octets, the formats are presented as a stack of octets. The first octet transmitted is the one shown at the top of the stack and the last is the one at the bottom (see Figure 5).

Unless otherwise indicated, within each octet and subfield the bits are transmitted with the least significant bit first.



**Figure 5/Q.1902.3 – General BICC PDU format overview**

### 5.11 Coding of the length indicator

The length indicator field is binary coded to indicate the number of octets in the parameter content field. The length indicated does not include the parameter name octet or the length indicator octet.

### 5.12 Coding of the pointers

The pointer value (in binary) gives the number of octets between the pointer itself (included) and the first octet (not included) of the parameter associated with that pointer.

The pointer value all zeros is used to indicate that, in the case of optional parameters, no optional parameter is present.

### 5.13 Coding of spare bits

Spare bits are coded 0 unless indicated otherwise.

### 5.14 National message types and parameters

If message type codes and parameter name codes are required for national uses not included in this Recommendation, the codes chosen should be from the highest code downwards, that is, starting at code 1111\_1111. Message type codes in the range 1111\_1111 to 1110\_0000 and parameter name codes in the range 1111\_1111 to 1100\_0001 are reserved exclusively for national use.

### 5.15 Rules for the allocation of message type codes and parameter name codes

Message type codes in Table 1 and parameter name codes in Table 2 are allocated from the same pool of values to not only BICC and ISUP, but also B-ISUP (see ITU-T Q.2763). Therefore, B-ISUP message and parameter codes not used by either BICC or ISUP should be marked reserved.

### 5.16 Meaning of "spare" and "reserved" codes

a) Spare code: A code is indicated in this Recommendation as:

- spare;
- spare for international use; or
- spare for national use.

A code indicated as "spare" or "spare for international use" is a code available for future ITU-T use.

A code indicated as "spare for national use" is not available for ITU-T use.

b) Reserved code: A code may have been reserved in this Recommendation because of:

- a previous Recommendation;
- an intended usage (however, procedures have not been developed); or
- national use.

A code reserved for a previous Recommendation (e.g. *Blue Book*) is not available for future use.

A code reserved for an intended use (e.g. for future extension) will be specified when the intended procedures are developed.

A code reserved for national use is not available for ITU-T use.

## 6 Parameters

### 6.1 Parameter names

The parameter name codes are given in Table 2 together with references to the clauses in which they are described. Code points marked as "ISUP only" in this table are reserved in BICC.

**Table 2/Q.1902.3 – Parameter name codes**

<b>Parameter name</b>	<b>Reference (clause)</b>	<b>Code</b>	<b>Note</b>
Access delivery information	6.2	0 0 1 0 1 1 1 0	
Access transport	6.3	0 0 0 0 0 0 1 1	
Application transport	6.4	0 1 1 1 1 0 0 0	
Automatic congestion level	6.5	0 0 1 0 0 1 1 1	
Backward call indicators	6.6	0 0 0 1 0 0 0 1	
Backward GVNS	6.7	0 1 0 0 1 1 0 1	
Call diversion information	6.8	0 0 1 1 0 1 1 0	
Call diversion treatment indicators	6.9	0 1 1 0 1 1 1 0	
Call history information	6.10	0 0 1 0 1 1 0 1	
Call offering treatment indicators	6.11	0 1 1 1 0 0 0 0	
Call reference (national use)	6.12	0 0 0 0 0 0 0 1	
Call transfer number	6.13	0 1 0 0 0 1 0 1	
Call transfer reference	6.14	0 1 0 0 0 0 1 1	
Called directory number (national use)	6.15	0 1 1 1 1 1 0 1	
Called IN number	6.16	0 1 1 0 1 1 1 1	
Called party number	6.17	0 0 0 0 0 1 0 0	
Calling geodetic location	6.18	1 0 0 0 0 0 0 1	
Calling party geodetic velocity information	6.19	1 0 0 0 0 0 1 1	
Calling party number	6.20	0 0 0 0 1 0 1 0	
Calling party's category	6.21	0 0 0 0 1 0 0 1	
Carrier selection information (national use)	6.22	1 0 1 0 0 0 0 1	
Cause indicators	6.23	0 0 0 1 0 0 1 0	
CCNR possible indicator	6.24	0 1 1 1 1 0 1 0	
CCSS	6.25	0 1 0 0 1 0 1 1	
Charged party identification (national use)	6.26	0 1 1 1 0 0 0 1	
Circuit assignment map	6.27	0 0 1 0 0 1 0 1	ISUP only
Circuit/CIC group supervision message type	6.28	0 0 0 1 0 1 0 1	
Circuit/CIC state indicator (national use)	6.29	0 0 1 0 0 1 1 0	
Closed user group interlock code	6.30	0 0 0 1 1 0 1 0	
Coding decoding processing	6.31	1 0 1 0 0 1 0 1	ISUP only
Collect call request	6.32	0 1 1 1 1 0 0 1	
Conference treatment indicators	6.33	0 1 1 1 0 0 1 0	
Connected number	6.34	0 0 1 0 0 0 0 1	
Connection request	6.35	0 0 0 0 1 1 0 1	ISUP only
Continuity indicators	6.36	0 0 0 1 0 0 0 0	
Correlation id	6.37	0 1 1 0 0 1 0 1	
Display information	6.38	0 1 1 1 0 0 1 1	

**Table 2/Q.1902.3 – Parameter name codes**

<b>Parameter name</b>	<b>Reference (clause)</b>	<b>Code</b>	<b>Note</b>
Echo control information	6.39	0 0 1 1 0 1 1 1	
End of optional parameters	6.40	0 0 0 0 0 0 0 0	
Event information	6.41	0 0 1 0 0 1 0 0	
Facility indicator	6.42	0 0 0 1 1 0 0 0	
Forward call indicators	6.43	0 0 0 0 0 1 1 1	
Forward GVNS	6.44	0 1 0 0 1 1 0 0	
Generic digits (national use)	6.45	1 1 0 0 0 0 0 1	
Generic notification indicator	6.46	0 0 1 0 1 1 0 0	
Generic number	6.47	1 1 0 0 0 0 0 0	
Global call reference	6.48	1 0 1 0 0 1 0 0	
Hop counter	6.49	0 0 1 1 1 1 0 1	
HTR information	6.50	1 0 0 0 0 0 1 0	
Information indicators (national use)	6.51	0 0 0 0 1 1 1 1	
Information request indicators (national use)	6.52	0 0 0 0 1 1 1 0	
IN Service Compatibility	6.53	1 0 1 0 0 0 1 0	
Inter-Nodal Traffic Group Identifier	6.54	1 0 1 0 0 0 1 1	
Location number	6.55	0 0 1 1 1 1 1 1	
Loop prevention indicators	6.56	0 1 0 0 0 1 0 0	
MCID request indicators	6.57	0 0 1 1 1 0 1 1	
MCID response indicators	6.58	0 0 1 1 1 1 0 0	
Message compatibility information	6.59	0 0 1 1 1 0 0 0	
MLPP precedence	6.60	0 0 1 1 1 0 1 0	
Nature of connection indicators	6.61	0 0 0 0 0 1 1 0	
Network management controls	6.62	0 1 0 1 1 0 1 1	
Network routing number (national use)	6.63	1 0 0 0 0 1 0 0	
Network specific facility (national use)	6.64	0 0 1 0 1 1 1 1	
Number portability forward information (network opt.)	6.65	1 0 0 0 1 1 0 1	
Optional backward call indicators	6.66	0 0 1 0 1 0 0 1	
Optional forward call indicators	6.67	0 0 0 0 1 0 0 0	
Original called IN number	6.68	0 1 1 1 1 1 1 1	
Original called number	6.69	0 0 1 0 1 0 0 0	
Origination ISC point code	6.70	0 0 1 0 1 0 1 1	
Parameter compatibility information	6.71	0 0 1 1 1 0 0 1	
Pivot capability	6.72	0 1 1 1 1 0 1 1	
Pivot counter	6.73	1 0 0 0 0 1 1 1	
Pivot routing backward information	6.74	1 0 0 0 1 0 0 1	
Pivot routing forward information	6.75	1 0 0 0 1 0 0 0	

**Table 2/Q.1902.3 – Parameter name codes**

Parameter name	Reference (clause)	Code	Note
Pivot routing indicators	6.76	0 1 1 1 1 1 0 0	
Pivot status (national use)	6.77	1 0 0 0 0 1 1 0	
Propagation delay counter	6.78	0 0 1 1 0 0 0 1	
Query on release capability (network option)	6.79	1 0 0 0 0 1 0 1	
Range and status	6.80	0 0 0 1 0 1 1 0	
Redirect backward information (national use)	6.81	1 0 0 0 1 1 0 0	
Redirect capability (national use)	6.82	0 1 0 0 1 1 1 0	
Redirect counter (national use)	6.83	0 1 1 1 0 1 1 1	
Redirect forward information (national use)	6.84	1 0 0 0 1 0 1 1	
Redirect status (national use)	6.85	1 0 0 0 1 0 1 0	
Redirecting number	6.86	0 0 0 0 1 0 1 1	
Redirection information	6.87	0 0 0 1 0 0 1 1	
Redirection number	6.88	0 0 0 0 1 1 0 0	
Redirection number restriction	6.89	0 1 0 0 0 0 0 0	
Remote operations (national use)	6.90	0 0 1 1 0 0 1 0	
SCF id	6.91	0 1 1 0 0 1 1 0	
Service activation	6.92	0 0 1 1 0 0 1 1	
Signalling point code (national use)	6.93	0 0 0 1 1 1 1 0	ISUP only
Subsequent number	6.94	0 0 0 0 0 1 0 1	
Suspend/Resume indicators	6.95	0 0 1 0 0 0 1 0	
Transit network selection (national use)	6.96	0 0 1 0 0 0 1 1	
Transmission medium requirement	6.97	0 0 0 0 0 0 1 0	
Transmission medium requirement prime	6.98	0 0 1 1 1 1 1 0	
Transmission medium used	6.99	0 0 1 1 0 1 0 1	
UID action indicators	6.100	0 1 1 1 0 1 0 0	
UID capability indicators	6.101	0 1 1 1 0 1 0 1	
User service information	6.102	0 0 0 1 1 1 0 1	
User service information prime	6.103	0 0 1 1 0 0 0 0	
User teleservice information	6.104	0 0 1 1 0 1 0 0	
User-to-user indicators	6.105	0 0 1 0 1 0 1 0	
User-to-user information	6.106	0 0 1 0 0 0 0 0	
Reserved		0 0 0 1 0 1 0 0 0 0 0 1 1 0 0 1 0 0 0 1 1 0 1 1 0 0 0 1 1 1 0 0 0 0 0 1 1 1 1 1	used in 1984 version (Red Book) ISUP

**Table 2/Q.1902.3 – Parameter name codes**

Parameter name	Reference (clause)	Code	Note
Reserved		0 0 0 1 0 1 1 1	used in 1988 version ( <i>Blue Book</i> ) ISUP
Reserved		0 1 0 0 0 0 0 1 0 1 0 0 0 0 1 0	used in ISUP'92
Reserved for future extension		1 0 0 0 0 0 0 0	

The following codes are reserved for use in B-ISUP:

0100 0110 to 0100 1010, 0100 1111 to 0101 1010, 0101 1100 to 0110 0100, 0110 0111 to 0110 1101, 0111 0110, 0111 1110, 1000 1111 to 1001 1000.

### 6.2 Access delivery information

The format of the access delivery information parameter field is shown in Figure 6.

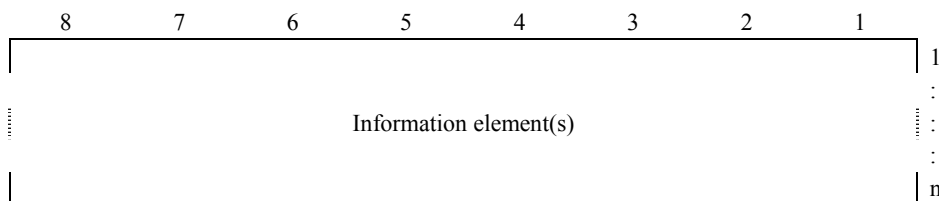


**Figure 6/Q.1902.3 – Access delivery information parameter field**

- bit A: *Access delivery indicator*
- 0 set-up message generated
- 1 no set-up message generated
- bits H-B *Spare*

### 6.3 Access transport

The format of the access transport parameter field is shown in Figure 7.

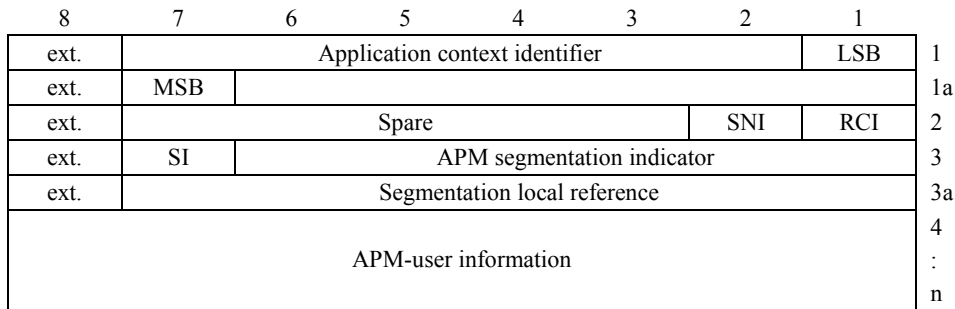


**Figure 7/Q.1902.3 – Access transport parameter field**

The information element is coded as described in 4.5/Q.931. Multiple Q.931 information elements can be included within the access transport parameter. The information elements applicable to a particular usage of the access transport parameter are dependent on, and will be determined by, the relevant procedures. The maximum length of the access transport parameter should only be limited by the message length as the content of the ATP will probably evolve in the future.

#### 6.4 Application transport parameter (APP)

The format of the application transport parameter field is shown in Figure 8.



**Figure 8/Q.1902.3 – Application transport parameter field**

The following codes are used in the application transport parameter field:

- a) *Extension indicator (ext.):* as 6.46 a)
- b) *Application context identifier (ACI) (Octet 1 and Octet 1a)*
  - b1) If the extension bit is set to 1 in Octet 1, Octet 1a is absent. The value contained in Octet 1 Bits 1-7 shall be interpreted as follows:

- 0 0 0 0 0 0 0      Unidentified Context and Error Handling (UCEH) ASE
- 0 0 0 0 0 0 1      PSS1 ASE (VPN)
- 0 0 0 0 0 1 0      spare
- 0 0 0 0 0 1 1      charging ASE

The preceding values are used by APM'98-user applications.

- 0 0 0 0 1 0 0      GAT ASE
- 0 0 0 0 1 0 1      BAT ASE
- 0 0 0 0 1 1 0      Enhanced Unidentified Context and Error Handling ASE (EUCEH ASE)
- 0 0 0 0 1 1 1 }  
to }      spare for international use
- 0 1 1 1 1 1 1 }
- 1 0 0 0 0 0 0 }  
to }      reserved for non-standardized APM'98-user applications
- 1 1 1 1 1 1 1 }



b2) If the extension bit is set to 0 in Octet 1, Octet 1a is present. In that case, the ACI is a 14-bit field:

Octet 1a	Octet 1	
7 6 5 4 3 2 1	7 6 5 4 3 2 1	
0 0 0 0 0 0 1	0 0 0 0 0 0 0	}
0 0 0 0 0 0 1	1 1 1 1 1 1 1	
0 0 0 0 0 1 0	0 0 0 0 0 0 0	}
1 1 1 1 1 1 1	1 1 1 1 1 1 1	

NOTE 1 – The compatibility mechanism as defined in ITU-T Q.764, in case of ISUP, and in ITU-T Q.1902.4, in case of BICC, is not applicable to this field.

c) *Application transport instruction indicators*

bit 1            *Release call indicator (RCI)*

0            do not release call

1            release call

bit 2            *Send notification indicator (SNI)*

0            do not send notification

1            send notification

d) *APM segmentation indicator*

0 0 0 0 0 0    final segment

0 0 0 0 0 1 }  
to }  
0 0 1 0 0 1 }

indicates the number of following segments

0 0 1 0 1 0 }  
to }  
1 1 1 1 1 1 }

spare

NOTE 2 – The compatibility mechanism as defined in ITU-T Q.764, in case of ISUP, and in ITU-T Q.1902.4, in case of BICC, is not applicable to this field.

e) *Sequence indicator (SI)*

0    subsequent segment to first segment

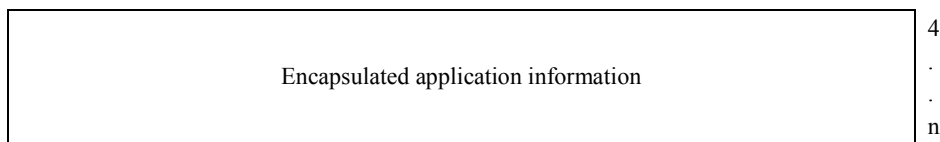
1    new sequence

f) *Segmentation local reference (SLR)*

g) *APM-user information field*

The format and coding of this field depends on the Application Context Identifier.

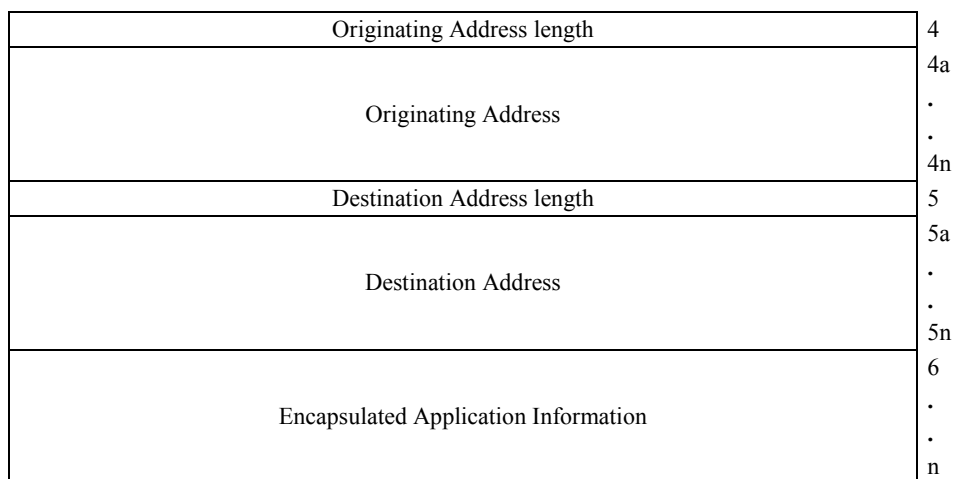
g1) If the ACI corresponds to an APM'98-user application, then the format of the APM-user information field is shown in Figure 9.



**Figure 9/Q.1902.3 – Content of the APM-user information field for APM'98-user applications**

The content of this field is described in g2.D).

g2) If the ACI corresponds to an APM'2000-user application, then the format of the APM-user information field is shown in Figure 10:



**Figure 10/Q.1902.3 – Content of the APM-user information field for APM'2000-user applications**

The coding of the APM-user information field is as follows:

g2.A) *Originating address length*

The values are 0, 3-20.

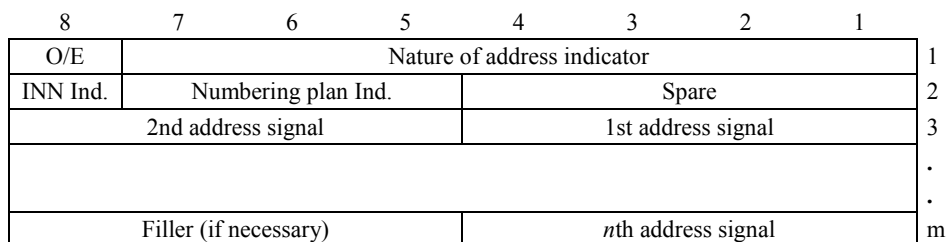
g2.B) *Destination address length*

The values are 0, 3-20.

g2.C) *Originating address/Destination address*

The originating address (destination address) field is not present if the originating address length (destination address length) is set to zero.

The format of the Originating and Destination address fields is shown in Figure 11.



**Figure 11/Q.1902.3 – Content of the Originating address (Destination address) field**

The following codes are used in the Originating address and the Destination address fields:

1) *Odd/even indicator (O/E)*: as 6.17a)

2) *Nature of address indicator*

0 0 0 0 0 0	spare
0 0 0 0 0 1	reserved for subscriber number
0 0 0 0 1 0	unknown (national use)
0 0 0 0 1 1	national (significant) number
0 0 0 0 1 0 0	international number
0 0 0 0 1 0 1	network-specific number (national use)
0 0 0 0 1 1 0	network routing number in national (significant) number format (national use)
0 0 0 0 1 1 1	network routing number in network specific number format (national use)
0 0 0 1 0 0 0	reserved for network routing number concatenated with directory number
0 0 0 1 0 0 1	} spare
to	
1 1 0 1 1 1 1	} reserved for national use
1 1 1 0 0 0 0	
to	
1 1 1 1 1 1 0	
1 1 1 1 1 1 1	spare

3) *Internal network number indicator (INN ind.)*

0 routing to internal network number allowed

1 routing to internal network number not allowed

4) *Numbering plan indicator*

0 0 0	spare
0 0 1	numbering plan according to ITU-T E.164
0 1 0	spare
0 1 1	reserved for numbering plan according to ITU-T X.121
1 0 0	reserved for numbering plan according to ITU-T F.69
1 0 1	reserved for national use
1 1 0	reserved for national use
1 1 1	spare

5) *Address signal*

0 0 0 0 digit 0

0 0 0 1 digit 1

0 0 1 0 digit 2

0 0 1 1	digit 3
0 1 0 0	digit 4
0 1 0 1	digit 5
0 1 1 0	digit 6
0 1 1 1	digit 7
1 0 0 0	digit 8
1 0 0 1	digit 9
1 0 1 0	spare
1 0 1 1	code 11
1 1 0 0	code 12
1 1 0 1	spare
1 1 1 0	spare
1 1 1 1	spare

The most significant address signal is sent first. Subsequent address signals are sent in successive 4-bit fields.

6) *Filler:* as 6.17 f)

g2.D) *Encapsulated application information*

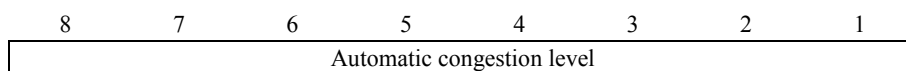
Contains the application specific information.

The format and coding of this field is dependent upon the APM-user application and defined in the appropriate Recommendation. For APM-user applications that wish to provide a service of transparent transport of information (e.g. the case where existing information elements are defined for the transport of certain information) as well as having the ability of passing additional network related information within the public network, then the following guideline is provided:

It is suggested that this field be structured such that the first octet (i.e. first octet of first segment for long APM-user information) is a pointer to information to be transported transparently. The pointer value (in binary) gives the number of octets between the pointer itself (included) and the first octet (not included) of transparent data. The pointer value all zeros is used to indicate that no transparent data is present. The range of octets between the pointer octet and the first octet of transparent data (to which the pointer octet points) contains the network related information to be passed between the applications residing within the public network. The format and coding of both the transparent information and the network related information is application specific and defined in the appropriate Recommendation.

### 6.5 Automatic congestion level

The format of the automatic congestion level parameter field is shown in Figure 12.



**Figure 12/Q.1902.3 – Automatic congestion level parameter field**

The following codes are used in the automatic congestion level parameter field:

```

0 0 0 0 0 0 0 0    spare
0 0 0 0 0 0 0 1    congestion level 1 exceeded
0 0 0 0 0 0 1 0    congestion level 2 exceeded
0 0 0 0 0 0 1 1 }
      to           } spare
1 1 1 1 1 1 1 1 }
  
```

### 6.6 Backward call indicators

The format of the backward call indicators parameter field is shown in Figure 13.

8	7	6	5	4	3	2	1	
H	G	F	E	D	C	B	A	1
P	O	N	M	L	K	J	I	2

**Figure 13/Q.1902.3 – Backward call indicators parameter field**

The following codes are used in the backward call indicators parameter field:

bits BA    *Charge indicator* (Note 1)

```

0 0    no indication
0 1    no charge
1 0    charge
1 1    spare
  
```

NOTE 1 – The interpretation of these bits depends only on the charging exchange.

bits DC    *Called party's status indicator*

```

0 0    no indication
0 1    subscriber free
1 0    connect when free (national use)
1 1    spare
  
```

bits FE    *Called party's category indicator*

```

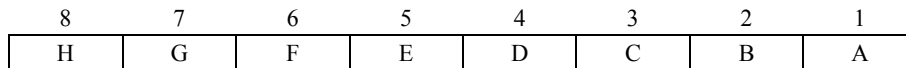
0 0    no indication
0 1    ordinary subscriber
1 0    Payphone
1 1    spare
  
```

bits <u>HG</u>	<i>End-to-end method indicator</i> (Note 2)
0 0	no end-to-end method available (only link-by-link method available)
0 1	pass-along method available (national use) (ISUP)/reserved (BICC)
1 0	SCCP method available (ISUP)/reserved (BICC)
1 0	pass-along and SCCP methods available (national use) (ISUP)/reserved (BICC)
bit <u>I</u>	<i>Interworking indicator</i> (Note 2)
0	no interworking encountered (Signalling System No. 7/BICC all the way)
1	interworking encountered
bit <u>J</u>	<i>End-to-end information indicator</i> (national use) (Note 2)
0	no end-to-end information available
1	end-to-end information available (ISUP)/reserved (BICC)
bit <u>K</u>	<i>ISDN user part/BICC indicator</i> (Note 2)
0	ISDN user part/BICC not used all the way
1	ISDN user part/BICC used all the way
bit <u>L</u>	<i>Holding indicator</i> (national use)
0	holding not requested
1	holding requested
bit <u>M</u>	<i>ISDN access indicator</i>
0	terminating access non-ISDN
1	terminating access ISDN
bit <u>N</u>	<i>Echo control device indicator</i>
0	incoming echo control device not included
1	incoming echo control device included
bits <u>PO</u>	<i>SCCP method indicator</i> (Note 2)
0 0	no indication
0 1	connectionless method available (national use) (ISUP)/reserved (BICC)
1 0	connection oriented method available (ISUP)/reserved (BICC)
1 1	connectionless and connection oriented methods available (national use) (ISUP)/reserved (BICC)

NOTE 2 – Bits G-K and O-P constitute the protocol control indicator (ITU-T Q.730 and Q.1902.6).

## 6.7 Backward GVNS

The format of the backward GVNS parameter field is shown in Figure 14.



**Figure 14/Q.1902.3 – Backward GVNS parameter field**

The following codes are used in the backward GVNS parameter field:

bits BA *Terminating access indicator*

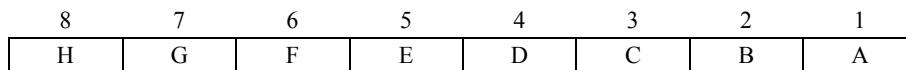
- 0 0 no information
- 0 1 dedicated terminating access
- 1 0 switched terminating access
- 1 1 spare

bits G-C *Spare*

bit H *Extension indicator: as 6.46 a)*

## 6.8 Call diversion information

The format of the call diversion information parameter field is shown in Figure 15.



**Figure 15/Q.1902.3 – Call diversion information parameter field**

The following codes are used in the call diversion information parameter field.

a) *Notification subscription options*

bits CBA

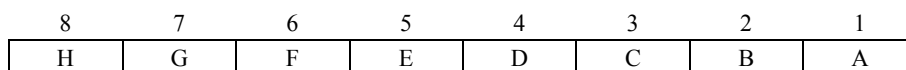
- 0 0 0 unknown
- 0 0 1 presentation not allowed
- 0 1 0 presentation allowed with redirection number
- 0 1 1 presentation allowed without redirection number
- 1 0 0 } spare
- to }
- 1 1 1 }

b) *Redirecting reason*

bits <u>GFED</u>	
0 0 0 0	unknown
0 0 0 1	user busy
0 0 1 0	no reply
0 0 1 1	unconditional
0 1 0 0	deflection during alerting
0 1 0 1	deflection immediate response
0 1 1 0	mobile subscriber not reachable
0 1 1 1	} spare
to	
1 1 1 1	
bit H	<i>Spare</i>

### 6.9 Call diversion treatment indicators

The format of the call diversion treatment indicators parameter field is shown in Figure 16.



**Figure 16/Q.1902.3 – Call diversion treatment indicators parameter field**

The following codes are used in the call diversion treatment parameter field:

bits <u>BA</u>	<i>Call to be diverted indicator</i>
0 0	no indication
0 1	call diversion allowed
1 0	call diversion not allowed
1 1	spare
bits G-C	<i>Spare</i>
bit H	<i>Extension indicator: as 6.46 a)</i>

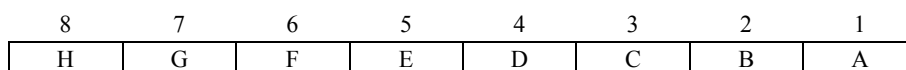
### 6.10 Call history information

The format of the call history information parameter field is shown in Figure 98.

The call history information parameter expresses in pure binary representation the propagation delay value of a call in ms.

### 6.11 Call offering treatment indicators

The format of the call offering treatment indicators parameter field is shown in Figure 17.



**Figure 17/Q.1902.3 – Call offering treatment indicators parameter field**

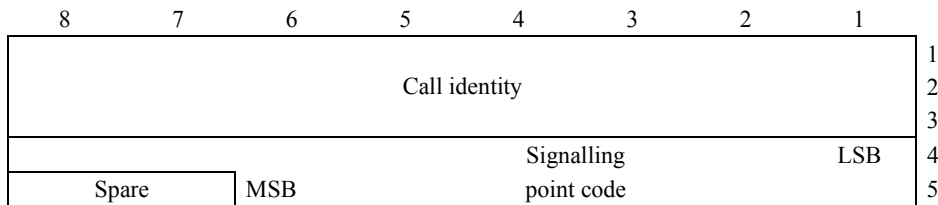


The following codes are used in the call offering treatment parameter field:

- bits BA    *Call to be offered indicator*
  - 0 0    no indication
  - 0 1    call offering not allowed
  - 1 0    call offering allowed
  - 1 1    spare
- bits G-C    *Spare*
- bit H        *Extension indicator: as 6.46 a)*

### 6.12 Call reference (national use)

The format of the call reference parameter is shown in Figure 18. This parameter is relevant to BICC only in MTP3 and MTP3b based signalling networks.



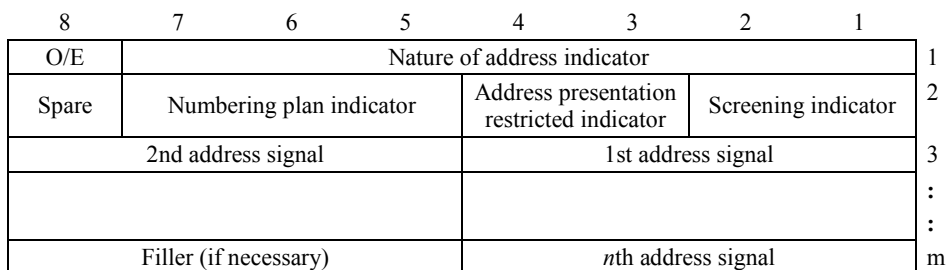
**Figure 18/Q.1902.3 – Call reference parameter field**

The following codes are used in the subfields of the call reference parameter field:

- a)    *Call identity*  
A code expressing in pure binary representation the identification number allocated to the call.
- b)    *Signalling point code*  
The code of the signalling point in which the call identity is relevant.

### 6.13 Call transfer number

The format of the call transfer number parameter field is shown in Figure 19.



**Figure 19/Q.1902.3 – Call transfer number parameter field**

The following codes are used in the subfields of the call transfer number parameter field:

- a) *Odd/even indicator (O/E):* as 6.17 a)
- b) *Nature of address indicator*

0 0 0 0 0 0	spare	
0 0 0 0 0 1	subscriber number (national use)	
0 0 0 0 1 0	unknown (national use)	
0 0 0 0 1 1	national (significant) number (national use)	
0 0 0 0 1 0 0	international number	
0 0 0 0 1 0 1	}	spare
to		
1 1 0 1 1 1 1	}	reserved for national use
1 1 1 0 0 0 0		
to		
1 1 1 1 1 1 0		
1 1 1 1 1 1 1	spare	
- c) *Numbering plan indicator*

0 0 0	spare
0 0 1	numbering plan according to ITU-T E.164
0 1 0	spare
0 1 1	numbering plan according to ITU-T X.121 (national use)
1 0 0	numbering plan according to ITU-T F.69 (national use)
1 0 1	private numbering plan (national use)
1 1 0	reserved for national use
1 1 1	spare
- d) *Address presentation restricted indicator*

0 0	presentation allowed
0 1	presentation restricted
1 0	spare
1 1	spare
- e) *Screening indicator*

0 0	user provided, not verified
0 1	user provided, verified and passed
1 0	user provided, verified and failed
1 1	network provided
- f) *Address signal*

0 0 0 0	digit 0
0 0 0 1	digit 1
0 0 1 0	digit 2

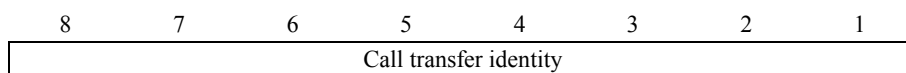
0 0 1 1	digit 3
0 1 0 0	digit 4
0 1 0 1	digit 5
0 1 1 0	digit 6
0 1 1 1	digit 7
1 0 0 0	digit 8
1 0 0 1	digit 9
1 0 1 0	spare
1 0 1 1	code 11
1 1 0 0	code 12
1 1 0 1	} spare
to	
1 1 1 1	

The most significant address signal is sent first. Subsequent address signals are sent in successive 4-bit fields.

g) *Filler*: as 6.17 f)

#### 6.14 Call transfer reference

The format of the call transfer reference parameter is shown in Figure 20.

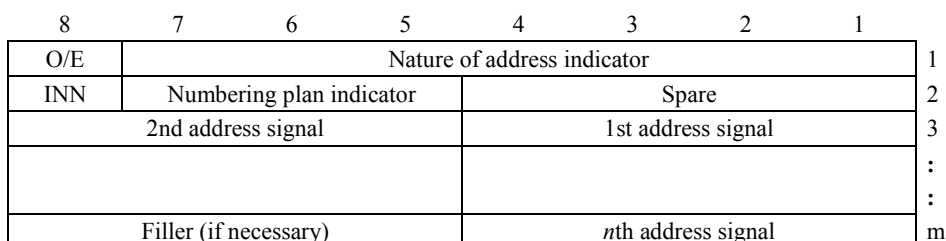


**Figure 20/Q.1902.3 – Call transfer reference parameter field**

The call transfer identity is a pure binary representation of the integer (0 to 255) assigned unambiguously to the particular ECT supplementary service invocation (see clause 7/Q.732).

#### 6.15 Called directory number (national use)

The format of the called directory number parameter field is shown in Figure 21.



**Figure 21/Q.1902.3 – Called directory number parameter field**

The following codes are used in the subfields of the called directory number parameter field:

- a) *Odd/even indicator (O/E)*: as 6.17 a)
- b) *Nature of address indicator*

0 0 0 0 0 0	spare
0 0 0 0 0 1	subscriber number (national use)
0 0 0 0 1 0	unknown (national use)
0 0 0 0 1 1	national (significant) number (national use)
0 0 0 1 0 0	reserved
0 0 0 1 1 1	reserved
0 0 0 1 0 0 0	reserved
0 0 0 1 0 0 1	} spare
to	
1 1 0 1 1 1 1	} reserved for national use
1 1 1 0 0 0 0	
to	
1 1 1 1 1 1 0	
1 1 1 1 1 1 1	spare
- c) *Numbering plan indicator*

0 0 0	reserved
0 0 1	numbering plan according to ITU-T E.164
0 1 0	spare
0 1 1	reserved (national use)
1 0 0	reserved (national use)
1 0 1	reserved for national use
1 1 0	reserved for national use
1 1 1	reserved
- d) *Internal network number indicator (INN)*

0	reserved
1	routing to internal network number not allowed
- e) *Address signal*

0 0 0 0	digit 0
0 0 0 1	digit 1
0 0 1 0	digit 2
0 0 1 1	digit 3
0 1 0 0	digit 4
0 1 0 1	digit 5
0 1 1 0	digit 6
0 1 1 1	digit 7

1 0 0 0	digit 8
1 0 0 1	digit 9
1 0 1 0	spare
1 0 1 1	reserved
1 1 0 0	reserved
1 1 0 1	spare
1 1 1 0	spare
1 1 1 1	ST

The most significant address signal is sent first. Subsequent address signals are sent in successive 4-bit fields.

f) *Filler*: as 6.17 f)

### 6.16 Called IN number

The format of the called IN number parameter corresponds to the original called number parameter (see 6.69).

### 6.17 Called party number

The format of the called party number parameter field is shown in Figure 22.

8	7	6	5	4	3	2	1	
O/E		Nature of address indicator						1
INN		Numbering plan indicator			Spare			2
2nd address signal				1st address signal				3
								:
								:
Filler (if necessary)				n <sup>th</sup> address signal				m

**Figure 22/Q.1902.3 – Called party number parameter field**

The following codes are used in the subfields of the called party number parameter field:

a) *Odd/even indicator (O/E)*

0 even number of address signals

1 odd number of address signals

b) *Nature of address indicator*

0 0 0 0 0 0 0 spare

0 0 0 0 0 0 1 subscriber number (national use)

0 0 0 0 0 1 0 unknown (national use)

0 0 0 0 0 1 1 national (significant) number

0 0 0 0 1 0 0 international number

0 0 0 0 1 0 1 network-specific number (national use)

0 0 0 0 1 1 0 network routing number in national (significant) number format (national use)

0 0 0 0 1 1 1	network routing number in network-specific number format (national use)
0 0 0 1 0 0 0	network routing number concatenated with Called Directory Number (national use)
0 0 0 1 0 0 1	} spare
to	
1 1 0 1 1 1 1	} reserved for national use
1 1 1 0 0 0 0	
to	
1 1 1 1 1 1 0	
1 1 1 1 1 1 1	spare

c) *Internal Network Number indicator (INN)*

0	routing to internal network number allowed
1	routing to internal network number not allowed

d) *Numbering plan indicator*

0 0 0	spare
0 0 1	numbering plan according to ITU-T E.164
0 1 0	spare
0 1 1	numbering plan according to ITU-T X.121 (national use)
1 0 0	numbering plan according to ITU-T F.69 (national use)
1 0 1	reserved for national use
1 1 0	reserved for national use
1 1 1	spare

e) *Address signal*

0 0 0 0	digit 0
0 0 0 1	digit 1
0 0 1 0	digit 2
0 0 1 1	digit 3
0 1 0 0	digit 4
0 1 0 1	digit 5
0 1 1 0	digit 6
0 1 1 1	digit 7
1 0 0 0	digit 8
1 0 0 1	digit 9
1 0 1 0	spare
1 0 1 1	code 11
1 1 0 0	code 12
1 1 0 1	spare

1 1 1 0       spare  
 1 1 1 1       ST

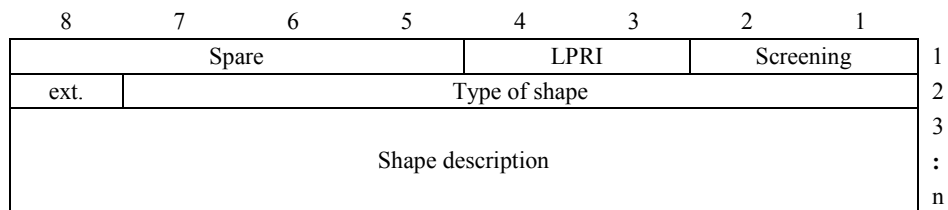
The most significant address signal is sent first. Subsequent address signals are sent in successive 4-bit fields.

f) *Filler*

In case of an odd number of address signals, the filler code 0000 is inserted after the last address signal.

### 6.18 Calling geodetic location

The format of the calling geodetic location parameter field is shown in Figure 23. The format and coding of the elements in the shape description are described in the following subclauses.



**Figure 23/Q.1902.3 – Geodetic location parameter**

The following codes are used in the subfields of the geodetic location parameter:

a) *Location presentation restricted indicator*

0 0    presentation allowed  
 0 1    presentation restricted  
 1 0    location not available (Note)  
 1 1    spare

NOTE – If the Geodetic Location parameter is included and the LPRI indicates location not available, octets 3 to n are omitted, the subfield c) is coded with 0000000 and the subfield b) is coded 11.

b) *Screening indicator*

0 0    user provided, not verified  
 0 1    user provided, verified and passed  
 1 0    user provided, verified and failed  
 1 1    network provided

c) *Type of shape*

0 0 0 0 0 0    ellipsoid point  
 0 0 0 0 0 1    ellipsoid point with uncertainty  
 0 0 0 0 1 0    ellipsoid point with altitude and uncertainty  
 0 0 0 0 1 1    ellipse on the ellipsoid  
 0 0 0 1 0 0    ellipsoid circle sector  
 0 0 0 1 0 1    polygon  
 0 0 0 1 1 0    ellipsoid point with altitude

0 0 0 0 1 1 1    ellipsoid point with altitude and uncertainty ellipsoid  
 0 0 0 1 0 0 0    ellipsoid arc  
 0 0 0 1 0 0 1    }  
                   to                    } spare  
 0 1 1 1 1 1 1    }  
 1 0 0 0 0 0 0    }  
                   to                    } reserved for national use  
 1 1 1 1 1 1 0    }  
 1 1 1 1 1 1 1    reserved for future expansion

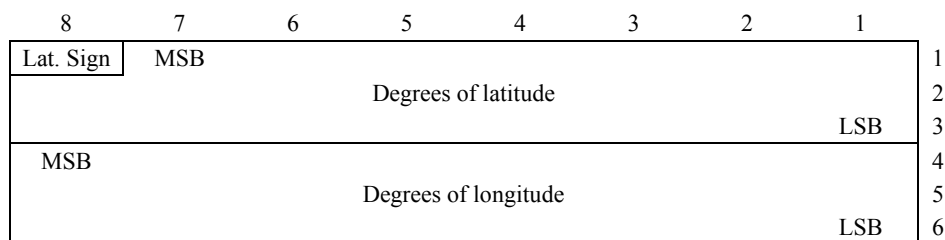
d) *Extension indicator (ext.):* as 6.46 a).

e) *Shape description*

The coding of the shape description consists of different elements dependent on the type of shape as detailed in the following subclauses:

### 6.18.1 Ellipsoid point shape description

The format of the ellipsoid point shape description is shown in Figure 24.



**Figure 24/Q.1902.3 – Ellipsoid point shape description**

a) *Latitude Sign*

0 North  
 1 South

b) *Degrees of latitude*

The relation between the binary coded number  $N$  and the range of latitudes  $X$  ( $0 \leq X \leq 90$ , where  $X$  is in degrees but not necessarily an integral number of degrees) it encodes is described by the following equation;

$$N \leq \frac{2^{23}}{90} X < N + 1$$

except for  $N = 2^{23} - 1$ , for which the range is extended to include  $N + 1$

c) *Degrees of longitude*

The longitude, expressed in the range  $-180^\circ, +180^\circ$ , is coded as a number between  $-2^{23}$  and  $2^{23} - 1$ , coded in 2's complement binary. The relation between the binary coded number  $N$  and the range of longitudes  $X$  ( $-180 \leq X \leq +180$ , where  $X$  is in degrees but not necessarily an integral number of degrees) it encodes is described by the following equation:



$$N \leq \frac{2^{24}}{360} X < N + 1$$

### 6.18.2 Ellipsoid point with uncertainty shape description

The format of the ellipsoid point with uncertainty shape description is shown in Figure 25.

8	7	6	5	4	3	2	1	
Lat. Sign	MSB							1
Degrees of latitude							LSB	2
Degrees of longitude							LSB	3
MSB								5
Degrees of longitude							LSB	6
Spare	Uncertainty code							7
Spare	Confidence							8

Figure 25/Q.1902.3 – Shape description of an ellipsoid point with uncertainty

a) *Latitude Sign*

As 6.18.1 a).

b) *Degrees of latitude*

As 6.18.1 b).

c) *Degrees of longitude*

As 6.18.1 c).

d) *Uncertainty code*

The uncertainty  $r$ , expressed in metres (in the range 0 m to 1800 km), is mapped from the binary number  $K$ , with the following formula:

$$r = C \left( (1 + x)^K - 1 \right)$$

with  $C = 10$  and  $x = 0.1$ .

e) *Confidence*

The confidence by which the location is known to be within the shape description,  $C$  (expressed as a percentage) is directly mapped from the binary number  $K$ , except for  $K = 0$  which is used to indicate "no information", and  $100 < K \leq 127$  which are not used.

### 6.18.3 Point with altitude and uncertainty shape description

The format of the point with altitude and uncertainty circle shape description is shown in Figure 26.

	8	7	6	5	4	3	2	1	
Lat. Sign	MSB								1
	Degrees of latitude								2
								LSB	3
	MSB								4
	Degrees of longitude								5
								LSB	6
Spare	Uncertainty code								7
Alt. sign	MSB								8
	Altitude								9
								LSB	10
Spare	Altitude uncertainty code								11
Spare	Confidence								11

**Figure 26/Q.1902.3 – Shape description of a point with altitude and uncertainty**

a) *Latitude sign*

As 6.18.1 a).

b) *Degrees of latitude*

As 6.18.1 b).

c) *Degrees of longitude*

As 6.18.1 c).

d) *Uncertainty code*

As Subclause 6.18.2 d).

e) *Altitude Sign*

0 above the ellipsoid

1 below the ellipsoid

f) *Altitude*

The relation between the binary coded number  $N$  and the range of altitudes  $a$  (in metres) it encodes is described by the following equation:

$$N \leq a < N + 1$$

except for  $N = 2^{15} - 1$  for which the range is extended to include all greater values of  $a$ .

g) *Altitude uncertainty code*

The altitude uncertainty  $h$ , expressed in metres (in the range 0 m to  $\approx 1000$  m), is mapped from the binary number  $K$ , with the following formula:

$$h = C \left( (1 + x)^K - 1 \right)$$

with  $C = 45$  and  $x = 0.025$ .

h) *Confidence*

As 6.18.2 e).

### 6.18.4 Ellipse on the ellipsoid shape description

The format of the ellipse on the ellipsoid shape description is shown in Figure 27.

	8	7	6	5	4	3	2	1	
Lat. Sign	MSB								1
	Degrees of latitude								2
							LSB		3
	MSB								4
	Degrees of longitude								5
							LSB		6
Spare	Major radius								7
Spare	Minor radius								8
	Orientation								9
Spare	Confidence								10

**Figure 27/Q.1902.3 – Shape description of an ellipse on the ellipsoid**

a) *Latitude sign*

As 6.18.1 a).

b) *Degrees of latitude*

As 6.18.1 b).

c) *Degrees of longitude*

As 6.18.1 c).

d) *Major radius*

The major axis of the ellipse  $r_{major}$ , expressed in metres (in the range 1 m to 1800 km), is mapped from the binary number  $K$ , with the following formula:

$$r = C((1+x)^K - 1)$$

with  $C = 10$  and  $x = 0.1$ .

e) *Minor radius*

The minor axis of the ellipse  $r_{minor}$ , expressed in metres (in the range 1 m to 1800 km), is mapped from the binary number  $K$ , with the following formula:

$$r = C((1+x)^K - 1)$$

with  $C = 10$  and  $x = 0.1$ .

f) *Orientation*

The orientation of the major axis of the ellipse,  $\theta$ , expressed in degrees ( $0^\circ$  being North,  $90^\circ$  being East, etc. with  $1^\circ$  granularity), is mapped from the binary number  $K$ , with the following formula:

$$\theta = K$$

except for  $180 < K \leq 255$  which are not used.

g) *Confidence*

As 6.18.2 e).

### 6.18.5 Ellipsoid circle sector shape description

The format of the ellipsoid circle sector shape description is shown in Figure 28.

	8	7	6	5	4	3	2	1	
1	Lat. Sign	MSB							
2	Degrees of latitude								
3									LSB
4	MSB								
5	Degrees of longitude								
6									LSB
7	Spare	Radius							
8	Offset angle								
9	Included angle								
10	Spare	Confidence							

**Figure 28/Q.1902.3– Shape description of an ellipsoid circle sector**

a) *Latitude sign*

As 6.18.1 a).

b) *Degrees of latitude*

As 6.18.1 b).

c) *Degrees of longitude*

As 6.18.1 c).

d) *Radius*

The radius of the circle sector  $r$ , expressed in metres (in the range 1 m to 1800 km), is mapped from the binary number  $K$ , with the following formula:

$$r = C \left( (1+x)^K - 1 \right)$$

with  $C = 10$  and  $x = 0.1$ .

e) *Offset angle*

The orientation of the offset of the circle sector,  $\theta$  expressed in degrees ( $0^\circ$  being North,  $90^\circ$  being East, etc. with  $2^\circ$  granularity), is mapped from the binary number  $K$ , with the following formula:

$$\theta = 2K$$

except for  $180 < K \leq 255$  which are not used.

f) *Included angle*

The included angle of the circle sector,  $\beta$  expressed in degrees ( $0^\circ$  being North,  $90^\circ$  being East, etc. with  $2^\circ$  granularity), is mapped from the binary number  $K$ , with the following formula:

$$\beta = 2K$$

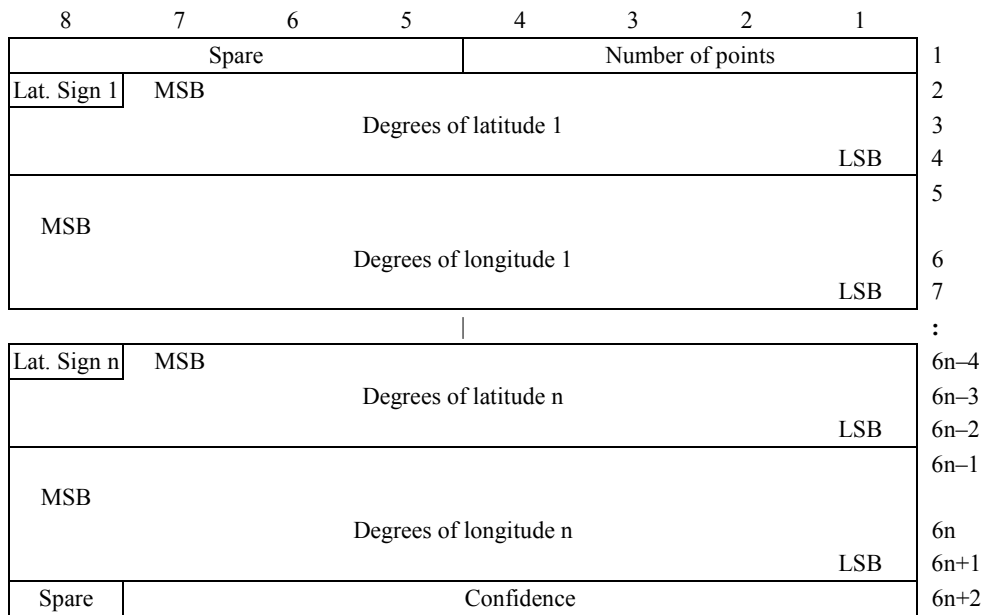
except for  $180 < K \leq 255$  which are not used.

g) *Confidence*

As 6.18.2 e).

### 6.18.6 Polygon shape description

The format of the polygon shape description is shown in Figure 29.



**Figure 29/Q.1902.3 – Shape description of a polygon**

- a) *Number of points*  
 0 0 0 0 reserved  
 0 0 0 1 reserved  
 0 0 1 0 reserved  
 0 0 1 1 }  
     to } binary value of the number of points (3-15)  
 1 1 1 1 }
- b) *Latitude Sign 1*  
 As 6.18.1 a).
- c) *Degrees of latitude 1*  
 As 6.18.1 b).
- d) *Degrees of longitude 1*  
 As 6.18.1 c).
- e) *Latitude Sign n*  
 As 6.18.1 a).
- f) *Degrees of latitude n*  
 As 6.18.1 b).
- g) *Degrees of longitude n*  
 As 6.18.1 c).
- h) *Confidence*  
 As 6.18.2 e).

### 6.18.7 Ellipsoid Point with Altitude shape description

The format of the point with altitude shape description is shown in Figure 30.

	8	7	6	5	4	3	2	1	
Lat. Sign	MSB								1
	Degrees of latitude								2
								LSB	3
MSB	Degrees of longitude								4
								LSB	5
									6
Alt. sign	MSB								7
	Altitude								8
								LSB	8

**Figure 30/Q.1902.3 – Shape description of a point with altitude**

- a) *Latitude Sign*  
As 6.18.1 a).
- b) *Degrees of latitude*  
As 6.18.1 b).
- c) *Degrees of Longitude*  
As 6.18.1 c).
- d) *Altitude Sign*  
As 6.18.3 e).
- e) *Altitude*  
As 6.18.3 f).

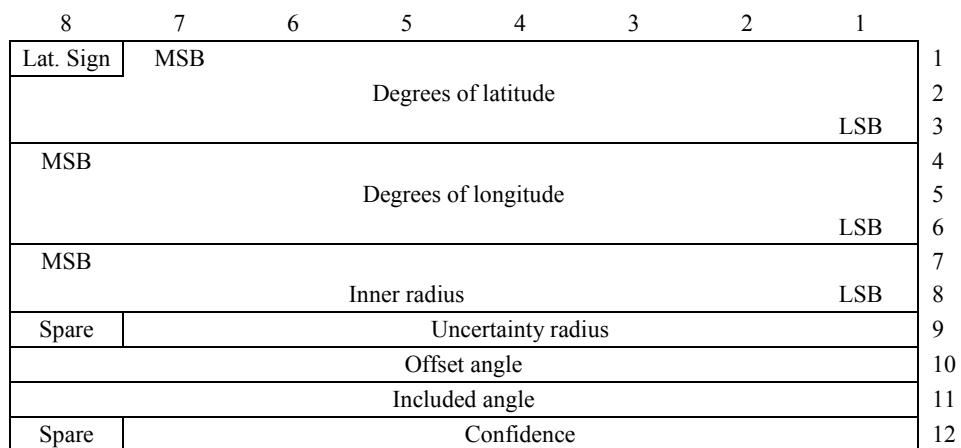
### 6.18.8 Ellipsoid Point with Altitude and Uncertainty Ellipsoid shape description

	8	7	6	5	4	3	2	1	
Lat. Sign	MSB								1
	Degrees of latitude								2
								LSB	3
MSB	Degrees of longitude								4
								LSB	5
									6
Alt. Sign	Altitude								7
	Altitude								8
Spare	Major radius								9
Spare	Minor radius								10
	Orientation								11
Spare	Altitude Uncertainty Code								12
Spare	Confidence								13

**Figure 31/Q.1902.3 – Shape description of a point with altitude and uncertainty ellipsoid**

- a) *Latitude Sign*  
As 6.18.1 a).
- b) *Degrees of latitude*  
As 6.18.1 b).
- c) *Degrees of Longitude*  
As 6.18.1 c).
- d) *Altitude Sign*  
As 6.18.3 e).
- e) *Altitude*  
As 6.18.3 f).
- f) *Major radius*  
As 6.18.4 d).
- g) *Minor radius*  
As 6.18.4 e).
- h) *Orientation*  
As 6.18.4 f).
- i) *Altitude Uncertainty Code*  
As 6.18.3 g).
- j) *Confidence*  
As 6.18.2 e).

**6.18.9 Ellipsoid Arc**



**Figure 32/Q.1902.3 – Shape description of an ellipsoid arc**

- a) *Latitude Sign*  
As 6.18.1 a).
- b) *Degrees of latitude*  
As 6.18.1 b).

c) *Degrees of Longitude*

As 6.18.1 c).

d) *Inner radius*

Inner radius is encoded in increments of 5 metres using a 16-bit binary coded number  $N$ . The relation between the number  $N$  and the range of radius  $r$  (in metres) it encodes is described by the following equation:

$$5N \leq r < 5(N + 1)$$

Except for  $N = 2^{16} - 1$  for which the range is extended to include all greater values of  $r$ . This provides a true maximum radius of 327 675 metres.

e) *Uncertainty radius*

The Uncertainty Radius is encoded in the same way as the Uncertainty Code, see 6.18.2 d).

f) *Offset angle*

As 6.18.5 e).

g) *Included angle*

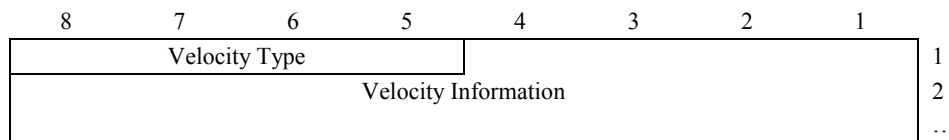
As 6.18.5 f).

h) *Confidence*

As 6.18.2 e).

### 6.19 Calling party geodetic velocity information

Velocity is encoded as shown in Figure 33. The velocity type in bits 8-5 of octet 1 defines the type of velocity information in succeeding bits.



**Figure 33/Q.1902.3 – Calling party geodetic velocity information parameter field**

The following codes are used in the subfields of the Velocity Information parameter:

a) *Velocity Type*

- 0 0 0 0    horizontal velocity
- 0 0 0 1    horizontal with vertical velocity
- 0 0 1 0    horizontal velocity with uncertainty
- 0 0 1 1    horizontal with vertical velocity and uncertainty
- 0 1 0 0    } reserved
- to     }
- 1 1 1 0    }
- 1 1 1 1    reserved for future expansion

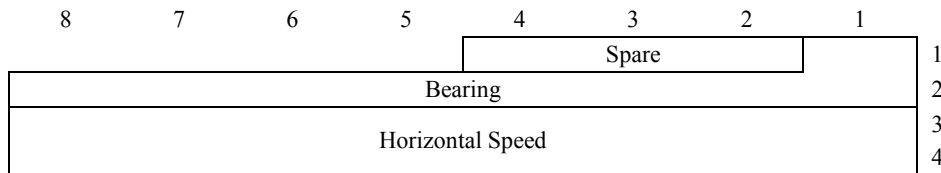


b) *Velocity Information*

The coding of the Velocity Information is dependent on the Velocity Type as detailed in the following subclauses:

**6.19.1 Horizontal Velocity**

Where the Velocity Type indicates "horizontal velocity", the format of Velocity Information is shown in Figure 34.



**Figure 34/Q.1902.3 – Velocity information parameter field for horizontal velocity type**

a) *Spare*

b) *Bearing*

Bearing is encoded in increments of 1 degree measured clockwise from North using a 9-bit binary coded number  $N$ . The relation between the number  $N$  and the bearing  $b$  (in degrees) it encodes is described by the following equation:

$$N \leq b < N + 1$$

except for  $360 \leq N < 511$  which are not used.

c) *Horizontal Speed*

Horizontal speed is encoded in increments of 1 kilometre per hour using a 16-bit binary coded number  $N$ . The relation between the number  $N$  and the horizontal speed  $h$  (in kilometres per hour) it encodes is described by the following equations:

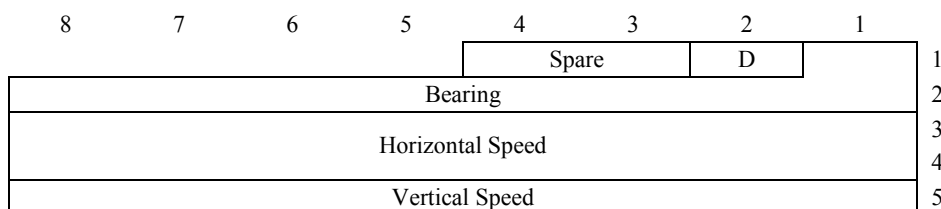
$$N \leq h < N + 0.5 \quad (N = 0)$$

$$N - 0.5 \leq h < N + 0.5 \quad (0 < N < 2^{16} - 1)$$

$$N - 0.5 \leq h \quad (N = 2^{16} - 1)$$

**6.19.2 Horizontal with Vertical Velocity**

Where the Velocity type indicates "horizontal with vertical velocity", the format of Velocity Information is shown in Figure 35.



**Figure 35/Q.1902.3 – Velocity information parameter field for horizontal with vertical velocity type**

- a) *Spare*
- b) *D (Direction of Vertical Speed)*  
0 Upward  
1 Downward

c) *Bearing*  
See 6.19.1 b).

d) *Horizontal Speed*  
See 6.19.1 c).

e) *Vertical Speed*  
Vertical speed is encoded in increments of 1 kilometre per hour using 8 bits giving a number  $N$  between 0 and  $2^8 - 1$ . The relation between the number  $N$  and the vertical speed  $v$  (in kilometres per hour) it encodes is described by the following equations:

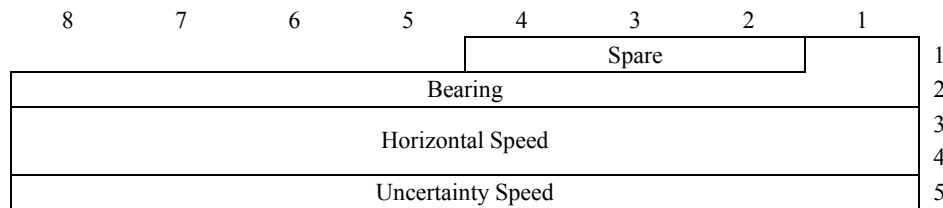
$$N \leq v < N + 0.5 \quad (N = 0)$$

$$N - 0.5 \leq v < N + 0.5 \quad (0 < N < 2^8 - 1)$$

$$N - 0.5 \leq v \quad (N = 2^8 - 1)$$

### 6.19.3 Horizontal Velocity with uncertainty

Where the Velocity type indicates "Horizontal Velocity with uncertainty", the format of Velocity Information is shown in Figure 36.



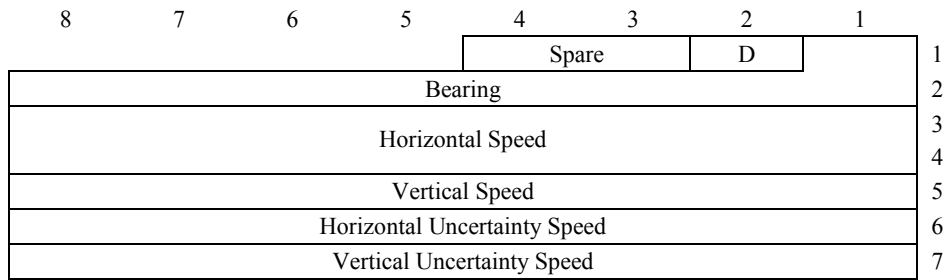
**Figure 36/Q.1902.3 – Velocity information parameter field for horizontal velocity with uncertainty type**

- a) *Spare*
- b) *Bearing*  
See 6.19.1 b).
- c) *Horizontal Speed*  
See 6.19.1 c).
- d) *Uncertainty Speed*

Uncertainty speed is encoded in increments of 1 kilometre per hour using an 8-bit binary coded number  $N$ . The value of  $N$  gives the uncertainty speed except for  $N = 255$  which indicates that the uncertainty is not specified.

### 6.19.4 Horizontal with Vertical Velocity and Uncertainty

Where the Velocity type indicates "Horizontal with Vertical Velocity and Uncertainty", the format of Velocity Information is shown in Figure 37.



**Figure 37/Q.1902.3 – Velocity information parameter field for horizontal with vertical velocity and uncertainty type**

- a) *Spare*
- b) *D (Direction of Vertical Speed)*  
See 6.19.2 b).

- c) *Bearing*  
See 6.19.1 b).

- d) *Horizontal Speed*  
See 6.19.1 c).

- e) *Vertical Speed*  
See 6.19.2 e).

- f) *Horizontal Uncertainty Speed*

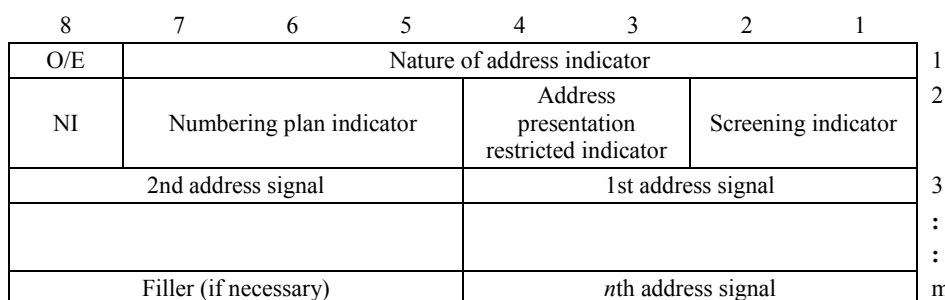
Horizontal uncertainty speed is encoded in increments of 1 kilometre per hour using an 8-bit binary coded number  $N$ . The value of  $N$  gives the uncertainty speed except for  $N=255$  which indicates that the uncertainty is not specified.

- g) *Vertical Uncertainty Speed*

Vertical uncertainty speed is encoded in increments of 1 kilometre per hour using an 8-bit binary coded number  $N$ . The value of  $N$  gives the uncertainty speed except for  $N=255$  which indicates that the uncertainty is not specified.

### 6.20 Calling party number

The format of the calling party number parameter field is shown in Figure 38.



**Figure 38/Q.1902.3 – Calling party number parameter field**

The following codes are used in the calling party number parameter field.

- a) *Odd/even indicator (O/E)*: as 6.17 a)
- b) *Nature of address indicator*
- |               |  |
|---------------|--|
| 0 0 0 0 0 0   | spare  |
| 0 0 0 0 0 1   | subscriber number (national use)             |
| 0 0 0 0 1 0   | unknown (national use)                       |
| 0 0 0 0 1 1   | national (significant) number (national use) |
| 0 0 0 1 0 0   | international number                         |
| 0 0 0 1 0 1   | } spare                                      |
| to            |  |
| 1 1 0 1 1 1 1 | } reserved for national use                  |
| 1 1 1 0 0 0 0 |  |
| to            |  |
| 1 1 1 1 1 1 0 |  |
| 1 1 1 1 1 1 1 | spare  |
- c) *Number Incomplete indicator (NI)*
- |   |            |
|---|------------|
| 0 | complete   |
| 1 | incomplete |
- d) *Numbering plan indicator*: as 6.17 d)
- e) *Address presentation restricted indicator*
- |     |   |
|-----|---|
| 0 0 | presentation allowed                          |
| 0 1 | presentation restricted                       |
| 1 0 | address not available (Note 1) (national use) |
| 1 1 | reserved for restriction by the network       |

NOTE 1 – If the parameter is included and the address presentation restricted indicator indicates address not available, octets 3 to m are omitted, the subfields in items a), b), c) and d) are coded with 0's, and the subfield f) is coded with 11.

- f) *Screening indicator*
- |     |                                    |
|-----|------------------------------------|
| 0 0 | reserved (Note 2)                  |
| 0 1 | user provided, verified and passed |
| 1 0 | reserved (Note 2)                  |
| 1 1 | network provided                   |

NOTE 2 – Code 00 and 10 are reserved for "user provided, not verified" and "user provided, verified and failed" respectively. Codes 00 and 10 are for national use.

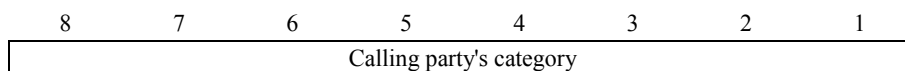
- g) *Address signal*
- |         |         |
|---------|---------|
| 0 0 0 0 | digit 0 |
| 0 0 0 1 | digit 1 |
| 0 0 1 0 | digit 2 |
| 0 0 1 1 | digit 3 |
| 0 1 0 0 | digit 4 |
| 0 1 0 1 | digit 5 |

0 1 1 0	digit 6
0 1 1 1	digit 7
1 0 0 0	digit 8
1 0 0 1	digit 9
1 0 1 0	spare
1 0 1 1	code 11
1 1 0 0	code 12
1 1 0 1	} spare
to	
1 1 1 1	

h) *Filler*: as 6.17 f)

### 6.21 Calling party's category

The format of the calling party's category parameter field is shown in Figure 39.



**Figure 39/Q.1902.3 – Calling party's category parameter field**

The following codes are used in the calling party's category parameter field.

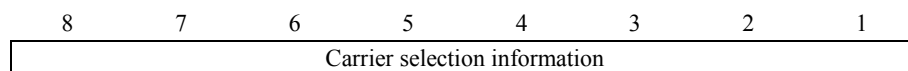
0 0 0 0 0 0 0 0	calling party's category unknown at this time (national use)
0 0 0 0 0 0 0 1	operator, language French
0 0 0 0 0 0 1 0	operator, language English
0 0 0 0 0 0 1 1	operator, language German
0 0 0 0 0 1 0 0	operator, language Russian
0 0 0 0 0 1 0 1	operator, language Spanish
0 0 0 0 0 1 1 0	} (available to Administrations for selection of a particular language by mutual agreement)
0 0 0 0 0 1 1 1	
0 0 0 0 1 0 0 0	
0 0 0 0 1 0 0 1	reserved (see ITU-T Q.104) (Note) (national use)
0 0 0 0 1 0 1 0	ordinary calling subscriber
0 0 0 0 1 0 1 1	calling subscriber with priority
0 0 0 0 1 1 0 0	data call (voiceband data)
0 0 0 0 1 1 0 1	test call
0 0 0 0 1 1 1 0	spare
0 0 0 0 1 1 1 1	payphone

0 0 0 1 0 0 0 0	}	spare
to		
1 1 0 1 1 1 1 1		
1 1 1 0 0 0 0 0	}	reserved for national use
to		
1 1 1 1 1 1 1 0		
1 1 1 1 1 1 1 1		spare

NOTE – In national networks, code 00001001 may be used to indicate that the calling party is a national operator.

## 6.22 Carrier selection information (national use)

The format of the Carrier selection information parameter field is shown in Figure 40.



**Figure 40/Q.1902.3 – Carrier selection information parameter field**

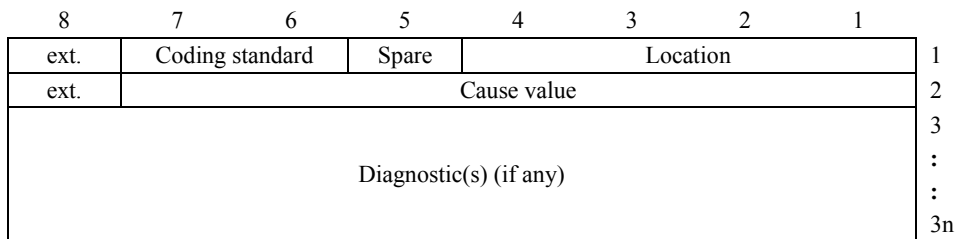
The following codes are used in the Carrier selection information parameter field:

0 0 0 0 0 0 0 0	no indication	
0 0 0 0 0 0 0 1	selected carrier identification pre-subscribed and no input by calling party	
0 0 0 0 0 0 1 0	selected carrier identification pre-subscribed and input by calling party	
0 0 0 0 0 0 1 1	selected carrier identification pre-subscribed and input by calling party undetermined	
0 0 0 0 0 1 0 0	selected carrier identification not pre-subscribed, and input by calling party	
0 0 0 0 0 1 0 1	reserved for primary preferred carrier of the charged party	
0 0 0 0 0 1 1 0	reserved for alternate preferred carrier of the charged party	
0 0 0 0 0 1 1 1	reserved for selected carrier identification presubscription unknown (verbal) instructions from the calling party	
0 0 0 0 1 0 0 0	reserved for selected carrier identification presubscription unknown (verbal) instructions from the charged party	
0 0 0 0 1 0 0 1	reserved for emergency call handling	
0 0 0 0 1 0 1 0	carrier selected by input from calling party	
0 0 0 0 1 0 1 1	carrier selected by a network operator	
0 0 0 0 1 1 0 0	}	spare
to		
1 1 1 1 1 1 1 0		
1 1 1 1 1 1 1 1		reserved

NOTE – This parameter can be present even if the transit network selection is not present.

### 6.23 Cause indicators

The format of the cause indicators parameter field is shown in Figure 41.



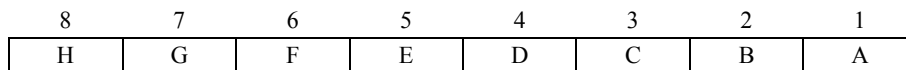
NOTE – Octets 3 to 3n may be omitted or repeated, e.g. 3' to 3n'.

**Figure 41/Q.1902.3 – Cause indicators parameter field**

The codes to be used in the subfields of the cause indicators parameter fields are defined in ITU-T Q.850.

### 6.24 CCNR possible indicator

The format of the CCNR possible indicator parameter field is shown in Figure 42.



**Figure 42/Q.1902.3 – CCNR possible indicator parameter field**

The following codes are used in the CCNR possible indicator parameter field:

- bit A            *CCNR possible indicator*
- 0            *CCNR not possible*
- 1            *CCNR possible*
- bits H-B        *Spare*

### 6.25 CCSS

The format of the CCSS parameter field is shown in Figure 43.



**Figure 43/Q.1902.3 – CCSS parameter field**

The following codes are used in the CCSS parameter field:

- bit A            *CCSS call indicator*
- 0            *no indication*
- 1            *CCSS call*
- bits H-B        *Spare*

### 6.26 Charged party identification (national use)

The format of the charged party identification parameter is national network specific. The format is similar to the format of the corresponding INAP parameter in the "FurnishChargingInformation" operation (see ITU-T Q.1218 and Q.1228).

### 6.27 Circuit assignment map (ISUP only)

The format of the circuit assignment map parameter field is shown in Figure 44.

8	7	6	5	4	3	2	1	
Spare		Map type						1
8	7	6	5	4	3	2	1	2
16	15	14	13	12	11	10	9	3
24	23	22	21	20	19	18	17	4
Spare	31	30	29	28	27	26	25	5

**Figure 44/Q.1902.3 – Circuit assignment map parameter field**

The following codes are used in the circuit assignment map parameter field:

a-1) *Map type*

- 0 0 0 0 0 0      spare
- 0 0 0 0 0 1      1544 kbit/s digital path map format (64 kbit/s base rate)
- 0 0 0 0 1 0      2048 kbit/s digital path map format (64 kbit/s base rate)
- 0 0 0 0 1 1 }  
à                    }      spare
- 1 1 1 1 1 1 }

a-2) bits 8, 7, octet 1      *spare*

b-1) *Map format (octets 2 to 5)*

Each bit position on the map (octets 2 to 5) indicates whether the corresponding 64 kbit/s circuit is used in the  $N \times 64$  connection. The bits are coded as follows:

- 0                    64 kbit/s circuit is not used
- 1                    64 kbit/s circuit is used

Octet 5 is not used for 1544 kbit/s digital path map.

b-2) bit 8, octet 5      *spare*

### 6.28 Circuit/CIC group supervision message type

The format of the circuit/CIC group supervision message type parameter field is shown in Figure 45.

8	7	6	5	4	3	2	1
H	G	F	E	D	C	B	A

**Figure 45/Q.1902.3 – Circuit/CIC group supervision message type parameter field**

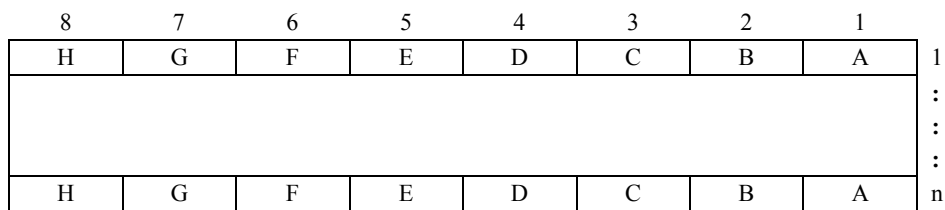


The following codes are used in the circuit/CIC group supervision message type parameter field:

bits <u>BA</u>	<i>Circuit/CIC group supervision message type indicator</i>
0 0	maintenance oriented
0 1	hardware failure oriented (ISUP) / reserved (BICC)
1 0	reserved for national use (used in 1984 version, <i>Red Book</i> , ISUP)
1 1	spare
bits H-C	<i>Spare</i>

### 6.29 Circuit/CIC state indicator (national use)

The format of the circuit/CIC state indicator parameter field is shown in Figure 46.



**Figure 46/Q.1902.3 – Circuit/CIC state indicator parameter field**

The number of octets in the circuit/CIC state indicator parameter field is equal to the specified range + 1. Each circuit/CIC state indicator octet is associated with a CIC such that octet n is associated with CIC  $m + n - 1$ , where m is the CIC contained in the message.

The following codes are used in each circuit/CIC state indicator octet:

- a) *for bits DC = 00*
- |                |                                   |
|----------------|-----------------------------------|
| bits <u>BA</u> | <i>Maintenance blocking state</i> |
| 0 0            | transient                         |
| 0 1            | spare                             |
| 1 0            | spare                             |
| 1 1            | unequipped                        |
| bits H-E       | <i>Spare</i>                      |
- b) *for bits DC not equal to 00*
- |                |                                   |
|----------------|-----------------------------------|
| bits <u>BA</u> | <i>Maintenance blocking state</i> |
| 0 0            | no blocking (active)              |
| 0 1            | locally blocked                   |
| 1 0            | remotely blocked                  |
| 1 1            | locally and remotely blocked      |
| bits <u>DC</u> | <i>Call processing state</i>      |
| 0 1            | circuit/CIC incoming busy         |
| 1 0            | circuit/CIC outgoing busy         |
| 1 1            | idle                              |

bits F E    *Hardware blocking state* (Note) (ISUP)/*reserved* (BICC)

0 0    no blocking (active)

0 1    locally blocked

1 0    remotely blocked

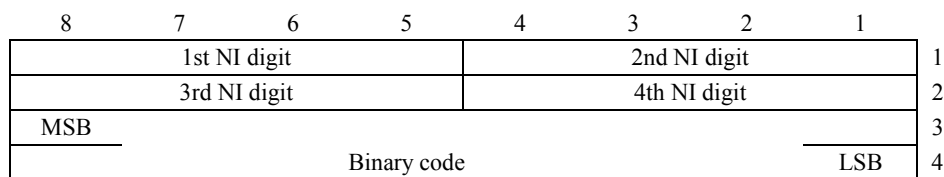
1 1    locally and remotely blocked

bits H-G    *Spare*

NOTE – If bits F E are not coded 0 0, bits D C must be coded 1 1.

### 6.30 Closed user group interlock code

The format of the closed user group interlock code parameter field is shown in Figure 47.



**Figure 47/Q.1902.3 – Closed user group interlock code parameter field**

The following codes are used in the subfields of the closed user group interlock code parameter field:

a) *Network Identity (NI) (octets 1 and 2)*

Each digit is coded in the binary coded decimal representation from 0 to 9. If the first digit of this field is coded 0 or 9, the TCC (Telephony Country Code) follows in the second to fourth NI digits (the most significant TCC digit is in the 2nd NI digit). If the TCC is one or two digits long, the excess digit(s) is inserted with the code for ROA or network identification, if necessary. If octet 2 is not required, it is coded all zeros.

Coding of the first digit as 1 or 8 is excluded.

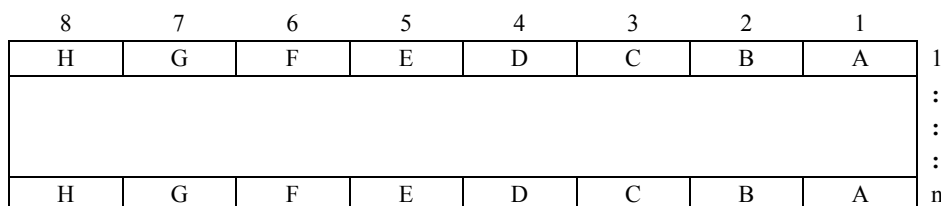
If the first digit is not 0, 9, 1 or 8, this field contains a DNIC (Data Network Identification Code) as defined in ITU-T X.121.

b) *Binary code (octets 3 and 4)*

A code allocated to a closed user group administered by a particular network. Bit 8 of octet 3 is the most significant and bit 1 of octet 4 is the least significant.

### 6.31 Coding decoding processing (ISUP only)

The format of the Coding Decoding Processing parameter field is shown in Figure 48.



**Figure 48/Q.1902.3 – Coding Decoding Processing (CDP) parameter field**

The *n*th octet of this parameter shows the type of voice compression and enabling/disabling of compression/decompression regarding the *n*th pair(s) of DME(s) of LVC.

bit <u>H</u>	<i>Compression status indicator</i>
0	decompressed
1	compressed
bits <u>G F E D C B A</u>	<i>Type of voice compression</i>
0 0 0 0 0 1	reserved
0 0 0 0 1 0	ITU-T G.711 $\mu$ -law
0 0 0 0 1 1	ITU-T G.711 A-law
0 0 0 1 0 0	ITU-T G.726 32 kbit/s ADPCM
0 0 0 1 0 1	} reserved
to	
0 0 0 1 0 0 1	
0 0 0 1 0 1 0	ITU-T G.728 LD-CELP
0 0 0 1 0 1 1	ITU-T G.729 CS-ACELP
0 0 0 1 1 0 0	} reserved
to	
1 1 1 1 1 1 1	

### 6.32 Collect call request

The format of the collect call request parameter field is shown in Figure 49.



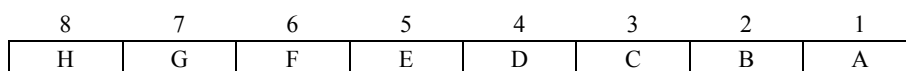
**Figure 49/Q.1902.3 – Collect call request parameter field**

The following codes are used in the collect call request parameter field:

bit <u>A</u>	<i>Collect call request indicator</i>
0	no indication
1	collect call requested
bits H-B	<i>Spare</i>

### 6.33 Conference treatment indicators

The format of the conference treatment indicators parameter field is shown in Figure 50.



**Figure 50/Q.1902.3 – Conference treatment indicators parameter field**

The following codes are used in the conference treatment parameter field:

- bits BA *Conference acceptance indicator* (Note)
  - 0 0 no indication
  - 0 1 accept conference request
  - 1 0 reject conference request
  - 1 1 Spare

NOTE – Applicable to the conference and three-party supplementary services.

- bits G-C *Spare*
- bit H *Extension indicator: as 6.46 a)*

### 6.34 Connected number

The format of the connected number parameter field is shown in Figure 51.

8	7	6	5	4	3	2	1	
O/E	Nature of address indicator						1	
Spare	Numbering plan indicator		Address presentation restricted indicator		Screening indicator		2	
2nd address signal			1st address signal				3	
							:	
							:	
Filler (if necessary)			nth address signal				m	

**Figure 51/Q.1902.3 – Connected number parameter field**

The following codes are used in the subfields of the connected number parameter field:

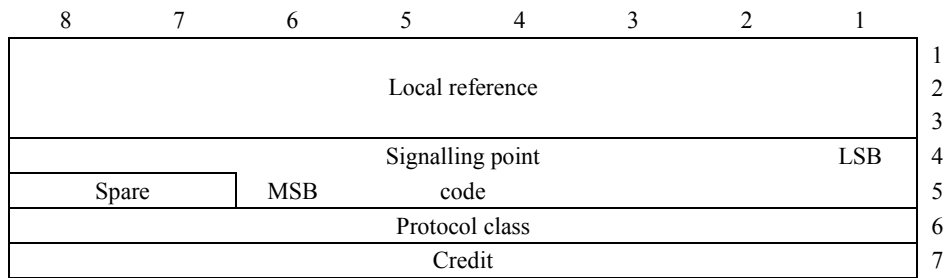
- a) *Odd/even indicator (O/E): as 6.17 a)*
- b) *Nature of address indicator: as 6.20 b)*
- c) *Numbering plan indicator: as 6.17 d)*
- d) *Address presentation restricted indicator:*
  - 0 0 presentation allowed
  - 0 1 presentation restricted
  - 1 0 address not available
  - 1 1 spare

NOTE – If the parameter is included and the address presentation restricted indicator indicates address not available, octets 3 to m are omitted, the subfields in items a), b), and c) are coded with 0's, and the screening indicator is set to 11 (network provided).

- e) *Screening indicator: as 6.20 f)*
- f) *Address signal: as 6.20 g)*
- g) *Filler: as 6.17 f)*

### 6.35 Connection request (ISUP only)

The format of the connection request parameter field is shown in Figure 52.



NOTE – Octets 6 and 7 may be omitted if protocol class requested is 2.

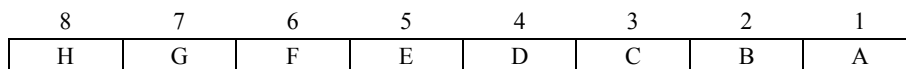
**Figure 52/Q.1902.3 – Connection request parameter field**

The following codes are used in the subfields of the connection request parameter field:

- a) *Local reference*  
A code indicating the local reference allocated by the signalling connection control part to the end-to-end connection.
- b) *Signalling point code*  
A code identifying the signalling point at which the connection request originated.
- c) *Protocol class*  
A code identifying in pure binary representation, the protocol class requested for the end-to-end connection.
- d) *Credit*  
A code identifying in pure binary representation the window size requested for the end-to-end connection.

### 6.36 Continuity indicators

The format of the continuity indicators parameter field is shown in Figure 53.



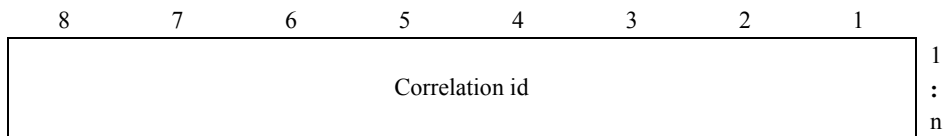
**Figure 53/Q.1902.3 – Continuity indicators parameter field**

The following codes are used in the continuity indicators parameter field:

- bit A *Continuity indicator*
  - 0 continuity check failed (ISUP)/reserved (BICC)
  - 1 continuity check successful (ISUP)/continuity (BICC)
- bits H-B *Spare*

### 6.37 Correlation id

The format of the correlation id parameter field is shown in Figure 54.

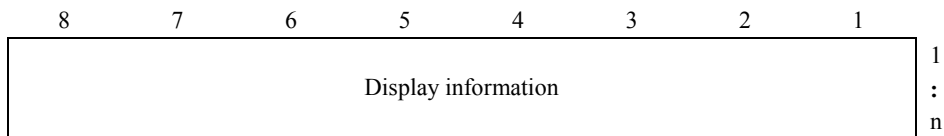


**Figure 54/Q.1902.3 – Correlation id parameter field**

The correlation id is coded as described in ITU-T Q.1218 and Q.1228.

### 6.38 Display information

The format of the display information parameter field is shown in Figure 55.



**Figure 55/Q.1902.3 – Display information parameter field**

The display information is coded as described in ITU-T Q.931.

### 6.39 Echo control information

The format of the echo control information parameter field is shown in Figure 56.



**Figure 56/Q.1902.3 – Echo control information parameter field**

- a) bits BA *Outgoing echo control device information indicator*
  - 0 0 no information
  - 0 1 outgoing echo control device not included and not available
  - 1 0 outgoing echo control device included
  - 1 1 outgoing echo control device not included but available
- b) bits DC *Incoming echo control device information indicator*
  - 0 0 no information
  - 0 1 incoming echo control device not included and not available
  - 1 0 incoming echo control device included
  - 1 1 incoming echo control device not included but available

- c) bits FE      *Outgoing echo control device request indicator*  
       0 0      no information  
       0 1      outgoing echo control device activation request  
       1 0      outgoing echo control device deactivation request (Note 1)  
       1 1      spare

NOTE 1 – This value will not be generated by the Echo Control Logic defined in ITU-T Q.115.

- d) bits HG      *Incoming echo control device request indicator*  
       0 0      no information  
       0 1      incoming echo control device activation request  
       1 0      incoming echo control device deactivation request (Note 2)  
       1 1      spare

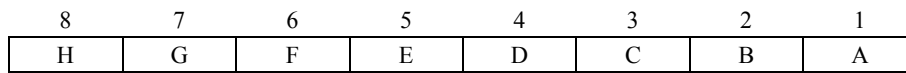
NOTE 2 – This value will not be generated by the Echo Control Logic defined in ITU-T Q.115.

#### 6.40 End of optional parameters

The last optional parameter field of a message is followed by the end of optional parameters octet (see 5.9).

#### 6.41 Event information

The format of the event information parameter field is shown in Figure 57.



**Figure 57/Q.1902.3 – Event information parameter field**

The following codes are used in the event indicator parameter field:

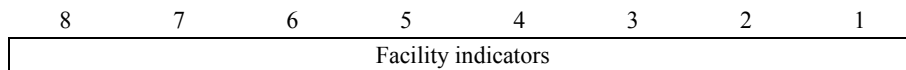
bits <u>GFE DCBA</u>	<i>Event indicator</i>
0 0 0 0 0 0	spare
0 0 0 0 0 1	ALERTING
0 0 0 0 1 0	PROGRESS
0 0 0 0 1 1	in-band information or an appropriate pattern is now available
0 0 0 1 1 0	call forwarded on busy (national use)
0 0 0 1 0 1	call forwarded on no reply (national use)
0 0 0 1 1 0	call forwarded unconditional (national use)
0 0 0 1 1 1	} spare (Note)
to	
1 1 1 1 1 1	

NOTE – Coding of this indicator is frozen; no additional codes can be defined for compatibility.

bit <u>H</u>	<i>Event presentation restricted indicator (national use)</i>
0	no indication
1	presentation restricted

## 6.42 Facility indicator

The format of the facility indicator parameter field is shown in Figure 58.



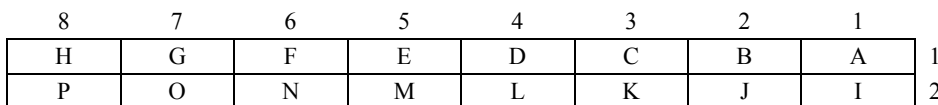
**Figure 58/Q.1902.3 – Facility indicator parameter field**

The following codes are used in the facility indicator parameter field:

0 0 0 0 0 0 0 0	spare	
0 0 0 0 0 0 0 1	spare	
0 0 0 0 0 0 1 0	user-to-user service	
0 0 0 0 0 0 1 1	}	spare
to		
1 1 1 1 1 1 1 1		

## 6.43 Forward call indicators

The format of the forward call indicators parameter field is shown in Figure 59.



**Figure 59/Q.1902.3 – Forward call indicators parameter field**

The following codes are used in the forward call indicators parameter field:

bit <u>A</u>	<i>National/international call indicator</i> (Note 1)
0	call to be treated as a national call
1	call to be treated as an international call
bits <u>CB</u>	<i>End-to-end method indicator</i> (Note 2)
0 0	no end-to-end method available (only link-by-link method available)
0 1	pass-along method available (national use) (ISUP)/reserved (BICC)
1 0	SCCP method available (ISUP)/reserved (BICC)
1 1	pass-along and SCCP methods available (national use) (ISUP)/reserved (BICC)
bit <u>D</u>	<i>Interworking indicator</i> (Note 2)
0	no interworking encountered (Signalling System No. 7/BICC all the way)
1	interworking encountered



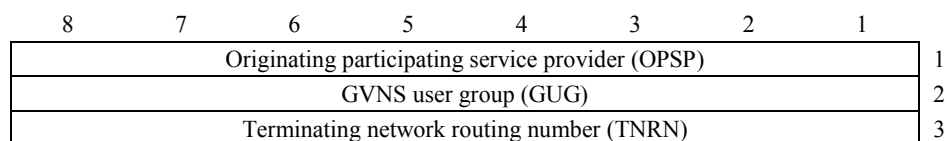
bit <u>E</u>	<i>End-to-end information indicator</i> (national use) (Note 2)
0	no end-to-end information available
1	end-to-end information available (ISUP)/reserved (BICC)
bit <u>F</u>	<i>ISDN user part/BICC indicator</i> (Note 2)
0	ISDN user part/BICC not used all the way
1	ISDN user part/BICC used all the way
bits <u>HG</u>	<i>ISDN user part/BICC preference indicator</i>
0 0	ISDN user part/BICC preferred all the way
0 1	ISDN user part/BICC not required all the way
1 0	ISDN user part/BICC required all the way
1 1	spare
bit <u>I</u>	<i>ISDN access indicator</i>
0	originating access non-ISDN
1	originating access ISDN
bits <u>KJ</u>	<i>SCCP method indicator</i> (Note 2)
0 0	no indication
0 1	connectionless method available (national use) (ISUP)/reserved (BICC)
1 0	connection oriented method available (ISUP)/reserved (BICC)
1 1	connectionless and connection oriented methods available (national use) (ISUP)/reserved (BICC)
bit <u>L</u>	<i>Spare</i>
bits P-M	<i>Reserved for national use</i>

NOTE 1 – Bit A can be set to any value in the country of origin. In the international network this bit is not checked. In the destination country, calls from the international network will have this bit set to 1.

NOTE 2 – Bits B-F and J-K constitute the protocol control indicator (ITU-T Q.730 and Q.1902.6).

#### 6.44 Forward GVNS

The format of the forward GVNS parameter field is shown in Figure 60.



**Figure 60/Q.1902.3 – Forward GVNS parameter field**

The following codes are used in the subfields of the forward GVNS parameter:

a) *Originating participating service provider*

8	7	6	5	4	3	2	1	
O/E	Spare			OPSP length indicator				1
2nd digit				1st digit				1a
:				:				:
Filler (if necessary)				nth digit				1m

**Figure 61/Q.1902.3 – Originating participating service provider subfield**

1) *Odd/even indicator (O/E)*: as 6.17 a)

2) *OPSP length indicator*

Number of octets to follow. The maximum number of octets is 4, allowing for a maximum number of digits to 7.

3) *Digit*

Digit string in BCD encoding of flexible length representing the Originating Participating Service Provider (OPSP) identification.

4) *Filler*

In case of an odd number of address signals, the filler code 0000 is inserted after the last address signal.

b) *GVNS user group*

8	7	6	5	4	3	2	1	
O/E	Spare			GUG length indicator				2
2nd digit				1st digit				2a
:				:				:
Filler (if necessary)				nth digit				2m

**Figure 62/Q.1902.3 – GVNS user group subfield**

1) *Odd/even indicator (O/E)*: as 6.17 a)

2) *GUG length indicator*

Number of octets to follow. The maximum number of octets is 8, allowing for a maximum number of digits to 16.

3) *Digit*

Digit string in BCD encoding of flexible length representing the GVNS user group identification (GUG).

4) *Filler*

In case of an odd number of address signals, the filler code 0000 is inserted after the last address signal.

c) *Terminating network routing number*

8	7	6	5	4	3	2	1	
O/E		Numbering plan indicator			TNRN length indicator			3
Spare		Nature of address indicator						3a
2nd digit				1st digit				3b
:				:				:
Filler (if necessary)				nth digit				3m

**Figure 63/Q.1902.3 – Terminating network routing number subfield**

- 1) *Odd/even indicator (O/E)*: as 6.17 a)
- 2) *Numbering plan indicator*: as 6.17 d)
- 3) *TNRN length indicator*

Number of octets to follow. The maximum number of octets is 9 allowing for a maximum number of digits to 15.

- 4) *Nature of address indicator*

0 0 0 0 0 0	spare
0 0 0 0 0 1	subscriber number (national use)
0 0 0 0 1 0	unknown (national use)
0 0 0 0 1 1	national (significant) number
0 0 0 1 0 0	international number
0 0 0 1 0 1	network specific number
0 0 0 1 1 0	} spare
to	
1 1 0 1 1 1 1	} reserved for national use
1 1 1 0 0 0 0	
to	
1 1 1 1 1 1 0	
1 1 1 1 1 1 1	spare

- 5) *Digit*: as 6.17 e)
- 6) *Filler*: as 6.17 f)

**6.45 Generic digits (national use)**

The format of the generic digits parameter field is shown in Figure 64.

8	7	6	5	4	3	2	1	
Encoding scheme				Type of digits				1
Digits								2
:								:
:								:
:								:
Digits								n

**Figure 64/Q.1902.3 – Generic digits parameter**

The following codes are used in the subfields of the generic digits parameter:

- a) *Encoding scheme*
- |       |                                   |
|-------|-----------------------------------|
| 0 0 0 | BCD even: (even number of digits) |
| 0 0 1 | BCD odd: (odd number of digits)   |
| 0 1 0 | IA5 character                     |
| 0 1 1 | binary coded                      |
| 1 0 0 | } spare                           |
| to    |                                   |
| 1 1 1 |                                   |
- b) *Type of digits*
- |           |   |
|-----------|---|
| 0 0 0 0 0 | reserved for account code                             |
| 0 0 0 0 1 | reserved for authorization code                       |
| 0 0 0 1 0 | reserved for private networking travelling class mark |
| 0 0 0 1 1 | reserved for business communication group identity    |
| 0 0 1 0 0 | } reserved for national use                           |
| to        |   |
| 1 1 1 1 0 |   |
| 1 1 1 1 1 | reserved for extension                                |
- c) *Digit*
- Coding in accordance with the coding scheme and type of digits.

#### 6.46 Generic notification indicator

The format of the generic notification indicator parameter field is shown in Figure 65.



**Figure 65/Q.1902.3 – Generic notification indicator parameter field**

The following codes are used in the generic notification indicator parameter field:

- a) *Extension indicator (ext.)*
- |   |   |
|---|---|
| 0 | information continues in the next octet |
| 1 | last octet                              |
- b) *Notification indicator*
- |               |  |                  |
|---------------|--|------------------|
| 0 0 0 0 0 0 0 | user suspended   | } (used in DSS1) |
| 0 0 0 0 0 0 1 | user resumed   |                  |
| 0 0 0 0 0 1 0 | bearer service change                                  |                  |
| 0 0 0 0 0 1 1 | discriminator for extension to ASN.1 encoded component |                  |
| 0 0 0 0 1 0 0 | call completion delay                                  |                  |

0 0 0 0 1 0 1	}	reserved
to		
1 0 0 0 0 0 1		
1 0 0 0 0 1 0		conference established
1 0 0 0 0 1 1		conference disconnected
1 0 0 0 1 0 0		other party added
1 0 0 0 1 0 1		isolated
1 0 0 0 1 1 0		reattached
1 0 0 0 1 1 1		other party isolated
1 0 0 1 0 0 0		other party reattached
1 0 0 1 0 0 1		other party split
1 0 0 1 0 1 0		other party disconnected
1 0 0 1 0 1 1		conference floating
1 0 0 1 1 0 0	}	reserved
to		
1 0 1 1 1 1 1		
1 1 0 0 0 0 0		call is a waiting call
1 1 0 0 0 0 1	}	reserved
to		
1 1 0 0 1 1 1		
1 1 0 1 0 0 0		diversion activated (used in DSS1)
1 1 0 1 0 0 1		call transfer, alerting
1 1 0 1 0 1 0		call transfer, active
1 1 0 1 0 1 1	}	reserved
to		
1 1 1 1 0 0 0		
1 1 1 1 0 0 1		remote hold
1 1 1 1 0 1 0		remote retrieval
1 1 1 1 0 1 1		call is diverting
1 1 1 1 1 0 0	}	reserved
to		
1 1 1 1 1 1 1		

## 6.47 Generic number

The format of the generic number parameter field is shown in Figure 66.

8	7	6	5	4	3	2	1	
Number qualifier indicator								1
O/E	Nature of address indicator							2
NI	Numbering plan indicator			Address presentation restricted indicator		Screening indicator		3
2nd address signal				1st address signal				4
								:
								:
Filler (if necessary)				nth address signal				m

**Figure 66/Q.1902.3 – Generic number parameter field**

The following codes are used in the generic number parameter field:

a) *Number qualifier indicator*

0 0 0 0 0 0 0	reserved (dialled digits) (national use)
0 0 0 0 0 0 1	additional called number (national use)
0 0 0 0 0 1 0	reserved (supplemental user provided calling number – failed network screening) (national use)
0 0 0 0 0 1 1	reserved (supplemental user provided calling number – not screened) (national use)
0 0 0 0 1 0 0	reserved (redirecting terminating number) (national use)
0 0 0 0 1 0 1	additional connected number
0 0 0 0 1 1 0	additional calling party number
0 0 0 0 1 1 1	reserved for additional original called number
0 0 0 0 1 0 0 0	reserved for additional redirecting number
0 0 0 0 1 0 0 1	reserved for additional redirection number
0 0 0 0 1 0 1 0	reserved (used in ISUP'92)
0 0 0 0 1 0 1 1	} spare
to	
0 1 1 1 1 1 1 1	
1 0 0 0 0 0 0 0	} reserved for national use
to	
1 1 1 1 1 1 1 0	
1 1 1 1 1 1 1 1	reserved for expansion

b) *Odd/even indicator (O/E):* as 6.17 a)

c) *Nature of address indicator*

0 0 0 0 0 0	spare
0 0 0 0 0 1	subscriber number (national use)
0 0 0 0 0 1 0	unknown (national use)
0 0 0 0 0 1 1	national (significant) number
0 0 0 0 1 0 0	international number
0 0 0 0 1 0 1	PISN specific number (national use)
0 0 0 0 1 1 0	} spare
to	
1 1 0 1 1 1 1	
1 1 1 0 0 0 0	} reserved for national use
to	
1 1 1 1 1 1 0	
1 1 1 1 1 1 1	spare

NOTE 1 – For each supplementary service the relevant codes and possible default settings are described in the supplementary service Recommendations (ITU-T Q.73x-series and Q.1902.6).

d) *Number incomplete indicator (NI)*

0	number complete
1	number incomplete

e) *Numbering plan indicator*

0 0 0	unknown (national use)
0 0 1	numbering plan according to ITU-T E.164
0 1 0	spare
0 1 1	numbering plan according to ITU-T X.121 (national use)
1 0 0	numbering plan according to ITU-T F.69 (national use)
1 0 1	private numbering plan (national use)
1 1 0	reserved for national use
1 1 1	spare

NOTE 2 – For each supplementary service the relevant codes and possible default settings are described in the supplementary service Recommendations (ITU-T Q.73x-series and Q.1902.6).

f) *Address presentation restricted indicator*

0 0	presentation allowed
0 1	presentation restricted
1 0	address not available
1 1	spare

NOTE 3 – For each supplementary service the relevant codes and possible default settings are described in the supplementary service Recommendations (ITU-T Q.73x-series and Q.1902.6). When the address presentation restricted indicator indicates address not available, the subfields in items b), c), d), and e) are coded with 0's, and the screening indicator is set to 11 (network provided).

g) *Screening indicator*

Only used if the number qualifier indicator is coded 0000 0101 (additional connected number) or 0000 0110 (additional calling party number). This indicator is coded as follows:

- 0 0 user provided, not verified
- 0 1 user provided, verified and passed
- 1 0 user provided, verified and failed
- 1 1 network provided

NOTE 4 – For each supplementary service the relevant codes and possible default settings are described in the supplementary service Recommendations (ITU-T Q.73x-series and Q.1902.6).

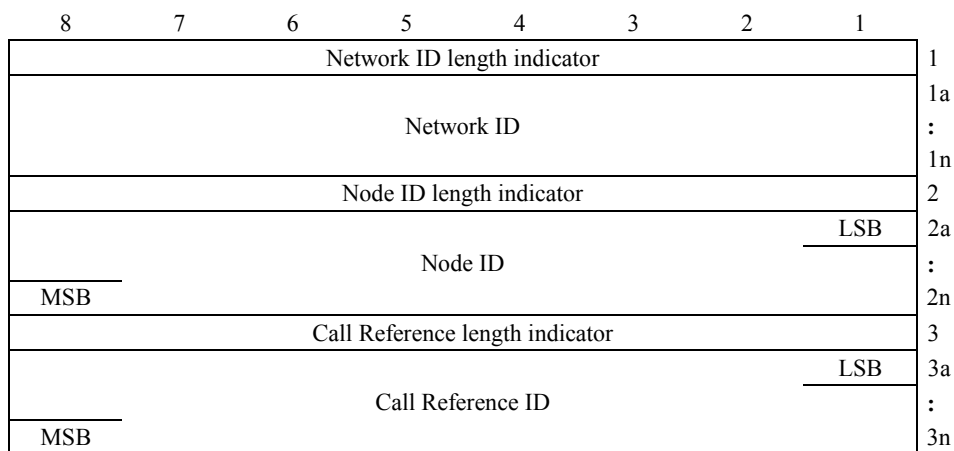
h) *Address signal:*

- 0 0 0 0 digit 0
- 0 0 0 1 digit 1
- 0 0 1 0 digit 2
- 0 0 1 1 digit 3
- 0 1 0 0 digit 4
- 0 1 0 1 digit 5
- 0 1 1 0 digit 6
- 0 1 1 1 digit 7
- 1 0 0 0 digit 8
- 1 0 0 1 digit 9
- 1 0 1 0 } spare
- to }
- 1 1 1 1 }

i) *Filler:* as 6.17 f)

**6.48 Global call reference**

The format of the global call reference parameter field is shown in Figure 67.



**Figure 67/Q.1902.3 – Global call reference parameter field**



The following codes are used in the subfields of the global call reference parameter field:

a) *Network ID*

The Network ID contains the value field (coded according to ASN.1 BER) of an object identifier identifying the network. This means that the tag and length fields are omitted.

An example of such an object identifier can be the following:

– {itu-t (0) administration (2) national regulatory authority (x) network (y)}

The value for x is the value of the national regulatory authority (one of the Data Country Codes associated to the country as specified in ITU-T X.121 shall be used for "national regulatory authority"), the value for y is under the control of the national regulatory authority concerned.

b) *Node ID*

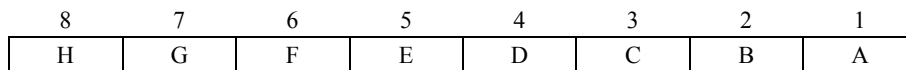
A binary number that uniquely identifies within the network the node which generates the call reference.

c) *Call Reference ID*

A binary number used for the call reference of the call. This is generated by the node for each call.

**6.49 Hop counter**

The format of the hop counter parameter field is shown in Figure 68.



**Figure 68/Q.1902.3 – Hop counter parameter field**

The following codes are used in the hop counter parameter field:

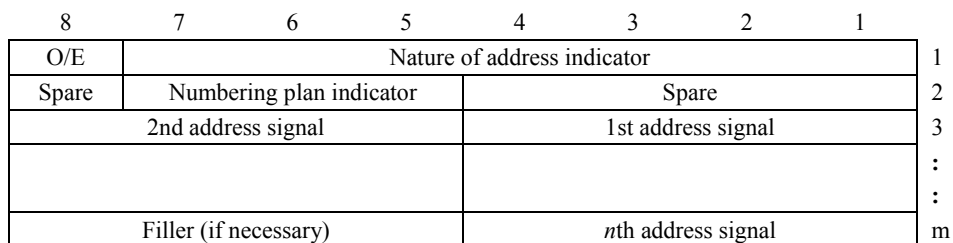
bits E D C B A      *Hop counter*

The hop counter contains the binary value of the number of contiguous SS No. 7 interexchange circuits (ISUP)/call control associations (BICC) that are allowed to complete the call.

bits H G F      *Spare*

**6.50 HTR information**

The format of the HTR information parameter field corresponds to the format shown in Figure 69.



**Figure 69/Q.1902.3 – HTR information parameter field**

The following codes are used in the subfields of the HTR information parameter field:

- a) *Odd/even indicator (O/E)*: as 6.17 a)
- b) *Nature of address indicator*: as 6.17 b)
- c) *Numbering plan indicator*: as 6.17 d)
- d) *Address signal*: as 6.17 e)
- e) *Filler*: as 6.17 f).

### 6.51 Information indicators (national use)

The format of the information indicators parameter field is shown in Figure 70.

8	7	6	5	4	3	2	1	
H	G	F	E	D	C	B	A	1
P	O	N	M	L	K	J	I	2

**Figure 70/Q.1902.3 – Information indicators parameter field**

The following codes are used in the information indicators parameter field:

- bits BA *Calling party address response indicator*
  - 0 0 calling party address not included
  - 0 1 calling party address not available
  - 1 0 spare
  - 1 1 calling party address included
  
- bit C *Hold provided indicator*
  - 0 hold not provided
  - 1 hold provided
- bits ED *Spare*
  
- bit F *Calling party's category response indicator*
  - 0 calling party's category not included
  - 1 calling party's category included
  
- bit G *Charge information response indicator*
  - 0 charge information not included
  - 1 charge information included
  
- bit H *Solicited information indicator*
  - 0 solicited
  - 1 unsolicited
  
- bits L-I *Spare*
  
- bits P-M *Reserved*

## 6.52 Information request indicators (national use)

The format of the information request indicators parameter field is shown in Figure 71.

8	7	6	5	4	3	2	1	
H	G	F	E	D	C	B	A	1
P	O	N	M	L	K	J	I	2

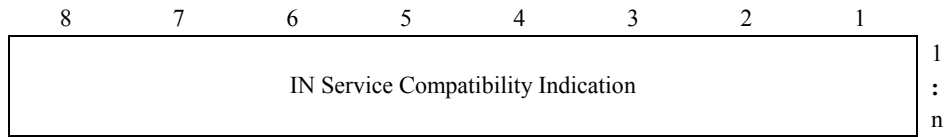
**Figure 71/Q.1902.3 – Information request indicators parameter field**

The following codes are used in the information request indicators parameter field:

- bit A      *Calling party address request indicator*
  - 0          calling party address not requested
  - 1          calling party address requested
  
- bit B      *Holding indicator*
  - 0          holding not requested
  - 1          holding requested
  
- bit C      *Spare*
  
- bit D      *Calling party's category request indicator*
  - 0          calling party's category not requested
  - 1          calling party's category requested
  
- bit E      *Charge information request indicator*
  - 0          charge information not requested
  - 1          charge information requested
  
- bits GF     *Spare*
  
- bit H      *Malicious call identification request indicator (reserved, used in ISUP'88 Blue Book)*
  - 0          malicious call identification not requested
  - 1          malicious call identification requested
  
- bits L-I     *Spare*
- bits P-M     *Reserved*

### 6.53 IN Service Compatibility

The format of the IN Service Compatibility parameter field is shown in Figure 72.

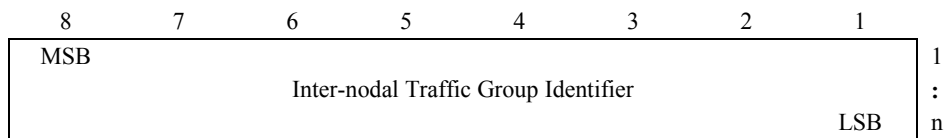


**Figure 72/Q.1902.3 – IN Service Compatibility parameter field**

The IN Service Compatibility Indication is coded according to the content of the INServiceCompatibilityIndication parameter defined in ITU-T Q.1228.

### 6.54 Inter-nodal Traffic Group Identifier

The format of the Inter-nodal Traffic Group Identifier parameter field is shown in Figure 73.

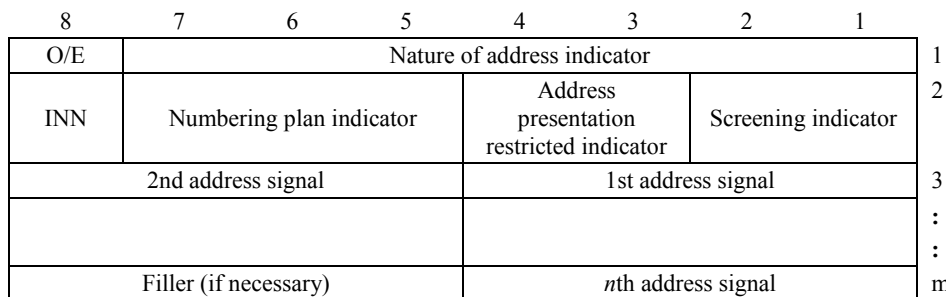


**Figure 73/Q.1902.3 – Inter-nodal Traffic Group Identifier parameter field**

The Inter-nodal Traffic Group Identifier carries a binary value representing the traffic group for the call.

### 6.55 Location number

The format of the location number field is shown in Figure 74.



**Figure 74/Q.1902.3 – Location number parameter field**

The following codes are used in the subfields of the location number parameter field:

- a) *Odd/even indicator (O/E)*: as 6.17 a)
- b) *Nature of address indicator*
  - 0 0 0 0 0 0 spare
  - 0 0 0 0 0 1 reserved for subscriber number (national use)
  - 0 0 0 0 1 0 reserved for unknown (national use)
  - 0 0 0 0 1 1 national (significant) number (national use)

0 0 0 0 1 0 0	international number
0 0 0 0 1 0 1	} spare
to	
1 1 0 1 1 1 1	
1 1 1 0 0 0 0	} reserved for national use
to	
1 1 1 1 1 1 0	
1 1 1 1 1 1 1	spare

c) *Internal Network Number indicator (INN)*

0	routing to internal number allowed
1	routing to internal number not allowed

d) *Numbering plan indicator*

0 0 0	spare
0 0 1	numbering plan according to ITU-T E.164
0 1 0	spare
0 1 1	numbering plan according to ITU-T X.121 (national use)
1 0 0	numbering plan according to ITU-T F.69 (national use)
1 0 1	private numbering plan
1 1 0	reserved for national use
1 1 1	spare

e) *Address presentation restricted indicator*

0 0	presentation allowed
0 1	presentation restricted
1 0	address not available (national use)
1 1	spare

NOTE – When the address presentation restricted indicator indicates address not available, the subfields in items a), b), c) and d) are coded with 0's, and the screening indicator is set to 11 (network provided).

f) *Screening indicator*

0 0	reserved
0 1	user provided, verified and passed
1 0	reserved
1 1	network provided

g) *Address signals*: as 6.47 h)

h) *Filler*: as 6.17 f)

### 6.56 Loop prevention indicators

The format of the loop prevention indicators parameter field is shown in Figure 75.

8	7	6	5	4	3	2	1
H	G	F	E	D	C	B	A

**Figure 75/Q.1902.3 – Loop prevention indicators parameter field**

The following codes are used in the loop prevention indicators parameter field:

- bit A     *Type*
- 0     request
- 1     response

If bit A equals to 0 (request):

- bits H-B    *Spare*

If bit A equals to 1 (response):

- bits C B    *Response indicator*
- 0 0     insufficient information (Note)
- 0 1     no loop exists
- 1 0     simultaneous transfer
- 1 1     spare

- bits H-D    *Spare*

NOTE – The value "insufficient information" may be received due to interworking.

### 6.57 MCID request indicators

The format of the MCID request indicators parameter field is shown in Figure 76.

8	7	6	5	4	3	2	1
H	G	F	E	D	C	B	A

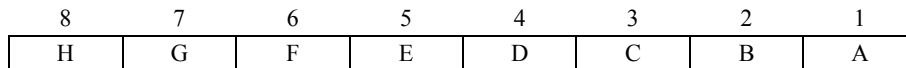
**Figure 76/Q.1902.3 – MCID request indicators parameter field**

The following codes are used in the MCID request indicators parameter field:

- bit A     *MCID request indicator*
- 0     MCID not requested
- 1     MCID requested
- bit B     *Holding indicator (national use)*
- 0     holding not requested
- 1     holding requested
- bits H-C    *Spare*

### 6.58 MCID response indicators

The format of the MCID response indicators parameter field is shown in Figure 77.



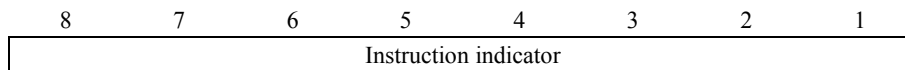
**Figure 77/Q.1902.3 – MCID response indicators parameter field**

The following codes are used in the MCID response indicators parameter field:

- bit A     *MCID response indicator*
- 0     MCID not included
- 1     MCID included
- bit B     *Hold provided indicator (national use)*
- 0     holding not provided
- 1     holding provided
- bits H-C    *Spare*

### 6.59 Message compatibility information

The format of the message compatibility information parameter field is shown in Figure 78.

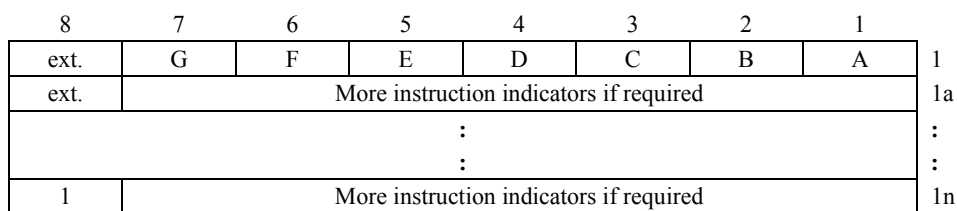


**Figure 78/Q.1902.3 – Message compatibility information parameter field**

The following codes are used in the subfields of the message compatibility information parameter field:

a) *Instruction indicators*

The format of the instruction indicators subfield is shown Figure 79.



**Figure 79/Q.1902.3 – Instruction indicators subfield**

The following codes are used in the instructions indicators subfield:

- bit A     *Transit at intermediate SN/exchange indicator*
- 0     transit interpretation
- 1     end node interpretation

- bit B     *Release call indicator*  
           0     do not release call  
           1     release call
- bit C     *Send notification indicator*  
           0     do not send notification  
           1     send notification
- bit D     *Discard message indicator*  
           0     do not discard message (pass on)  
           1     discard message
- bit E     *Pass on not possible indicator*  
           0     release call  
           1     discard information
- bits G F   *Broadband/narrow-band interworking indicator*  
           0 0    pass on  
           0 1    discard message  
           1 0    release call  
           1 1    reserved, assume 00

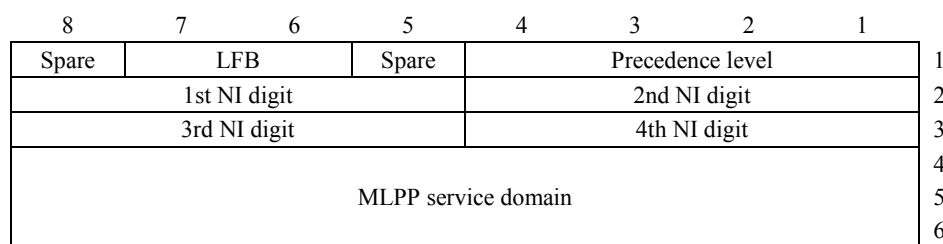
b) *Extension indicator (ext.):* as 6.46 a)

c) *More instruction indicators*

The bits will be defined when required.

### 6.60 MLPP precedence

The format of the MLPP precedence parameter field is shown in Figure 80.



**Figure 80/Q.1902.3 – MLPP precedence parameter field**

The following codes are used in the subfields of the MLPP precedence parameter field:

- a) *LFB (Look ahead for busy)*  
       0 0     LFB allowed  
       0 1     path reserved (national use)  
       1 0     LFB not allowed  
       1 1     spare



- b) *Precedence level*
- |         |                |
|---------|----------------|
| 0 0 0 0 | flash override |
| 0 0 0 1 | flash          |
| 0 0 1 0 | immediate      |
| 0 0 1 1 | priority       |
| 0 1 0 0 | Routine        |
| 0 1 0 1 | } spare        |
| to      |                |
| 1 1 1 1 |                |

- c) *Network Identity (NI) octets 2 and 3*

Each digit is coded in binary coded decimal representation from 0 to 9.

The first digit of this field is coded 0. The Telephony Country Code (TCC) follows in the second to fourth NI digits (the most significant TCC digit is in the 2nd NI digit). If the TCC is one or two digits long, the excess digit(s) is inserted with the code for ROA or network identification, if necessary. If octet 3 is not required, it is coded all zeros.

- d) *MLPP service domain (octets 4, 5 and 6)*

A code pure binary coded allocated to a MLPP service domain administered by a particular ISDN. Bit 8 of octet 4 is the most significant and bit 1 of octet 6 is the least significant respectively.

### 6.61 Nature of connection indicators

The format of the nature of connection indicators parameter field is shown in Figure 81.



**Figure 81/Q.1902.3 – Nature of connection indicators parameter field**

The following codes are used in the nature of connection indicators parameter field:

bits BA *Satellite indicator*

- |     |  |
|-----|--|
| 0 0 | no satellite circuit in the connection   |
| 0 1 | one satellite circuit in the connection  |
| 1 0 | two satellite circuits in the connection |
| 1 1 | spare                                    |

bits DC *Continuity check indicator (ISUP)/Continuity indicator (BICC)*

- |     |   |
|-----|---|
| 0 0 | continuity check not required (ISUP)/no COT to be expected (BICC)                 |
| 0 1 | continuity check required on this circuit (ISUP)/reserved (BICC)                  |
| 1 0 | continuity check performed on a previous circuit (ISUP)/COT to be expected (BICC) |
| 1 1 | spare   |

- bit E      *Echo control device indicator*
- 0      outgoing echo control device not included
- 1      outgoing echo control device included
- bits H-F    *Spare*

### 6.62 Network management controls

The format of the network management controls parameter field is shown in Figure 82.

8	7	6	5	4	3	2	1
H	G	F	E	D	C	B	A

**Figure 82/Q.1902.3 – Network management controls parameter field**

The following codes are used in the network management controls parameter field:

- bit A      *Temporary Alternative Routing (TAR) indicator*
- 0      no indication
- 1      TAR controlled call
- bits G-B    *Spare*
- bit H      *Extension indicator: as 6.46 a)*

### 6.63 Network routing number (national use)

The format of the network routing number parameter field is shown in Figure 83.

8	7	6	5	4	3	2	1	
O/E	Numbering plan indicator			Nature of address indicator			1	
2nd address signal				1st address signal			2	
							:	
							:	
Filler (if necessary)				nth address signal			m	

**Figure 83/Q.1902.3 – Network routing number parameter field**

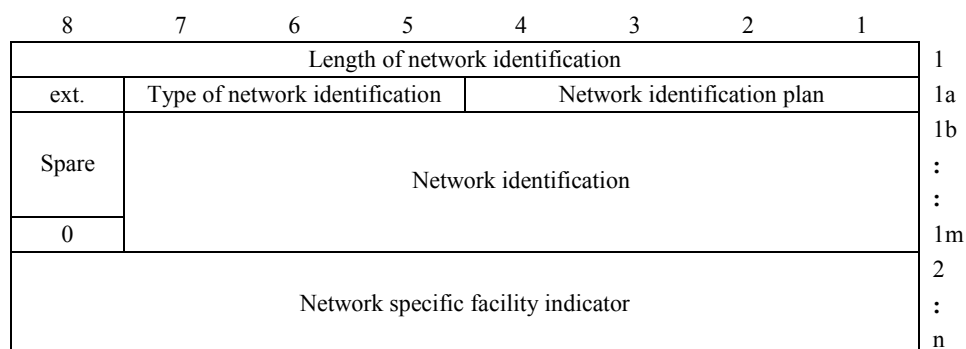
The following codes are used in the subfields of the network routing number parameter:

- a) *Odd/even indicator (O/E): as 6.17 a)*
- b) *Numbering plan indicator*
- 0 0 0      spare
- 0 0 1      numbering plan according to ITU-T E.164
- 0 1 0      spare
- 0 1 1      spare
- 1 0 0      spare
- 1 0 1      spare
- 1 1 0      reserved for national use
- 1 1 1      reserved for national use

- c) *Nature of address indicator*
- |         |   |
|---------|---|
| 0 0 0 0 | spare   |
| 0 0 0 1 | network routing number in national (significant) number format (national use) |
| 0 0 1 0 | network routing number in network specific number format (national use)       |
| 0 0 1 1 | } spare   |
| to      |   |
| 1 0 1 0 | } reserved for national use   |
| to      |   |
| 1 0 1 1 | } reserved for national use   |
| 1 1 1 1 |   |
- d) *Address signal*
- |         |         |
|---------|---------|
| 0 0 0 0 | digit 0 |
| 0 0 0 1 | digit 1 |
| 0 0 1 0 | digit 2 |
| 0 0 1 1 | digit 3 |
| 0 1 0 0 | digit 4 |
| 0 1 0 1 | digit 5 |
| 0 1 1 0 | digit 6 |
| 0 1 1 1 | digit 7 |
| 1 0 0 0 | digit 8 |
| 1 0 0 1 | digit 9 |
| 1 0 1 0 | spare   |
| 1 0 1 1 | spare   |
| 1 1 0 0 | spare   |
| 1 1 0 1 | spare   |
| 1 1 1 0 | spare   |
| 1 1 1 1 | spare   |
- e) *Filler*: as 6.17 f)

### 6.64 Network specific facility (national use)

The format of the network specific facility parameter field is shown in Figure 84.



**Figure 84/Q.1902.3 – Network specific facility parameter field**

The following codes are used in the subfields of the network specific facility parameter field:

a) *Length of network identification*

This field contains the length, in octets, of the network identification found in octets 1a, 1b-1m. If the value is 0000 0000, then octets 1a-1m are omitted.

b) *Extension (ext.): as 6.46 a)*

c) *Type of network identification*

The following codes are used in the type of network identification subfield:

- 0 1 0      national network identification
- 0 1 1      reserved for international network identification (Note)
- 1 0 0 }  
to } spare  
1 1 1 }

When the type of network identification is coded 010 "national network identification", the network identification plan and network identification are coded nationally.

NOTE – The value 011 is reserved for international use, in case the parameter will be accepted for international use in the future.

d) *Network identification plan*

e) *Network identification*

f) *Network-specific facility indicator*

This field is encoded according to the rules specified by the identified network. The network may specify the same coding rule as stimulus type of information elements in ITU-T Q.932. In this case multiple information elements may be included in this field.

**6.65 Number portability forward information (network option)**

The format of the number portability forward information parameter field is shown in Figure 85.



**Figure 85/Q.1902.3 – Number portability forward information parameter field**

The following codes are used in the number portability forward information parameter field:

a) bits DCBA      *Number portability status indicator*

- 0 0 0 0      no indication
- 0 0 0 1      number portability query not done for called number
- 0 0 1 0      number portability query done for called number, non-ported called subscriber
- 0 0 1 1      number portability query done for called number, ported called subscriber
- 1 0 0 }  
to } spare  
1 1 1 }

b) bits GFE      *Spare*

c) bit H      *Extension indicator: as 6.46 a)*

### 6.66 Optional backward call indicators

The format and codes of the optional backward call indicators field is shown in Figure 86.

8	7	6	5	4	3	2	1
H	G	F	E	D	C	B	A

**Figure 86/Q.1902.3 – Optional backward call indicators parameter field**

The following codes are used in the optional backward call indicators parameter field:

- bit A      *In-band information indicator*
  - 0      no indication
  - 1      in-band information or an appropriate pattern is now available
- bit B      *Call diversion may occur indicator*
  - 0      no indication
  - 1      Call diversion may occur
- bit C      *Simple segmentation indicator*
  - 0      no additional information will be sent
  - 1      additional information will be sent in a segmentation message
- bit D      *MLPP user indicator*
  - 0      no indication
  - 1      MLPP user
- bits H-E    *Reserved for national use*

### 6.67 Optional forward call indicators

The format of the optional forward call indicators parameter field is shown in Figure 87.

8	7	6	5	4	3	2	1
H	G	F	E	D	C	B	A

**Figure 87/Q.1902.3 – Optional forward call indicators parameter field**

The following codes are used in the optional forward call indicators parameter field:

- bits BA    *Closed user group call indicator*
  - 0 0    non-CUG call
  - 0 1    spare
  - 1 0    closed user group call, outgoing access allowed
  - 1 1    closed user group call, outgoing access not allowed
- bit C      *Simple segmentation indicator*
  - 0      no additional information will be sent
  - 1      additional information will be sent in a segmentation message
- bits G-D    *Spare*

bit <u>H</u>	<i>Connected line identity request indicator</i>
0	not requested
1	requested

### 6.68 Original Called IN number

The format of the original called IN number parameter corresponds to the original called number parameter (see 6.69).

### 6.69 Original called number

The format of the original called number parameter field is shown in Figure 88.

8	7	6	5	4	3	2	1	
O/E	Nature of address indicator						1	
Spare	Numbering plan indicator			Address presentation restricted indicator		Spare		2
2nd address signal				1st address signal				3
								:
								:
Filler (if necessary)				nth address signal				m

**Figure 88/Q.1902.3 – Original called number parameter field**

The following codes are used in the subfields of the original called number parameter field:

a) *Odd/even indicator (O/E)*: as 6.17 a)

b) *Nature of address indicator*:

0 0 0 0 0 0	spare
0 0 0 0 0 1	subscriber number (national use)
0 0 0 0 1 0	unknown (national use)
0 0 0 0 1 1	national (significant) number (national use)
0 0 0 0 1 0 0	international number
0 0 0 0 1 0 1	} spare
to	
1 1 0 1 1 1 1	
1 1 1 0 0 0 0	} reserved for national use
to	
1 1 1 1 1 1 0	
1 1 1 1 1 1 1	spare

c) *Numbering plan indicator*: as 6.17 d)

d) *Address presentation restricted indicator*: as 6.20 e)

e) *Address signal*: as 6.20 g)

f) *Filler*: as 6.17 f)

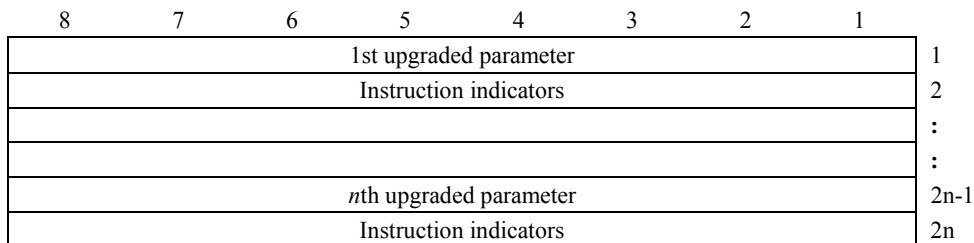
### 6.70 Origination ISC point code

The format of the origination ISC point code parameter field is shown in Figure 113.

NOTE – This parameter will not be generated by BICC.

### 6.71 Parameter compatibility information

The format of the parameter compatibility information parameter field is shown in Figure 89.



**Figure 89/Q.1902.3 – Parameter compatibility information parameter field**

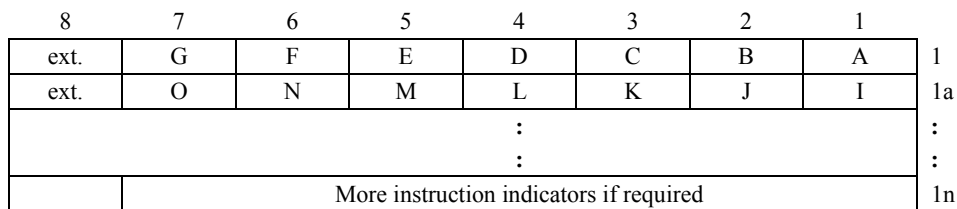
The following codes are used in the subfields of the parameter compatibility information parameter field:

- a) *Nth upgraded parameter name*

This field contains the parameter name of the *n*th upgraded parameter in accordance with Table 2.

- b) *Instruction indicators*

The format of the instruction indicators subfield is shown in Figure 90.



**Figure 90/Q.1902.3 – Instruction indicators subfield**

The following codes are used in the instructions indicators subfield:

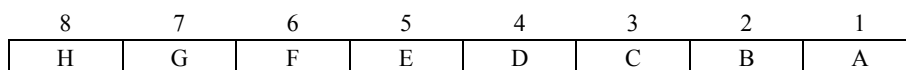
- bit A     *Transit at intermediate SN/exchange indicator*  
 0     transit interpretation  
 1     end node interpretation
- bit B     *Release call indicator*  
 0     do not release call  
 1     release call
- bit C     *Send notification indicator*  
 0     do not send notification  
 1     send notification

- bit D     *Discard message indicator*
  - 0     do not discard message (pass on)
  - 1     discard message
- bit E     *Discard parameter indicator*
  - 0     do not discard parameter (pass on)
  - 1     discard parameter
- bits G F   *Pass on not possible indicator*
  - 0 0   release call
  - 0 1   discard message
  - 1 0   discard parameter
  - 1 1   reserved (interpreted as 00)
- c)    *Extension indicator (ext.): as 6.46 a)*
- d)    bits J I   *Broadband/narrow-band interworking indicator*
  - 0 0   pass on
  - 0 1   discard message
  - 1 0   release call
  - 1 1   discard parameter
- e)    bits O-K   *Spare*
- f)    *More instruction indicators*

The bits will be defined when required.

### 6.72 Pivot capability

The format of the pivot capability parameter field is shown in Figure 91.



**Figure 91/Q.1902.3 – Pivot capability parameter field**

The following codes are used in the pivot capability parameter field:

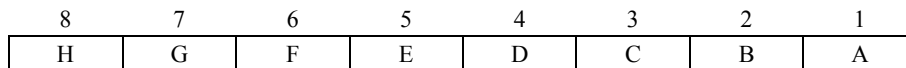
- bits CBA   *Pivot possible indicator*
  - 0 0 0   no indication
  - 0 0 1   pivot routing possible before ACM
  - 0 1 0   pivot routing possible before ANM
  - 0 1 1   pivot routing possible any time during the call
  - 1 0 0 }  
to } spare
  - 1 1 1 }
- bits FED    *Spare*



bit G     *Interworking to redirection indicator (national use)*  
           0     allowed (forward)  
           1     not allowed (forward)  
 bit H     *Extension indicator: as 6.46 a)*

### 6.73 Pivot Counter

The format of the pivot counter parameter field is shown in Figure 92.



**Figure 92/Q.1902.3 – Pivot counter parameter field**

The following codes are used in the pivot counter parameter field:

bits EDCBA   *Pivot counter*  
                   binary value of the number of redirections  
 bits HGF     *Spare*

### 6.74 Pivot routing backward information

The pivot routing backward information parameter is a constructor with format as shown in Figure 93.

The values of the information type tag are:

0000 0000	reserved
0000 0001	return to invoking exchange duration (national use)
0000 0010	return to invoking exchange call identifier (national use)
0000 0011	invoking pivot reason
0000 0100	} spare
to	
1111 1111	

#### 6.74.1 Return to invoking exchange duration (national use)

Return to invoking exchange duration is encoded in units of seconds as a variable length (of length 1-2 octets) integer with the least significant bit in the first octet.

#### 6.74.2 Return to invoking exchange call identifier (national use)

The format of the return to invoking exchange call identifier is shown in Figure 18, and the encoding is identical to that of the Call Reference parameter as shown in 6.12.

#### 6.74.3 Invoking pivot reason

The format and coding of the invoking pivot reason are given in 6.75.4.

### 6.75 Pivot routing forward information

The pivot routing forward information parameter is a constructor with format as shown in Figure 93.

8	7	6	5	4	3	2	1	
Information type tag								1
Information type length								2
Information type value								3
:								:
:								:
Information type tag								n+1
Information type length								n+2
Information type value								n+3

**Figure 93/Q.1902.3 – Pivot routing forward information parameter field**

The values of the information type tag are:

0000 0000	reserved	
0000 0001	return to invoking exchange possible (national use)	
0000 0010	return to invoking exchange call identifier (national use)	
0000 0011	performing pivot indicator	
0000 0100	invoking pivot reason	
0000 0101	}	spare
to		
1111 1111		

#### 6.75.1 Return to invoking exchange possible (national use)

Return to invoking exchange possible has length zero and has no information type value.

#### 6.75.2 Return to invoking exchange call identifier (national use)

The format of the return to invoking exchange call identifier is shown in Figure 18, and the encoding is identical with that of the Call Reference parameter as shown in 6.12.

#### 6.75.3 Performing pivot indicator

The format of the performing pivot indicator is shown in Figure 94.

8	7	6	5	4	3	2	1	
ext.	Performing pivot reason						1	
Spare					Pivot possible indicator at performing exchange		2	Reason 1
:								
:								
ext.	Performing pivot reason						2n-1	
Spare					Pivot possible indicator at performing exchange		2n	Reason n

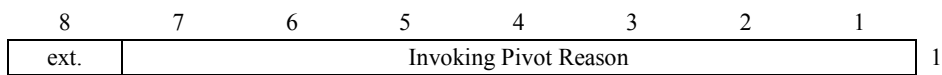
**Figure 94/Q.1902.3 – Performing pivot indicator**

The following codes are used in the performing pivot indicator:

- a) *Extension indicator (ext.):* as 6.46 a)
- b) *Performing Pivot Reason (octet 2n – 1)*
  - 0 0 0 0 0 0 0      unknown/ not available
  - 0 0 0 0 0 0 1      service provider portability (national use)
  - 0 0 0 0 0 1 0      reserved for location portability
  - 0 0 0 0 0 1 1      reserved for service portability
  - 0 0 0 0 1 0 0 }  
to } spare
  - 0 1 1 1 1 1 1 }
  - 1 0 0 0 0 0 0 }  
to } reserved for national use
  - 1 1 1 1 1 1 1 }
- c) *Pivot Possible Indicator at Performing Exchange (octet 2n)*
  - 0 0 0      no indication
  - 0 0 1      pivot routing possible before ACM
  - 0 1 0      pivot routing possible before ANM
  - 0 1 1      pivot routing possible any time during the call
  - 1 0 0 }  
to } spare
  - 1 1 1 }

#### 6.75.4 Invoking pivot reason

The format of the invoking pivot reason is shown in Figure 95.



**Figure 95/Q.1902.3 – Invoking pivot reason**

The coding of the invoking pivot reason is identical to that of the performing pivot indicator as shown in 6.75.3 a) and b).

#### 6.76 Pivot routing indicators

The format of the pivot routing indicators parameter field is shown in Figure 96.



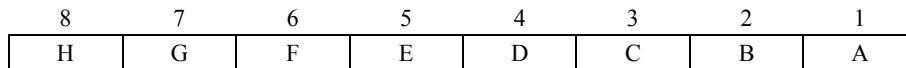
**Figure 96/Q.1902.3 – Pivot routing indicators parameter field**

The following codes are used in the pivot routing indicators parameter field:

bit	<u>GFEDCBA</u>	<i>Pivot routing indicators</i>
	0000000	no indication
	0000001	pivot request
	0000010	cancel pivot request
	0000011	pivot request failure
	0000100	interworking to redirection prohibited (backward) (national use)
	0000101	} spare
	to	
	1111111	
bit	H	<i>Extension indicator: as 6.46 a)</i>

### 6.77 Pivot status (national use)

The format of the pivot status parameter field is shown in Figure 97.

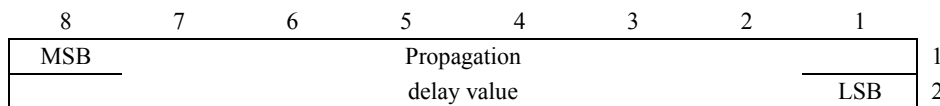


**Figure 97/Q.1902.3 – Pivot status indicator parameter field**

bits	<u>BA</u>	<i>Pivot status indicator</i>
	00	no indication
	01	acknowledgment of pivot routing
	10	pivot routing will not be invoked
	11	spare
bits	<u>GFEDC</u>	<i>Spare</i>
bit	H	<i>Extension indicator: as 6.46 a)</i>

### 6.78 Propagation delay counter

The format of the propagation delay counter parameter field is shown in Figure 98.

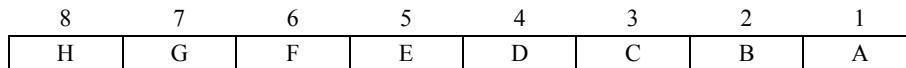


**Figure 98/Q.1902.3 – Propagation delay counter parameter field**

The propagation delay counter parameter expresses in pure binary representation the propagation delay value of a call in ms to be accumulated during call setup.

### 6.79 Query on release capability (network option)

The format of the query on release capability parameter field is shown in Figure 99.



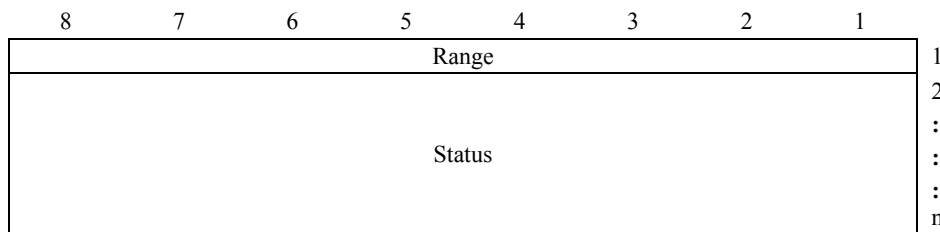
**Figure 99/Q.1902.3 – Query on release capability parameter field**

The following codes are used in the query on release capability parameter field:

- bit A      *QoR capability indicator*
- 0      no indication
- 1      QoR support
- bits G-B    *Spare*
- bit H      *Extension indicator: as 6.46 a)*

### 6.80 Range and status

The format of the range and status parameter field is shown in Figure 100.



**Figure 100/Q.1902.3 – Range and status parameter field**

The following codes are used in the subfields of the range and status parameter field:

a) *Range*

A number in pure binary representation ranging from 0 to 255. The number represented by the range code + 1 indicates the range of circuits/CICs affected by the message.

The number of circuits/CICs affected by a group supervision message is limited to 32 or less. For the group reset messages, a circuit/CIC group query message, or a circuit/CIC query response message, this requires that the range value be 31 or less. For the group blocking and unblocking messages the range value may be up to 255, but the number of status bits set to 1 must be 32 or less.

For the group blocking, unblocking and reset messages, range code 0 is reserved. Range code 0 is exclusively used by the circuit/CIC query and circuit/CIC query response messages.

b) *Status*

The status subfield contains from 2 to 256 status bits numbered from 0 to 255. Status bit 0 is located in bit position 1 of the first status subfield octet. Other status bits follow in numerical order. The number of relevant status bits in a given status subfield is equal to range + 1.

Each status bit is associated with a CIC such that status bit n is associated with CIC m + n, where m is the CIC contained in the message.

The status bits are coded as follows:

- in circuit/CIC group blocking messages
  - 0 no indication
  - 1 blocking
- in circuit/CIC group blocking acknowledgement messages
  - 0 no indication
  - 1 blocking acknowledgement
- in circuit/CIC group unblocking messages
  - 0 no indication
  - 1 unblocking
- in circuit/CIC group unblocking acknowledgement messages
  - 0 no indication
  - 1 unblocking acknowledgement
- in circuit/CIC group reset acknowledgement messages
  - 0 not blocked for maintenance reasons
  - 1 blocked for maintenance reasons

### 6.81 Redirect backward information (national use)

The redirect backward information parameter is a constructor with format as shown in Figure 93.

The values of the information type tag are:

0000 0000	reserved
0000 0001	return to invoking exchange duration
0000 0010	return to invoking exchange call identifier
0000 0011	invoking redirect reason
0000 0100	} spare
to	
1111 1111	

#### 6.81.1 Return to invoking exchange duration

Return to invoking exchange duration is encoded in units of seconds as a variable length (of length 1-2 octets) integer with the least significant bit in the first octet.

#### 6.81.2 Return to invoking exchange call identifier

The format of the return to invoking exchange call identifier is shown in Figure 18, and the encoding is identical with that of the Call Reference parameter as shown in 6.12.

#### 6.81.3 Invoking redirect reason

The format and coding of the invoking redirect reason are given in 6.84.4.

### 6.82 Redirect capability (national use)

The format of the redirect capability parameter field is shown in Figure 101.

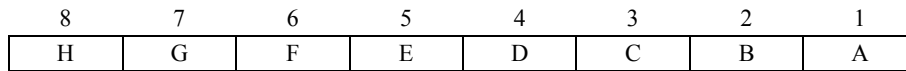


Figure 101/Q.1902.3 – Redirect capability parameter field

The following codes are used in the redirect capability parameter field:

- |                 |   |
|-----------------|---|
| bits <u>CBA</u> | <i>Redirect possible indicator</i>            |
| 0 0 0           | no indication                                 |
| 0 0 1           | redirect possible before ACM                  |
| 0 1 0           | redirect possible before ANM                  |
| 0 1 1           | redirect possible at any time during the call |
| 1 0 0           | } spare                                       |
| to              |   |
| 1 1 1           |   |
| bits GFED       | <i>Spare</i>                                  |
| bit H           | <i>Extension indicator: as 6.46 a)</i>        |

### 6.83 Redirect counter (national use)

The format of the redirect counter parameter field is shown in Figure 102.



Figure 102/Q.1902.3 – Redirect counter parameter field

The following codes are used in the redirect counter parameter field:

- |            |  |
|------------|--|
| bits EDCBA | <i>Redirect counter</i>                    |
|            | binary value of the number of redirections |
| bits HGF   | <i>Spare</i>                               |

### 6.84 Redirect forward information (national use)

The redirect forward information parameter is a constructor with format as shown in Figure 93.

The values of the information type tag are:

- |           |   |
|-----------|---|
| 0000 0000 | reserved                                    |
| 0000 0001 | return to invoking exchange possible        |
| 0000 0010 | return to invoking exchange call identifier |
| 0000 0011 | performing redirect indicator               |

```

0000 0100    invoking redirect reason
0000 0101    }
   to        } spare
1111 1111    }

```

### 6.84.1 Return to invoking exchange possible

Return to invoking exchange possible has length zero and has no information type value.

### 6.84.2 Return to invoking exchange call identifier

The format of the return to invoking exchange call identifier is shown in Figure 18, and the encoding is identical with that of the Call Reference parameter as shown in 6.12.

### 6.84.3 Performing redirect indicator

The format of the performing redirect indicator is shown in Figure 103.

8	7	6	5	4	3	2	1	
ext.	Performing redirect reason						1	
Spare						Redirect possible indicator at performing exchange	2	Reason 1
:								
:								
ext.	Performing redirect reason						2n-1	
Spare						Redirect possible indicator at performing exchange	2n	Reason n

**Figure 103/Q.1902.3 – Performing redirect indicator**

The following codes are used in the performing redirect indicator:

- a) *Extension indicator (ext.):* as 6.46 a)
- b) *Performing redirect reason (octet 2n -1)*
  - 0 0 0 0 0 0      unknown/not available
  - 0 0 0 0 0 1      service provider portability (national use)
  - 0 0 0 0 1 0      reserved for location portability
  - 0 0 0 0 1 1      reserved for service portability
  - 0 0 0 0 1 0 0 }  
to } spare  
0 1 1 1 1 1 1 }
  - 1 0 0 0 0 0 0 }  
to } reserved for national use  
1 1 1 1 1 1 1 }

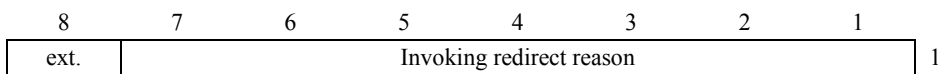


c) *Redirect possible indicator at performing exchange (octet 2n)*

0 0 0	no indication
0 0 1	redirect possible before ACM
0 1 0	redirect possible before ANM
0 1 1	redirect possible any time during the call
1 0 0	} spare
to	
1 1 1	

#### 6.84.4 Invoking redirect reason

The format of the invoking redirect reason is shown in Figure 104.

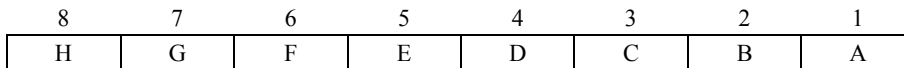


**Figure 104/Q.1902.3 – Invoking redirect reason**

The coding of the invoking redirect reason is identical to that of the performing redirect indicator as shown in 6.84.3 a) and b).

#### 6.85 Redirect status (national use)

The format of the redirect status parameter field is shown in Figure 105.



**Figure 105/Q.1902.3 – Redirect status parameter field**

bits <u>BA</u>	<i>Redirect status indicator</i>
0 0	no indication
0 1	acknowledgment of redirection
1 0	redirection will not be invoked
1 1	spare
bits GFEDC	<i>Spare</i>
bit H	<i>Extension indicator: as 6.46 a)</i>

#### 6.86 Redirecting number

The format of the redirecting number parameter field is shown in Figure 88.

The following codes are used in the subfields of the redirecting number parameter field:

- a) *Odd/even indicator: as 6.17 a)*
- b) *Nature of address indicator: as 6.20 b)*
- c) *Numbering plan indicator: as 6.17 d)*
- d) *Address presentation restricted indicator: as 6.20 e)*

- e) *Address signal*: as 6.20 g)
- f) *Filler*: as 6.17 f)

**6.87 Redirection information**

The format of the redirection information parameter field is shown in Figure 106.

	8	7	6	5	4	3	2	1	
	H	G	F	E	D	C	B	A	1
	P	O	N	M	L	K	J	I	2

NOTE – The parameter may be received without the second octet from an ISUP'88 (*Blue Book*).

**Figure 106/Q.1902.3 – Redirection information parameter field**

The following codes are used in the redirection information parameter field:

- bits CBA            *Redirecting indicator*
  - 0 0 0            no redirection (national use)
  - 0 0 1            call rerouted (national use)
  - 0 1 0            call rerouted, all redirection information presentation restricted (national use)
  - 0 1 1            call diverted
  - 1 0 0            call diverted, all redirection information presentation restricted
  - 1 0 1            call rerouted, redirection number presentation restricted (national use)
  - 1 1 0            call diversion, redirection number presentation restricted (national use)
  - 1 1 1            spare
- bit D                *Spare*
- bits HGFE            *Original redirection reason*
  - 0 0 0 0            unknown/not available
  - 0 0 0 1            user busy (national use)
  - 0 0 1 0            no reply (national use)
  - 0 0 1 1            unconditional (national use)
  - 0 1 0 0            } spare
  - to                }
  - 1 1 1 1            }
- bits KJI            *Redirection counter*
  - Number of redirections the call has undergone expressed as a binary number between 1 and 5.
- bit L                *Reserved for national use*

bits	PONM	Redirecting reason
0 0 0 0		unknown/not available
0 0 0 1		user busy
0 0 1 0		no reply
0 0 1 1		unconditional
0 1 0 0		deflection during alerting
0 1 0 1		deflection immediate response
0 1 1 0		mobile subscriber not reachable
0 1 1 1	} spare	
to		
1 1 1 1		

### 6.88 Redirection number

The format of the redirection number parameter field is shown in Figure 22.

The following codes are used in the subfields of the redirection number parameter field:

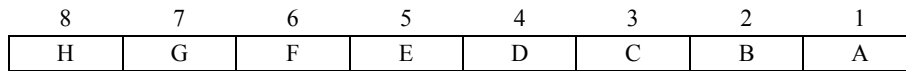
- a) *Odd/even indicator (O/E)*: as 6.17 a)
- b) *Nature of address indicator*:
 

0 0 0 0 0 0 0	spare
0 0 0 0 0 0 1	subscriber number (national use)
0 0 0 0 0 1 0	unknown (national use)
0 0 0 0 0 1 1	national (significant) number
0 0 0 0 1 0 0	international number
0 0 0 0 1 0 1	spare
0 0 0 0 1 1 0	network routing number in national (significant) number format (national use)
0 0 0 0 1 1 1	network routing number in network-specific number format (national use)
0 0 0 1 0 0 0	reserved for network routing number concatenated with Called Directory Number (national use)
0 0 0 1 0 0 1	} spare
to	
1 1 0 1 1 1 1	
1 1 1 0 0 0 0	} reserved for national use
to	
1 1 1 1 1 1 0	
1 1 1 1 1 1 1	spare
- c) *Internal network number indicator (INN)*: as 6.17 c)
- d) *Numbering plan indicator*: as 6.17 d)
- e) *Address signal*: as 6.20 g)

f) *Filler*: as 6.17 f)

### 6.89 Redirection number restriction

The format of the redirection number presentation parameter field is shown in Figure 107.



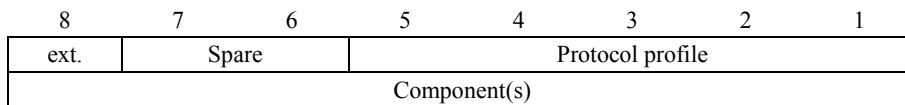
**Figure 107/Q.1902.3 – Redirection number restriction parameter field**

The following codes are used in the redirection number restriction parameter field:

- bits BA     *Presentation restricted indicator*
- 0 0     presentation allowed
- 0 1     presentation restricted
- 1 0     spare
- 1 1     spare
- bits H-C     *Spare*

### 6.90 Remote operations (national use)

The format of the remote operations parameter field is shown in Figure 108. The format and coding of the elements in the components are described in this clause.



NOTE – The component may be repeated any number of times within the remote operations parameter. In case of multiple service requests, the receiving entity shall treat the repetition of Invoke components identical to the case where multiple Remote Operations parameters are received in a single message.

**Figure 108/Q.1902.3 – Remote operations parameter field**

The following codes are used in the Remote Operations parameter field:

- a) *Extension indicator (ext.)*: as 6.46 a)
  - b) *Protocol profile field*
- |           |   |                            |
|-----------|---|----------------------------|
| 0 0 0 0   | } | spare                      |
| to        |   |                            |
| 1 0 0 0   |   |                            |
| 1 0 0 1   |   | remote operations protocol |
| 1 0 0 1 0 | } | spare                      |
| to        |   |                            |
| 1 1 1 1 1 |   |                            |

c) *Components*

This item provides the format and encoding of Component(s). The description is divided in two sub-items.

Sub-item i) uses the description method of other Q.700-series Recommendations. The content is based on the encoding rules provided in ITU-T X.690 and is consistent with that Recommendation.

Sub-item ii) uses X.680-series of Recommendations for abstract syntax notation one (ASN.1).

The general component structure and encoding rules are described in Annex B.

i) *Specification of components in table form*

1) *Component type*

The Components are based on the Remote Operations Service Element (ROSE) of ITU-T X.880. The four component types defined for the Remote Operation parameter are as follows:

- Invoke;
- Return Result;
- Return Error;
- Reject.

2) *Component type tag*

Each Component is a sequence of information elements. The Component types have the structure indicated in Table 3 to Table 6.

The information element for the various components shown in Table 3 to Table 6 are all mandatory except the Linked ID and the parameters.

The Parameter Tag shall be any valid ASN.1 tag, depending on the type of the parameter supplied. It can indicate either a primitive or a constructor element and refer to any of the defined tag classes.

When the parameter element is a collection of several information elements, the associated data type shall be derived from the Sequence, SequenceOf, Set or SetOf types.

Clause 6.90 c) i) 6) and Table 11 define the Sequence and Set tags.

**Table 3/Q.1902.3 – Invoke component**

<b>Invoke component</b>	<b>Mandatory indication</b>
Component Type Tag Component Length (Note 1)	Mandatory
Invoke ID Tag Invoke ID length Invoke ID	Mandatory
Linked ID Tag Linked ID length Linked ID	Optional
Operation Code Tag Operation Code length Operation Code	Mandatory
Parameters (Notes 2 and 3)	Optional
<p>NOTE 1 – The component length is coded to indicate the number of octets contained in the component (excluding the component type tag and the component length octets).</p> <p>NOTE 2 – The coding is supplementary service specific and the subject of other Recommendations.</p> <p>NOTE 3 – It is a parameter within ROSE, but in the BICC/ISUP it is a subfield within a field.</p>	

**Table 4/Q.1902.3 – Return Result Component**

<b>Return Result Component</b>	<b>Mandatory indication</b>
Component Type Tag Component length (Note 1)	Mandatory
Invoke ID Tag Invoke ID length Invoke ID	Mandatory
Sequence Tag Sequence length (Note 2)	Optional <sup>a)</sup>
Operation Code Tag Operation Code length Operation Code (Note 3)	Optional <sup>a)</sup> (Note 4)
Parameters (Note 5)	Optional <sup>a)</sup>
<p><sup>a)</sup> Omitted when no information elements are included in the parameters.</p> <p>NOTE 1 – The component length is coded to indicate the number of octets contained in the component (excluding the component type tag and the component length octets).</p> <p>NOTE 2 – The sequence length is coded to indicate the number of octets contained in the sequence (excluding the sequence type tag and the sequence length octets).</p> <p>NOTE 3 – The coding is supplementary service specific and the subject of other Recommendations.</p> <p>NOTE 4 – If a result is included, then the operation value is mandatory and is the first element in the sequence.</p> <p>NOTE 5 – It is a parameter within ROSE, but in the BICC/ISUP it is a subfield within a field.</p>	

**Table 5/Q.1902.3 – Return Error Component**

<b>Return Error Component</b>	<b>Mandatory indication</b>
Component Type Tag Component length (Note 1)	Mandatory
Invoke ID Tag Invoke ID length Invoke ID	Mandatory
Error Code Tag Error Code length Error Code	Optional
Parameters (Notes 2 and 3)	Optional
NOTE 1 – The component length is coded to indicate the number of octets contained in the component (excluding the component type tag and the component length octets). NOTE 2 – The coding is supplementary service specific and the subject of other Recommendations. NOTE 3 – It is a parameter within ROSE, but in the BICC/ISUP it is a subfield within a field.	

**Table 6/Q.1902.3 – Reject Component**

<b>Reject Component</b>	<b>Mandatory indication</b>
Component Type Tag Component length (Note)	Mandatory
Invoke ID Tag <sup>a)</sup> Invoke ID length Invoke ID	Mandatory
Problem Code Tag Problem Code length Problem Code	Mandatory
a) If the invoke ID is not available, Universal Null (see Table 9) with Length = 0 should be used. NOTE – The component length is coded to indicate the number of octets contained in the component (excluding the component type tag and the component length octets).	

The Component Type Tag is coded context-specific, constructor as indicated in Table 7.

**Table 7/Q.1902.3 – Component Type Tag**

<b>Component Type Tag</b>	<b>H</b>	<b>G</b>	<b>F</b>	<b>E</b>	<b>D</b>	<b>C</b>	<b>B</b>	<b>A</b>
Invoke	1	0	1	0	0	0	0	1
Return Result	1	0	1	0	0	0	1	0
Return Error	1	0	1	0	0	0	1	1
Reject	1	0	1	0	0	1	0	0

3) *Length of each Component or of their Information Elements*

The length of the contents is coded to indicate the number of octets in the contents. The length does not include the Tag nor the Length of the Contents octet.

The length of the contents uses the short, long or indefinite form. If the length is less than 128 octets, the short form is used. In the short form, bit H is coded 0, and the length is encoded as a binary number using bits A to G. The format of this length field is shown in Figure 109.

H	G	F	E	D	C	B	A	
0	MSB						Length of contents	LSB

**Figure 109/Q.1902.3 – Format of the length subfield (short form)**

If the length is greater than 127 octets, then the long form of the length of the contents is used. The long form length is from 2 to 127 octets long. Bit H of the first octet is coded 1, and bits A to G of the first octet encode a number, one less, than the size of the length in octets as an unsigned binary number whose MSB and LSB are bits G and A respectively. The length itself is encoded as an unsigned binary number whose MSB and LSB are bit H of the second octet and bit A of the last octet, respectively. This binary number should be encoded in the fewest possible octets, with no leading octets having the value 0.

The format of this length field is shown in Figure 110.

H	G	F	E	D	C	B	A	
1	MSB						(Length of field size) – 1	LSB
MSB	Length of contents						LSB	

NOTE – The application of the indefinite form of the length is not precluded depending on future application (see Annex B).

**Figure 110/Q.1902.3 – Format of the length subfield (long form)**

4) *Component ID Tag*

The term Component ID refers to the Invoke ID or the Linked ID.

The Component ID Tag is coded as shown in Table 8.

**Table 8/Q.1902.3 – Coding of Component ID Tag**

	H	G	F	E	D	C	B	A
Invoke ID	0	0	0	0	0	0	1	0
Linked ID <sup>a)</sup>	1	0	0	0	0	0	0	0

<sup>a)</sup> This tag differs from the Invoke ID, which is coded as a Universal INTEGER, in order to distinguish it from the following tag (Operation Code) which is also coded as a Universal INTEGER.



The length of a Component ID is 1 octet.

An Invoke Component has one or two Component IDs: an Invoke ID and if it is desired to associate the Invoke with a previous Invoke, then the second or Linked ID is provided in addition to the Invoke ID.

Return Result and Return Error Components have one Component ID, called an Invoke ID which is the reflection of the Invoke ID of the Invoke Component to which they are responding.

The Reject Component uses as its Invoke ID, the Invoke ID in the component being rejected. If this ID is unavailable (e.g. due to mutilation of the message undetected by lower layers), then the Invoke ID Tag is replaced with a universal Null Tag (which always has length = 0) as shown in Table 9.

**Table 9/Q.1902.3 – Coding of Null Tag**

	H	G	F	E	D	C	B	A
Null Tag	0	0	0	0	0	1	0	1

If an Invoke containing both Invoke and Linked IDs is being rejected, only the Invoke ID is used in the Reject Component.

5) *Operation Code Tag*

Each operation is assigned a value to identify it. Operations can be classified as local or global operations.

A local operation code follows an Operation Code Tag and Operation Code Length. The Operation Code Tag is coded as shown in Table 10.

**Table 10/Q.1902.3 – Coding of Operation Code Tag**

	H	G	F	E	D	C	B	A
Local Operation Code Tag	0	0	0	0	0	0	1	0
Global Operation Code Tag	0	0	0	0	0	1	1	0

The Global Operation Code is coded as an Object Identifier, which is described in ITU-T X.690.

6) *Parameter Tag*

The Parameter Tag shall be any valid ASN.1 Tag, depending on the type of the parameter supplied. It can indicate either a primitive or a constructor element and refer to any of the defined tag classes.

When the parameter element is a collection of several information elements, the associated data types shall be derived from the Sequence, SequenceOf, Set or SetOf types.

The Sequence and Set Tags are coded as shown in Table 11.

**Table 11/Q.1902.3 – Coding of Sequence and Set Tag**

	<b>H</b>	<b>G</b>	<b>F</b>	<b>E</b>	<b>D</b>	<b>C</b>	<b>B</b>	<b>A</b>
Sequence Tag	0	0	1	1	0	0	0	0
Set Tag	0	0	1	1	0	0	0	1

7) *Error Code Tag*

Each error is assigned a value to identify it. Errors can be classified as local or global errors. A local error code follows the Error Code Tag and Error Code Length. The Error Code Tag is coded as shown in Table 12.

**Table 12/Q.1902.3 – Coding of Error Code Tag**

	<b>H</b>	<b>G</b>	<b>F</b>	<b>E</b>	<b>D</b>	<b>C</b>	<b>B</b>	<b>A</b>
Local Error Code Tag	0	0	0	0	0	0	1	0
Global Error Code Tag	0	0	0	0	0	1	1	0

The Global Error Code is coded as an Object Identifier, which is described in ITU-T X.690.

8) *Problem Code*

The Problem Code consists of one of the four elements – General Problem, Invoke Problem, Return Result Problem or Return Error Problem. The tags for these elements are coded as shown in Table 13. Their values are shown in Tables 14 to 17.

**Table 13/Q.1902.3 – Coding of Problem Type Tags**

<b>Problem type</b>	<b>H</b>	<b>G</b>	<b>F</b>	<b>E</b>	<b>D</b>	<b>C</b>	<b>B</b>	<b>A</b>
General Problem	1	0	0	0	0	0	0	0
Invoke	1	0	0	0	0	0	0	1
Return Result	1	0	0	0	0	0	1	0
Return Error	1	0	0	0	0	0	1	1

**Table 14/Q.1902.3 – Coding of General Problem**

	<b>H</b>	<b>G</b>	<b>F</b>	<b>E</b>	<b>D</b>	<b>C</b>	<b>B</b>	<b>A</b>
Unrecognized Component <sup>a)</sup>	0	0	0	0	0	0	0	0
Mistyped Component <sup>a)</sup>	0	0	0	0	0	0	0	1
Badly Structured Component <sup>a)</sup>	0	0	0	0	0	0	1	0

<sup>a)</sup> Components are equivalent to ROSE Application Protocol Data Units (APDU).

**Table 15/Q.1902.3 – Coding of Invoke Problem**

	<b>H</b>	<b>G</b>	<b>F</b>	<b>E</b>	<b>D</b>	<b>C</b>	<b>B</b>	<b>A</b>
Duplicate Invoke ID	0	0	0	0	0	0	0	0
Unrecognized Operation	0	0	0	0	0	0	0	1
Mistyped parameter <sup>a)</sup>	0	0	0	0	0	0	1	0
Resource Limitation	0	0	0	0	0	0	1	1
Initiating Release <sup>b)</sup>	0	0	0	0	0	1	0	0
Unrecognized Linked ID	0	0	0	0	0	1	0	1
Linked Response Unexpected	0	0	0	0	0	1	1	0
Unexpected Linked Operation <sup>c)</sup>	0	0	0	0	0	1	1	1

a) Invoke parameter is equivalent to ROSE Invoke argument.  
b) ROSE uses "Initiator releasing" as only the initiator of the underlying association may release it. In ISUP, either entity may release the association.  
c) ROSE refers to a linked operation as a child operation.

**Table 16/Q.1902.3 – Coding of Return Result Problem**

	<b>H</b>	<b>G</b>	<b>F</b>	<b>E</b>	<b>D</b>	<b>C</b>	<b>B</b>	<b>A</b>
Unrecognized Invoke ID	0	0	0	0	0	0	0	0
Return Result Unexpected	0	0	0	0	0	0	0	1
Mistyped Parameter	0	0	0	0	0	0	1	0

**Table 17/Q.1902.3 – Coding of Return Error Problem**

	<b>H</b>	<b>G</b>	<b>F</b>	<b>E</b>	<b>D</b>	<b>C</b>	<b>B</b>	<b>A</b>
Unrecognized Invoke ID	0	0	0	0	0	0	0	0
Return Error Unexpected	0	0	0	0	0	0	0	1
Unrecognized Error	0	0	0	0	0	0	1	0
Unexpected Error	0	0	0	0	0	0	1	1
Mistyped Parameter	0	0	0	0	0	1	0	0

ii) *Specification of components in ASN.1*

The tables take precedence over the ASN.1 coding. The following module defines the parametrized type component which is contained in remote operations parameter.

ComponentOfISUPRemoteOperations {itu-t Recommendation q763 moduleB(1)}

**DEFINITIONS IMPLICIT TAGS ::=**

**BEGIN**

-- EXPORTS everything

**IMPORTS**

**ROS{}** FROM

**Remote-Operations-Generic-ROS-PDUs** {joint-iso-itu-t remote-operations(4) generic-ROS-PDUs(6) version1(0)}

OPERATION FROM

```
Remote-Operations-Information-Objects {joint-iso-itu-t remote-operations(4)
informationObjects(5) version1(0)}
```

```
Component {OPERATION : Invokable, OPERATION: Returnable} ::= CHOICE
{
  basicROS ROS {ISUPROSInvokeIDSet , {Invokable},
  {Returnable}}
}
```

```
ISUPROSInvokeIDSet INTEGER ::= {-128..127}
```

END -- end of ComponentOfISUPRemoteOperations Module.

NOTE – The parametrized type ROS { } defined in ITU-T X.880 represents the four basic ROS PDUs: invoke, return result, return error and reject. Invokable and returnable are two sets of operations.

### 6.91 SCF id

The format of the SCF id parameter field is shown in Figure 111.

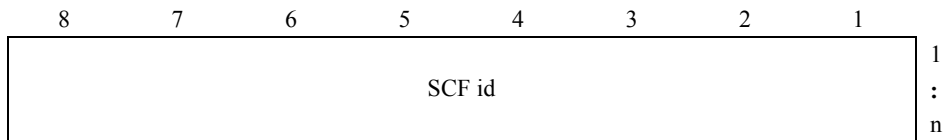


Figure 111/Q.1902.3 – SCF id parameter field

The SCF id is coded as described in ITU-T Q.1218 and Q.1228.

### 6.92 Service activation

The format of the service activation parameter field is shown in Figure 112.

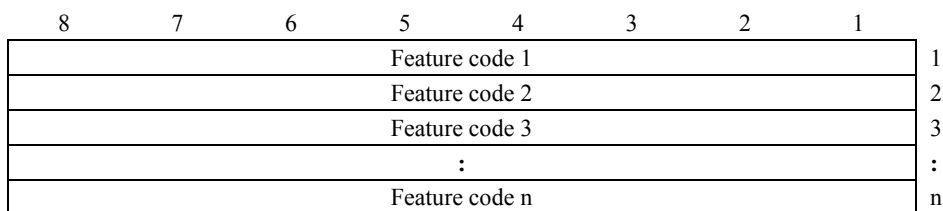


Figure 112/Q.1902.3 – Service activation parameter field

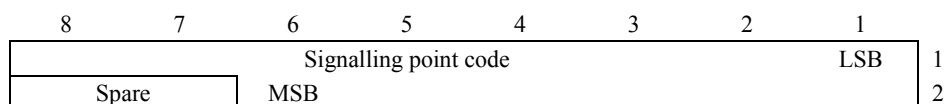
The following feature codes are used in the service activation parameter field:

```
0 0 0 0 0 0 0 0    spare
0 0 0 0 0 0 0 1    call transfer
0 0 0 0 0 0 1 0 }
  to                } reserved for international use
0 1 1 1 1 0 1 1 }
```

0 1 1 1 1 1 0 0 }  
                   to        } reserved for national use  
 1 1 1 1 1 1 1 0 }  
 1 1 1 1 1 1 1 1       reserved for extension

### 6.93 Signalling point code (national use) (ISUP only)

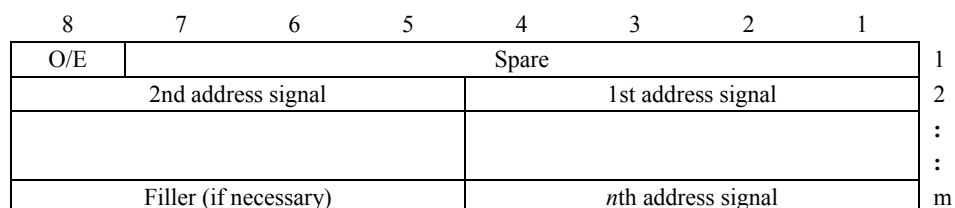
The format of the signalling point code parameter field is shown in Figure 113.



**Figure 113/Q.1902.3 – Signalling point code parameter field**

### 6.94 Subsequent number

The format of the subsequent number parameter field is shown in Figure 114.



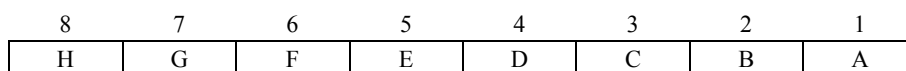
**Figure 114/Q.1902.3 – Subsequent number parameter field**

The following codes are used in the subfields of the subsequent number parameter field:

- a) *Odd/even indicator (O/E)*: as 6.17 a)
- b) *Address signal*: as 6.17 e)
- c) *Filler*: as 6.17 f)

### 6.95 Suspend/resume indicators

The format of the suspend/resume indicators parameter field is shown in Figure 115.



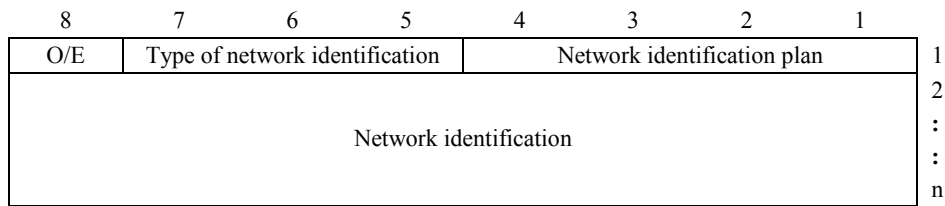
**Figure 115/Q.1902.3 – Suspend/resume indicators parameter field**

The following codes are used in the suspend/resume indicators parameter field:

- bit A       *Suspend/resume indicator*
- 0        ISDN subscriber initiated
- 1        network initiated
- bits H-B     *Spare*

## 6.96 Transit network selection (national use)

The format of the transit network selection parameter field is shown in Figure 116.



**Figure 116/Q.1902.3 – Transit network selection parameter field**

The following codes are used in the subfields of the transit network selection parameter field:

a) *Odd/even indicator(O/E)*: as 6.17 a)

b) *Type of network identification*

0 0 0 ITU-T-standardized identification

0 0 1 spare

0 1 0 national network identification

0 1 1 }  
to } spare  
1 1 1 }

c) *Network identification plan*

i) For ITU-T-standardized identification

0 0 0 0 unknown

0 0 0 1 spare

0 0 1 0 spare

0 0 1 1 public data network identification code (DNIC), ITU-T X.121

0 1 0 0 spare

0 1 0 1 spare

0 1 1 0 public land Mobile Network Identification Code (MNIC), ITU-T E.212

0 1 1 1 }  
to } spare  
1 1 1 1 }

ii) For national network identification

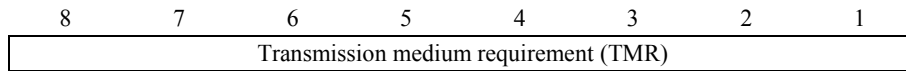
This information is coded according to national specifications.

d) *Network identification*

This information is organized according to the network identification plan and the coding principle given in 6.17 e) and, if applicable, in 6.17 f).

## 6.97 Transmission medium requirement

The format of the transmission medium requirement parameter field is shown in Figure 117.



**Figure 117/Q.1902.3 – Transmission medium requirement parameter field**

The following codes are used in the transmission medium requirement parameter field:

0 0 0 0 0 0 0 0	speech
0 0 0 0 0 0 0 1	spare
0 0 0 0 0 0 1 0	64 kbit/s unrestricted
0 0 0 0 0 0 1 1	3.1 kHz audio
0 0 0 0 0 1 0 0	reserved for alternate speech (service 2)/64 kbit/s unrestricted (service 1)
0 0 0 0 0 1 0 1	reserved for alternate 64 kbit/s unrestricted (service 1)/speech (service 2)
0 0 0 0 0 1 1 0	64 kbit/s preferred
0 0 0 0 0 1 1 1	2 × 64 kbit/s unrestricted
0 0 0 0 1 0 0 0	384 kbit/s unrestricted
0 0 0 0 1 0 0 1	1536 kbit/s unrestricted
0 0 0 0 1 0 1 0	1920 kbit/s unrestricted
0 0 0 0 1 0 1 1	} spare
to	
0 0 0 0 1 1 1 1	
0 0 0 1 0 0 0 0	3 × 64 kbit/s unrestricted
0 0 0 1 0 0 0 1	4 × 64 kbit/s unrestricted
0 0 0 1 0 0 1 0	5 × 64 kbit/s unrestricted
0 0 0 1 0 0 1 1	spare
0 0 0 1 0 1 0 0	7 × 64 kbit/s unrestricted
0 0 0 1 0 1 0 1	8 × 64 kbit/s unrestricted
0 0 0 1 0 1 1 0	9 × 64 kbit/s unrestricted
0 0 0 1 0 1 1 1	10 × 64 kbit/s unrestricted
0 0 0 1 1 0 0 0	11 × 64 kbit/s unrestricted
0 0 0 1 1 0 0 1	12 × 64 kbit/s unrestricted
0 0 0 1 1 0 1 0	13 × 64 kbit/s unrestricted
0 0 0 1 1 0 1 1	14 × 64 kbit/s unrestricted
0 0 0 1 1 1 0 0	15 × 64 kbit/s unrestricted
0 0 0 1 1 1 0 1	16 × 64 kbit/s unrestricted
0 0 0 1 1 1 1 0	17 × 64 kbit/s unrestricted

0 0 0 1 1 1 1 1	18 × 64 kbit/s unrestricted
0 0 1 0 0 0 0 0	19 × 64 kbit/s unrestricted
0 0 1 0 0 0 0 1	20 × 64 kbit/s unrestricted
0 0 1 0 0 0 1 0	21 × 64 kbit/s unrestricted
0 0 1 0 0 0 1 1	22 × 64 kbit/s unrestricted
0 0 1 0 0 1 0 0	23 × 64 kbit/s unrestricted
0 0 1 0 0 1 0 1	spare
0 0 1 0 0 1 1 0	25 × 64 kbit/s unrestricted
0 0 1 0 0 1 1 1	26 × 64 kbit/s unrestricted
0 0 1 0 1 0 0 0	27 × 64 kbit/s unrestricted
0 0 1 0 1 0 0 1	28 × 64 kbit/s unrestricted
0 0 1 0 1 0 1 0	29 × 64 kbit/s unrestricted
0 0 1 0 1 0 1 1	} spare
to	
1 1 1 1 1 1 1 1	

### 6.98 Transmission medium requirement prime

The format of the transmission medium requirement prime parameter field is shown in Figure 117, except that the coding rules for optional parameter are applied.

The following codes are used in the transmission medium requirement prime parameter field:

0 0 0 0 0 0 0 0	speech
0 0 0 0 0 0 0 1	spare
0 0 0 0 0 0 1 0	reserved for 64 kbit/s unrestricted
0 0 0 0 0 0 1 1	3.1 kHz audio
0 0 0 0 0 1 0 0	reserved for alternate speech (service 2)/64 kbit/s unrestricted (service 1)
0 0 0 0 0 1 0 1	reserved for alternate 64 kbit/s unrestricted (service 1)/speech (service 2)
0 0 0 0 0 1 1 0	reserved for 64 kbit/s preferred
0 0 0 0 0 1 1 1	reserved for 2 × 64 kbit/s unrestricted
0 0 0 0 1 0 0 0	reserved for 384 kbit/s unrestricted
0 0 0 0 1 0 0 1	reserved for 1536 kbit/s unrestricted
0 0 0 0 1 0 1 0	reserved for 1920 kbit/s unrestricted
0 0 0 0 1 0 1 1	} spare
to	
0 0 0 0 1 1 1 1	
0 0 0 1 0 0 0 0	} reserved
to	
0 0 0 1 0 0 1 0	



0 0 0 1 0 0 1 1	spare
0 0 0 1 0 1 0 0	} reserved
to	
0 0 1 0 0 1 0 0	
0 0 1 0 0 1 0 1	spare
0 0 1 0 0 1 1 0	} reserved
to	
0 0 1 0 1 0 1 0	
0 0 1 0 1 0 1 1	} spare
to	
1 1 1 1 1 1 1 1	

### 6.99 Transmission medium used

The format of the transmission medium used parameter field is shown in Figure 117, except that the coding rules for optional parameter are applied.

The coding is identical to the coding in 6.98.

### 6.100 UID action indicators

The format of the UID action indicators parameter field is shown in Figure 118.

8	7	6	5	4	3	2	1
H	G	F	E	D	C	B	A

**Figure 118/Q.1902.3 – UID action indicators parameter field**

The following codes are used in the UID action indicators parameter field:

- bit A      *Through-connection instruction indicator*
- 0      no indication
- 1      through-connect in both directions
- bit B      *T9 timer instruction indicator*
- 0      no indication
- 1      stop or do not start T9 timer
- bits G-C    *Spare*
- bit H      *Extension indicator: as 6.46 a)*

### 6.101 UID capability indicators

The format of the UID capability indicators parameter field is shown in Figure 119.

8	7	6	5	4	3	2	1
H	G	F	E	D	C	B	A

**Figure 119/Q.1902.3 – UID capability indicators parameter field**

The following codes are used in the UID capability indicators parameter field:

- bit A      *Through-connection indicator*
- 0      no indication
- 1      through-connection modification possible
- bit B      *T9 timer indicator*
- 0      no indication
- 1      stopping of T9 timer possible
- bits G-C    *Spare*
- bit H      *Extension indicator: as 6.46 a)*

### 6.102 User service information

The format of the user service information parameter field is shown in Figure 120. This format is the same as the Bearer capability information element from ITU-T Q.931 and not all capabilities coded here are supported at this time.

8	7	6	5	4	3	2	1	
ext.	Coding standard		Information transfer capability					1
ext.	Transfer mode		Information transfer rate					2
Rate multiplier								2a
ext.	Layer ident.		User information Layer 1 protocol					3
ext.	Layer ident.		User information Layer 2 protocol					4
ext.	Layer ident.		User information Layer 3 protocol					5

NOTE 1 – Octet 2a is required if octet 2 indicates multirate (64 kbit/s base rate); otherwise, it shall not be present.

NOTE 2 – Octets 3, 4, 5 or any combination of these octets may be omitted. Octet 3 may be extended as described in ITU-T Q.931.

**Figure 120/Q.1902.3 – User service information parameter field**

The codes to be used in the subfields of the user service information parameter field is defined in the Bearer capability information element in ITU-T Q.931.

### 6.103 User service information prime

The format of the user service information prime parameter field is shown in Figure 120.

The codes to be used in the subfield of the user service information prime parameter field are defined in the Bearer capability information element in ITU-T Q.931.

### 6.104 User teleservice information

The format of the user teleservice information parameter field is shown in Figure 121. This format is the same as the High Layer Compatibility information element from ITU-T Q.931 and not all capabilities coded here are supported at this time.

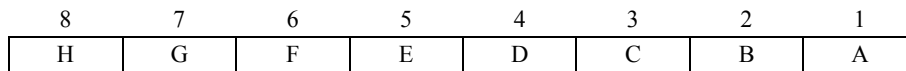
8	7	6	5	4	3	2	1	
ext.	Coding standard		Interpretation		Presentation			1
ext.	High layer characteristics identification							2
ext.	Extended layer characteristics identification							3

**Figure 121/Q.1902.3 – User teleservice information parameter field**

The codes to be used in the user teleservice information parameter field are defined in the High layer compatibility information element in ITU-T Q.931.

### 6.105 User-to-user indicators

The format of the user-to-user indicators parameter field is shown in Figure 122.



**Figure 122/Q.1902.3 – User-to-user indicators parameter field**

The following codes are used in the user-to-user indicators parameter field:

- bit A      *Type*  
 0          request  
 1          response

*If bit A equals 0 (request):*

- bits C B      *Service 1*  
 0 0          no information  
 0 1          spare  
 1 0          request, not essential  
 1 1          request, essential
- bits E D      *Service 2*  
 0 0          no information  
 0 1          spare  
 1 0          request, not essential  
 1 1          request, essential
- bits G F      *Service 3*  
 0 0          no information  
 0 1          spare  
 1 0          request, not essential  
 1 1          request, essential
- bit H          *Spare*

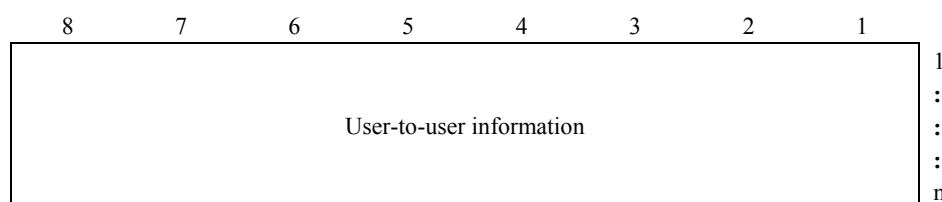
*If bit A equals 1 (response):*

- bits C B      *Service 1*  
 0 0          no information  
 0 1          not provided  
 1 0          provided  
 1 1          spare
- bits E D      *Service 2*  
 0 0          no information  
 0 1          not provided  
 1 0          provided  
 1 1          spare

bits <u>G F</u>	<i>Service 3</i>
0 0	no information
0 1	not provided
1 0	provided
1 1	spare
bit <u>H</u>	<i>Network discard indicator</i>
0	no information
1	user-to-user information discarded by the network

### 6.106 User-to-user information

The format of the user-to-user information parameter is shown in Figure 123.



**Figure 123/Q.1902.3 – User-to-user information parameter field**

The format of the user-to-user information parameter field is coded identically to the protocol discriminator plus user information field described in ITU-T Q.931.

## 7 Messages

In the following tables, the format and coding of the Bearer Independent Call Control protocol and ISDN user part messages are specified. For each message, a list of the relevant parameters is given and for each parameter:

- a reference to the clause where the formatting and coding of the parameter content is specified;
- the type of the parameter.

The following types are used in the tables:

- F = mandatory fixed length parameter;
- V = mandatory variable length parameter;
- O = optional parameter of fixed or variable length;
- the length of the parameter.

The value in the table includes:

- for type F parameters: the length, in octets, of the parameter content;
- for type V parameters: the length, in octets, of the length indicator and of the parameter content. The minimum and the maximum length are indicated;
- for type O parameters: the length, in octets, of the parameter name, length indicator and parameter content. For variable length parameters the minimum and maximum length is indicated.

For each message type, type F parameters and the pointers for the type V parameters must be sent in the order specified in these tables.

The ISUP routing label and the CIC field, which are transmitted ahead of the message type field if required, are not shown. Parameter names, pointers to mandatory variable fields and the optional part, as well as length indicators appear in the message in accordance with Figure 5 and are not shown explicitly in Tables 18 to 50.

**Table 18/Q.1902.3**

<b>Message Type: Address complete</b>			
<b>Parameter</b>	<b>Reference (clause)</b>	<b>Type</b>	<b>Length (octets)</b>
Message type	5.4	F	1
Backward call indicators	6.6	F	2
Access delivery information	6.2	O	3
Access transport	6.3	O	3-?
Application transport (Note 3)	6.4	O	5-?
Call diversion information	6.8	O	3
Call reference (national use)	6.12	O	7
Cause indicators	6.23	O	4-?
CCNR possible indicator	6.24	O	3
Conference treatment indicators	6.33	O	3-?
Echo control information	6.39	O	3
Generic notification indicator (Note 1)	6.46	O	3
HTR information	6.50	O	4-?
IN service compatibility	6.53	O	3-?
Network specific facility (national use)	6.64	O	4-?
Optional backward call indicators	6.66	O	3
Parameter compatibility information	6.71	O	4-?
Pivot routing backward information	6.74	O	3-?
Redirect status (national use)	6.85	O	3
Redirection number (Note 2)	6.88	O	5-?
Redirection number restriction	6.89	O	3
Remote operations (national use)	6.90	O	8-?
Service activation	6.92	O	3-?
Transmission medium used	6.99	O	3
UID action indicators	6.100	O	3-?
User-to-user indicators	6.105	O	3
User-to-user information	6.106	O	3-131
End of optional parameters	6.40	O	1

NOTE 1 – This parameter may be repeated.

NOTE 2 – Peer-to-peer interworking between this version of ISUP and a pre-1997 version of ISUP may result in format errors and lead to the release of the call.

NOTE 3 – Multiple application transport parameters (APP) can be sent in the same message, provided that they belong to different segmentation sequences.

**Table 19/Q.1902.3**

<b>Message Type: Answer</b>			
<b>Parameter</b>	<b>Reference (clause)</b>	<b>Type</b>	<b>Length (octets)</b>
Message type	5.4	F	1
Access delivery information	6.2	O	3
Access transport	6.3	O	3-?
Application transport (Note 3)	6.4	O	3-?
Backward call indicators	6.6	O	4
Backward GVNS	6.7	O	3-?
Call history information	6.10	O	4
Call reference (national use)	6.12	O	7
Conference treatment indicators	6.33	O	1-?
Connected number (Note 2)	6.34	O	4-?
Display information	6.38	O	3-?
Echo control information	6.39	O	3
Generic notification indicator (Note 1)	6.46	O	3
Generic number (Notes 1 and 2)	6.47	O	5-?
IN service compatibility	6.53	O	3-?
Network specific facility (national use)	6.64	O	4-?
Optional backward call indicators	6.66	O	3
Parameter compatibility information	6.71	O	4-?
Pivot routing backward information	6.74	O	3-?
Redirect status (national use)	6.85	O	3
Redirection number (Note 2)	6.88	O	5-?
Redirection number restriction	6.89	O	3
Remote operations (national use)	6.90	O	8-?
Service activation	6.92	O	3-?
Transmission medium used	6.99	O	3
User-to-user indicators	6.105	O	3
User-to-user information	6.106	O	3-131
End of optional parameters	6.40	O	1

NOTE 1 – This parameter may be repeated.

NOTE 2 – Peer-to-peer interworking between this version of ISUP and a pre-1997 version of ISUP may result in format errors and lead to the release of the call.

NOTE 3 – Multiple application transport parameters (APP) can be sent in the same message, provided that they belong to different segmentation sequences.

**Table 20/Q.1902.3**

<b>Message Type: Application transport</b>			
<b>Parameter</b>	<b>Reference (clause)</b>	<b>Type</b>	<b>Length (octets)</b>
Message type	5.4	F	1
Application transport (Note)	6.4	O	5-?
Message compatibility information	6.59	O	3-?
Parameter compatibility information	6.71	O	4-?
End of optional parameters	6.40	O	1

NOTE – Multiple application transport parameters (APP) can be sent in the same message, provided that they belong to different segmentation sequences.

**Table 21/Q.1902.3**

<b>Message Type: Blocking (ISUP only)</b> <b>Blocking acknowledgement (ISUP only)</b> <b>Continuity check request (ISUP only)</b> <b>Loop back acknowledgement (national use) (ISUP only)</b> <b>Overload, (national use) (ISUP only)</b> <b>Reset circuit/CIC</b> <b>Unblocking (ISUP only)</b> <b>Unblocking acknowledgement (ISUP only)</b> <b>Unequipped CIC, (national use)</b>			
<b>Parameter</b>	<b>Reference (clause)</b>	<b>Type</b>	<b>Length (octets)</b>
Message type	5.4	F	1

**Table 22/Q.1902.3**

<b>Message Type: Call progress</b>			
<b>Parameter</b>	<b>Reference (clause)</b>	<b>Type</b>	<b>Length (octets)</b>
Message type	5.4	F	1
Event information	6.41	F	1
Access delivery information	6.2	O	3
Access transport	6.3	O	3-?
Application transport (Note 3)	6.4	O	5-?
Backward call indicators	6.6	O	4
Backward GVNS	6.7	O	3-?
Call diversion information	6.8	O	3
Call history information	6.10	O	4
Call reference (national use)	6.12	O	7

**Table 22/Q.1902.3**

<b>Message Type: Call progress</b>			
<b>Parameter</b>	<b>Reference (clause)</b>	<b>Type</b>	<b>Length (octets)</b>
Call transfer number (Note 2)	6.13	O	4-?
Cause indicators	6.23	O	4-?
CCNR possible indicator	6.24	O	3
Conference treatment indicators	6.33	O	3-?
Connected number (Note 2)	6.34	O	4-?
Echo control information	6.39	O	3
Generic notification indicator (Note 1)	6.46	O	3
Generic number (Notes 1 and 2)	6.47	O	5-?
IN service compatibility	6.53	O	3-?
Network specific facility (national use)	6.64	O	4-?
Optional backward call indicators	6.66	O	3
Parameter compatibility Information	6.71	O	4-?
Pivot routing backward information	6.74	O	3-?
Redirect status (national use)	6.85	O	3
Redirection number (Note 2)	6.88	O	5-?
Redirection number restriction	6.89	O	3
Remote operations (national use)	6.90	O	8-?
Service activation	6.92	O	3-?
Transmission medium used	6.99	O	3
UID action indicators	6.100	O	3-?
User-to-user indicators	6.105	O	3
User-to-user information	6.106	O	3-131
End of optional parameters	6.40	O	1

NOTE 1 – This parameter may be repeated.

NOTE 2 – Peer-to-peer interworking between this version of ISUP and a pre-1997 version of ISUP may result in format errors and lead to the release of the call.

NOTE 3 – Multiple application transport parameters (APP) can be sent in the same message, provided that they belong to different segmentation sequences.



**Table 23/Q.1902.3**

<b>Message Type:</b> Circuit/CIC group blocking Circuit/CIC group blocking acknowledgement Circuit/CIC group unblocking Circuit/CIC group unblocking acknowledgement			
Parameter	Reference (clause)	Type	Length (octets)
Message type	5.4	F	1
Circuit/CIC group supervision message type	6.28	F	1
Range and status	6.80	V	3-34

**Table 24/Q.1902.3**

<b>Message Type:</b> Circuit/CIC group reset Circuit/CIC group query (national use)			
Parameter	Reference (clause)	Type	Length (octets)
Message type	5.4	F	1
Range and status (Note)	6.80	V	2
NOTE – The status subfield is not present.			

**Table 25/Q.1902.3**

<b>Message Type:</b> Circuit/CIC group query response (national use)			
Parameter	Reference (clause)	Type	Length (octets)
Message type	5.4	F	1
Range and status (Note)	6.80	V	2
Circuit/CIC state indicator	6.29	V	2-33
NOTE – The status subfield is not present.			

**Table 26/Q.1902.3**

<b>Message Type:</b> Circuit/CIC group reset acknowledgement			
Parameter	Reference (clause)	Type	Length (octets)
Message type	5.4	F	1
Range and status	6.80	V	3-34

**Table 27/Q.1902.3**

<b>Message Type: Confusion</b>			
<b>Parameter</b>	<b>Reference (clause)</b>	<b>Type</b>	<b>Length (octets)</b>
Message type	5.4	F	1
Cause indicators	6.23	V	3-?
End of optional parameters	6.40	O	1

**Table 28/Q.1902.3**

<b>Message Type: Connect</b>			
<b>Parameter</b>	<b>Reference (clause)</b>	<b>Type</b>	<b>Length (octets)</b>
Message type	5.4	F	1
Backward call indicators	6.6	F	2
Access delivery information	6.2	O	3
Access transport	6.3	O	3-?
Application transport (Note 3)	6.4	O	5-?
Backward GVNS	6.7	O	3-?
Call history information	6.10	O	4
Call reference (national use)	6.12	O	7
Conference treatment indicators	6.33	O	3-?
Connected number (Note 2)	6.34	O	4-?
Echo control information	6.39	O	3
Generic notification indicator (Note 1)	6.46	O	3
Generic number (Notes 1 and 2)	6.47	O	5-?
HTR information	6.50	O	4-?
IN service compatibility	6.53	O	3-?
Network specific facility (national use)	6.64	O	4-?
Optional backward call indicators	6.66	O	3
Parameter compatibility information	6.71	O	4-?
Pivot routing backward information	6.74	O	3-?
Redirect status (national use)	6.85	O	3
Redirection number restriction	6.89	O	3
Remote operations (national use)	6.90	O	8-?
Service activation	6.92	O	3-?
Transmission medium used	6.99	O	3
User-to-user indicators	6.105	O	3

**Table 28/Q.1902.3**

<b>Message Type: Connect</b>			
<b>Parameter</b>	<b>Reference (clause)</b>	<b>Type</b>	<b>Length (octets)</b>
User-to-user information	6.106	O	3-131
End of optional parameters	6.40	O	1
NOTE 1 – This parameter may be repeated.			
NOTE 2 – Peer-to-peer interworking between this version of ISUP and a pre-1997 version of ISUP may result in format errors and lead to the release of the call.			
NOTE 3 – Multiple application transport parameters (APP) can be sent in the same message, provided that they belong to different segmentation sequences.			

**Table 29/Q.1902.3**

<b>Message Type: Continuity</b>			
<b>Parameter</b>	<b>Reference (clause)</b>	<b>Type</b>	<b>Length (octets)</b>
Message type	5.4	F	1
Continuity indicators	6.36	F	1

**Table 30/Q.1902.3**

<b>Message Type: Facility</b>			
<b>Parameter</b>	<b>Reference (clause)</b>	<b>Type</b>	<b>Length (octets)</b>
Message type	5.4	F	1
Access transport	6.3	O	3-?
Call transfer number (Note)	6.13	O	4-?
Generic notification indicator	6.46	O	3
IN service compatibility	6.53	O	3-?
Message compatibility information	6.59	O	3-?
Parameter compatibility information	6.71	O	4-?
Pivot counter	6.73	O	3
Pivot routing backward information	6.74	O	3-?
Pivot routing indicators	6.76	O	3
Pivot status (national use)	6.77	O	3
Redirect status (national use)	6.85	O	3-?
Redirection number	6.88	O	4-?
Remote operations (national use)	6.90	O	8-?
Service activation	6.92	O	3-?
End of optional parameters	6.40	O	1
NOTE – Peer-to-peer interworking between this version of ISUP and a pre-1997 version of ISUP may result in format errors and lead to the release of the call.			

**Table 31/Q.1902.3**

<b>Message Type: Facility accepted Facility request</b>			
<b>Parameter</b>	<b>Reference (clause)</b>	<b>Type</b>	<b>Length (octets)</b>
Message type	5.4	F	1
Facility indicator	6.42	F	1
Call reference (national use)	6.12	O	7
Connection request (ISUP only)	6.35	O	7-9
Parameter compatibility information	6.71	O	4-?
User-to-user indicators	6.105	O	3
End of optional parameters	6.40	O	1

**Table 32/Q.1902.3**

<b>Message Type: Facility reject</b>			
<b>Parameter</b>	<b>Reference (clause)</b>	<b>Type</b>	<b>Length (octets)</b>
Message type	5.4	F	1
Facility indicator	6.42	F	1
Cause indicators	6.23	V	3-?
User-to-user indicators	6.105	O	3
End of optional parameters	6.40	O	1

**Table 33/Q.1902.3**

<b>Message Type: Forward transfer</b>			
<b>Parameter</b>	<b>Reference (clause)</b>	<b>Type</b>	<b>Length (octets)</b>
Message type	5.4	F	1
Call reference (national use)	6.12	O	7
End of optional parameters	6.40	O	1
NOTE – Parameter compatibility information parameter may be received in the future version.			

**Table 34/Q.1902.3**

<b>Message Type: Identification request</b>			
<b>Parameter name</b>	<b>Reference (clause)</b>	<b>Type</b>	<b>Length (octets)</b>
Message type	5.4	F	1
MCID request indicators	6.57	O	3
Message compatibility information	6.59	O	3-?
Parameter compatibility information	6.71	O	4-?
End of optional parameters	6.40	O	1

**Table 35/Q.1902.3**

<b>Message Type: Identification response</b>			
<b>Parameter</b>	<b>Reference (clause)</b>	<b>Type</b>	<b>Length (octets)</b>
Message type	5.4	F	1
Access transport	6.3	O	3-?
Calling party number (Note 2)	6.20	O	4-?
Charged party identification (national use)	6.26	O	3-?
Generic number (Notes 1 and 2)	6.47	O	5-?
MCID response indicators	6.58	O	3
Message compatibility information	6.59	O	3-?
Parameter compatibility information	6.71	O	4-?
End of optional parameters	6.40	O	1
NOTE 1 – This parameter may be repeated.			
NOTE 2 – Peer-to-peer interworking between this version of ISUP and a pre-1997 version of ISUP may result in format errors and lead to the release of the call.			

**Table 36/Q.1902.3**

<b>Message Type: Information (national use)</b>			
<b>Parameter</b>	<b>Reference (clause)</b>	<b>Type</b>	<b>Length (octets)</b>
Message type	5.4	F	1
Information indicators	6.51	F	2
Call reference	6.12	O	7
Calling party number (Note)	6.20	O	4-?
Calling party's category	6.21	O	3
Connection request (ISUP only)	6.35	O	7-9
Network specific facility	6.64	O	4-?
Parameter compatibility information	6.71	O	4-?
End of optional parameters	6.40	O	1
NOTE – Peer-to-peer interworking between this version of ISUP and a pre-1997 version of ISUP may result in format errors and lead to the release of the call.			

**Table 37/Q.1902.3**

<b>Message Type: Information request (national use)</b>			
<b>Parameter</b>	<b>Reference (clause)</b>	<b>Type</b>	<b>Length (octets)</b>
Message type	5.4	F	1
Information request indicators	6.52	F	2
Call reference	6.12	O	7
Network specific facility	6.64	O	4-?
Parameter compatibility information	6.71	O	4-?
End of optional parameters	6.40	O	1

**Table 38/Q.1902.3**

<b>Message Type: Initial address</b>			
<b>Parameter</b>	<b>Reference (clause)</b>	<b>Type</b>	<b>Length (octets)</b>
Message type	5.4	F	1
Nature of connection indicators	6.61	F	1
Forward call indicators	6.43	F	2
Calling party's category	6.21	F	1
Transmission medium requirement	6.97	F	1
Called party number (Note 2)	6.17	V	4-?
Access transport	6.3	O	3-?
Application transport (Note 3)	6.4	O	5-?
Call diversion treatment indicators	6.9	O	3-?
Call offering treatment indicators	6.11	O	3-?
Call reference (national use)	6.12	O	7
Called directory number (national use)	6.15	O	5-?
Called IN number (Note 2)	6.16	O	4-?
Calling geodetic location	6.18	O	10-?
Calling party geodetic velocity information	6.19	O	6-?
Calling party number (Note 2)	6.20	O	4-?
Carrier selection information	6.22	O	3
CCSS	6.25	O	3-?
Circuit assignment map (ISUP only)	6.27	O	6-7
Closed user group interlock code	6.30	O	6
Coding decoding processing (ISUP only)	6.31	O	3-?
Collect call request	6.32	O	3
Conference treatment indicators	6.33	O	3-?
Connection request (ISUP only)	6.35	O	7-9
Correlation id	6.37	O	3-?
Echo control information	6.39	O	3
Forward GVNS	6.44	O	5-26

**Table 38/Q.1902.3**

<b>Message Type: Initial address</b>			
<b>Parameter</b>	<b>Reference (clause)</b>	<b>Type</b>	<b>Length (octets)</b>
Generic digits (national use) (Note 1)	6.45	O	4-?
Generic notification indicator (Note 1)	6.46	O	3
Generic number (Notes 1 and 2)	6.47	O	5-?
Global call reference	6.48	O	8-?
Hop counter	6.49	O	3
IN service compatibility	6.53	O	3-?
Inter-nodal traffic group identifier	6.54	O	3-?
Location number (Note 2)	6.55	O	4-?
MLPP precedence	6.60	O	8
Network management controls	6.62	O	3-?
Network routing number (national use)	6.63	O	4-?
Network specific facility (national use)	6.64	O	4-?
Number portability forward information (network option)	6.65	O	3-?
Optional forward call indicators	6.67	O	3
Original called IN number	6.68	O	4-?
Original called number (Note 2)	6.69	O	4-?
Origination ISC point code	6.70	O	4
Parameter compatibility information	6.71	O	4-?
Pivot capability	6.72	O	3
Pivot counter	6.73	O	3
Pivot routing forward information	6.75	O	3-?
Propagation delay counter	6.78	O	4
Query on release capability (network option)	6.79	O	3
Redirect capability (national use)	6.82	O	3
Redirect counter (national use)	6.83	O	3
Redirect forward information (national use)	6.84	O	3-?
Redirect status	6.85	O	3
Redirecting number (Note 2)	6.86	O	4-?
Redirection information	6.87	O	3-4
Remote operations (national use)	6.90	O	8-?
SCF id	6.91	O	3-?
Service activation	6.92	O	3-?
Transit network selection (national use)	6.96	O	4-?
Transmission medium requirement prime	6.98	O	3
UID capability indicators	6.101	O	3-?
User service information	6.102	O	4-13
User service information prime	6.103	O	4-13

**Table 38/Q.1902.3**

<b>Message Type: Initial address</b>			
<b>Parameter</b>	<b>Reference (clause)</b>	<b>Type</b>	<b>Length (octets)</b>
User teleservice information	6.104	O	4-5
User-to-user indicators	6.105	O	3
User-to-user information	6.106	O	3-131
End of optional parameters	6.40	O	1
NOTE 1 – This parameter may be repeated.			
NOTE 2 – Peer-to-peer interworking between this version of ISUP and a pre-1997 version of ISUP may result in format errors and lead to the release of the call.			
NOTE 3 – Multiple application transport parameters (APP) can be sent in the same message, provided that they belong to different segmentation sequences.			

**Table 39/Q.1902.3**

<b>Message Type: Loop prevention</b>			
<b>Parameter</b>	<b>Reference (clause)</b>	<b>Type</b>	<b>Length (octets)</b>
Message type	5.4	F	1
Call transfer reference	6.14	O	3
Loop prevention indicators	6.56	O	3
Message compatibility information	6.59	O	3-?
Parameter compatibility information	6.71	O	4-?
End of optional parameters	6.40	O	1

**Table 40/Q.1902.3**

<b>Message Type: Network resource management</b>			
<b>Parameter</b>	<b>Reference (clause)</b>	<b>Type</b>	<b>Length (octets)</b>
Message type	5.4	F	1
Echo control information	6.39	O	3
Message compatibility information	6.59	O	3-?
Parameter compatibility information	6.71	O	4-?
End of optional parameters	6.40	O	1



**Table 41/Q.1902.3**

<b>Message Type: Pass-along (national use) (ISUP only)</b>			
<b>Parameter</b>	<b>Reference (clause)</b>	<b>Type</b>	<b>Length (octets)</b>
Message type	5.4	F	1
Message type Mandatory fixed part Mandatory variable part Optional part	Any message in Table 18 through to Table 50 which is relevant only at the "endpoint" of a connection as defined in clause 3/Q.764.		

**Table 42/Q.1902.3**

<b>Message Type: Pre-Release information</b>			
<b>Parameter</b>	<b>Reference (clause)</b>	<b>Type</b>	<b>Length (octets)</b>
Message type	5.4	F	1
Application transport (Note 2)	6.4	O	5-?
Message compatibility information	6.59	O	3-?
Optional backward call indicators (Note 1)	6.66	O	3
Optional forward call indicators (Note 1)	6.67	O	3
Parameter compatibility information	6.71	O	4-?
End of optional parameters	6.40	O	1
NOTE 1 – These parameters are required to allow the message to be segmented using the simple segmentation procedure. They should be mutually exclusive.			
NOTE 2 – Multiple application transport parameters (APP) can be sent in the same message, provided that they belong to different segmentation sequences.			

**Table 43/Q.1902.3**

<b>Message Type: Release</b>			
<b>Parameter</b>	<b>Reference (clause)</b>	<b>Type</b>	<b>Length (octets)</b>
Message type	5.4	F	1
Cause indicators	6.23	V	3-?
Access delivery information	6.2	O	3
Access transport	6.3	O	3-?
Automatic congestion level	6.5	O	3
Display information	6.38	O	3-?
HTR information	6.50	O	4-?
Network specific facility (national use)	6.64	O	4-?
Parameter compatibility information	6.71	O	4-?
Redirect backward information (national use)	6.81	O	3-?
Redirect counter (national use)	6.83	O	3

**Table 43/Q.1902.3**

<b>Message Type: Release</b>			
<b>Parameter</b>	<b>Reference (clause)</b>	<b>Type</b>	<b>Length (octets)</b>
Redirection information (national use)	6.87	O	3-4
Redirection number (national use) (Note)	6.88	O	5-?
Remote operations (national use)	6.90	O	8-?
Signalling point code (national use) (ISUP only)	6.93	O	4
User-to-user indicators	6.105	O	3
User-to-user information	6.106	O	3-131
End of optional parameters	6.40	O	1

NOTE – Peer-to-peer interworking between this version of ISUP and a pre-1997 version of ISUP may result in format errors and lead to the release of the call.

**Table 44/Q.1902.3**

<b>Message Type: Release complete</b>			
<b>Parameter</b>	<b>Reference (clause)</b>	<b>Type</b>	<b>Length (octets)</b>
Message type	5.4	F	1
Cause indicators	6.23	O	5-6
End of optional parameters	6.40	O	1

**Table 45/Q.1902.3**

<b>Message Type: Resume, Suspend</b>			
<b>Parameter</b>	<b>Reference (clause)</b>	<b>Type</b>	<b>Length (octets)</b>
Message type	5.4	F	1
Suspend/resume indicators	6.95	F	1
Call reference (national use)	6.12	O	7
End of optional parameters	6.40	O	1

NOTE – Parameter compatibility information parameter may be received in the future version.

**Table 46/Q.1902.3**

<b>Message Type: Segmentation</b>			
<b>Parameter</b>	<b>Reference (clause)</b>	<b>Type</b>	<b>Length (octets)</b>
Message type	5.4	F	1
Access transport	6.3	O	3-?
Generic digits (national use) (Note 1)	6.45	O	4-?
Generic notification indicator (Note 1)	6.46	O	3
Generic number (Notes 1 and 2)	6.47	O	5-?
Message compatibility information	6.59	O	3-?
Parameter compatibility information	6.71	O	4-?
User-to-user information	6.106	O	3-131
End of optional parameters	6.40	O	1
NOTE 1 – This parameter may be repeated.			
NOTE 2 – Peer-to-peer interworking between this version of ISUP and a pre-1997 version of ISUP may result in format errors and lead to the release of the call.			

**Table 47/Q.1902.3**

<b>Message Type: Subsequent address (Note 1)</b>			
<b>Parameter</b>	<b>Reference (clause)</b>	<b>Type</b>	<b>Length (octets)</b>
Message type	5.4	F	1
Subsequent number (Note 2)	6.94	V	3-?
End of optional parameters	6.40	O	1
NOTE 1 – No new optional parameters are allowed in the subsequent address message.			
NOTE 2 – Peer-to-peer interworking with a pre-1997 version of ISUP may result in format errors and lead to the release of the call.			

**Table 48/Q.1902.3**

<b>Message Type: Subsequent directory number (national use) (Note)</b>			
<b>Parameter</b>	<b>Reference (clause)</b>	<b>Type</b>	<b>Length (octets)</b>
Message type	5.4	F	1
Message compatibility information	6.59	O	4-?
Subsequent number	6.94	O	4-?
End of optional parameters	6.40	O	1
NOTE – No new optional parameters are allowed in the Subsequent Directory Number message.			

**Table 49/Q.1902.3**

<b>Message Type: User part test (ISUP only)</b> <b>User part available (ISUP only)</b>			
<b>Parameter</b>	<b>Reference (clause)</b>	<b>Type</b>	<b>Length (octets)</b>
Message type	5.4	F	1
Parameter compatibility information	6.71	O	4-?
End of optional parameters	6.40	O	1

**Table 50/Q.1902.3**

<b>Message Type: User-to-user information</b>			
<b>Parameter</b>	<b>Reference (clause)</b>	<b>Type</b>	<b>Length (octets)</b>
Message type	5.4	F	1
User-to-user information	6.106	V	2-130
Access transport	6.3	O	3-?
End of optional parameters	6.40	O	1
NOTE – Parameter compatibility information parameter may be received in the future version.			

## ANNEX A

**Tables for handling of unrecognized parameter values**

Reference: see ITU-T Q.1902.4 for BICC and ITU-T Q.764 for ISUP.

**Type A SNs/exchanges**

Unrecognized parameter values should be handled as indicated below in Table A.1.

Required actions:

- Default – Handle as if the default value was received.
- Ignore – The value is "don't care"; the received value may be passed on unchanged or reset to zero.
- No default – Pass to call control.

Table A.1 shows the normal actions unless specific procedural text in ITU-T Q.1902.4 and Q.1902.6, in case of BICC, and ITU-T Q.764 and the Q.73x-series, in case of ISUP, states otherwise.

**Table A.1/Q.1902.3 – Type A SNs/exchanges**

<b>Reference (clause)</b>	<b>Title</b>	<b>Action</b>
6.5	<i>Automatic congestion level</i>	Discard parameter
6.6	<i>Backward call indicators</i> Bits BA: Charge ind. Bits DC: Called party status ind. Bits FE: Called party category ind. Bits HG: End-to-end method ind. Bit J: End-to-end information ind. (national use) Bit L: Holding ind. (national use) Bits PO: SCCP method ind.	Default: 10 "charge" Default: 00 "no indication" Default: 00 "no indication" Default: 00 "no end-to-end method available" Default: 0 "no end-to-end info available" Default: 0 "holding not requested" Default: 00 "no indication"
6.17	<i>Called party number</i> Nature of address ind. Numbering plan ind. Spare Address signals Filler	Send release with cause 28 Send release with cause 28 Ignore Send release with cause 28 (Note) Default: 0000
6.20	<i>Calling party number</i> Nature of address ind. Number incomplete ind. Numbering plan ind. Address presentation restricted ind. Screening ind. Address signals Filler	Discard parameter Discard parameter Discard parameter Default: 01 "presentation restricted" Discard parameter No default Default: 0000
6.21	<i>Calling party's category</i>	Default: 0000 1010 "ordinary subscriber"
6.23	<i>Cause indicators</i> Coding standard Spare Location Cause value	Default: 00 "ITU-T standardized coding" Ignore International: Default "International network." National: Default "Beyond an Interwork. Point" Default: "Unspecified within class xxx"
6.28	<i>Circuit/CIC group supervision message type indicator</i> Bits BA: Type ind. Bits H-C: Spare	Discard message and send confusion with cause 110 Ignore
6.29	<i>Circuit/CIC state indicator</i> Maintenance blocking state Spare	Discard message Ignore

**Table A.1/Q.1902.3 – Type A SNs/exchanges**

<b>Reference (clause)</b>	<b>Title</b>	<b>Action</b>
6.34	<i>Connected number</i> Nature of address ind. Spare Numbering plan ind. Address presentation restricted ind. Screening ind. Address signals Filler	Discard parameter Ignore Discard parameter Default: 01 "presentation restricted" Discard parameter No Default Default: 0000
6.36	<i>Continuity indicators</i> Bit A: Continuity indicator Bits H-B: Spare	Discard message Ignore
6.41	<i>Event information</i> Bits G-A: Event ind.	Discard message
6.42	<i>Facility indicator</i>	Discard message
6.43	<i>Forward call indicators</i> Bits CB: End-to-end method ind. Bit E: End-to-end inform ind. (national use) Bits HG: ISUP/BICC preference ind. Bits KJ: SCCP method indicator Bit L: Spare Bits P-M: Reserved (national use)	Default: 00 "no end-to-end method available" Default: 0 "no end-to-end info available" Send release with cause 111 Default: 00 "no indication" Ignore Ignore
6.51	<i>Information indicators (national use)</i> Bits BA: CgPA response ind. Bit C: Holding ind. Bits ED: Spare Bit F: CgPC response ind. Bit G: Charge inform. resp. ind. Bit H: Solicited inf. ind. Bits P-I: Spare/Reserved	Default: 00 "CgPA not included" Default: "Hold not provided" Ignore Default: "CgPC not included" Default: "Charge inform. not included" Default: "Solicited" Ignore
6.52	<i>Information request ind. (national use)</i> Bits P-M, L-F, C: Spare/Reserved	Ignore
6.61	<i>Nature of connection indicators</i> Bits BA: Satellite ind. Bits DC: Continuity ind. Bits H-F: Spare	Default: 10 "two satellites in the connection" See Type B SN/exchange Ignore
6.66	<i>Optional backward call indicators</i> Bits E-H: Reserved for national use	Ignore

**Table A.1/Q.1902.3 – Type A SNs/exchanges**

<b>Reference (clause)</b>	<b>Title</b>	<b>Action</b>
6.67	<i>Optional forward call indicators</i> Bits BA: Closed user group call ind. Bits G-D: Spare	Default: 00 "non-CUG call" Ignore
6.69	<i>Original called number</i> Nature of address ind. Numbering plan ind. Address present. restr. ind. Address signals Filler spare	Discard parameter Discard parameter Default: 01 "Presentation restricted" No default Default: 0000 Ignore
6.80	<i>Range and status</i>	See ITU-T Q.1902.4 for BICC and 2.9.3/Q.764, 2.8.2/Q.764 and 2.8.3/Q.764 for ISUP
6.86	<i>Redirecting number</i> Nature of address ind. Numbering plan ind. Address presentation restricted ind. Address signals Filler	Discard parameter Discard parameter Default: 01 "presentation restricted" No Default Default: 0000
6.87	<i>Redirection information</i> Bits C-A: Redirecting ind.  Bits H-E: Original redirection reason Bits K-I: Redirection counter Bits P-M: Redirecting reason Bits L, D: Spare/Reserved	Default: 100 "Call diverted, all redirection information presentation restricted" Default: 000 "unknown /not available" Default: "101" Default: 0000 "unknown/not available" Ignore
6.88	<i>Redirection number</i> Nature of address indicator Numbering plan indicator Address signals Filler	discard parameter discard parameter no default default: 0000
6.94	<i>Subsequent number</i> Bits 1-7: Spare Address signal Filler	Ignore Send release with cause 28 (Note) Default: 0000
6.95	<i>Suspend/resume indicators</i> Bits H-B: Spare	Ignore

**Table A.1/Q.1902.3 – Type A SNs/exchanges**

Reference (clause)	Title	Action
6.96	<i>Transit network selection</i> Type of network identification Network identification plan Network Identification	Release with cause 91 Release with cause 91 Release with cause 91
6.97	<i>Transmission medium requirement</i>	Send release with cause 65
6.102	<i>User service information</i>	No default
6.105	<i>User-to-user indicators</i> Bits CB: Service 1 Bits ED: Service 2 Bits GF: Service 3	Default: 00 "no information" Default: 00 "no information" Default: 00 "no information"
NOTE – Evaluated as far as needed for routing.		

**Type B SNs/exchanges**

The following definitions are used:

- Default – Handle as if the default value was received; the default value is sent.
- Ignore – The value is "don't care", the received value may be passed on unchanged or reset to zero.
- No default – Value received passed on unchanged.

Table A.2 shows the normal actions unless specific procedural text in ITU-T Q.1902.4 and Q.1902.6, in case of BICC, and ITU-T Q.764 and the Q.73x-series, in case of ISUP, state otherwise.

**Table A.2/Q.1902.3 – Type B SNs/exchanges**

Reference (clause)	Title	Action
6.5	<i>Automatic congestion level</i>	Discard parameter
6.6	<i>Backward call indicator</i> Bits BA: Charge ind. Bits DC: Called party status ind. Bits FE: Called party category ind. Bits HG: End-to-end method ind. Bit J: End-to-end information ind. (national use) Bit L: Holding ind. (national use) Bits PO: SCCP method ind.	No default No default No default No default No default Ignore (international transit) No default (national transit) No default



**Table A.2/Q.1902.3 – Type B SNs/exchanges**

<b>Reference (clause)</b>	<b>Title</b>	<b>Action</b>
6.17	<i>Called party number</i> Nature of address ind. Numbering plan ind. Spare Address signals Filler	Send release with cause 28 Send release with cause 28 Ignore Send release with cause 28 (Note) Default: 0000
6.20	<i>Calling party number</i> Nature of address ind. Number incomplete ind. Numbering plan ind. Address presentation restric. ind. Screening ind. Address signals Filler	No default No default No default No default No default No default Ignore
6.21	<i>Calling party's category</i>	No default
6.23	<i>Cause indicators</i> Coding standard Spare Location Cause value	No default Ignore No default No default
6.28	<i>Circuit/CIC group supervision message type indicator</i> Bits BA: Type ind. Bits H-C: Spare	Discard message and send confusion with cause 110 Ignore
6.29	<i>Circuit/CIC state indicator</i> Maintenance blocking state Spare	Discard message Ignore
6.34	<i>Connected number</i> Nature of address ind. Spare Numbering plan ind. Address presentation restric. ind. Screening indicator Address signals Filler	No default Ignore No default No default No default No default Ignore
6.36	<i>Continuity indicators</i> Bit A: Continuity indicator Bits H-B: Spare	Discard message Ignore

**Table A.2/Q.1902.3 – Type B SNs/exchanges**

<b>Reference (clause)</b>	<b>Title</b>	<b>Action</b>
6.41	<i>Event information</i> Bits G-A: Event ind.	No default
6.42	<i>Facility indicators</i>	Discard message
6.43	<i>Forward call indicators</i> Bits CB: End-to-end method ind. Bit E: End-to-end information ind. (national use) Bits HG: ISUP/BICC preference ind. Bits KJ: SCCP method ind. Bit L: Spare Bits P-M: Reserved (national use)	No default No default Send release with cause 111 No default Ignore Ignore
6.51	<i>Information indicators (national use)</i> Bits BA: Calling party address resp. ind. Bits ED: Spare Bit C: Hold provided ind. Bit F: Calling party's category resp. ind. Bit G: Charge inform. resp. ind. Bit H: Solicited inform. ind. Bits P-I: Spare/Reserved	No default Ignore No default No default No default Default: 0 "solicited" Ignore
6.52	<i>Inform. request indicators (national use)</i> Bits P-M, L-F, C: Spare/reserved	Ignore
6.61	<i>Nature of connection indicators</i> Bits BA: Satellite ind. Bits DC: Continuity ind. Bits H-F: Spare	Default: 10 "two satellites in the connection" Default: 00 "continuity check not required" (ISUP)/"no COT to be expected" (BICC) Ignore
6.66	<i>Optional backward call indicators</i> Bits H-E: Reserved (national use)	Ignore
6.67	<i>Optional forward call indicators</i> Bits BA: Closed user group call ind. Bits G-D: Spare	No default Ignore
6.69	<i>Original called number</i> Nature of address indicator Numbering plan indicator Address presentation restric. indicator Address signals Filler Spare	No default No default No default No default Ignore Ignore

**Table A.2/Q.1902.3 – Type B SNs/exchanges**

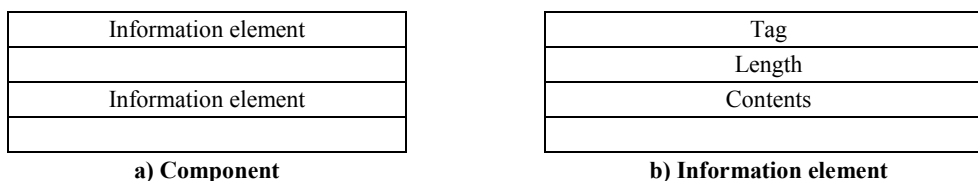
<b>Reference (clause)</b>	<b>Title</b>	<b>Action</b>
6.80	<i>Range and status</i>	See ITU-T Q.1902.4 for BICC and 2.9.3/Q.764 and 2.8.2/Q.764 for ISUP
6.86	<i>Redirecting number</i> Nature of address ind. Numbering plan ind. Address presentation restricted ind. Address signals Filler	No default No default No default No default Ignore
6.87	<i>Redirection information</i> Bits C-A: Redirecting indicator Bits H-E: Original redirection reason Bits K-I: Redirection counter Bits P-N: Redirecting reason Bits L, D: Spare/Reserved	No default No default No default No default Ignore
6.88	<i>Redirection number</i> Nature of address indicator Numbering plan indicator Address signals Filler	No default No default No default Ignore
6.94	<i>Subsequent number</i> Bits 1-7: Spare Address signal Filler	Ignore Send release with cause 28 (Note) Default: 0000
6.95	<i>Suspend/resume indicators</i> Bits H-B: Spare	Ignore
6.96	<i>Transit network selection</i> Type of network identification Network identification plan Network identification	Release with cause 91 Release with cause 91 Release with cause 91
6.97	<i>Transmission medium requirement</i>	Send release with cause 65
6.102	<i>User service information</i>	No default
6.105	<i>User-to-user indicators</i> Bits CB: Service 1 Bits ED: Service 2 Bits GF: Service 3	Default: 00 "no information" Default: 00 "no information" Default: 00 "no information"
NOTE – Evaluated as far as needed for routing.		

## ANNEX B

### General description of component encoding rules

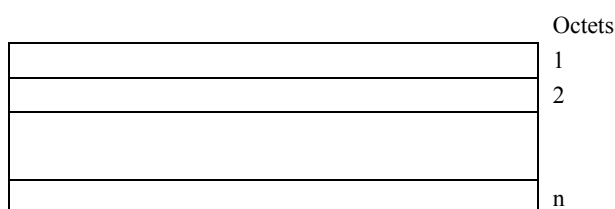
#### B.1 General components structure

Each information element within a component has the same structure. An information element consists of three fields, which always appear in the following order. The Tag distinguishes one type from another and governs the interpretation of the Contents. The Length specifies the length of the Contents. The Contents is the substance of the element, containing the primary information the element is intended to convey. Figure B.1 shows an overview of a component and an information element.

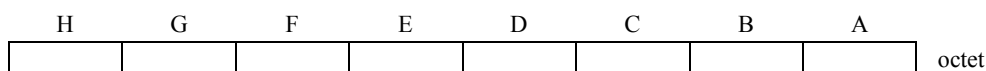


**Figure B.1/Q.1902.3 – Structure of component and information element**

Each field is coded using one or more octets. Octets are labelled as shown in Figure B.2. The first octet is the first transmitted. Bits in an octet are labelled as shown in Figure B.3, with bit A the least significant and the first transmitted.

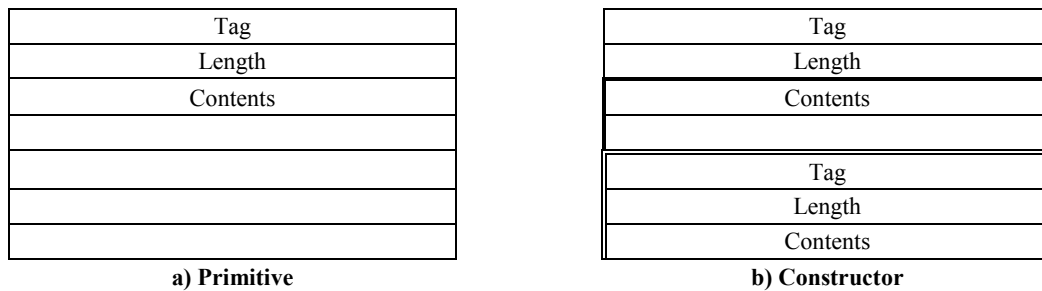


**Figure B.2/Q.1902.3 – Octet labelling scheme**



**Figure B.3/Q.1902.3 – Bit labelling scheme**

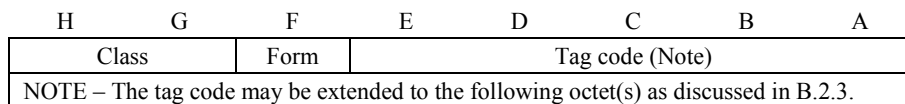
The contents of each element is either one value (Primitive) or one or more information element (Constructor), as shown in Figure B.4.



**Figure B.4/Q.1902.3 – Types of contents**

## B.2 Tags

An information element is first interpreted according to its position within the syntax of the message. The Tag distinguishes one information element from another and governs the interpretation of the Contents. It is one or more octets in length. The Tag is composed of "Class", "Form" and "Tag code", as shown in Figure B.5.



**Figure B.5/Q.1902.3 – Format of Tag**

### B.2.1 Tag class

All Tags use the two most significant bits (H and G) to indicate the Tag Class. These bits are coded as shown in Table B.1.

**Table B.1/Q.1902.3 – Coding of tag class**

Class	Coding (HG)
Universal	00
Application-wide	01
Context-specific	10
Private use	11

The universal class is used for Tags that are exclusively standardized in ITU-T X.690 and are application independent types. Universal Tags may be used anywhere a universal information element type is used. The universal class applies across all ITU-T Recommendations, i.e. across ITU-T Signalling System No. 7 ASEs, X.400 MHS, etc.

The Application-wide class is used for information elements that are standardized across all applications (ASEs) using ITU-T Signalling System No. 7.

The Context-specific class is used for information elements that are specified within the context of the next higher construction and take into account the sequence of other information elements within the same construction. This class may be used for tags in a construction, and the tags may be reused in any other construction.

The Private Use class is reserved for information elements specific to a nation, a network or a private user. Such information elements are beyond the scope of this Recommendation.

### B.2.2 Form of the information element

Bit F is used to indicate whether the element is "Primitive" or "Constructor", as is shown in Table B.2. A primitive element is one whose structure is atomic (i.e. one value only). A constructor element is one whose content is one or more information elements which may themselves be constructor elements.

Both forms of elements are shown in Table B.2.

**Table B.2/Q.1902.3 – Coding of element form**

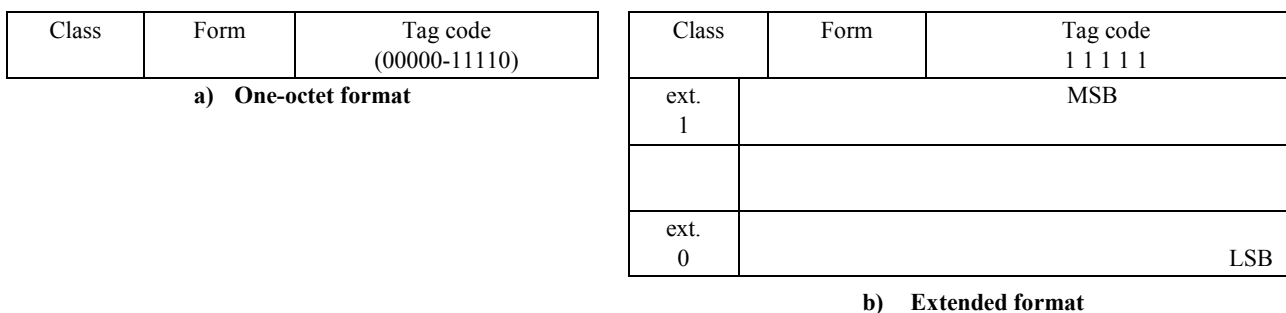
Element Form	Coding (F)
Primitive	0
Constructor	1

### B.2.3 Tag code

Bits A to E of the first octet of the Tag plus any extension octets represent a Tag code that distinguishes one element type from another of the same class. Tag codes in the range 00000 to 11110 (0 to 30 decimal) are provided in one octet.

The extension mechanism is to code bits A to E of the first octet as 11111. Bit H of the following octet serves as an extension indicator. If bit H of the extension octet is set to 0, then no further octets for this tag are used. If bit H is set to 1, the following octet is also used for extension of the Tag code. The resultant Tag consists of bits A to G of each extension octet, with bit G of the first extension octet being most significant and bit A of the last extension octet being least significant. Tag code 31 is encoded as 0011111 in bits G to A of a single extension octet. Higher tag codes continue from this point using the minimum possible number of extension octets.

Figure B.6 shows the detailed format of the Tag code.



**Figure B.6/Q.1902.3 – Format of the Tag Code**

### B.3 Length of the contents

The length of the contents is coded to indicate the number of octets in the contents. The length does not include the Tag nor the length of the contents octets.

The length of the contents uses the short, long or indefinite form. If the length is less than 128 octets, the short form is used. In the short form, bit H is coded 0, and the length is encoded as a binary number using bits A to G.

If the length is greater than 127 octets, then the long form of the length of the contents is used. The long form length is from 2 to 127 octets long. Bit H of the first octet is coded 1, and bits A to G of the first octet encode a number one less than the size of the length in octets as an unsigned binary number whose MSB and LSB are bits G and A, respectively. The length itself is encoded as an unsigned binary number whose MSB and LSB are bit H of the second octet and bit A of the last octet, respectively. This binary number should be encoded in the fewest possible octets, with no leading octets having the value 0.

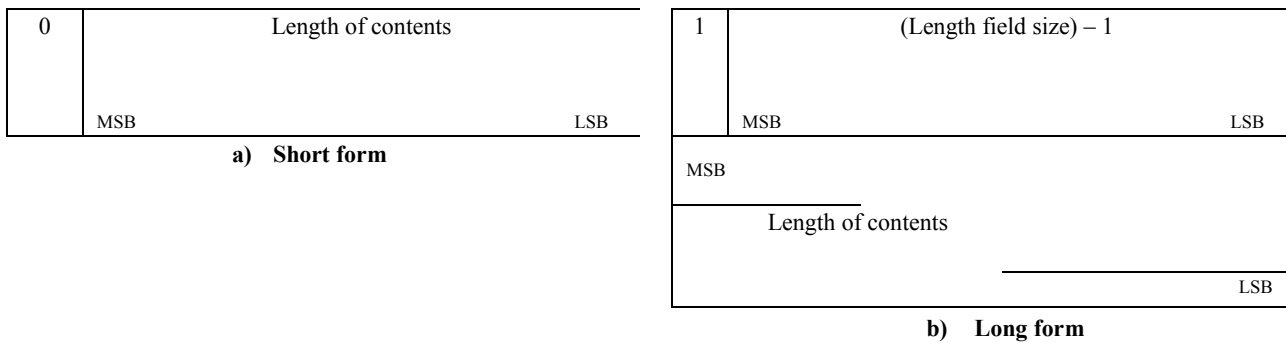
The indefinite form is one octet long and may (but need not) be used in place of the short or long form, whenever the element is a constructor. It has the value 10000000. When this form is employed, a special End-of-Contents (EOC) indicator terminates the contents.

There is no notation for the end-of-contents indicator. Although considered part of the contents syntactically, the end-of-contents indicator has no semantic significance.

The representation for the end-of-contents indicator is an element whose class is universal, whose form is primitive, whose ID code has the value 0, and whose contents is unused and absent:

EOC	Length	Contents
00 (hex)	00 (hex)	Absent

Figure B.7 shows the formats of the length field described above. The maximum value that may be encoded is constrained by the network message size limitations in the connectionless case.



Constructor Element tag
L = 1000 0000
Tag Length (Note) Contents
: : :
Tag Length (Note) Contents
EOC Tag (0000 0000)
EOC Length (0000 0000)

**c) Indefinite form**

NOTE – The length may take any of three forms: short, long and indefinite.

**Figure B.7/Q.1902.3 – Format of length field**

#### B.4 Contents

The contents are the substance of the element and contains the information the element is intended to convey. Its length is variable, but always an integral number of octets. The contents are interpreted in a type-dependent manner, i.e. according to the tag value.

### ANNEX C

#### Allocation of ISUP circuit identification codes

Allocations of ISDN user part circuit identification codes for certain applications are defined below:

a) *2048 kbit/s digital path*

For circuits which are derived from a 2048 kbit/s digital path (ITU-T G.732 and G.734) the circuit identification code contains in the five least significant bits a binary representation of the actual number of the time slot which is assigned to the communication path.

The remaining bits in the circuit identification code are used, where necessary, to identify these circuits uniquely among all other circuits of other systems interconnecting an originating and destination point.



b) *8448 kbit/s digital path*

For circuits which are derived from a 8448 kbit/s digital path (ITU-T G.744 and G.747) the circuit identification code contains in the seven least significant bits, an identification of the circuit which is assigned to the communication path. The codes in Table C.1 are used.

The remaining bits in the circuit identification code are used, where necessary, to identify these circuits uniquely among all other circuits of other systems interconnecting an originating and destination point.

c) *Frequency Division Multiplex (FDM) systems in networks using the 2048 kbit/s pulse code modulation standard*

For frequency division multiplex systems existing in networks that also use the 2048 kbit/s pulse code modulation standard, the circuit identification code contains in the six least significant bits, the identification of a circuit within a group of 60 circuits carried by five basic frequency division multiplex groups which may or may not be part of the same supergroup. The codes in Table C.2 are used.

The remaining bits in the circuit identification code are used, where necessary, to identify these circuits uniquely among all other circuits of other systems interconnecting an originating and destination point.

d) For a multirate connection type call, the CIC used in call connection messages shall be that of the lowest numbered CIC of the circuits used in the multirate connection types. Where the circuits used are derived from a 2048 kbit/s digital path, they shall be in fixed groups of contiguous time slots (excluding time slot 0 and 16), in accordance with Table C.3 (Part 1).

e) For the  $N \times 64$  kbit/s connection types, circuits used may be either contiguous or non-contiguous. In a 2048 kbit/s digital path, the N can be a value from 2 to 30. In a 1544 kbit/s digital path, the N can be a value from 2 to 24.

NOTE – At an international interface with inflexible mapping between the 2048 kbit/s and 1544 kbit/s digital paths, the circuits used shall be in a fixed group of contiguous time slots in accordance with Table C.3 (Part 2) per bilateral agreement.

**Table C.1/Q.1902.3**

0 0 0 0 0 0 0	Circuit 1
0 0 0 0 0 0 1	Circuit 2
.	.
.	.
.	.
0 0 1 1 1 1 1	Circuit 32
0 1 0 0 0 0 0	Circuit 33
.	.
.	.
.	.
1 1 1 1 1 1 0	Circuit 127
1 1 1 1 1 1 1	Circuit 128

**Table C.2/Q.1902.3**

0 0 0 0 0 0	Unallocated	
0 0 0 0 0 1 . . .	Circuit 1 . . .	1st basic (FDM) group
0 0 1 1 0 0	Circuit 12	
0 0 1 1 0 1 0 0 1 1 1 0 0 0 1 1 1 1 0 1 0 0 0 0 0 1 0 0 0 1 . . .	Circuit 1 Circuit 2 Circuit 3 Unallocated Circuit 4 . . .	2nd basic (FDM) group
0 1 1 0 0 1	Circuit 12	
0 1 1 0 1 0 . . . 0 1 1 1 1 1 1 0 0 0 0 0 1 0 0 0 0 1 . . .	Circuit 1 . . . Circuit 6 Unallocated Circuit 7 . . .	3rd basic (FDM) group
1 0 0 1 1 0	Circuit 12	
1 0 0 1 1 1 . . . 1 0 1 1 1 1 1 1 0 0 0 0 1 1 0 0 0 1 1 1 0 0 1 0 1 1 0 0 1 1	Circuit 1 . . . Circuit 9 Unallocated Circuit 10 Circuit 11 Circuit 12	4th basic (FDM) group
1 1 0 1 0 0 . . .	Circuit 1 . . .	
1 1 1 1 1 1	Circuit 12	5th basic (FDM) group

**Table C.3/Q.1902.3 (Part 1)**

Time slot	Multirate connection type			
	2 × 64 kbit/s	384 kbit/s	1536 kbit/s	1920 kbit/s
1	Call 1	Call 1	Call 1	Call 1
2				
3	Call 2			
4				
5	Call 3			
6				
7	Call 4	Call 2		
8				
9	Call 5			
10				
11	Call 6			
12				
13	Call 7	Call 3		
14				
15	Call 8			
16	Unallocated (for Q.33 use)			
17	Call 8	Call 3	Call 1	
18	Call 9			
19				
20	Call 10	Call 4		
21				
22	Call 11			
23				
24	Call 12			
25				
26	Call 13	Call 5		Not allocated to 1536 kbit/s calls
27				
28	Call 14			
29				
30	Call 15			
31				

**Table C.3/Q.1902.3 (Part 2)**

Time slot	1544 kbit/s circuit	Fixed contiguous N × 64 multirate connection type at 2048 kbit/s and 1544 kbit/s interface										
		N = 2	N = 3	N = 4	N = 5	N = 6	N = 7	N = 8	N = 9	N = 10	N = 11	
0		Unallocated										
1	1	Call 1	Call 1	Call 1	Call 1	Call 1	Call 1	Call 1	Call 1	Call 1	Call 1	Call 1
2	2											
3	3	Call 2	Call 2	Call 2	Call 2	Call 2	Call 2	Call 2	Call 2	Call 2	Call 2	Call 2
4	4											
5	5	Call 3	Call 3	Call 3	Call 3	Call 3	Call 3	Call 3	Call 3	Call 3	Call 3	Call 3
6	6											
7	7	Call 4	Call 4	Call 4	Call 4	Call 4	Call 4	Call 4	Call 4	Call 4	Call 4	Call 4
8	8											
9	9	Call 5	Call 5	Call 5	Call 5	Call 5	Call 5	Call 5	Call 5	Call 5	Call 5	Call 5
10	10											
11	11	Call 6	Call 6	Call 6	Call 6	Call 6	Call 6	Call 6	Call 6	Call 6	Call 6	Call 6
12	12											
13	13	Call 7	Call 7	Call 7	Call 7	Call 7	Call 7	Call 7	Call 7	Call 7	Call 7	Call 7
14	14											
15	15	Call 8	Call 8	Call 8	Call 8	Call 8	Call 8	Call 8	Call 8	Call 8	Call 8	Call 8
16		Unallocated (for Q.33, Q.50 use)										
17	16	Call 8	Call 8	Call 8	Call 8	Call 8	Call 8	Call 8	Call 8	Call 8	Call 8	Call 8
18	17	Call 9	Call 9	Call 9	Call 9	Call 9	Call 9	Call 9	Call 9	Call 9	Call 9	Call 9
19	18											
20	19	Call 10	Call 10	Call 10	Call 10	Call 10	Call 10	Call 10	Call 10	Call 10	Call 10	Call 10
21	20											
22	21	Call 11	Call 11	Call 11	Call 11	Call 11	Call 11	Call 11	Call 11	Call 11	Call 11	Call 11
23	22											
24	23	Call 12	Call 12	Call 12	Call 12	Call 12	Call 12	Call 12	Call 12	Call 12	Call 12	Call 12
25	24											
26		Call 13	Call 13	Call 13	Call 13	Call 13	Call 13	Call 13	Call 13	Call 13	Call 13	Call 13
27		(Note 1)	(Note 1)	(Note 1)	(Note 1)	(Note 1)	(Note 1)	(Note 1)	(Note 1)	(Note 1)	(Note 1)	(Note 1)
28		Call 14	Call 14	Call 14	Call 14	Call 14	Call 14	Call 14	Call 14	Call 14	Call 14	Call 14
29		(Note 1)	(Note 1)	(Note 1)	(Note 1)	(Note 1)	(Note 1)	(Note 1)	(Note 1)	(Note 1)	(Note 1)	(Note 1)
30		Call 15	Call 15	Call 15	Call 15	Call 15	Call 15	Call 15	Call 15	Call 15	Call 15	Call 15
31		(Note 1)	(Note 1)	(Note 1)	(Note 1)	(Note 1)	(Note 1)	(Note 1)	(Note 1)	(Note 1)	(Note 1)	(Note 1)

**Table C.3/Q.1902.3 (Part 2)**

Time slot	1544 kbit/s circuit	Fixed contiguous N × 64 multirate connection type at 2048 kbit/s and 1544 kbit/s interface									
		N = 12	N = 13	N = 14	N = 15	N = 16	N = 17	N = 18	N = 19	N = 20	N = 21
0		Unallocated									
1	1	Call 1	Call 1	Call 1	Call 1	Call 1	Call 1	Call 1	Call 1	Call 1	Call 1
2	2										
3	3										
4	4										
5	5										
6	6										
7	7										
8	8										
9	9										
10	10										
11	11										
12	12										
13	13										
14	14										
15	15										
16		Unallocated (for Q.33, Q.50 use)									
17	16	Call 2	Call 2 (Note 1)	Call 2 (Note 1)	Call 2 (Note 1)	Call 1	Call 1	Call 1	Call 1	Call 1	Call 1
18	17										
19	18										
20	19										
21	20										
22	21										
23	22										
24	23										
25	24										
26											
27											
28		NA	NA	NA	NA	NA	NA	NA	NA	NA	NA
29											
30											
31											

**Table C.3/Q.1902.3 (Part 2)**

Time slot	1544 kbit/s circuit	Fixed contiguous N × 64 multirate connection type at 2048 kbit/s and 1544 kbit/s interface								
		N = 22	N = 23	N = 24	N = 25	N = 26	N = 27	N = 28	N = 29	N = 30
0		Unallocated								
1	1	Call 1	Call 1	Call 1	NA (Note 2)	NA (Note 2)	NA (Note 2)	NA (Note 2)	NA (Note 2)	NA (Note 2)
2	2									
3	3									
4	4									
5	5									
6	6									
7	7									
8	8									
9	9									
10	10									
11	11									
12	12									
13	13									
14	14									
15	15									
16		Unallocated (for Q.33, Q.50 use)								
17	16	Call 1	Call 1	Call 1	NA	NA	NA	NA	NA	NA
18	17									
19	18									
20	19									
21	20									
22	21									
23	22									
24	23									
25	24									
26										
27										
28										
29										
30										
31										
NA Not allocated NOTE 1 – Use another 1544 kbit/s digital path. NOTE 2 – Not allocated for 2048 kbit/s and 1544 kbit/s interworking; but, can be allocated in the 2048 kbit/s digital path.										



## SERIES OF ITU-T RECOMMENDATIONS

Series A	Organization of the work of ITU-T
Series B	Means of expression: definitions, symbols, classification
Series C	General telecommunication statistics
Series D	General tariff principles
Series E	Overall network operation, telephone service, service operation and human factors
Series F	Non-telephone telecommunication services
Series G	Transmission systems and media, digital systems and networks
Series H	Audiovisual and multimedia systems
Series I	Integrated services digital network
Series J	Cable networks and transmission of television, sound programme and other multimedia signals
Series K	Protection against interference
Series L	Construction, installation and protection of cables and other elements of outside plant
Series M	TMN and network maintenance: international transmission systems, telephone circuits, telegraphy, facsimile and leased circuits
Series N	Maintenance: international sound programme and television transmission circuits
Series O	Specifications of measuring equipment
Series P	Telephone transmission quality, telephone installations, local line networks
<b>Series Q</b>	<b>Switching and signalling</b>
Series R	Telegraph transmission
Series S	Telegraph services terminal equipment
Series T	Terminals for telematic services
Series U	Telegraph switching
Series V	Data communication over the telephone network
Series X	Data networks and open system communications
Series Y	Global information infrastructure and Internet protocol aspects
Series Z	Languages and general software aspects for telecommunication systems