



INTERNATIONAL TELECOMMUNICATION UNION

**ITU-T**

TELECOMMUNICATION  
STANDARDIZATION SECTOR  
OF ITU

**Q.2120**

(02/95)

**B-ISDN ATM ADAPTATION LAYER**

---

**B-ISDN META-SIGNALLING PROTOCOL**

**ITU-T Recommendation Q.2120**

(Previously "CCITT Recommendation")

---

## FOREWORD

The ITU-T (Telecommunication Standardization Sector) is a permanent organ of the International Telecommunication Union (ITU). The ITU-T is responsible for studying technical, operating and tariff questions and issuing Recommendations on them with a view to standardizing telecommunications on a worldwide basis.

The World Telecommunication Standardization Conference (WTSC), which meets every four years, establishes the topics for study by the ITU-T Study Groups which, in their turn, produce Recommendations on these topics.

The approval of Recommendations by the Members of the ITU-T is covered by the procedure laid down in WTSC Resolution No. 1 (Helsinki, March 1-12, 1993).

ITU-T Recommendation Q.2120 was prepared by ITU-T Study Group 11 (1993-1996) and was approved under the WTSC Resolution No. 1 procedure on the 7th of February 1995.

---

## NOTE

In this Recommendation, the expression "Administration" is used for conciseness to indicate both a telecommunication administration and a recognized operating agency.

© ITU 1995

All rights reserved. No part of this publication may be reproduced or utilized in any form or by any means, electronic or mechanical, including photocopying and microfilm, without permission in writing from the ITU.

## CONTENTS

	<i>Page</i>	
1	Scope and application .....	1
1.1	Scope .....	1
1.2	Application .....	1
2	References .....	2
3	Definitions .....	2
4	Abbreviations and Acronyms .....	3
5	General .....	4
6	Protocol model .....	5
6.1	Modelling of Meta-signalling .....	5
6.2	Meta-signalling ATM LME service definition .....	5
6.3	Services provided to the ATM LME by the ATM layer .....	7
7	Meta-signalling messages .....	7
7.1	ASSIGN REQUEST .....	8
7.2	ASSIGNED .....	8
7.3	DENIED .....	8
7.4	CHECK REQUEST .....	8
7.5	CHECK RESPONSE .....	8
7.6	REMOVED .....	8
8	Parameters .....	8
8.1	Protocol Discriminator (PD) .....	9
8.2	Protocol Version (PV) .....	9
8.3	Message Type (MT) .....	9
8.4	Reference Identifier (RI) .....	9
8.5	Signalling Configuration (SCON) .....	9
8.6	Signalling Virtual Channel Identifier A (SVCIA) .....	9
8.7	Signalling Virtual Channel Identifier B (SVCIB) .....	9
8.8	Point-to-point signalling virtual channel Cell Rate (PCR) .....	9
8.9	Cause (CAU) .....	9
8.10	Service Profile Identifier (SPID) .....	9
8.11	Cyclic Redundancy Check (CRC) .....	10
9	Meta-signalling message formatting and coding .....	10
9.1	Formatting principles .....	10
9.2	Formats and codes .....	10
9.3	Coding .....	10
10	Prose description of Meta-signalling procedures .....	16
10.1	Introduction .....	16
10.2	Focused message prevention .....	17
10.3	General parameter examination procedure .....	17
10.4	Assignment procedure .....	18
10.5	Check procedure .....	20
10.6	Removal procedure .....	22
11	Timers .....	24
11.1	Timer definitions .....	24

	<i>Page</i>
Annex A – State overview diagrams .....	24
Annex B – SDL description of Meta-signalling procedures .....	26
Annex C – Dynamic signalling configuration control.....	49
C.1 Introduction .....	49
C.2 Meta-signalling procedures.....	49
Annex D – Protocol Implementation Conformance Statement (PICS) pro formato Recommendation Q.2120 (user y side) .....	53
D.1 General.....	53
D.2 Abbreviations and special symbols.....	53
D.3 Instructions for completing the PICS pro forma.....	53
D.4 Global statement of conformance .....	54
D.5 Protocol Capabilities (PC) .....	54
D.6 Messages – Protocol data units (MS) .....	55
D.7 System Parameters (SP).....	56

## SUMMARY

This Recommendation specifies the B-ISDN Meta-signalling protocol and procedures. The Meta-signalling protocol and procedures define the activity that assigns Signalling Virtual Channels on the B-ISDN User Network Interface (UNI).

The Meta-signalling protocol and procedures must be invoked by B-ISDN terminals on a multiple access UNI so that it is possible for its signalling channels to be allocated by the network. Once the signalling channels have been allocated, the signalling protocol stack can be created and signalling can proceed.

Procedures exist to detect and remove multiple signalling channel assignments.

The Meta-signalling protocol operates over the Meta-signalling channel (Virtual Channel Identifier = 1) which must be available at all times on all UNIs.

### Keywords

B-ISDN	Broadband Integrated Services Digital Network
Meta-signalling	Protocol for identification of Signalling Virtual Channels
SVC	Signalling Virtual Channel
UNI	User Network Interface



## **B-ISDN META-SIGNALLING PROTOCOL**

*(Geneva, 1995)*

### **1 Scope and application**

#### **1.1 Scope**

The Meta-signalling protocol has procedures for the:

- assignment of a point-to-point signalling virtual channel and an associated broadcast signalling virtual channel;
- assignment of a point-to-point signalling virtual channel (see Annex C);
- checking of the status of signalling virtual channels;
- removal of signalling virtual channels.

Using these procedures, Plane Management can:

- resolve the possible contention for particular signalling virtual channels;
- allocate cell rate to signalling virtual channels;
- allocate a broadcast signalling virtual channel identity;
- associate a signalling endpoint with a particular point-to-point signalling and broadcast signalling virtual channel pair.

The broadcast signalling virtual channel which is associated with each signalling virtual channel is managed indirectly via its association with that channel.

The procedures for assigning, checking and removing the signalling virtual channels are independent of each other. Any relationship between them is under the control of Plane Management.

#### **1.2 Application**

The Meta-signalling protocol is used to manage user-to-network signalling virtual channels and their associated broadcast signalling channels. However, the protocol may also be used over a virtual path connection between two users to manage user-to-user signalling virtual channels and associated broadcast signalling virtual channels. VCI = 1 shall be used for such a user-to-user Meta-signalling channel.

In cases where there is a need to use the Meta-signalling channel for other applications, such applications must have a Protocol Discriminator format that is compatible with the Protocol Discriminator format described in this Recommendation. The other protocol discriminators should be set to a different value from meta-signalling to allow coincident operation of the other protocols with the meta-signalling protocol.

The Meta-signalling protocol is not required for point-to-point configurations at the UNI. In such a point-to-point signalling configuration, VCI = 5 is the default value for the PSVCI, no BSVC is used and the default value of the peak cell rate is 167 cells/sec. (see 3.7). Additional studies may necessitate a modification of this default value.

As a network option, the Meta-signalling protocol also allows a user to request and be allocated a single PSVCI (VCI = 5) for signalling. (See Annex C.)

#### NOTES

1 Recommendation I.361 [2] reserves VCI values 0 through 15 for special purposes. These values cannot be used for PSVCI or BSVC except where indicated in [2].

2 Bandwidth is reserved, on a VP basis, for Meta-signalling only when Meta-signalling is supported on the VP.

## 2 References

The following Recommendation and other references contain provisions which, through reference in this text, constitute provisions of this Recommendation. At the time of publication, the editions indicated were valid. All Recommendations and other references are subject to revision: all users of this Recommendation are therefore encouraged to investigate the possibility of applying the most recent edition of the Recommendations and other references listed below. A list of the currently valid ITU Recommendations is regularly published.

- [1] CCITT Recommendation I.321 (1991), *B-ISDN protocol reference model and its application*.
- [2] ITU-T Recommendation I.361 (1993), *B-ISDN ATM layer specification LB-ISDN*.
- [3] ITU-T Recommendation I.413 (1993), *B-ISDN user-network interface*.
- [4] ITU-T Recommendation I.371 (1993), *Traffic control and congestion control in B-ISDN*.
- [5] ITU-T Recommendation I.610 (1993), *B-ISDN operation and maintenance principles and functions*.
- [6] ITU-T Recommendation I.363 (1993), *B-ISDN ATM adaption layer (AAL) specification*.
- [7] ITU-T Recommendation X.290 (1995), *OSI conformance testing methodology and framework for protocol Recommendations for ITU-T applications - General concepts*.

## 3 Definitions

For the purposes of this Recommendation, the following definitions apply:

**3.1 Meta-Signalling Virtual Channel (MSVC):** A virtual channel that is used to convey Meta-signalling messages across a UNI. This channel is identified by a standardised value of VCI = 1 in every VP [2]. The default value for the Virtual Path Identifier is 0 (i.e. VPI = 0). User-to-user meta-signalling channels in a user-to-user virtual path shall also use VCI = 1.

**3.2 Meta-Signalling Protocol Entity (MSPE):** The ATM Layer Management protocol entity on either the network or user side that establishes, checks or removes point-to-point and associated broadcast signalling virtual channels.

**3.3 Network Meta-Signalling Protocol Entity (NMSPE):** This is the Meta-signalling protocol that terminates a Meta-signalling virtual channel on the network side.

**3.4 User Meta-Signalling Protocol Entity (UMSPE):** This is the Meta-signalling protocol entity that terminates a Meta-signalling virtual channel at the user side.

**3.5 Broadcast Signalling Virtual Channel (BSVC):** A broadcast signalling virtual channel is a uni-directional channel allocated by the network over which it will offer calls to a user. This channel shall be the General Broadcast Signalling Virtual Channel (GBSVC) or a Selective Broadcast Signalling Virtual Channel (SBSVC).

**3.6 Broadcast Signalling Virtual Channel Identifier (BSVCI):** This identifier indicates the VCI value of a Broadcast Signalling Virtual Channel. The BSVCI shall have the following values:

- 2, which is the value reserved in every VP [2] and is known as the General Broadcast SVC Identifier,
- X, which is defined during the assignment phase and is known as a Selective Broadcast SVC Identifier.



**3.7 Point-to-point Signalling Virtual Channel (PSVC):** A virtual channel that conveys all point-to-point signalling for a given signalling endpoint. A signalling endpoint is assigned only one point-to-point signalling virtual channel and this channel is assigned, checked and removed using the Meta-signalling protocol.

In a point-to-point configuration, the PSVC is also used for call offering.

**3.8 Point-to-point SVC Identifier (PSVCI):** This identifier indicates the VCI value of a Point-to-point Signalling Virtual Channel (PSVC). The PSVCI may indicate the value 5 which is reserved per VP for the identification of a PSVC in a point-to-point signalling configuration.

**3.9 ATM signalling endpoint:** This is an association of a PSVCI and zero or one BSVCI.

**3.10 Service Profile:** The service profile is a collection of information maintained by a network to provide service to a signalling entity. It allows, but does not require, different services to be provided to different signalling endpoints. It is network specific.

The collection of information can contain:

- a non-standard protocol stack used by the user;
- terminal subscription data;
- directory number;
- supplementary service information, and other user or service data, as defined by a specific network.

This collection of information is associated with a specific Service Profile Identifier (SPID) which can be communicated by Meta-signalling.

## 4 Abbreviations and Acronyms

For the purposes of this Recommendation the following abbreviations are used:

ATM	Asynchronous Transfer Mode
BCD	Binary Coded Decimal
B-ISDN	Broadband Integrated Services Digital Network
BSVC	Broadcast Signalling Virtual Channel
BSVCI	Broadcast Signalling Virtual Channel Identifier
CAU	Cause
CDV	Cell Delay Variation
CLP	Cell Loss Priority
CRC	Cyclic Redundancy Check
GBSVC	General Broadcast Signalling Virtual Channel
GBSVCI	General Broadcast Signalling Virtual Channel Identifier
LME	Layer Management Entity
MSPE	Meta-signalling Protocol Entity
MSVC	Meta-signalling Virtual Channel
MSVCI	Meta-signalling Virtual Channel Identifier
MT	Message Type
NMSPE	Network Meta-signalling Protocol Entity
OAM	Operations And Maintenance
PCR	PSVC Cell Rate

PD	Protocol Discriminator
PSVC	Point-to-point Signalling Virtual Channel
PSVCI	Point-to-point Signalling Virtual Channel Identifier
PV	Protocol Version
RI	Reference Identifier
SAP	Service Access Point
SBSVCI	Selective Broadcast Signalling Virtual Channel Identifier
SCON	Signalling Configuration
SPID	Service Profile Identifier
SVC	Signalling Virtual Channel
SVCI	Signalling Virtual Channel Identifier
SVCIA	Signalling Virtual Channel Identifier A
SVCIB	Signalling Virtual Channel Identifier B
UMSPE	User Meta-signalling Protocol Entity
VC	Virtual Channel
VCI	Virtual Channel Identifier
VP	Virtual Path
VPI	Virtual Path Identifier

## 5 General

This Recommendation defines the B-ISDN Meta-signalling protocol (Version 1) that is used to establish and maintain the user-network signalling connections which are applicable at the  $T_B$  or co-incident  $T_B/S_B$  reference points, see Recommendation I.321 [1]. The procedures are asymmetric and are designed primarily for use over the user-network interface (UNI)<sup>1)</sup>.

The Meta-signalling protocol operates over the Meta-signalling virtual channel. This channel has a pre-defined value of  $VCI = 1$  in every Virtual Path (VP). The default peak cell rate of the meta-signalling virtual channel is 42 cells/sec. All Meta-signalling messages are equal to one ATM cell payload (i.e. 48 octets) in length [2]. The originating signalling entity shall set the CLP bit to 0. The network may change the value of the CLP bit. The ATM-layer-user-to-ATM-user-layer-user indication shall always be set to the value "1" for meta-signalling cells.

Bandwidth is reserved on a VP basis, for Meta-signalling, only when Meta-signalling is supported on that VP. (For example, for a user-network VP, bandwidth is reserved for meta-signalling only when the VP is configured as a point-to-multipoint signalling configuration or when it is configured as a point-to-point signalling configuration and Annex C procedures apply.) The Broadcast Signalling Virtual Channel shall have the same cell rate and CDV (see I.371 [4]) as the associated PSVC. As a consequence, when multiple PSVCs are associated with the BSVC, the BSVC must meet the most stringent constraint of the associated PSVCs.

The protocol has procedures which enable the assignment, removal and checking of point-to-point signalling and associated broadcast signalling virtual channels. Both the point-to-point signalling and broadcast virtual channels must be in the same virtual path as the Meta-signalling channel which manages them.

The network side and user side endpoints which communicate via the Meta-signalling protocol are located in the ATM Layer Management Entity on each side and each is under the control of its Plane Management Entity.

---

<sup>1)</sup> The protocol may also be used to manage user-to-user signalling channels in a user-to-user virtual path.

## 6 Protocol model

### 6.1 Modelling of Meta-signalling

The meta-signalling procedures are management procedures that reside in the Management Plane and are modelled as part of the Layer Management Entity (LME) of the ATM layer (see Figure 1). The LMEs communicate via a permanent ATM virtual channel connection identified by a VCI = 1. The meta-signalling procedures are used to assign, check and remove ATM connections for use by the higher layer signalling applications. Since the meta-signalling layer management entity is a direct user of the ATM layer service, the interface between this entity and the ATM layer is defined by a subset of the services offered by the ATM layer to the next higher layer.

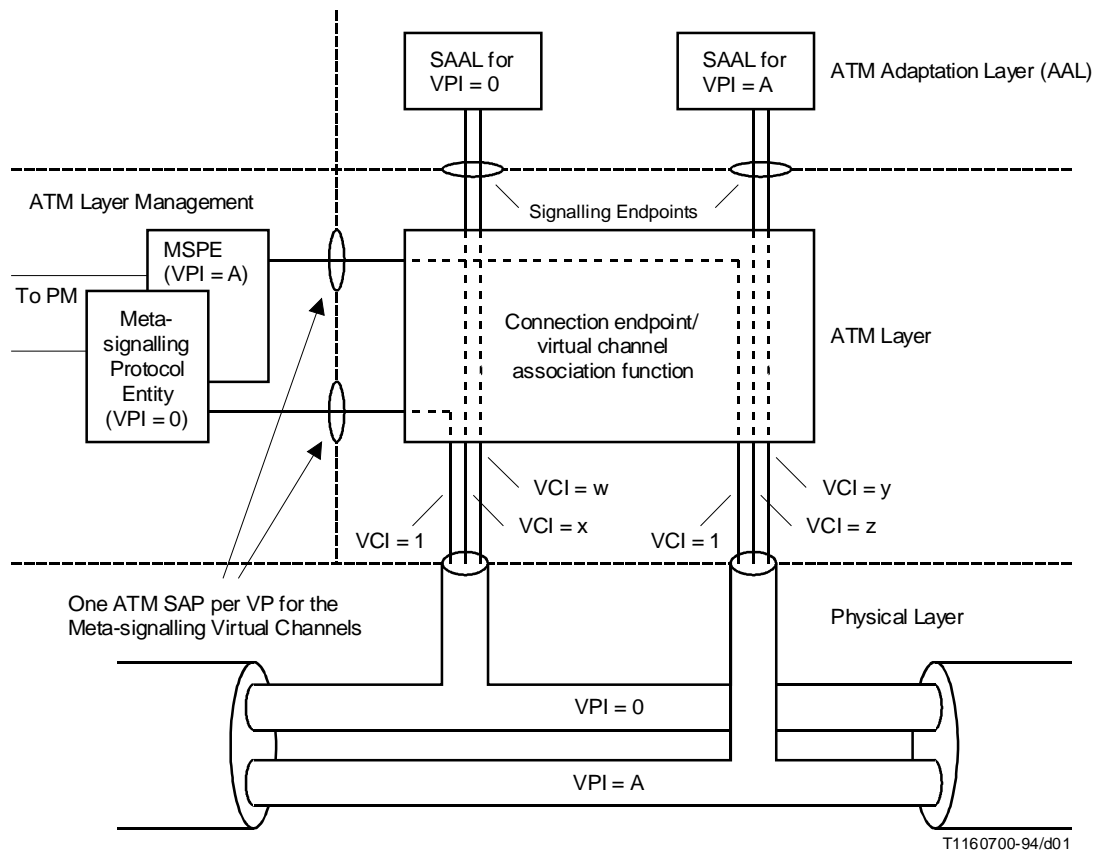

FIGURE 1/Q.2120

### Meta-signalling protocol architecture model

An example of some typical signalling relations under the control of Meta-signalling is shown in Figure 2.

### 6.2 Meta-signalling ATM LME service definition

The Meta-signalling protocol entity provides the following services to Plane Management:

- assignment of a point-to-point signalling virtual channel and its associated broadcast signalling virtual channel;
- checking of the status of point-to-point and associated broadcast signalling virtual channels;
- removal of point-to-point and associated broadcast signalling virtual channels.

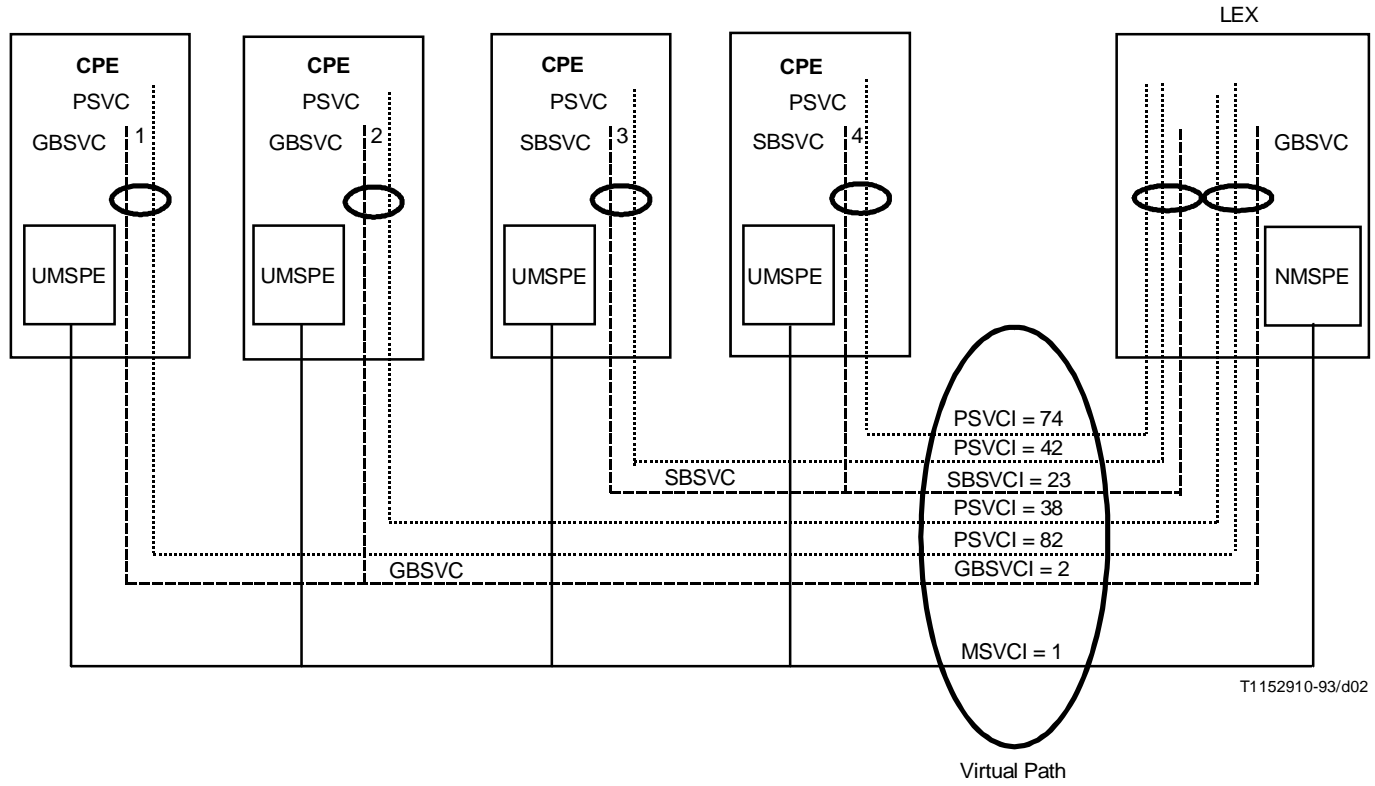

T1152910-93/d02

FIGURE 2/Q.2120  
Example signalling relations under control of Meta-signalling

The primitives at the interface between the ATM LME and Plane Management are detailed below. The primitives represent, in an abstract way, the logical exchange of information and control between the Meta-signalling ATM LME and Plane Management. (Explanation of the abbreviations used in this discussion can be found in clause 4.)

### 6.2.1 Assignment Primitives and their parameters

The primitives and associated parameters at the user side for use in assignment procedures are:

ESTABLISH_SVC-request	SCON, cell rate, SPID
ESTABLISH_SVC-confirm	PSVCI, BSVCI, cause
ESTABLISH_FAIL-indication	cause

The primitives and associated parameters at the network side for use in assignment procedures are:

ESTABLISH_SVC-indication	RI, SCON, PSVCI, cell rate, SPID
ESTABLISH_SVC-response	RI, PSVCI, BSVCI, cause
ESTABLISH_FAIL-request	RI, cause

### 6.2.2 Checking Primitives and their parameters

The primitives and associated parameters at the network side for use in checking procedures are:

CHECK_SVC-request	SVCI
CHECK_RESULT-indication	response, result_pointer, SPID

### 6.2.3 Removal Primitives and their parameters

The primitives and associated parameters at the user side for use in removal procedures are:

REMOVED_SVC-indication	SVCI, cause
REMOVE_SVC-request	PSVCI, cause

The primitives and associated parameters at the network side for use in removal procedures are:

REMOVE_SVC-request	SVCI, cause
REMOVED_SVC-indication	PSVCI, BSVCI, cause

## 6.3 Services provided to the ATM LME by the ATM layer

The Meta-signalling entity receives information from the ATM layer in the form of an ATM-LM-DATA-indication containing a 48 octet SDU, and it provides information to the ATM layer in the form of an ATM-LM-DATA-request containing a 48 octet SDU.

The ATM layer provides unacknowledged transfer of PDUs between peer meta-signalling endpoints. In this mode of operation, a Meta-signalling PDU may become lost or corrupted. The basic characteristics of the information transfer service provided to the Meta-signalling entity are as follows:

- a) provision of an ATM connection between meta-signalling entities for unacknowledged information transfer of SDUs;
- b) association of the Meta-signalling connection endpoint identifier to the couple VPI = x, VCI = 1.

The ATM-LM-DATA service uses two primitives as illustrated in Figure 3.

## 7 Meta-signalling messages

The following messages shall be exchanged between peer Meta-signalling protocol entities:

- ASSIGN REQUEST;
- ASSIGNED;
- DENIED;

- CHECK REQUEST;
- CHECK RESPONSE;
- REMOVED.

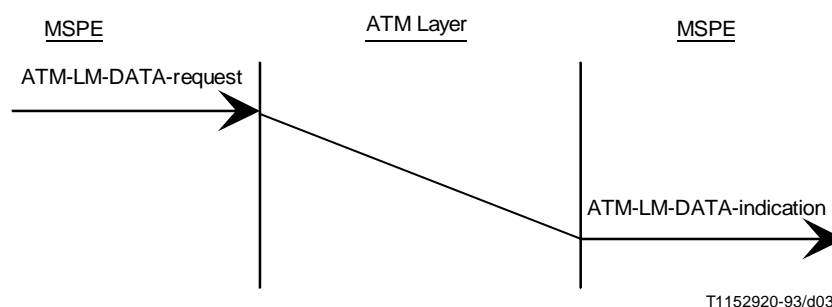

FIGURE 3/Q.2120  
ATM-LM-DATA primitives

The usage of each message is described below.

### 7.1 ASSIGN REQUEST

This message is sent from the user side to the network side to request allocation of signalling resources.

### 7.2 ASSIGNED

This message is sent from the network side to the user side in response to the ASSIGN REQUEST message when the network is able to allocate signalling resources.

### 7.3 DENIED

This message is sent from the network side to the user side in response to the ASSIGN REQUEST message when the network is unable to allocate signalling resources. The reason for denial is given in a cause parameter.

### 7.4 CHECK REQUEST

This message is sent from the network side to the user side to verify the assignment of signalling resources.

### 7.5 CHECK RESPONSE

This message is sent from the user side to the network side in response to a CHECK REQUEST message if appropriate.

### 7.6 REMOVED

This message is sent to indicate the completed removal of one or more signalling endpoints. This is sent by the user side or the network side.

## 8 Parameters

The following parameters can be included in Meta-signalling messages:

- a) Protocol Discriminator (PD);
- b) Protocol Version (PV);
- c) Message Type (MT);

- d) Reference Identifier (RI);
- e) Signalling Configuration (SCON);
- f) Signalling Virtual Channel Identifier A (SVCIA);
- g) Signalling Virtual Channel Identifier B (SVCIB);
- h) Point-to-point signalling virtual channel Cell Rate (PCR);
- i) Cause (CAU);
- j) Service Profile Identifier (SPID);
- k) Cyclic Redundancy Check (CRC).

These parameters are further described below.

### **8.1 Protocol Discriminator (PD)**

This parameter identifies messages on a Meta-signalling channel as Meta-signalling messages or messages belonging to another protocol.

### **8.2 Protocol Version (PV)**

This parameter identifies the Meta-signalling protocol version in use and identifies the general message format being used.

### **8.3 Message Type (MT)**

This parameter identifies the message name which is used to determine the function and detailed format of each message.

### **8.4 Reference Identifier (RI)**

This parameter is used to differentiate between a number of assignment procedures and their related ASSIGN REQUEST, ASSIGNED and DENIED messages. The value is randomly generated each time an ASSIGN REQUEST message is sent.

### **8.5 Signalling Configuration (SCON)**

This parameter is used in an ASSIGN REQUEST message to specify the requested signalling configuration.

### **8.6 Signalling Virtual Channel Identifier A (SVCIA)**

This parameter contains either a PSVCI or a BSVCI, depending on the procedure in use.

### **8.7 Signalling Virtual Channel Identifier B (SVCIB)**

This parameter contains a BSVCI.

### **8.8 Point-to-point signalling virtual channel Cell Rate (PCR)**

This parameter indicates the requested or allocated cell rate for the PSVC.

### **8.9 Cause (CAU)**

This parameter is used to provide information to the recipient and may indicate the reason for the generation of the message.

### **8.10 Service Profile Identifier (SPID)**

This parameter is used to request that a basic or a specific level of service be provided to the user.

## 8.11 Cyclic Redundancy Check (CRC)

This parameter is used to detect errors in Meta-signalling messages.

## 9 Meta-signalling message formatting and coding

The parameters that are associated with each message are shown in Table 1.

TABLE 1/Q.2120

**Meta-signalling messages and associated parameters**

Message	Direction	PD	PV	MT	RI	SCON	SVCIA	SVCIB	PCR	CAU	SPID	CRC
ASSIGN REQUEST	U ⇒ N	M	M	M	M	M (Note 1)	–	–	M	–	M (Note 2)	M
ASSIGNED	N ⇒ U	M	M	M	M	–	M	M	–	M	–	M
DENIED	N ⇒ U	M	M	M	M	–	–	–	–	M	–	M
CHECK REQUEST	N ⇒ U	M	M	M	–	–	M	–	–	–	–	M
CHECK RESPONSE	U ⇒ N	M	M	M	–	–	M	M	–	–	M	M
REMOVED	N ⇒ U or U ⇒ N	M	M	M	–	–	M	–	–	M	–	M

M Indicates that a mandatory, valid value must be present.  
 – Indicates that the parameter is not used and is encoded with Not Applicable.  
 N Network side.  
 U User side.

NOTES

1 For operation not using the Annex C procedure, this parameter is encoded with a value of 1. If the procedure in Annex C is implemented, this parameter will contain a value of 2.

2 For operation not using the SPID, the SPID parameter is coded as Not Applicable. If the SPID is used, it shall be coded according to 9.3.10.

### 9.1 Formatting principles

A fixed format coding scheme is used. All parameter fields are sent in every message. Parameters that are not required for a particular message are coded with specified Not Applicable values and are ignored by the recipient.

### 9.2 Formats and codes

The format of Meta-signalling messages is shown in Table 2.

### 9.3 Coding

#### 9.3.1 Protocol Discriminator

The protocol discriminator shall be coded as described in Table 3.



TABLE 2/Q.2120

**Format of Meta-signalling messages**

Bit								Octet number
8	7	6	5	4	3	2	1	
Protocol Discriminator								1
Protocol Version								2
Message Type								3
Reference Identifier								4
								5
Signalling Configuration								6
Signalling Virtual Channel Identifier A								7
								8
Signalling Virtual Channel Identifier B								9
								10
PSVC Cell Rate								11
Cause								12
Service Profile Identifier								13 to 23
Null-fill								24 to 40
0 0 0 0 0 0 0 0								41 (Note)
0 0 0 0 0 0 0 0								42
0 0 0 0 0 0 0 0								43
0 0 1 0 1 0 0 0								44
CRC								45 to 48
<p>NOTE – This coding of octets 41 through 44 allows equipment compliant with clause 6/I.363[6] to process the Meta-signalling CRC.</p> <p>When a field is contained within a single octet, the lowest bit number of the field represents the lowest order value.</p> <p>When a field spans more than one octet, the order of bit values within each octet progressively decreases as the octet number increases; the lowest bit number associated with the field represents the lowest order value.</p> <p>The octets are transmitted in ascending numerical order starting with octet 1; inside an octet, bit 8 is the first to be transmitted.</p>								

TABLE 3/Q.2120

**Coding of Protocol Discriminator**

Bit								Meaning
8	7	6	5	4	3	2	1	
0	0	0	0	0	0	0	1	Meta-signalling
NOTE – All other values are reserved.								

### 9.3.2 Protocol Version

The protocol version shall be coded as described in Table 4.

TABLE 4/Q.2120  
Coding of Protocol Version

Bit								Meaning
8	7	6	5	4	3	2	1	
0	0	0	0	0	0	0	1	Version # 1
NOTE – All other values are reserved.								

### 9.3.3 Message Type

The message type shall be coded as described in Table 5.

TABLE 5/Q.2120  
Coding of Message Type

Bit								Meaning
8	7	6	5	4	3	2	1	
0	0	0	0	0	0	0	1	ASSIGN REQUEST
0	0	0	0	0	0	1	0	ASSIGNED
0	0	0	0	0	0	1	1	DENIED
0	0	0	0	0	1	0	0	CHECK REQUEST
0	0	0	0	0	1	0	1	CHECK RESPONSE
0	0	0	0	0	1	1	0	REMOVED
NOTE – All other values are reserved.								

### 9.3.4 Reference Identifier

This value is randomly generated each time the ASSIGN REQUEST message is sent. The Not Applicable value for this parameter shall be coded as all 0's.

### 9.3.5 Signalling Configuration

The signalling configuration shall be coded as described in Table 6.

### 9.3.6 Signalling Virtual Channel Identifier A

This parameter is contained in two octets. The Not Applicable value for this parameter shall be coded as all 0's.

### 9.3.7 Signalling Virtual Channel Identifier B

This parameter is contained in two octets. The Not Applicable value for this parameter shall be coded as all 0's.

TABLE 6/Q.2120

**Coding of Signalling Configuration**

Bit								Meaning
8	7	6	5	4	3	2	1	
0	0	0	0	0	0	0	0	Not applicable
0	0	0	0	0	0	0	1	Point-to-multipoint, with broadcast
0	0	0	0	0	0	1	0	Point-to-point (See Annex C)
NOTES								
1 All other values are reserved.								
2 For SCON = 2, no BSVC shall be assigned (the BSVC shall be coded "Not Applicable" in the ASSIGNED message). For SCON = 1, a BSVC shall be assigned.								

**9.3.8 Point-to-point Signalling Virtual Channel Cell Rate**

This parameter shall be coded as described in Table 7.

TABLE 7/Q.2120

**Coding of Point-to-point Signalling Virtual Channel Cell Rate**

OAM Cell Rate		Signalling Cell Rate						
Bit	Meaning	Bit						Meaning
8 7		6	5	4	3	2	1	
0 0	No OAM cells	0	0	0	0	0	0	Not Applicable
0 1	1 cell/s in addition to signalling cell rate	0	0	0	0	0	1	42 cells/s
1 0	2% of signalling cell rate plus 1 cell/s in addition to signalling cell rate	0	0	0	0	1	0	84 cells/s
1 1	Reserved	0	0	0	0	1	1	125 cells/s
		0	0	0	1	0	0	167 cells/s
		0	0	0	1	0	1	250 cells/s
		0	0	0	1	1	0	344 cells/s
		0	0	0	1	1	1	500 cells/s
		0	0	1	0	0	0	667 cells/s
		0	0	1	0	0	1	1000 cells/s
		0	0	1	0	1	0	1334 cells/s
		0	0	1	0	1	1	2000 cells/s
		0	0	1	1	0	0	2667 cells/s
		All other values						Reserved
NOTES								
1 The values above indicate peak cell rates. Future versions may indicate other than the peak rate.								
2 42 cells/s is approximately 16 kbit/s.								
3 The "Not Applicable" value is used in messages other than the ASSIGN REQUEST.								
4 All equipment shall support at least a PSVC cell rate of 42 cells/s.								
5 The Broadcast Signalling Virtual Channel shall have the same cell rate and CDV (see I.371[4]) as the associated PSVC. As a consequence, when multiple PSVCs are associated with the BSVC, the BSVC must meet the most stringent constraint of the associated PSVCs.								

### 9.3.9 Cause

The cause shall be coded as described in Table 8.

TABLE 8/Q.2120  
Coding for Cause

Bit								Meaning	Message Type
8	7	6	5	4	3	2	1		
0	0	0	0	0	0	0	0	Not Applicable	ALL
0	0	0	0	0	0	0	1	No PSVCI available	DENIED
0	0	0	0	0	0	1	0	Meta-signalling version not supported	DENIED
0	0	0	0	0	0	1	1	Cell rate not available	DENIED
0	0	0	0	0	1	0	0	SPID recognized	ASSIGNED
0	0	0	0	0	1	0	1	SPID not recognized	ASSIGNED
0	0	0	0	0	1	1	0	Duplicate assignment	REMOVED
0	0	0	0	0	1	1	1	System initialization	REMOVED
0	0	0	0	1	0	0	0	Point-to-point configuration active	DENIED
0	0	0	0	1	0	0	1	Point-to-Multipoint configuration active	DENIED

NOTE – All other values are reserved.

### 9.3.10 Service Profile Identifier

The service profile identifier shall be coded as described in Table 9.

TABLE 9/Q.2120  
SPID format

Bit								Octet Number
8	7	6	5	4	3	2	1	
Network Information Type								1
Network Information								2
:								to
:								11

#### 9.3.10.1 Network Information Type

The network information type sub-field shall be coded as in Table 10.

TABLE 10/Q.2120

**Coding for Network Information Type**

Bit								Meaning
8	7	6	5	4	3	2	1	
0	0	0	0	0	0	0	0	Not Applicable
0	0	0	0	0	0	0	1	Country Code (Rec. E.164) with network-specific information
NOTE – All other values are reserved.								

**9.3.10.2 Network Information**

When the “Not Applicable” Network Information Type is used, the Network Information field of the SPID parameter shall be coded as all 0’s.

When the “Country Code (Recommendation E.164) with network-specific information” Network Information Type is used, the Network Information shall be coded using numeric {0-9} BCD values. The first four digits of the Network Information shall contain the Recommendation E.164 Country Code. (This allows country specific SPIDs to be defined and indicated.) If the Country Code does not fill the first four fields, the Country Code shall be preceded by one or more BCD value 0’s (0000). The remaining fields of the Network Information shall contain the network-specific information. If the network-specific information does not completely fill the allocated octet space, the remaining octets will be filled with semi-octets of 1111.

**9.3.10.3 Service Profile Identifier Coding Examples**

Table 11 illustrates the SPID coding when the Network Information Type = Country Code (Recommendation E.164) with network-specific information, Country Code = 1, and the network-specific information = 7585824.

TABLE 11/Q.2120

**SPID coding example 1**

Bit								Octet
8	7	6	5	4	3	2	1	
0	0	0	0	0	0	0	1	1
0	0	0	0	0	0	0	0	2
0	0	0	0	0	0	0	1	3
0	1	1	1	0	1	0	1	4
1	0	0	0	0	1	0	1	5
1	0	0	0	0	0	1	0	6
0	1	0	0	1	1	1	1	7
1	1	1	1	1	1	1	1	8
....								....
1	1	1	1	1	1	1	1	11

Table 12 illustrates the SPID coding when the Network Information Type = Not Applicable and the Network Information = Not Applicable.

TABLE 12/Q.2120  
**SPID coding example 2**

Bit								Octet
8	7	6	5	4	3	2	1	
0	0	0	0	0	0	0	0	1
0	0	0	0	0	0	0	0	2
0	0	0	0	0	0	0	0	3
				....				....
0	0	0	0	0	0	0	0	11

### 9.3.11 Null fill

These bits shall be coded as all 0's.

### 9.3.12 Cyclic Redundancy Check

The CRC field is filled with the value of a CRC calculation which is performed over the entire Meta-signalling cell payload excluding the 4 octet CRC field. The CRC field shall contain the ones complement of the sum (modulo 2) of:

- the remainder of  $x^k \cdot (x^{31} + x^{30} + \dots + x + 1)$  divided (modulo 2) by the generator polynomial, where k is the number of bits of information over which the CRC is calculated; and
- the remainder of the division (modulo 2) by the generator polynomial of the product of  $x^{32}$  by the information over which the CRC is calculated.

The CRC-32 generator polynomial is:

$$G(x) = x^{32} + x^{26} + x^{23} + x^{22} + x^{16} + x^{12} + x^{11} + x^{10} + x^8 + x^7 + x^5 + x^4 + x^2 + x + 1$$

The result of the CRC calculation is placed with the least significant bit right justified in the CRC field.

As a typical implementation at the transmitter, the initial content of the register of the device computing the remainder of the division is preset to all "1's" and is then modified by division by the generator polynomial (as described above) on the information over which the CRC is to be calculated; the ones complement of the resulting remainder is put into the CRC field.

As a typical implementation at the receiver, the initial content of the register of the device computing the remainder of the division is preset to all "1's". The final remainder, after multiplication by  $x^{32}$  and then division (modulo 2) by the generator polynomial of the serial incoming cell, will be (in the absence of errors):

$$C(x) = x^{31} + x^{30} + x^{26} + x^{25} + x^{24} + x^{18} + x^{15} + x^{14} + x^{12} + x^{11} + x^{10} + x^8 + x^6 + x^5 + x^4 + x^3 + x + 1$$

See ATM Adaptation Layer [6] for further details.

## 10 Prose description of Meta-signalling procedures

### 10.1 Introduction

The Meta-signalling procedures are categorized into three groups:

- Assignment*

This involves a request from the user for the assignment of a PSVCI/BSVCI pair by the network and its subsequent response indicating either the PSVCI/BSVCI pair or the reason for denying the assignment.

b) *Checking*

This involves the network starting a verification of signalling virtual channels and the user's responses to such a check.

c) *Removal*

This indicates the removal of one or more PSVCI/BSVCI pairs. The removal procedure is initiated by the user or the network.

Note that the terms "User side" and "Network side" are used to indicate the user and network side Meta-signalling protocol entities, respectively.

SDL descriptions of the User side and Network side procedures are contained in Annex B. In cases of discrepancy with the text, the SDL description will apply. Annex A contains an overview of the state transitions at the user side and at the network side of a Meta-signalling link. Note that these diagrams do not include all possible transitions and focus on normal operation. Annex C contains the optional procedures for dynamic signalling configuration control.

### **10.1.1 User side actions**

The user side originates the assignment procedure and may originate the removal procedure. These procedures are independent of each other and are under the control of the user side Plane Management.

The user side is required to respond at any time to a checking procedure originated by the network.

### **10.1.2 Network side actions**

The network side originates the checking procedure and may originate the removal procedure. These procedures are independent of each other and are under the control of the network side Plane Management.

The network side is also required to respond to assignment procedures invoked by the user. The network side is under the control of Plane Management in this case.

The network side will process ASSIGN REQUEST messages while a check procedure is active.

The network side may also originate the removal procedure while a check procedure is active.

## **10.2 Focused message prevention**

To prevent a focused overload on multiple interfaces, Plane Management at the network side may stagger the initialization of various interfaces or virtual paths on an interface during a re-initialization of that node.

In order to minimise the effect of many terminals on one interface initializing simultaneously (e.g. after commercial power failure and recovery), load spreading will be performed. This is achieved as follows:

When the user side desires to send any message, it shall delay the sending of that message by a time specified by timer  $T_{\text{mu}2}$ . This timer shall have a random value ranging between 0 seconds and 600 ms.

## **10.3 General parameter examination procedure**

When a Meta-signalling protocol entity receives a message with Meta-signalling indicated in the PD parameter it shall, independent of its current state, first check the message parameters indicated below in the order shown.

If all checks are successful the Meta-signalling protocol entity continues further processing according to its state and the contents of the received Meta-signalling message.

### **10.3.1 CRC parameter check**

The CRC parameter is checked to determine if it contains the correct result of a CRC calculation as described in 9.3.12.

When the CRC mechanism detects an errored Meta-signalling message, the message is ignored.

### **10.3.2 PV parameter check**

The PV parameter is checked for supported protocol versions.

If the network does not support the protocol version requested by the user side in an ASSIGN REQUEST message, a DENIED message is sent with the cause "Meta-signalling version not supported". The network side shall include a protocol version which it supports in the PV field of the DENIED message. The user side may attempt to perform the assignment procedures again using another protocol version. If any other message is received which contains an unsupported protocol version, that message is ignored.

NOTES

1 The format and location of the protocol version, message type, reference indicator and CAU fields must be maintained in future versions of the protocol.

2 The Meta-signalling protocol at the network side must be able to recognise and respond to the ASSIGN REQUEST messages of different protocol versions. The Meta-signalling protocol at the user side must be able to recognise and respond to the DENIED messages of different protocol versions.

**10.3.3 MT parameter check**

MT parameter is checked to determine if it contains one of the valid message types defined in 9.3.3.

When a meta-signalling message is received with an unknown message type, the message is ignored.

**10.3.4 Other parameter checks**

All other parameters that are associated with the defined Message Type are checked to determine that they contain valid parameter values. If any invalid values are detected, the message is ignored.

**10.4 Assignment procedure**

The assignment procedure provides the mechanism whereby the user side is allocated a PSVC or a point-to-point signalling virtual channel and an associated broadcast call offering signalling virtual channel by the network.

Where signalling is supported in a VP (with a VPI = x) the assignment procedure is initiated by the user side Plane Management after power-on if:

- a) there is a need to use a signalling channel in VPI x; or
- b) if any cells with VPI = x, VCI ≠ 0 are detected in the network-to-user direction.

Figures 4 and 5 relate to the assignment procedure. Annex C defines an optional Dynamic Signalling Configuration Control procedure.

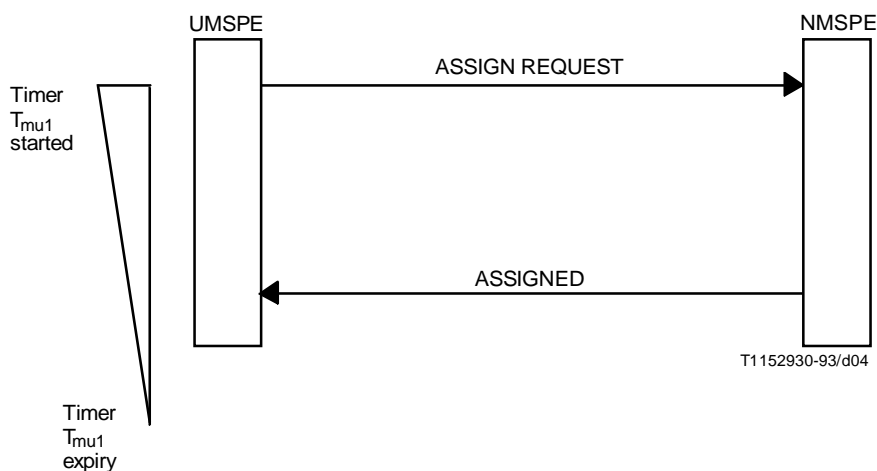

FIGURE 4/Q.2120  
Successful SVCI assignment



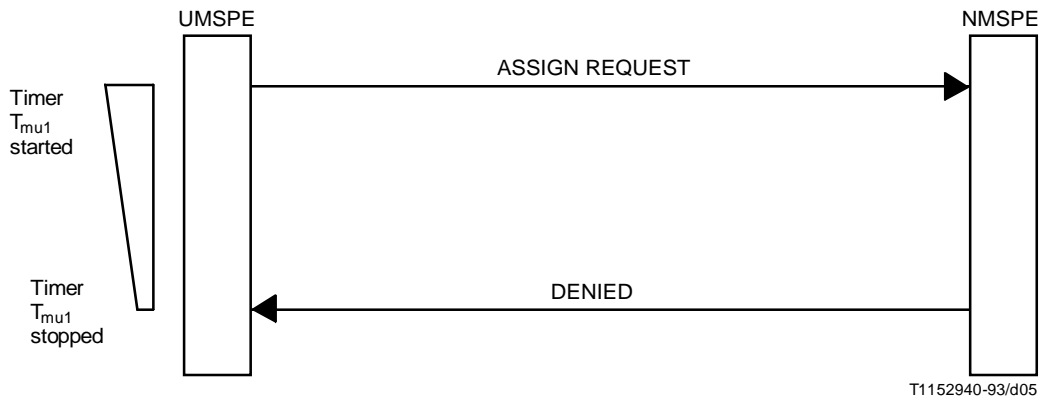

FIGURE 5/Q.2120  
Unsuccessful SVCI assignment

#### 10.4.1 User side

Following the receipt of an ESTABLISH\_SVC-request primitive from Plane Management, the user side originates the assignment procedure by sending an ASSIGN REQUEST message to the network side. The message contains a PCR, an SPID, an RI and an SCON parameter. The user side then starts timer  $T_{mu1}$ .

While timer  $T_{mu1}$  is active, the assignment procedure monitors the meta-signalling channel for any ASSIGNED or DENIED messages with an RI value that matches the RI value sent in the ASSIGN REQUEST message. Such a matching value of RI is called a valid RI value.

The following procedures are designed to guard against the assignment of identical SVCIs to different signalling endpoints.

##### 10.4.1.1 Normal conditions

If, by the expiry of  $T_{mu1}$ , a single ASSIGNED message with the valid RI has been received, an ESTABLISH\_SVC-confirm primitive is sent to Plane Management including the PSVCI, BSVCI, and cause.

If, before the expiry of  $T_{mu1}$ , the first message received with a valid RI value is a DENIED message, the Meta-signalling entity will stop timer  $T_{mu1}$  and send an ESTABLISH\_FAIL-indication primitive to Plane Management including the cause for the denial.

Once an assignment has been successfully completed, the user side continues to check messages to determine if the PSVCI in any subsequent ASSIGNED message matches its own currently assigned value. If a match is found, an ESTABLISH\_FAIL-indication is sent to Plane Management with a cause indicating duplicated assignment. The PSVC and BSVC are removed using the removal procedure.

##### 10.4.1.2 Abnormal conditions

If timer  $T_{mu1}$  expires before any ASSIGNED or DENIED message with a valid RI is received, then the same ASSIGN REQUEST message is re-issued using a new randomly generated RI value and timer  $T_{mu1}$  is started. If  $T_{mu1}$  expires again, an ESTABLISH\_FAIL-indication primitive is sent to Plane Management indicating the cause.

If, before the expiry of  $T_{mu1}$ , the first message received with a valid RI value is an ASSIGNED message, and if afterwards either:

- an ASSIGNED or DENIED message with a valid RI value, or
- an ASSIGNED message with the same PSVCI but different RI value,

is detected, timer  $T_{mu1}$  is stopped and an ESTABLISH\_FAIL-indication primitive is sent to Plane Management indicating the cause. The PSVC is then removed using the removal procedure.

### 10.4.2 Network side

The network side, upon receiving an ASSIGN REQUEST message, sends an ESTABLISH\_SVC-indication primitive to Plane Management which includes the SCOM, SPID and cell rate carried in the message. The network Plane Management should then determine the appropriate response.

If the network is unable to assign signalling channels due to resource constraints (e.g. maximum number of connections is already assigned, cell rate requested is not available.), then Plane Management will send an ESTABLISH\_FAIL-request primitive including a cause value. This will result in a DENIED message being sent which includes a cause and the RI value that was received in the ASSIGN REQUEST message. Other causes for a DENIED message being sent include the situations where a point-to-point or point-to-multipoint configuration is active or where the requested version of the protocol is not supported. In this final case the network should set the PV parameter to the version number of the protocol it does support.

Otherwise, the network Plane Management should select appropriate PSVCI/BSVCI values for the point-to-point and broadcast signalling virtual channels. Plane Management then sends an ESTABLISH\_SVC-response primitive including those values. These are then sent in an ASSIGNED message using the same RI value received in the ASSIGN REQUEST message.

The values for the cause and BSVC parameters, returned in the ASSIGNED message in response to the SPID parameter received in the ASSIGN REQUEST message indicating various user/network capabilities, are given in Table 13.

TABLE 13/Q.2120

**Network responses to different SPIDs received in ASSIGN REQUEST**

Network Type	SPID Meaning Received	Cause Meaning Returned	BSVC
Supports Service Profile concept	Not Applicable	Not Applicable	GBSVC
Supports Service Profile concept	N – recognized SPID	SPID recognized	GBSVC or SBSC
Supports Service Profile concept	X – unrecognized SPID	SPID not recognized	GBSVC
Does not support Service Profile concept	Any SPID including Not Applicable	Not Applicable	GBSVC

NOTE – A network meta-signalling protocol entity, on an interface defined as point-to-point by subscription, that receives an ASSIGN REQUEST message will notify Plane Management that this condition has occurred.

### 10.5 Check procedure

The check procedure provides a mechanism to allow the network to determine which signalling virtual channels are assigned. Specifically, it allows the network to determine:

- a) whether a particular point-to-point signalling virtual channel is assigned or not;
- b) if a particular point-to-point signalling virtual channel is in duplicate assignment;
- c) all assigned point-to-point and broadcast signalling virtual channels;
- d) whether a particular broadcast signalling virtual channel is assigned or not;
- e) the correctness of the relationship between the PSVCI, BSVCI and SPID.

These procedures are initiated by the network Plane Management. Only one check procedure is permitted at a time. Potential conditions for initiating this procedure include, but are not limited to:

- a) periodic audit of all assigned signalling virtual channels to verify the existence of the signalling endpoints or to detect signalling endpoints that are no longer active, but have not requested removal of their signalling channels (This may be performed when all allowable signalling virtual channels are assigned, thus preventing any further assignments.);

- b) updating of tables following extraordinary error situations (e.g. power interruption within the switching system);
- c) on demand from Plane Management.

**10.5.1 Network side**

Following the receipt of a CHECK\_SVC-request primitive from Plane Management, the network side originates the check procedure by sending a CHECK REQUEST message which contains one of the following:

- 1) the virtual channel identifier of a particular point-to-point signalling virtual channel to be checked, or
- 2) the virtual channel identifier of a broadcast signalling virtual channel to be checked, or
- 3) the value 1 to indicate all signalling virtual channels.

The virtual channel identifier value of the SVC to be checked will be placed in the SVCIA parameter in the message. After sending the CHECK REQUEST message, the network side starts timer  $T_{mn1}$ .

Whenever a CHECK RESPONSE message is received while timer  $T_{mn1}$  is active, the PSVCI, BSVCI and SPID values are stored and timer  $T_{mn1}$  is restarted. If, after receiving at least one CHECK RESPONSE message, timer  $T_{mn1}$  expires, a CHECK\_RESULT-indication primitive shall be sent to Plane Management indicating the completion of the check procedure and including all the stored responses. See Figure 6.

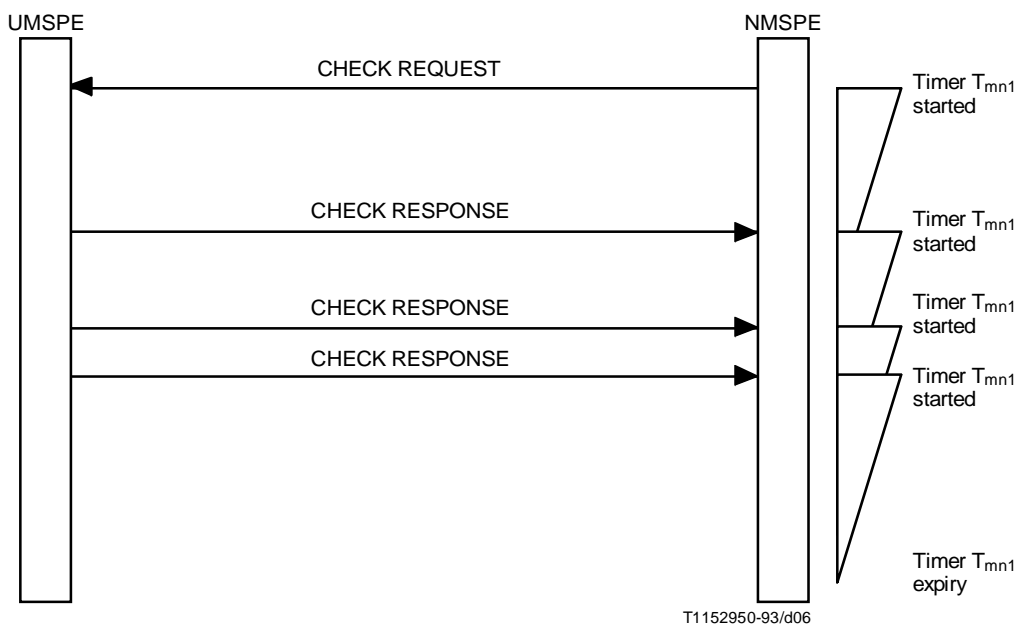

**FIGURE 6/Q.2120**  
**Check procedure**

If the network side receives no response before the first expiration of timer  $T_{mn1}$ , it shall resend the CHECK REQUEST message and restart timer  $T_{mn1}$ . If no response is received by the second expiry of  $T_{mn1}$ , a CHECK\_RESULT-indication primitive shall be sent to Plane Management indicating that no responses were received. The network side Plane Management shall internally remove the indicated SVCI(s) checked by this procedure. See Figure 7.

Whenever the network side Plane Management detects duplicated PSVCI values in the responses received during a Check procedure, it shall remove that PSVC using the removal procedure.

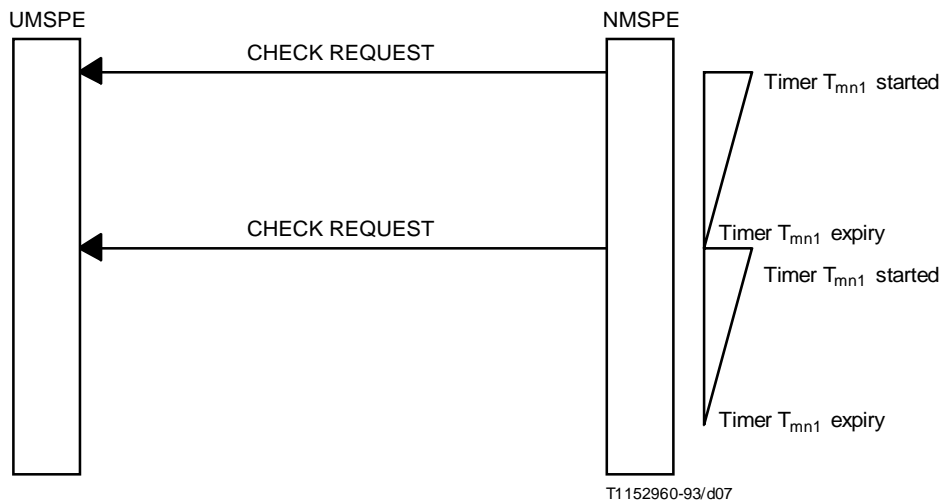

FIGURE 7/Q.2120  
Check procedure – No response

### 10.5.2 User side

The user side shall check the contents of the SVCIA parameter in the CHECK REQUEST message.

If the value in the SVCIA parameter is equal to either:

- 1) the value 1 to indicate all signalling virtual channels; or
- 2) the value of the assigned point-to-point signalling virtual channel identifier; or
- 3) the value of the assigned broadcast signalling virtual channel identifier,

then a CHECK RESPONSE message shall be sent that contains the point-to-point and broadcast SVCI values assigned at the user side as well as the SPID. If no match is found, then no response shall be sent.

### 10.6 Removal procedure

The removal procedure provides a mechanism to indicate the completed removal of one or more signalling virtual channels.

The user side can indicate the removal of its own point-to-point signalling virtual channel only.

NOTE – By implication the user side Plane Management will have removed the association between that point-to-point signalling virtual channel and its broadcast signalling virtual channel.

The network side can indicate the removal of:

- a particular point-to-point signalling virtual channel, or
- a particular broadcast signalling virtual channel and all associated point-to-point signalling virtual channels, or
- all signalling virtual channels.

Conditions for removing a signalling channel include, but are not limited to:

- a) the network or user has determined an incorrect assignment condition regarding the signalling channels involved, such as multiple assignment of point-to-point signalling virtual channels;
- b) either the user or network has determined that the signalling virtual channels are no longer needed.

Two REMOVED messages are sent to cover the possibility of loss of a REMOVED message.

## 10.6.1 Removal initiated by user

### 10.6.1.1 User side

Following the local removal of the point-to-point and the broadcast signalling virtual channels by user Plane Management, it shall indicate this by sending a REMOVE\_SVC-request primitive to the user MSPE. The UMSPE will send two identical REMOVED messages to the network side indicating the signalling virtual channel removed (see Figure 8). The REMOVED message shall indicate the PSVC removed in the SVCIA parameter. The REMOVED messages shall contain the appropriate cause value.

NOTE – The User Plane Management removes both the PSVC and the BSVC. The Network Plane Management removes the PSVC, and removes the BSVC if no existing associations of the BSVC with other PSVCs exist.

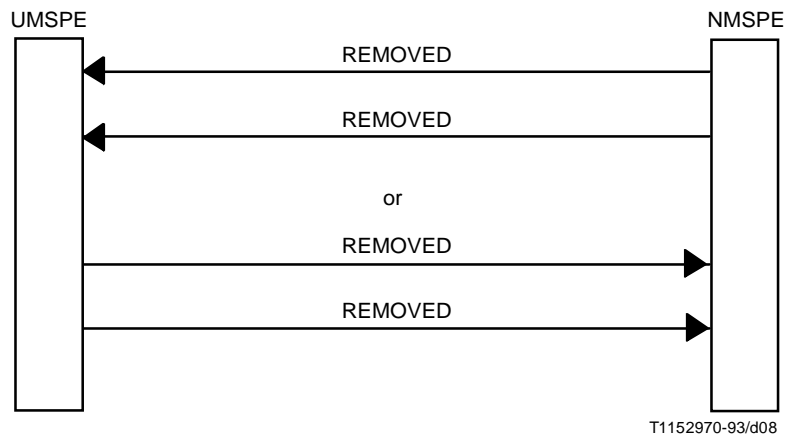

NOTE – This procedure can be invoked by either the User side or the Network side.

FIGURE 8/Q.2120  
Removal procedure

### 10.6.1.2 Network side

Upon receipt of any REMOVED message, the network side shall send a REMOVED\_SVC-indication primitive to Plane Management with the received PSVCI and Cause. The signalling endpoint identified by the indicated PSVCI is removed. The removal of the associated BSVC depends on the existence of other signalling relationships which include the same BSVC.

## 10.6.2 Removal initiated by the network

### 10.6.2.1 Network side

Following the removal of:

- a PSVC, and if appropriate, the associated BSVC; or
- a BSVC and associated PSVCs; or
- all SVCs,

the Network Plane Management will send a REMOVE\_SVC-request primitive to the NMSPE. The NMSPE will then send two identical REMOVED messages to the user side indicating the signalling virtual channel(s) removed (see Figure 8). The REMOVED messages shall contain the appropriate cause value and the appropriate signalling virtual channel identification in the SVCIA parameter coded according to Table 14.

When a network requires the removal of all existing SVCI assignments, it should initiate a removal procedure using SVCIA = 1 and an appropriate cause value.

TABLE 14/Q.2120

**Network Side Removal – Parameter Codings**

VCI to be removed	SVCIA parameter
PSVCI	PSCVI value
BSVCI	BSVCI value
All PSVCI and BSVCI	1

**10.6.2.2 User side**

Upon receipt of a REMOVED message, the user side shall send a REMOVED\_SVC-indication primitive to Plane Management including the SVCI and cause values.

**11 Timers****11.1 Timer definitions**

The following timers are used at the user side:

$T_{mu1}$ : Timer which supervises the assignment procedure (see 10.4.1).

$T_{mu2}$ : Timer used to delay the sending of each message (see 10.2).

The following timer is used at the network side:

$T_{mn1}$ : Timer which supervises the check procedure (see 10.5.1).

The timer values are given in Table 15.

TABLE 15/Q.2120

**Timer values**

User Side Timer	Range	Network Side Timer	Range
$T_{mu1}$	1600-2400 ms	$T_{mn1}$	800-1200 ms
$T_{mu2}$	0-600 ms		

**Annex A****State overview diagrams**

(This annex forms an integral part of this Recommendation)

The State Overview diagrams are shown for the User Side and the Network Side. (See Figures A.1 to A.3.)

The notation used has the following meaning:

- Input received/Output sent; or
- action(s) taken (separated by commas).

CP\_ASSIGNMENT\_FAIL/ESTAB\_FAIL\_ind.  
 CP\_ASSIGNED/ESTAB\_SVC\_conf.  
 CP\_ASSIGN\_REQ/ASSIGN\_REQ

Establish\_SVC\_req/create MS\_SVC process,Assign\_REQ  
 REMOVE\_SVC\_req./REMOVED, REMOVED

CP\_REMOVE\_REQ/REMOVED, REMOVED  
 CP\_CHECK\_RESP/CHECK\_RESP  
 CP\_REMOVED/REMOVED\_SVC

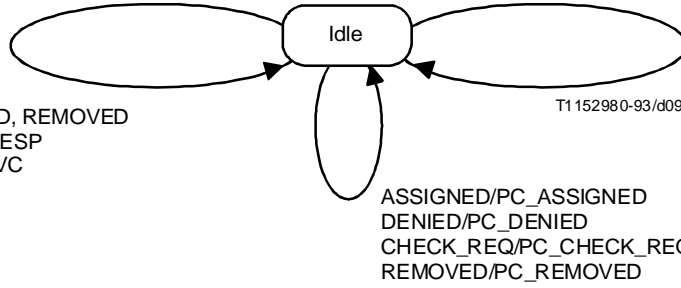

**Meta\_Sig\_User Process**

FIGURE A.1/Q.2120  
**Meta\_Sig\_User (user side)**  
**Process state overview**

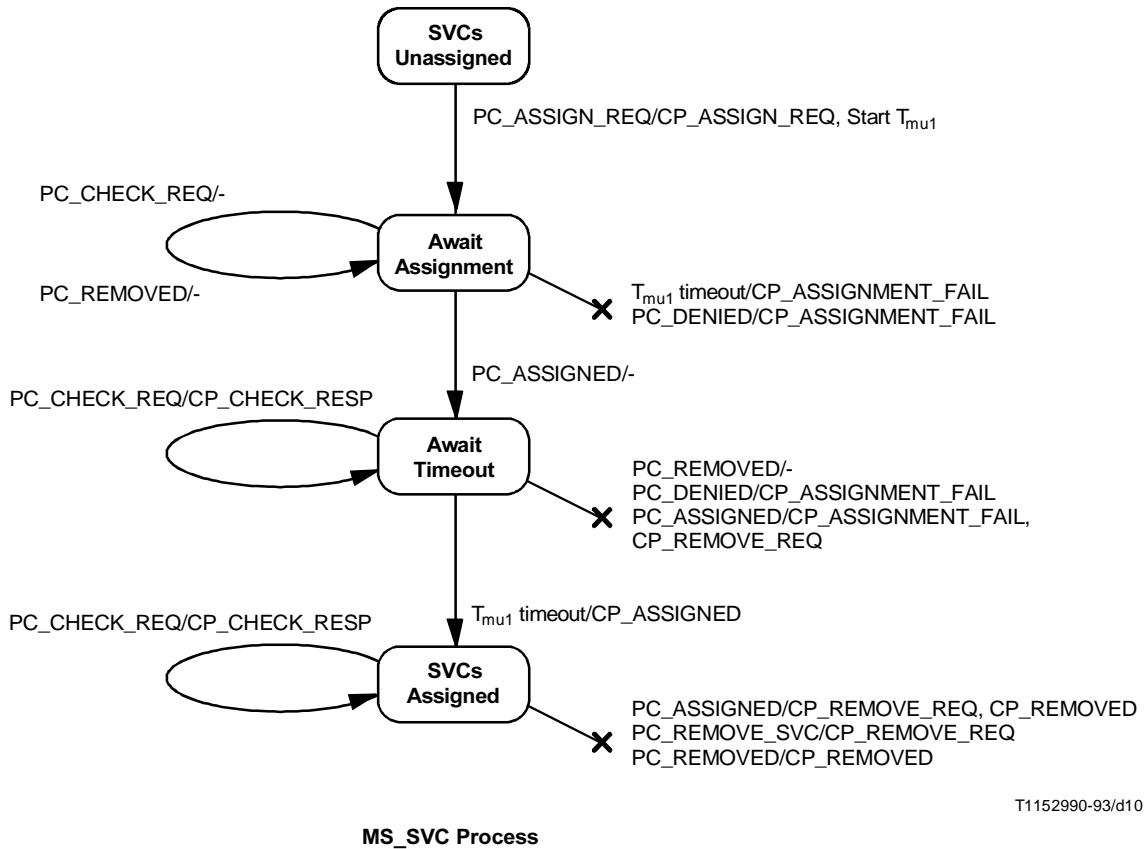

**MS\_SVC Process**

FIGURE A.2/Q.2120  
**MS\_SVC (user side)**  
**Process state overview**

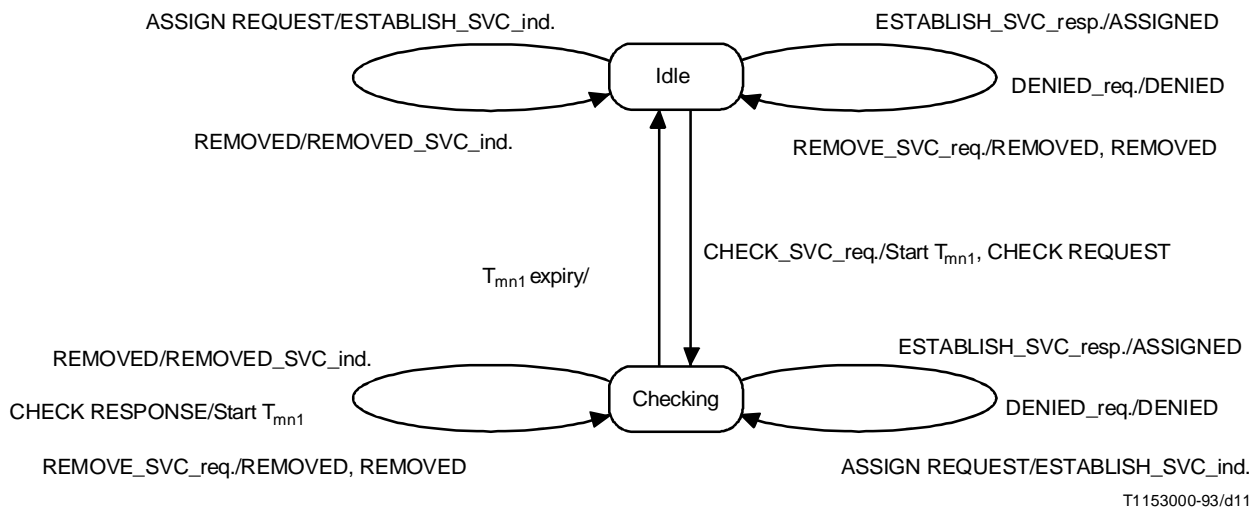

FIGURE A.3/Q.2120  
**Network side meta-signalling procedure**  
**Process state overview**

## Annex B

### SDL description of Meta-signalling procedures

(This annex forms an integral part of this Recommendation)

Where differences occur between the text and the description in this annex, the SDL description shall take precedence over the text.

The following notation is used throughout the SDL representation of the meta-signalling procedures. (See Figures B.1 to B.8.)

NOTE – Acronyms and abbreviations used throughout this Recommendation are defined in clause 4.

Process name and block name abbreviations are:

- Meta-Sig-Proc Meta-signalling procedure process for each signalling endpoint
- Meta-Sig-User Meta-signalling procedure process User Side
- N\_MS\_PE Network Meta-signalling Protocol Entity (Block name)
- U\_MS\_PE User Meta-signalling Protocol Entity (Block name)

Internal Meta-signalling signals passed from child to parent are:

- cp-assign\_request
- cp-assigned
- cp-assignment\_fail
- cp-check\_response
- cp-remove\_request
- cp-removed

Internal Meta-signalling signals passed from parent to child are:

- pc-assign\_request
- pc-assigned
- pc-check
- pc-check\_indication
- pc-denied
- pc-remove\_svc
- pc-removed



Primitives for describing communication between the Meta-signalling ATM-LME and Plane Management are:

CHECK\_RESULT-indication (Meta-signalling to Plane Management)  
CHECK\_SVC-request (Plane Management to Meta-signalling)  
ESTABLISH\_FAIL-indication (Meta-signalling to Plane Management)  
ESTABLISH\_FAIL-request (Plane Management to Meta-signalling)  
ESTABLISH\_SVC-indication (Meta-signalling to Plane Management)  
ESTABLISH\_SVC-response (Plane Management to Meta-signalling)  
REMOVE\_SVC-request (Plane Management to Meta-signalling)  
REMOVED\_SVC-indication (Meta-signalling to Plane Management)

Primitives for describing communication between the Meta-signalling ATM-LME and the ATM Layer are:

ATM-LM-DATA-indication (ATM Layer to Meta-signalling)  
ATM-LM-DATA-request (Meta-signalling to ATM Layer)

Messages for communication between the Meta-signalling user side and the Meta-signalling network side are:

ASSIGN REQUEST (user to network)  
ASSIGNED (network to user)  
CHECK RESPONSE (both)  
CHECK REQUEST (both)  
DENIED (network to user)  
REMOVED (both)

All input symbols indicate from where the input came and show the parameters in parentheses (param1, param2, param3, ...). This information is contained either within the input symbol or in a comment symbol associated with that input.

All output symbols indicate to where the output is directed and indicate the parameters associated with the output within the output symbol, in a comment symbol associated with the output, or in a "Build\_Cell" macro call immediately before (or immediately after) the output symbol.

The timer used within the network side procedures is:

$T_{mn1}$  Check procedure supervision (value =  $t_n$  1800 – 1200 ms).

Timers used within the user side procedures are:

$T_{mu1}$  Assignment procedure supervision (value =  $t_{u1}$ , 1600 – 2400 ms).  
 $T_{mu2}$  Delay before sending next message (value =  $t_{u2}$ , 0 – 600 ms).

PROCESS

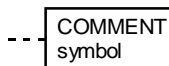
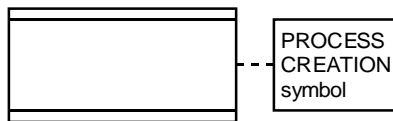
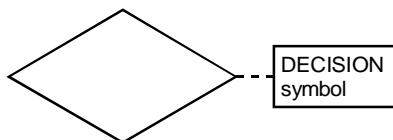
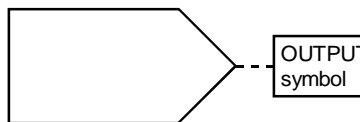
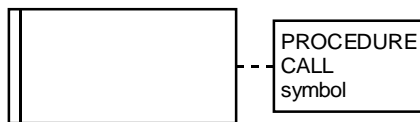
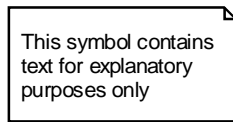
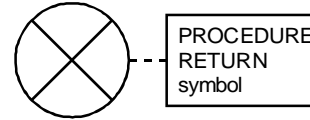
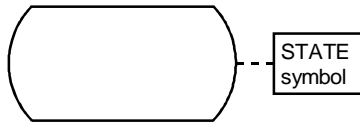
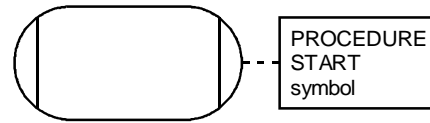
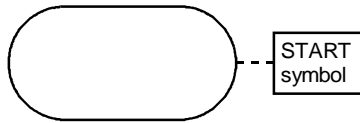

\*\*\*\* NOTE \*\*\*\*  
The symbols used in these pages are a subset of those detailed in Recommendation Z.100.

T1172470-95/d12

FIGURE B.1/Q.2120

Key to symbols used in SDL representation of processes

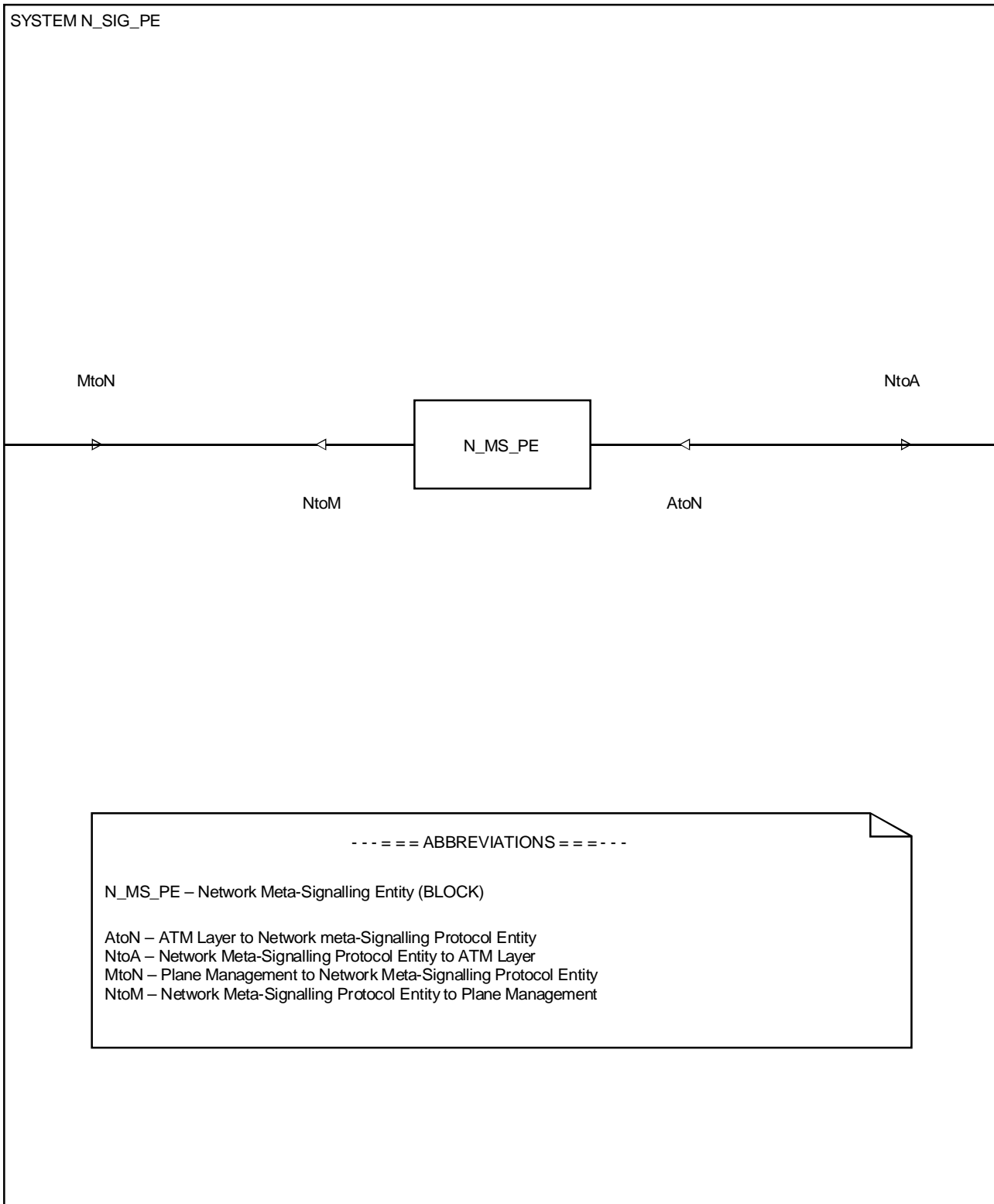

T1172480-95/d13

FIGURE B.2/Q.2120  
**Network side system diagram**

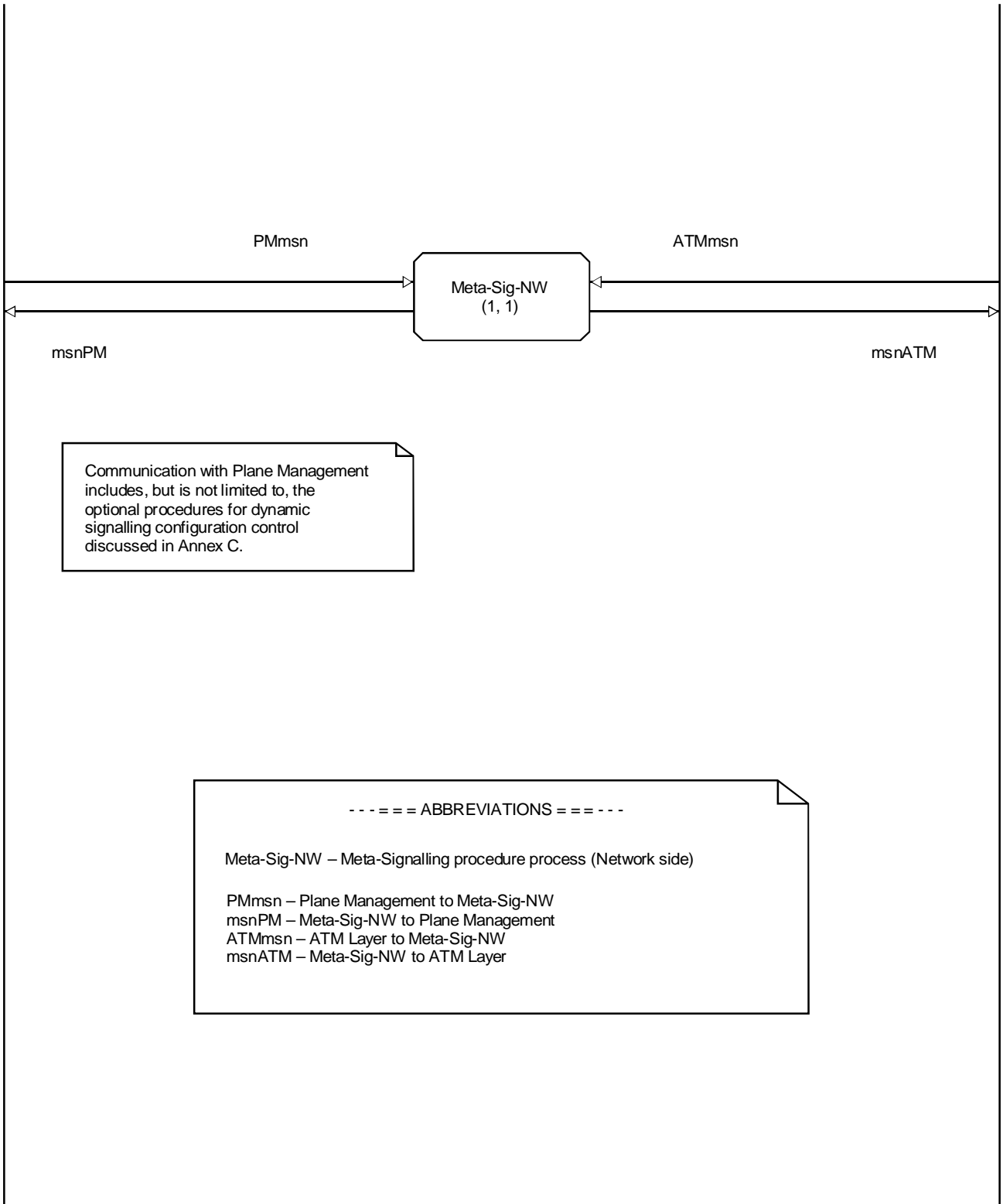

T1172490-95/d14

FIGURE B.3/Q.2120  
**Meta-signalling procedure process (network side)**

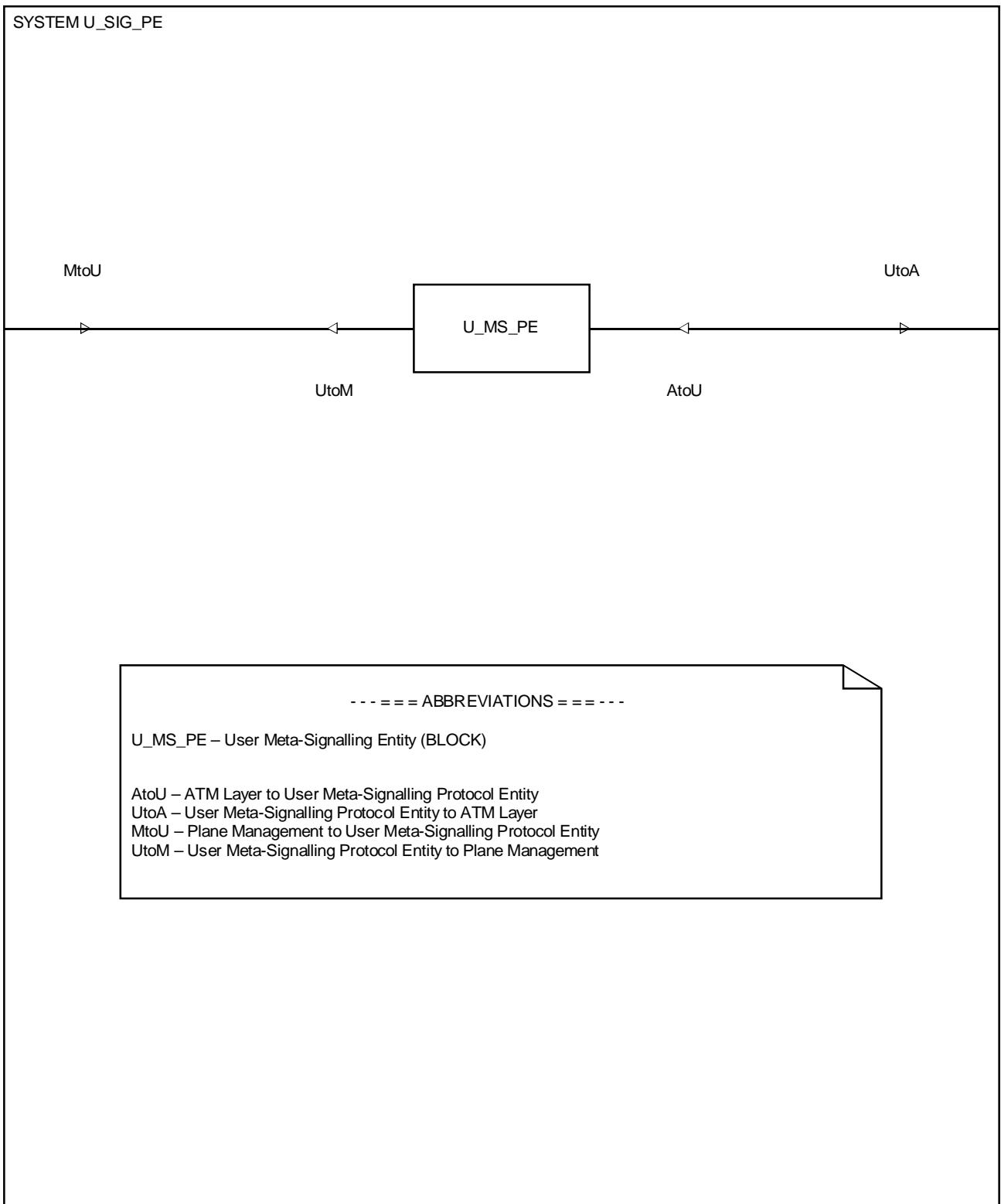

T1172500-95/d15

FIGURE B.4/Q.2120  
**User side system diagram**

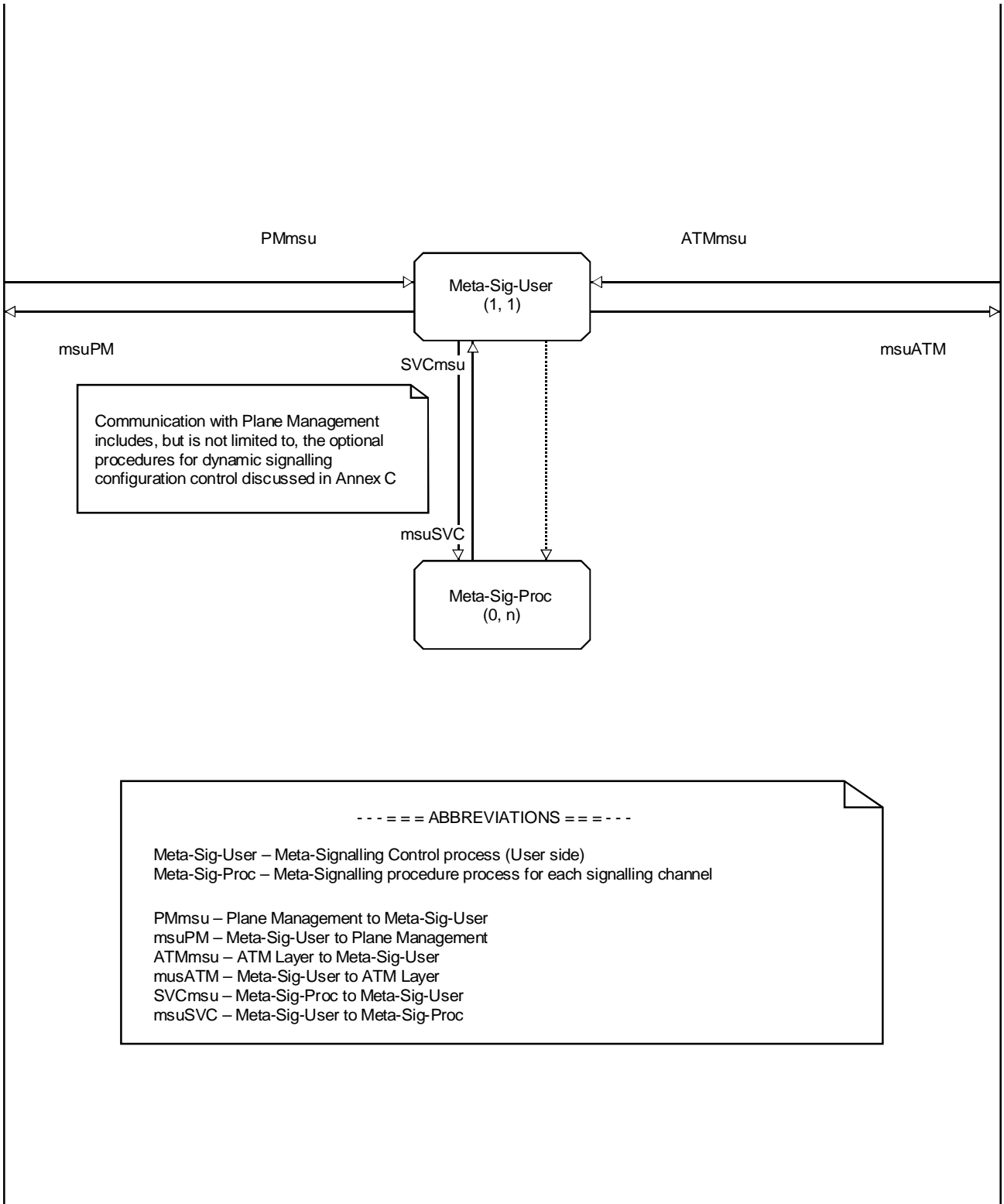
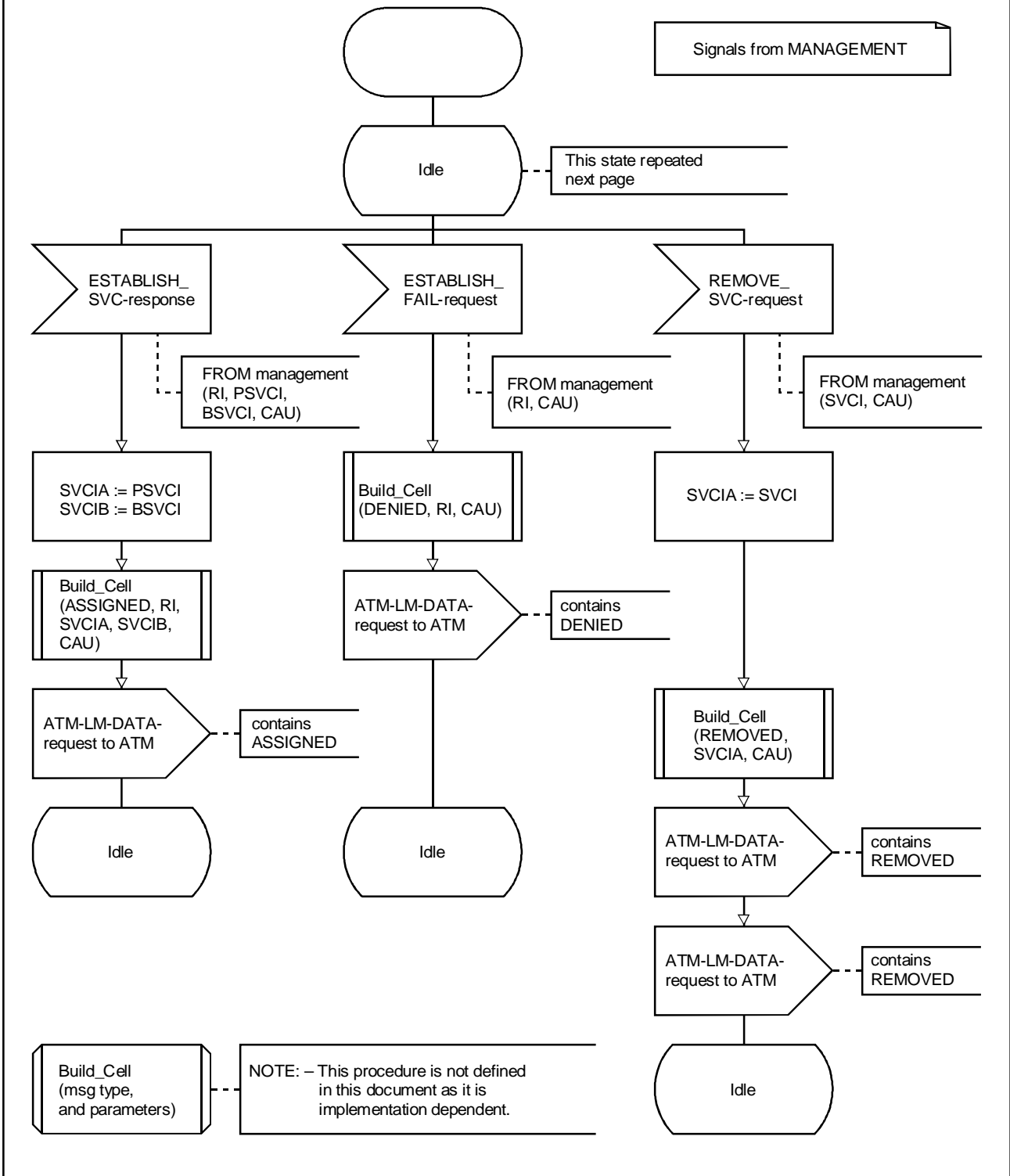

FIGURE B.5/Q.2120  
**Meta-signalling control process (user side)**



T1172520-95/d17

FIGURE B.6/Q.2120 (sheet 1 of 6)  
**SDL for Meta-signalling procedure process (network side)**

Signals FROM MANAGEMENT

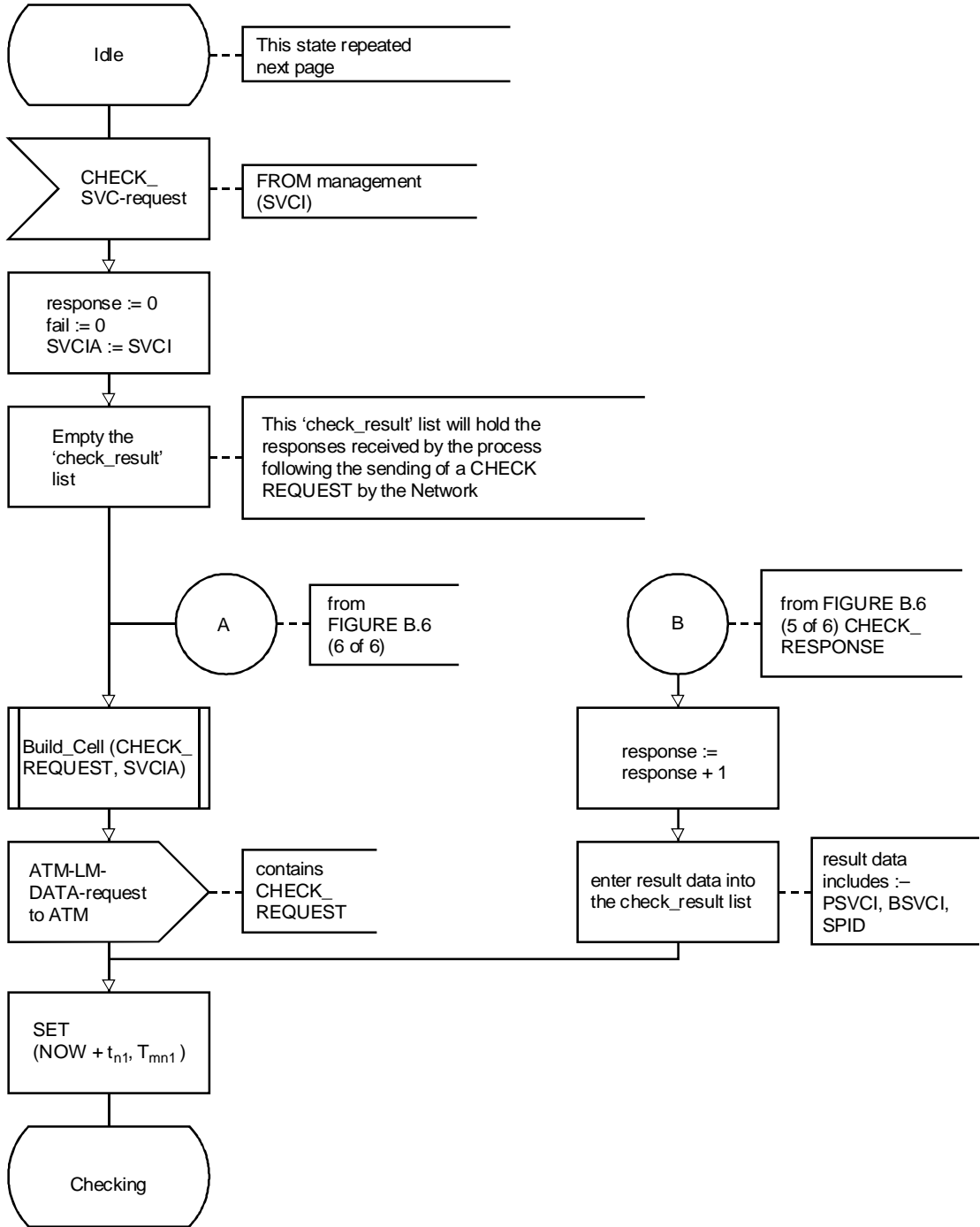

T1172530-95/d18

FIGURE B.6/Q.2120 (sheet 2 of 6)  
SDL for Meta-signalling procedure process (network side)



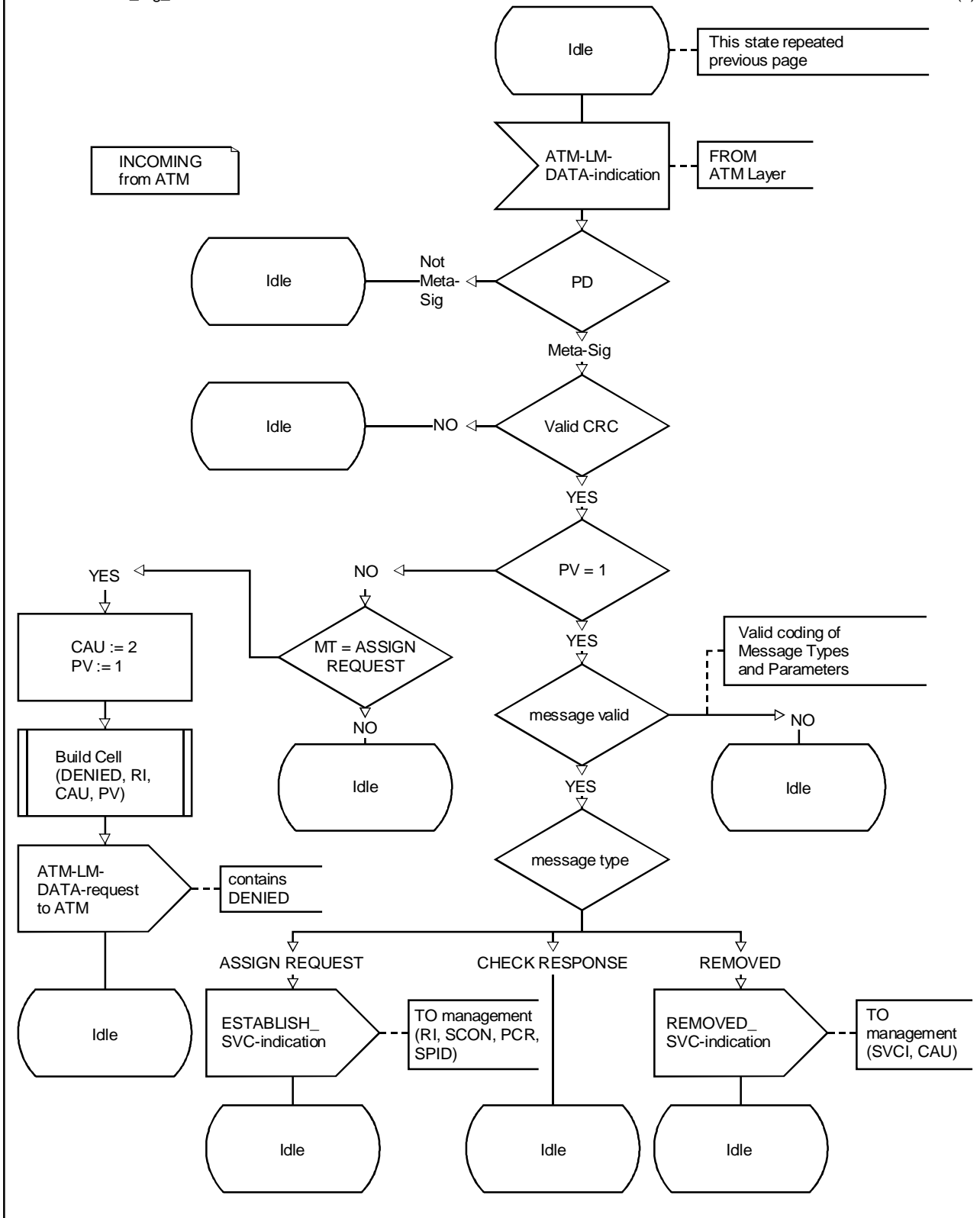

T1172540-95/d19

FIGURE B.6/Q.2120 (sheet 3 of 6)  
 SDL for Meta-signalling procedure process (network side)

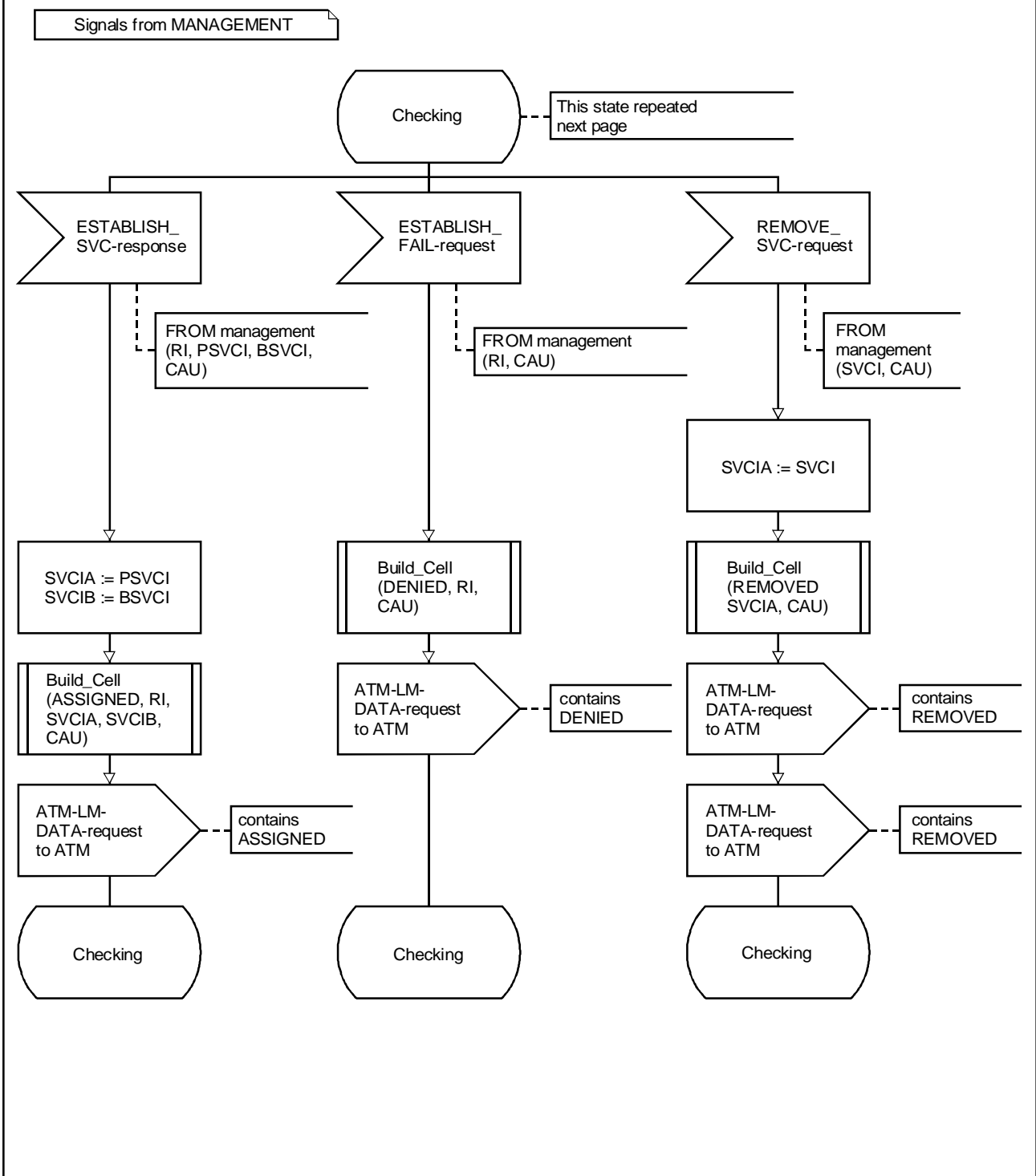

T1172550-95/d20

FIGURE B.6/Q.2120 (sheet 4 of 6)  
**SDL for Meta-signalling procedure process (network side)**

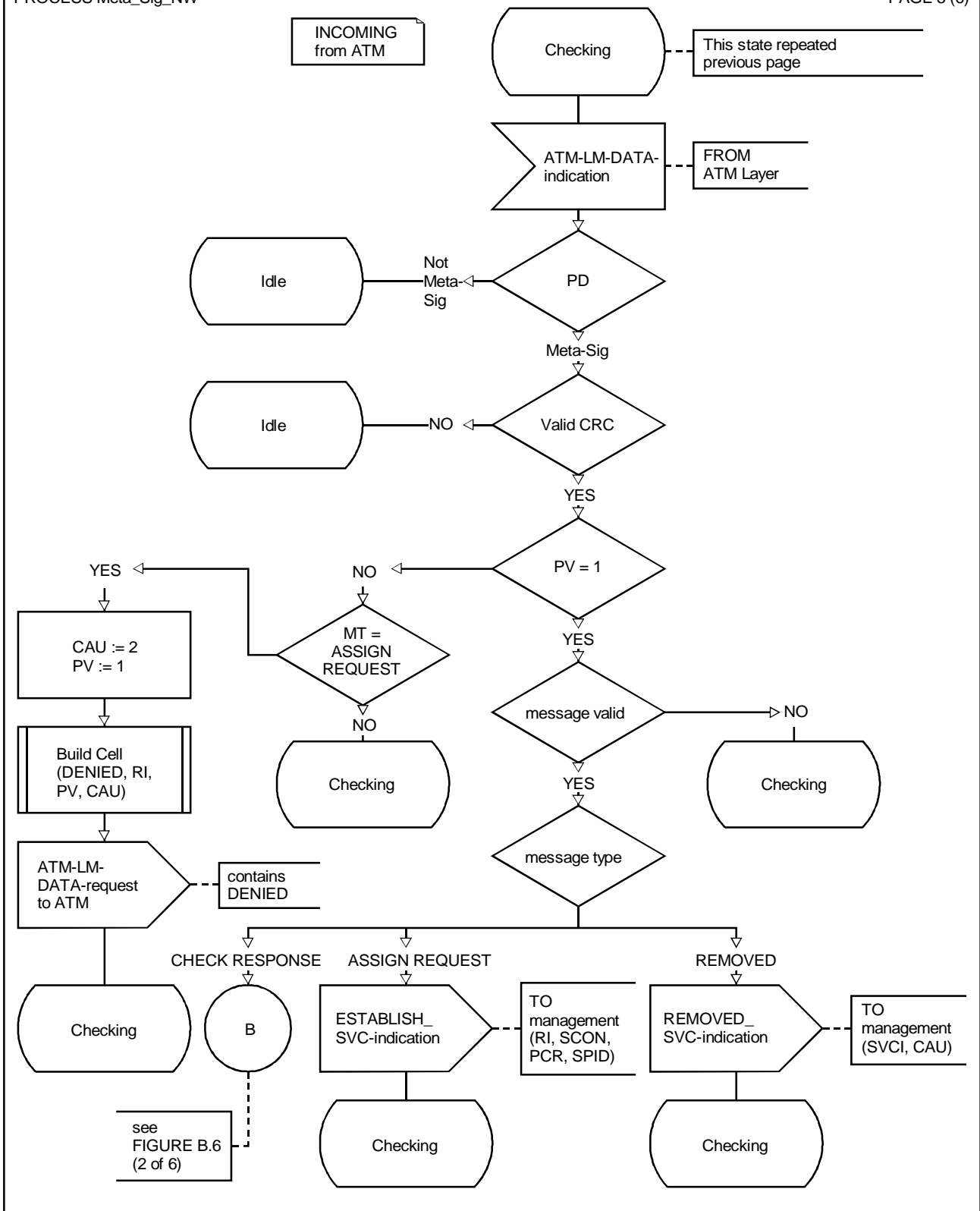

T1172560-95/d21

FIGURE B.6/Q.2120 (sheet 5 of 6)  
 SDL for Meta-signalling procedure process (network side)

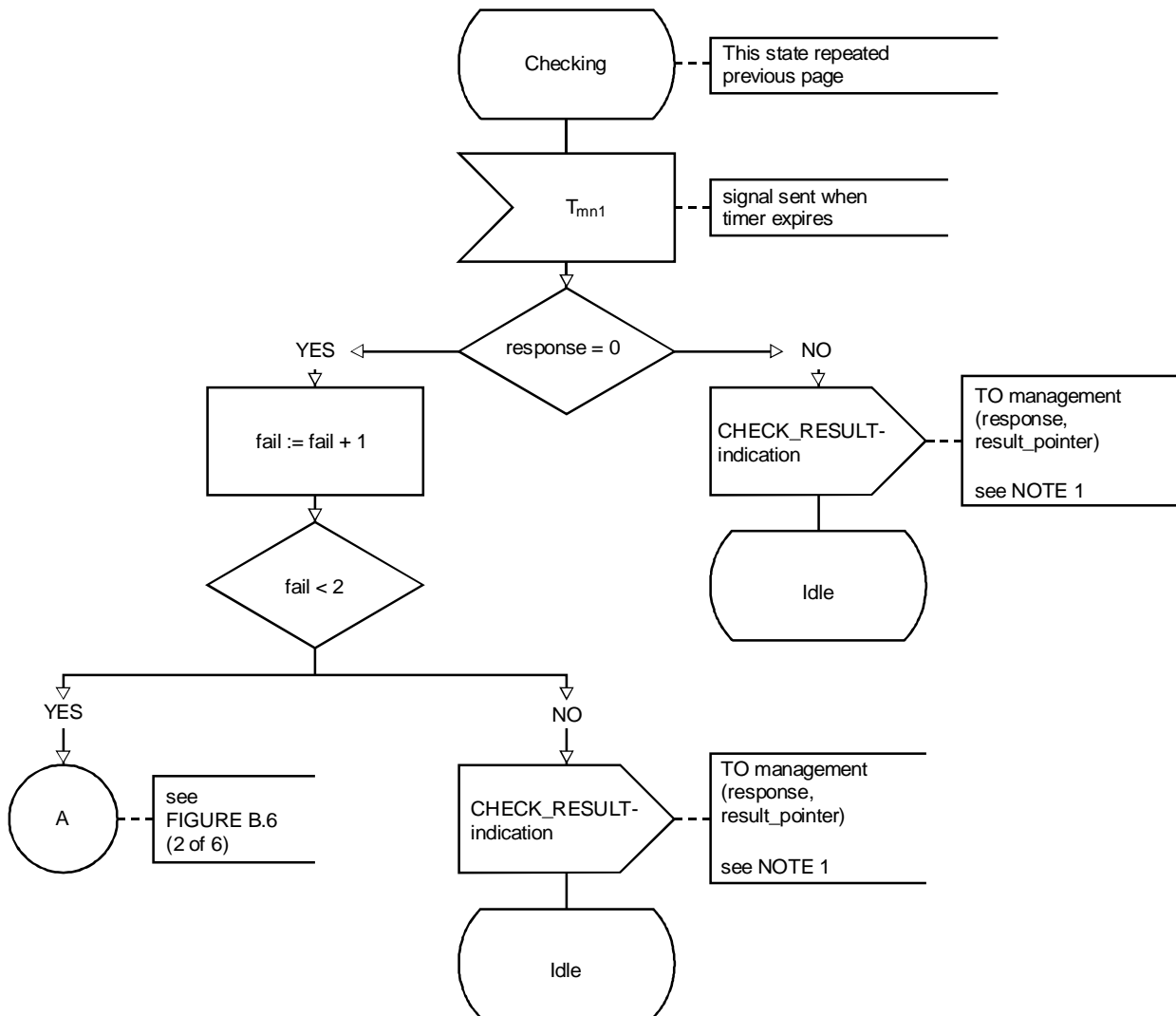

\*\*\* NOTE 1 \*\*\*

The primitive sent to management will contain :-

- i) the current value of response
- ii) a pointer to 'check\_result' list

A non-zero value of response indicates that at least one response has been received. A zero value of response indicates that no responses have been received and that the 'check\_result' list is empty.

T1172570-95/d22

FIGURE B.6/Q.2120 (sheet 6 of 6)  
**SDL for Meta-signalling procedure process (network side)**

MANAGEMENT to PARENT  
PARENT to CHILD signals

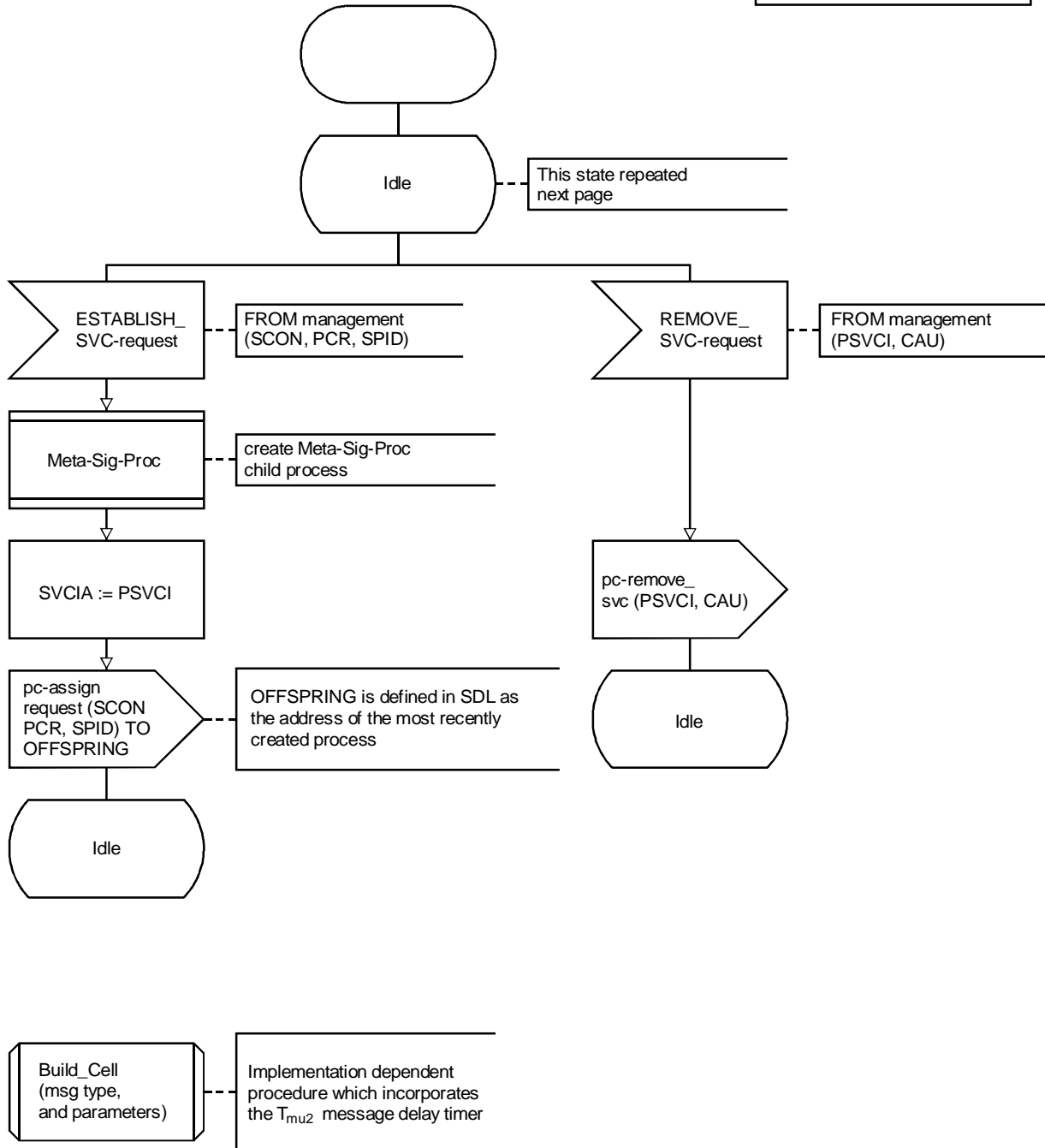

T1172580-95/d23

FIGURE B.7/Q.2120 (sheet 1 of 4)  
SDL for Meta-signalling control process (user side)

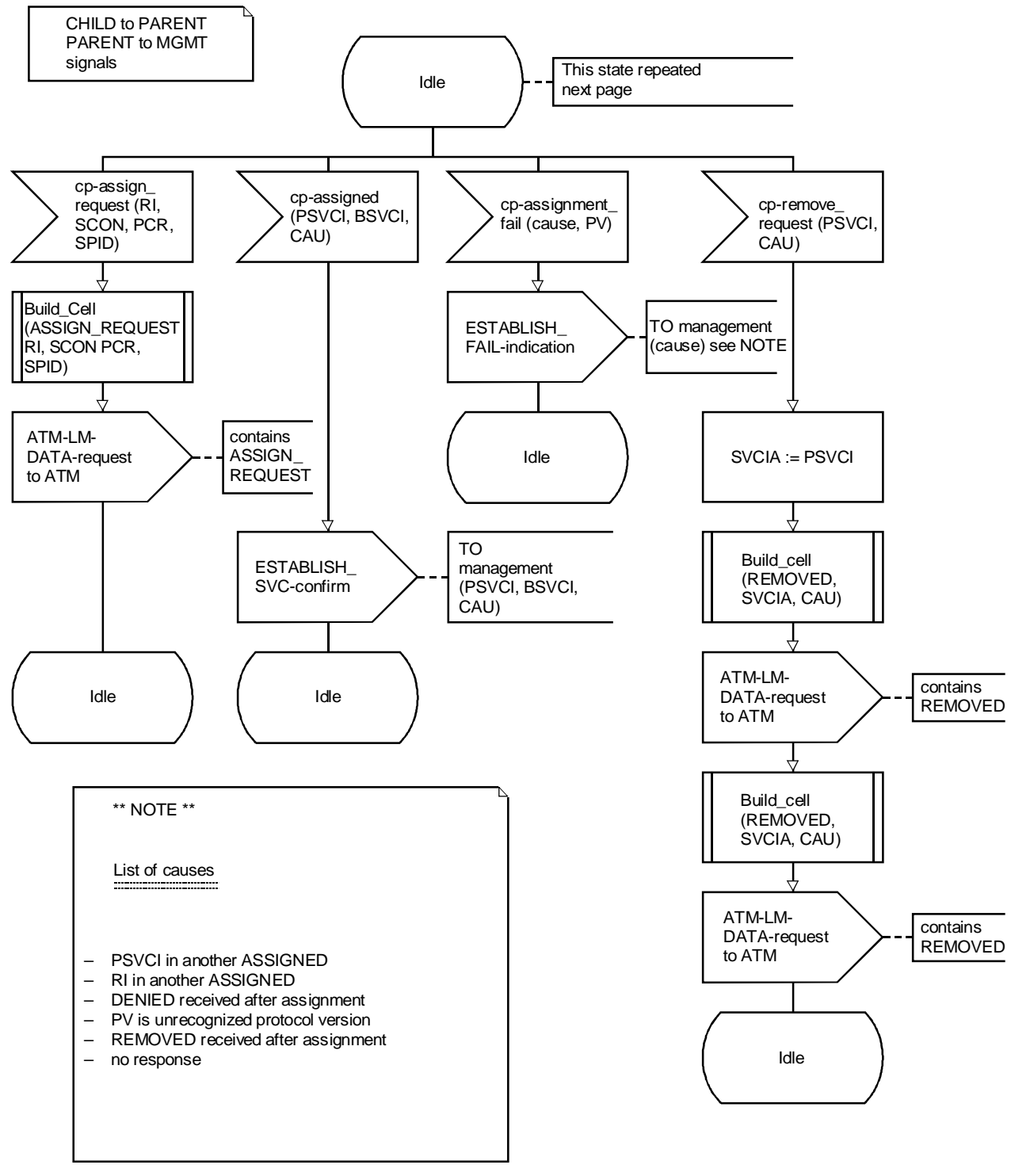
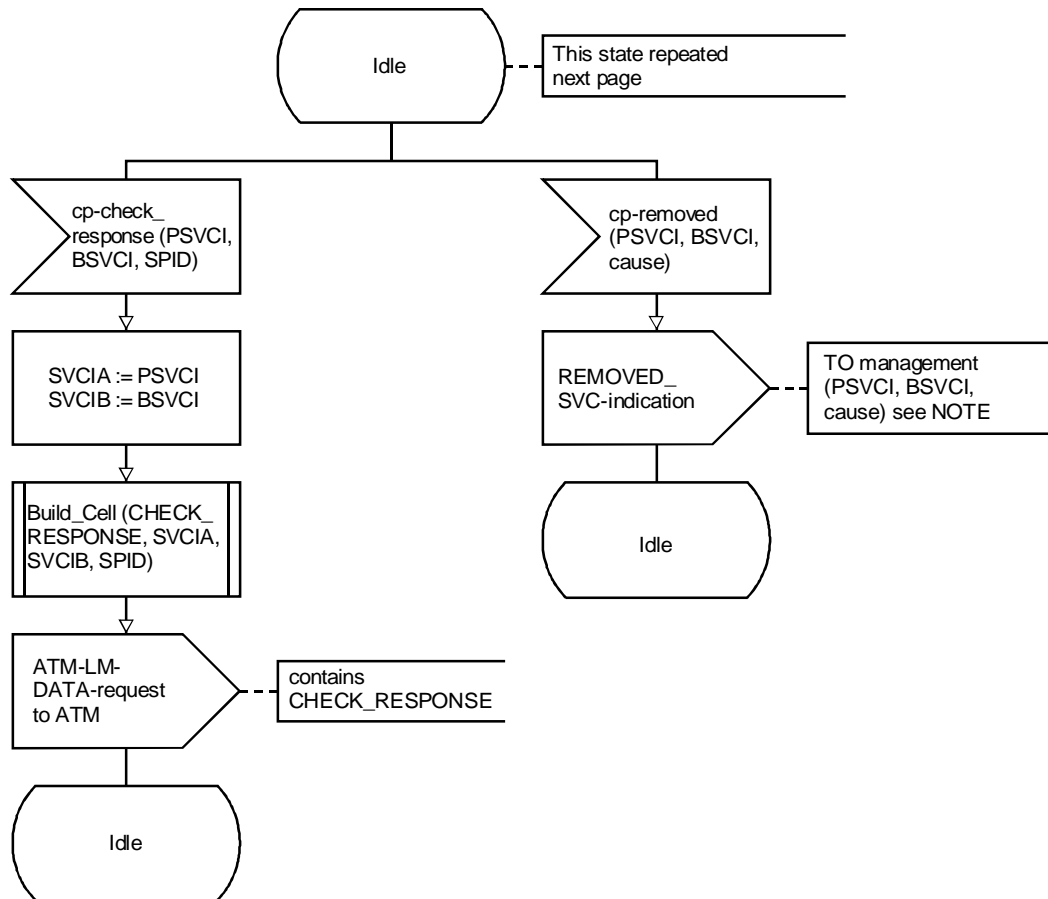

FIGURE B.7/Q.2120 (sheet 2 of 4)  
SDL for Meta-signalling control process (user side)

CHILD to PARENT  
PARENT to MANAGEMENT  
signals



\*\*\* NOTE \*\*\*

List of Causes

- PSVCI = My\_PSVCI
- CAU (received from network (Table 7))
- PSVCI in another ASSIGNED

FIGURE B.7/Q.2120 (sheet 3 of 4)  
SDL for Meta-signalling control process (user side)

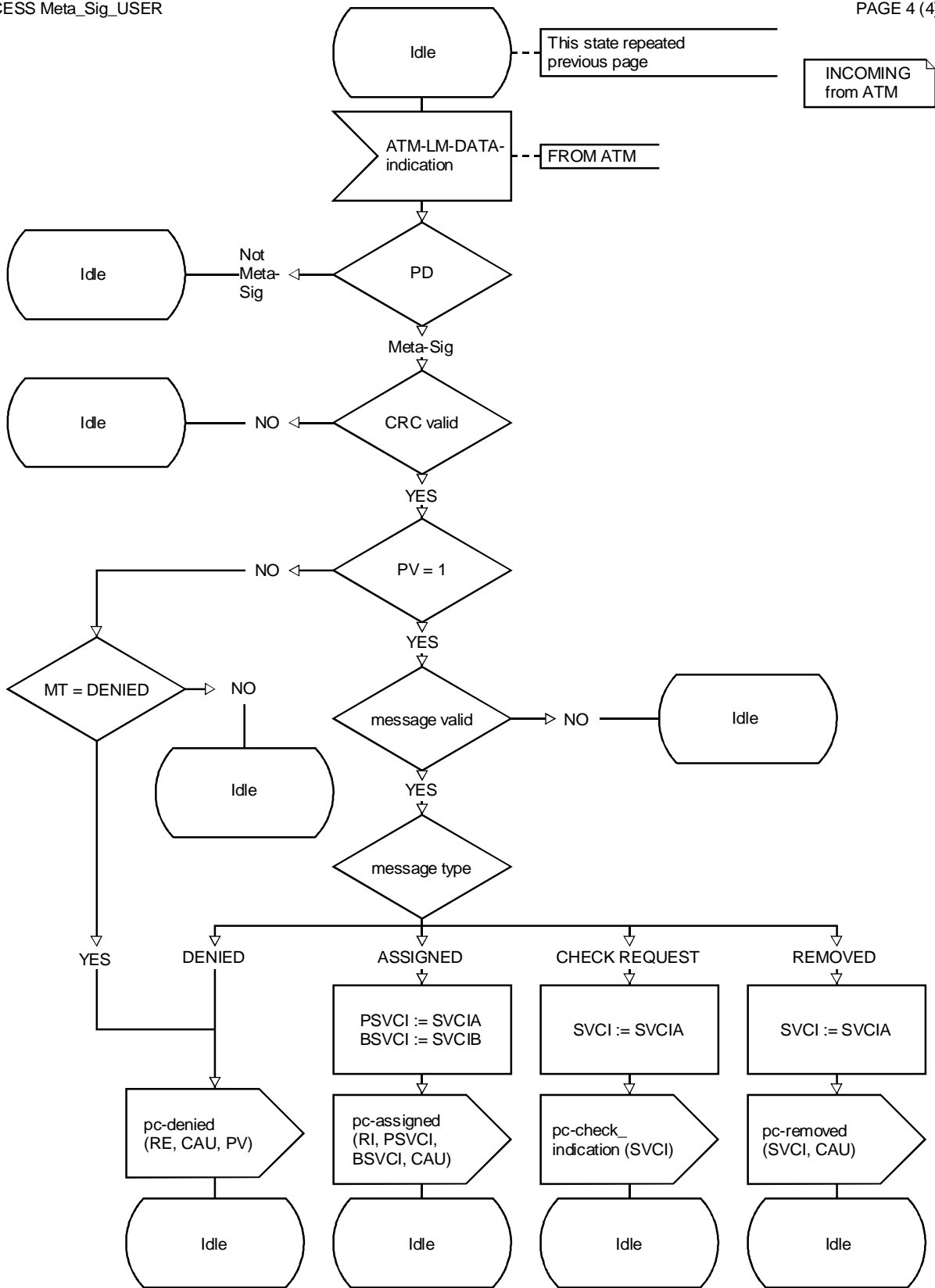

T1172610-95/d26

FIGURE B.7/Q.2120 (sheet 4 of 4)  
**SDL for Meta-signalling control process (user side)**



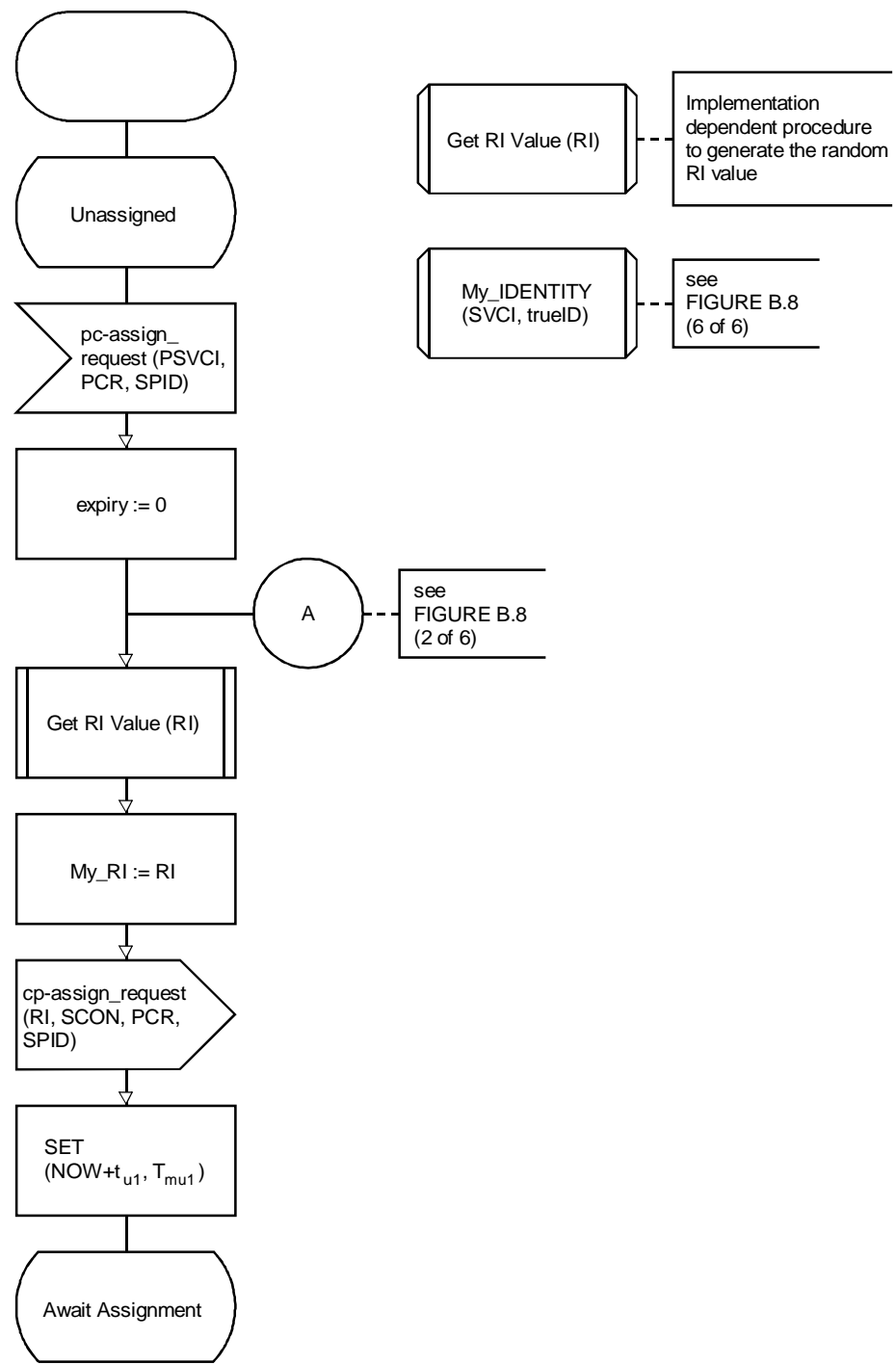

T1 172620-95/d27

FIGURE B.8/Q.2120 (sheet 1 of 6)  
 SDL for Meta-signalling procedure process for each signalling channel (user side)

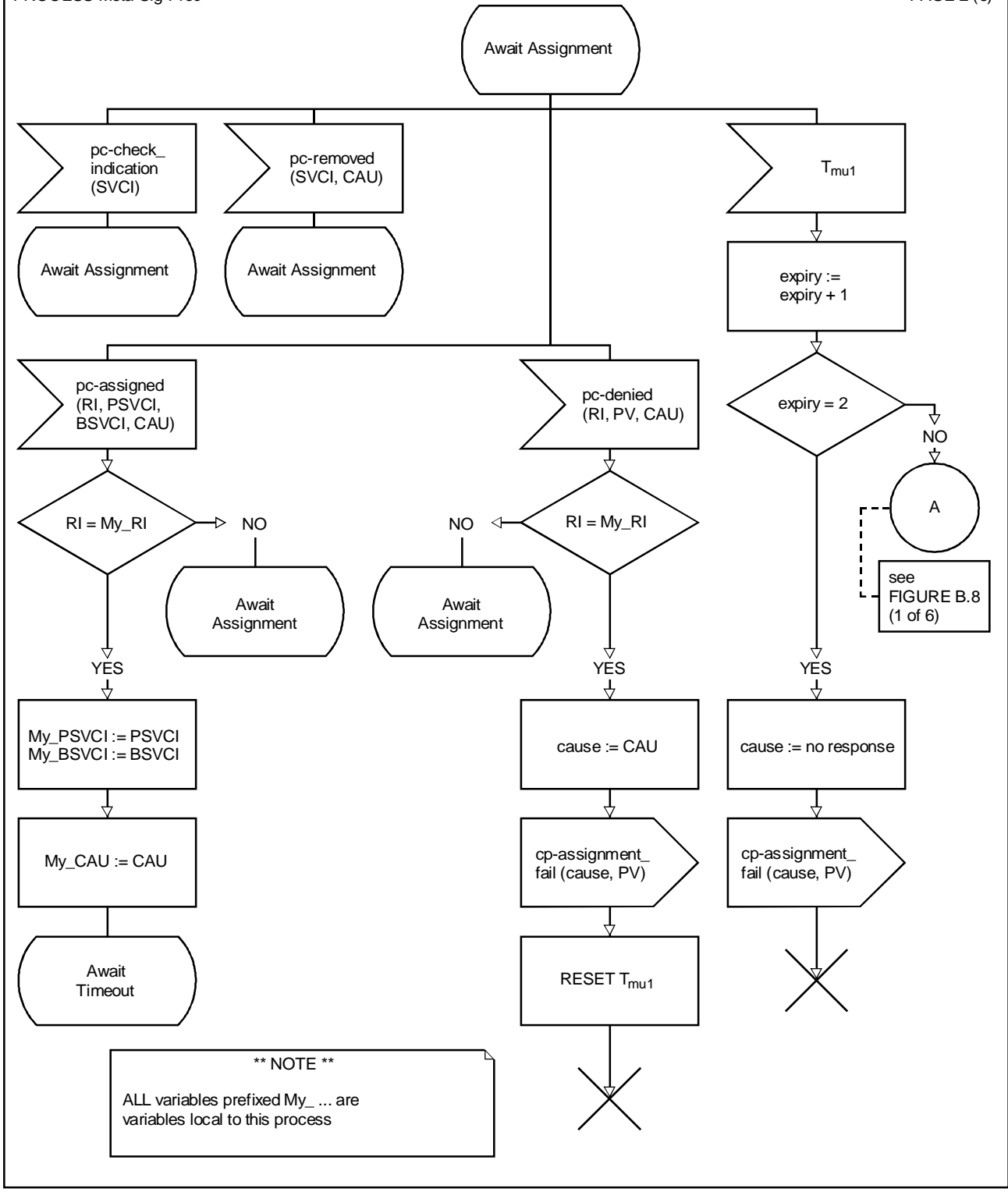

**\*\* NOTE \*\***  
 ALL variables prefixed My\_ ... are variables local to this process

FIGURE B.8/Q.2120 (sheet 2 of 6)

SDL for Meta-signalling procedure process for each signalling channel (user side)

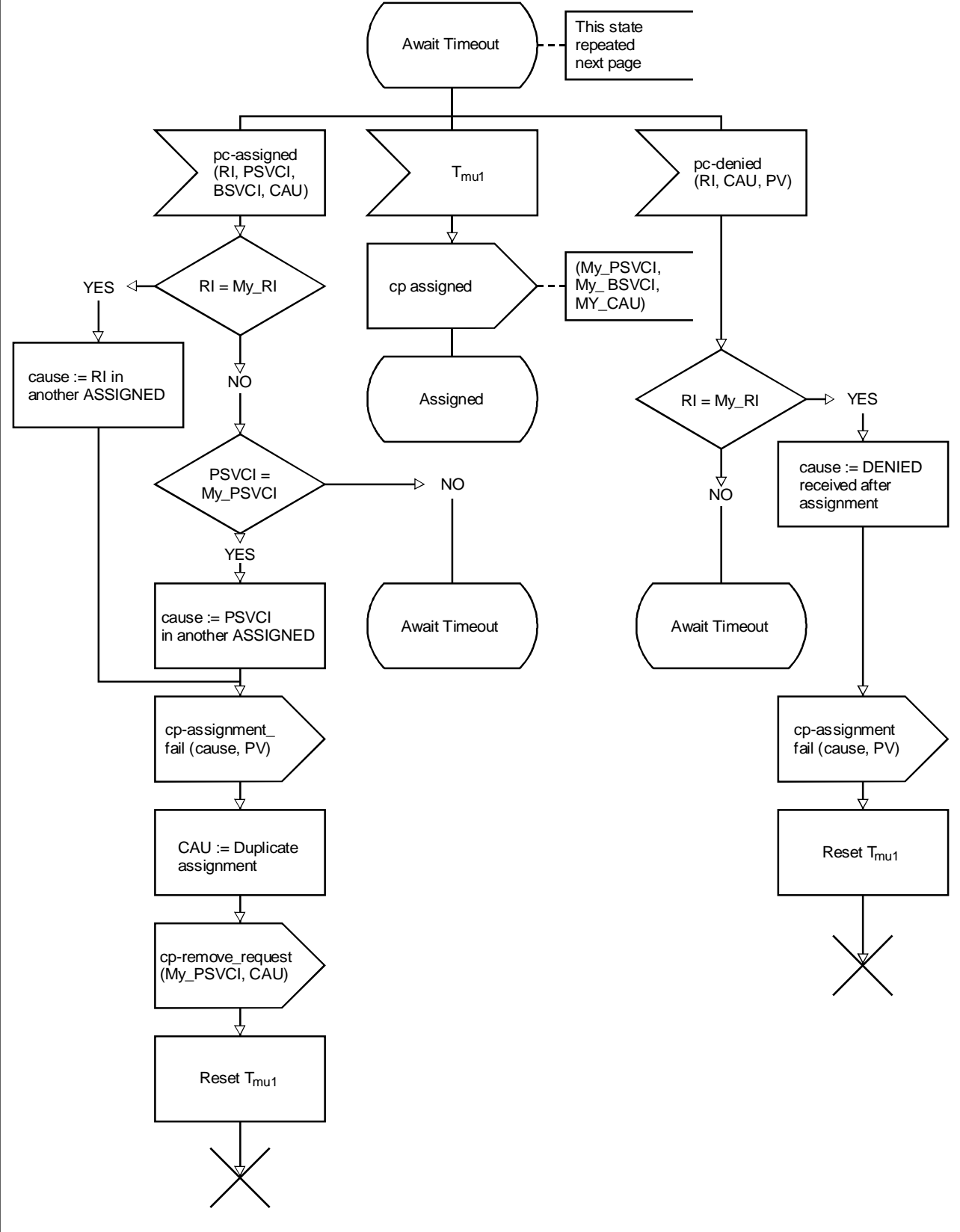
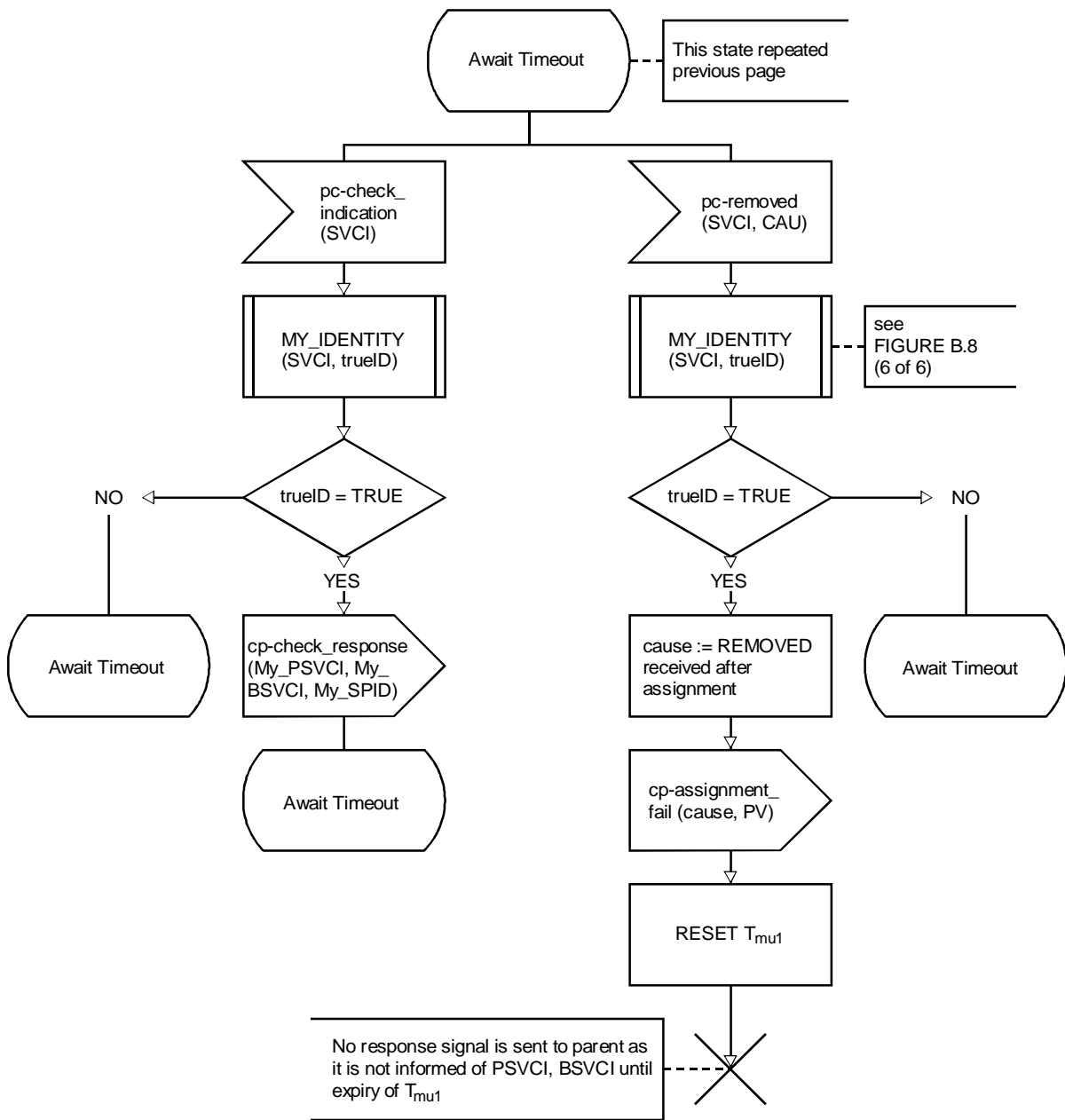

FIGURE B.8/Q.2120 (sheet 3 of 6)

T1172640-95/d29

SDL for Meta-signalling procedure process for each signalling channel (user side)



T1 172650-95/d30

FIGURE B.8/Q.2120 (sheet 4 of 6)

SDL for Meta-signalling procedure process for each signalling channel (user side)

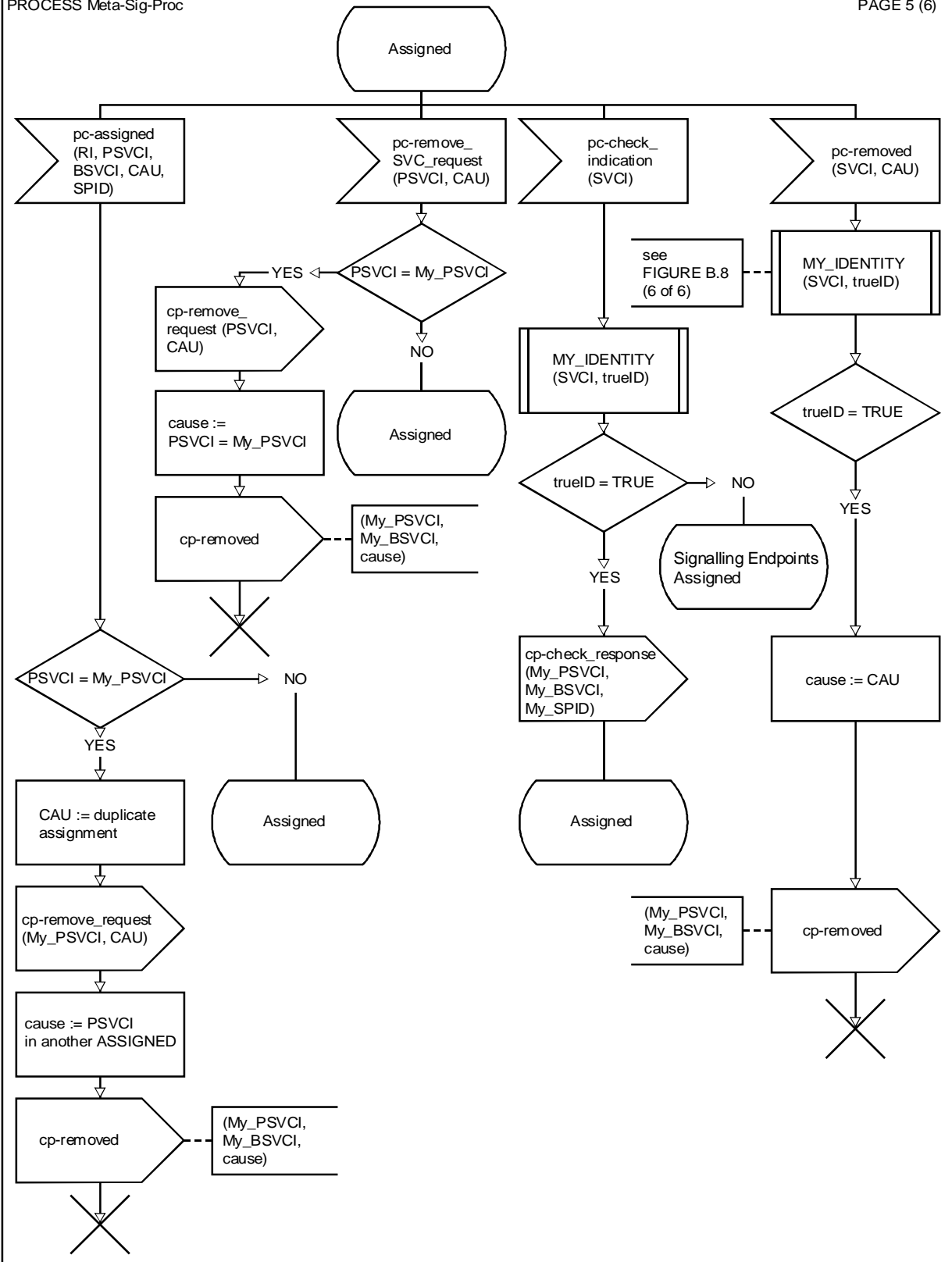

T1172660-95/d31

FIGURE B.8/Q.2120 (sheet 5 of 6)

SDL for Meta-signalling procedure process for each signalling channel (user side)

This PROCEDURE is entered with a value for SVCI. It then tests to see if this value matches the GSVCI (VCI = 1) or the values of PSVCI or BSVCI known by the child process calling it.

If the SVCI does match, the flag "trueID" is set. Otherwise it is cleared.

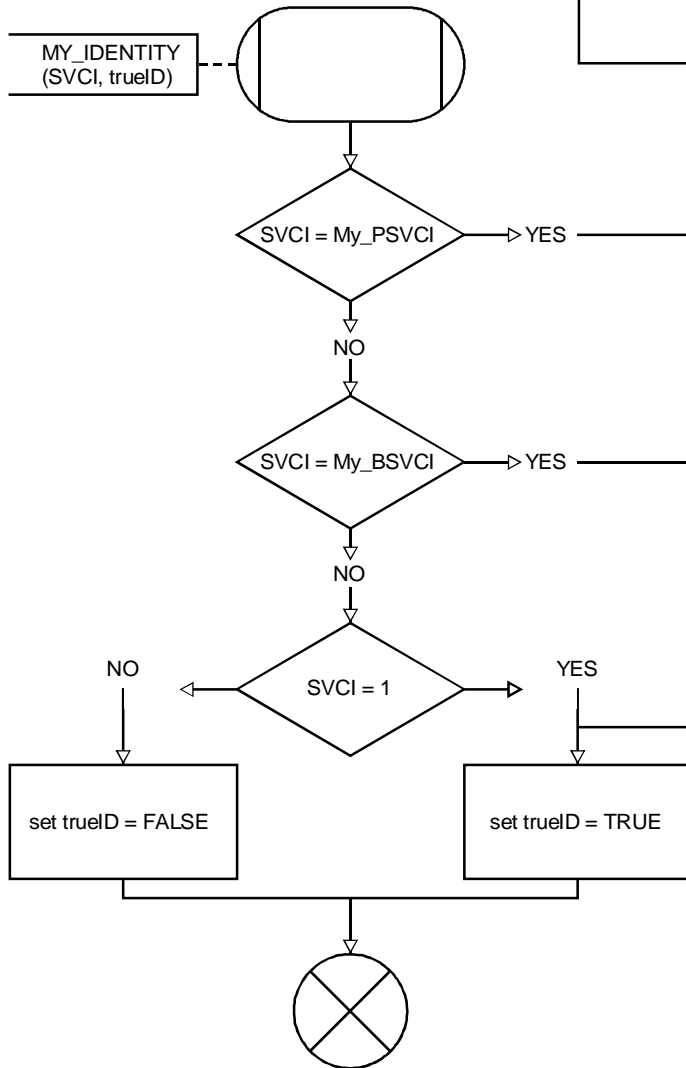

T1172670-95/d32

FIGURE B.8/Q.2120 (sheet 6 of 6)  
SDL for Meta-signalling procedure process for each signalling channel (user side)

## Annex C

### Dynamic signalling configuration control

(This annex forms an integral part of this Recommendation)

#### C.1 Introduction

This annex describes the optional dynamic signalling configuration control concept which allows a network to determine the point-to-point or point-to-multipoint signalling configuration dynamically without requiring a specific subscription arrangement.

The following subclauses present the impact on the assignment, check and removal procedures at the user and network sides.

#### C.2 Meta-signalling procedures

##### C.2.1 General

A variable called CONFIG in the network side Plane Management identifies the active signalling configuration on the UNI.

Figure C.1 is the State Overview diagram of the CONFIG variable. It has three possible states:

- N0 – No signalling configuration active.
- N1 – Point-to-point signalling configuration.
- N2 – Point-to-multipoint signalling configuration.

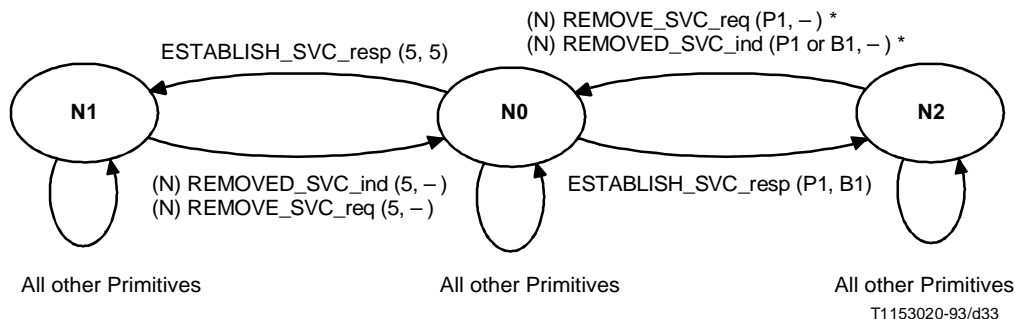

#### NOTES

- 1 P1 is PSVCI and is different from 5.
- 2 B1 is BSVCI.
- 3 CONFIG will enter the N0 state only after all signalling channels have been removed.

FIGURE C.1/Q.2120

Network side plane management CONFIG variable – State overview behaviour

#### C.2.2 Assignment procedure

##### C.2.2.1 User side

A user equipment requesting to operate in a point-to-point signalling arrangement shall set the SCON value in the ESTABLISH-SVC-request primitive to 2 and the SPID to 0. (VCI = 5 is reserved in Recommendation I.361 [2] for a point-to-point signalling configuration.)

A user equipment requesting to operate in a point-to-multipoint signalling configuration shall set the SCON value in the ESTABLISH-SVC-request primitive to 1.

### C.2.2.2 Network side

Upon receipt of an ESTABLISH-SVC-indication primitive, the network side Plane Management shall determine the appropriate response by examining the requested cell rate, SCON and SPID parameters and its current signalling configuration (see Table C.1).

TABLE C.1/Q.2120

State table for assign procedure

Event	CONFIG state		
	N0	N1	N2
ESTABLISH-SVC-indication with SCON = 2	ASSIGNED (5,-) N1 or DENIED (Cause 3) N0	DENIED (Cause 8) N1	DENIED (Cause 9) N2
ESTABLISH-SVC-indication with SCON = 1	ASSIGNED (P,B) N2 or DENIED (Cause 1 or 3) N0	DENIED (cause 8) N1	ASSIGNED (P,B) N2 or DENIED (Cause 1 or 3) N2
<p>NOTES</p> <p>1 P is the PSVCI value in the SVCIA parameter and is different from 5. B is the BSVCI value in the SVCIB parameter.</p> <p>2 The table shows the message options with the next-state indicated below the message.</p> <p>3 Cause 1 or 3 is sent to indicate resources not available. Cause 8 indicates "point-to-point configuration active". Cause 9 indicates "point-to-multipoint configuration active".</p>			

### C.2.3 Check procedure

The Check procedure defined in 10.5.1 is applicable to dynamic signalling configuration control as described in this annex. For example, the network may originate a check procedure by sending a CHECK REQUEST message with a VCI value of 5 when the point-to-point signalling configuration is active.

### C.2.4 Removal procedure

The Removal procedure which is described in 10.6 is applicable to the dynamic signalling configuration control. For example, after initiating a global removal, the network Plane Management shall be in the N0 state (i.e. no signalling configuration active).



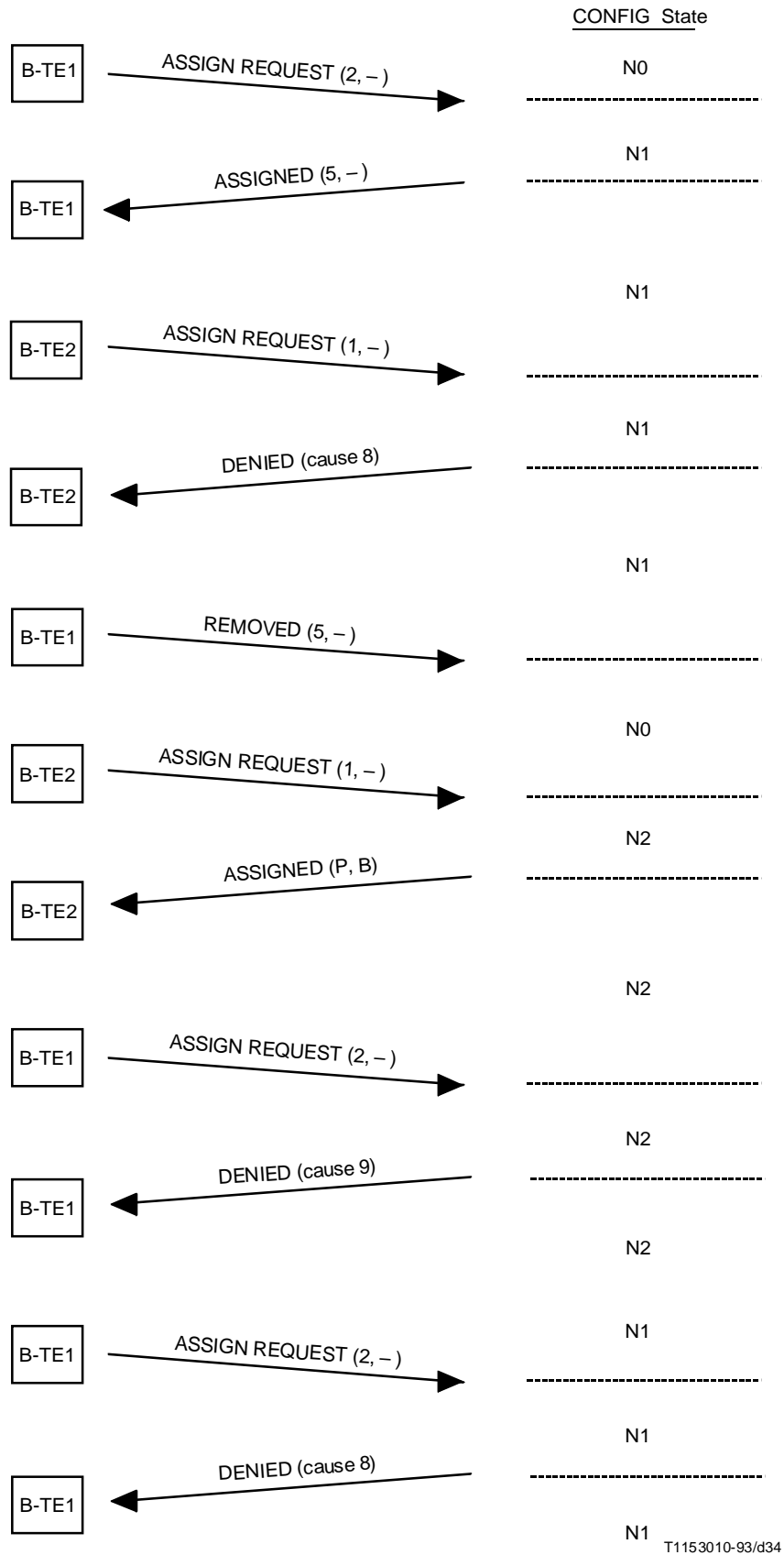
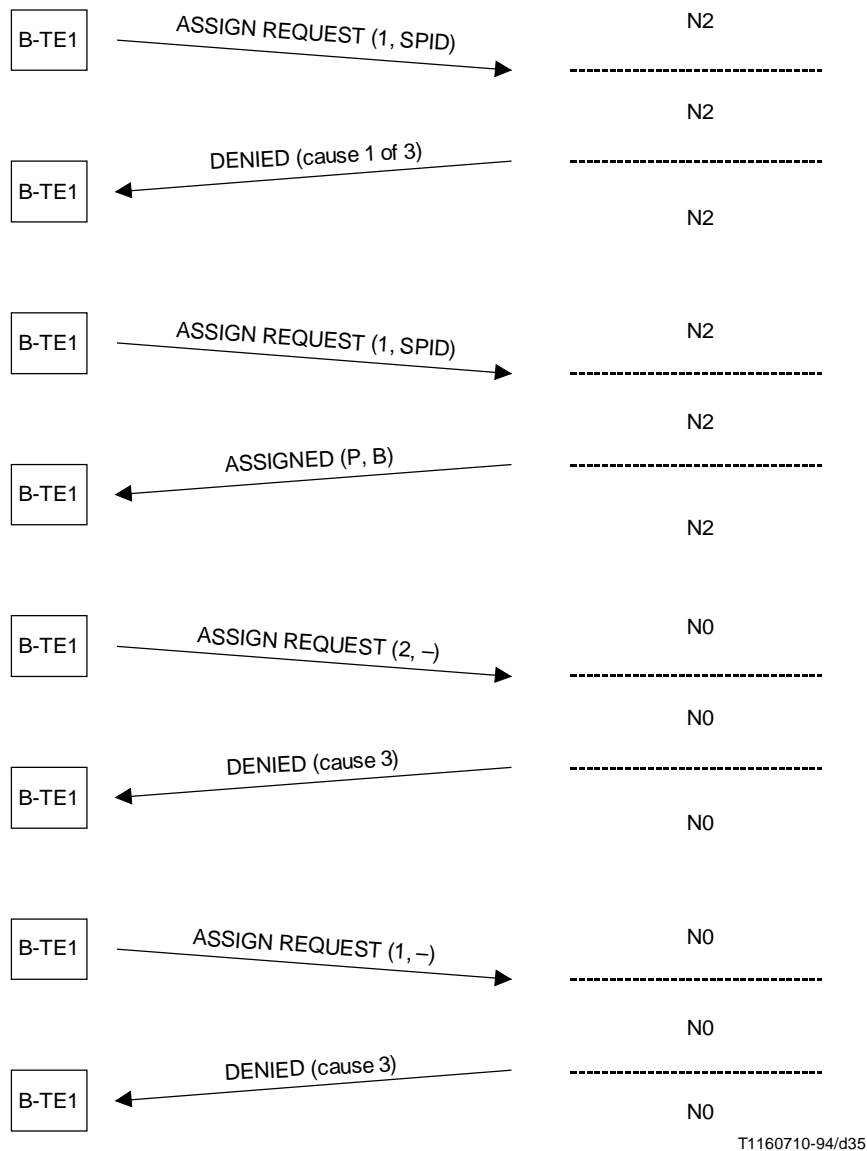

FIGURE C.2/Q.2120  
Interaction examples for different signalling configurations



NOTES

- 1 B-TE1 is a point-to-point terminal. B-TE2 is a point-to-multipoint terminal.
- 2 The ASSIGN REQUEST message has parameters of (SCON, SPID).  
For operation not using the SPID, the SPID parameter is coded Not Applicable.
- 3 The ASSIGNED message has parameters of (PSVCI, BSVCI).  
For operation not using the BSVCI, the BSVCI parameter is coded Not Applicable.
- 4 A "-" indicates Not Applicable.

FIGURE C.2/Q.2120 (end)  
Interaction examples for different signalling configurations

## Annex D

### Protocol Implementation Conformance Statement (PICS) pro forma to Recommendation Q.2120 (user y side)<sup>2)</sup>

(This annex forms an integral part of this Recommendation)

#### D.1 General

The supplier of a protocol implementation claiming to conform to this Recommendation shall complete the following Protocol Implementation Conformance Statement (PICS) pro forma and accompany it by the information necessary to identify fully both the supplier and the implementation. This PICS pro forma applies to the user-side interface.

The PICS is a document specifying the capabilities and options which have been implemented, and any features which have been omitted, so that the implementation can be tested for conformance against relevant requirements, and against those requirements only.

This PICS has several uses, the most important are the static conformance review and test case selection in order to identify which conformance tests are applicable to this product.

The PICS pro forma is a document, in the form of a questionnaire, normally designed by the protocol specifier or conformance test suite specifier which, when completed for an implementation or system, becomes the PICS.

#### D.2 Abbreviations and special symbols

For the purposes of this Recommendation, the following abbreviations and symbols are used:

CPE	Customer Premises Equipment (user y side)
IUT	Implementation Under Test
M	Mandatory
MS	Prefix for the Index number of the Message structure
N/A	Not Applicable
O	Optional
O.<n>	Optional, but, if chosen, support is required for either at least one or only one of the options in the group labelled by the same numeral <n>
P	Prohibited
PC	Prefix for the Index number of the Protocol Capabilities group
PICS	Protocol Implementation Conformance Statement
PIXIT	Protocol Implementation Extra Information for Testing
S.<i>	Supplementary Information number i
SP	Prefix for the Index number of the System Parameter group
X.<i>	Exceptional Information number i

#### D.3 Instructions for completing the PICS pro forma

The main part of the PICS pro forma is a fixed-format questionnaire, divided into three sections. Answers to the questionnaire are to be provided in the right most column, either by simply marking an answer to indicate a restricted choice (such as Yes or No), or by entering a value or a set or range of values.

A supplier may also provide additional information, categorized as either Exceptional Information or Supplementary Information (other than PIXIT). When present, each kind of additional information is to be provided as items labelled X.<i> or S.<i> respectively for cross-reference purposes, where <i> is any unambiguous identification for the item. An exception item should contain the appropriate rationale. The Supplementary Information is not mandatory and the PICS is complete without such information. The presence of optional supplementary or exceptional information should not affect test execution, and will in no way affect static conformance verification.

---

<sup>2)</sup> Copyright release for PICS pro forma – Users of this Recommendation may freely reproduce the PICS pro forma in this annex so that it may be used for its intended purpose and may further publish the completed PICS.

NOTE – Where an implementation is capable of being configured in more than one way, a single PICS may be able to describe all such configurations. However, the supplier has the choice of providing more than one PICS, each covering some subset of the implementation’s configuration capabilities, in case this makes for easier or clearer presentation of the information.

In the case in which an IUT does not implement a condition listed, such as in PC10, where a CPE may not support the checking procedures, the Support column of the PICS pro forma table should be completed as: "Yes:\_\_\_ No:\_\_\_ : X2". The entry of the exceptional information would read: "X2 This CPE does not support the checking procedures."

#### D.4 Global statement of conformance

Global statement – The implementation specified in this PICS meets all the mandatory requirements of the referenced standards:

Yes/No

NOTE – Answering “No” to this question indicates non-conformance to this Recommendation. Non-supported mandatory capabilities are to be listed in the PICS below, with an explanation for the abnormal status of the implementation.

The supplier will have fully complied with the requirements for a statement of conformance by completing the statement contained in this section. However, the supplier may find it helpful to continue to complete the detailed tabulations in the sections which follow.

#### D.5 Protocol Capabilities (PC)

Item #	Protocol feature	Status	References	Support
PC1	Does the CPE support the Meta-signalling VCI = 1?	M	1.2, 3.1, 5, 6.1	Yes:___No:___X:___
PC2	Does the CPE support Meta-signalling on VPI = 0?	M	3.1	Yes:___No:___X:___
PC3	Does the CPE support Meta-signalling on user-to-user VPs?	O	1.2, 3.1	Yes:___No:___X:___
PC4	Does the CPE side originate the assignment procedure?	M	10.1.1, 10.4	Yes:___No:___X:___
PC5.1	Does the CPE side originate the assignment procedure, if there is a need to use a signalling channel?	O.1	10.4a)	Yes:___No:___X:___
PC5.2	Does the CPE side originate the assignment procedure, if any cells within the VP that have VCI_0 are detected in the network-to-user direction?	O.1	10.4b)	Yes:___No:___X:___
PC6	Is the Reference Identifier (RI) randomly generated?	M	8.4, 9.3.4	Yes:___No:___X:___
PC7	Does the CPE delay the sending of every message by a random amount of time (i.e. $T_{mu2}$ )?	M	10.2, 11.1	Yes:___No:___ Value:___
PC8	If no response is received before the first expiry of $T_{mu1}$ does the CPE re-issue the ASSIGN REQUEST message?	M	10.4.1.2	Yes:___No:___X:___
PC9	Does the CPE use a new value of RI in the above instance (PC8)?	M	10.4.1.2	Yes:___No:___X:___

Item #	Protocol feature	Status	References	Support
PC10	Does the CPE respond to the checking procedure (i.e. CHECK REQUEST) with a CHECK RESPONSE message if the value in the SVCIA equals 1? The value in the SVCIA equals the CPE's value of the assigned point-to-point signalling virtual channel identifier? Or the value in the SVCIA equals the CPE's value of the assigned broadcast signalling virtual channel identifier?	M	10.1.1 10.5.2	Yes: __ No: __ X: __
PC11	Does the CPE continue to monitor ASSIGNED messages for a match to its PSVCI?	M	10.4.1.1	Yes: __ No: __ X: __
PC12	If PC11 is yes, then does it follow the removal procedures?	M	10.4.1.1	Yes: __ No: __ X: __
PC13	Can the CPE originate the removal procedure?	M	10.1.1, 10.6	Yes: __ No: __ X: __
PC14.1	Does the CPE support the point-to-multipoint with broadcast signalling configuration?	O.2	9.3.5	Yes: __ No: __ X: __
PC14.2	Does the CPE support the point-to-point signalling configuration?	O.2	9.3.5	Yes: __ No: __ X: __
PC15	Does the CPE support the point-to-point SVC cell rate of 42 cells/s?	M	9.3.8	Yes: __ No: __ X: __
PC16	Does the CPE support point-to-point SVC cell rates other than 42 cells/s?	O	9.3.8	Yes: __ No: __ Value(s) __
PC17	Is a non-Not Applicable SPID value supported?	O	9 Table 1 (Note 2), 9.3.10	Yes: __ No: __ X: __
PC18	Does the IUT ignore all parameters coded with Not Applicable values?	M	9.1	Yes: __ No: __ X: __
O.1 Support of at least one of these items is required.				
O.2 Support of at least one of these items is required.				

## D.6 Messages – Protocol data units (MS)

Item #	Protocol feature	Status	References	Support
MS1	Is the order of byte transmission in ascending numerical order and the order of bit transmission in descending numerical order?	M	9.2	Yes: __ No: __ X: __
MS2	Does the lowest bit number of a field, contained in a single octet, represent the lowest order value?	M	9.2	Yes: __ No: __ X: __

Item #	Protocol feature	Status	References	Support
MS3	For a field which spans more than one octet, does the order of values within each octet progressively decrease as the octet number increases?	M	9.2	Yes: __ No: __ X: __
MS4	Does the lowest bit number associated with the field represent the lowest order value?	M	9.2	Yes: __ No: __ X: __
MS5	Message is exactly 48 octets long.	M	5	Yes: __ No: __ X: __
	Do all transmitted messages contain the following fields?			
MS6.1	Protocol Discriminator	M	9.1	Yes: __ No: __ X: __
MS6.2	Protocol Version	M	9.1	Yes: __ No: __ X: __
MS6.3	Message Type	M	9.1	Yes: __ No: __ X: __
MS6.4	Reference Identifier	M	9.1	Yes: __ No: __ X: __
MS6.5	SCON	M	9.1	Yes: __ No: __ X: __
MS6.6	Signalling Virtual Channel Identifier A	M	9.1	Yes: __ No: __ X: __
MS6.7	Signalling Virtual Channel Identifier B	M	9.1	Yes: __ No: __ X: __
MS6.8	PSVC Cell Rate	M	9.1	Yes: __ No: __ X: __
MS6.9	Cause	M	9.1	Yes: __ No: __ X: __
MS6.10	Service Profile Identifier	M	9.1	Yes: __ No: __ X: __
MS6.11	Null fill	M	9.1	Yes: __ No: __ X: __
MS6.12	CRC	M	9.1	Yes: __ No: __ X: __
MS7	Is the Protocol Discriminator coded 0000 0001?	M	9.3.1	Yes: __ No: __ X: __
MS8	Is the Protocol version coded 0000 0001?	M	9.3.2	Yes: __ No: __ X: __
MS9	Is the Null fill coded as all 0's?	M	9.3.10	Yes: __ No: __ X: __

## D.7 System Parameters (SP)

Item #	Protocol feature	Status	References	Support
SP1	Maximum number of transmissions of ASSIGN REQUEST	M	10.4.1.2	Yes: __ No: __ Value: __
SP2	Minimum time between the transmission of the ASSIGN REQUEST (i.e. $T_{mu1}$ )	M	10.4.1.2, 11.1	Yes: __ No: __ Value: __