



INTERNATIONAL TELECOMMUNICATION UNION

**ITU-T**

TELECOMMUNICATION  
STANDARDIZATION SECTOR  
OF ITU

**Q.251-Q.300**

(11/1988)

SERIES Q: SWITCHING AND SIGNALLING

---

**Specifications of Signalling System No. 6**

ITU-T Recommendations Q.251-Q.300

(Formerly CCITT Recommendations)

---

ITU-T Q-SERIES RECOMMENDATIONS  
SWITCHING AND SIGNALLING

SIGNALLING IN THE INTERNATIONAL MANUAL SERVICE	Q.1–Q.3
INTERNATIONAL AUTOMATIC AND SEMI-AUTOMATIC WORKING	Q.4–Q.59
Basic Recommendations	Q.4–Q.9
Numbering plan and dialling procedures in the international service	Q.10–Q.11
Routing plan for international service	Q.12–Q.19
General Recommendations relative to signalling and switching systems (national or international)	Q.20–Q.34
Tones for use in national signalling systems	Q.35–Q.39
General characteristics for international telephone connections and circuits	Q.40–Q.47
Signalling for satellite systems	Q.48–Q.49
Signalling for circuit multiplication equipment	Q.50–Q.59
FUNCTIONS AND INFORMATION FLOWS FOR SERVICES IN THE ISDN	Q.60–Q.99
Methodology	Q.60–Q.67
Basic services	Q.68–Q.79
Supplementary services	Q.80–Q.99
CLAUSES APPLICABLE TO ITU-T STANDARD SYSTEMS	Q.100–Q.119
General clauses	Q.100–Q.109
Transmission clauses for signalling	Q.110–Q.114
Control of echo suppressors	Q.115
Abnormal conditions	Q.116–Q.119
SPECIFICATIONS OF SIGNALLING SYSTEMS No. 4 AND No. 5	Q.120–Q.249
Specifications of Signalling System No. 4	Q.120–Q.139
Specifications of Signalling System No. 5	Q.140–Q.179
<b>SPECIFICATIONS OF SIGNALLING SYSTEM No. 6</b>	<b>Q.250–Q.309</b>
SPECIFICATIONS OF SIGNALLING SYSTEM R1	Q.310–Q.399
SPECIFICATIONS OF SIGNALLING SYSTEM R2	Q.400–Q.499
DIGITAL EXCHANGES	Q.500–Q.599
INTERWORKING OF SIGNALLING SYSTEMS	Q.600–Q.699
SPECIFICATIONS OF SIGNALLING SYSTEM No. 7	Q.700–Q.799
Q3 INTERFACE	Q.800–Q.849
DIGITAL SUBSCRIBER SIGNALLING SYSTEM No. 1	Q.850–Q.999
PUBLIC LAND MOBILE NETWORK	Q.1000–Q.1099
INTERWORKING WITH SATELLITE MOBILE SYSTEMS	Q.1100–Q.1199
INTELLIGENT NETWORK	Q.1200–Q.1699
SIGNALLING REQUIREMENTS AND PROTOCOLS FOR IMT-2000	Q.1700–Q.1799
SPECIFICATIONS OF SIGNALLING RELATED TO BEARER INDEPENDENT CALL CONTROL (BICC)	Q.1900–Q.1999
BROADBAND ISDN	Q.2000–Q.2999

*For further details, please refer to the list of ITU-T Recommendations.*

**Specifications of Signalling System No 6**

**Summary**

Signalling System No. 6 could be used to control the switching of all types of international circuits, including TASI-derived circuits and satellite circuits. It is designed for both-way operation of the speech circuits. The system can also be used for regional and national applications, and a large part of the signal code capacity is reserved for this purpose.

The system features are obtained by entirely removing the signalling from the speech paths and introducing the concept of a separate common signalling link over which all signals for a number of speech circuits are transferred. A number of these common signalling links interconnected by a number of transit centres and signal transfer points will form a coherent signalling network which can transfer all signals for all speech circuit groups within that network area.

The separate common signalling link is capable of operation over both analogue and digital circuits. Signalling information is transmitted in the serial data mode on a link-by-link basis – i.e. the signals are transferred from one link to the next only after processing.

**Source**

ITU-T Recommendations Q.251-Q.300 were prepared by CCITT Study Group XI (1985-1988) and approved by WTSC in Melbourne on 25 November 1988. Those texts were originally published in Blue Book, Fascicle VI.3.

## FOREWORD

The International Telecommunication Union (ITU) is the United Nations specialized agency in the field of telecommunications. The ITU Telecommunication Standardization Sector (ITU-T) is a permanent organ of ITU. ITU-T is responsible for studying technical, operating and tariff questions and issuing Recommendations on them with a view to standardizing telecommunications on a worldwide basis.

The World Telecommunication Standardization Conference (WTSC), which meets every four years, establishes the topics for study by the ITU-T study groups which, in turn, produce Recommendations on these topics.

The approval of ITU-T Recommendations is covered by the procedure laid down in WTSC Resolution 1.

In some areas of information technology which fall within ITU-T's purview, the necessary standards are prepared on a collaborative basis with ISO and IEC.

## NOTE

In this Recommendation, the expression "Administration" is used for conciseness to indicate both a telecommunication administration and a recognized operating agency.

## INTELLECTUAL PROPERTY RIGHTS

ITU draws attention to the possibility that the practice or implementation of this Recommendations may involve the use of a claimed Intellectual Property Right. ITU takes no position concerning the evidence, validity or applicability of claimed Intellectual Property Rights, whether asserted by ITU members or others outside of the Recommendation development process.

As of the date of approval of this Recommendations, ITU had not received notice of intellectual property, protected by patents, which may be required to implement this Recommendations. However, implementors are cautioned that this may not represent the latest information and are therefore strongly urged to consult the TSB patent database.

© ITU 2002

All rights reserved. No part of this publication may be reproduced, by any means whatsoever, without the prior written permission of ITU.

## CONTENTS

### Part I – Specifications of Signalling System No. 6

Rec. No.		Page
	INTRODUCTION.....	1
	SECTION 1 – <i>Functional description of the signalling system</i>	
Q.251	1.1 General.....	3
Q.252	1.2 Signal transfer time definitions.....	6
Q.253	1.3 Association between signalling and speech networks.....	7
	SECTION 2 – <i>Definition and function of signals</i>	
Q.254	2.1 Telephone signals.....	10
Q.255	2.2 Signalling-system-control signals.....	14
Q.256	2.3 Management signals.....	15
	SECTION 3 – <i>Signal unit formats and codes</i>	
Q.257	3.1 General.....	16
Q.258	3.2 Telephone signals.....	20
Q.259	3.3 Signalling-system-control signals.....	28
Q.260	3.4 Management signals.....	31
	SECTION 4 – <i>Signalling procedures</i>	
Q.261	4.1 Normal call set-up.....	36
Q.262	4.2 Analysis of digital information for routing.....	42
Q.263	4.3 Double seizing with both-way operation.....	42
Q.264	4.4 Potential for automatic repeat attempt and re-routing.....	43
Q.265	4.5 Speed of switching and signal transfer in international exchanges.....	44
Q.266	4.6 Blocking and unblocking sequences and control of quasi-associated signalling.....	44
Q.267	4.7 Unreasonable and superfluous messages.....	46
Q.268	4.8 Release of international connections and associated equipment.....	49
	SECTION 5 – <i>Continuity check of the speech path</i>	
Q.271	5.1 General.....	54
	5.2 Reliability of the speech path across the exchange.....	54
	5.3 Continuity check of the speech circuit between exchanges.....	54
	5.4 Loop checking method.....	54
	5.5 Transmission requirements for the continuity check.....	54
	5.6 Continuity signal.....	55
	5.7 Timing considerations for the continuity check.....	55

Rec. No.		Page
<b>SECTION 6 – <i>Signalling link</i></b>		
Q.272	6.1 Requirements for the signalling data link .....	57
Q.273	6.2 Data transmission rate.....	62
Q.274	6.3 Transmission methods .....	63
	6.4 Modem and interface requirements.....	64
Q.275	6.5 Data channel failure detection .....	71
Q.276	6.6 Service dependability.....	71
Q.277	6.7 Error control.....	72
Q.278	6.8 Synchronization .....	75
Q.279	6.9 Drift compensation .....	78
<b>SECTION 7 – <i>Signal traffic characteristics</i></b>		
Q.285	7.1 Signal priority categories .....	79
Q.286	7.2 Signalling channel loading and queueing delays .....	80
Q.287	7.3 Signal transfer time requirements .....	84
<b>SECTION 8 – <i>Security arrangements</i></b>		
Q.291	8.1 General.....	87
	8.2 Basic security arrangements .....	87
	8.3 Types of failure, recognition of failure and abnormal error rates .....	88
Q.292	8.4 Reserve facilities provided.....	90
Q.293	8.5 Intervals at which security measures are to be invoked.....	92
	8.6 Changeover and changeback procedures .....	93
	8.7 Emergency restart procedure .....	96
	8.8 Full-time synchronized reserve links .....	98
	8.9 Load sharing method .....	99
<b>SECTION 9 – <i>Testing and maintenance</i></b>		
Q.295	9.1 Overall tests of Signalling System No. 6 .....	100
	9.2 Signalling data link .....	101
	9.3 (Reserved).....	102
	9.4 (Reserved).....	102
	9.5 Network maintenance .....	102
Q.296	9.6 Monitoring and maintenance of the common signalling channel .....	105

SECTION 10 – *Network management*

Q.297	10. Network management .....	112
	10.1 General.....	112
	10.2 Information categories .....	112
	Annex – The application of network management signals transported by System No. 6 .....	113
	Annex A to Signalling System No. 6 specifications.....	115
	Annex B to Signalling System No. 6 specifications .....	121

**Part II – Interworking between CCITT Signalling System No. 6  
and national common channel signalling systems**

Q.300	Interworking between CCITT Signalling System No. 6 and national common channel signalling systems .....	127
	Glossary of terms specific to Signalling System CCITT No. 6 .....	132
	Abbreviations specific to Signalling System No. 6 .....	136





## PART I – SPECIFICATIONS OF SIGNALLING SYSTEM No. 6

### *Preamble*

This specification of Signalling System No. 6 represents an evolution originating with the *Green Book* text and proceeding through the *Yellow Book* revision to the present text. It is intended that new or modernized application of System No. 6 should be based on this text. Updating of earlier versions is encouraged with the caution that careful coordination is called for.

## INTRODUCTION

### *General*

Signalling System No. 6 can be used to control the switching of all types of international circuits to be used in a worldwide connection, including TASI-derived circuits and satellite circuits.

The system meets all requirements defined by the CCITT concerning the service features for world-wide international semi-automatic and automatic telephone traffic. It is designed for both-way operation of the speech circuits.

The system can also be used for regional and national applications, and a large part of the signal code capacity is reserved for this purpose.

Moreover, a large unused signal code capacity will allow the addition of new signals to cater for some unknown future requirements. This spare capacity may be used for increasing the number of telephone signals as well as for introducing other signals, e.g. network-management signals and network-maintenance signals.

The system features are obtained by entirely removing the signalling from the speech paths and introducing the concept of a separate common signalling link over which all signals for a number of speech circuits are transferred. A number of these common signalling links interconnected by a number of transit centres and signal transfer points will form a coherent signalling network which can transfer all signals for all speech circuit groups within that network area.

### *Modes of operation*

The signalling system may be operated both in an associated *mode* and in a non-associated mode. In the associated mode of operation, the signals are transferred between the two exchanges which are the end points of a group of speech circuits over a common signalling link terminating at the same exchanges. In the non-associated mode of operation, the signals are transferred via two or more common signalling links in tandem associated with other groups of circuits, the signals being processed and forwarded through one or more intermediate exchanges acting only as signal transfer point.

The associated mode of operation is suited for use with large circuit groups, while a non-associated mode makes the signalling system economically suitable for use with small circuit groups by sharing the capacity of a signalling link among several groups.

A signalling link may be operated in the associated mode for one circuit group and in a non-associated mode for other circuit groups, either under normal or under breakdown conditions.

### *Common signalling link*

The separate common signalling link is capable of operation over both analogue and digital circuits. Signalling information is transmitted in the serial data mode on a link-by-link basis – i.e. the signals are transferred from one link to the next only after processing.

Analogue signalling links are capable of operations over standard international voice bandwidth channels including the 3-kHz spaced telephone channels used for some intercontinental circuits. Over voice-frequency channels the stream of pulses is normally transmitted at a rate of 2400 bit/s using the four-phase modulation method.

With respect to digital signalling links, the 1544 kbit/s and 2048 kbit/s internationally standardized PCM primary multiplexes (Recommendation Q.47 and Recommendation Q.46) are treated differently. In the case of 1544 kbit/s a channel is derived over which the stream of pulses is transmitted at 4 kbit/s. Signalling information is also transmitted at 4 kbit/s. In the case of 2048 kbit/s, a channel is derived over which the stream of pulses is transmitted at 64 kbit/s. Signalling information may be sent over such a channel at specified rates of either 4 kbit/s or 56 kbit/s. Other bit rates may have application in the future and other provisions for channel derivation may also prove useful, but neither are included in the present specification.

In both analogue and digital channels the pulse stream is divided into signal units of 28 bits each and into blocks of 12 signal units each.

The error control necessary for a common signalling link is based on error detection by coding and on error correction by retransmission. Error detection is based on decoding of checking bits included in each signal unit and on data carrier failure detection. This provides the desired system reliability. Error-free signal messages are used without delay. Provision is made for automatic transfer to an alternative link in the event of failure caused by breakdown or excessive error rate.

### *Signal messages*

Signal messages carry information to identify the telephone circuit concerned. Since the circuit identity, i.e. the *label*, requires a large proportion of the bits (11 out of the 20 available information bits), provision is made for sending *multi-unit messages* consisting of several signal units under one label. A single digit or a random telephone signal will normally be transferred in a one-unit message while several or even all digits may be transferred in a multi-unit message.

### *Signal processing*

All signals are processed at each transit centre or signal transfer point which has to be passed.

The processing of messages at a signal transfer point is minimal and includes label translation, if necessary, and the sending of signal messages within the proper priority category. In addition to the processing required at a signal point, a transit centre examines sufficient signal information to perform proper switching action.

### *Signalling equipment*

Because of the new technique based on a separate common signalling link, on data type transmission and on central processing of the signalling information, Signalling System No. 6 will be used in general between exchanges of the stored programme control type.

## SECTION 1

### FUNCTIONAL DESCRIPTION OF THE SIGNALLING SYSTEM

#### Recommendation Q.251

#### 1.1 GENERAL

##### 1.1.1 Block diagrams

Because common channel signalling, used in conjunction with exchanges having stored programme control, allows a wide latitude in the distribution of signalling functions between the processor and peripheral equipment, and because common channel signalling is not limited to exchanges of this type, it is not practicable to specify well-defined equipment interfaces.

The major signal transfer functions are shown in Figures 1/Q.251, 2/Q.251 and Table 1/Q.251 for both the analogue version and the digital version. The blocks are functional blocks and should not be construed as depicting equipment arrangements.

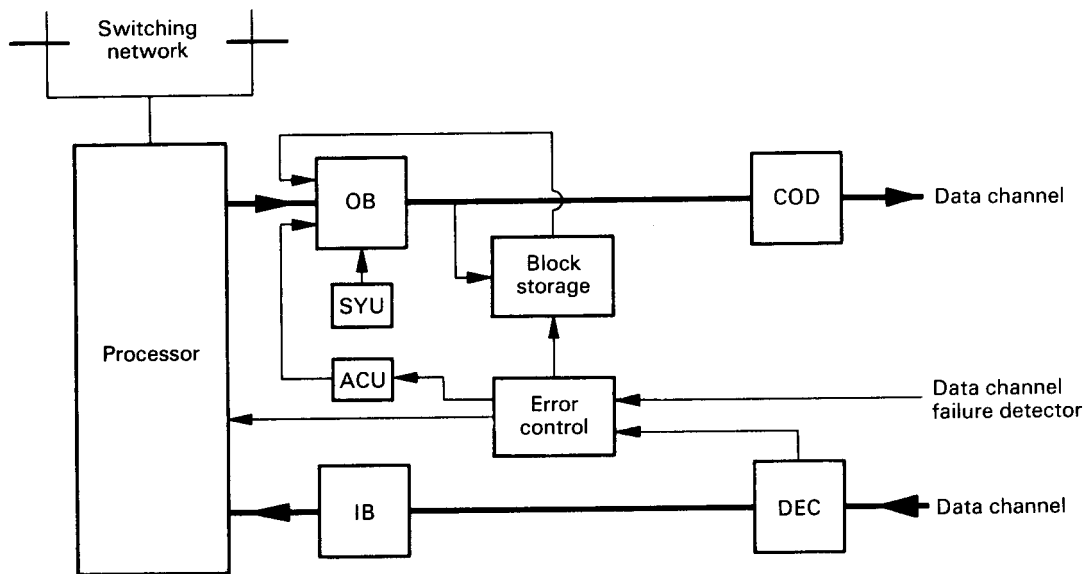

CCITT-48840

OB    output buffer	ACU    acknowledgement signal unit generator
IB    input buffer	COD    coder
SYU    synchronization signal unit generator	DEC    decoder

FIGURE 1/Q.251

**Functional block diagram of a System No. 6 terminal**

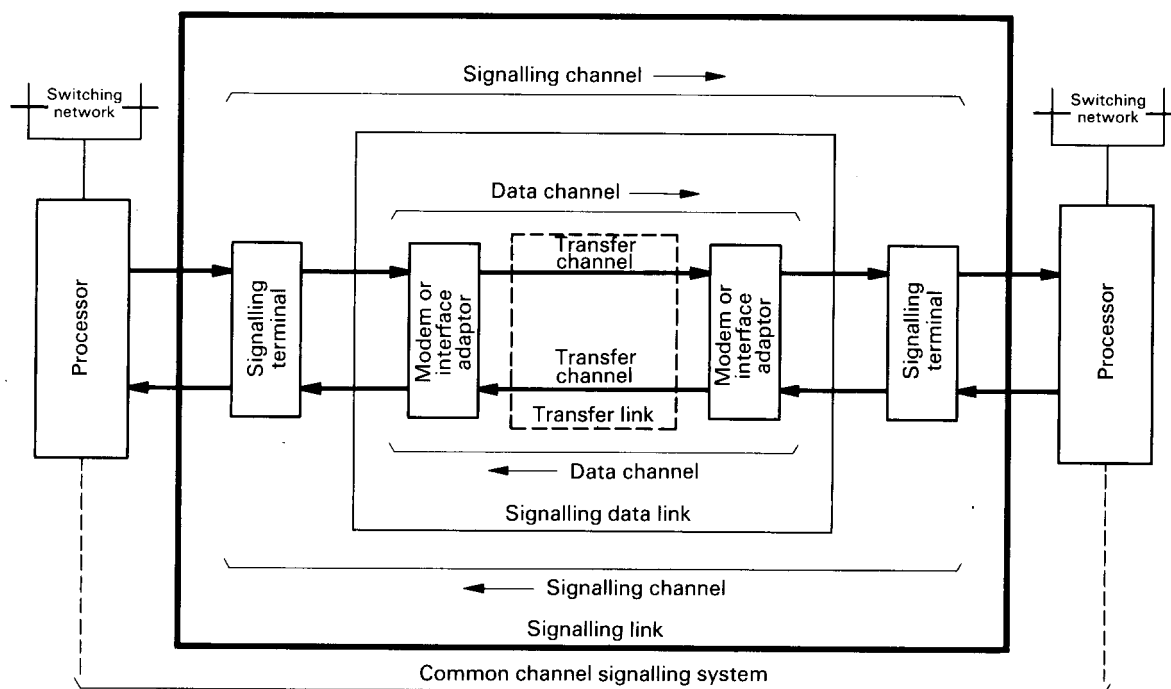

CCITT-48852

FIGURE 2/Q.251

Basic diagram of the common channel signalling system

TABLE 1 /Q.251

	Analogue version	Digital version
Data transceiver	Modem	Interface adaptor
Transfer channel	(Voice-frequency channel) a one-way voice-frequency transmission path from the output of a data modulator to the input of a data demodulator, made up of one or more voice-frequency channels in tandem.	(Digital channel) a one-way digital transmission path, from the output of the interface adaptor to the input of the interface adaptor, made up of one or more digital channels in tandem.
Transfer link	(Voice-frequency link) a two-way voice-frequency transmission path between two data modems, made up of one voice frequency channel in each direction.	(Digital link) a two-way digital transmission path between two interface adaptors, made up of one digital channel in each direction.
Data channel	a one-way data transmission path between two points, made up of a modulator, a voice-frequency channel and a demodulator.	a one-way data transmission path between two points, made up of a digital channel terminating on an interface adaptor at each end.
Signalling data link	a two-way data transmission path between two points, made up of one data channel in each direction.	
Signalling channel	a one-way signalling path from the processor of one switching machine to the processor of another switching machine.	
Signalling link	a two-way direction signalling path from processor to processor made up of one signalling channel in each direction.	

### 1.1.2 *Signal unit and block structure*

Each signalling channel of the system (shown in Figure 2/Q.251) is operated synchronously: that is, a continuous stream of data flows in both directions. The data stream is divided into signal units of 28 bits each, of which the last 8 are check bits, and these signal units in turn are grouped into *blocks* of 12 signal units. The 12th and last signal unit of each block is an acknowledgement signal unit coded to indicate the number of the block being transmitted, the number of the block being acknowledged and whether or not each of the 11 signal units of the block being acknowledged was received without detected errors.

Eight consecutive blocks form a *multi-block*. Since the system allows for up to 32 multi-blocks, the maximum number of blocks in the error control loop is 256.

In normal operation, the first 11 signal units within a block will consist of signal units carrying either telephone signals or management signals, or of synchronization signal units. Synchronization signal units, which are transmitted only in the absence of other signalling traffic, are coded to indicate the number of the position they occupy within the block to facilitate locating the acknowledgement signal unit. Their format has been chosen to produce a large number of dibit transitions to facilitate achieving or maintaining bit synchronism in the analogue version.

During system-synchronizing procedures, only synchronization and acknowledgement signal units are transmitted until bit, signal unit, and block synchronism has been achieved at both ends of the signalling system.

### 1.1.3 *Transmitting terminal*

The transmission of a signal in System No. 6 starts in the processor as shown in Figure 1/Q.251. Signals corresponding to the information to be transmitted are formed in accordance with the format specified and delivered to the output buffer. These signals, which may be one-unit messages or multi-unit messages, are stored in this buffer according to their priority level. The output buffer delivers the highest priority signal awaiting transmission to the coder in serial form in the next available time slot. In the coder, each signal unit is encoded by the addition of check bits in accordance with the check bit polynomial.

In the analogue version of the signalling system the signal is then modulated and delivered to the outgoing voice frequency channel for transmission to the distant receiving terminal. In the digital version of the signalling system the signal is passed through the interface adaptor before entering the outgoing digital channel.

### 1.1.4 *Receiving terminal*

The receiving function starts with the acceptance of the serial data from the transmission path. The output of the demodulator or the interface adaptor is delivered to the decoder where each signal unit is checked for errors on the basis of the associated check bits. Signal units received with detected errors are discarded. Signal units carrying telephone signals or management signals which are error-free are transferred to the input buffer after deletion of the check bits. The input buffer delivers the signal units to the processor where the processor analyzes the signals and takes appropriate action.

### 1.1.5 *Error control*

Error control is based on error detection by redundant coding and on error correction by retransmission of those signal messages found to be in error. This procedure requires that each transmitted signal message be stored until acknowledged as being received correctly. In the case of multi-unit messages, each signal unit of the message must be stored until all units of the message are acknowledged as being received correctly. When an acknowledgement signal unit is received, it is analyzed in the box marked *error control* in Figure 1/Q.251. If an acknowledgement bit indicates that a signal unit being acknowledged was received in error, the retransmission process is started. Request for retransmission of a synchronization signal unit is ignored. If any unit of a multi-unit message is in error, the entire multiunit message must be retransmitted in its initial order.

The data channel failure detector complements the decoder for longer error bursts. When activated it gives an indication to the box marked *error control* in Figure 1/Q.251. An error indication from either the decoder or the data

channel failure detector is associated with the position of the erroneous signal unit(s) within the block. This information is used by the acknowledgement signal unit generator to control the marking of the acknowledgement bits.

As shown in Figure 1/Q.251, the processor may also be notified whenever an error is detected in a signal unit. This information may be used by the processor to erase the memory of any signal unit(s) of a multi-unit message received which is associated with the one found in error, since this entire message will be retransmitted.

**Recommendation Q.252**

**1.2 SIGNAL TRANSFER TIME DEFINITIONS**

**1.2.1 Functional reference points**

The major functional reference points are as indicated in Figure 3/Q.252, i.e. points A, B, C and D, which are defined below:

*Point A.* – That point in a switching centre where the signal as a signal unit, before being coded (check bits added), is delivered from the processor to an output buffer store.

*Point B.* – That point where the signal unit (check bits included) in serial form will be delivered to the transmission path.

*Point C.* – That point where the signal unit (check bits included) in serial form will be delivered to the demodulator or interface adaptor.

*Point D.* – That point in a switching centre where the signal unit, after being decoded (check bits deleted), will be presented from an input buffer store to the processor.

The functional reference points B and C are typically those points which define the transmission path used for common channel signalling. In the analogue version this transmission path is provided by a voice frequency channel and in the digital version by a digital channel.

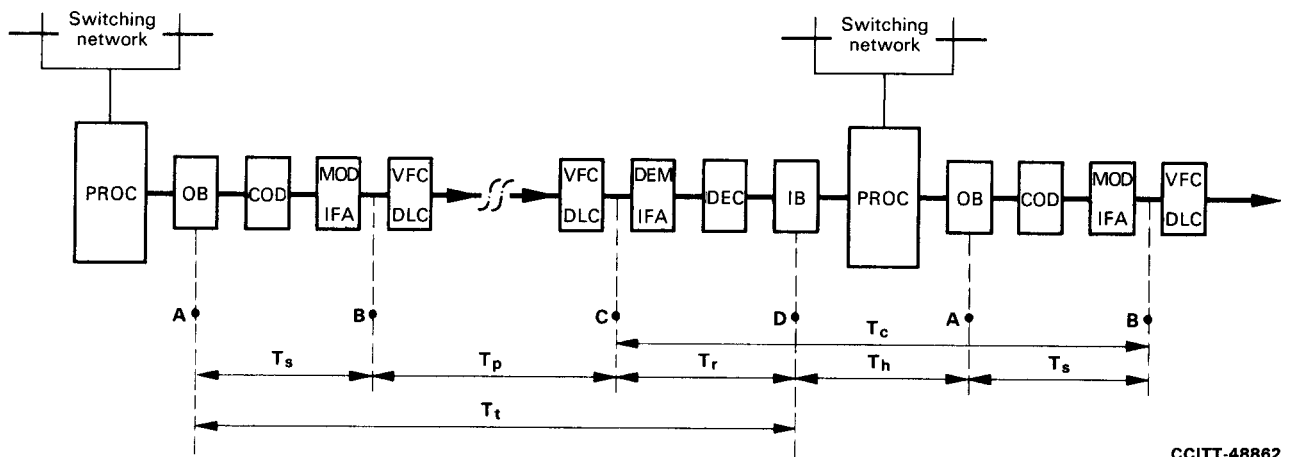

CCITT-48862

PROC	processor	$T_c$	cross-office transfer time
OB	output buffer	$T_h$	processing (handling) time
IB	input buffer	$T_p$	voice-frequency or digital channel propagation time
COD	coder	$T_r$	receiver transfer time
DEC	decoder	$T_s$	sender transfer time
MOD	modulator	$T_t$	total signal transfer time
DEM	demodulator		
VFC	voice-frequency channel		
IFA	interface adaptor		
DLC	digital channel		

FIGURE 3/Q.252

Functional signal transfer time diagram

### 1.2.2 *Signal transfer time components*

The various components of signal transfer time between two switching centres are defined as follows:

$T_c$  = cross-office transfer time,

$T_e$  = emission time of a signal unit (included in  $T_s$ ),

$T_h$  = processing (handling) time,

$T_p$  = transfer channel propagation time,

$T_q$  = queueing delay in the output buffer store (included in  $T_s$ ),

$T_r$  = receiver transfer time,

$T_s$  = sender transfer time,

$T_t$  = total signal transfer time.

$T_h$  is that period from the moment the signal is available for acceptance by the processor to the moment the signal is placed in the output buffer and is available for transmission.

$T_r$  is that period of time from the moment when the last bit of the signal unit leaves the transfer channel to that time when the signal is completely in the input buffer and is available for acceptance by the processor.  $T_r$  thus includes the following actions: demodulation, decoding (error detection) and, where present, serial to parallel conversion.

$T_s$  is that period of time from the moment when the signal enters the output buffer store to that time when the last bit of the signal unit passes into the transfer channel.  $T_s$  thus includes the following times and actions: emission time of signal unit(s) (one-unit or multi-unit message), queueing delay in the output buffer store, encoding (adding check bits), parallel to serial conversion where present, modulation in the analogue version and clock and data rate conversion where applicable in the digital version.

The definitions of signal transfer times give rise to the following time relationships:

$$T_c = T_r + T_h + T_s$$

$$T_t = T_s + T_p + T_r$$

In the case when an error is detected, retransmission will occur and the above time relationships are not valid. Rather, the time involved in retransmission and the extra queueing delays, which may occur on a retransmitted signal, must be taken into consideration.

## **Recommendation Q.253**

### **1.3 ASSOCIATION BETWEEN SIGNALLING AND SPEECH NETWORKS**

#### 1.3.1 *Definitions*

The signals pertaining to a given group of speech circuits between two exchanges utilizing a common channel signalling system can be transferred in the following ways:

##### **1.3.1.1 associated mode of operation**

In the associated mode of operation, the signals are transferred between the two exchanges over a common signalling link which terminates at the same exchanges as the group of speech circuits to which the signalling link has been assigned.

##### **1.3.1.2 non-associated mode of operation**

In a non-associated mode of operation, the signals are transferred between the two exchanges over two or more common signalling links in tandem, the signals being processed and forwarded through one or more intermediate *signal transfer points* (see § 1.3.3 below). Following this definition, there may be a range of non-associated modes of operation

which vary in the degree of rigidity imposed on the choice of the path utilized by the signals pertaining to the speech circuit. The ends of this range can be described as fully dissociated mode and quasi-associated mode of operation.

a) **fully dissociated mode of operation**

The fully dissociated mode of operation is the extreme case of the non-associated mode. It is assumed that there is an established network of common signalling links and signal transfer points which may have its own routing principles.

In the fully dissociated mode of operation, the signals are transferred between the two exchanges via any available path in the signalling network according to the rules of that network.

b) **quasi-associated mode of operation**

The quasi-associated mode of operation is the limited form of the non-associated mode. The common signalling links to be used are generally each operating in the associated mode with a group of circuits.

In the quasi-associated mode of operation the signals are transferred between the two exchanges over two or more common signalling links in tandem, but only over certain predetermined paths and through predetermined signal transfer points.

1.3.2 Association methods provided by the System No. 6

Signalling System No. 6 is designed to provide associated and quasi-associated modes of operation as defined in §§ 1.3.1.1 and 1.3.1.2, b) above, e.g. as shown in Figure 4/Q.253.

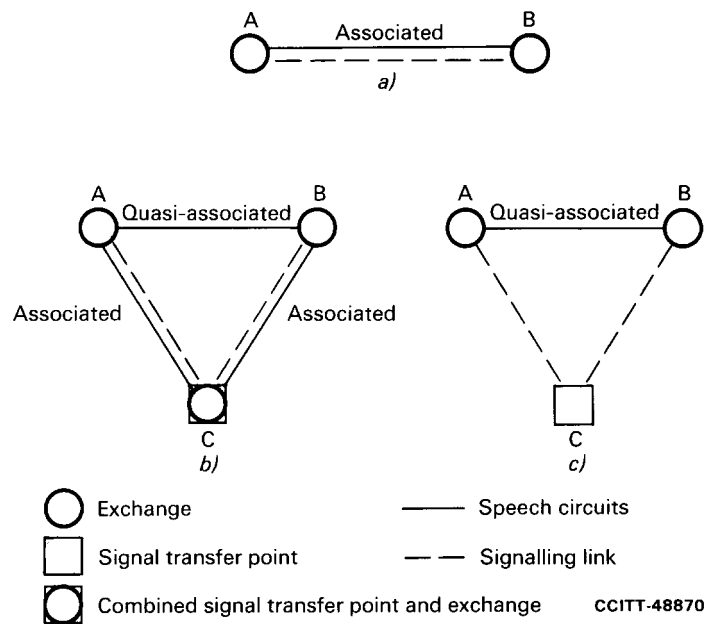

FIGURE 4/Q.253

**Example of associated and quasi-associated modes of operation**

As far as quasi-associated structures are concerned, the number of signal transfer points in the signalling path for a group of speech circuits between the two System No. 6 exchanges should be kept as low as practicable. Normally, one such signal transfer point should suffice. However, there may be groups of circuits without associated common signalling links which will need more than one signal transfer point to handle the signalling traffic.

Attention is drawn to the fact that the addition of a signal transfer point involves the handling time at that point and one additional signal transfer time. Extensive use of signal transfer points will reduce some of the advantages of the signalling speed of System No. 6.

*Note* – It should be noted that where a speech circuit group has an associated signalling link, dependability requirements may be met with economically, by using quasi-associated operation under breakdown condition when the associated signalling link is non-operative.



### 1.3.3 **signal transfer point**

#### 1.3.3.1 *Definition*

A signal transfer point is a signal relay centre handling and forwarding telephone signals from one signalling link to another in case of signalling in a non-associated mode of operation as defined in § 1.3.1.2 above.

*Note* – Following this definition there is no need for a signal transfer point to have any connection with, or relation to, a switching centre.

However, in the case of a quasi-associated mode of operation as defined in § 1.3.1.2 b) above, it is obvious that a signal transfer point may coincide with the System No. 6 exchange where the signalling links terminate and that the equipment may be incorporated into the signalling equipment of that System No. 6 exchange.

#### 1.3.3.2 *Functions of a signal transfer point*

a) The equipment at a signal transfer point has to analyze the label and telephone signal information of every telephone signal message received in order to offer the message to the proper outgoing signalling channel, taking account of its priority, if any.

b) In doing so, it may be necessary to change the label of the received telephone signal message according to some preset rules. However, the telephone signal information included in the message will never be changed by the equipment of a signal transfer point.

c) If for some reason a signal transfer point is unable to transfer signal messages, a procedure is provided to notify the preceding exchange(s) so that signal messages may be sent via reserve routes if available.

*Note* – The fact mentioned under b) above and the fact that the analysis of the received message will never be accompanied by the switching of speech circuits provide a distinction between a signal transfer point and a transit exchange. In general, a transit exchange will be designed to perform both the normal transit exchange functions and the signal transfer point functions.

## SECTION 2

### DEFINITION AND FUNCTION OF SIGNALS

#### Recommendation Q.254<sup>1)</sup>

#### 2.1 TELEPHONE SIGNALS

Signals concerning a particular call or a particular speech circuit.

##### 2.1.1 address signal

A call set-up signal sent in the forward direction containing one element of information (digit 1, 2, ... 9 or 0, code 11 or code 12) about the called party's number or the end-of-pulsing (ST) signal.

For each call, a succession of address signals is sent.

##### 2.1.2 country-code indicator

Information sent in the forward direction indicating whether or not the country code is included in the address information.

##### 2.1.3 nature-of-circuit indicator

Information sent in the forward direction about the nature of the circuit or any preceding circuit(s) already engaged in the connection:

- *satellite circuit*, or
- *no satellite circuit*.

An international exchange receiving this information will use it (in combination with the appropriate part of the address information) to determine the nature of the outgoing circuit to be chosen.

##### 2.1.4 echo suppressor indicator

Information sent in the forward direction indicating whether or not an outgoing half-echo suppressor is included in the connection.

##### 2.1.5 calling-party's-category indicator

Information sent in the forward direction about the *category of the calling party* and, in case of semi-automatic calls about the *service language* to be spoken by the incoming, delay and assistance operators.

The following categories are provided:

- operator,
- ordinary calling subscriber,
- calling subscriber with priority,
- data call,
- test call.

---

<sup>1)</sup> Some section numbers have been reserved for future use.

#### 2.1.6 **end-of-pulsing (ST) signal**

An address signal sent in the forward direction indicating that there are no more address signals to follow.

#### 2.1.10 **continuity signal**

A signal sent in the forward direction indicating continuity of the preceding No. 6 speech circuit(s) as well as of the selected speech circuit to the following international exchange, including verification of the speech path across the exchange with the specified degree of reliability.

#### 2.1.12 **switching-equipment-congestion signal**

A signal sent in the backward direction indicating the failure of the call set-up attempt due to congestion encountered at international switching equipment.

#### 2.1.13 **circuit-group-congestion signal**

A signal sent in the backward direction indicating the failure of the call set-up attempt due to congestion encountered on an international circuit group or on the outgoing links of a terminal international exchange.

#### 2.1.14 **national-network-congestion signal**

A signal sent in the backward direction indicating the failure of the call set-up attempt due to congestion encountered in the national destination network (excluding the busy condition of the called party's line(s)).

#### 2.1.15 **address-incomplete signal**

A signal sent in the backward direction indicating that the number of address signals received is not sufficient for setting up the call. This condition may be determined in the incoming international exchange (or in the national destination network):

- immediately after the reception of an ST signal, or
- on time-out after the latest digit received.

#### 2.1.16 **address-complete signal, charge**

A signal sent in the backward direction indicating that all the address signals required for routing the call to the called party have been received, that no called-party's-line-condition signals (electrical) will be sent, and that the call should be charged on answer.

#### 2.1.17 **address-complete signal, no charge**

A signal sent in the backward direction indicating that all the address signals required for routing the call to the called party have been received, that no called-party's-line-condition signals (electrical) will be sent, and that the call should not be charged on answer.

#### 2.1.18 **address-complete signal, coin-box**

A signal sent in the backward direction indicating that all the address signals required for routing the call to the called party have been received, that no called-party's-line-condition signals (electrical) will be sent, that the call should be charged on answer, and that the called number is a coin (box) station.

#### 2.1.19 **address-complete, subscriber-free signal, charge**

A signal sent in the backward direction as an alternative to the address-complete, charge signal indicating that the called party's line is free, and that the call should be charged on answer.

#### 2.1.20 **address-complete, subscriber-free signal, no charge**

A signal sent in the backward direction as an alternative to the address-complete, no charge signal indicating that the called party's line is free, and that the call should not be charged on answer.

#### 2.1.21 **address-complete, subscriber-free signal, coin-box**

A signal sent in the backward direction as an alternative to the address-complete, coin-box signal indicating that the called party's line is free, that the call should be charged on answer, and that the called number is a coin (box) station.

#### 2.1.23 **unallocated-number signal**

A signal sent in the backward direction indicating that the received number is not in use (for example spare level, spare code, vacant subscriber's number).

#### 2.1.24 **subscriber-busy signal (electrical)**

A signal sent in the backward direction indicating that the line(s) connecting the called party with the exchange is (are) engaged. The subscriber-busy signal will also be sent in case of complete uncertainty about the place where the busy or congestion conditions are encountered and in the case where a discrimination between subscriber-busy and national-network congestion is not possible.

#### 2.1.25 **line-out-of-service signal**

A signal sent in the backward direction indicating that the called party's line is out-of-service or faulty.

#### 2.1.26 **send-special-information tone signal**

A signal sent in the backward direction indicating that the special information tone should be returned to the calling party. This tone indicates that the called number cannot be reached for reasons not covered by other specific signals and that the unavailability is of a long term nature. (See also Recommendation Q.35.)

#### 2.1.27 **confusion signal**

Signal sent in the backward direction indicating that an exchange is unable to act upon a message received from the preceding exchange because the message is considered unreasonable.

#### 2.1.28 **call-failure signal**

A signal sent in the backward direction indicating the failure of a call set-up attempt due to the lapse of a time-out or a fault not covered by specific signals and where the congestion tone is the appropriate tone to be returned to the calling party.

#### 2.1.29 **message-refusal signal**

A signal sent by a signal transfer point in response to the reception of a telephone signal which it is unable to deal with as a consequence of the transfer-prohibited situation.

#### 2.1.31 **forward-transfer signal**

A signal sent in the forward direction on semi-automatic calls when the outgoing international exchange operator wants the help of an operator at the incoming international exchange. The signal will normally serve to bring an assistance operator (see Recommendation Q.101) into the circuit if the call is automatically set up at that exchange. When a call is completed via an operator (incoming or delay operator) at the incoming international exchange, the signal should preferably cause this operator to be recalled.

#### 2.1.32 **answer signal, charge**

A signal sent in the backward direction indicating that the call is answered and subject to charge.

In semi-automatic working, this signal has a supervisory function. In automatic working, the signal is used:

- to start metering the charge to the calling subscriber (Recommendation Q.28), and
- to start the measurement of call duration for international accounting purposes.

#### 2.1.33 **answer signal, no charge**

A signal sent in the backward direction indicating that the call is answered but is not subject to charge. It is used for calls to particular destinations only.

In semi-automatic working, this signal has a supervisory function. In automatic working, the reception of this signal shall not start the metering to the calling subscriber.

#### 2.1.34 **clear-back signals**

Signals sent in the backward direction, the first of which indicates that the called party has cleared. Subsequent clear-back signals indicate that the called party has cleared following a reanswer, e.g. switch-hook flashing.

In semi-automatic working, they perform a supervisory function. In automatic working, the arrangements specified in Recommendation Q.118 apply.

#### 2.1.35 **reanswer signals**

Signals in the backward direction indicating that the called party, after having cleared, again lifts his receiver or in some other way reproduces the answer condition, e.g. switch-hook flashing.

#### 2.1.36 **clear-forward signal**

A signal sent in the forward direction to terminate the call or call attempt and release the circuit concerned. This signal is normally sent when the calling party clears but also may be a proper response in other situations, as for example, when reset circuit is received.

#### 2.1.37 **release-guard signal**

A signal sent in the backward direction in response to a clear-forward signal, or if appropriate to the reset-circuit signal, when the circuit concerned has been brought into the idle condition.

#### 2.1.38 **reset-circuit signal**

A signal that is sent to release a circuit when, due to memory mutilation or other causes, it is unknown whether, for example, a clear-forward or clear-back signal is appropriate. If at the receiving end the circuit is blocked, this signal should remove that condition.

#### 2.1.41 **blocking signal**

A signal sent for maintenance purposes to the exchange at the other end of a circuit to cause engaged conditions of that circuit for subsequent calls outgoing from that exchange. An exchange receiving the blocking signal must be capable of accepting incoming calls on that circuit unless it also has sent a blocking signal. Under conditions covered later, a blocking signal is also a proper response to a reset-circuit signal.

#### 2.1.42 **unblocking signal**

A signal sent to the exchange at the other end of a circuit to cancel in that exchange the engaged conditions of that circuit caused by an earlier blocking signal.

#### 2.1.43 **blocking-acknowledgement signal**

A signal sent in response to a blocking signal indicating that the speech circuit has been blocked.

#### 2.1.44 **unblocking-acknowledgement signal**

A signal sent in response to an unblocking signal indicating that the speech circuit has been unblocked.

## **2.2      SIGNALLING-SYSTEM-CONTROL SIGNALS**

Signals used for the proper functioning of the signalling system via the common signalling link.

### **2.2.1      acknowledgement indicator**

Information indicating whether or not an error has been detected in a received signal unit.

### **2.2.2      synchronization signal**

A signal sent in order to establish and maintain synchronization between the two ends of a signalling channel.

### *2.2.3      System-control signals*

#### **2.2.3.1    changeover signal**

A signal sent to indicate a failure on a synchronized signalling link. If this signal is sent on a link carrying signalling information, it also indicates that a changeover to the next reserve signalling link is required.

#### **2.2.3.2    manual-changeover signal**

A signal sent to initiate a changeover to a reserve signalling link or to initiate the removal of full-time synchronized reserve link from service availability because of need for rearrangements, changes, maintenance, etc.

#### **2.2.3.3    manual-changeover-acknowledgement signal**

A signal sent in response to a manual-changeover signal to indicate that manual changeover can take place.

#### **2.2.3.4    standby-ready signal**

A signal sent on a standby reserve link to indicate that the error rate on that link has met the requirements of the *one-minute proving period*.

#### **2.2.3.5    standby-ready-acknowledgement signal**

A signal sent on the standby reserve link in response to a standby-ready signal and indicating that the error rate on that link has met the requirements of the *one-minute proving period*.

#### **2.2.3.6    load transfer signal**

A signal sent on a link to indicate that the error rate on that link has met the requirements of the *one-minute proving period* and that signalling traffic should be transferred to that particular link.

#### **2.2.3.7    emergency-load-transfer signal**

A signal sent on as many links as possible to indicate that the error rate on those links has met the requirements of the *emergency proving period*, and that emergency transfer can take place to one of these links.

#### **2.2.3.8    load-transfer-acknowledgement signal**

A signal sent on a link in response to a load-transfer signal or to an emergency-load-transfer signal to indicate that the load-transfer will take place to that particular link.

## 2.2.4 *Multi-block synchronization signals*

### 2.2.4.1 **multi-block monitoring signal**

A signal, required on links where the number of blocks in the error control loop exceeds 8, and sent to check multi-block synchronism.

### 2.2.4.2 **multi-block acknowledgement signal**

A signal sent on a link in response to a multi-block monitoring signal and used by the receiving terminal to verify multi-block synchronism.

## **Recommendation Q.256**

### **2.3 MANAGEMENT SIGNALS**

Signals concerning the management of the speech circuit network and the signalling network. The three following categories of signals are distinguished:

#### 2.3.1 **network-management signals**

Information regarding the conditions of circuit groups or equipment sent from one point in the network to one or more other points. This excludes information relevant to individual calls or individual speech circuits.

#### 2.3.2 **network-maintenance signals**

Management signals used for maintenance purposes.

##### 2.3.2.1 **reset-band signal**

A signal sent by a failed exchange during recovery to request that all circuits in the band be put in the idle state except those circuits at the receiving end that have imposed a blocked condition on the sending end. If at the receiving end the circuit is blocked, the reset-band signal should remove that condition.

##### 2.3.2.2 **reset-band-acknowledgement signal**

A signal sent in response to the reset-band signal to indicate whether a circuit is available for use or should be blocked in the failed exchange.

##### 2.3.2.3 **reset-band-acknowledgement signal, all circuits idle**

A signal sent in response to the reset-band signal to indicate that all circuits in the band are available for use.

#### 2.3.3 **signalling-network-management signals**

Information regarding the conditions of signalling links which may be required to modify signal routings. This excludes information relevant to the signals concerned with individual calls or speech circuits.

##### 2.3.3.1 **transfer-prohibited signal**

A signal sent by a signal transfer point when it is unable to transfer signals for a particular group of circuits.

##### 2.3.3.2 **transfer-allowed signal**

A signal sent by a signal transfer point when it is once again ready to transfer signals for the particular group of circuits.

##### 2.3.3.3 **transfer-allowed-acknowledgement signal**

A signal sent in response to the reception of a transfer-allowed signal.

## SECTION 3

### SIGNAL UNIT FORMATS AND CODES

#### Recommendation Q.257

#### 3.1 GENERAL

##### 3.1.1 *Types of message and signal unit (SU)*

Signalling and other information carried by the common signalling link is transferred by means of messages consisting of one or more signal units.

A **signal unit (SU)** is the smallest defined group of bits on the signalling channel and contains 28 bits.

Dependent upon the number of signal units necessary to transmit one message, the message is called a one-unit message or a multi-unit message.

##### 3.1.1.1 *One-unit message, lone signal unit (LSU)*

A **one-unit message** is a message which is transmitted entirely within one signal unit, Such a signal unit is called a lone signal unit (LSU). It is designed to transmit either:

- a) a single telephone signal,
- b) a signalling-system-control signal, or
- c) a management signal.

##### 3.1.1.2 *Multi-unit message (MUM)*

A **multi-unit message (MUM)** consists of 2, 3, 4, 5 or 6 signal units in tandem. It is designed to transmit a number of related signals (e.g. address signals) in an efficient way. A special case of the multi-unit messages is the initial address message, which is the only one which can have six signal units in tandem and has a minimum of three signal units.

##### 3.1.1.3 **initial signal unit (ISU)**

The first signal unit of a multi-unit message is called the initial signal unit (ISU).

##### 3.1.1.4 **subsequent signal unit (SSU)**

The second and any following signal unit of a multi-unit message are called subsequent signal units (SSU).

#### 3.1.2 *Basic formats*

##### 3.1.2.1 *Basic format of a lone signal unit*

The basic format of a lone signal unit is shown in Figure 5/Q.257.



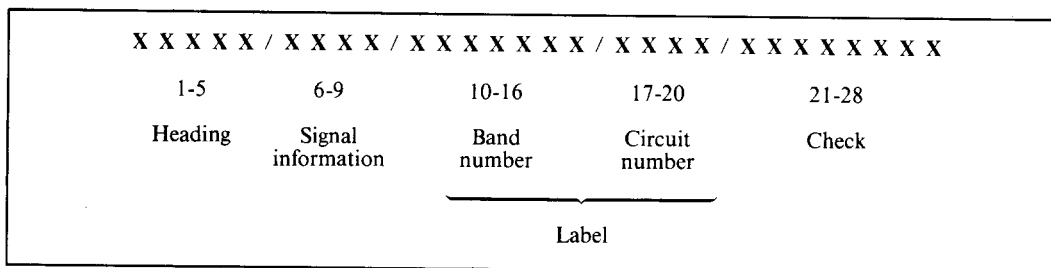

FIGURE 5/Q.257

**Basic format of:** – a lone signal unit  
 – an initial signal unit of a multi-unit message

The basic format of a lone signal unit is not used in all cases. Where a different format is used it is shown in the sections relating to individual signal units.

### 3.1.2.2 Basic format of a multi-unit message

The format of the initial signal unit of a multi-unit message is shown in Figure 5/Q.257. The use of a special code in the signal information field (bits 6-9) distinguishes an initial signal unit from a lone signal unit. See 3.1.2.1 above.

The format of a subsequent signal unit of a multi-unit message is shown in Figure 6/Q.257.

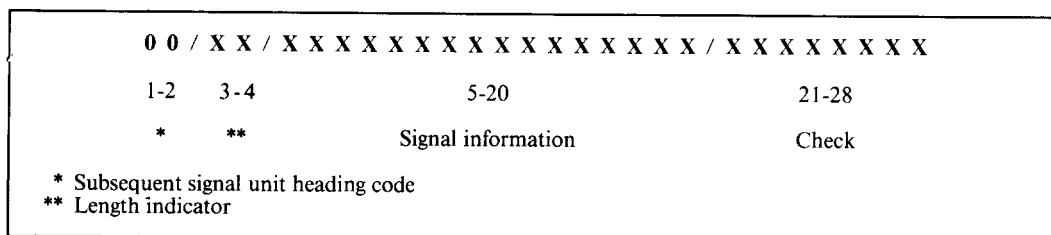

FIGURE 6/Q.257

**Format of a subsequent signal unit of a multi-unit message**

For some messages, the signal information field of a subsequent signal unit (bits 5-20) can be sub-divided, notably in address messages where the field is divided into four 4-bit parts.

### 3.1.3 Codes for the general parts of signal units

The interpretation of a message depends upon a system of codes in various parts of the message.

#### 3.1.3.1 Heading

The heading is used to identify the type of:

- a) group of signals,
- b) message, or
- c) signal.

The heading generally consists of the first five bits of the signal units (bits 1-5). There are two exceptions to this rule, viz.:

- all subsequent signal units are identified by the same 2-bit heading code **0 0** (bits 1-2);
- the acknowledgement signal unit is identified by a 3-bit heading code **0 1 1** (bits 1-3).

The heading codes are allocated as follows:

<b>0 0</b>	Subsequent signal unit
<b>0 1 0 0 0</b>	} Spare (reserved for regional and/or national use)
<b>0 1 0 0 1</b>	
<b>0 1 0 1 0</b>	
<b>0 1 0 1 1</b>	
<b>0 1 1</b>	Acknowledgement signal unit
<b>1 0 0 0 0</b>	Initial signal unit of an initial address message (or of a multi-unit message)
<b>1 0 0 0 1</b>	} Subsequent address message (one-unit message or multi-unit message)
<b>1 0 0 1 0</b>	
<b>1 0 0 1 1</b>	
<b>1 0 1 0 0</b>	
<b>1 0 1 0 1</b>	
<b>1 0 1 1 0</b>	
<b>1 0 1 1 1</b>	
<b>1 1 0 0 0</b>	} International telephone signals
<b>1 1 0 0 1</b>	
<b>1 1 0 1 0</b>	
<b>1 1 0 1 1</b>	
<b>1 1 1 0 0</b>	Spare (reserved for regional and/or national use)
<b>1 1 1 0 1</b>	} Signalling-system-control signals (except acknowledgement signal unit) and management signals
<b>1 1 1 1 0</b>	
<b>1 1 1 1 1</b>	} Spare (reserved for regional and/or national use)
<b>1 1 1 1 1</b>	

The heading code allocation is also shown in Table 2/Q.257.

### 3.1.3.2 *Signal information*

Signal units with a 5-bit heading code have a signal information field of four bits (bits 6-9). The signal information field is used:

- to define a particular signal within a group of signals being defined by the heading code,
- to define a sub-group within a group of signals, or
- to indicate that the signal unit is an initial signal unit and that the subsequent signal unit(s) contain(s) a number of signals belonging to the group of signals defined by the heading code.

For case c), the signal information code **0 0 0 0** is used except with heading code **1 0 0 0 0** which alone is sufficient to identify the signal unit as an initial signal unit.

The allocation of signal information codes is shown in Table 2/Q.257.

### 3.1.3.3 *Label*

Messages which relate to a speech circuit (or a group or sub-group of speech circuits) must carry a label to identify that circuit (or group of circuits). Only one label per message is used.

To identify a group of up to sixteen speech circuits, a 7-bit *band number* is used (bits 10-16).

TABLE 2/Q.257  
Allocation of heading and signal information codes

Bits 6-9	Bits 1-5	0000X	0001X	0010X	0011X	01000	01001	01010	01011	011XX	10000	10001	10010	10011	10100	10101	10110	10111	11000	11001	11010	11011	11100	11101	11110	11111	Bits 1-5	Bits 6-9																		
0000	SSU					ISU of MUM	ISU of MUM	ISU of MUM	ISU of MUM		ISU of IAM	ISU of SAM 1	ISU of SAM 2	ISU of SAM 3	ISU of SAM 4	ISU of SAM 5	ISU of SAM 6	ISU of SAM 7	ISU of MUM	ISU of MUM	ISU of MUM	ISU of MUM	ISU of MUM	ISU of MUM	ISU of MUM	ISU of MUM	ISU of MUM	ISU of MUM	0000																	
NOT 0000						LSU	LSU	LSU	LSU		ISU of MUM	Lone SAM 1	Lone SAM 2	Lone SAM 3	Lone SAM 4	Lone SAM 5	Lone SAM 6	Lone SAM 7	LSU	LSU	LSU	LSU	LSU	LSU	LSU	LSU	LSU	LSU	LSU	NOT 0000																
0000	ONE SSU or FIVE SSUs (IAM only)					RESERVED FOR REGIONAL and/or NATIONAL USE	RESERVED FOR REGIONAL and/or NATIONAL USE	RESERVED FOR REGIONAL and/or NATIONAL USE	RESERVED FOR REGIONAL and/or NATIONAL USE	ACU	RESERVED FOR REGIONAL and/or NATIONAL USE												RESERVED FOR REGIONAL and/or NATIONAL USE	RESERVED FOR REGIONAL and/or NATIONAL USE	RESERVED FOR REGIONAL and/or NATIONAL USE	RESERVED FOR REGIONAL and/or NATIONAL USE																				
0001													1	1	1	1	1	1	1	1	1	RLG																						0000		
0010													2	2	2	2	2	2	2	2	2	ANC																							0001	
0011													3	3	3	3	3	3	3	3	3	ANN					SEC	FOT	AFX																0010	
0100													4	4	4	4	4	4	4	4	4	CB 1					CGC		SSB																0011	
0101													5	5	5	5	5	5	5	5	5	RA 1					NNC		UNN																0100	
0110													6	6	6	6	6	6	6	6	6	CB 2							LOS																0101	
0111													7	7	7	7	7	7	7	7	7	RA 2							SST																0110	
1000													8	8	8	8	8	8	8	8	8	CB 3					CFL																		0111	
1001													9	9	9	9	9	9	9	9	9	RA 3																							1000	
1010													0	0	0	0	0	0	0	0	0																									1001
1011																																														1010
1100																																														1011
1101																																														1100
1110																																														1101
1111																																														1110
																															1111															

*Note* – All unassigned codes are reserved for international use. The interpretation of the abbreviations for signals is given in the List of *Abbreviations Specific to Signalling System No. 6* at the end of Part I of this fascicle.

To identify a circuit within a group of up to sixteen speech circuits, an additional 4-bit code (circuit number) is used (bits 17-20). See Figure 5/Q.257.

This provides a total of 11 bits which can be used to identify 2048 speech circuits.

Label codes will be assigned by the Administration concerned.

The label field position is in bits 10-20 of either a lone signal unit or an initial signal unit of a multi-unit message. Subsequent signal units of multi-unit messages do not require a label. Where a 7-bit band number alone is sufficient to identify the destination of a signal (e.g. some management signals), bits 17-20 can contain some further signalling information.

#### 3.1.3.4 Length indicator

Subsequent signal units have a length indicator field of two bits (bits 3-4) to indicate the number of subsequent signal units contained in a multi-unit message. Each subsequent signal unit of a multi-unit message carries the same length indicator. The codes used are shown in Table 3/Q.257.

TABLE 3/Q.257

Number of subsequent signal units	Length indicator	
	Initial address message	Other multi-unit messages
1	–	00
2	01	01
3	10	10
4	11	11
5	00	–

The length indicator **0 0** has a different, but unambiguous meaning in the initial address message because the initial address message has a minimum requirement of two subsequent signal units.

#### 3.1.3.5 Check

Every signal unit has a check field of eight bits (bits 21-28) for error detection purposes (see Recommendation Q.277).

### Recommendation Q.258

## 3.2 TELEPHONE SIGNALS

### 3.2.1 Initial address message (IAM)

The initial address message (IAM) is the first message of a call. It is a special case of the multi-unit message as it consists of a minimum of three signal units and a maximum of six signal units. It can contain different types of information – address signals (including ST), other routing information, and the filler code – under the same heading code.

#### 3.2.1.1 Format of the initial address message

The format of the initial signal unit is shown in Figure 5/Q.257.

The format of the subsequent signal units is shown in Figure 6/Q.257 except for the subsequent signal units numbers 2-5 in which the signal information field (bits 5-20) is sub-divided into four 4-bit parts so that four address signals can be carried in each of these subsequent signal units.

The subsequent signal units of an initial address message do not require the 5-bit heading or 11-bit label as this information is already contained in the initial signal unit.

The number of address signals available for transmission determines the length of the initial address message.

### 3.2.1.2 Codes used in the initial address message

#### a) Initial signal unit

- The 5-bit heading code **1 0 0 0 0** is used.
- The signal information code **0 0 0 0** is used.
- The assigned label code is used.

#### b) Subsequent signal unit (number 1)

- The heading code **0 0** is used.
- The length indicator is coded as appropriate (see Recommendation Q.257, 3.1.3.4).
- Bit 5: country code indicator:
  - 0** country code not included
  - 1** country code included
- Bit 6: nature of circuit indicator:
  - 0** no satellite circuit in the connection
  - 1** one satellite circuit in the connection
- Bit 7: echo-suppressor indicator:
  - 0** outgoing half-echo suppressor not included
  - 1** outgoing half-echo suppressor included
- Bit 8: spare (reserved for international use) <sup>1)</sup>
- Bits 9-12: spare (reserved for regional and/or national use) <sup>1)</sup>
- Bits 13-16: calling-party's-category indicator
  - 0 0 0 0** spare
  - 0 0 0 1** operator, language French
  - 0 0 1 0** operator, language English
  - 0 0 1 1** operator, language German
  - 0 1 0 0** operator, language Russian
  - 0 1 0 1** operator, language Spanish
  - 0 1 1 0** } available to Administration
  - 0 1 1 1** } for selecting a particular language provided by mutual agreement
  - 1 0 0 0** }
  - 1 0 0 1** reserved (see Recommendation Q.104)
  - 1 0 1 0** ordinary calling subscriber
  - 1 0 1 1** calling subscriber with priority
  - 1 1 0 0** data call
  - 1 1 0 1** test call
  - 1 1 1 0** spare
  - 1 1 1 1** spare (reserved for regional and/or national use)
- Bits 17-20: spare (reserved for regional and/or national use) <sup>1)</sup>

---

<sup>1)</sup> These bits are coded as **0** at present.

c) *Subsequent signal units (numbers 2-5) – telephone call*

- The heading code **0 0** is used.
- The length indicator is coded as appropriate (see Recommendation Q.257, § 3.1.3.4).
- The four 4-bit parts of the signal information field contain address signals in sequence, bits 5-8, bits 9-12, etc., and are coded as follows:

<b>0 0 0 0</b>	filler	(no information)
<b>0 0 0 1</b>	digit	1
<b>0 0 1 0</b>	digit	2
<b>0 0 1 1</b>	digit	3
<b>0 1 0 0</b>	digit	4
<b>0 1 0 1</b>	digit	5
<b>0 1 1 0</b>	digit	6
<b>0 1 1 1</b>	digit	7
<b>1 0 0 0</b>	digit	8
<b>1 0 0 1</b>	digit	9
<b>1 0 1 0</b>	digit	0
<b>1 0 1 1</b>	code	11
<b>1 1 0 0</b>	code	12
<b>1 1 0 1</b>	spare	
<b>1 1 1 0</b>	spare	
<b>1 1 1 1</b>	ST	

The filler code **0 0 0 0** is used where needed to complete the signal information field of the last subsequent signal unit of the initial address message.

d) *Subsequent signal unit (number 2) – test call*

- The heading code **0 0** is used.
- The length indicator is coded as appropriate (see Recommendation Q.257, § 3.1.3.4).
- The first 4-bit part (bits 5-8) of the signal information field contains an address signal coded as follows:

<b>0 0 0 0</b>	system No. 6 continuity check
<b>0 0 0 1</b>	ATME 2 – signalling check and transmission test
<b>0 0 1 0</b>	ATME 2 – signalling check only
<b>0 0 1 1</b>	quiet termination test line
<b>0 1 0 0</b>	echo suppressor test system
<b>0 1 0 1</b>	loop around test line
<b>0 1 1 0</b>	transmission access test line
<b>0 1 1 1</b>	transmission access test line
<b>1 0 0 0</b>	transmission access test line
<b>1 0 0 1</b>	echo canceller test line
<b>1 0 1 0</b>	spare
<b>1 0 1 1</b>	spare
<b>1 1 0 0</b>	spare
<b>1 1 0 1</b>	spare
<b>1 1 1 0</b>	spare
<b>1 1 1 1</b>	spare

The codes used to complete the signal information field of the subsequent signal unit (number 2) test call are the end-of-pulsing (ST) and fillers.

3.2.1.3 *Example of an initial address message*

An example of a three-unit initial address message is shown in Figure 7/Q.258.

ISU	1 0 0 0 0 / 0 0 0 0 / X X X X X X X X X X / X X X X X X X X						
	Heading code	Signal infor- mation code	Label			Check	
1st SSU	0 0 / 0 1 / X X X 0 0 0 0 0 X X X X 0 0 0 0 / X X X X X X X X						
	*    **	Other routing information				Check	
2nd SSU	0 0 / 0 1 / X X X X    X X X X    X X X X    X X X X / X X X X X X X X						
	*    **	1st	2nd	3rd	4th	Check	
	Address signals						
* Subsequent signal unit heading code							
** Length indicator							

FIGURE 7/Q.258

**Example of a three-unit initial address message**

3.2.2 *Subsequent address message (SAM)*

A subsequent address message (SAM) is used to transmit additional address signals not available when the initial address message is formed.

A subsequent address message may be either a one-unit message or a multi-unit message.

3.2.2.1 *Formats of subsequent address messages*

a) *Lone signal unit*

The format of the lone signal unit is shown in Figure 5/Q.257.

b) *Multi-unit message*

The format of the initial signal unit is shown in Figure 5/Q.257.

The format of the subsequent signal units is shown in Figure 6/Q.257. In this case, however, the signal information fields of every subsequent signal unit are sub-divided into four 4-bit parts.

3.2.2.2 *Codes used in subsequent address messages*

a) *Heading*

Heading codes in the range **1 0 0 0 1-1 0 1 1 1** are used in the lone signal unit or initial signal unit depending on the sequence number of the subsequent address message concerned. The first subsequent address message of a call uses heading **1 0 0 0 1**, the second **1 0 0 1 0**, the third **1 0 0 1 1**, etc. While it is preferred to limit the number of subsequent address messages, if more than seven are sent, the sequence is recycled so that the eighth uses heading code **1 0 0 0 1**.

Subsequent signal units of subsequent address messages use the heading code **0 0**.

b) *Signal information*

– *Lone signal unit*

In the case of a one-unit subsequent address message, the signal information field (bits 6-9) contains one of the address signals which are coded as follows:

- 0 0 0 1** digit 1
- 0 0 1 0** digit 2
- 0 0 1 1** digit 3

**0 1 0 0** digit 4  
**0 1 0 1** digit 5  
**0 1 1 0** digit 6  
**0 1 1 1** digit 7  
**1 0 0 0** digit 8  
**1 0 0 1** digit 9  
**1 0 1 0** digit 0  
**1 1 1 1** ST

Codes **1 0 1 1**, **1 1 0 0**, **1 1 0 1**, **1 1 1 0** and **0 0 0 0** are not used in the signal information field of a one-unit subsequent address message.

– *Multi-unit message*

The signal information field of the initial signal unit is coded as **0 0 0 0**.

The signal information field of the subsequent signal units contains the address signals which are coded as follows:

**0 0 0 0** filler (no information)  
**0 0 0 1** digit 1  
**0 0 1 0** digit 2  
**0 0 1 1** digit 3  
**0 1 0 0** digit 4  
**0 1 0 1** digit 5  
**0 1 1 0** digit 6  
**0 1 1 1** digit 7  
**1 0 0 0** digit 8  
**1 0 0 1** digit 9  
**1 0 1 0** digit 0  
**1 1 1 1** ST

Signal information codes **1 0 1 1**, **1 1 0 0**, **1 1 0 1** and **1 1 1 0** are not used in multi-unit subsequent address messages.

The filler code **0 0 0 0** is used, where needed, to complete the signal information field of the last subsequent signal unit of the subsequent address message.

c) *Label*

The assigned label code is used.

3.2.3 *Other telephone signals*

3.2.3.1 *Telephone signals with heading code 1 0 0 0 0*

The following signal information codes, in conjunction with heading code **1 0 0 0 0**, are allocated:

<b>0 0 0 0</b>	initial signal unit of an initial address message (see Recommendation Q.258, § 3.2.1.2)	
<b>0 0 0 1</b>	spare	} (reserved for international use)
<b>0 0 1 0</b>	spare	
<b>0 0 1 1</b>	spare	} (reserved for regional and/or national use)
<b>0 1 0 0</b>	spare	
<b>0 1 0 1</b>	spare	
<b>0 1 1 0</b>	spare	
<b>0 1 1 1</b>	spare	
<b>1 0 0 0</b>	spare	
<b>1 0 0 1</b>	spare	
<b>1 0 1 0</b>	spare	
<b>1 0 1 1</b>	spare	
<b>1 1 0 0</b>	spare	
<b>1 1 0 1</b>	spare	
<b>1 1 1 0</b>	spare	
<b>1 1 1 1</b>	spare	



The formats for messages using signal information code **0 0 0 1** have not yet been decided. The formats for messages using signal information codes in the range **0 0 1 0 – 1 1 1 1** will be determined by regional organizations and/or national Administrations.

### 3.2.3.2 Telephone signals with heading code **1 1 0 0 0**

The format of one-unit telephone signals using heading code **1 1 0 0 0** is shown in Figure 5/Q.257.

Signals, sent in the backward direction, in lone signal units using heading code **1 1 0 0 0**, are allocated signal information codes as follows:

<b>0 0 0 1</b>	release-guard
<b>0 0 1 0</b>	answer, charge (priority)
<b>0 0 1 1</b>	answer, no charge (priority)
<b>0 1 0 0</b>	clear-back No. 1
<b>0 1 0 1</b>	reanswer No. 1
<b>0 1 1 0</b>	clear-back No. 2
<b>0 1 1 1</b>	reanswer No. 2
<b>1 0 0 0</b>	clear-back No. 3
<b>1 0 0 1</b>	reanswer No. 3
<b>1 0 1 0</b>	spare
<b>1 0 1 1</b>	spare
<b>1 1 0 0</b>	spare
<b>1 1 0 1</b>	spare
<b>1 1 1 0</b>	spare
<b>1 1 1 1</b>	spare

Signal information code **0 0 0 0** indicates that the signal unit is the initial signal unit of a multi-unit message. This facility is reserved for possible future expansion.

### 3.2.3.3 Telephone signals with heading code **1 1 0 0 1**

The format of one-unit telephone signals using heading code **1 1 0 0 1** is shown in Figure 5/Q.257.

Signals, sent in the backward direction, in lone signal units using heading code **1 1 0 0 1**, are allocated signal information codes as follows:

<b>0 0 0 1</b>	spare
<b>0 0 1 0</b>	spare
<b>0 0 1 1</b>	switching-equipment-congestion
<b>0 1 0 0</b>	circuit-group-congestion
<b>0 1 0 1</b>	national-network-congestion
<b>0 1 1 0</b>	spare
<b>0 1 1 1</b>	spare
<b>1 0 0 0</b>	call-failure
<b>1 0 0 1</b>	spare
<b>1 0 1 0</b>	spare
<b>1 0 1 1</b>	spare
<b>1 1 0 0</b>	spare
<b>1 1 0 1</b>	spare
<b>1 1 1 0</b>	confusion
<b>1 1 1 1</b>	spare

Signal information code **0 0 0 0** indicates that the signal unit is the initial signal unit of a multi-unit message. This facility is reserved for possible future expansion.

### 3.2.3.4 Telephone signals with heading code **1 1 0 1 0**

The format of a one-unit telephone signals using heading code **1 1 0 1 0** is shown in Figure 5/Q.257.

Signals, in lone signal units using heading code **1 1 0 1 0**, are allocated signal information codes as follows:

<b>0 0 0 1</b>	continuity	}	sent in the forward direction
<b>0 0 1 0</b>	clear-forward		
<b>0 0 1 1</b>	forward-transfer		
<b>0 1 0 0</b>	spare		
<b>0 1 0 1</b>	spare		
<b>0 1 1 0</b>	spare		
<b>0 1 1 1</b>	spare		
<b>1 0 0 0</b>	spare		
<b>1 0 0 1</b>	spare		
<b>1 0 1 0</b>	reset-circuit	}	sent in either direction
<b>1 0 1 1</b>	blocking		
<b>1 1 0 0</b>	unblocking		
<b>1 1 0 1</b>	blocking-acknowledgement		
<b>1 1 1 0</b>	unblocking-acknowledgement		
<b>1 1 1 1</b>	message-refusal		

Signal information code **0 0 0 0** indicates that the signal unit is the initial signal unit of a multi-unit message. This facility is reserved for possible future expansion.

### 3.2.3.5 Telephone signals with heading code **1 1 0 1 1**

The format of one-unit telephone signals using heading code **1 1 0 1 1** is shown in Figure 5/Q.257.

Signals, sent in the backward direction, in lone signal units using heading code **1 1 0 1 1**, are allocated signal information codes as follows:

<b>0 0 0 1</b>	address-complete, subscriber-free, charge
<b>0 0 1 0</b>	address-complete, subscriber-free, no charge
<b>0 0 1 1</b>	address-complete, subscriber-free, coin-box
<b>0 1 0 0</b>	subscriber-busy (electrical)
<b>0 1 0 1</b>	unallocated-number
<b>0 1 1 0</b>	line-out-of-service
<b>0 1 1 1</b>	send-special-information tone
<b>1 0 0 0</b>	spare
<b>1 0 0 1</b>	spare
<b>1 0 1 0</b>	address-complete, charge
<b>1 0 1 1</b>	address-complete, no charge
<b>1 1 0 0</b>	address-complete, coin-box
<b>1 1 0 1</b>	address-incomplete
<b>1 1 1 0</b>	spare
<b>1 1 1 1</b>	spare

Signal information code **0 0 0 0** indicates that the signal unit is the initial signal unit of a multi-unit message. This facility is reserved for possible future expansion.

### 3.2.3.6 Reserved heading codes

The signal information codes under the heading codes **0 1 0 0 0**, **0 1 0 0 1**, **0 1 0 1 0**, **0 1 0 1 1**, **1 1 1 0 0**, **1 1 1 1 0** and **1 1 1 1 1** are reserved for regional and/or national use.

Signal information code **0 0 0 0** indicates that the signal unit is the initial signal unit of a multi-unit message. This facility is reserved for possible future expansion.

### 3.2.4 Examples of address messages

Examples of address messages are given below to elucidate the formats and codes adopted for address messages. As there is no telephone signal information contained in the check fields of the signal units, these fields are not shown in the examples.

3.2.4.1 *Transit call* from USA (international exchange New York) to the Netherlands (international exchange Amsterdam) via the United Kingdom (transit exchange London).

- Assumptions:
- Semi-automatic traffic, English language.
  - The signalling links New York-London and London-Amsterdam are both associated with their respective speech circuit groups.
  - Speech path New York-London is a satellite circuit equipped with echo suppressors, speech path London-Amsterdam is a cable circuit not equipped with echo suppressors (due to bilateral agreement between the Administrations concerned).
  - Dialed information: 31 2150 43551.
  - *En bloc* operation.

a) *Address message New York-London*

```

1 0 0 0 0 / 0 0 0 0 / 0 0 0 0 1 0 1 / 0 0 1 1
0 0 / 1 1 / 1 1 1 0 0 0 0 0 0 1 0 0 0 0
0 0 / 1 1 / 0 0 1 1 / 0 0 0 1 / 0 0 1 0 / 0 0 0 1
0 0 / 1 1 / 0 1 0 1 / 1 0 1 0 / 0 1 0 0 / 0 0 1 1
0 0 / 1 1 / 0 1 0 1 / 0 1 0 1 / 0 0 0 1 / 1 1 1 1

```

b) *Address message London-Amsterdam*

```

1 0 0 0 0 / 0 0 0 0 / 0 0 0 0 0 0 0 / 1 0 1 0
0 0 / 1 1 / 0 1 0 0 0 0 0 0 1 0 0 0 0 0
0 0 / 1 1 / 0 0 1 0 / 0 0 0 1 / 0 1 0 1 / 1 0 1 0
0 0 / 1 1 / 0 1 0 0 / 0 0 1 1 / 0 1 0 1 / 0 1 0 1
0 0 / 1 1 / 0 0 0 1 / 1 1 1 1 / 0 0 0 0 / 0 0 0 0

```

The intermediate CT London serves as a transit exchange.

3.2.4.2 *Direct call* from the Netherlands (international exchange Amsterdam) to USA (international exchange New York).

- Assumptions:
- Automatic traffic, ordinary subscriber.
  - Speech path Amsterdam-New York is a cable circuit equipped with echo suppressors.
  - Speech circuit group Amsterdam-New York has no associated signalling link. Signal information will be transferred via the two signalling links Amsterdam-London and London-New York in tandem, thus using a quasi-associated mode of operation.
  - Dialed information: 1 201 949 5813.
  - Overlap with subscribers' dialling operation.

a) *Address messages Amsterdam-London*

<pre> 1 0 0 0 0 / 0 0 0 0 / 0 0 1 0 0 0 0 / 1 0 0 1 0 0 / 1 0 / 0 0 1 0 0 0 0 1 0 1 0 0 0 0 0 0 / 1 0 / 0 0 1 0 / 1 0 1 0 / 0 0 0 1 / 1 0 0 1 0 0 / 1 0 / 0 1 0 0 / 1 0 0 1 / 0 0 0 0 / 0 0 0 0 1 0 0 0 1 / 0 1 0 1 / 0 0 1 0 0 0 0 / 1 0 0 1 1 0 0 1 0 / 1 0 0 0 / 0 0 1 0 0 0 0 / 1 0 0 1 1 0 0 1 1 / 0 0 0 1 / 0 0 1 0 0 0 0 / 1 0 0 1 1 0 1 0 0 / 0 0 1 1 / 0 0 1 0 0 0 0 / 1 0 0 1 1 0 1 0 1 / 1 1 1 1 / 0 0 1 0 0 0 0 / 1 0 0 1* </pre>	<p>} Initial address message</p> <ul style="list-style-type: none"> <li>– First subsequent address message</li> <li>– Second subsequent address message</li> <li>– Third subsequent address message</li> <li>– Fourth subsequent address message</li> <li>– Fifth subsequent address message</li> </ul>
---	---

\* ST-signal, sent if the end of the address has been recognized.

b) *Address messages London-New York*

Exactly the same messages are sent as under a).

The London exchange serves as signal transfer point only. It is assumed that by agreement between the Administrations concerned there is no need for a change of label at this signal transfer point.

**Recommendation Q.259**

**3.3      SIGNALLING-SYSTEM-CONTROL SIGNALS**

3.3.1    *General*

The signalling-system-control signals are not related to telephone signal information. They are necessary for the proper functioning of the signalling system.

All signalling-system-control signals specified (see Recommendation Q.255) are transferred by means of lone signal units:

- acknowledgement signal unit,
- synchronization signal unit, and
- system-control signal unit.

3.3.2    *Acknowledgement signal unit (ACU)*

The function of the acknowledgement signal unit (ACU) is described in Recommendation Q.251.

3.3.2.1   *Format of the ACU*

The format of the ACU is given in Figure 8/Q.259.

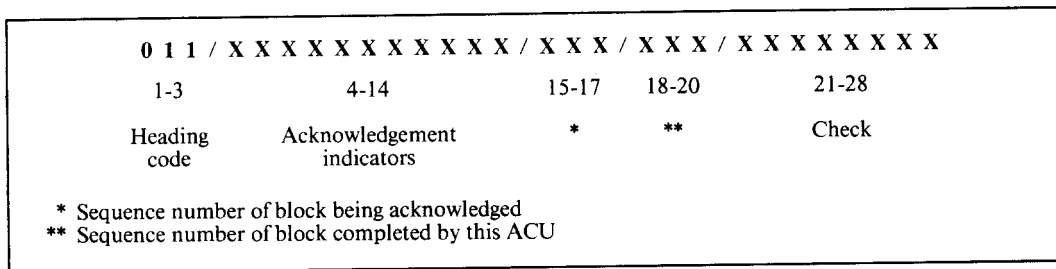

FIGURE 8/Q.259  
**Format of the acknowledgement signal unit**

3.3.2.2   *Codes for the ACU parts*

a)    *Heading*

The heading code **0 1 1** is used.

b)    *Acknowledgement indicators*

The ACU contains 11 acknowledgement indicators to acknowledge sequentially the corresponding eleven signal units of a block received. That is, bit 4 refers to the first signal unit in the block being acknowledged, bit 5 refers to the second, etc. Each indicator will be coded in the following way:

- 0** no error detected,
- 1** error detected.

*The error detected condition* includes signals rejected by the terminal as covered in Recommendations Q.277, Q.278 and Q.293, § 8.6.1.

c)    *Block sequence numbers*

Both the block being acknowledged and the block completed by the ACU are indicated by cyclic sequence numbers from the series **0 0 0, 0 0 1, 0 1 0, 0 1 1, 1 0 0, 1 0 1, 1 1 0, 1 1 1, 0 0 0 ...**

3.3.3 *Synchronization signal unit (SYU)*

The function of the synchronization signal unit (SYU) is described in Recommendation Q.251.

3.3.3.1 *Format of the SYU*

The format of the SYU is given in Figure 9/Q.259.

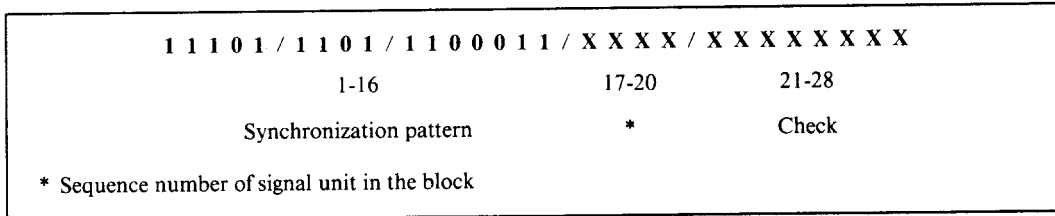

FIGURE 9/Q.259  
**Format of the synchronization signal unit**

3.3.3.2 *Codes for the SYU parts*

a) *Synchronization pattern*

This pattern is coded as: **1 1 1 0 1 1 1 0 1 1 1 0 0 0 1 1**.

The first nine bits of the synchronization pattern may be considered to contain the heading and signal information fields which are coded **1 1 1 0 1** and **1 1 0 1** respectively.

The heading code **1 1 1 0 1** is used for signalling-system-control signals (except ACU) as well as for management signals. The spare signal information codes can be allocated either to system-control signals or to management signals.

b) *Signal unit sequence number*

The sequence number may have any code of the 4-bit binary code **0 0 0 0**, **0 0 0 1**, **0 0 1 0** up to **1 0 1 0** inclusive. The number chosen for a synchronization signal unit is determined by the position of that synchronization signal unit in the block of signal units.

The remaining codes **1 0 1 1** to **1 1 1 1** are not assigned.

3.3.4 *System-control signal units (SCU)*

The function of the system-control signal units is described in Recommendation Q.255.

3.3.4.1 *Format of an SCU*

The format of an SCU is given in Figure 10/Q.259.

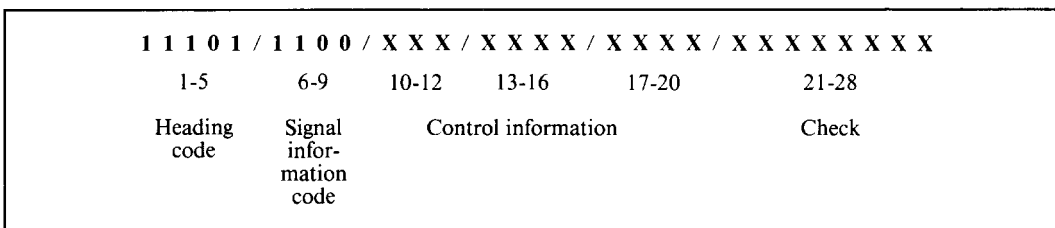

FIGURE 10/Q.259  
**Format of a system-control signal unit**

3.3.4.2 *Codes for the SCU parts*

a) *Heading*

The heading code **1 1 1 0 1** is used.

The heading code **1 1 1 0 1** is used for signalling-system-control signals (except ACU) as well as management signals. The spare signal information codes can be allocated either to system-control signals or to management signals.

b) *Signal information*

The signal information code **1 1 0 0** is used.

c) *Control information*

- bits 10-12 are coded as **0 0 1**. The other codes are spare.
- bits 13-16 are coded as **0 0 0 1**. The other codes are spare.
- bits 17-20 system-control signals, defined in Recommendation Q.255, are coded as follows:

<b>0 0 0 0</b>	spare
<b>0 0 0 1</b>	changeover
<b>0 0 1 0</b>	manual-changeover
<b>0 0 1 1</b>	spare
<b>0 1 0 0</b>	standby-ready
<b>0 1 0 1</b>	spare
<b>0 1 1 0</b>	load-transfer
<b>0 1 1 1</b>	emergency-load-transfer
<b>1 0 0 0</b>	spare
<b>1 0 0 1</b>	spare
<b>1 0 1 0</b>	manual-changeover-acknowledgement
<b>1 0 1 1</b>	spare
<b>1 1 0 0</b>	standby-ready-acknowledgement
<b>1 1 0 1</b>	spare
<b>1 1 1 0</b>	load-transfer-acknowledgement
<b>1 1 1 1</b>	spare

3.3.5 *Multi-block-synchronization signal units (MBS)*

The function of the multi-block-synchronization signal units is described in Recommendation Q.255.

3.3.5.1 *Format of an MBS*

The format of an MBS is given in Figure 11/Q.259.

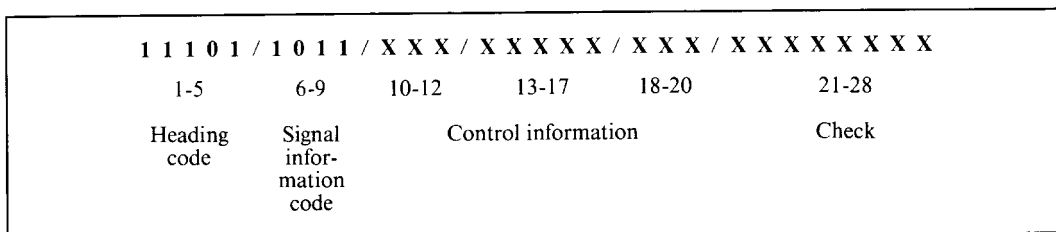

FIGURE 11/Q.259

**Format of a multi-block-synchronization signal unit**

3.3.5.2 *Codes for the multi-block-synchronization signal unit parts*

a) *Heading*

The heading code **1 1 1 0 1** is used.

The heading code **1 1 1 0 1** is used for signalling system control signals (except ACU) as well as management signals. See § 3.3.4.2.

b) *Signal information*

The signal information code **1 0 1 1** is used.

c) *Control information*

– bits 10-12 are coded as follows:

**0 0 0** multi-block monitoring signal

**1 0 0** multi-block acknowledgement signal

The other codes are spare.

- bits 13-17 indicate the sequence number of the multi-block in which the multi-block monitoring signal is sent by a 5-bit binary code from the series **0 0 0 0 0, 0 0 0 0 1, 0 0 0 1 0, . . . , 1 1 1 1 1, 0 0 0 0 0**.
- bits 18-20 indicate the sequence number of the block in which the multi-block monitoring signal is sent (or placed into the output buffer) [see § 3.3.2.2, c) above].

**Recommendation Q.260**

**3.4 MANAGEMENT SIGNALS**

3.4.1 *General*

Management signals may include:

- network-management signals,
- network-maintenance signals,
- signalling-network-management signals,

i.e. signals concerned with the management of the signalling network and of the speech circuit network.

These signals may be transferred by means of one-unit messages or multi-unit messages.

3.4.1.1 *Basic format of management signals*

The basic format of a one-unit management message is shown in Figure 12/Q.260.

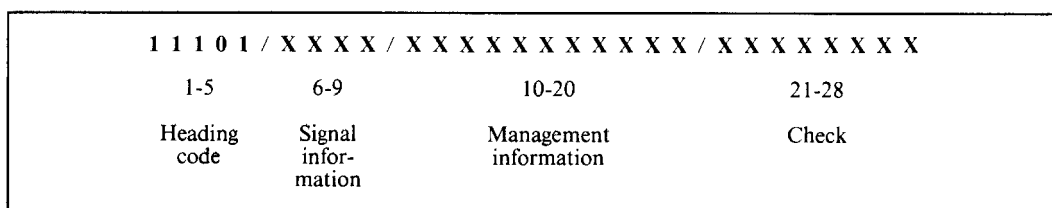

FIGURE 12/Q.260

**Basic Format : a one-unit management message or an initial signal unit of a multi-unit management message**

The management information field, bits 10-20, may be subdivided as required. When a band number is included in the management signal unit, it is placed in bits 10-16.

For some management signals which relate to a group or sub-group of circuits, the band number in bits 10 to 16 and the management information in bits 17-20. This is detailed under the type of signal.

3.4.1.2 *Format of a multi-unit management message*

The format of the initial signal unit of a multi-unit management message is given in Figure 12/Q.260. The use of a special code, **0 0 0 0** in the signal information field (bits 6-9) distinguishes an initial signal unit from a one-unit management message.

The format of a subsequent signal unit of a multi-unit management message is shown in Figure 13/Q.260.

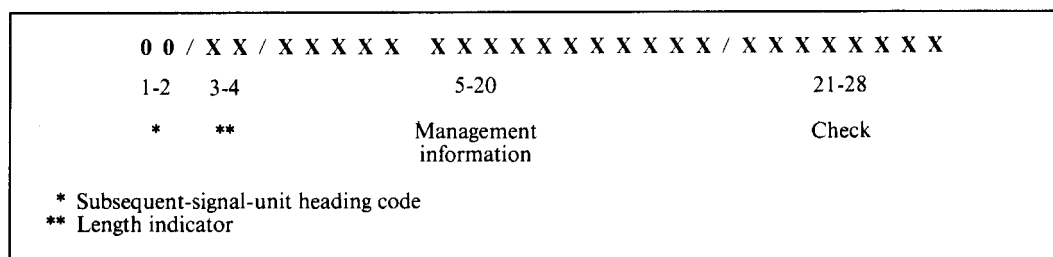

FIGURE 13/Q.260

**Format of a subsequent signal unit of a multi-unit management message**

3.4.1.3 *Codes for management signals*

a) *Heading*

The heading code **1 1 1 0 1** is used for one-unit management messages and for the initial signal unit of a multi-unit management message. The heading code **0 0** is used for subsequent signal units of multi-unit messages.

b) *Signal information*

Signal information codes are assigned as follows:

<b>0 0 0 1</b>	network-management and network-maintenance signal units
<b>0 0 1 0</b>	spare
<b>0 0 1 1</b>	spare
<b>0 1 0 0</b>	spare
<b>0 1 0 1</b>	signalling-network-management signal unit
<b>0 1 1 0</b>	spare (reserved for regional and/or national use)
<b>0 1 1 1</b>	spare (reserved for regional and/or national use)
<b>1 0 0 0</b>	spare
<b>1 0 0 1</b>	spare
<b>1 0 1 0</b>	spare
<b>1 0 1 1</b>	MBS (see Recommendation Q.259)
<b>1 1 0 0</b>	SCU (see Recommendation Q.259)
<b>1 1 0 1</b>	SYU (see Recommendation Q.259)
<b>1 1 1 0</b>	spare (reserved for regional and/or national use)
<b>1 1 1 1</b>	spare (reserved for regional and/or national use)

Signal information code **0 0 0 0** indicates that the signal unit is the initial signal unit of a multi-unit message.

The spare international signal information codes may be assigned to either management signals or signalling-system-control signals.

3.4.2 *Network-management and network-maintenance signals*

3.4.2.1 *Network-management signals*

The heading field is coded **1 1 1 0 1**. Signal information fields are coded **0 0 0 0** for multi-unit management messages and **0 0 0 1** for one unit network-management and network-maintenance signals. Figure 12/Q.260 and Figure 13/Q.260 apply. Multi-unit management messages and corresponding management information are established in three categories:

- 1) destination hard to reach,
- 2) all circuits busy, and
- 3) switching centre congestion.

For coding see § 3.4.2.4 b).

3.4.2.2 *Network maintenance signals*

Network maintenance signals may be sent as one-unit or multi-unit messages under heading code **1 1 1 0 1**.



### 3.4.2.3 Codes for one-unit network-management and network-maintenance signals

#### a) *Heading*

The heading code **1 1 1 0 1** is used.

#### b) *Signal information*

The signal information code **0 0 0 1** is used.

#### c) *Band number*

The band number (bits 10-16) indicates the group or subgroup of circuits to which the signal refers.

#### d) *Management or maintenance information is given in bits 17-20*

<b>0 0 0 0</b>	spare
<b>0 0 0 1</b>	spare
<b>0 0 1 0</b>	spare
<b>0 0 1 1</b>	spare
<b>0 1 0 0</b>	spare
<b>0 1 0 1</b>	spare
<b>0 1 1 0</b>	spare
<b>0 1 1 1</b>	spare
<b>1 0 0 0</b>	spare
<b>1 0 0 1</b>	spare
<b>1 0 1 0</b>	spare
<b>1 0 1 1</b>	spare
<b>1 1 0 0</b>	spare
<b>1 1 0 1</b>	spare
<b>1 1 1 0</b>	reset-band-acknowledgement, all circuits idle
<b>1 1 1 1</b>	reset-band

### 3.4.2.4 Codes used in multi-unit management messages

#### a) *Initial signal unit*

- The five-bit heading code **1 1 1 0 1** is used.
- The signal information code **0 0 0 0** is used.
- The band number is used to designate the group or subgroup of circuits to which the signals apply when appropriate. The remaining bits are used for management or maintenance information.

#### b) *Management information – initial signal unit*

Management or maintenance information is given in bits 17-20.

<b>0 0 0 0</b>	destination hard to reach
<b>0 0 0 1</b>	all circuits busy
<b>0 0 1 0</b>	switching centre congestion
<b>0 0 1 1</b>	spare
<b>0 1 0 0</b>	spare
<b>0 1 0 1</b>	spare
<b>0 1 1 0</b>	spare
<b>0 1 1 1</b>	spare
<b>1 0 0 0</b>	spare
<b>1 0 0 1</b>	spare
<b>1 0 1 0</b>	spare
<b>1 0 1 1</b>	spare
<b>1 1 0 0</b>	spare
<b>1 1 0 1</b>	spare
<b>1 1 1 0</b>	spare
<b>1 1 1 1</b>	reset-band acknowledgement

#### c) *Subsequent signal unit*

- The heading code **0 0** is used.
- The length indicator is coded as appropriate (see Recommendation Q.257, § 3.1.3.4).
- The management information is inserted.

d) *Management information – subsequent signal units*

The format of subsequent signal units is determined by the management information coded in bits 17-20 in b) above.

e) *First subsequent signal unit*

*ISU bits 17-20 Bits 5-20 in first SSU*

*Bits 5-20 in second SSU*

<b>0 0 0 0</b>	<b>XXXX</b>	<b>XXXX</b>	<b>XXXX</b>	<b>XXXX</b>	<b>XXXX</b>	<b>XXXX</b>	<b>XXXX</b>	<b>XXXX</b>	<b>XXXX</b>
	(5-8)	(9-12)	(13-16)	(17-20)	(5-8)	(9-12)	(13-16)	(17-20)	
	ISC	Reason	D1	D2	D3	D4	D5	D6	
	Code								

The digits shown as D1 to D6 represent destination code assignments which can follow address patterns or can be selected by bilateral agreement or both. The "reasons" given in the first SSU, bits (9-12) are:

<b>0 0 0 0</b>	ABR (Answer/Bid Ratio) below arbitrary threshold
<b>0 0 0 1</b>	ABR below high threshold
<b>0 0 1 0</b>	ABR below medium threshold
<b>0 0 1 1</b>	ABR below low threshold
<b>0 1 0 0-1 1 1 1</b>	spare

<b>0 0 0 1</b>	<b>XXXX</b>	<b>XXXX</b>	<b>XXXX</b>	<b>XXXX</b>	<b>XXXX</b>	<b>XXXX</b>	<b>XXXX</b>	<b>XXXX</b>	<b>XXXX</b>
	(5-8)	(9-12)	(13-16)	(17-20)	(5-8)	(9-12)	(13-16)	(17-20)	
	ISC	Reason	D1	D2	D3	D4	D5	D6	
	Code								

Reasons are as follows:

<b>0 0 0 0</b>	all circuits busy threshold exceeded
<b>0 0 0 1</b>	low congestion
<b>0 0 1 0</b>	medium congestion
<b>0 0 1 1</b>	high congestion
<b>0 1 0 0-1 1 1 1</b>	spare

<b>0 0 1 0</b>	<b>XXXX</b>	<b>XXXX</b>	<b>1 1 1 1</b>	<b>1 1 1 1</b>
	(5-8)	(9-12)	(13-16)	(17-20)
	ISC	Reason	Not	Not
	Code		used	used

Reasons are as follows:

<b>0 0 0 0</b>	moderate congestion – level 1
<b>0 0 0 1</b>	serious congestion – level 2
<b>0 0 1 0</b>	unable to process calls – level 3
<b>0 0 1 1-1 1 1 1</b>	spare

<b>0 0 1 1</b>	spare
<b>0 1 0 0</b>	spare
<b>0 1 0 1</b>	spare
<b>0 1 1 0</b>	spare
<b>0 1 1 1</b>	spare
<b>1 0 0 0</b>	spare
<b>1 0 0 1</b>	spare
<b>1 0 1 0</b>	spare

- 1 0 1 1** spare
- 1 1 0 0** spare
- 1 1 0 1** spare
- 1 1 1 0** spare
- 1 1 1 1** circuit status indicators – codes to indicate for each circuit in the band the circuit status. Bit 5 refers to the first circuit, (circuit No. **0 0 0 0**), and so on to bit 20 which refers to circuit No. **1 1 1 1**, the last circuit. Code **0** indicates circuit available for service, **1** circuit should be blocked. However, if all circuits are idle (available), the LSU coding in § 3.4.2.3 d) for "all circuits idle" applies. Also see § 9.5.1.

3.4.3 *Signalling-network-management signals*

3.4.3.1 *Format of a signalling-network-management signal*

The format of a one-unit signalling-network-management message is given in Figure 14/Q.260.

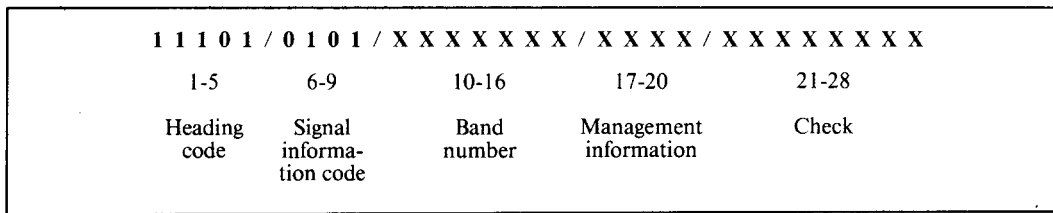

FIGURE 14/Q.260  
**Format of a one-unit signalling-network-management message**

3.4.3.2 *Codes for the signalling network-management signal unit parts*

a) *Heading*

The heading code **1 1 1 0 1** is used.

b) *Signal information*

The signal information code **0 1 0 1** is used.

c) *Band number*

The band number (bits 10-16) indicates the group or sub-group of circuits to which the signal refers (see Recommendation Q.257, § 3.1.3.3).

d) *Management information*

The codes used in the management information field are allocated as follows:

- 0 0 0 0** spare
- 0 0 0 1** spare
- 0 0 1 0** spare
- 0 0 1 1** spare
- 0 1 0 0** spare
- 0 1 0 1** transfer-prohibited
- 0 1 1 0** transfer-allowed
- 0 1 1 1** spare
- 1 0 0 0** transfer-allowed-acknowledgement
- 1 0 0 1** spare
- 1 0 1 0** spare
- 1 0 1 1** spare
- 1 1 0 0** spare
- 1 1 0 1** spare
- 1 1 1 0** spare
- 1 1 1 1** spare

## SECTION 4

### SIGNALLING PROCEDURES

(Including interworking with Signalling Systems No. 4 and No. 5)

#### Recommendation Q.261

##### 4.1 NORMAL CALL SET-UP

###### 4.1.1 *Initial address message*

An initial address message which is sent as the first message of a call set-up generally includes all of the information required by the next international exchange to route the call. The seizing function is implicit in the reception of this initial address message. The format of the initial address message is given in Recommendation Q.258.

The initial address message (IAM) will contain the following signalling information:

- a) country-code indicator,
- b) nature-of-circuit indicator,
- c) echo-suppressor indicator,
- d) calling-party's category,
- e) address signals.

The *country-code indicator* provides information as to whether or not a country code is included in the address signals. It is necessary in System No. 6 as the country code is not sent to the incoming international exchange. This indicator must be translated to the appropriate signal for transmission over succeeding circuits using other signalling systems. Interworking with other systems is specified in the parts of the *Yellow Book* covering those systems.

The *nature-of-circuit indicator* provides information as to whether or not this circuit or any preceding circuit in the connection has traversed a high-altitude satellite, and makes it possible for an international transit exchange to ensure that a second high-altitude circuit is included only in known exceptional circumstances.

The *echo-suppressor indicator* provides information as to whether or not a standard outgoing half-echo suppressor (Recommendation G.161) has been included in the forward direction at a preceding international exchange. Receipt of this signal marked **1** indicates that a standard incoming half-echo suppressor should be included in the backward direction at the last four-wire exchange in the connection. Exceptionally, it is possible for the echo suppressors to be inserted at a point other than the last four-wire exchange on the basis of this signal.

The use of an echo suppressor at an international transit exchange must be by agreement and only in those connections which have been analyzed and where it has been found that the transmission requirements are fulfilled.

Recommendation Q.115 covers the arrangements for control of echo suppressors.

The *calling-party's-category indicator* is used to indicate the type of caller originating the call, e.g. ordinary caller, operator or data caller and may indicate that a special routing is required. The *language and discriminating information* is included in the calling-party's category. It will be necessary to translate the language digit received from an operator in semi-automatic working or a discriminating digit received from a preceding link to the appropriate calling-party's-category code. The language or discriminating information must be translated from the calling-party's-category indicator to the appropriate digit for transmission over a circuit using System No. 4 or System No. 5 in a succeeding link.

The *sending sequence of address information* will be the country code (not sent to an incoming international exchange) followed by the national (significant) number. For calls to code 11 and code 12, refer to Recommendation Q.107.

All digits required for routing the call through the international network will be sent in the *initial address message*. On calls with a country code in the address (except in the case of calls to special operators), the initial address message will contain a minimum of four digits and should contain as many as are available. All digits of the address may be included. In a terminal link, the initial address may contain one digit. Thus, the initial address message could consist of as few as three signal units (one digit) or as many as six signal units. Although 15 digits and ST could be included in a six-unit message, the international numbering plan allows only 12 digits.

Selection of the outgoing national circuit normally can start at the incoming international exchange on receipt of the initial address message and signalling can proceed on the first national link.

*Note* – When interworking towards another signalling system with fewer facilities, it will be necessary to discard some of the signals, e.g. nature-of-circuit indicator and echo-suppressor indicator.

When no echo suppressor or nature-of-circuit indication is received from a preceding circuit using a signalling system with fewer facilities, the indicators will be considered as received *no* unless positive knowledge is available.

#### 4.1.2 *Subsequent address messages*

The remaining digits, if any, of the address may be sent individually in one-unit messages or in groups in multi-unit messages. Efficiency can be gained by grouping together as many digits as possible. However, to prevent an increase in post-dialling delay in those cases where overlap operation with subscribers' dialling is used, it may be desirable to send the last few digits individually. The number of signal units used in a subsequent address message may be from one to four. If the outgoing circuit from an international transit exchange is equipped with System No. 5, any digits received in overlap must be grouped for *en bloc* sending.

Subsequent address messages can be sent on to the national network as they are received. Appropriate measures (e.g. by withholding the last digit(s) of the national number) must be taken at the last common channel exchange, to prevent ringing the called subscriber or alerting the operator until the continuity of the speech circuits served by the common channels has been verified.

The *sequence of address messages* may be disturbed in the event that one or more messages have been retransmitted because of an error. To prevent the assembly of digits in an incorrect sequence, the last System No. 6 or common channel exchange must examine the sequence number included in each address message and reassemble the digits if necessary. In some instances, intermediate common channel exchanges must also resequence address messages; refer to Recommendation Q.262, § 4.2.1.

#### 4.1.3 *End-of-pulsing (ST) signal*

The ST signal is always sent in the following situations:

- a) semi-automatic calls,
- b) test calls, and
- c) when the ST is received from a preceding circuit.

In automatic working, this signal will be sent whenever the outgoing international exchange is in a position to know, by digit analysis, that the final digit has been sent. Digit analysis may consist of an examination of the country code and counting of the maximum (or fixed) number of digits of the national number. In other cases, the ST signal is not sent and the end-of-address information is determined by the receipt of one of the address- complete signals from the incoming international exchange.

#### 4.1.4 *Continuity check of the speech path*

The continuity check is described in § 5. The use of the loop method of continuity checking requires that any echo suppressors in the check loop be disabled. Each System No. 6 exchange must disable any echo suppressor in that exchange, which is required to be active for the speech connection, for the period of attachment of the *continuity-check loop* or *transceiver*.

Each System No. 6 exchange will connect the transceiver to the outgoing speech circuit when the initial address message is sent [see Recommendation Q.271, § 5.7.2, a)].

The first System No. 6 exchange will send forward the *continuity signal* after completion of the following conditions:

- the continuity check performed on the outgoing circuit is completed,
- the speech path across the exchange has been checked and found correct (Recommendation Q.271, § 5.2), and
- if the preceding link is a common link, receipt of a continuity signal from the preceding exchange.

Succeeding intermediate System No. 6 exchanges will send forward the continuity signal after the completion of the three following conditions:

- a continuity signal is received from the preceding link,
- the speech path across the exchange has been checked and found correct (Recommendation Q.271, § 5.2), and
- the continuity check performed on the outgoing circuit is completed.

The speech path may be switched through at an international exchange and the transceiver disconnected after the continuity check of the circuit has been successfully completed. However, the switching through of the speech path should be delayed until the residual check tone has propagated through the return path of the speech circuit. This determination may be made by timing, or by using the check-tone receiver to test for the removal of the check-tone or other appropriate means.

On receipt of the continuity signal in the following international exchange, the continuity-check loop will be removed. Also, any digits of the national number which were withheld may be released (see § 4.1.2 above).

At the System No. 6 exchange, on failure of the outgoing circuit to satisfy the continuity check:

- the continuity-check transceiver will be removed and an automatic repeat attempt will be made on another circuit,
- the outgoing terminal of the faulty circuit will be removed from service,
- a blocking signal will be sent to the following exchange, and
- after receipt of the blocking-acknowledgement signal, a clear-forward release-guard sequence will take place.

A *repeat of the continuity check* of the speech path will be made on the failed outgoing circuit within 1 to 10 seconds of receipt of the release-guard signal.

The second continuity check will be initiated by the System No. 6 exchange detecting the failure, using the test call procedure specified in Recommendation Q.295, § 9.1.1. The address information shall contain the code **0 0 0 0** to notify the incoming exchange that the test call is not to be switched through.

If the repeated check passes on this test call, the speech circuit will be unblocked and returned to service. If the check fails, the maintenance staff will be alerted that a failure has occurred and the circuit has been blocked. The check may be repeated at intervals of 1-3 minutes using the test call procedure. The repeated continuity check procedure will be finished and the circuit unblocked and returned to service when continuity is detected. Each repeated continuity check test call will be terminated using the clear-forward release-guard sequence.

The repeated continuity check test cycle may at any time be inhibited, either manually or automatically, in order to prevent its use in an inappropriate situation.

According to transmission maintenance requirements, System No. 6 should provide for:

- a) a print-out each time a second continuity check is started. In such cases, the circuit involved should be identified;
- b) a print-out each time a continuity check results in a warning being given to maintenance personnel.

Continuity check by means of the test call procedure may be performed at any time as required under the control of the maintenance staff. In these circumstances, although the test call is always terminated by the clear-forward signal, the blocking and unblocking signals are sent only at the discretion of the maintenance staff.

The second continuity check is not performed in the case of check failure in test calls (see Recommendation Q.295, § 9.1.1).

Since a continuity check failure can be caused by a faulty transceiver, precautions should be taken to ensure a low probability of selecting a faulty one for both the initial continuity check and the second check, e.g. by ensuring the selection of a different transceiver for each of the checks.

#### 4.1.5 *Address-complete signals*

The address-complete signals should be originated either in or as close as possible to the called-party's – exchange since they imply that no further electrical called-party's-line-condition signals or congestion signals (see, however, § 4.1.7 below) will be sent. An address-complete signal will not be sent until the continuity signal has been received and the cross-office check made, if applicable.

If the succeeding network does not provide electrical called-party's-line-condition signals, the last No. 6 exchange shall originate and send an address-complete signal when the end of address signalling has been determined:

- a) by receipt of an end-of-pulsing (ST) signal;
- b) by receipt of the maximum number of digits used in the national numbering plan;
- c) by analysis of the national (significant) number to indicate that a sufficient number of digits has been received to route the call to the called party;
- d) by receipt of an end-of-selection signal from the succeeding network (e.g. number received signal in System No. 4); or
- e) exceptionally, if the succeeding network uses overlap pulsing and number analysis is not possible, by observing that 4 to 10 (for new equipment 4 to 6) seconds have elapsed since the last digit was received, and that no fresh information has been received; in such circumstances, transmission to the national network of the last digit received must be prevented until the end of the waiting period which causes an address-complete signal to be sent over the international circuit. In this way, it is ensured that no national answer signal can arrive before an address-complete signal has been sent.

If the succeeding circuit in a connection utilizes System No. 5, the last System No. 6 exchange shall originate and send an address-complete signal whenever the conditions for sending the end-of-pulsing (ST) signal over the No. 5 circuit have been met as specified in Recommendation Q.152.

When the last System No. 6 (common channel) exchange receives an address-complete or equivalent signal, it will release routing and address information from memory and transmit the address-complete signal over the preceding link after receipt of the continuity signal.

If in normal operation delay in the receipt of an address-complete or equivalent signal from the succeeding network is expected, the last common channel exchange will originate and send an address-complete signal 15 to 20 seconds after receiving the latest address message. This time-out condition is an upper limit considering the clauses of 4.8.5.1 a) of Recommendation Q.268 (20 to 30 seconds for outgoing international exchanges in abnormal release conditions).

An intermediate System No. 6 exchange which receives an address-complete signal will release routing and address information from memory and transmit the signal over the preceding link.

On receipt of an address-complete signal, the first System No. 6 exchange will release registers and through-connect the speech path of the interconnected circuit, release address and routing information from memory and transmit the same or an equivalent signal over the preceding link.

When interworking from System No. 4 to System No. 6, the number-received signal will be sent over the System No. 4 link on receipt of the end-of-pulsing signal (ST) from the System No. 4 link or an address-complete signal from the System No. 6 link. However, the number-received signal will also be sent on failure to receive one of those signals within 4 to 6 seconds after reception of the latest digit.

Unless the exchange originating an address-complete signal has the ability to determine that a called number is a coin-box or a no charge number, the address-complete charge signal will be sent.

After an address-complete signal, only the following signals relating to the call may be sent:

- a) in normal operation, one of the answer signals, clear-back or release-guard signals;
- b) call-failure signal (§ 4.8.3 below), message-refusal signal (§ 4.6.2.3 below); or
- c) when interworking with Systems No. 4 and No. 5, one of the congestion signals derived from busy-flash signals (§ 4.1.7 below).

Any further information about the called-party's line condition or congestion will be transmitted to the calling subscriber or operator as audible tones or announcements.

The appropriate address-complete, subscriber-free signal is sent as an alternative to the address-complete signals given above when it is known that the called subscriber's line is free (not busy). It must be originated in the called subscriber's exchange, and therefore cannot be followed by the busy-flash signal. The procedures for handling the address-complete, subscriber-free signals are the same as for the other address-complete signals when generated in the called subscriber's exchange.

#### 4.1.6 *Address-incomplete signal*

The address-incomplete signal is sent whenever it can be determined that the proper number of digits has not been received. This determination can be made at once if the end-of-pulsing (ST) signal is received or by receipt of an address-incomplete signal (or equivalent) from the national network. When overlap working is used, and the end-of-pulsing (ST) signal has not been received, the address-incomplete signal will be sent by the last common channel exchange 15 to 20 seconds after receipt of the latest digit.

If the incoming international exchange has already generated and sent an address-complete signal as described in § 4.1.5 above, and address-incomplete signal received from the succeeding network will be suppressed and the suitable tone or announcement sent.

Each System No. 6 exchange on receipt of the address-incomplete signal will send the signal to the preceding System No. 6 (common channel) exchange, if any, clear forward the connection, and remove the record of the call from memory. The first common channel exchange will send the appropriate tone or announcement, if any, for the national network concerned to the calling party.

#### 4.1.7 *Congestion signals*

The three types of congestion signals are defined in Recommendation Q.254, §§ 2.1.12 to 2.1.14. The congestion signals may be sent without waiting for the completion of the continuity-check sequence. Reception of a congestion signal at any System No. 6 exchange will cause the clear-forward signal to be sent and cause either:

- a) re-routing of the call or an automatic repeat attempt to be made (§ 4.4 below); or
- b) the appropriate attempt signal or the appropriate audible tone or announcement to be sent to the preceding international exchange or to the national network.

Because receipt of congestion signal CGC by an outgoing international exchange may initiate repeat attempt or re-routing, it is possible to transmit congestion signal NNC from international exchanges where repeat attempt or re-routing may be expected to be useless.

If a busy-flash signal is received from a succeeding international link which uses another signalling system, it shall be coded as a circuit-group-congestion signal on System No. 6. Any of the congestion signals from System No. 6 – i.e. switching equipment, circuit group, national network – will be converted to a busy-flash signal for transmission over a preceding link using System No. 4 or System No. 5.

If a signal equivalent to a busy-flash signal is received by an incoming international exchange from a national network, it should be coded as a national-network-congestion signal to be transmitted on System No. 6.

#### 4.1.8 *Called-party's-line-condition signals*

The following signals will be sent when the appropriate electrical signals are received at the incoming international exchange from the national networks:

- subscriber-busy signal (electrical),
- line-out-of-service signal,
- unallocated-number signal,
- send-special-information tone signal.



These signals will be sent without waiting for the completion of the continuity check.

On receipt of one of these signals, the first common channel exchange (or the outgoing international exchange) will clear forward the connection and cause an appropriate indication to be given to the originating subscriber or operator.

Each System No. 6 exchange on receipt of a subscriber-busy, line-out-of-service, unallocated-number or send-special-information tone signal can clear forward the connection. Preceding links using System No. 4 or System No. 5 will be able to transmit only the busy-flash signal. This signal shall be returned when a subscriber busy signal is received. For the other three signals named above, a special information tone shall be applied when interworking with System No. 4 or System No. 5.

#### 4.1.9 *Answer signals*

The signals answer, charge and answer, no charge are sent as received from the national network or from the succeeding international link.

The answer, no charge signal shall be used when:

- a) an answer, no charge signal is received from a succeeding link; or
- b) an answer signal is received and an address-complete, no charge or equivalent signal has been sent to a preceding link.

The answer, no charge signal will be translated to a normal answer signal when the preceding signalling system does not include a no-charge signal, either address-complete, no charge, answer, no charge or equivalent.

The signals answer, charge and answer, no charge are used only as a result of the first off-hook signal from the called party and are priority signals.

#### 4.1.10 *Clear-back signals*

A clear-back signal is sent when the called party clears before a clear-forward signal has been received. A clear-back signal must not disconnect the speech path at a System No. 6 international exchange. The requirements for the release of a connection in the event that a clear-forward signal is not received are given in Recommendation Q.118.

#### 4.1.11 *Reanswer and clear-back sequences*

Subsequent off-hook, on-hook signals from the called party, such as will result from switch-hook flashing, will cause the following sequence of signals to be sent:

Clear-back	No. 1
Reanswer	No. 1
Clear-back	No. 2
Reanswer	No. 2
Clear-back	No. 3
Reanswer	No. 3
Clear-back	No. 1
etc.	

In contrast to the answer signal, the reanswer signal has no special priority. The sequence numbering of the clear-back and reanswer signals makes it possible for the First System No. 6 exchange to reassemble the sequence in proper order in the event that the original sequence is disturbed as a result of retransmission of one or more of the signals. It is necessary, however, that a flashing sequence be retransmitted to the operator (or the preceding link) and that the final condition of the circuit represents the final position of the called party's switch hook. A reanswer signal is transmitted as an answer signal over a preceding link using System No. 4 or System No. 5.

#### 4.1.12 *Forward-transfer signal*

The forward-transfer signal may be sent in semi-automatic working in either of the following two cases:

- a) following a call switched automatically to a subscriber, or following a call established via a special operator, the controlling operator wishes to call in an assistance operator. On receipt of the forward-transfer signal at the incoming international exchange, an assistance operator is called in;
- b) following a call via code 1 1 or code 12, the controlling operator wishes to recall the incoming operator at the incoming international exchange. Receipt of the forward-transfer signal at the incoming international exchange recalls the incoming operator on calls completed via the operator positions at the exchange.

#### 4.1.13 *Clear-forward and release-guard sequence*

The clear-forward signal is overriding and all international exchanges must be in a position to respond by releasing the circuit and sending a release-guard signal at any time during the progress of a call and even if the circuit is in the idle condition. The clear-forward signal is sent only after all equipment has been released, information concerning the call has been released from memory and the circuit is available for a new incoming call. Receipt of a clear-forward signal will cause all associated equipment to be returned to the idle condition and all information concerning the call to be released from memory. If sent while a circuit is blocked, however, it will *not* result in unblocking the circuit concerned (see Recommendation Q.266, § 4.6.1).

The release-guard signal is sent in response to the clear-forward signal, but not until the circuit is available for a new call. The fact that the circuit is blocked will not delay the transmission of the release-guard signal.

#### 4.1.14 *Diagrams showing signal sequence*

The normal call set-up sequences are shown diagrammatically in Annex A to these Specifications.

### **Recommendation Q.262**

#### **4.2 ANALYSIS OF DIGITAL INFORMATION FOR ROUTING**

Refer to Recommendation Q.107 *bis*.

### **Recommendation Q.263**

#### **4.3 DOUBLE SEIZING WITH BOTH-WAY OPERATION**

##### 4.3.1 *Double seizing*

Since System No. 6 circuits have the capability of both-way operation, it is possible that the two exchanges will attempt to seize the same circuit at approximately the same time.

##### 4.3.2 *Unguarded interval*

Considering that with Signalling System No. 6:

- a) circuit propagation time may be relatively long,
- b) the initial address message may consist of up to six signal units,

- c) there may be a significant queueing delay, and
- d) quasi-associated operation may add extra cross-office delay(s),

the unguarded interval during which double seizing can occur may be relatively long in some instances. The exchange must therefore detect double seizing and take action as defined in § 4.3.5.

#### 4.3.3 *Detection of double seizing*

A double seizure is detected by an exchange from the fact that it receives an initial address message for a circuit for which it has sent an initial address message. For detection of a double seizure when out of sequence messages are received, see *Reasonableness check tables*, Annex B to these Specifications.

#### 4.3.4 *Preventive action*

Double seizing is minimized by the use of an opposite order of selection at each terminal exchange of a both-way circuit group. It is necessary to use this method of selection in cases where System No. 6 uses a voice-frequency link with long propagation time.

#### 4.3.5 *Action to be taken on detection of double seizing*

It is expected that each exchange will control one-half of the circuits in a both-way circuit group. On detection of a double seizure, the call being processed by the control exchange<sup>1)</sup> for that circuit will be completed and the received initial address message will be disregarded. Under these conditions, the call being processed by the control exchange will be allowed to complete although the continuity of the circuit may have been checked in the direction from non-control to control only. The call being processed by the non-control exchange will be backed off, switches released, the continuity check transceiver removed, and the check loop connected unless or until a continuity signal has been received from the control exchange. A clear-forward signal will not be sent. The non-control exchange will make an automatic repeat attempt on the same or on an alternative route.

### **Recommendation Q.264**

#### **4.4 POTENTIAL FOR AUTOMATIC REPEAT ATTEMPT AND RE-ROUTING**

##### 4.4.1 *Automatic repeat attempt*

The potential for automatic repeat attempt as defined in Recommendation Q.12 is provided in System No. 6. Backward signals are included to provide information on which to base a decision as to whether or not it would be advantageous to invoke an automatic repeat attempt.

An automatic repeat attempt will be made:

- upon failure of the continuity check (§ 4.1.4 above),
- on receipt of the confusion signal (while setting up a call) (§ 4.7.6.4 below),
- on detection of double seizing (at the non-control exchange) (§ 4.3.5 above),
- in some cases on receipt of a message-refusal signal (§ 4.6.2.3 below), and
- on receipt of a blocking signal after sending an initial address message and before any backward signals have been received (§ 4.6.1 below).

##### 4.4.2 *Automatic repeat attempt and re-routing*

The potential for automatic repeat attempt or re-routing on receipt of the circuit-group-congestion, the switching-equipment-congestion or the call-failure signals is provided.

---

<sup>1)</sup> For the purpose of resolution of double seizing on both-way circuits, a suitable method is that one exchange as determined by bilateral agreement will control *all* circuits with odd-numbered (binary numbers) labels and the other exchange those with even-numbered labels. This designation of control may also be used for maintenance control purposes (see Recommendation M.80).

## Recommendation Q.265

### 4.5 SPEED OF SWITCHING AND SIGNAL TRANSFER IN INTERNATIONAL EXCHANGES

#### 4.5.1 *General*

It is recommended that the equipment in the international exchanges (terminal or transit) shall have a high switching speed so as not to lose the advantage of the high speed of System No. 6.

Although the speech path of circuits served by System No. 6 is not split, the speech path of circuits using in-band line signalling is split during the transmission of line signals (see Recommendation Q.27). To avoid clipping the initial verbal response of the called party, it is necessary to remove splits inserted during transmission of the answer signal as rapidly as possible. Consequently, the answer signal should be transferred across the System No. 6 exchange as rapidly as possible to avoid delaying removal of the splits in any interconnected circuits which utilize in-band line signalling.

The operation of switching devices to attach and disconnect continuity-check equipment must be as rapid as possible to minimize post-dialling delay.

The signals switching-equipment congestion or circuit-group congestion should be returned as soon as practicable following receipt of the information necessary to determine the routing.

#### 4.5.2 *Outgoing international exchange*

At the outgoing international exchange:

- if overlap operation is used, the sending of the initial address message shall take place as soon as sufficient digits are received (normally a minimum of 4) and analyzed to permit the selection of an outgoing circuit;
- if *en bloc* operation is used, the initial address message should be sent as soon as all the digits of the address including the end-of-pulsing (ST) signal are available and the outgoing circuit has been chosen.

#### 4.5.3 *International transit exchange*

At the international transit exchange, the selection of an outgoing circuit should begin as soon as the digits necessary to determine the routing have been received and analyzed.

#### 4.5.4 *Incoming international exchange*

At the incoming international exchange:

- if overlap operation is used in the national network, the setting-up of the national part of the connection should start as soon as a sufficient number of digits has been received for routing;
- if *en bloc* operation is used in the national network, the setting-up of the national part of the connection should start as soon as all of the digits have been received (including signal ST).

## Recommendation Q.266

### 4.6 BLOCKING AND UNBLOCKING SEQUENCES AND CONTROL OF QUASI-ASSOCIATED SIGNALLING

#### 4.6.1 *Blocking and unblocking sequences*

The blocking (unblocking) signal is provided to permit the switching equipment or maintenance personnel to remove from (and return to) traffic the distant terminal of a circuit because of a fault or to permit testing. It is also used in connection with the continuity check of the speech path as described in Recommendation Q.261, § 4.1.4, and in Recommendation Q.271.

Since the circuits served by System No. 6 have both-way capability, the blocking signal can be originated by either exchange. The receipt of the blocking signal will have the effect of prohibiting calls outgoing from that exchange until an unblocking signal is received, but will not in itself prohibit calls incoming to that exchange. Acknowledgement sequences are always required for both the blocking and unblocking signals, using the blocking-acknowledgement signal, and the unblocking-acknowledgement signal, respectively. The acknowledgement is not sent until the appropriate action, either blocking or unblocking, has been taken. The clear-forward signal should not override the blocking signal and return circuits to service which might be faulty. The blocked circuit will be returned to service on transmission of the unblocking-acknowledgement signal at one exchange and on receipt of the unblocking-acknowledgement signal at the other exchange.

In the event of the receipt of a blocking signal:

- after an initial address message has been sent, and
- before a backward signal relating to that call has been received,

an automatic repeat attempt will be made on another circuit. The exchange receiving the blocking signal should clear forward the original attempt in the normal manner after sending the blocking-acknowledgement signal.

If the blocking signal is sent while the speech circuit is engaged on a call and after at least one backward signal relating to that call has been sent, steps will be taken by the exchange receiving the signal to prevent the circuit being seized for subsequent calls outgoing from that exchange.

The fact that the circuit is engaged on a call will not delay transmission of the blocking (unblocking)-acknowledgement signal.

If a blocking signal is sent and subsequently an initial address message is received in the opposite direction, the following action is taken:

- for test calls, the call should be accepted, if possible. In the case where the test call cannot be accepted, the blocking signal must be repeated;
- for calls other than test calls, the blocking signal must be repeated.

Blocking of a circuit by use of the blocking signal should not exceed 5 minutes, after which an alarm should be given at each terminal of the circuit. Should a call be in progress on the circuit involved, the 5 minutes time will commence when that call is cleared. If the work on the circuit must exceed 5 minutes, the circuit should be withdrawn from service by the Circuit Control Station.

#### 4.6.2 *Control of quasi-associated signalling*

##### 4.6.2.1 *Transfer-prohibited signal*

When a signal transfer point is unable to transfer quasi-associated signals for a particular group of circuits, this signal transfer point sends a *transfer-prohibited signal* for each affected band to the exchange or signal transfer point concerned. Since this signal refers to a group of 16 circuits, the band number of the relevant group is sufficient. (See Recommendation Q.260, § 3.4.3.2.)

The transfer-prohibited signal may have the effect at the receiving exchange or signal transfer point of re-routing quasi-associated signals via another signalling path.

##### 4.6.2.2 *Transfer-allowed signal*

When the signal transfer point is once more able to transfer signals, it sends a *transfer-allowed* signal to each exchange or signal transfer point concerned for each band that is allowed. The transfer-allowed signal will have the same band number as the transfer-prohibited signal. Following the transmission of the transfer-allowed signal, the signalling will be restored to the normal route.

On receipt of a transfer-allowed signal, the receiving exchange or signal transfer point will return a *transfer-allowed-acknowledgement* signal, and restore signalling for the circuits assigned to that band.

The signal transfer point will repeat the transfer-allowed signals at periods of 4 to 15 seconds until a transfer-allowed-acknowledgement signal is received. If a transfer-allowed-acknowledgement signal is not received within one minute of sending a transfer-allowed signal, the repetition of the transfer-allowed signal is ceased and maintenance personnel alerted.

### 4.6.2.3 *Message-refusal signal*

If a telephone message is received by a signal transfer point intended for a destination for which the signalling route set has failed, a *message-refusal signal* shall be returned to the exchange or signal transfer point from which this telephone message was received. The message-refusal signal uses the label of the circuit concerned. In addition a transfer-prohibited signal, using the same band number as that of the circuit label, is transmitted after the message-refusal and on the same link set.

On receipt of a message-refusal signal at a signal transfer point, the signal is passed on in the normal way.

On receipt of a message-refusal signal at the terminal exchange of the circuit identified in the label, that exchange will, if possible, retransmit the most recent signal message in memory associated with the affected circuit. In the case of an outgoing call in the process of being established, a clear forward should be sent and an automatic repeat attempt made. The repeated signal or call will be routed in the normal manner, except where a transfer-prohibited signal received from the signal transfer point has already indicated a permanent signalling reconfiguration.

### 4.6.3 *Signalling route set failure*

A signalling route set is considered to have failed when all signalling routes comprising the signalling route set have failed due to link set failure or receipt of transfer prohibited signals on the signalling routes for the band(s) concerned. Where the signalling route set terminates on the originating exchange, all free speech circuits should be removed from service. Where the signalling route set terminates on an STP or exchange acting as STP for the band(s) concerned, transfer prohibited signals should be sent on all signalling routes of the opposite signalling route set [see Recommendation Q.292, § 8.4.4 b)] as specified in § 4.6.2.1.

On restoration of the signalling route set, all free circuits may be returned to service and transfer allowed signals are sent on the opposite signalling route set as specified in § 4.6.2.2.

## **Recommendation Q.267**

### **4.7 UNREASONABLE AND SUPERFLUOUS MESSAGES**

#### 4.7.1 *General*

The characteristics of the common channel signalling system may give rise to irregularities such as:

- *unreasonable messages*, i.e. messages with:
  - an inappropriate signal content,
  - an incorrect signal direction, or
  - an inappropriate place in the signal sequence;
- *superfluous messages*.

#### 4.7.2 *Reasonableness check tables*

In order to resolve ambiguous situations which may arise from these irregularities, special procedures must be defined. These procedures, some of which are mandatory, are included in the reasonableness check tables given in Annex B to these Specifications, which cover all possible stages in the signalling sequences.

The justification for using such tables follows from the dependability requirements in Recommendation Q.276, § 6.6.1.

4.7.3 *Retransmissions and undetected errors*

The following three cases may be considered as examples of the occurrence of unreasonable or superfluous messages:

- in case a signal unit received in error is retransmitted and the next signal unit of the same call is received in advance of the retransmitted signal unit, the signal units are received in reverse order and thus appear unreasonable;
- the incidence of an undetected error may alter the meaning of a signal unit, which then becomes unreasonable,
- in case the acknowledgement for a transmitted signal unit is not received (due to an ACU being received in error or drift compensation), this signal unit may be received twice, so that the second appearance of the signal unit is superfluous.

*Examples:*

a) *Disturbed signal sequence*

When a reanswer signal is received before a clear-back signal is retransmitted owing to a detected error:

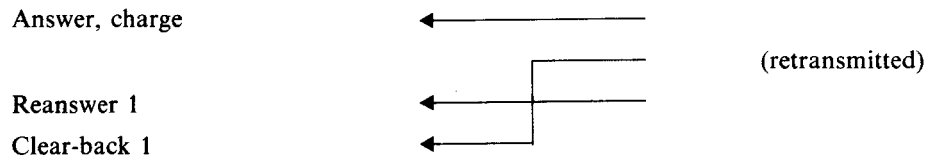

The reanswer signal is conditionally accepted pending receipt of the clear-back signal.

b) *Undetected error*

When a forward-transfer signal is received in an unreasonable place or direction in a call sequence owing to an undetected error:

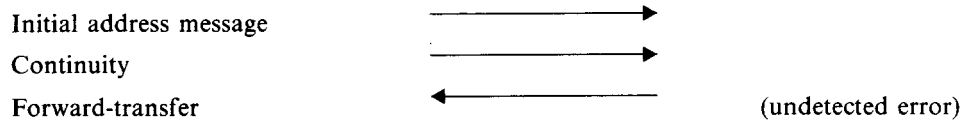

The forward transfer signal is rejected.

c) *Superfluous message*

When two initial address messages are received owing to an ACU being received in error or to drift compensation:

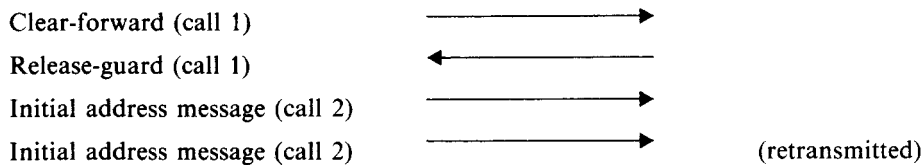

The receipt of two initial address messages would call for the contents to be compared. Should the two be identical, one or the other is discarded.

4.7.4 *Spill-over of messages from one call sequence to another*

In the event of a new call following immediately after the completion of a previous call, there could be a spill-over of messages from the first call to the second, viz. if a signal unit of the first call is received correctly a second time owing to a retransmission. This could lead to ambiguous situations as illustrated in the following examples. The reasonableness check tables given in Annex B to these Specifications contain the procedures for these cases.

Examples:

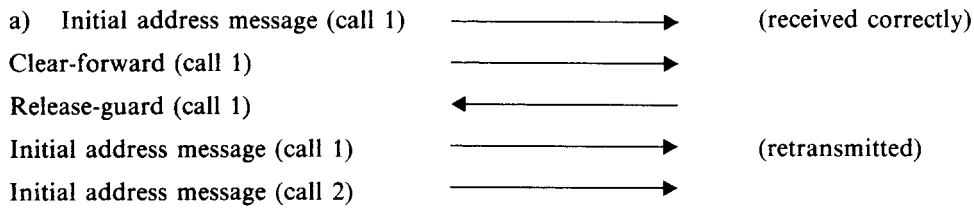

This sequence has a similar appearance to the one arising when an initial address message is received a second time owing to an ACU being received in error or to drift compensation without an intervening clear-forward signal; see example c) in § 4.7.3 above. The contents of the two initial address messages should be compared. Should the two be different, the call can be rejected by sending a *confusion signal* in the backward direction.

On receipt of the confusion signal, the System No. 6 exchange will send a clear-forward signal for the circuit in question, after which an automatic repeat attempt of the call will be made.

b) Another example of a spill-over could occur if an ACU acknowledging a clear-forward signal is received in error and another call is initiated on the circuit just cleared. The sequence would be:

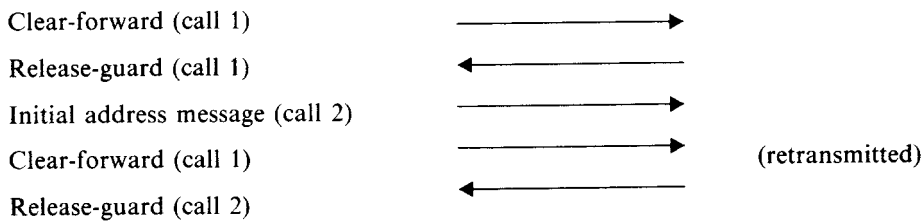

The processor receiving the release-guard signal does not know whether it was generated in response to a retransmitted clear-forward signal or whether it was the result of an incoming undetected error.

In this case, the exchanges disagree as to the state of the circuit (seizure or release) and the specified procedure must be followed to remove the ambiguity.

#### 4.7.5 Other ambiguous situations

Another ambiguous situation could arise for example if, after transmitting a clear-forward signal, an ACU is received in error resulting in the superfluous retransmission of the initial address message. If the latter is followed by a backward signal, for example the congestion signal, the sequence would be:

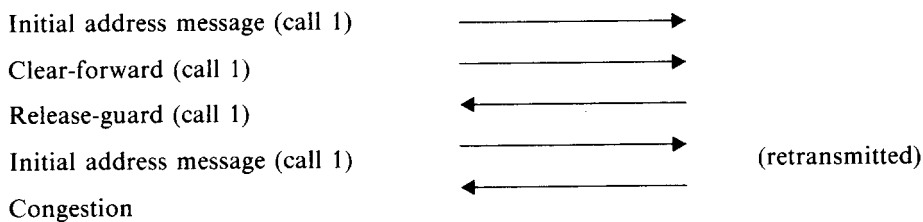

The processor receiving the congestion signal will find the associated circuit in the idle condition and assume the signal to be invalid. The processor at the other end will keep the circuit busy while waiting for the clear-forward signal.

In this case, the exchanges disagree as to the state of the circuit (idle or busy) and the specified procedure must be followed to remove the ambiguity.

#### 4.7.6 Procedures for the treatment of unreasonable and superfluous messages

##### 4.7.6.1 Rejecting

Messages or signal units recognized to be unreasonable or superfluous are discarded.



#### 4.7.6.2 *Waiting*

Unreasonable messages or signal units which may become meaningful at a later stage of the signal sequence are provisionally held. The waiting time should be longer than the retransmission delay of the delayed message. The provisionally-held signal units are processed if the arrival of retransmitted signals within the waiting period makes them meaningful. Otherwise, if they are still meaningless at the end of the waiting period, they are rejected with the exception of the case where the held signal is a clear-forward signal. In this case, the release-guard signal must be sent.

#### 4.7.6.3 *Clearing*

If due to an abnormal signal sequence an ambiguous situation arises, which would result in a circuit being held unduly for a prolonged time, the circuit should be cleared in the normal way.

#### 4.7.6.4 *Sending the confusion signal*

If none of the above procedures is suitable for resolving the situation created by the receipt of an unreasonable message (§ 4.7.1 above), the confusion signal is sent back to the preceding System No. 6 exchange. The confusion signal will not be sent subsequent to sending the address-complete signal or other signal causing the release of address and routing information at the preceding System No. 6 exchange (see § 4.8.1 below).

On receipt of the confusion signal, the preceding System No. 6 exchange will send the clear-forward signal, after which an automatic repeat attempt will be made of the call to be completed as in § 4.7.4, a) above, otherwise the clear-forward signal will be sent.

#### 4.7.7 *Mandatory procedures*

Of the procedures contained in the reasonableness check tables, only those are mandatory which apply to situations in which:

- processors at either end of the link disagree as regards the state of a circuit, or
- cooperation between the processors at either end of the link is required to resolve the ambiguous situation.

Compelled sequences such as clear-forward release-guard must always be completed irrespective of whether the occurrence of the first signal appears reasonable or not.

### **Recommendation Q.268**

## **4.8 RELEASE OF INTERNATIONAL CONNECTIONS AND ASSOCIATED EQUIPMENT**

#### 4.8.1 *Normal release conditions*

Connections are normally released in the forward direction as a result of the receipt of a clear-forward signal from the preceding exchange. In addition, provision is made for the normal release of connections (or circuits) as follows:

- on the continuity check failure: Recommendation Q.261, § 4.1.4,
- on receipt of an address-incomplete signal: Recommendation Q.261, § 4.1.6,
- on receipt of one of the congestion signals: Recommendation Q.261, § 4.1.7,
- on receipt of one of the called-party's-line-condition signals: Recommendation Q.261, § 4.1.8,
- on receipt of the blocking signal after sending an initial address message: Recommendation Q.266, § 4.6.1,
- in some cases, on receipt of the message-refusal signal: Recommendation Q.266, § 4.6.2.3,
- in some cases described under the treatment of unreasonable and superfluous messages: Recommendation Q.267, § 4.7.6.3, and Annex B to these Specifications,
- on receipt of a confusion signal: Recommendation Q.267, § 4.7.6.4.

If the conditions for the normal release of connections as described above are not fulfilled, release is provided as follows:

- in the release under abnormal conditions: § 4.8.5 below,
- on receipt of a call-failure signal: § 4.8.3 below,
- on failure to receive a clear-forward signal after receiving a clear-back signal: Recommendation Q.118, § 4.3.2,
- on failure to receive an answer signal: Recommendation Q.118, § 4.3.1,
- on failure to receive a clear-forward signal after sending a clear-back signal: Recommendation Q.118, § 4.3.3.

Address and routing information are released from memory in each of the exchanges of a connection as described in the following subsections:

#### 4.8.1.1 *Outgoing international exchange*

Address and routing information stored at the outgoing international exchange can be erased on receipt of one of the following backward signals as covered in § 4.1 above:

- a) one of the address-complete signals,
- b) the address-incomplete signal,
- c) one of the congestion signals (unless an automatic repeat attempt is to be made, see § 4.4 above),
- d) one of the called-party's-line-condition signals, or
- e) the answer signal (received out of sequence),

or when the connection is cleared earlier.

#### 4.8.1.2 *Incoming international exchange*

Address and routing information stored at the incoming international exchange can be erased on receipt of one of the above backward signals (or equivalent) from a national common channel system, or when one of the following signals as covered in § 4.1 above has been originated and sent to the outgoing international exchange:

- a) one of the address-complete signals,
- b) address-incomplete signal, or
- c) one of the congestion signals,

or on receipt of a clear-forward signal.

#### 4.8.1.3 *International transit exchange*

Address and routing information stored at an international transit exchange can be erased on receipt of one of the backward signals, § 4.8.1.1, a) to e) above, on receipt of a clear-forward signal, or when one of the congestion signals is originated in that exchange. If the succeeding circuit in the connection utilizes System No. 5, the address and routing information can be released on sending the end-of-pulsing signal (ST) over the System No. 5 circuit as specified in Recommendation Q.152. Whenever one of the backward signals indicating an unsuccessful call is returned, the transit exchange connection and succeeding circuits shall be cleared.

### 4.8.2 *Abnormal release conditions – clear-forward, release-guard sequences*

#### 4.8.2.1 *Inability to release in response to a clear-forward signal*

If an exchange is unable to return the circuit to the idle condition in response to a clear-forward signal, it should remove the circuit from service and send the blocking signal. Upon receipt of the blocking-acknowledgement signal, the release-guard signal is sent in acknowledgement of the original clear-forward signal.

#### 4.8.2.2 *Inability to release in response to a backward signal*

If an exchange is unable to release a circuit in response to an address-incomplete, congestion, called-party's-line-condition, call-failure or confusion signal, it should remove the circuit from service by sending the blocking signal. Upon receipt of the blocking-acknowledgement signal, the clear-forward signal should be sent in reply to the original backward signal.

#### 4.8.2.3 *Failure to receive a release-guard signal in response to a clear-forward signal*

If a release-guard signal is not received in response to a clear-forward signal before 4 to 15 seconds, the clear-forward signal will be repeated.

If, after sending a clear-forward signal, a release-guard signal is not received within a period of one minute after the first clear-forward signal, the maintenance personnel shall be alerted and a reset-circuit signal sent. The reset-circuit signal shall be repeated at one minute intervals until either an acknowledgement is received or maintenance intervention occurs. If there is no provision for sending reset-circuit signals, clear-forward signals shall be used instead.

#### 4.8.3 *Call-failure signal*

The *call-failure signal* is sent as the result of time-out situations described in § 4.8.5 below. The call-failure signal is also sent whenever a call attempt fails and other specific signals do not apply, viz.:

- the confusion signal,
- the address-incomplete signal,
- the congestion signals, or
- the called-party's-line-condition signals.

Reception of the call-failure signal at any No. 6 exchange will cause the clear-forward signal to be sent and:

- a) an automatic repeat attempt to be made, or
- b) the appropriate signal or the appropriate tone or announcement to be sent to the preceding international exchange or to the national network.

The call-failure signal from System No. 6 will be converted to a busy-flash signal for transmission over a preceding link using System No. 4 or System No. 5. If the preceding link uses System No. 6, the call-failure signal is passed back.

#### 4.8.4 *Reset-circuit signal*

In systems which maintain circuit status in memory, there may be occasions when the memory becomes mutilated. In such a case, the circuits must be reset to the idle condition at both exchanges to make them available for new traffic. Since the exchange with the mutilated memory does not know whether the circuit is idle, busy outgoing, busy incoming, blocked, etc., a reset-circuit signal should be sent for each affected circuit. (If complete groups or subgroups of circuits are involved, the reset-band signal sequence described in Recommendation Q.295, § 9.5 should be used.) On receipt of a reset-circuit signal, the unaffected exchange will:

- a) accept the signal as a clear-forward signal and respond by sending a release-guard signal, after the circuit has been made idle, if it is the incoming exchange on a connection in any state of call setup or during a call,
- b) accept the signal as a clear-back or call failure, whichever is appropriate, and respond by sending a clear-forward signal if it is the outgoing exchange on a connection,
- c) accept the signal as a clear-forward signal and respond by sending a release-guard signal if the circuit is in the idle condition,
- d) if it has previously sent a blocking signal, or if it is unable to release the circuit as described above, respond with the blocking signal. If an incoming or outgoing call is in progress, this call should be disconnected and the circuit returned to the idle (blocked) state. A clear-forward or release-guard signal may be sent. The blocking signal should be acknowledged by the affected exchange. If the acknowledgement is not received, the repetition procedure in § 4.8.5.4 should be followed,
- e) if it had previously received a blocking signal, respond by disconnecting any connected call, remove the blocked condition and restore the circuit to the idle state. If an outgoing call had been in progress, respond with a clear-forward signal or, in all other cases, a release-guard signal,

- f) if a reset-circuit signal is received after the sending of an initial address message but before receipt of a backward signal relating to that call, clear the circuit and make a repeat attempt on another circuit if appropriate,
- g) if a reset-circuit signal is received after having sent a reset-circuit signal, respond with a release-guard signal. The circuit should be restored to traffic,
- h) send an appropriate clearing signal on an interconnected circuit (e.g., clear-forward, or a suitable backward signal).

The affected exchange will then reconstruct its memory according to the received acknowledgement to the reset-circuit signal, and respond to this signal in the normal way, i.e. release-guard in response to a clear-forward, blocking-acknowledgement in response to a blocking signal.

In addition, an interconnected circuit may be cleared by the use of an appropriate signal. When both exchanges are arranged to handle reset-circuit signals, if no acknowledgement to the reset-circuit signal is received before 4-15 seconds, the reset-circuit signal should be repeated. If an acknowledgement for the signal is not received within 1 minute after the sending of the initial reset-circuit signal, maintenance personnel should be notified to permit manual restoration procedures. However, the sending of the reset-circuit signal should continue at 1-minute intervals until maintenance intervention occurs.

The use of reset-circuit and reset-band signals is optional. Therefore, in the situation where only one exchange is arranged to handle these signals if no acknowledgement is received before 4-15 seconds, the signalling procedure should be ceased and maintenance personnel notified to facilitate manual restoration of affected circuits. To the extent that selective use of the reset-circuit signals improves recovery from other fault situations, their use for this purpose is permitted. Although the indicated signals are optional, the ability to cooperate with exchanges transmitting them should be regarded as the preferred status.

#### 4.8.5 *Abnormal release conditions – other sequences*

If the conditions for normal release as covered in § 4.8.1 above are not fulfilled, release will take place under the following conditions:

##### 4.8.5.1 *Outgoing international exchange*

An outgoing international exchange shall:

- a) release all equipment and clear forward the connection on failure to meet the conditions for normal release of address and routing information as covered in 4.8.1.1 above before 20 to 30 seconds after sending the latest address message,
- b) release all equipment and clear forward the connection on failure to receive a clear-forward signal from the national network after having received a clear-back signal as provided in Recommendation Q. 118, or
- c) release all equipment and clear forward the connection on failure to receive an answer signal within the interval specified in Recommendation Q.118.

##### 4.8.5.2 *Incoming international exchange*

An incoming international exchange shall:

- a) release all equipment, clear forward the connection into the national network and send back a call-failure signal in the following cases:
  - on failure to receive a continuity signal before 10 to 15 seconds after receipt of the initial address message, or
  - on failure to receive an address-complete or called-party's-line-condition signal from the national network (where expected) before 20 to 30 seconds after receipt of the latest address message, unless the timing for sending the address-incomplete signal (see § 4.1.6 above) is provided, or

- b) send the call-failure signal on failure to receive a clear-forward signal for the incoming circuit before 4 to 15 seconds after sending an address-incomplete, congestion, call-failure, confusion signal or a called-party's-line-condition signal indicating inability to complete the call. If a clear-forward signal is not received within a period of one minute after sending the call-failure signal, the maintenance personnel shall be alerted and a reset-circuit signal sent. The reset-circuit signal shall be repeated at one minute intervals until either an acknowledgement is received or maintenance intervention occurs. If there is no provision for sending reset-circuit signals, call-failure signals shall be used instead;
- c) release all equipment and clear forward the connection on failure to receive a clear-forward signal after having sent a clear-back signal as provided in Recommendation Q. 118.

#### 4.8.5.3 *International transit exchange*

An international transit exchange shall:

- a) release all equipment, clear forward the connection and send back the call-failure signal in the following cases:
  - on failure to receive a continuity signal before 10 to 15 seconds after receipt of the initial address message, or
  - on failure to meet the conditions for normal release as covered in § 4.8.1.3 above, before 20 to 30 seconds after sending the latest address message, or
- b) send the call-failure signal on failure to receive a clear-forward signal for the incoming circuit before 4 to 15 seconds after sending an address-incomplete, congestion, call-failure, or confusion signal or a called-party's-line-condition signal indicating inability to complete the call. If a clear-forward signal is not received within a period of one minute after sending the call-failure signal, the maintenance personnel shall be alerted and a reset-circuit signal sent. The reset-circuit signal shall be repeated at one minute intervals until either an acknowledgement is received or maintenance intervention occurs. If there is no provision for sending reset-circuit signals, call-failure signals shall be used instead.

#### 4.8.5.4 *Failure in the blocking/unblocking sequences*

An international exchange shall repeat the blocking or unblocking signal on failure to receive an acknowledgement signal in response to either the blocking or unblocking signals before 4 to 15 seconds. (See § 4.6.1 above for the blocking/unblocking sequence). If an acknowledgement signal is not received within a period of 1 minute after sending the initial blocking or unblocking signal, maintenance personnel should be alerted, and optionally the blocking or unblocking signal sent and repeated at one minute intervals until either an acknowledgement is received or maintenance intervention occurs.

## SECTION 5

### CONTINUITY CHECK OF THE SPEECH PATH

#### Recommendation Q.271

#### 5.1 GENERAL

Because the signalling in System No. 6 does not pass over the speech path, facilities should be provided for making a continuity check of the speech path prior to the commencement of conversation. The check is not intended to eliminate the need for routine testing of the transmission path.

This specification relates only to that part of an international connection served by Signalling System No. 6. The part of the speech path to be checked may include a TASI circuit.

As the presence of active echo suppressors in the circuit would interfere with the continuity check, it is necessary to disable the suppressors during the check and to re-enable them, if required, after the check has been completed.

#### 5.2 RELIABILITY OF THE SPEECH PATH ACROSS THE EXCHANGE

Administrations shall ensure the reliability of a connection through a switching machine (cross-office check) either on a per call basis or by a statistical method. With either method, the probability of the connection being established with an unacceptable speech path, transmission quality should not exceed  $10^{-5}$  as the long-term average.

#### 5.3 CONTINUITY CHECK OF THE SPEECH CIRCUIT BETWEEN EXCHANGES

The continuity check of the speech circuit will be done, link-by-link, on a per call basis prior to the commencement of conversation. The loop checking method used is specified in the following sections.

#### 5.4 LOOP CHECKING METHOD

The continuity check transceiver (check-tone transmitter and receiver) is connected to the GO and RETURN paths of the outgoing circuit at the first and each succeeding exchange, excluding the last exchange, in that part of the international connection served by Signalling System No. 6. The check loop should be connected to the GO and RETURN paths of the incoming circuit at each exchange except the first in that part of the international connection served by Signalling System No. 6. A continuity check is considered successful when a tone is sent on the GO path and is received on the RETURN path within acceptable transmission and timing limits.

#### 5.5 TRANSMISSION REQUIREMENTS FOR THE CONTINUITY CHECK

##### 5.5.1 *Transmitting equipment*

The check-tone frequency will be  $2000 \pm 20$  Hz.

The sending level of the check tone will be  $-12 \pm 1$  dBm0.

### 5.5.2 *Check loop*

The check loop will have a loss of 0 dB, taking into account any difference between the relative levels of the two paths at the point of attachment.

### 5.5.3 *Receiving equipment*

The check-tone receiver will have the following characteristics:

#### 5.5.3.1 *Operating requirements*

Signal frequency:  $2000 \pm 30$  Hz

Signal level range: The absolute power level  $N$  of the check tone shall be within the limits

$$(-18 + n) \leq N \leq (-6 + n) \text{ dBm}$$

where  $n$  is the relative power level at the receiver input

Recognition time: 30 to 60 ms

The frequency and level range tolerances allow for variations at the sending end and for variations in line transmission that are considered acceptable.

#### 5.5.3.2 *Non-operating requirements*

Signal frequency: outside the frequency band  $2000 \pm 200$  Hz

Signal level: below or equal to  $-22 + n$  dBm0

The limit is 10 dB below the nominal absolute level of the check tone at the input of the receiver. If the level fails below this point, transmission is considered unacceptable.

Signal duration: shorter than 30 ms

The level range of  $(-18 + n) \leq N \leq (-6 + n)$  dBm will serve as a GO/NO-GO check on the links in that part of the international connection served by Signalling System No. 6.

#### 5.5.3.3 *Release requirements*

If the receiver is used to test for the removal of check tone (see Recommendation Q.261, § 4.1.4):

- after recognition of tone, interruptions of up to 15 ms shall be ignored; this will prevent switching through the speech path prematurely;
- the indication of tone removal should not be delayed more than 40 ms; and
- the release level of the receiver should be lower than  $-27 + n$  dBm.

## 5.6 CONTINUITY SIGNAL

The procedure for sending the continuity signal is given in Recommendation Q.261, § 4.1.4.

## 5.7 TIMING CONSIDERATIONS FOR THE CONTINUITY CHECK

### 5.7.1 *Time-out period of the continuity check*

The continuity check is considered to have failed if the receiver has not responded within a period determined by the Administration concerned. This period should not exceed 2 seconds.

The time-out period of the continuity check should always exceed the continuity recognition time,  $T_{CR}$ , given by:

$$T_{CR} = 2 T_p + T_{IAM} + T_{TC} + T_L + T_R - T_T$$

where:  $T_p$  = one-way propagation time of the speech circuit and the signalling link (where they are the same),  
 $T_{TC}$  = TASI clip time for two TASI systems in series (for connections not using TASI,  $T_{TC} = 0$ ),  
 $T_R$  = receiver response time,  
 $T_L$  = loop connecting time (maximum),  
 $T_T$  = transceiver connecting time (minimum),  
 $T_{IAM}$  = emission time of the longest initial address message.

If retransmission of an IAM is to be included in  $T_{CR}$ , the following formula may be used:

$$T_{CR} = 4T_p + 2T_{IAM} + T_{ACU} + T_x + T_y + T_L + T_R - T_T$$

where:  $T_{ACU}$  = emission time of an ACU (length of an ACU),  
 $T_x$  = time between receiving an IAM and emitting an ACU,  
 $T_y$  = time between receiving an ACU and emitting an initial address message.

#### 5.7.2 *Switching times of continuity check equipment*

The connection and disconnection of the equipment used for the continuity check and also the disabling and subsequent enabling of echo suppressors should be related to the following stages of progress in the establishment of the connection:

- a) *Preparation at System No. 6 exchange applying the transceiver.* – Action should be initiated at the termination of the handling time  $T_h$  of the initial address message, i.e. when it is inserted in the output buffer and is available for emission.
- b) *Preparation at System No. 6 exchange connecting the check loop.* – Action should be initiated at the moment of recognition of the initial address message received.
- c) *Disconnection at System No. 6 exchange connecting the check loop.* – Action follows the receipt of the continuity signal or the clear-forward signal, or the emission of signals indicating that the call cannot be established, e.g. circuit-group congestion signal.
- d) *Disconnection at System No. 6 exchange applying the transceiver.* – Action should be initiated on the successful completion or the failure of the continuity check. Exceptionally, if disconnection has not previously occurred action should be initiated at the moment of recognition of the address-complete signals, the answer signals, signals indicating that the call cannot be established, or on the emission of a clear-forward signal.

It is recommended that the mean time, both for the connection and for the disconnection, be less than 100 ms. A mean time of 200 ms should not be exceeded. See Recommendation Q.261.



## SECTION 6

### SIGNALLING LINK

#### Recommendation Q.272

#### 6.1 REQUIREMENTS FOR THE SIGNALLING DATA LINK

##### 6.1.1 *General*

a) The signalling data link may be either an analogue signalling data link (§ 6.1.1.1 below) or a digital signalling data link (§ 6.1.1.2 below).

b) System No. 6 is capable of operating over signalling data links with the longest loop propagation time visualized (see also § 6.7.3 below).

c) To reduce the possibility of the called party being distorted or clipped, the propagation time of the signalling data link should be as low as possible and should not be significantly greater than that of any speech circuits with which it is associated.

d) The signalling data link shall be dedicated to the use of a System No. 6 signalling link between two points, the only switching to be provided being that required for the security arrangements (see Recommendation Q.292).

e) A means must be furnished for disabling the echo suppressors which might be associated with the circuits used for the signalling data links. Disabling must be accomplished by local action by the processor at each terminal.

##### 6.1.1.1 *Analogue signalling data link*

The analogue signalling data link shall be made up of standard international voice-frequency channels, either 3-kHz or 4-kHz spaced, and associated modems. The overall transmission characteristics of the voice-frequency channels must be equalized if necessary to meet the recommendations of § 6.1.3 below.

##### 6.1.1.2 *Digital signalling data link*

The digital signalling data link shall be derived from the 1544 kbit/s (Recommendation Q.47) or 2048 kbit/s (Recommendation Q.46) primary multiplex equipment and includes the appropriate digital interface adaptor.

##### 6.1.2 *Error rate characteristics of the data channel*

##### 6.1.2.1 *Analogue data channel*

The data transmitted at 2400 bits per second with four-phase PSK (*phase shift keying*) modulation over a data channel as specified should meet a long-term bit error rate of less than 1 in  $10^5$  in normal operation (see Recommendation Q.295, § 9.2.7). This figure excludes interruptions exceeding 350 ms in length.

##### 6.1.2.2 *Digital data channel*

The data transmitted at permitted data rates over digital data channels as specified should meet a long term bit error rate of less than 1 in  $10^6$  in normal operation (see Recommendation Q.295, § 9.2.7). This figure excludes interruptions exceeding 350 ms in length.

##### 6.1.3 *Transmission characteristics of the voice-frequency channel*

The transmission characteristics of the voice-frequency channels used in the signalling data link are based on those in Recommendation M.761.

However, for the System No. 6 data rate and modulation method, Recommendation M.761 offers some latitude in the selection of channels. The equalization for attenuation distortion and delay distortion of the channels can be restricted to the frequency band 1000 to 2600 Hz (see Figures 15/Q.272 and 16/Q.272).

a) *Overall loss at 800 Hz.* – The overall loss at 800 Hz of the channels of a transfer link is not specified.

The channels of a transfer link should be set up so that when a test signal at a level of –10 dBm0 is connected to the input of the transfer channel, the level received at the output of the transfer channel at the distant end is as close as possible to – 10 dBm0.

b) *Variation of overall loss at 800 Hz.* – The variation with time overall loss at 800 Hz should be as small as possible but should not exceed the following limits:

Short-term variation (over a period of a few seconds) ..... ± 3 dB

Long-term variation (over long periods including daily and seasonal variations)..... ± 4 dB

c) *Attenuation/frequency distortion.* – The variation of the overall loss of the channel with frequency over the range of 1000 to 2600 Hz relative to the attenuation at 800 Hz should not exceed the limits shown in Figure 15/Q.272.

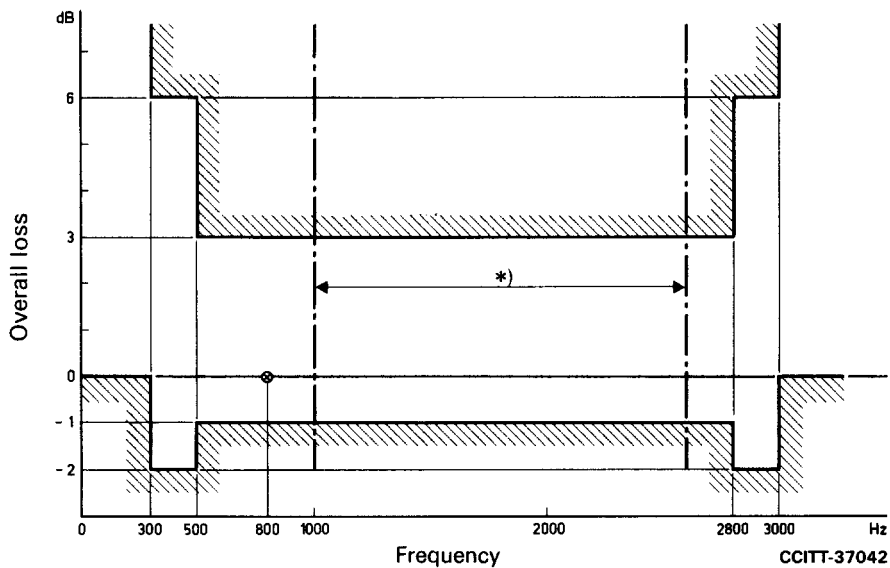

\* Frequency band with defined characteristics for Signalling System No. 6.

Note 1 – Alternative relaxed limits are shown in Annex A to Recommendation Q.272.

Note 2 – Below 300 Hz and above 3000 Hz the loss shall not be less than 0.0 dB but is otherwise unspecified.

FIGURE 15/Q.272  
Limits for overall loss of the transfer link relative to that at reference frequency

d) *Delay/frequency distortion.* – The delay/frequency distortion in the band of frequencies from 1000 to 2600 Hz relative in that band should not exceed the limits given in Figure 16/Q.272. It may be necessary to select channels and/or provide suitable delay distortion equalizers to ensure that these limits are not exceeded.

Where the full-time reserved link is a TASI speech circuit taken into use for signalling purposes, this characteristic may not be met unless all TASI channels in the route meet the transmission requirements specified above. In addition, it may be necessary to restrict the number of 3-kHz-spaced channels used in a signalling data link.

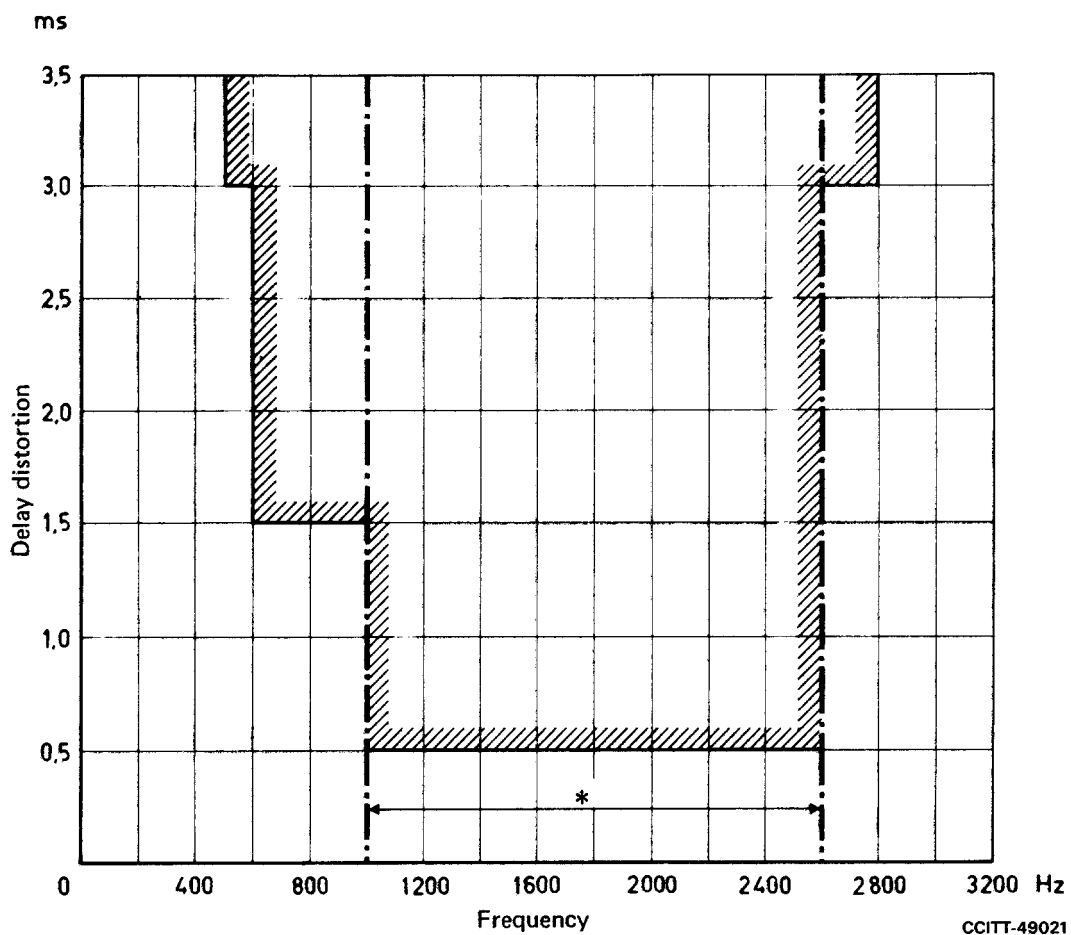

\* Frequency band with defined characteristics for Signalling System No. 6. The tolerance scheme is taken from Recommendation M.1020.

*Note* – The limits shown in this Figure are under study. Proposed changes are shown in Annex A to Recommendation Q.272.

FIGURE 16/Q.272  
Permissible variation of overall delay distortion with frequency  
for the voice-frequency channel

e) *Uniform spectrum random circuit noise.* – See Recommendation M.761, particularly the note to Recommendation M.761, § 2.6.

f) *Impulse noise.* – Impulsive noise on the voice-frequency channel should not exceed 18 peaks in 15 minutes, greater than  $-21$  dBm0. Measurements should be made during peak hours.

According to Recommendation M.761, impulsive noise should be measured with an instrument complying with Recommendation O.71. The value given above is a provisional limit for maintenance purposes; final values are still under study.

#### 6.1.4 Nominal data carrier power level

The nominal data carrier power level is  $-15$  dBm0 (see Recommendation Q.15).

Recommendations H.41 and V.2 allow a power level of  $-10$  dBm0 when no more than 5% of the channels in a multichannel system are used for non-speech applications simultaneously in both directions. If the percentage of channels in this type of service is considerably more than 5%, the power should be reduced. Recommendation Q.15 allows a mean absolute power level of  $-15$  dBm0.

### 6.1.5 *Slip characteristics of the digital data channel*

The occurrence of slips adversely affects the service dependability of the signalling system. Means must be provided for

- a) preventing slips from occurring, e.g., by use of synchronization or by use of a contra-directional interface, or
- b) detecting slips, or
- c) providing accurate clocks to reduce the occurrence of undetected slips.

Although a means can be provided to detect slips, in general each slip that occurs will cause a signal unit to be received in error. When using a slip detecting mechanism, the slip rate must be such that the dependability requirements of Recommendation Q.276, § 6.6.1 are still met (see also Recommendation Q.276, § 6.8.3).

#### 6.1.5.1 *The 1544 kbit/s primary multiplex*

Provisionally, the need for a slip requirement is not foreseen.

#### 6.1.5.2 *The 2048 kbit/s primary multiplex*

- a) 4 kbit/s signalling rate

The coding for deriving the 4 kbit/s channel from the 64 kbit/s bearer is designed so that slips are always detected and the true data recovered.

- b) 56 kbit/s signalling rate

The coding for deriving the 56 kbit/s channel from the 64 kbit/s bearer may be used to detect slips. Provisionally an undetected slip rate not exceeding once in 16 days is required.

ANNEX A

(to Recommendation Q.272)

Proposed changes presently under study

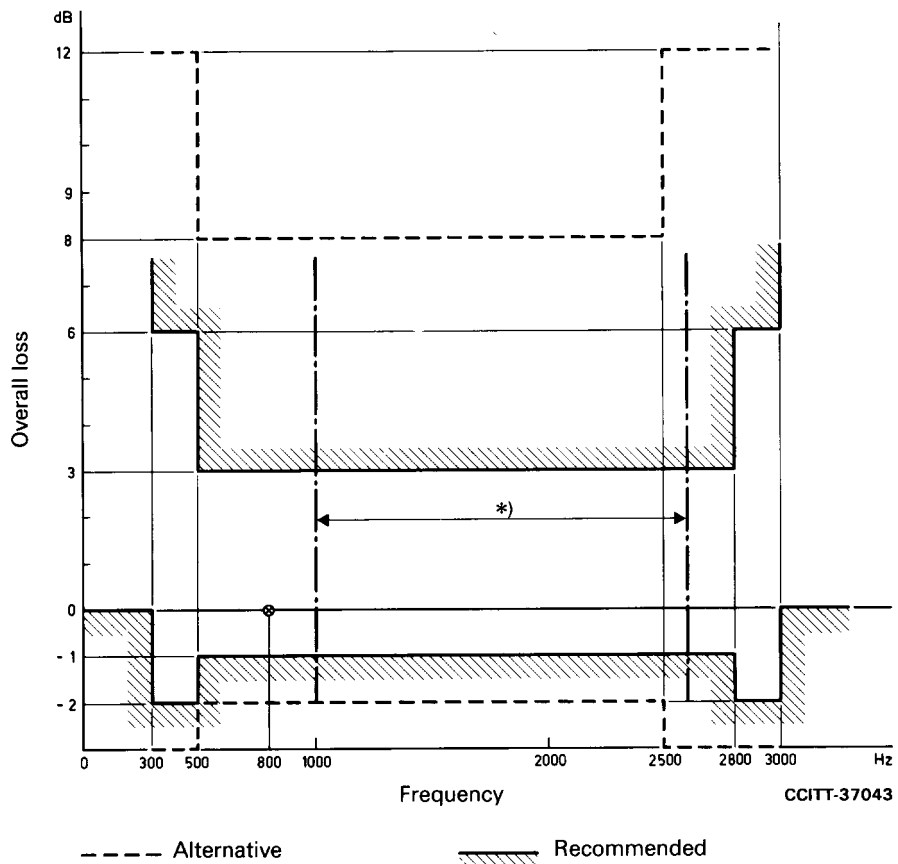

\* Frequency band with defined characteristics for Signalling System No. 6.

*Note* – Below 300 Hz and above 3000 Hz the loss shall not be less than 0.0 dB but is otherwise unspecified.

FIGURE 15

**Limits for overall loss of the transfer link  
relative to that at reference frequency  
(Alternative if tests confirm suitability)**

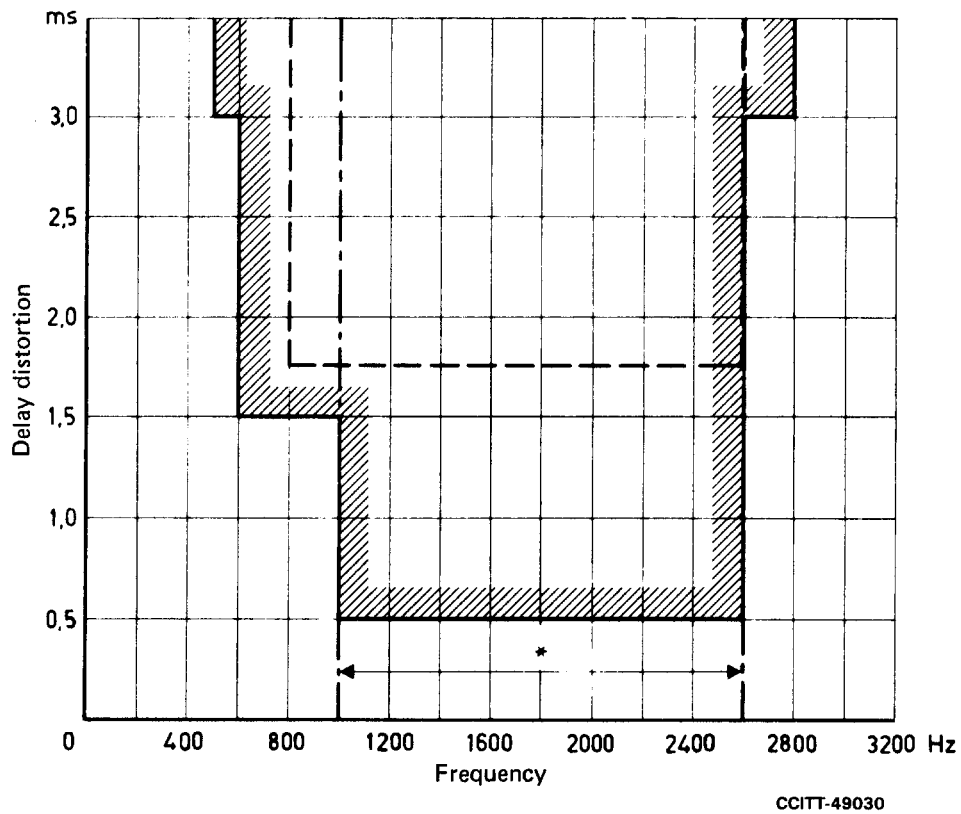

CCITT-49030

— — — Alternative       Recommended

\* Frequency Band with defined characteristics for Signalling System No. 6.

FIGURE 16  
**Permissible variation of overall delay distortion with frequency  
for the voice-frequency channel  
(Alternative if tests confirm suitability)**

**Recommendation Q.273**

**6.2 DATA TRANSMISSION RATE**

6.2.1 *Analogue data channel rate*

The preferred data transmission rate on analogue channels is 2400 bit/s.

6.2.2 *Digital data channel rates*

The preferred data transmission rate on digital channels is 4 kbit/s for both the 1544 kbit/s and 2048 kbit/s international digital multiplexes. In addition, the rate of 56 kbit/s may be used with the 2048 kbit/s international digital multiplex.

## Recommendation Q.274

### 6.3 TRANSMISSION METHODS

#### 6.3.1 *Analogue modulation methods*

The modulation technique described in this Recommendation uses *phase shift keying* to transmit serial binary data over analogue telephone channels. The binary data signal is encoded by first grouping it into bit pairs (dibits). Each dibit is represented by one of four possible carrier phase shifts. Thus, the output from the phase modulator consists of a serial train of phase-shifted carrier pulses at half the data bit rate. The phase shift between two consecutive modulation elements contains the information to be transmitted.

The data receiver uses differentially coherent detection to recover the sense of the binary data from the line signal. This type of detection has proven to be relatively insensitive to the types of distortions and interference encountered on telephone-type transmission media. It also allows rapid recovery from such catastrophic impairments as dropouts and large phase hits.

Receiver timing recovery can be accomplished in several ways. A very rapid timing recovery scheme can be provided using certain properties of the transmitted spectrum.

Receiver timing information can also be extracted from the zero crossings, on a dibit basis, of the received baseband data signals. The latter method is capable of providing synchronization holdover through extended drop-outs and periods of high noise.

#### 6.3.2 *Digital transmission methods*

The methods used to derive the 4 and 56 kbit/s digital channels from the 1544 and 2048 kbit/s primary multiplexes are described below.

##### 6.3.2.1 *Derivation from the 1544 kbit/s primary multiplex*

The binary data from the signalling terminal is transferred serially at the data transmission rate of 4 kbit/s to the 1544 kbit/s primary multiplex. At the primary multiplex each bit of the data stream is successively inserted into the S bit position (see Recommendation Q.47, § 4.1).

In the receive direction the primary multiplex extracts the bits from the S-bit position and transfers them serially to the signalling terminal.

##### 6.3.2.2 *Derivation from the 2048 kbit/s primary multiplex*

a) *Data transmission at 4 kbit/s rate.* – The binary data from the signalling terminal is transferred serially to the digital interface adaptor. At the digital interface adaptor the 4 kbit/s data stream is modulated on a 64 kbit/s bearer channel such that 16 bits of the bearer channel correspond to one bit of the 4 kbit/s channel. The 64 kbit/s data stream is transferred serially to the 2048 kbit/s primary multiplex in alignment with an 8 kHz clock (byte timing). At the primary multiplex the 16 bits corresponding to one signalling information bit are inserted into the designated channel time slot of two successive frames.

In the receive direction the primary multiplex extracts the bits from the designated channel time slot and transfers them serially at 64 kbit/s in alignment with an 8 kHz clock to the digital interface adaptor. At the digital interface adaptor the 16 bits corresponding to one signalling information bit are detected and the binary data is transferred serially to the signalling terminal at the data transmission rate of 4 kbit/s.

b) *Data transmission at 56 kbit/s rate.* – The binary data from the signalling terminal is transferred serially to the digital interface adaptor. At the digital interface adaptor, the 28 bits of a signal unit are placed in bit positions 1 to 7 of four 8 bit bytes [see also § 6.4.2.4 c) below]. These four bytes are transferred serially at the data transmission rate of 64 kbit/s to the 2048 kbit/s primary multiplex in alignment with an 8 kHz clock (byte timing). At the primary multiplex, the four bytes are inserted into the designated channel time slot of four successive frames.

In the receive direction the primary multiplex extracts the bits from the designated channel time slot and transfers them serially at the data transmission rate of 64 kbit/s to the digital interface adaptor in alignment with an 8 kHz clock. In the digital interface adaptor the bits 1 to 7 of each 8 bit byte are transferred serially to the signalling terminal at the data transmission rate of 56 kbit/s.

## 6.4 MODEM AND INTERFACE REQUIREMENTS

### 6.4.1 *Analogue modem requirements*

The requirements for a 2400 bits per second modem are given below.

#### 6.4.1.1 *Principal requirements*

The principal requirements of a modem used for System No. 6 are as follows:

- a) Use of differential four-phase modulation (see Recommendation V.26, alternative B);
- b) Use of differential coherent 4-phase demodulation;
- c) Full duplex operation over a 4-wire data link;
- d) A modulation rate of 1200 bauds;
- e) A bit rate of 2400 bits per second.

#### 6.4.1.2 *Frequency requirements*

- a) The basic timing frequency shall be 2400 Hz (one cycle per bit);
- b) The carrier frequency shall be 1800 Hz;
- c) The carrier envelope frequency shall be 600 Hz (see § 6.4.1.4 below);
- d) All frequencies generated in the modem shall be stable to within  $\pm 0.005\%$  of the nominal value. They must have a constant phase relationship with respect to one another. This implies that all frequencies should be derived from a basic clock or that they be phase-locked.

#### 6.4.1.3 *Encoding phase relationships*

The encoding phase relationship must be as follows:

Dibit	Phase change
<b>0 0</b>	+ 45°
<b>0 1</b>	+ 135°
<b>1 1</b>	+ 225°
<b>1 0</b>	+ 315°

The phase change is the actual on-line phase shift in the transition region from the end of one signalling element to the beginning of the following signalling element.

#### 6.4.1.4 *Line signal envelope*

The data carrier pulse shape can be closely approximated by the following expression for a signal element centred at  $t = 0$  (see Figure 17/Q.274):

$$\text{Envelope } (t) = \frac{\cos \frac{2\pi f_d \cdot t}{2} - \cos \frac{2\pi f_d \cdot \frac{3}{4} T}{2}}{1 - \cos \frac{2\pi f_d \cdot \frac{3}{4} T}{2}}$$

$$\text{for } -\frac{3}{4} T \leq t \leq \frac{3}{4} T$$

$$\text{and } \text{Envelope } (t) = 0 \text{ for } -T \leq t \leq -\frac{3}{4} T \text{ and } \frac{3}{4} T \leq t \leq T$$

where  $f_d$  = the dibit rate of 1200 Hz,

and  $T$  = the dibit period of 1/1200 s.



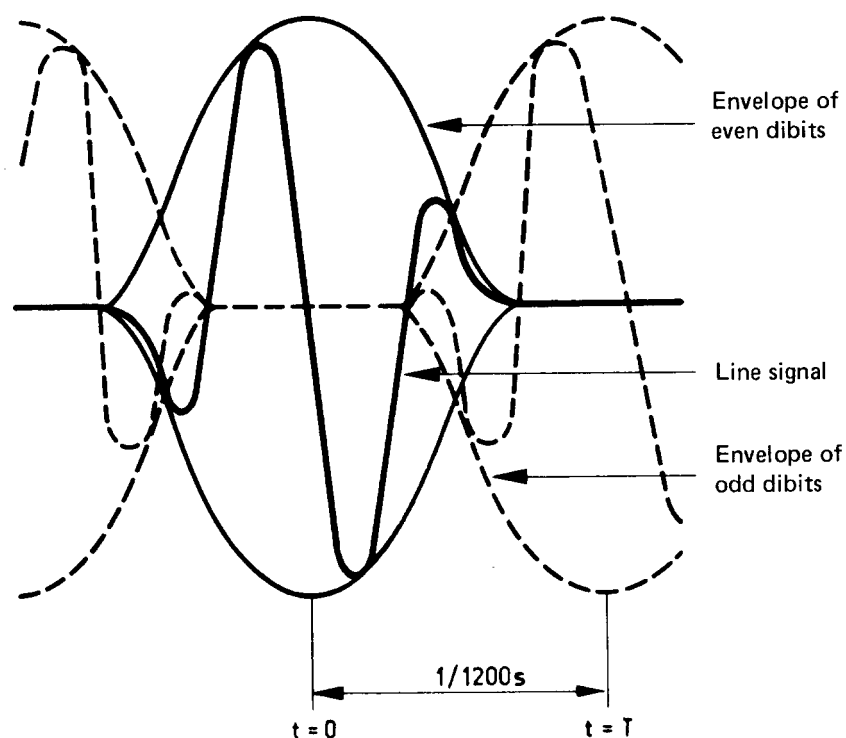

CCITT-49040

FIGURE 17/Q.274  
Composite line signal

#### 6.4.1.5 Line power spectrum

The line power spectrum produced by the transmission of random data is shown in Figure 18/Q.274. The spectral lines produced by the transmission of repeated dibits (using the encoding phase relationship of § 6.4.1.3 above) are also shown.

#### 6.4.1.6 Transmitter requirements

- a) The transmitter output level shall be  $-15 \pm 1$  dBm0 (see also Recommendation Q.272, § 6.1.4).
- b) In the data transmitter, the bit timing and carrier frequency are derived from the same source to facilitate receiver timing recovery.

#### 6.4.1.7 Receiver requirements

- a) The receiver sensitivity range shall be  $-15 \pm 8$  dBm0 [see § 6.4.1.6 above and Recommendation Q.272, § 6.1.3 b)].
- b) The modem receiver shall be capable of establishing bit synchronization as fast as possible, but in any case within 150 milliseconds while receiving synchronization signal units.
- c) The receiver shall maintain bit synchronization with the distant transmitter for at least 500 milliseconds during a loss of data carrier after initial bit synchronization has been established.

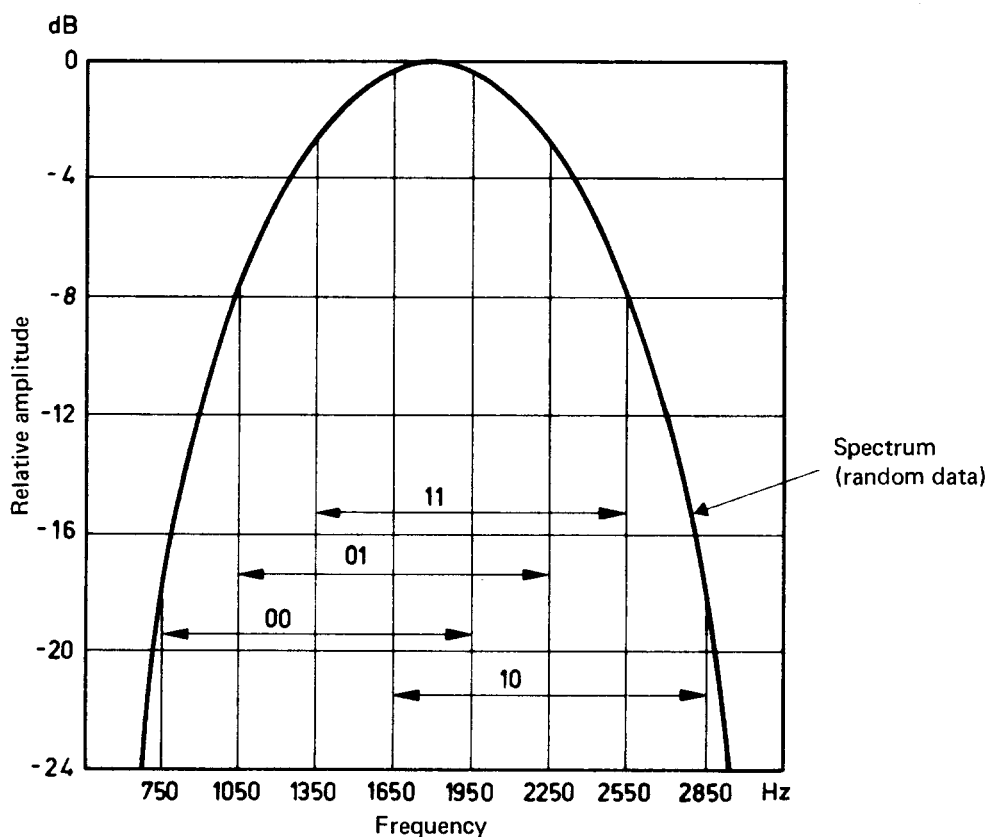

CCITT-49050

FIGURE 18/Q.274  
Line power spectrum

#### 6.4.1.8 Interface requirements<sup>1)</sup>

Each Administration may at its discretion integrate the modem into the signalling terminal equipment or use a separate modem. If the modem is a separate unit, then the interface requirements of Recommendations V.24/V.28 should be followed as far as possible. Alternatively the interface requirements of § 6.4.2.3 below may be followed.

The transmitting and receiving signalling terminals derive timing from the timing frequency of the modem transmitter and receiver respectively.

#### 6.4.2 Digital interface requirements

##### 6.4.2.1 General

a) The interface between the signalling terminal and primary multiplex equipment can be functionally represented as shown in Figures 19/Q.274, 20/Q.274 and 21/Q.274. See also Recommendation G.703.

b) The interface adaptor functions are rate conversion of data where required, rate and/or direction conversion of clocks where required, generation of a receive holdover clock and transfer of a loss of frame alignment indication.

c) The receive holdover clock must maintain bit synchronism for at least 500 ms during data channel failure at all data rates after initial bit synchronization has been established.

d) The transmit and receive clock signals shall be in phase with the respective data signals.

<sup>1)</sup> The interface requirements for the digital version can be followed for the analogue version. This admits the use of a universal signalling terminal.

6.4.2.2 Interface and adaptor requirements

a) *The 4 kbit/s data transmission rate, 1544 kbit/s primary multiplex.* – The interface and adaptor functions for the 4 kbit/s data transmission rate over a 1544 kbit/s primary multiplex are shown in Figure 19/Q.274. The diagram is intended to show functions and should not be construed as depicting equipment.

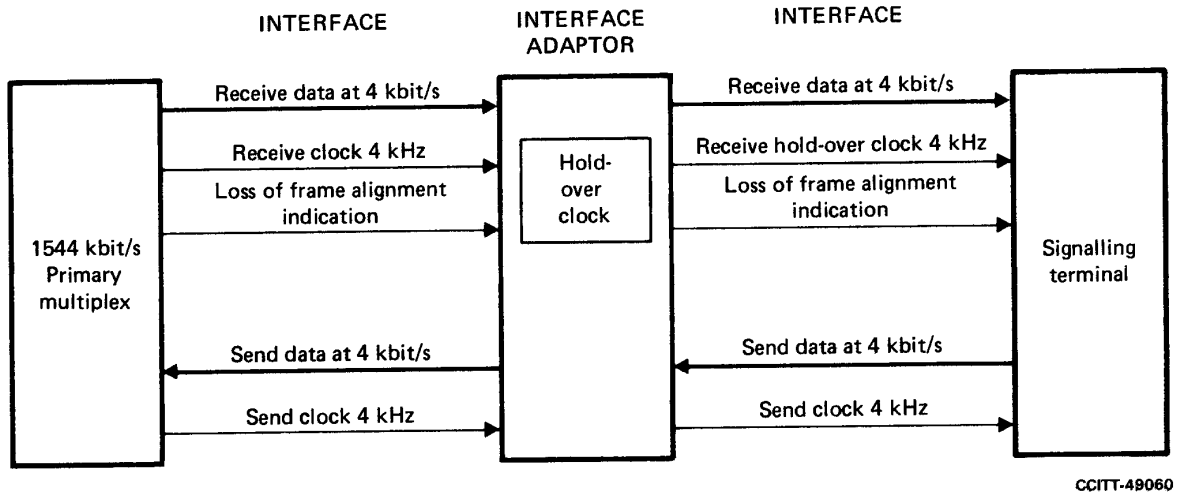

FIGURE 19/Q.274  
Interface and adaptor functions, 4-kbit/s, 1544-kbit/s primary multiplex

The interface adaptor is transparent to the send and receive data and to a loss of frame alignment indication. Data channel failure is covered in § 6.5.

A holdover function on the 4 kHz receive clock to the signalling terminal is provided to maintain bit synchronism for a minimum interval during which the receive clock is not present.

b) *The 4 kbit/s data transmission rate, 2048 kbit/s primary multiplex.* – The interface and adaptor functions for the 4 kbit/s data transmission rate over a 2048 kbit/s primary multiplex are shown in Figure 20/Q.274. The diagram is intended to show functions and should not be construed as depicting equipment.

The receive-rate converter converts the receive data on the 64 kbit/s bearer channel to receive data at 4 kbit/s using the 8 kHz and 64 kHz receive clocks. The 4 kHz receive clock is derived in the receive clock converter.

The send rate converter converts the send data at 4 kbit/s to send data on the 64 kbit/s digital bearer channel using the 8 kHz and 64 kHz send clocks. The 4 kHz send clock is derived in the send clock converter.<sup>2)</sup>

The interface adaptor is transparent to a loss of frame alignment information. A holdover function on the 4 kHz receive clock to the signalling terminal is provided to maintain bit synchronism for a minimum interval during which the receive clock is not present. Data channel failure is covered in § 6.5 below.

c) *The 56 kbit/s data transmission rate, 2048 kbit/s primary multiplex.* – The interface and adaptor functions for the 56 kbit/s data transmission rate over a 2048 kbit/s primary multiplex are shown in Figure 21/Q.274. The diagram is intended to show functions and should not be construed as depicting equipment.

<sup>2)</sup> This material is subject to revision pending results of further work by Study Group XVIII.

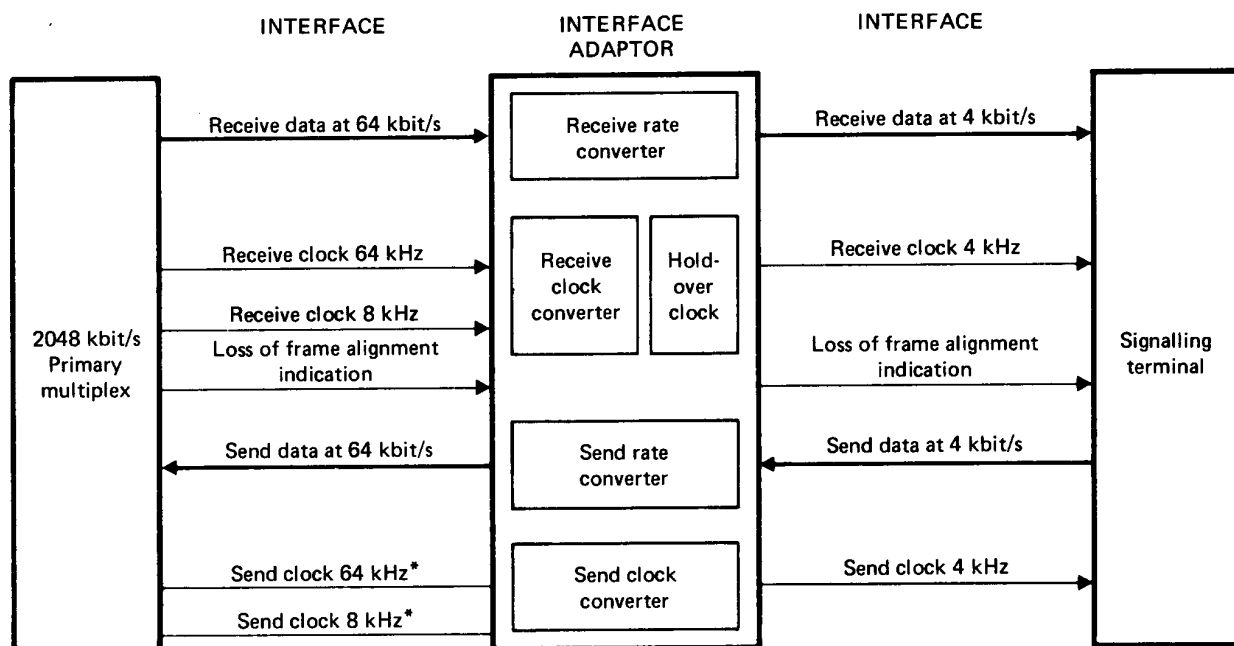

CCITT-49070

\*The direction of the 64 kHz and 8 kHz clocks between the 2048 kbit/s primary multiplex and interface adaptor in Figures 20/Q.274 and 21/Q.274 are dependent on whether a codirectional or contra-directional interface is used.

FIGURE 20/Q.274  
Interface and adaptor functions, 4 kbit/s, 2048 kbit/s primary multiplex

The interface adaptor is transparent to the send and receive data and to a loss of frame alignment indication. Data channel failure is covered in § 6.5 below.<sup>3)</sup>

The send data at 56 and 64 kbit/s is aligned with the 8 kHz send clock. Similarly, the receive data is aligned with the 8 kHz receive clock.

A holdover function on the receive clock to the signalling terminal is provided to maintain bit synchronism for a minimum interval during which the receive clock is not present.

#### 6.4.2.3 Interface electrical requirements<sup>3)</sup>

Interface electrical requirements are given in Recommendation G.732 and Recommendation G.733, for the interface between the primary multiplex and the interface adaptor. Arrangements for the interface between the interface adaptor and the signalling terminal are left to the discretion of Administrations.

Each Administration may at its discretion integrate the interface adaptor into the signalling terminal or the primary multiplex equipment or may use a separate interface adaptor. If the interface adaptor is a separate unit then the interface electrical requirements above must be met. If it is integrated into either the signalling terminal equipment or the multiplex equipment the remaining interface must meet the interface electrical requirements.

<sup>3)</sup> This material is subject to revision pending results of further work by Study Group XVIII.

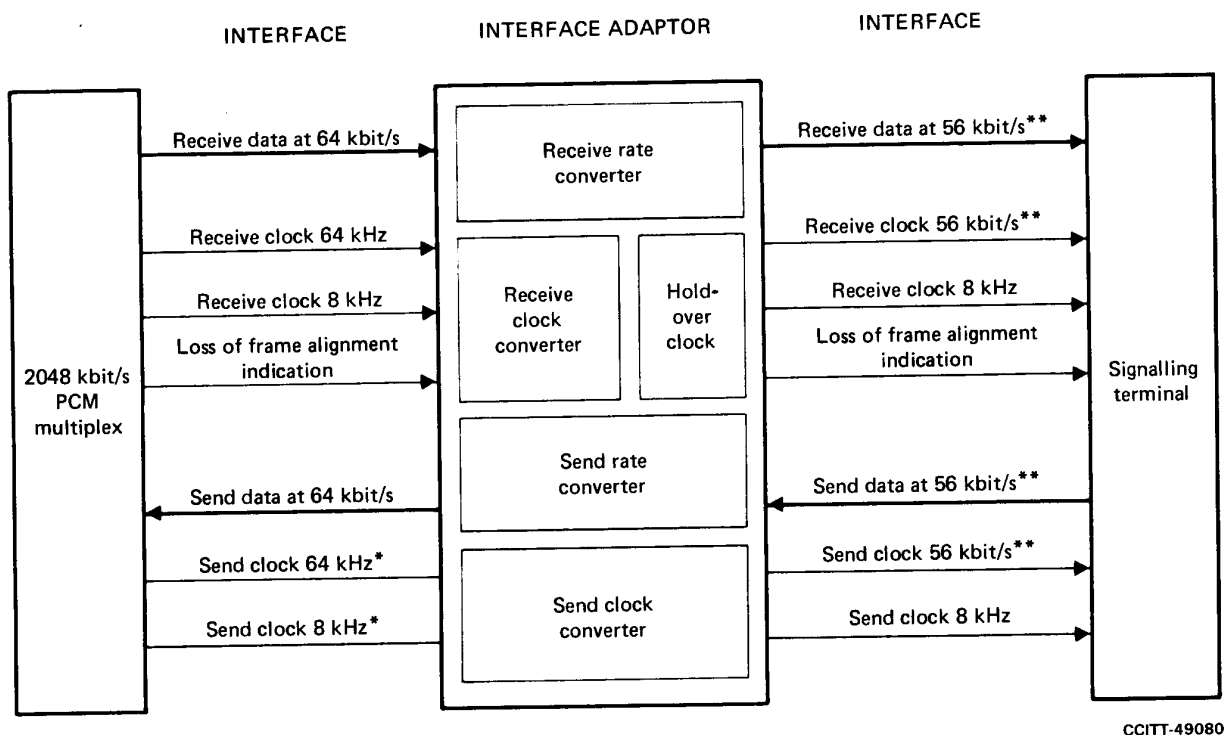

\* The direction of the 64 kHz and 8 kHz clocks between the 2048 kbit/s primary multiplex and interface adaptor in Figures 20/Q.274 and 21/Q.274 are dependent on whether a codirectional or contra-directional interface is used.

\*\* The nature of the 56 kbit/s data and the 56 kbit/s clocks between the interface adaptor and the signalling terminal is left to the discretion of each Administration. The clocks may be at 56 kHz with the data arriving at a smooth rate or the clocks may be at 64 kHz with every eighth bit deleted and the seven data bits occurring at a 64 kbit/s rate with every eighth bit discarded.

FIGURE 21/Q.274  
Interface and adaptor functions, 56-kbit/s, 2048-kbit/s primary multiplex

#### 6.4.2.4 Interface adaptor electrical requirements

- a) *The 1544 kbit/s primary multiplex, 4 kbit/s channel*

The send and receive data and the send clock signals traverse the interface adaptor without modification.

The receive clock and the data channel failure information are separated in the interface adaptor. The receive clock from the primary multiplex synchronizes the receive holdover clock. The holdover clock provides the receive clock to the signalling terminal. The interface adaptor recognizes data channel failure by the absence of the receive clock from the primary multiplex. This information is separately transferred to the signalling terminal.

The receive holdover clock should:

- maintain bit synchronism for at least 500 ms after initial bit synchronism is established, and
- have a tolerance of  $\pm 70$  parts per million when the receive clock is not present.

- b) *The 2048 kbit/s primary multiplex, 4 kbit/s channel*

Each bit of the 4 kbit/s data is represented by two channel-time-slots in the transmitted 64 kbit/s stream. These sixteen bits are encoded by the send-rate converter according to Table 4/Q.274. The 8 bit bytes are aligned with the 8 kHz clock.

TABLE 4/Q.274

**4-kbit/s channel encoding for 2048 kbit/s  
primary multiplex**

Binary figure	Bit position	Encoded transmission	
1	odd	<b>00111100</b>	<b>00111100</b>
1	even	<b>11000011</b>	<b>11000011</b>
0	odd	<b>01100110</b>	<b>01100110</b>
0	even	<b>10011001</b>	<b>10011001</b>

Transmission of the data in this form makes it possible to detect and correct for single, channel-time-slot slip avoiding the loss of signalling data. This is achieved in the receiver-rate converter as follows. The 64 kbit/s data stream is collected into 8 bit bytes using the 8 kHz clock, and each byte is decoded. The reception of three consecutive bytes of the same code indicates that channel-time-slot duplication has occurred, and that a half cycle delay must be introduced into the 4 kHz receive clock, whereas reception of a single byte with a given code followed by a byte with a code signifying a different bit position, indicates that omission of a channel-time-slot has occurred and that the 4 kHz clock must be advanced by half a cycle.

The send clock at 4 kHz is derived directly from the 64 kHz and 8 kHz send clocks. The 4 kHz receive clock is derived from the 64 kHz and 8 kHz receive clocks, but it must be adjustable to take account of channel-time-slot slip detected in the receive rate converter. The receive holdover clock provides the receive clock to the signalling terminal. The interface adaptor recognizes loss of frame alignment by the absence of the 8 kHz clock from the primary multiplex or by an indication transmitted from the primary multiplex over a separate connection. <sup>4)</sup> This information is separately transferred to the signalling terminal.

The receive holdover clock should:

- maintain bit synchronism for at least 500 ms after initial bit synchronism is established, and
- have a tolerance of  $\pm 70$  parts per million when the receive clocks are not present.

c) *The 2048 kbit/s primary multiplex, 56 kbit/s channel*

The send and receive data and the send clock signals traverse the interface adaptor without modification.<sup>4)</sup>

The 28 bits of a signal unit are represented by bit positions 1 to 7 of four consecutive channel time slots in the 64 kbit/s stream transmitted from or received at the interface adaptor. Bit position 8 of consecutive octets is coded **0, 0, 1, 1, 0, 0, 1, 1, ...** in a continuing sequence. This pattern is not suitable for direct transmission to the 1544 kbit/s multiplex.<sup>4)</sup>

The receive holdover clock should:

- maintain channel-time-slot synchronism for at least 500 ms after initial synchronism is established, and
- have a tolerance of  $\pm 50$  parts per million when the receive clocks are not present.

---

<sup>4)</sup> This material is subject to revision pending results of further work by Study Group XVIII.

## Recommendation Q.275

### 6.5 DATA CHANNEL FAILURE DETECTION

#### 6.5.1 General

Detection of data channel failure is required to supplement the eight-bit cyclic code. In case of unsatisfactory data transmission conditions a data channel failure indication should be given to the terminal for use in the error control equipment (see Recommendation Q.277, § 6.7.2).

#### 6.5.2 Detector requirements

##### 6.5.2.1 Data channel failure detector – analogue version

In this case the data channel failure detector is known as the *data carrier failure detector*.

a) The data carrier failure detector is required to indicate failure when transmission becomes unsatisfactory because of decreased carrier level. A failure should be indicated when the received carrier is below the minimum sensitivity of the modem used, and should indicate no failure when the level is above -23 dBm0.

b) The detector is required to detect the loss of carrier even though the decrease in carrier power may be accompanied by an increase in noise power. If a signal guard technique is used to distinguish carrier power from noise power, the received spectrum from 300 Hz to 500 Hz should be used to detect the amount of noise power.

c) The indication of failure or re-establishment of carrier should have a nominal delay of 5 ms with limits of 4 ms minimum and 8 ms maximum.

##### 6.5.2.2 Data channel failure detector – digital version

In the case of both the 1544 kbit/s and the 2048 kbit/s primary multiplexes, the data channel failure detector is known as the *loss of frame alignment detector*.

a) The loss of frame alignment detector is required to indicate when the digital multiplex has lost frame alignment.

b) The indication of loss or re-establishment of frame alignment should have a mean delay of 2 ms or less after the PCM equipment has detected the loss or re-establishment of frame alignment.

#### 6.5.3 Interface

In the case of the 1544 kbit/s primary multiplex, data-channel failure is electrically indicated by inhibiting the 4 kHz receive clock.

In the case of the 2048 kbit/s primary multiplex, loss of frame alignment is electrically indicated by inhibiting the 8 kHz receive clock or by an indication transmitted from the primary multiplex over a separate connection.

## Recommendation Q.276

### 6.6 SERVICE DEPENDABILITY

#### 6.6.1 Dependability requirements

The following dependability requirements should be obtained with signalling links having the error rate characteristics as described in Recommendation Q.272, § 6.1.2. These requirements refer to each signalling link.

a) Signal units which carry telephone signal information and which are delayed as a consequence of correction by retransmission:

*not more than one in  $10^4$  such signal units to be delayed as a long-term average.*

b) Signal units of any type which give rise to wrongly-accepted signals due to undetected errors and causing false operation (e.g., false clear-back signal):

*not more than one error in  $10^8$  of all signal units transmitted.*

c) As in item b) but causing serious false operation (e.g., false metering or false clearing of connection):

*not more than one error in  $10^{10}$  of all signal units transmitted.*

d) Interruption to the signalling service (including both normal and reserve links):

- interruption of duration between 2 seconds and 2 minutes – not more than once a year;
- interruption of duration exceeding 2 minutes – not more than once in 10 years.

Items a), b) and c) assume one telephone signal per signal unit. Results for a multi-unit message will be at least comparable to those for one-unit messages transmitting the same information.

#### 6.6.2 *Retransmission considerations*

The requirement of § 6.6.1 a) above is inserted to limit the percentage of the answer signals which are delayed through the retransmission process. The amount of retransmission depends on the number of bits in the signal units and on interferences such as those caused by short interruptions and intermittent bursts of noise up to the point at which changeover to the reserve link occurs.

#### 6.6.3 *Service interruption considerations*

The requirement of § 6.6.1 d) depends largely on the performance of the voice frequency links or digital links assigned for signalling. Therefore precautions should be taken in the design stage of the terminal equipment to ensure that the contribution to the total is relatively small.

### **Recommendation Q.277**

## **6.7 ERROR CONTROL**

### 6.7.1 *Error detection by the use of check bits*

The disturbance of a signal unit during transmission will be detected by the use of coders and decoders, connected at the transmitting and receiving terminals respectively. The coder will generate 8 check bits based on the polynomial  $X^8 + X^2 + X + 1$  (see Table 5/Q.277 for the matrix and for a typical implementation).

These check bits will constitute bits 21-28 of each signal unit and are inverted before transmission to provide protection against a single bit-slip of synchronization.

When the decoder at the receiving terminal has received all 28 bits of a signal unit after the check bits have been reinverted, it will indicate whether or not the signal unit has been checked correctly. This information will be stored for inclusion in the acknowledgement field of an ACU to be emitted in the return direction. An ACU will be transmitted after each 11 signal units to form a block (see Recommendation Q.251, § 1.1.2).



TABLE 5/Q.277  
**8 bit check order**  
 8 bit check code matrix

	1	b <sub>1</sub>	b <sub>2</sub>	b <sub>3</sub>	b <sub>4</sub>	b <sub>5</sub>	b <sub>6</sub>	b <sub>7</sub>	b <sub>8</sub>	b <sub>9</sub>	b <sub>10</sub>	b <sub>11</sub>	b <sub>12</sub>	b <sub>13</sub>	b <sub>14</sub>	b <sub>15</sub>	b <sub>16</sub>	b <sub>17</sub>	b <sub>18</sub>	b <sub>19</sub>	b <sub>20</sub>
c <sub>7</sub>	1	0	1	1	0	1	0	1	0	1	0	0	0	1	1	1	0	0	0	0	0
c <sub>6</sub>	1	1	0	1	1	0	1	0	1	0	1	0	0	0	1	1	1	0	0	0	0
c <sub>5</sub>	1	0	1	0	1	1	0	1	0	1	0	1	0	0	1	1	1	1	0	0	0
c <sub>4</sub>	1	1	0	1	0	1	1	0	1	0	1	0	1	0	0	0	1	1	1	0	0
c <sub>3</sub>	1	0	1	0	1	0	1	1	0	1	0	1	0	1	0	0	0	1	1	1	0
c <sub>2</sub>	1	0	0	1	0	1	0	1	1	0	1	0	1	0	0	0	0	0	1	1	1
c <sub>1</sub>	1	0	1	1	1	1	1	1	1	0	0	1	0	0	1	0	0	0	0	1	1
c <sub>0</sub>	1	1	1	0	1	0	1	0	1	0	0	0	1	1	1	0	0	0	0	0	1

The *ones* in a row of the matrix under b<sub>1</sub> ... b<sub>20</sub> indicate those bits that should be *added modulo 2* to determine the check bit indicated at that row.

The *inversion* of the check bits is shown in this matrix by column 1.

**Typical shift register coder implementation**

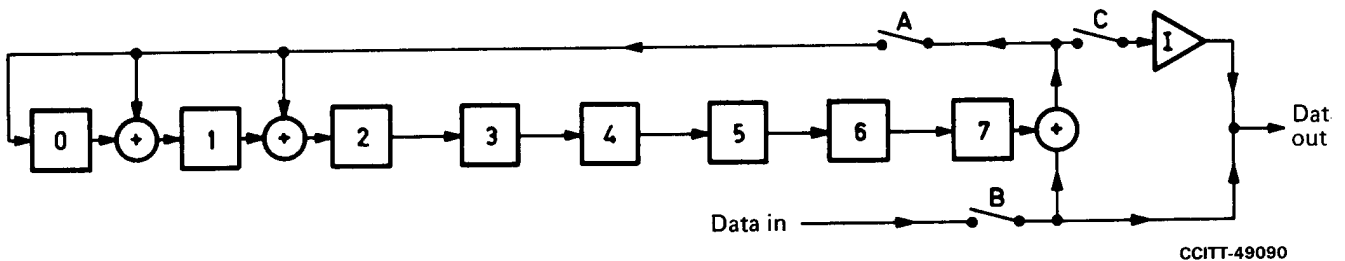

When information bits are being transmitted: Switches A and B closed, C open.  
 When check bits are being transmitted: Switches A and B open, C closed.  
 Shift registers in coders should be zero set at start.

**8 bit check code**

Polynomial:  $p(x) = (x + 1)(x^7 + x^6 + x^5 + x^4 + x^3 + x^2 + 1) = x^8 + x^2 + x + 1$ .  
 Code name: Primitive polynomial plus parity check.  
 Information bits: b<sub>1</sub> ... b<sub>20</sub>, check bits: c<sub>7</sub> ... c<sub>0</sub>.  
 Sequence on the line: b<sub>1</sub> (first) b<sub>2</sub> ... b<sub>19</sub> b<sub>20</sub> c<sub>7</sub> c<sub>6</sub> ... c<sub>1</sub> c<sub>0</sub> (last).

6.7.2 *Error detection by data channel failure detection*

The data carrier failure detector or loss of frame alignment detector will supplement the error detection by use of check bits. Indication of data channel failure at any time during the process of reception will cause the rejection of signal units in the process of reception. Regardless of the result of decoding, the ACU should acknowledge the signal unit as received incorrectly.

6.7.3 *Error correction*

Correction is achieved by retransmission of the messages which are not acknowledged to have been received correctly. The *block structure* and the contents of the ACU have been described in Recommendations Q.251, § 1.1.2, and Q.259, § 3.3.1. The acknowledgement indicators should be transmitted in the same sequence as the signal unit to which they refer.

A retransmission to comply with the information in the ACU will be made possible by storing at the transmitting terminal the signal units with their block reference numbers at the time of emission. This record must be maintained until the receipt of the associated ACU, when the record of messages which are acknowledged to have been correctly received should be eliminated. In the case of multi-unit messages, the complete message should be retransmitted if any of its constituent signal units fail to check correctly. A multi-unit message may contain signal units which are transmitted in two adjacent blocks, but it must be ensured that the records of the constituent signal units of the multi-unit message remain until the acknowledgement indicators show that the complete multi-unit message has been received correctly.

In the unlikely event that a terminal is unable to accept a correctly-received signal unit, e.g. due to input buffer congestion, the appropriate acknowledgement indicator bit in the outgoing ACU is marked as if the signal unit were received in error.

The maximum permitted delay between the emission of a signal unit and the subsequent reception of the ACU containing the acknowledgement of this signal unit is as follows:

a) *Where the multi-block monitoring procedure is not used*, the maximum permitted delay between the emission of a signal unit and the subsequent handling of the received ACU containing the acknowledgement of that signal unit must not exceed the time taken to send 8 blocks (96 signal units). Of this time (96 signal units), the time for 64 signal units (maximum) is available for the loop propagation time of the data link (see Note 1). At a data rate of 2400 bit/s this caters for a loop propagation time of up to 740 ms (see Note 2).

b) *Where the multi-block monitoring procedure is used*, the maximum permitted delay between the emission of a signal unit and the subsequent handling of the received ACU containing the acknowledgement of that signal unit must not exceed the time taken to send 256 blocks (see Note 3). Of this time (up to 3072 signal units), all but about 32 signal units are available for the loop propagation time of the data link. At a data rate of 56 kbit/s, this caters for a loop propagation time of up to 1520 ms.

*Note 1* – The number, 64 signal units, is based on the consideration that out of the total number of 96 signal units, 32 signal units are allocated as follows:

At the exchange emitting signal units:

emission of SU	}	not more than the time for sending 3 signal units
reception of ACU		
processing		

At the exchange receiving signal units:

reception of SU	}	not more than the time for sending 29 signal units
generation of ACU		
time in ACU queue		
emission of ACU		
time for drift compensation		
processing		

*Note 2* – The time for sending 64 signal units is also equivalent to

448 ms at 4 kbit/s

32 ms at 56 kbit/s.

*Note 3* – The full 256 blocks need not be banded in all designs, e.g. block memory may be limited to that required for the expected range of loop propagation delays and data rates at which the terminal will be applied. If the error control loop cannot exceed 8 blocks, multi-block monitoring equipment need not be provided.

The messages, which are not acknowledged to have been correctly received should be presented for retransmission, at which time the record of their previous transmission should be eliminated. The exception to the general rule is that the following signalling system control units should never be retransmitted: acknowledgement, synchronization, multi-block monitoring, multi-block acknowledgement, and changeover.

All signal units in a block except the SYU, ACU, multi-block monitoring, multi-block acknowledgement, and changeover system control signal units must be retransmitted if the ACU, referring to that block, is not received correctly. This may arise owing to the fact that the ACU fails to check correctly on account of errors during transmission or owing to drift between the data streams in the two directions (see Recommendation Q.279).

The first three bits of the ACU (i.e. the beading code) may be used for identification purposes (see Recommendation Q. 259, § 3.3.2.2). If the ACU checks to be error-free and the beading is correct the probability of an undetected error is extremely small.

6.8.1 *General*

The SYU will contain, in addition to the 8 check bits, a 16 bit pattern for bit and signal unit synchronization and a 4 bit number for block synchronization. The same 16-bit pattern will appear in every SYU. The 4-bit number will describe the position of the SYU within its block (see Recommendation Q.259, § 3.3.3.2).

Each signalling terminal requires 2 counters of up to 8 bits capacity, to keep a record of the blocks completed and acknowledged.

The block-completed counter (BCC) indicates the sequence number of the last block transmitted by the terminal. The last 3 bits of this number are also sent to the ACU of the block and occupy the bit positions reserved for the block-completed sequence number (BCSN).

The block-acknowledged counter (BAC) is up-dated using the block-acknowledged sequence number (BASN) in the incoming ACUs and therefore indicates the sequence number of the block being acknowledged by the last received ACU. In order to keep it up to date even when ACUs are detected in error, the block-acknowledged counter is incremented whenever the twelfth signal unit of a block is received in error. In the case where the block-acknowledged sequence number does not have the expected value, the block-acknowledged counter will be up-dated as follows:

- If the BASN has the same value as in the previous ACU, the BAC will not be incremented;
- If the BASN has an unexpected value greater than the previous BASN, then the least significant three bits of the BAC are replaced by the latest BASN;
- If the BASN has a value less than the previous BASN, then the BAC is incremented by eight and the least significant three bits replaced by the latest BASN.

If the terminal is in multiblock synchronization, and if a jump in the BASN of greater than 2 or equal to or less than –1 occurs, then multiblock synchronization must be checked immediately.

The counters are set to zero during normal synchronization and are checked periodically by using the multiblock monitoring procedure.

If the capacity of the counters is exceeded by the number of blocks in the error control loop, the signalling link is not capable of being used.

Some variations of the synchronization procedures in the specification may be incompatible with *Green Book* synchronization procedures.

6.8.2 *Normal synchronization*

This synchronization procedure is used whenever a signalling link is brought into service, either initially or after a total loss of synchronism.

Normal synchronism will be established in the following manner. Each terminal will emit either:

- a series of blocks containing eleven SYUs, plus one ACU, or
- a series of blocks of *faulty-link information* as covered in Recommendation Q.293, § 8.6.1, when changeover has been requested.

In both cases ACUs are transmitted initially with the acknowledgement indicators set to **1** and the block-completed and block-acknowledged sequence number set to **0**.

The instant of commencement of emission at the terminals is immaterial.

After bit synchronism has been established in the demodulator, the incoming bit stream will be monitored to find the SYU pattern. Once this pattern is found and verified the sequence number can be determined and the ACU position located.

In due course, three consecutive ACUs should be correctly received with block-acknowledged sequence number set to **0**.

At this time the acknowledgement indicators in the next outgoing ACU are set to reflect the detected errors in the signal units of the associated received block. Both sequence numbers in the ACU remain at **0**.

The reception of at least two consecutive ACUs with block-acknowledged sequence numbers set to **0** which check correctly and acknowledge one or more signal units as correct indicates that both terminals are in bit, signal unit and block synchronism.

At this time the one-minute proving period is started and block sequence numbering is initiated as follows:

the block-completed counter and block-completed sequence number in the next outgoing ACU are set to **1**. Thereafter the counter and the block-completed sequence number in the ACU are incremented by 1 each time an ACU is transmitted. The block-acknowledged sequence number in outgoing ACUs is now up-dated from the block-completed sequence number of the appropriate received ACU.

When the terminal receives an ACU with a block-acknowledged sequence number other than **0**, the block-acknowledged counter is set to this number. Thereafter, the counter is up-dated by the appropriate block-acknowledged sequence number each time an ACU is received.

When the block-acknowledged counter is incremented for the first time the number of blocks in the error control loop may be determined by subtracting the contents of the block-acknowledged counter from the contents of the block-completed counter. Should the result be negative, then the counters should be reset and block sequence numbering should be restarted.

The counter capacity is insufficient if the block-completed counter recycles before the block-acknowledged counter advances.

If, and only if, the initial synchronization procedure has indicated more than eight blocks in the error control loop, should the multi-block-monitoring procedure be used once every cycle of the block-completed counter. In this case the multi-block monitoring procedure should also be used for block resynchronization (see § 6.8.4 below).

Whenever a multi-block-monitoring signal is received it must be acknowledged by a multi-block-acknowledgement signal within the time required to send 40 signal units.

When the multi-block-acknowledgement signal is received, the multi-block and block numbers are compared with the contents of the block-acknowledged counter. If the received number is within minus four to plus three of the contents of the block-acknowledged counter then it is assumed that multi-block synchronism exists.

When a multi-block-acknowledgement signal is not received in response to a multi-block-monitoring signal transmitted no action need be taken. However, if a multi-block-monitoring signal is acknowledged as being received in error or if the ACU is in error then the multi-block monitoring procedure may be restarted.

If the signal unit error rate is acceptable at the end of the one-minute proving period, two load-transfer signals are emitted in the case of a regular link, or two standby-ready signals for synchronized reserve links. Acknowledgement of these signals by the other terminal is as covered in Recommendation Q.293, §§ 8.6.2 and 8.8. Signalling traffic may then be offered to regular links, while synchronized reserve links may be marked as ready for service.

The one-minute and the emergency proving periods and the load-transfer signalling sequence are omitted for non-synchronized reserve links when a changeover is made from the regular link as covered in Recommendation Q.293, § 8.6.1.

Bit synchronism is maintained by the transition between dibits for the analogue modem or by the receive clock on digital links; loss of synchronism will result in signal units failing to check correctly; however, incorrect signal units are more likely to result from line interference than loss of synchronism. Monitoring of the bit stream should result in the recognition of the 16 bit pattern of an SYU and enable synchronism to be restored if it had been lost.

### 6.8.3 *Signal unit resynchronization*

Loss of signal unit synchronism will result in continuous failure of signal units to check. When the signalling terminal receives consecutive signal units in error, it may take unilateral action to resynchronize to the incoming bit stream. In any ACUs transmitted during this procedure, all the indicator bits must be set to **1** and the block-acknowledged number and the block-completed number must be incremented as in normal operation. When synchronism is re-established on the incoming channel the indicators are set according to the incoming signal units, i.e. normal operation is resumed. The signal unit error rate monitor must continue to count signal units in error throughout this procedure.

During unilateral resynchronization, means must be provided to ensure that false resynchronization is kept to a level that is compatible with the dependability requirements (Recommendation Q.276). For this reason signal units should be checked to see that synchronization is valid.

### 6.8.4 *Block resynchronization*

Equipment must be provided to detect loss of block synchronism.

Loss of block synchronism will be recognized when a valid signal unit, which is not an ACU, is received in the 12th position in a block.

Loss of block synchronism may also be recognized by any of the following:

- a) an ACU is received in other than the 12th position in a block;
- b) the block-completed sequence number is not the one expected (see Note 2);
- c) an SYU sequence number is not the one expected.

Loss of block synchronism will not be recognized prior to the initial incrementing of the block-acknowledged counter, during either initial synchronization or after a total loss of synchronism as specified in § 6.8.2.

When loss of block synchronism has been recognized – by any of the four events described above – the terminal will stop sending telephone signals and send only SYUs and repeated ACUs (see Recommendation Q.279).

When the terminal has identified the signal unit position in a block either by recognizing the SYU number or by identifying an ACU, and has subsequently recognized two consecutive ACUs with correctly advancing block-completed sequence numbers, synchronism is deemed to have been regained.

After successful block-synchronization, the block being transmitted is completed with SYUs and an ACU. At least one complete block of 11 SYUs shall be sent before resuming normal traffic.

The first ACU sent after synchronization has been regained will have the following characteristics:

- a) the indicator bits are all set to **1**;
- b) the blocked-completed sequence number is set to the next in sequence;
- c) the block-acknowledged sequence number will correspond to the latest received ACU.

Upon resynchronization, a terminal may receive an ACU with an acknowledged block number which differs from that expected. All messages sent in unacknowledged blocks should be retransmitted.

After the completion of block resynchronization, multi-block synchronism should be checked, if applicable.

When block synchronism cannot be regained within 350 ms, the link is considered to have failed and resynchronization according to § 6.8.2 is commenced. The relevant link security procedures of Recommendation Q.293 will be initiated where appropriate (e.g. changeover, emergency restart, etc.). In the case of a link that is not carrying signalling traffic, resynchronization should commence without waiting for 350 ms, that is, unilateral block resynchronization should be dispensed with.

*Note 1* – An all-zero signal, i.e. a signal unit consisting of 20 zeros with the correct check bits, may cause a discontinuity in the transmitted signal unit sequence.

A receiving terminal which can recognize such a signal may, optionally, take steps to ensure that synchronism is not lost. In this case, the zero signal units should be treated as if they were in error, causing the error counter to be stepped, but no request for retransmission should be sent. Thus if zero signal units are received too frequently, a changeover or emergency restart will be initiated.

*Note 2* – If an unexpected ACU with both the BASN and BCSN equal to zero is received, reset the block counters, restart the block sequence numbering as in § 6.8.2 and count the ACU as being in error.

#### 6.8.5 *Multi-block resynchronization*

If the multi-block and block numbers in a multi-block-acknowledgement signal unit are not within minus four to plus three of the contents of the block-acknowledged counter a new multi-block-monitoring signal is sent. If the result of the second measurement is not within the above limit, multi-block synchronism has been lost. However, if the results of the measurements are the same, multi-block synchronism can be regained by up-dating the contents of the block-acknowledged counter to the obtained result.

When the second multi-block-monitoring signal is sent the terminal will send only SYUs and ACUs for three blocks. Normal traffic is then resumed and all messages transmitted in the interval between the two multi-block-monitoring signals are retransmitted.

If multiblock synchronism cannot be regained, the link is considered to have failed and resynchronization according to § 6.8.2 is commenced. The block counters will be reset and the block sequence numbering restarted. The relevant link security procedures of Recommendation Q.293 will be initiated where appropriate (e.g. change over, emergency restart. etc.).

### **Recommendation Q.279**

## **6.9 DRIFT COMPENSATION**

### 6.9.1 *General*

The difference in clock rates at the two terminations of a signalling link will result in a drift between the bit streams transmitted in the two directions.

The slower terminal will find at some stage that it has two blocks awaiting acknowledgement. When this occurs, only the second (later block) should be acknowledged (*skipping* of an ACU). On receipt of the acknowledgement of the second block, the sending terminal will initiate the transmission of all messages in the first block as if they were received in error before proceeding with any necessary retransmission relating to the second block.

Moreover, the faster terminal will find at some stage that it has no complete new block to acknowledge in the ACU it is about to transmit. In this case, the acknowledgement fields for the indicators and block number (bits 4 to 17) from the previous block are repeated (*repeating* of an ACU). This ACU will be recognized to be a repetition by the cyclic number (bits 15 to 17) and should be ignored by the slow terminal (see Recommendation Q.259, § 3.3.2).

### 6.9.2 *Drift compensation hysteresis*

When the time difference between the moment at which the second block is received and the moment at which the acknowledgement should be sent is very small (e.g. less than one signal unit), drift compensation may be required at frequent intervals. In order to avoid alternative skipping and repeating ACUs too frequently, it is recommended that a certain interval elapses between the opposite decisions *to skip* and *to repeat* ACUs (drift compensation hysteresis). This interval must be sufficiently long to avoid unnecessary drift compensations, but short enough that acknowledging of the concerned block is not delayed too much.

## SECTION 7

### SIGNAL TRAFFIC CHARACTERISTICS

#### Recommendation Q.285

#### 7.1 SIGNAL PRIORITY CATEGORIES

##### 7.1.1 Rules for signal priority

The following rules for establishing priority categories must be followed in normal operation; within any of the priority categories, signals are transmitted in order of their arrival at the output buffer (see Recommendation Q.251, § 1.1.1):

- a) Acknowledgement signal units (12th signal unit of each block) have absolute priority for emission at their fixed predetermined position;
- b) Faulty link information (Recommendation Q.293, § 8.6.1) has priority over all other signals;
- c) The answer signal, charge, the answer signal, no charge and the multi-block-monitoring and multi-block-acknowledgement signals have priority over other waiting telephone signals and signalling-system-control signals except those cited in a) and b) above;
- d) All other telephone signals, one-unit or multi-unit messages, and all other signalling-system-control signals, except synchronization signal units, have priority over management or other signals concerned with the bulk handling of traffic;

*Note* – In the event that a management signal concerns the bulk restoration of service, e.g. RSB, RBA, TFA, TAA, this signal may take priority over other telephone or signalling system control signals.

- e) Any signal which is to be retransmitted will take precedence over other waiting signals in the same priority category;
- f) Management signals have priority over synchronization signal units;
- g) Synchronization signal units have no priority.

##### 7.1.2 Break-in

a) Potential for a priority one-unit message to break into a multi-unit message is provided in the design of the format, but initially this feature will not apply except for ACU;

b) If a multi-unit message is used for a management signal, potential for break-in by a lone signal unit should be retained as a future option. However, there is no intent to provide means for a multi-unit message to apply break-in to another multi-unit message.

c) In the rare event that a SYU breaks into a multi-unit message (e.g. owing to severe processor overload), the multi-unit message may be accepted as valid.

## Recommendation Q.286

### 7.2 SIGNALLING CHANNEL LOADING AND QUEUEING DELAYS

#### 7.2.1 Loading potential

According to Recommendation Q.257, § 3.1.3.3, the System No. 6 design provides the potential in circuit labels to identify 2048 telephone circuits. Considering that the load per signalling system will vary according to the traffic characteristics of the circuits served and the number of signals in use, it is not practicable to specify a general maximum limit of circuits that a system can handle. The maximum number of circuits to be served must be determined for each situation, taking into account the traffic characteristics which apply, so that the total signalling load is held to a level which will maintain an acceptable signalling delay value resulting from queueing.

#### 7.2.2 Queueing delays

Common channel signalling systems handle the required signals for many circuits on a time-shared basis. With time-sharing, signalling delay occurs when it is necessary to process more than one signal in a given interval of time. When this occurs, a queue is built up from which signals are transmitted in order of their time of arrival and of their priority. Formulae, which are in close agreement with computer simulation tests and are recommended for calculating average queueing delays for the signals listed and the variables noted, are given in the Annex A to this Recommendation.

#### ANNEX A

(to Recommendation Q.286)

#### Queueing delay formulae for telephone signals

*Answer signal:* One-unit message with priority

$$Q_w = \frac{1 + (D-1) a_d}{(1-a_c)(1-a_c-a_{wM})} \times \frac{T_e}{2} \quad (1)$$

*Other telephone signals:* One-unit message without priority

$$Q_o = \frac{1 + (D-1) a_d}{(1-a_c-a_{pM})(1-a_c-a_{wM})} \times \frac{T_e}{2} \quad (2)$$

*Address signal:* Multi-unit message without priority

$$Q_d = Q_o + \frac{(D-1) a_c}{1-a_c} \times T_e \quad (3)$$

where  $Q_w, Q_o, Q_d$  = average queueing delay,

$a_w$  = traffic of answer signals if multi-block synchronization signal units are not used,

$a_{wM}$  = traffic of answer signals, multi-block monitoring and multi-block acknowledgement signals if multi-block synchronization signal units are used,



- $a_d$  = traffic of multi-unit address messages,
- $a_p$  = traffic of all telephone signals, if multi-block synchronization signal units are not used,
- $a_{pM}$  = traffic of all telephone signals, multi-block monitoring and multi-block acknowledgment signals if multi-block synchronization signal units are used,
- $a_c$  = traffic of acknowledgement signal units,
- $T_e$  = emission time of a signal unit,
- $D$  = number of SUs composing a multi-unit address message.

When multi-unit address messages are of different length the average queueing delay for the messages composed of  $D_i$  SUs is given by formula (3) using  $D_i$  for  $D$ . In formulae (1) and (2), the following values should be used:

$$D = \frac{\sum D_i a_{di}}{a_d} \text{ and } a_d = \sum a_{di}$$

where  $a_{di}$  is the traffic of the messages composed of  $D_i$  SUs.

*Note 1* – The unit of traffic is the erlang. The traffic  $a_p$  includes  $a_w$ ,  $a_d$  and the traffic of other one-unit messages, but excludes  $a_c$ .

*Note 2* – These formulae include the effects of systematic delay (due to synchronous operation and block composition) and of traffic delay, but do not include the emission time of the signal message and the delay resulting from eventual retransmission of signal messages.

*Note 3* – In addition, formula (3) includes the effect of break-in by acknowledgement signal units.

*Note 4* – Signal units of lower priority, e.g. management signal units and synchronization signal units, have no influence on the delay of telephone signals.

### Example of queuing delays

The traffic model assumed is given in Table 6/Q.286, from which the proportion of signal traffic may be obtained as shown in Table 7/Q.286. Using Table 7/Q.286, queuing delays are calculated as shown in Figure 22/Q.286.

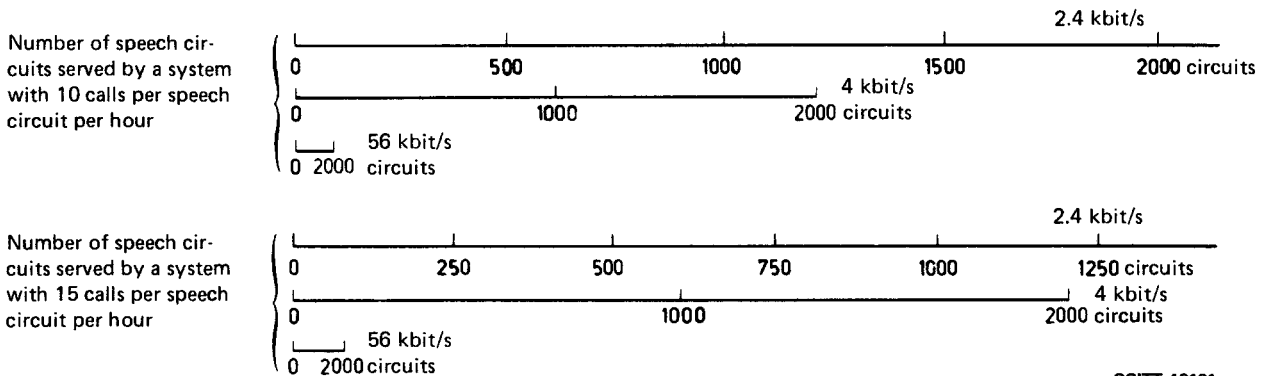
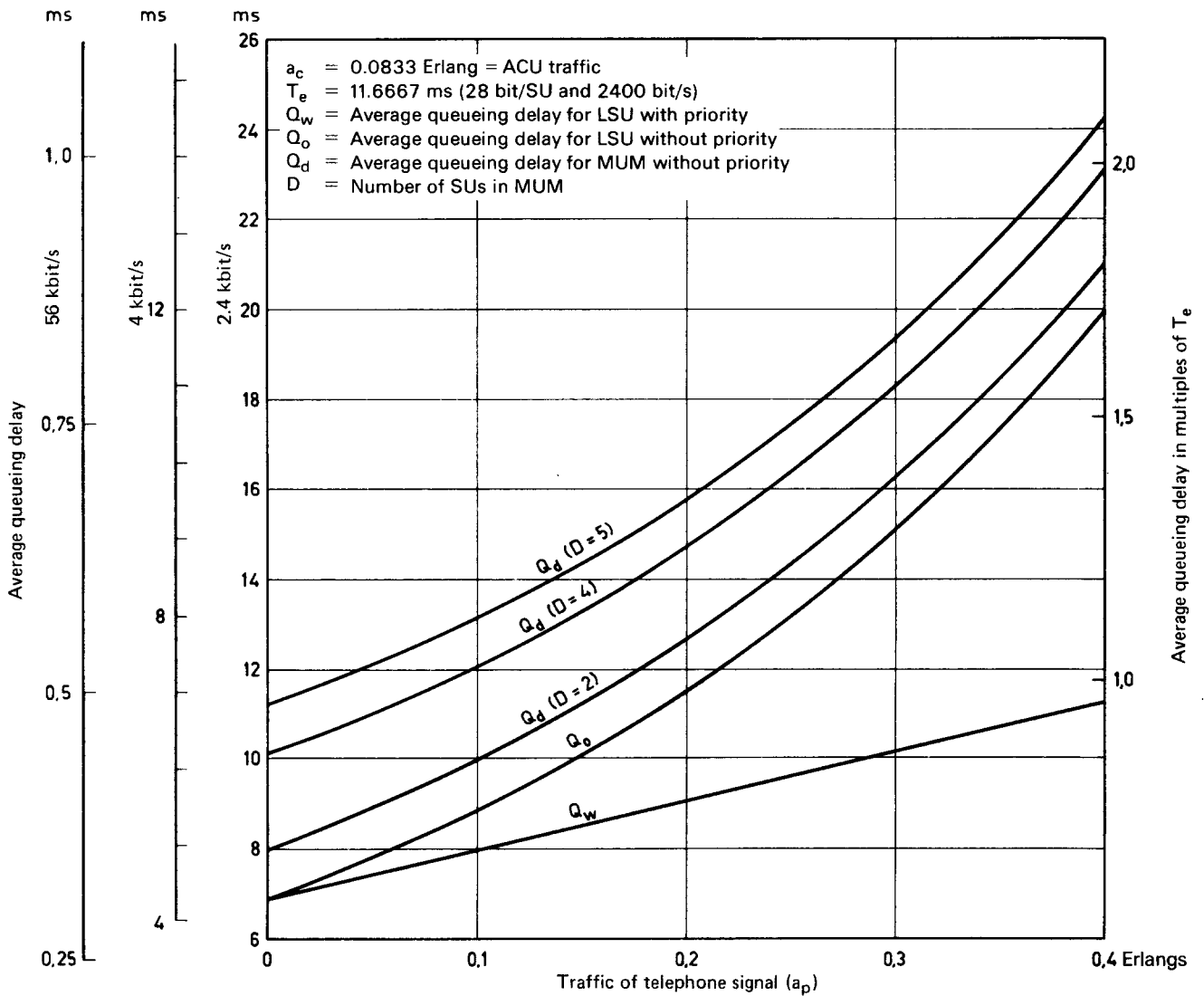

CCITT-49101

*Note* – When multi-block synchronization signal units are used, an extra load of approximately 0.01 Erlang at answer signal priority level will occur in the worst case, i.e. 16-block cycle at 2.4 kbit/s. This will give an increased queuing delay of approximately 2% for an answer signal and of approximately 3% for a five-unit IAM.

FIGURE 22/Q.286

Average queuing delays for each channel of traffic model shown in Table 6/Q.286

TABLE 6/Q.286

**Traffic model**

Sending procedure		"En bloc"				Overlap			
Type of call		AW	SB	CC	AB	AW	SB	CC	AB
Per cent calls		30	10	5	5	30	10	5	5
Messages per call	Address	1	1	1	0	1	1	1	1
	5-SU					1	1	0	1
	4-SU					1	1	0	1
	2-SU					3	3	0	0
	1-SU								
	Answer	1	0	0	0	1	0	0	0
	Others	4.5	4	4	0	4.5	4	4	3

*Note 1* – AW : answered, SB = subscriber busy and not answered, CC = circuit congestion, AB = abortive.

*Note 2* – The assumptions used in this model are chosen for illustrative purposes, and should not be considered to be typical.

TABLE 7/Q.286

**Proportion of traffic**

Type of message		SUS per call	Per cent traffic
Answer		0.60	5.5
Address	D = 5	2.25	20.4
	D = 4	2.00	18.2
	D = 2	0.90	8.2
Other		5.25	47.7
Total per call		11.00	100.0

*Note* – In this table, *other* includes the one-unit address messages.

**Recommendation Q.287**

**7.3 SIGNAL TRANSFER TIME REQUIREMENTS**

The cross-office signal transfer should be fast so as not to lose the advantage of the fast signalling capability of the System No. 6. While no firm time requirements in regard to the various components of signal transfer time have been established, Annex A to this Recommendation contains design objectives in terms of average and 95% level time values for  $T_h$  and  $T_c$  for the answer signal, other one-unit messages and the initial address message at the specified data rates. These figures have to be viewed as reasonable design requirements.

**ANNEX A**

(to Recommendation Q.287)

**Estimates for transfer times**

1. *Design objectives*

The design objectives for the handling time  $T_h$  and the cross-office transfer time  $T_c$  are shown in Table 8/Q.287.

TABLE 8/Q.287

**Design-objectives ( $T_h$  and  $T_c$ )**

Type of message		Answer	Other one-signal unit message	IAM of 5 SU
$T_h$ in ms	Average	12	25	25
	95 % level	25	60	60
$T_c$ in ms at 2.4 kbit/s	Average	40	65	120
	95 % level	70	140	200
$T_c$ in ms at 4 kbit/s	Average	30	50	80
	95 % level	55	100	135
$T_c$ in ms at 56 kbit/s	Average	20	35	35
	95 % level	35	70	70

*Note* – These figures have to be viewed as reasonable design requirements.

2. *Calculation for cross-office transfer time*

*Average value:*

The average value of the cross-off-ice transfer time,  $T_{cAV}$ , is calculated by the following formula:

$$T_{cAV} = T_r + T_{hAV} + T_{sAV} \tag{1}$$

The average value of the sender transfer time,  $T_{sAV}$ , is approximated as follows:

$$T_{sAV} = T_{qAV} + T_m + T_e \text{ for one-unit messages} \tag{2a}$$

$$T_{sAV} = T_{qAV} + T_m + (D \times T_e), \text{ for multi-unit messages} \quad (2b)$$

where  $T_e$  = emission time of a signal unit,

$T_m$  = time for encoding and modulation and, where present, parallel to serial conversion,

$T_r$  = receiver transfer time,

$D$  = number of SUs composing a multi-unit message.

The average queuing delay,  $T_{qAV}$ , is equivalent to  $Q_w$ ,  $Q_o$  or  $Q_d$  which is calculated by the formula in Annex A to Recommendation Q.286.

95% level value:

The 95% level value of the cross-office transfer time,  $T_{c\ 95\%}$ , is approximated by the following formula:

$$T_{c\ 95\%} = T_{cAV} \sqrt{(\Delta T_h)^2 + (\Delta T_q)^2}$$

where

$$\Delta T_h = T_{h\ 95\%} - T_{hAV} \quad (3)$$

$$\Delta T_q = T_{q\ 95\%} - T_{qAV}$$

The 95% level value of the queuing delay,  $T_{q\ 95\%}$ , may be determined by simulation.

Example 1:

Table 9/Q.287 shows a calculated example at 2.4 kbit/s of  $T_{cAV}$  and  $T_{c\ 95\%}$  for  $a_p = 0.4$  erlang with the traffic model of Table 6/Q.286. As a result of simulation for this model, it has been determined that  $T_{q\ 95\%} = 3.5 \times T_{qAV}$ . The values of  $T_{hAV}$  and  $T_{h\ 95\%}$  are those assumed for Table 8/Q.287 and  $T_r = T_m = 2$  ms is assumed.

TABLE 9/Q.287

**Calculated example ( $T_c$ )**

Type of message		Answer	Other one-unit message	IAM of 5 SU
$T_c$ in ms	Average	38	60	111
	95% level	69	121	181

Example 2:

Figure 23/Q.287 and Table 10/Q.287 show a calculated example of the average  $T_c$  for traffic of 2000 circuits served by systems of different data transmission rates with 10 calls per speech circuit per hour, with the traffic model of Table 6/Q.286. Answer message average handling time  $T_h = 10$  ms (other message average handling time  $T_h = 20$  ms) and  $T_r = T_m = 2$  ms are assumed. The number of blocks in the error control loop is assumed not to exceed eight.

TABLE 10/Q.287

**Average cross-office transfer times for systems of different signal transmission rate**

Type of message		Answer	Other one-unit message	IAM of 5 SU	
Average handing time $T_h$ (ms)		10	20	20	
Average cross-office transfer time $T_c$ (ms)	Bit rate (kbit/s)	2.4	36	54	105
		4	27	38	69
		56	15	25	28
Average cross-office transfer time $T_c$ (ms) (Refer to Figure 23/Q.287)		A	B	C	

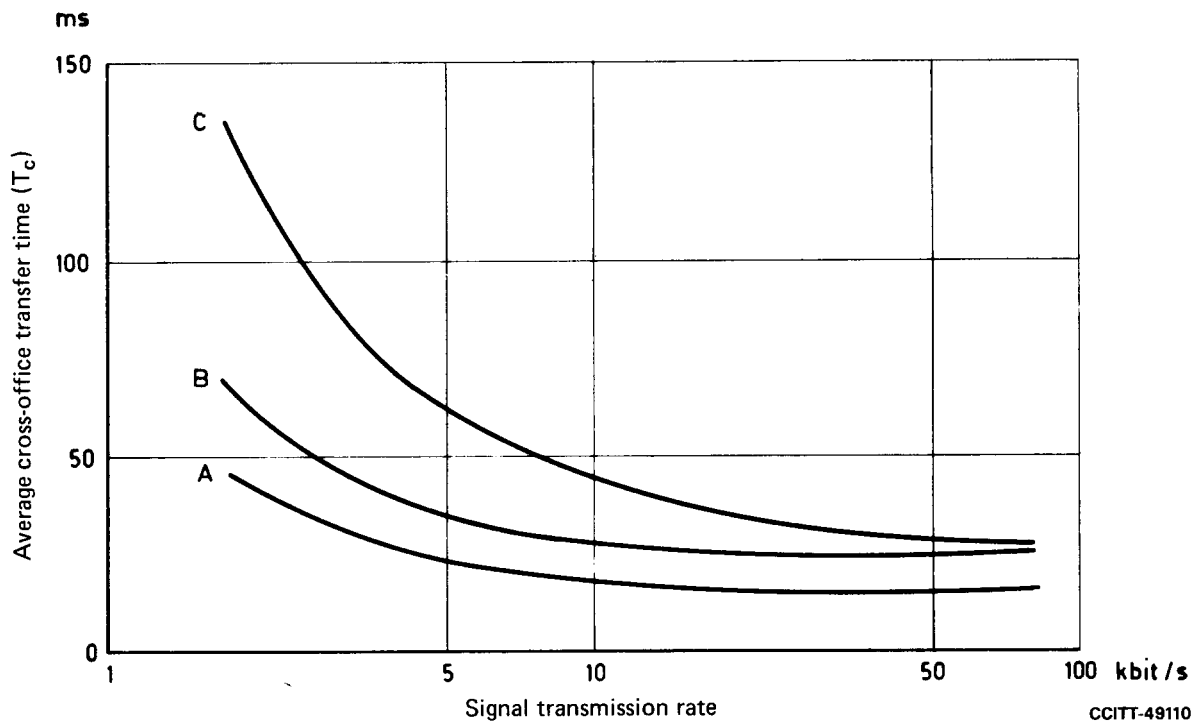

FIGURE 23/Q.287

**Average cross-office transfer time for systems of different signal transmission rates**

CCITT-49110

## SECTION 8

### SECURITY ARRANGEMENTS

#### Recommendation Q.291

##### 8.1 GENERAL

Since a common signalling link carries the signals for many speech circuits, a failure of this link will affect all the speech circuits served. Therefore, arrangements must be made to ensure continuity of service for the circuits.

The security arrangements involve the provision of reserve facilities, that may be one or more of the following:

- another signalling link, used in the quasi-associated or load-sharing mode,
- a dedicated reserve signalling link,
- a dedicated reserve transfer link, or
- a circuit, normally used for speech (or other service purposes), to be withdrawn when required for use as a transfer link.

In the last two cases the transfer links must be equipped with signalling terminals and modems and interface adaptors to form signalling links.

Other than possible signalling traffic carrying considerations, there are no restrictions in using a digital reserve signalling link for an analogue regular signalling link and vice versa.

When the regular signalling link fails, all waiting messages marked for retransmission as well as all unacknowledged signal units should be retransmitted over the reserve facility. Subsequent signalling traffic destined for the failed link should then be transferred to the reserve facility. Signalling traffic should be directed to the reserve facility only after the proper preparations have been made [see § 8.6.1 d) below].

When no signalling link is available for carrying signalling traffic during the period of changeover to a non-synchronized reserve or a nominated speech circuit, or during an emergency restart condition, measures must be taken to prevent the storage capacity of the failed signalling system from being exceeded so as to prevent messages from being lost. It is recommended that all free speech circuits should be removed from service during this period (by local busying at each end), to permit traffic to overflow to other routes which are serviceable. When there is no overflow facility, appropriate circuit-group-congestion signals should be returned.

##### 8.2 BASIC SECURITY ARRANGEMENTS

The basic security requirement is taken from the dependability requirements for continuity of signalling service [Recommendation Q.276, § 6.6.1 d)].

Steps should be taken to open up a reserve facility as soon as possible after detection of a fault.

Once the reserve facility has been taken into service, the regular signalling link should not be brought back into service for signalling traffic until it has been checked to be giving satisfactory performance for 1 minute.

Should it happen that the reserve signalling link also fails, another reserve facility should be opened up. When there is no other reserve facility available, an attempt to transfer to any suitable signalling link, using the emergency restart procedure described in Recommendation Q.293, 8.7, must take place.

### 8.3 TYPES OF FAILURE, RECOGNITION OF FAILURE AND ABNORMAL ERROR RATES

#### 8.3.1 *Types of failure*

The interruption of signalling service may be caused by several types of faults affecting the transfer channels, the modems or interface adaptors or the signalling terminal equipment.

The failure may be indicated as follows:

- a) loss of the analogue data carrier or loss of the digital frame alignment,
- b) continuous failure of signal units to check correctly,
- c) unacceptable intermittent failure of signal units to check correctly, or
- d) loss of block or multi-block synchronism.

#### 8.3.2 *Recognition of failure*

Monitoring equipment is provided to recognize all types of signalling channel failures.

At each terminal, the monitoring will be performed on the incoming signalling channel by:

- a) monitoring the signal unit error rate, and
- b) detection of loss of block or multi-block synchronism.

The *signal unit error rate monitor* recognizes unacceptably high percentages of signal units received incorrectly. A signal unit is recognized as being received incorrectly as a result of an indication from the check bit decoder or the data channel failure detector (see Recommendation Q.277, §§ 6.7.1 and 6.7.2). The signal unit error rate monitor should have the hyperbolic error rate time characteristic shown in Figure 24/Q.291. The signal unit error rate monitor shall be reset to zero whenever:

- the monitor output has been recognized, indicating that the signal unit error rate, as detected by the decoder or the data channel failure detector, has become unacceptable, or
- synchronism of the signalling link has been achieved, or
- after signalling link failure.

*Loss of block* or multi-block synchronism is detected as described in Recommendation Q.278.

#### 8.3.3 *Recognition of end of failure*

##### a) *One-minute proving period*

End-of-failure monitoring equipment is provided at each terminal to recognize satisfactory performance of the signalling link after initial synchronization or after a link failure. The signalling link shall not be placed into service until a signal unit error rate of 0.2% or less has been achieved in a proving period of one minute. The end-of-failure monitor will indicate that this error rate has been achieved when it recognizes that no more than:

- 10 signal units at 2400 bit/s, or
- 16 signal units at 4 kbit/s, or
- 240 signal units at 56 kbit/s

have been received in error in a proving period of one minute.



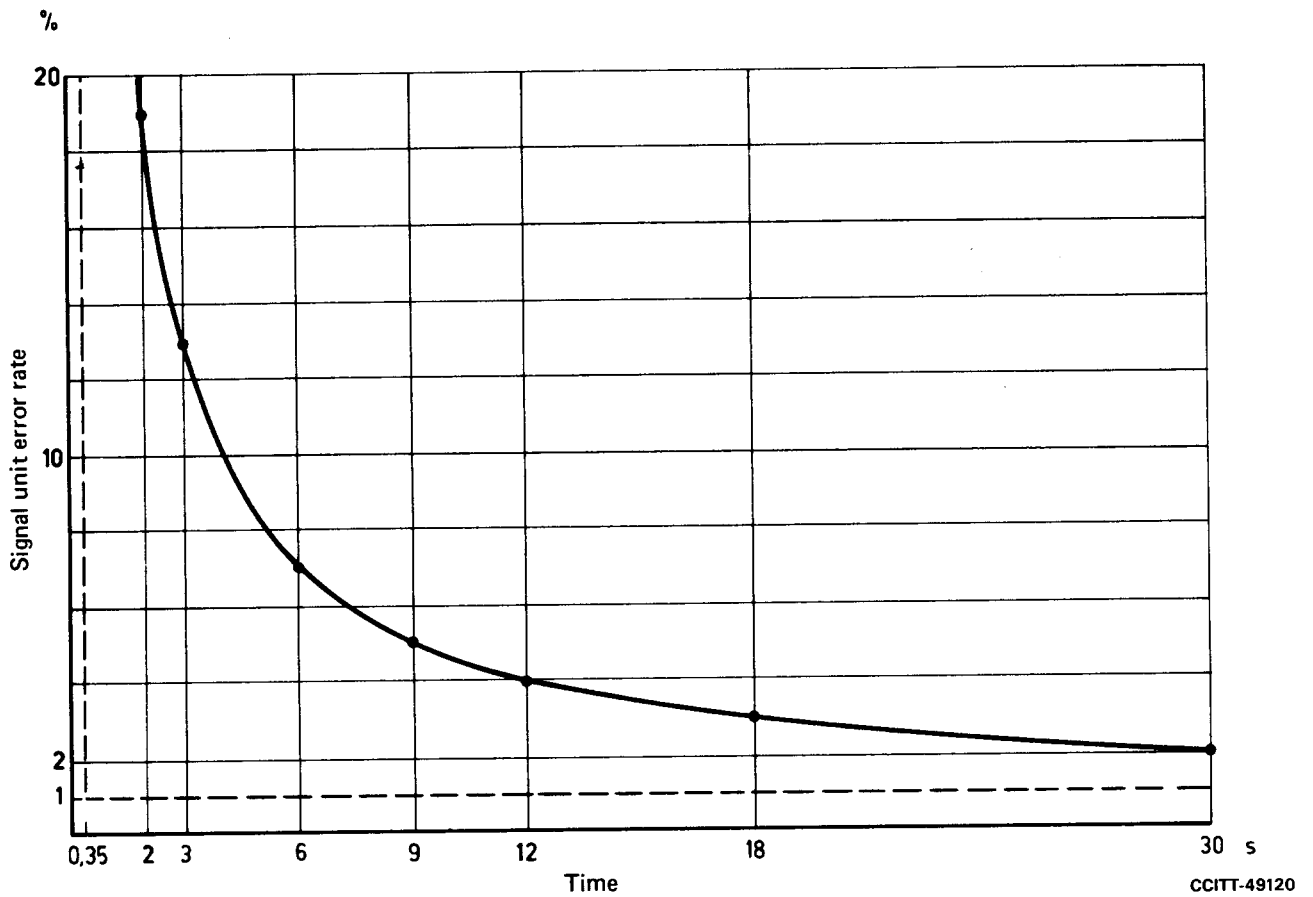

Consecutive signal units received in error for 350 ms will initiate changeover.

*Note* – The curve is based on a uniform distribution of errors.

Data transmission rate	Number of signal units	
	X	Y
2400 bit/s	$31 \pm 1$	2 500
4 kbit/s	50	4 200
56 kbit/s	700	58 800

*Note* – The signal unit error rate monitor can also be defined by the following parameters:

- a) X consecutive signal units received in error;
- b) 2% of signal units in error out of Y received signal units.

FIGURE 24/Q.291  
Signal unit error rate monitor characteristic

In the event that the end-of-failure monitor indicates that more than the appropriate number of signal units in error have been received before the one-minute proving period has elapsed, then the end-of-failure monitor shall be reset and the one-minute proving period recommenced.

b) *Emergency proving period*

An emergency proving period is used in conjunction with the emergency restart procedure (see Recommendation Q.293, § 8.7). The emergency proving period is a 2 to 3 second period during which the error rate on the link is such that the end-of-failure monitor does not give an output. The emergency proving period begins when a regular or reserve link achieves synchronism. In the event that the monitor gives an output before the emergency proving period has elapsed, the end-of-failure monitor shall be reset and the emergency proving period recommenced.

c) *No proving period*

No proving period is required when

- changeover to a reserve link is caused by failure of a signalling link (as specified in Recommendation Q.293, § 8.6.1), or when
- block and multi-block synchronism is regained (as specified in Recommendation Q.278, §§ 6.8.4 and 6.8.5).

## **Recommendation Q.292**

### **8.4 RESERVE FACILITIES PROVIDED**

The reserve facilities provided can be subdivided into three groups following below in the order of ready availability:

- a) quasi-associated reserve signalling links,
- b) full-time reserved transfer links,
- c) nominated direct circuits.

Within each group, one or more arrangements can be distinguished which differ in the preparatory actions to be taken to bring the reserve facility into active service.

The choice of the particular facilities to be used can be governed by several factors, e.g. the possibility of using quasi-associated signalling links, the number of circuits served, the geographical distance between the System No. 6 exchanges, etc. The choice of method(s), therefore, will be made by the Administrations involved according to the circumstances which apply.

As a matter of principle, the reserve facility to be used should follow a route different from the route of the regular signalling link.

#### **8.4.1 *Quasi-associated reserve signalling links***

The method of using a quasi-associated signalling link as a reserve facility is directly derived from the principles accepted for System No. 6 (Recommendation Q.253).

This method assumes an adequate signalling network and requires prior agreements on its adoption between the Administration(s) through whose signal transfer point(s) the signalling traffic may overflow.

Methods of controlling quasi-associated signalling are described in Recommendation Q.266, § 4.6.2.

#### **8.4.2 *Full-time reserved transfer links***

A transfer link is permanently assigned to provide the reserve signalling link.

The following arrangements can be distinguished:

a) *Load sharing*

Both transfer links are equipped with modems or interface adaptors and signalling terminals and are in use on the basis of duplicate working with load sharing. Each link in this method is the reserve for the signal load on the other link. (See also Recommendation Q.293, § 8.9.)

The circuits shall be assigned identical labels on both links and each circuit shall be assigned to one of the parallel signalling links as its regular link. The exchange must be capable of accepting signalling traffic for the labels over either link at any time. (See also Recommendation Q.293, § 8.9.)

b) *Synchronized reserve*

The transfer link is equipped with modems or interface adaptors and signalling terminals, thus forming a reserve signalling link.

The link is not in use, but its channels are synchronized.

c) *Non-synchronized reserve*

The transfer link is not equipped with modems or interface adaptors and signalling terminals. A switching operation is thus required to convert the transfer link into a signalling link, before synchronizing of the signalling channels can start.

Arrangements a) and b) are considered to be more usual than c) and will no doubt be the general rule in the case of a full-time reservation of a transfer link. However, for international exchanges at which very many signalling links terminate, Administrations may prefer not to use the arrangements a) and b) above but to pool available modems, interface adaptors and signalling terminals for common use to a number of reserve transfer links.

#### 8.4.3 *Nominated direct circuits*

A nominated direct circuit is permanently assigned to be converted into a signalling link, when required. The following arrangements can be distinguished:

a) *Speech circuit reserve*

The nominated circuit is normally in speech (or other service) condition. Switching action and synchronizing must be performed when the transfer link of the circuit is required for the reserve signalling link. The switching action is allowed only when the transfer link is not in use. For this reason, Administrations should ensure that the nominated speech circuit has a high probability of being free (for example, by using a last-choice circuit).

The available modems and signalling terminals may be pooled for common use to a number of speech circuit groups.

b) *TASI-through reserve (analogue only)*

The nominated circuit is a TASI-through circuit. The circuit is not to be used for speech. When it is required to open up a reserve signalling link, data are applied in the normal way. These data will be sufficient to operate the speech detector at each end and cause TASI channels to be associated with the circuit for as long as the data are applied.

Arrangement b) cannot be ranked as a general solution since it depends on having a TASI system between the two international exchanges involved.

#### 8.4.4 *Link-sets, signalling routes, signalling route sets and opposite signalling route sets*

a) *Link sets, signalling routes, and signalling route sets*

A regular link and reserve links directly connecting two System No. 6 exchanges, a System No. 6 exchange and an STP or two STPs, and which provide signalling for the same 2048 circuit labels are termed a link set. Where quasi-associated signalling facilities are provided, the security arrangements for a band of speech circuits will consist of one or more link sets. The different signalling paths so formed are known as signalling routes. The list of signalling routes in their priority order is known as a signalling route set. One signalling route set is allocated for all bands which have the same security arrangements.

b) *Opposite signalling route sets*

At an STP traffic passes from the originating to destination exchange and vice versa using a signalling route set in each direction. Each of these signalling route sets, which form a complementary pair, is termed an opposite signalling route set with respect to the other.

8.4.5 *Choice of reserve facility*

When the regular link in a link set has failed and where more than one type of service is provided, signalling should first be restored on a synchronized reserve, such as a load shared or full-time synchronized reserve transfer link in the same link set. If these are not provided or are not available, signalling should then be restored via one or more link sets using quasi-associated signalling. If this option is not provided or is not available, then an attempt should be made to restore signalling on a nonsynchronized reserve such as a full-time nonsynchronized reserve transfer link or nominated direct circuit, within the original link set. Should the failed link be a reserve link, then changeover follows the same priority order as above except that the search should commence on the link below the one that has just failed. Changeover to a proved reserved link of a higher priority is only possible by using the emergency restart procedure. See Recommendation Q.293, § 8.7.

For each band or group of bands the provision of the different types of reserve, the search order to be applied where a number of one type are provided, and the selection order between link sets should be specified by the Administrations concerned.

**Recommendation Q.293**

**8.5 INTERVALS AT WHICH SECURITY MEASURES ARE TO BE INVOKED**

The following action points are defined:

$T_0$  = time when signalling fault indication starts,

$T_w$  = time when warning of failure is issued (for example, to busy a nominated speech circuit reserve),

$T_d$  = time when decision to change over is made,

$T_u$  = time when signalling traffic is offered to the reserve link.

The intervals  $T_w - T_0$  and  $T_u - T_d$  are not specified. It is recognized that these intervals will vary from one method or arrangement to another.

The interval  $T_d - T_0$  does not include the time for the processor to react. Its value is determined in the case of:

- continuous failure, by all signal units being in error for 350 milliseconds;
- intermittent failure, by the instant the signal unit error rate monitor gives an output indicating that the signalling error rate has become unacceptable; or
- loss of block or multi-block synchronism, by the failure to achieve block resynchronization within about 350 ms.

## 8.6 CHANGEOVER AND CHANGEBACK PROCEDURES

### 8.6.1 *Changeover from faulty signalling links*

- a) Consider two exchanges A and B with a fault in signalling link AB, *affecting both directions*.

Each exchange at time  $T_d$  initiates the synchronization procedure (Recommendation Q.278), where applicable, on the reserve signalling link. When both ends are in synchronism over the reserve link, the processors switch over without any proving period and use this link.

On detection of failure of a working link at time  $T_0$  each terminal *starts sending faulty-link information* on the link just failed. This information consists of a number of changeover signals (completing the block being sent) plus ACU, followed by a continuous stream of alternating blocks of changeover signals and of SYUs (11 changeover signals + ACU, 11 SYUs + ACU, 11 changeover signals + ACU, etc.).

When a terminal is unable to accept a correctly received signal unit, the relevant bit in the ACU acknowledging the signal unit shall be set to **1**. If the terminal has lost synchronism, then the normal synchronization procedure is started (Recommendation Q.278, § 6.8.2).

With the reserve facility properly prepared, each exchange retransmits on the reserve facility all waiting signals marked for retransmission and all signals not acknowledged by the other exchange, followed by new signalling traffic from the failed link as specified in Recommendation Q.291, § 8.1.

- b) Consider a fault affecting *only one direction* for example A to B. The fault will be detected at terminal B and at a time  $T_d$  this terminal will act as under § 8.6.1 a) above.

Upon receipt of two changeover signals on the working signalling channel within a period of 3 seconds, exchange A commences the synchronization procedure, when applicable, on the reserve signalling link. On the failed channel, exchange A will commence the resynchronization procedure as in Recommendation Q.278, § 6.8.2, allowing the block numbering sequence to be re-established. If exchange A has not itself lost synchronism on the failed channel, it may skip over superfluous actions within the synchronization procedure, i.e. faulty-link information, the sending of all **1s** acknowledgement indicators, SYU search, and proving period. The detection and timing of the loss of block synchronization should be cancelled at this time. Exchange A will proceed to retransmit all the failed link messages as described in Recommendation Q.291, § 8.1, and transfer all subsequent signalling traffic destined for the failed link to the reserve link for the duration of the failure.

- c) If more than one type of reserve is provided, the choice of reserve facility should be in accordance with Recommendation Q.292, § 8.4.5. Nominated speech circuits will be made busy to outgoing traffic at each end immediately, or as soon as free, until transfer to a nominated reserve signalling link has been accomplished. At time  $T_d$ , an operable reserve will be selected, by hunting through the available choices in a fixed predetermined order as specified by the Administrations concerned. Nominated direct circuits in use for speech are skipped over in the selection process.

If a synchronized reserve or quasi-associated route is selected, a later transfer to a non-synchronized full-time reserve link or a nominated direct circuit may be effected as described in § 8.6.3.2 below.

When a failure is encountered on a reserve signalling link, faulty-link information is sent in the same manner as on a regular signalling link encountering a failure. If the reserve link is carrying signalling traffic, the procedure as covered in Recommendation Q.291, § 8.2, will be initiated.

- d) When a changeover is to another link in the same linkset, Signalling System Control Signals (SCUs) waiting on the faulty link are not retransmitted on the new link. When a changeover is to one or more quasi-associated routings, the telephone signal units, network maintenance signals and network management signals are retransmitted on their respective routings after band translation where necessary. SCUs and signalling network management signals are not retransmitted on quasi-associated routings.

When a link becomes faulty and no reserve facility is available for some or all bands on the link, then any waiting signal units for such bands will not be able to be retransmitted as described above. Where such signals refer to remote routes and are using the System No. 6 exchange as a signal transfer point, these signals should be deleted and a message-refusal signal returned for each telephone signal and a transfer-prohibited signal returned for each network maintenance signal (see Recommendation Q.266, §§ 4.6.2.1 and 4.6.2.3).

### 8.6.2 *Changeback to the regular link*

When either terminal has regained synchronism on the failed regular link, it will begin both its one-minute and emergency proving periods. However, if synchronism had been continuously maintained at one end during the failure, this exchange need not start a new proving period. When the received signal unit error rate has remained acceptable for the one-minute proving period, the exchange will *cease sending faulty-link information* by replacing the changeover signals (if it is sending changeover signals) with SYUs (plus ACUs).

To return to the regular link, the exchange A initiating the changeback sends two load-transfer signals on the regular link. From this time until changeback is either completed or abandoned, exchange A must be in a position to receive and process all signals on both the regular link and the reserve in use. When exchange B receives a load-transfer signal and knows the regular link is operational, it responds with a load-transfer acknowledgement signal on the regular link, then immediately transfers its signalling traffic from the reserve to the regular link. When exchange A receives one load-transfer-acknowledgement signal, it transfers its signalling traffic from the reserve to the regular link. Should an exchange receive a load-transfer signal on the link that is carrying traffic, then this signal shall be acknowledged.

Until the load-transfer and acknowledgement signal sequence has been satisfactorily completed as described above, signalling continues over the reserve link. After this signal sequence is completed, exchanges A and B continue to monitor the reserve link until all signals initially transmitted on the reserve link have had the opportunity to be acknowledged. Signals sent on the reserve link acknowledged as having been received in error are retransmitted on the reserve link. After  $5 \pm 1$  seconds, when all signals have had the opportunity to be acknowledged as correctly received, each end will return reserve voice-frequency links with switched terminals and modems to their original status. A nominated speech circuit must be returned to service for outgoing traffic without delay by completing an unblocking sequence even though blocking signals have not previously been exchanged for the circuit. This unblocking sequence will remove any previous circuit state at both ends and return the circuit to the idle state. Any resultant failure indications occurring on the reserve link during the  $5 \pm 1$  second time interval may be ignored. (See also § 8.9.)

In the event exchange B decides not to change back when it receives a load-transfer signal, it withholds the load-transfer-acknowledgement signal. Exchange A must therefore time for an interval of approximately 2 minutes for the receipt of a load-transfer-acknowledgement signal. If the time interval elapses without receiving a load-transfer-acknowledgement signal, exchange A will transmit two more load-transfer signals and recycle the timing.

If exchange A decides to terminate the changeback procedure at any time before the process is completed, it will interrupt the changeback procedure and transmit faulty link information as for a normal changeover. Exchange B will respond to the faulty-link information even though it has agreed to changeback and has started sending messages on the regular link. In the event of changeover before the load-transfer signalling sequence is completed, both exchanges will remain on the reserve link which the changeback commenced.

If the changeback procedure is interrupted or terminated as above before the procedure is completed, the regular link should continue to meet the one-minute proving period requirement.

In the event that both exchanges A and B start changeback procedures at about the same time, either exchange, having transmitted two load-transfer signals, shall respond to a received load-transfer signal with a load-transfer-acknowledgement signal and shall transfer signalling traffic to the regular link on the receipt of either a load-transfer signal or a load-transfer-acknowledgement signal.

### 8.6.3 *Changeover from working signalling links*

#### 8.6.3.1 *Manual changeover procedure*

a) In the event that it is desired to change over to a reserve link for rearrangements, changes, maintenance, etc., on a link currently carrying the signalling traffic for the link set, the exchange A desiring the changeover will send a manual-changeover signal on the working link. This working link may be the regular link, a full-time synchronized reserve link, or one link of a load shared pair. When exchange B receives this signal, the selection of a reserve link is initiated by both exchanges. The selection order for this reserve differs from that for the normal changeover (described in § 8.4.5 above) in that quasi-associated routings are excluded from the search if one-or more non-synchronized reserve

links are provided in the link set. This is specified in order to transfer the signalling load directly to a non-synchronized reserved link, thus preventing a possible double load transfer due to the load transfer procedure (automatic) as specified in § 8.6.3.2 being initiated on a quasi-associated routing subsequent to the manual changeover. When a transfer to a non-synchronized reserve link is indicated, the cyclic procedure described in § 8.6.3.2 below will be used as appropriate. When exchange B has selected a quasi-associated route or other synchronized reserve link or has gained synchronism on a non-synchronized link, a manual-changeover-acknowledgement signal is sent back on the original working link.

Exchange A must not send a manual-changeover signal or exchange B send a manual-change-over-acknowledgement signal if the desired changeover would cause the complete failure of a signalling route set. That is, the signalling for a group of bands would be lost. However, these signals will not be inhibited if the affected signalling route set is for bands for which the exchange is acting as a signal transfer point.

If a quasi-associated route or other synchronized reserve link is selected for the changeover, the exchanges A and B transfer their signalling traffic subsequent to the exchange of the manual-changeover-acknowledgement signal.

If a non-synchronized reserve signalling link is selected and the manual-changeover-acknowledgement signal has been received, two load transfer signals are sent by exchange A on this link when the link is in synchronism and has passed the one-minute proving period. On receipt of one load-transfer-acknowledgement signal, exchange A will transfer its signalling traffic.

For all cases, both exchanges A and B continue to monitor the original working link for  $5 \pm 1$  seconds, until all signals initiated on this link have the opportunity of being acknowledged as correctly received. Signals acknowledged as having been received incorrectly are retransmitted on the original working link. Subsequent to this timing period, the exchange initiating the manual changeover may continue to transmit SYUs + ACUs in the normal manner or may remove the link from service. The exchange acknowledging the manual changeover should maintain synchronism and, should the link be removed, detect loss of synchronization.

b) If exchanges A and B simultaneously send manual-changeover signals, both exchanges must send manual-changeover-acknowledgement signals. In the quasi-associated route or other synchronized reserved link case, exchanges A and B transfer their signalling traffic subsequent to the receipt of the manual-changeover-acknowledgement signal. For all other cases, each end, subsequent to receipt of a manual-changeover-acknowledgement signal on the original working link, will transmit two load-transfer signals on the selected reserve which will be acknowledged by the other end.

When either end receives a load-transfer signal, while expecting a load-transfer-acknowledgement signal from the other end after sending two load-transfer signals, it may transfer its signalling traffic from the original working link to the reserve link after sending a load-transfer-acknowledgement signal.

c) In the event that a manual-changeover signal is not acknowledged by the other exchange, a suitable interval shall elapse (e.g. one minute), before the request is repeated. If the second manual-changeover signal is not acknowledged, the maintenance staff at the exchange requesting changeover should be alerted.

d) Changeback from the reserve link will always be to the regular link and is initiated by the end which previously initiated the manual changeover. The procedure used is the same as the normal changeback as described in § 8.6.2 above. In the event of simultaneous manual changeover, or in the case where the regular link is not the link from which manual changeover had originally taken place, either end can initiate the changeback to the regular link.

If the link from which manual changeover originally took place is not the regular link but is a synchronized reserve, the end initiating the manual changeover will initiate the restoration of the link to the standby ready-state as described in § 8.8 c) below. This will commence when the link is considered serviceable again and may occur independently of the load transfer to the regular link.

#### 8.6.3.2 *Load-transfer procedure (automatic)*

a) An automatic load-transfer from a quasi-associated routing or other synchronized reserve to a prepared non-synchronized reserve may be provided by agreement if desired by the Administrations concerned. This procedure may be used to limit the signalling traffic load at the signal transfer point or to maintain two synchronized links within the link set. Three types of automatic load-transfer are possible. In the first type, the signalling traffic for a group of bands using a signal transfer point is transferred back to the associated link set. In the second type, the signalling traffic in a link set is transferred from a synchronized reserve to a prepared non-synchronized reserve allowing the synchronized reserve to remain as a standby link. In the third type the signalling traffic from a failed load sharing link in a link set is transferred from the other load sharing link to a prepared non-synchronized reserve allowing the working load sharing link and the prepared reserve to remain as mutual reserves.

b) Subsequent to the initial transfer of signalling traffic to a synchronized reserve, both exchanges attempt to achieve synchronization on a secondary reserve facility. If more than one facility is provided, the two exchanges use the following selection procedure to establish synchronization on a secondary facility.

Each exchange will select the first choice non-synchronized reserve and will attempt to synchronize for a prearranged time interval of 5 +/- 0.25 seconds at one exchange and 7.5 +/- 0.25 seconds at the other. The selection sequence and the time interval will be fixed by bilateral agreement. If synchronization is not accomplished within the specified time interval, an attempt is made to synchronize on each of the available reserves in turn. If unsuccessful on the last choice non-synchronized reserve, the selection cycle is repeated unless the regular link has become operative. The difference in timing at the two exchanges ensures that even in the event the exchanges do not attempt synchronization on the same reserve initially, both exchanges will ultimately meet on the reserve for a minimum interval of 2 seconds.

When synchronism is established on the reserve and the error rate has been acceptable during the one minute proving period, load-transfer and load-transfer-acknowledgement signals are interchanged on the selected reserve prior to transfer of the traffic as described in § 8.6.3.1 above. Signal units originally transmitted on the synchronized reserve are retransmitted as necessary on the same reserve.

### 8.7 EMERGENCY RESTART PROCEDURE

a) The emergency restart procedure is intended to re-establish signalling communication on a link set between two exchanges without waiting for the one-minute proving period, whenever the regular, and all synchronized links in the link set of lower priority than the last working links, have failed, or non-synchronized reserve links cannot be synchronized within 2 to 3 seconds of failure of the working link. Any link between the two exchanges which has achieved synchronism and has passed the emergency proving period (see Recommendation Q.291, § 8.3.3) will be selected to re-establish signalling communication. Maintenance personnel are alerted whenever an emergency restart condition exists. Either exchange may unilaterally commence the emergency restart procedure and the other exchange must respond even though it is unaware of an emergency signalling situation. The emergency restart procedure will be initiated on a link set even though all the signalling traffic may have successfully transferred to quasi-associated reserves. However, the emergency restart procedure will not be initiated on a link set, if after termination of link set signalling a manually changed-over link remains in the link set. In this case, the link set carries out the emergency restart procedure only if the subsequent failure of a signalling route set occurs [except STP signalling route sets, see § 8.6.3.1 a)]. This failure would be for signalling traffic transferred from the link set to a quasi-associated routing at the manual changeover. Therefore, the manually changed-over link can be included in the emergency restart procedure if it is capable of being synchronized and emergency proved.



b) If faulty-link information is being sent on a previously failed link, it will continue to be sent until that link has passed its emergency proving period.

If at any time after the emergency proving period the signal unit error rate monitor indicates an unsatisfactory performance of the link, faulty-link information is again sent on the link and the change-over or emergency restart procedure is begun.

To minimize the number of calls affected by the emergency restart condition, Recommendation Q.291, § 8.1 should be followed, particularly the recommendation to remove free speech circuits from service. However, this will only be necessary when the link-set failure has caused the failure of an entire signalling route set, and hence no quasi-associated routings are available.

The following procedure is designed to attempt emergency restart on as many signalling links as possible at the same time. Both exchanges will simultaneously connect terminals to as many voice-frequency links as possible between the two exchanges. Quasi-associated signalling routes are excluded from this procedure. The regular link and all synchronized reserve links have terminals permanently assigned to them. Terminals for non-synchronized reserve links will be assigned from a pool of reserve terminals. Assume that the total number of links is  $n$  and the available number of reserve terminals is  $T$ . If  $T \geq n$ , then a reserve terminal is assigned to each of the  $n$  non-synchronized reserve links and synchronization is simultaneously attempted on all links. If  $T < n$ , then  $T - 1$  reserve terminals are assigned to as many non-synchronized reserve links, and one terminal will be cycled through the remaining non-synchronized reserve links following the procedure described in § 8.6.3.2 b) above.

Idle status of previously engaged nominated speech circuits at each exchange during the emergency restart procedure is recognized either by reception of a clear-forward signal from a preceding exchange or by reception of a clear-back signal from a succeeding exchange.

c) When one or more links have passed the emergency proving period, two emergency-load-transfer signals are sent periodically (at 2-3 seconds intervals) over each link. Each exchange may receive signals on the links during the emergency restart procedure and must take steps either to process these signals or deliberately reject them by setting the relevant ACU indicators to **1**. However, after sending ELT signals on any link, all signals received on the link must be processed. Although both exchanges may send emergency-load-transfer signals, only one exchange (designated the emergency restart control exchange by mutual agreement of the two Administrations) will acknowledge these signals. The non-control exchange must respond by sending emergency-load-transfer signals over the same signalling link, whenever it receives these signals and the link has passed the emergency proving period.

Both exchanges continue sending pairs of emergency-load-transfer signals at 2-3 seconds intervals over links which have passed the emergency proving period until the control exchange has sent two load-transfer-acknowledgement signals and one has been received by the non-control exchange.

Upon receiving two emergency-load-transfer signals within 3 seconds on one or more links, the control exchange will select one of these links which has passed the emergency proving period and respond with two load-transfer-acknowledgement signals. The control exchange may now start sending signalling traffic over this link. The non-control exchange may also commence signalling traffic when it receives a load-transfer-acknowledgement signal. The signalling traffic that is restarted (or allowed for STP traffic) will be for bands where no working signalling path is at that time available via this exchange. Other signalling traffic may only be transferred from working links after the one-minute proving period using the normal changeback or automatic load transfer procedures.

This interchange of signals will take place even if the selected link had previously been manually changed-over, and irrespective of whether or not the control exchange had initiated the manual change-over. Once the link is selected the manual change-over condition will be removed at both ends.

A guard period of  $5 \pm 1$  seconds shall be commenced on transfer of traffic to the selected link. During this guard period, any emergency-load-transfer signals, received at the control exchange on the link on which traffic has been resumed, shall be acknowledged. Emergency-load-transfer signals received on any other link, between the two exchanges, or received by the non-control exchange on any link, shall be ignored. If, during the guard period, the signal unit error rate monitor indicates an unsatisfactory performance of the link carrying traffic or if faulty-link information is received on that link, then the guard period is terminated and § 8.7 b), second paragraph applies.

After the emergency restart procedure has been terminated, subsequent failures are treated in the normal manner. The load-transfer or standby-ready signalling sequences are not initiated on the selected link during the emergency restart procedure, although they shall be sent after the one-minute proving period in order to carry out the normal changeback and automatic load transfer procedures or to confirm the proving status of the link for subsequent link security procedures.

If an exchange receives two emergency-load-transfer signals, it must respond in the manner described and transfer signalling traffic to the indicated signalling link, even though it may not be in the emergency restart state.

## **8.8 FULL-TIME SYNCHRONIZED RESERVE LINKS**

### **8.8.1 *Failure of a synchronized reserve link***

On detection of failure of a synchronized reserve link, the terminal starts sending faulty-link information as described in § 8.6.1 a) above. Receipt of faulty-link information indicates that the link is not suitable for use as a reserve.

### **8.8.2 *Removal of a full-time synchronized reserve link from service availability***

It may be necessary, for reasons of rearrangements, changes, maintenance, etc., to remove a full-time synchronized reserve link, which is not currently carrying the signalling traffic for the link set, from service availability.

In this case the Exchange A desiring the removal will send a manual-changeover signal on the reserve link. On receipt of this signal Exchange B will mark the reserve as unavailable for service and respond with a manual changeover-acknowledgement signal. Exchange A, on receipt of the acknowledgement signal, will also mark the reserve as unavailable for service and may then continue to transmit SYUs or ACUs in the normal manner or may remove the link from service. Exchange B acknowledging the removal should maintain synchronism and, should the link be removed, detect loss of synchronization. Subsequent to these actions the provisions for inclusion of the reserve link in an emergency restart procedure apply as specified in § 8.7 a).

In the event that the manual-changeover signal is not acknowledged by the other exchange, a suitable interval shall elapse (e.g. one minute), before the request is repeated. If the second manual-changeover is not acknowledged the exchange initiating the removal may unilaterally remove the link from service (provided that it is still acting as a reserve and is not carrying signal traffic) by sending faulty link information or disconnection of the carrier but may not mark the link as unavailable and continue to transmit SYUs + ACUs in the normal manner.

Restoration of the reserve link from unavailable to available (standby ready) status will be initiated by the end which previously initiated the removal using the procedure described in § 8.8.3) below.

### **8.8.3 *Restoration of a synchronized reserve link***

When both terminals are again in synchronism over the reserve link and the error rate has met the requirement for the one-minute proving period (see Recommendation Q.291, § 8.3.3), the faulty-link information will be replaced with blocks of SYU (plus ACU) to indicate that the proving period has been completed.

To confirm that the proving period has been completed at both exchanges, the exchange A finishing the proving period sends two standby-ready signals on the reserve link.

When exchange B receives a standby-ready signal and knows the reserve link is usable, it responds with a standby-ready-acknowledgement signal on the reserve link. When exchange A receives one standby-ready-acknowledgement signal, it has confirmation that the reserve link is available for use.

## 8.9 LOAD SHARING METHOD

The load sharing method is described in § 8.4.2 a). The method implies that the total signalling load on the link set is shared between two working links. Steps should be taken to ensure that the load is approximately equalized between the two links. This will normally be done by allocating each circuit to one of the signalling links as its regular link, and arranging for half of the total number of circuits to be allocated to each link. Although not mentioned in § 8.4.2 a), other allocation methods are possible such as allocating each circuit to one of the signalling links on a per-call basis. This follows from the fact that under failure conditions on one link the signalling traffic will be transferred to the remaining link and hence each exchange must be capable of accepting signalling traffic for all labels on either link. It is therefore unnecessary for both exchanges to use the same allocation method for their outgoing signalling traffic and each Administration will decide on a suitable method. (For example, free option for each label, an odd-even label basis, a per-band basis or a per-call basis.)

It must be ensured that one signalling link can handle all the signalling traffic without unacceptable queueing delays. Load sharing should not, therefore, be used to increase the signalling capacity of a link set. If extra capacity is required, then a second link set with separate links should be provided.

When a faulty link within a load-shared pair becomes workable again, the procedure used is the changeback procedure of § 8.6.2 (and not the procedure of § 8.8). The signals standby-ready and standby-ready-acknowledgement are not used. As both links remain in use, the  $5 \pm 1$  second guard timing is not used.

In general, any link set will probably contain a maximum of two synchronized links, although more may be provided by agreement between Administrations. Normally there will be no mixing between different security arrangements (i.e., a load shared pair with full-time synchronized reserves, etc.) although it may be provided by agreement between Administrations.

## SECTION 9

### TESTING AND MAINTENANCE

#### Recommendation Q.295

#### 9.1 OVERALL TESTS OF SIGNALLING SYSTEM No. 6

##### 9.1.1 *Automatic operational tests of circuits served*

Information can be gained on faulty operation of System No. 6 from overall operational tests of international circuits served by the system. Such tests can be performed by the use of the automatic transmission measuring and signalling testing equipment (ATME 2 – Recommendation O.22). In accordance with Recommendation Q.258, the information to be transmitted in the IAM is the following:

Country-code indicator ..... No country code included  
Nature-of-circuit indicator ..... As appropriate  
Echo suppressor indicator ..... Outgoing half-echo suppressor not included  
Calling-party's category indicator ..... Test call  
Address signals ..... **X + ST**

This format allows 16 types of tests, both for transmission and signalling. If more are required, an additional address signal can be used.

The following **X** address signal codes are assigned:

**0 0 0 0** System No. 6 continuity check, see Recommendation Q.261, § 4.1.4  
**0 0 0 1** ATME 2, Signalling check and transmission test  
**0 0 1 0** ATME 2, Signalling check only  
**0 0 1 1** Quiet termination test line  
**0 1 0 0** Echo suppressor test system  
**0 1 0 1** Loop around test line  
**0 1 1 0** Transmission access test line  
**0 1 1 1** Transmission access test line  
**1 0 0 0** Transmission access test line  
**1 0 0 1** Echo Canceller test line

All test calls are completed with the clear-forward and release-guard sequence regardless of the outcome of the test.

All test calls must be allowed to be completed (for example to the responding equipment of ATME 2), even if there is a failure of the continuity check. On test calls, therefore, the continuity signal will be sent irrespective of the result of the continuity check of the speech path.

##### 9.1.2 *Signal unit error rate monitor*

The signal unit error rate monitor, which is described in Recommendation Q.291, § 8.3.2, also provides a means of detecting deterioration of the data link. When the error rate exceeds 0.2% for a period of 6 to 10 minutes, an alarm should be given to alert maintenance personnel.

## 9.2 SIGNALLING DATA LINK

The data link is composed of two one-way data channels. In general, the maintenance functions are performed independently for each direction of transmission.

For maintenance purposes each data channel may be considered to be composed of the following elements:

- Analogue version
  - a) a voice frequency channel;
  - b) the modulator and demodulator;
  - c) a data carrier failure detector.
- Digital version
  - a) a digital channel,
  - b) the digital interface adaptor at each end;
  - c) a loss of frame alignment detector.

The data channel and its constituent parts must be tested to ensure that they meet the requirements of Recommendation Q.272.

### 9.2.1 *Maintenance safeguard*

Since interruptions of the data link will affect many speech circuits, the data channels must be treated with the utmost care. Appropriate special measures should be taken to prevent unauthorized maintenance access which could result in interruptions to service. These special measures may include marking or flagging the equipment and appearances on distribution frames or test bays where access is possible (see Recommendation M.1050).

### 9.2.2 *Voice-frequency channel line-up and maintenance*

The recommendations for the line-up and maintenance of the voice-frequency channel are taken from Recommendation M.1050, taking also into account Recommendation Q.272, § 6.1.3.

#### 9.2.2.1 *Line-up*

The voice-frequency channel line-up must be done in such a way as to ensure that the attenuation/ frequency and delay/frequency distortions meet the requirements of Recommendation Q.272, § 6.1.3, within the frequency band 1000 to 2600 Hz. In addition, the uniform spectrum random noise and impulsive noise requirements of Recommendation Q.272 must be met at the receiving end.

#### 9.2.2.2 *Maintenance*

To ensure proper operation of the common channel signalling system, it will be necessary to schedule preventive maintenance for the voice-frequency channel. The tests to be made as a routine measure are:

	<i>Test</i>	<i>Periodicity</i>
a)	Overall loss at 800 Hz .....	See Table 1/M.610, column 3
b)	Attenuation frequency distortion.....	Annually
c)	Delay/frequency distortion .....	Annually
d)	Noise .....	See Table 1/M.610, column 3

### 9.2.3 *Digital channel line-up and maintenance*

Tests should be applied to ensure that the digital channel meets the requirements given in Recommendation Q.46 or Q.47.

### 9.2.4 *Data carrier failure and loss of frame alignment detector tests*

Local tests should be applied to ensure that the data carrier failure detector and the loss of frame alignment detector meet the requirements given in Recommendation Q.275.

### 9.2.5 *Modem tests*

Modems should be tested locally to ensure that the requirements of Recommendation Q.274 are met. Appropriate arrangements should be provided so that tests may be made independently of the voice-frequency channel and other equipment.

### 9.2.6 *Interface adaptor tests*

The interface adaptors used in the digital version of System No. 6 should be tested locally to ensure that the requirements of Recommendation Q.274 are met.

### 9.2.7 *Data channel line-up and maintenance*

#### 9.2.7.1 *Line-up*

After verifying that the transmission path meets the requirements (§§ 9.2.2.1, 9.2.3 above), the data channel error rate should be checked for a period of 15 minutes (without interruption) using the equipment described in § 9.2.8 below. The error rate requirements are given in Recommendation Q.272, § 6.1.2.

#### 9.2.7.2 *Routine maintenance*

The checks described in § 9.2.7.1 above should be made each time routine noise tests of the voice frequency channel (see § 9.2.2.2 above) or tests (see § 9.2.3 above) of the digital channel are required.

### 9.2.8 *Data test equipment*

The equipment for testing the data channel error rate consists of a pseudo-random bit stream generator to be connected to the input of the transmitting end of the data channel and a monitor to be connected to the output of the corresponding receiving end.

The bit stream to be generated, as specified in Recommendation V.52, is reproduced in Annex A to this Recommendation.

9.3 (Reserved)

9.4 (Reserved)

## 9.5 NETWORK MAINTENANCE

Network maintenance signals relate to the maintenance of the telephone network. They refer normally to groups of circuits, exchanges, etc., rather than to individual circuits and relate to maintenance activity rather than the rerouting of traffic to provide continuing service.

### 9.5.1 *Reset-band signal*

In systems which maintain circuit status in software, there may be very rare occasions when large blocks of memory are erased during an emergency action or are accidentally mutilated. In these cases, the sending of the reset-circuit signal would be too laborious during recovery procedures, and two reset-band signals will be sent for each affected group or subgroup of circuits (label band number). The memory should be reconstructed according to the response received in the reset-band-acknowledgement message. Any interconnected circuits may be cleared by the use of an appropriate signal.

The unaffected exchange receiving a reset-band signal twice within a period of 5 seconds will:

- 1) make the circuits idle in the designated band, except those circuits at the receiving end that have imposed a blocked condition on the sending end,
- 2) send the appropriate clearing signal (clear-forward, clear-back) on any tandem-connected circuits, and
- 3) respond with a reset-band-acknowledgement message for the designated band coded as follows:
  - *band number*: same band number as received reset-band signal
  - *circuit status indicators*: i) for all circuits idle, coded as described in § 3.4.2.3 d) in an LSU; ii) for any other status condition, coded as described in the last (1 1 1 1) entry of § 3.4.2.4 e), with 0 to indicate available for service, 1 to indicate unavailable for service due to blocked condition. In this case a two unit message results.

Should a reset-band signal be received after sending a reset-band signal, but before receiving a reset-band acknowledgement message indicating that both exchanges have lost memory, the response should be a reset-band-acknowledgement, all circuits idle LSU. If the exchange has not been arranged to avoid all-zero signal units by recourse to the LSU established to supersede the prior RBA coding, the original two-unit message remains applicable. Although the new LSU is recommended, no time has been set to remove the validity of the reset-band-acknowledgement as originally coded.

Maintenance status should then be established manually by maintenance personnel especially for those circuits in the installation and testing process. Faulty circuits will be detected during the continuity check on the first call attempt.

When both exchanges are arranged to handle reset-circuit and band signals, if no reset-band acknowledgement is received before 4-15 seconds after sending the second reset-band signal, the reset-circuit signal should be sent for each affected circuit. If an acknowledgement signal for the reset-circuit signal is not received within a period of one minute after the sending of the initial reset signal, maintenance personnel should be notified to facilitate manual restoration procedures. The sending of the reset-circuit signal should continue at one minute intervals until maintenance intervention occurs.

The use of reset-circuit and reset-band signals is optional. Therefore, in the situation where only one exchange is arranged to handle these signals, if no acknowledgement is received for either signal, the signalling procedure should be ceased and maintenance personnel notified to facilitate manual restoration of affected circuits. Although the indicated signals are optional, the ability to cooperate with exchanges transmitting them should be regarded as the preferred status.

To the extent that selective use of the reset-band signal improves recovery from other fault situations, its use for this purpose is permitted.

In the event that reset signals are received at an STP, the following procedures apply:

- 1) An STP receiving a reset-band, reset-band-acknowledgement or reset-circuit signal will forward the signal on the opposite signalling route in the normal manner, after band number translation (if required);
- 2) If an STP transmits a Transfer Prohibited Signal (TFP) and subsequently receives:
  - a) a reset-circuit signal: a message-refusal signal shall be returned;
  - b) a reset-band signal: the TFP signal shall be repeated;
  - c) a reset-band-acknowledgement: the TFP signal shall be repeated.

Actions b) and c) allow the failed exchange to reconstruct its transfer status information. It is assumed that any re-initialization should cause all connected STPs to appear to have transfer status "Allowed".

ANNEX A

(to Recommendation Q.295)

**Pseudo-random test pattern**

In order to test circuits for data transmission on an international basis, it is necessary to standardize the test patterns to be used. Such a pattern should be a pseudo-random one having the following characteristics:

- 1) it should contain all or at least the majority of eight-bit sequences likely to be met in the transmission of actual data;
- 2) it should contain sequences of 0s and 1s as long as possible compatible with ease of generation;
- 3) the pattern should be of sufficient length such that at data transmission rates higher than 1200 bits per second its duration is significant compared with line noise disturbances.

Accordingly, a 511-bit test pattern is chosen. The pattern is generated in a nine-stage shift register whose fifth and ninth stage outputs are added together in a modulo-two addition stage, and the result is fed back to the input of the first stage. The modulo-two adder is such that the output produces an output 0 when the two inputs are similar and an output 1 when the two inputs are dissimilar.

Table 11/Q.295 shows the state of each stage of the shift register during the transmission of the first 15 bits. The pattern over a longer period is

**1 1 1 1 1 1 1 1 0 0 0 0 1 1 1 1 0 1 1 1 1 0 0 0 1 0 1 1 1 0 0 1 1 0 0 1 1 0 0 ...**

It is clear from the table that this pattern is the sequence of bits in stage 9 of the shift register but it also represents the sequence in any other stage shifted in time. The choice of stage to be connected to the output is therefore a matter of circuit convenience.

TABLE 11/Q.295

**Shift-register stages during pseudo-random test pattern generation**

									Output
↓	1	2	3	4	5	6	7	8	↑
1	1	1	1	1	1	1	1	1	1
0	1	1	1	1	1	1	1	1	1
0	0	1	1	1	1	1	1	1	1
0	0	0	1	1	1	1	1	1	1
0	0	0	0	1	1	1	1	1	1
0	0	0	0	0	1	1	1	1	1
1	0	0	0	0	0	1	1	1	1
1	1	0	0	0	0	0	0	1	1
1	1	1	0	0	0	0	0	0	1
1	1	1	1	0	0	0	0	0	0
0	1	1	1	1	0	0	0	0	0
1	0	1	1	1	1	0	0	0	0
1	1	0	1	1	1	1	0	0	0
1	1	1	0	1	1	1	1	1	0
1	1	1	1	0	1	1	1	1	1



## Recommendation Q.296

### 9.6 MONITORING AND MAINTENANCE OF THE COMMON SIGNALLING CHANNEL

#### 9.6.1 *General*

The purpose of the facilities and equipment described in this Recommendation is as follows:

- i) To enable, by means of independent equipment connected directly to the No. 6 transfer link, the observation by maintenance staff of any or all signals on the link for reasons of maintenance on the common channel signalling system itself. (Telephony maintenance observations in general should be performed by the same means as utilized by maintenance staff for the other signalling system types implemented in the switching centre.)
- ii) To enable, by means of independent equipment connected in tandem with the No. 6 transfer link, the generation of signals in connection with pre-service testing according to the CCITT No. 6 Test Schedule, published as an ITU Manual. (*Note* – use of this equipment requires the breaking of the transfer link, and is not appropriate in a maintenance environment).
- iii) To enable, by means of facilities which may be included in the System No. 6 implementation, the recording and mutual exchange by Administrations of an effective but economical set of performance statistics for the signalling link network and for individual signalling links.

#### 9.6.2 *Signalling monitor*

##### 9.6.2.1 *General requirements for signal monitoring equipment*

The Signalling System No. 6 Data Link Monitor shall be independent of the signalling equipment, to ensure that the performance of the monitor is independent of any fault in the equipment being tested. The monitor should allow full access to the data on a Number 6 transfer link as well as facilities for selecting particular signals under operator control. As it is considered necessary under some conditions to observe signals in both directions on both a regular and one reserve link, as well as signals entering and leaving an STP function, the monitor should be capable of simultaneously monitoring at least two transfer links (i.e. four transfer channels).

##### 9.6.2.2 *Monitor configuration*

The monitoring system would consist of three basic subsystems: the demodulation equipment (or digital interface for the digital version of System No. 6), the Computer, and I/O Equipment.

The demodulation equipment for analogue data (or the corresponding digital interface adaptor) must be of a high impedance type so as not to present a load when connected to the transfer link.

The Computer Subsystem will perform the majority of logic and processing functions in the system. The implementation chosen must, however, allow the repertoire of signals the monitor can handle to be updated as additions are made to the Specification of Signalling System No. 6 (refer § 9.6.2.7). The functions required of the Computer Subsystem include the following:

- interfacing to the demodulation equipment (or digital interface) and receiving the signal units;
- storage for signal units (with check bits) to be processed;
- processing functions;
- the man-machine interface (I/O subsystem).

The I/O subsystem consists of a hard copy output device. As an option a visual display unit could be provided to allow higher output speeds and the ability to avoid large amounts of hard copy.

#### 9.6.2.3 *Functional specification*

##### a) *Synchronism*

The system must be capable of attaining signal unit synchronism regardless of the signal units on the data link. Since this synchronism will be attained by the detection of SYUs, the system must be capable of maintaining synchronism in the event of sustained absence of SYUs (e.g. during changeovers).

Bit, Block and multi-block synchronism should be constantly monitored and suitable messages stored and/or displayed to inform the operator.

The check bits of each signal unit should be verified as soon as the signal is received to allow special treatment of signals units received in error.

In the event of a carrier failure a suitable indication must be given to the operator. Similarly, when the carrier is restored, the operator must be informed.

##### b) *Signal types*

No. 6 signals are categorized in Recommendations Q.257 to Q.260 into the following types: Telephony, Control and Management. The majority of signal processing functions shall be based upon specifying any combination of these signal types. Signals received in error are treated as another signal type. Each signal type has particular processing requirements as detailed in the following section.

###### i) *Telephone signals*

To monitor a call, a facility is required to be able to store or display signal units which relate to a specific band and telephone circuit. Since an SSU which contains the information field in a MUM carries no label field it cannot be detected by scanning label fields only. Thus special account must be taken of SSUs.

###### ii) *Signalling-system-control signals*

Control signals have no label field and therefore cannot be further processed. As an option, the facility may be provided to suppress output of changeover signal units under the control of the operator to reduce the number of signal units which must be stored or displayed during a changeover.

###### iii) *Management signals*

The label field of some management signals contains a band number. A facility should be provided to allow only signals relating to a selected band or bands to be stored or displayed. The SSUs contained in a MUM must be handled as previously detailed in 9.6.2.3, b), i).

##### c) *Modes of operation*

Three distinct modes of operation shall be provided to allow the operator to view the type of information required at the rate required.

- A "Statistics" mode capable of quickly gathering specified information relating to the status and behaviour of the link itself. It is expected that this mode will be used for the following purposes:
  - i) to obtain a quick indication of the error rate on the link, and the condition of the link (bit signal unit or multi-block synchronism achieved);
  - ii) to assist investigation into why a link between two No. 6 signalling terminals will not synchronize;
  - iii) to demonstrate that the monitor can achieve signal unit synchronism, so that output in the other modes can be used with confidence;
  - iv) to determine the average signal unit loading on the link.

- An "Immediate Mode" capable of presenting to the operator in a quickly readable form some or all of the signals passing on the link. In this mode it is expected that behaviour of the link at a bit level is not of interest, and in order to reduce the quantity of information displayed, no ACUs, SYUs or information in binary form (including check bits) would be displayed.
- A "Deferred Mode", capable of storing all bits received on the link for a period of time, to allow later investigation of link behaviour at bit level. (*Note* – This does not preclude the use of compression techniques for storage of SYUs, ACUs and check bits, as long as validity checks are performed before compression.) In this mode storage will be necessary, since the rate of receipt of information will be too great for an operator to handle in real time, and therefore facilities must be provided to allow the operator to recover and examine stored data.

d) *Statistics mode*

During periods of link instability, it is desirable to obtain statistics relating to the behaviour and synchronization status of the link. It is also desirable to be able to measure the average loading of the link. The following should be counted for a time specified by the operator:

- signal units;
- signal units received in error;
- number of signal units retransmitted;
- ACUs;
- sequence errors;
- carrier failures (the duration of the carrier-off condition should also be measured);
- zero signal units;
- undersized/oversized blocks;
- block acknowledge/complete skips/repeats;
- average valid signal units per block, between 0 to 11 excluding ACUS. (*Note* – From this it is possible to calculate loading in Erlangs or as a percentage.)

As an option the facility to allow continuous monitoring of link performance with periodic production of hard copy results could be provided.

e) *Immediate mode*

The Immediate mode allows the display immediately upon receipt of specified signal types with specified labels if desired. The output must be presented in chronological order so that the operator is in no confusion over the order of occurrence of the signals. The signals on each link shall be displayed simultaneously and in clear time relationship with each other.

A time stamp of the time each signal unit was received should be displayed alongside each signal unit if possible. Otherwise IAM and SAM signals should be time stamped, and further time stamps given at regular intervals if signals are being displayed.

Facilities must be provided to allow the operation to vary the output speed of each signal unit on the display to ensure that the output is not too fast to read on a visual display output terminal.

f) *Deferred mode*

The Deferred mode is used to closely analyse signals on a link or links for a period not less than 2 minutes, to allow storage of all signals exchanged (including check bits) during the 60 second "Normal Proving Period" (see Recommendation Q.278).

Efficient and flexible scanning facilities shall be provided to allow the operator to locate signals of interest easily. The signals shall be stored on a block basis, with time stamp identifying each block. All scanning and display can then be performed on a block basis.

#### 9.6.2.4 *Triggering for immediate and deferred modes*

The display or storage processes in the Immediate and Deferred Modes require some form of trigger event to allow them to begin or end. The provision of a wide range of trigger events adds considerable power to the monitor.

A suitable trigger event is the reception by the signalling monitor of a specific signal unit or signal type specified by the operator, or an appropriate operator command. When the operator specifies a trigger event, it also should be specified whether the trigger event will be used to start or stop the recording, and whether the monitor will record the data received before the trigger event, after the trigger event, or both immediately before and after the trigger event.

#### 9.6.2.5 *Output forms*

Signal Units shall be displayed as mnemonics in abbreviated form (e.g. CLF B = 5, C = 6 for a clear forward on Band 5, Circuit 6) with all the data in the information field in a suitable form. A command shall be provided to enable the output of the mnemonic and a bit representation of the signal unit.

The output shall distinguish between signals received in error, unrecognized signals and reserved signals. Unrecognized and reserved signals shall be categorized as belonging to all signal types to ensure that they are always displayed.

Hard copy output shall include a page header with the time/date and mode of operation.

#### 9.6.2.6 *Operator facilities*

The operator shall be able to perform all functions with the minimum of keystrokes. There must be facilities to set the current time and to initialize and/or restart the system.

#### 9.6.2.7 *Addition of signals*

Since new No. 6 signals are defined by Study Group XI from time to time, the facility must exist to allow easy additions to the repertoire of signals. This could be achieved by decoding signals using a look-up table which is stored in Read-Only-Memory, which can be modified if necessary.

### 9.6.3 *Signal manipulator* (see Figure 25/Q.296)

#### 9.6.3.1 *Preamble*

During pre-service testing of Signalling System No. 6 between Administrations, in order to execute certain tests specified in the ITU Manual entitled "CCITT Signalling System No. 6 Test Schedule", it is necessary to inject messages out of sequence, and to withhold certain signals. It is preferable for these actions to be performed by separate test equipment. Advantages of economy may be obtained by realizing such an interactive signalling system No. 6 link test set as part of the signalling system No. 6 link monitor, described previously.

#### 9.6.3.2 *Functional description*

The interactive test set should be equipped with two modems (or the corresponding digital interfaces) and inserted serially in one transfer channel of the data link (Figure 25/Q.296 refers). While the data flows through the set in one direction, the data that flows in the other direction in the other transfer channel should be uninterrupted. After insertion into the transfer channel, the test set should synchronize automatically and give an indication once system synchronization has been achieved. Upon achieving synchronization, the system must continually check each block, to ensure that synchronism still exists. If block synchronism is subsequently lost, automatic resynchronization should be initiated and an indication of loss of synchronization be given. Operator commands should be accepted only when synchronization exists.

When the set is in the idle state, it should appear completely transparent to the two system No. 6 exchanges between which it is inserted, except for a maximum propagation of the order of one block time.

It is recommended that the interactive test set contain the following minimum functions, which should be executed upon operator command.

a) *Display signal unit*

A specified signal unit combined with a specified mask is searched for, and once a match is found, a specified number of successive signal units are displayed. This function enables monitoring of a sequence of events commencing with a specified trigger event.

b) *Replace signal unit*

A specified signal unit combined with a mask is searched for, and once found, is replaced by a second specified signal unit. There must be an automatic function for calculating and adding the 8 check bits to the specified 20 bits prior to the insertion of the signal unit in the output buffer. Furthermore, if the signal unit is to be replaced by an SYU, the last 4 bits specified in the SYU should be ignored and the sequence number recalculated automatically to reflect its position in the block.

This function may be used to delete, insert or replace signal units.

c) *Delay signal unit*

A specified signal unit is delayed by a variable time interval. A search is initiated for a specified signal unit combined with the mask, and once found, is automatically replaced by a SYU. After the specified interval of time has elapsed, the next received SYU should be replaced by the original SYU. The specified time should be taken as a minimum time interval since the time of arrival of an SYU is uncertain.

d) *Skip*

The sequence number in the SYU is incremented by a specified number. It may be useful to specify how many successive (if more than one) SYUs are to be affected by this skip function.

e) *Corrupt signal unit*

A specified number of signal units in a block are corrupted by inverting all 8 check bits in the signal unit. The inversion of check bits should begin with the first signal unit in the next block. It should also be possible to specify the number of blocks that are to be affected.

This function is useful in simulating a given error rate on the link.

f) *Manipulate ACU*

A number of functions to manipulate an ACU should be provided. One function should be provided that would modify the position of the ACU such that it is moved to a position other than the 12th position. It should be possible to specify the number of blocks to be modified in this manner. A second function should serve to replace a specified number of successive ACUs by SYUs (sequence number 0). A third function to be provided would cause the next ACU to contain a specified block completed number. It should be possible to specify the number of successive ACUs to be transmitted with this same number.

g) *Suppress transmit carrier*

The transmit carrier on the output side of the test set is interrupted by a specified time interval.

#### 9.6.4 *Measurement of signalling data link network performance*

##### 9.6.4.1 *Preamble*

Recommendation Q.272 specifies the transmission characteristics of both analogue and digital channels suitable for use as signalling data links. However, it is expected that the error performance and availability of circuits conforming to Recommendation Q.272 will be variable, and at present no performance limits have been specified except the 15 minute bit error rate described in Recommendation Q.295.

Therefore acceptability of a particular voice channel for use as a signalling data link is a matter for bilateral agreement by the administrations concerned.

To assist with the longer term maintenance of the common signalling channel network, it is recommended that facilities be provided to record the basic signalling data link performance supervision statistics specified below.

Deterioration in the performance supervision statistics (see Note 1) may indicate a need for maintenance staff to investigate in more detail the performance of a particular link, in which case the link maintenance statistics listed in § 9.6.4.3 below may be useful.

(Note – For these statistics to be useful in the maintenance environment, provision is required for corrections to be automatically made to the statistics in the event of an outage of the whole or a part of the common channel signalling equipment, or where this is not possible, a clear indication to maintenance staff that the recorded statistics are incomplete.)

#### 9.6.4.2 *Signalling performance supervision statistics*

The following indicators shall be computed for the duration of a standard Measurement Period, for purposes of comparison. The Measurement Period is seven days. The indicators may be recorded in hard copy form automatically or by operator command at the end of the Measurement Period, or may be output in a coded form for further computer analysis.

##### a) *Signalling route set performance supervision statistics*

- Signalling route set unavailability, expressed as a percentage of the Measurement Period (see Note 2);
- The number of outages (that is, the number of times the signalling route set enters a state of unavailability (see Note 2)).

##### b) *Signalling data link supervision statistics*

- Signalling data link unavailability, expressed as a percentage of the Measurement Period;
- The number of changeovers caused by overflow of the error rate monitor (Note 3);
- The number of changeovers which occur as a result of COV received from the distant end of the link (Note 3);
- The number of reserve link failures (Note 3);
- The number of times block synchronism is lost;
- The number of times multi-block synchronism is lost.

*Note 1* – No supervision statistics on a link set basis are recommended for measurement, because although it may be convenient to measure these, the availability of a complete signalling route set (which itself may consist of a link set) is a direct measure of the ability of the signalling data link network to be available to carry signals from one System No. 6 terminal to another. Emergency Restarts on a link set are not recommended for measurement because in some configurations, emergency restart may occur even when a link in the signalling route set is still available (e.g. a triangular network with exchanges conforming to the 1980 Yellow Book Q-recommendations).

*Note 2* – Unavailability of the signalling route set is defined as the condition in which no signalling data link in the signalling route set is in service.

*Note 3* – A link may be simultaneously both regular in one signalling relation and reserve in another.

9.6.4.3 Link maintenance statistics

[Note – The following list of indicators is not yet considered to be complete and is for further study.]

The following indicators shall be computed for a duration of time determined by the operator. The indicators may be recorded in hard copy automatically or by operator command, at the end of the Measurement Period or may be output in a coded form for further computer analysis:

- a) the number of losses of block synchronism;
- b) the number of occurrences of high error rate (reception of 30 consecutive signal units in error or detection of error rate over 2% in 30 seconds);
- c) the number of failures detected during a one minute proving period;
- d) the number of signal units received in error;
- e) the number of skipped or repeated ACUs;
- f) the number of signal units transmitted;
- g) the number of telephone signal units.

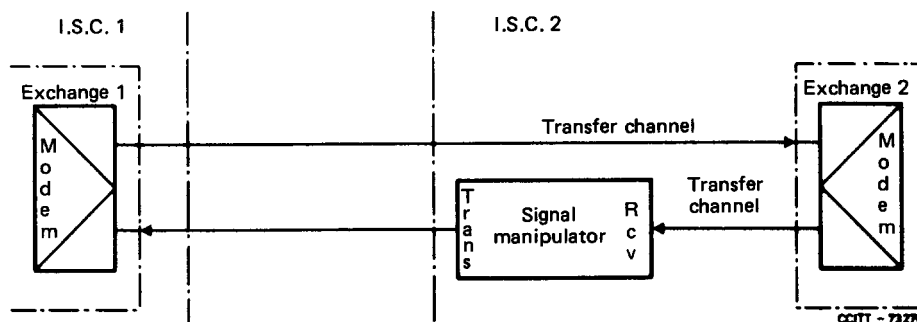

FIGURE 25/Q.296

## SECTION 10

### NETWORK MANAGEMENT

#### Recommendation Q.297

#### 10. NETWORK MANAGEMENT

##### 10.1 *General*

The application of Signalling System No. 6 for network management purposes was anticipated in the original coding structure of the signal units fundamental to the system. Specific coding was deferred until studies and understandings of intent were well established. The revision to the Red Book specification, of which this section is a part, makes a significant advance in extending the general utility of the system.

The expanded specification enables System No. 6 to fill the role of a transport mechanism for network management information passing System No. 6 equipped exchanges for which a network management band assignment has been made by bilateral agreement (or multilateral agreement). The information need not be limited to System No. 6 circuits nor to the two System No. 6 equipped exchanges.

The means of obtaining the requisite information to be transported, and the ability to respond to information received, must be provided by each Administration involved. Bilateral, or multilateral agreements are expected to clarify the inputs to and outputs from System No. 6 whilst the system will provide the capability to pass all signals allocated to Network Management information, including currently spare codes.

Two other understandings support the specification revision:

- i) the signals represent advice and do not constitute directives;
- ii) any screening of output signals by an originator is assumed to have taken place before the signals appear on the common channel.

Thus, an Administration may:

- i) choose to inspect information before allowing it to be sent;
- ii) send information automatically;
- iii) screen selected signals while sending others automatically.

##### 10.2 *Information categories*

10.2.1 It has been found useful to define basic information categories. Those now recognized are:

- i) destinations hard to reach;
- ii) all circuits busy;
- iii) switching centre congestion.

Coding is shown in § 3.4.2.4 b). Introductory text appears in § 3.4.2.1. The annex to this Recommendation contains a summary of the application of these information categories.

##### 10.2.2 *Destination Hard to Reach*

As indicated in the SSU format structure, it is possible to report on a number of traffic streams defined by up to 6 destination code digits at each of up to 16 ISCs through the same transport arrangements. This general purpose reason code covers Answer Bid Ratio (ABR) and can be set for up to 16 separate levels. Not all the destination code digits or the reason codes need be used, this being specified as part of the bilateral arrangements between Administrations which would also include assignment of the ISC code to which the information relates. The binary code assignment should conform to those listed in § 3.2.1.2 c) with filler digits and ST as appropriate.



### 10.2.3 *All circuits busy*

The same approach is followed for All Circuits Busy as for Destination Hard to Reach in § 10.2.2. Again, 16 circuit group conditions, specified by the reason code, can be catered for. Circuit groups are identified by up to a 6-digit code, and the information can relate to any of up to 16 ISCs. The parameter values of the reason codes will be assigned by bilateral agreement and may relate to the full occupancy condition or percentage occupancy conditions. Circuit group identities and ISC codes will also be bilaterally agreed.

### 10.2.4 *Switching Centre Congestion*

This information is coded compactly into one SSU in all cases. The ISC code again permits the condition reported to be related to any of up to 16 ISCs. The reason code covers up to 16 congestion levels although three levels are thought to be sufficient for most contingencies. Again, bilateral agreements will be necessary to assign congestion levels and ISC codes.

### 10.2.5 *Operational concerns*

Details relating to operational matters are covered in the E.410 series Recommendations. See especially Recommendation E.411. A related issue concerns false signals. A review of error correction measures incorporated in the design of System No. 6 concluded that no significant difficulty need be anticipated. The adoption of a rule whereby signals will be disregarded if not confirmed periodically should afford added protection. A time interval of 30 seconds, for example, could be adopted. The expiration of such an interval should affect signal processing external to the No. 6 transport system. Thus, a rare signal arising inadvertently could affect traffic for at most one such time interval. Regulation of signal volume is a similar concern. Even though management signals are of a lower priority than telephone signals, administrative avoidance of queuing extremes should be part of an operating plan.

## ANNEX

(to Recommendation Q.297)

### **The application of network management signals transported by System No. 6**

Section 10 of the System No. 6 specification identifies three information categories of Network Management Signals (NMS) which may be transported by System No. 6. Provision is made for each information category to transmit information relating to one of up to 16 reason codes. However, it is not envisaged that all 16 reason codes will be allocated during the initial applications of this capability. Following the experience gained from initial applications, however, a move towards a standardized range of reason codes for all users is likely to take place. In the intervening period, some guidance as to the allocation of reason codes is given in order to assist Administrations in making bilateral arrangements. Coding allocation of the reason codes is contained in § 3 of this specification whilst operational guidance for network management actions is contained in the E.410 series of Recommendations. A summary of the application of reason codes which have been initially allocated for each of the information categories, is as follows:

- a) Destination Hard to Reach NMS: This information relates to the performance of traffic to a destination. A destination is said to be Hard-to-Reach (HTR) when the Answer-Bid-Ratio (ABR) to the destination is abnormally low. A HTR code can be a country code, an area (or city) code or an exchange code. Initially, four reason codes have been allocated. One general purpose reason code covers ABR values below an arbitrary level whilst the other three reason codes relate to the level of ABR (High, Medium, Low) and could be used to identify the type and degree of network management action required.

- b) All Circuits Busy NMS: This information relates to the availability of circuits. A signal should indicate when all circuits in a route or to a destination are busy, or (preferably) when the remaining idle circuits in a route (or to a destination) are less than a specified number, or when occupancy of a route has exceeded the desired threshold. As with the Destination Hard to Reach NMS, four reason codes have been allocated initially. One reason code is allocated to "All Circuits Busy threshold" and will indicate that a predetermined number of circuits are busy or that the occupancy of a particular circuit group has exceeded a certain level. The threshold level would be set by bilateral agreement. Three other reason codes have been allocated to indicate Low, Medium and High Congestion levels. Each reason code, or combination of reason codes, could be used to identify the type, degree and duration of network management action required.
- c) Switching Centre Congestion NMS: This information relates to the Switching congestion of an ISC. Three reason codes have been allocated to indicate "moderate congestion", "serious congestion" and "unable to process calls". The function of this signal is to warn other Switching Centres that this particular ISC is experiencing overload. Appropriate Network Management actions can then be taken depending upon the degree of the problem identified by the particular reason code.

**ANNEX A TO SIGNALLING SYSTEM No. 6 SPECIFICATIONS**

(see Recommendation Q.261)

TABLE A-1

**Semi-automatic (SA) and automatic (A) terminal traffic**

(error-free operation assumed)

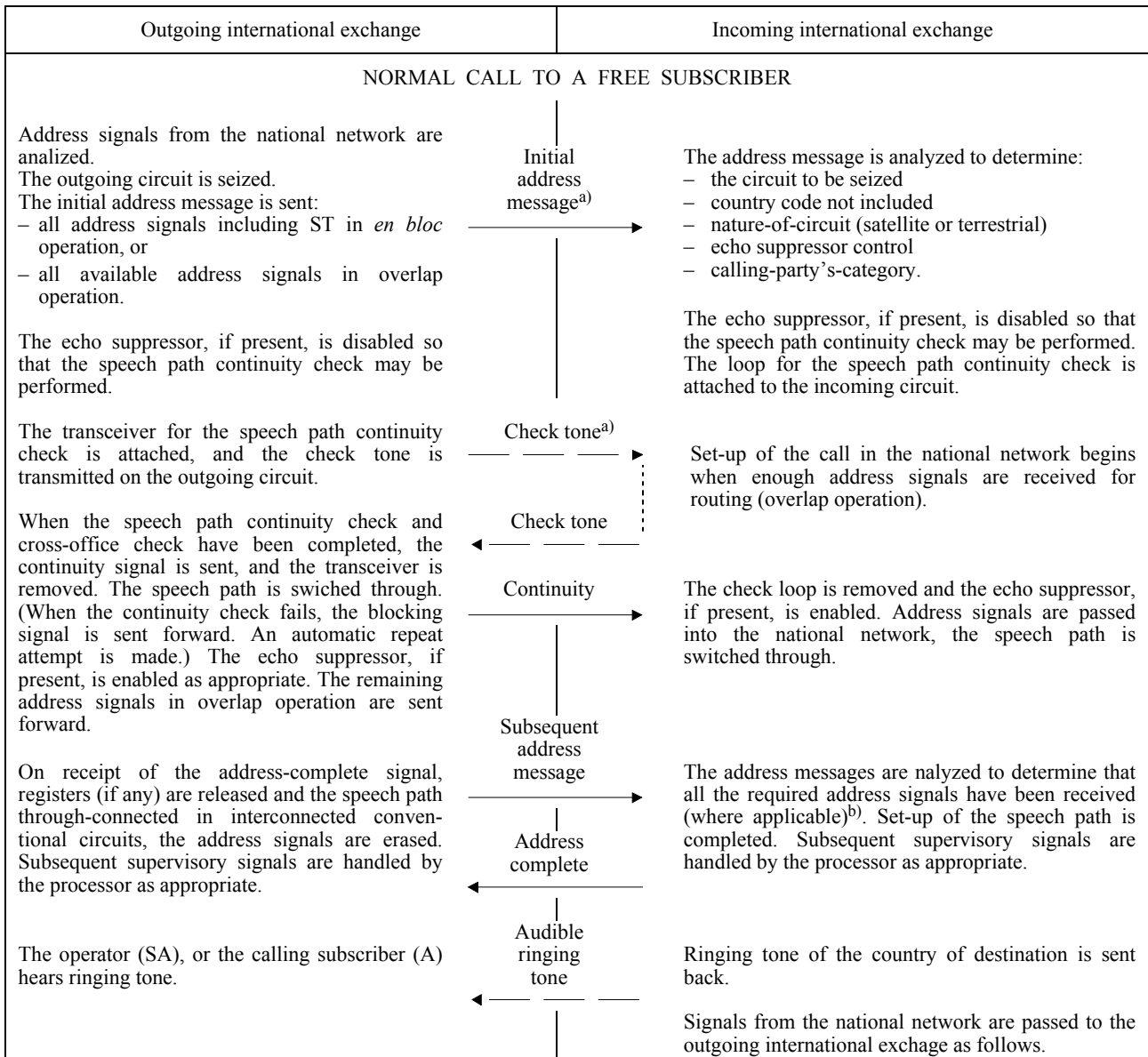

a) Solid arrows denote common channel signals; dotted arrows are tones, sent via the speech path (check tone and audible tones).

b) Address-complete signal may come from the national network.

TABLE A-1 (end)

Outgoing international exchange	Incoming international exchange
<p>On receipt of the answer signal, charging<sup>c)</sup>, measurement of call duration and conversation begin.</p>	<p>The called subscriber answers (charge or no charge).</p>
<p><i>Clear-back</i> is recognized.</p>	<p>The called subscriber hangs up.</p>
<p>SA: A clearing supervisory signal is given to the controlling operator.</p>	<p>SA and A: After 2-3 minutes, if there is no clearforward signal, the national part of the connection is released.</p>
<p>A: After 1-2 min, if there is no clear-forward signal, the international connection is released and charging and measurement of the call duration are ceased.</p>	
<p>The outgoing operator (SA) or the calling subscriber (A) clears. When the outgoing equipment is released, the clear-forward signal is sent.</p>	<p><i>Clear-forward</i> is recognized. The connection is released, and <i>clear-forward</i> is sent to the national network of destination</p>
<p><i>Release-guard</i> is recognized, and the outgoing circuit is made available for new traffic.</p>	<p>When the incoming equipment has released, a release-guard signal is sent back. The circuit is made available for new traffic.</p>

<sup>c)</sup> Unless a no-charge answer or address-complete signal has been received.

**TABLE A-2**  
**Semi-automatic (SA) and automatic (A) transit traffic**  
 (error-free operation assumed)

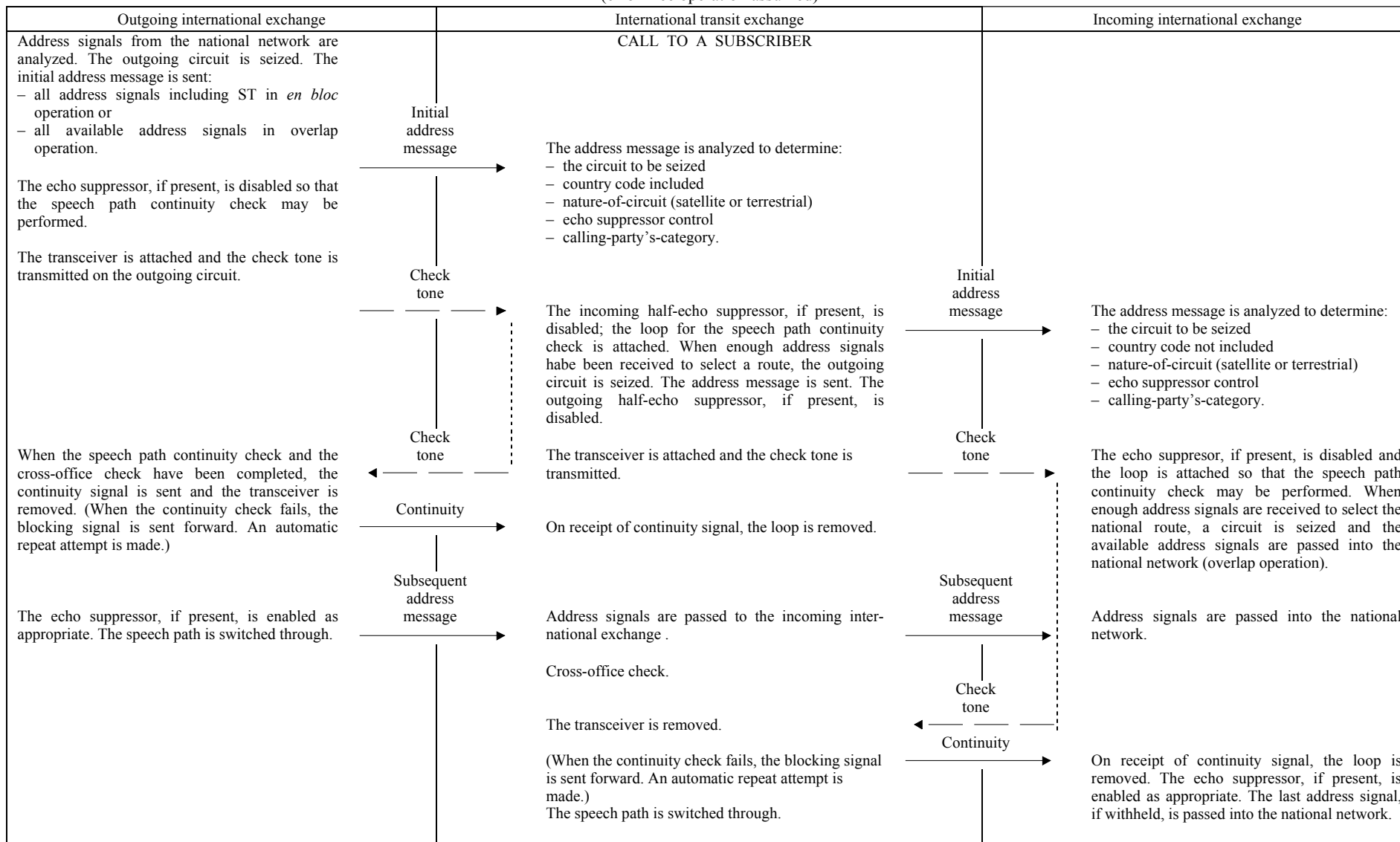
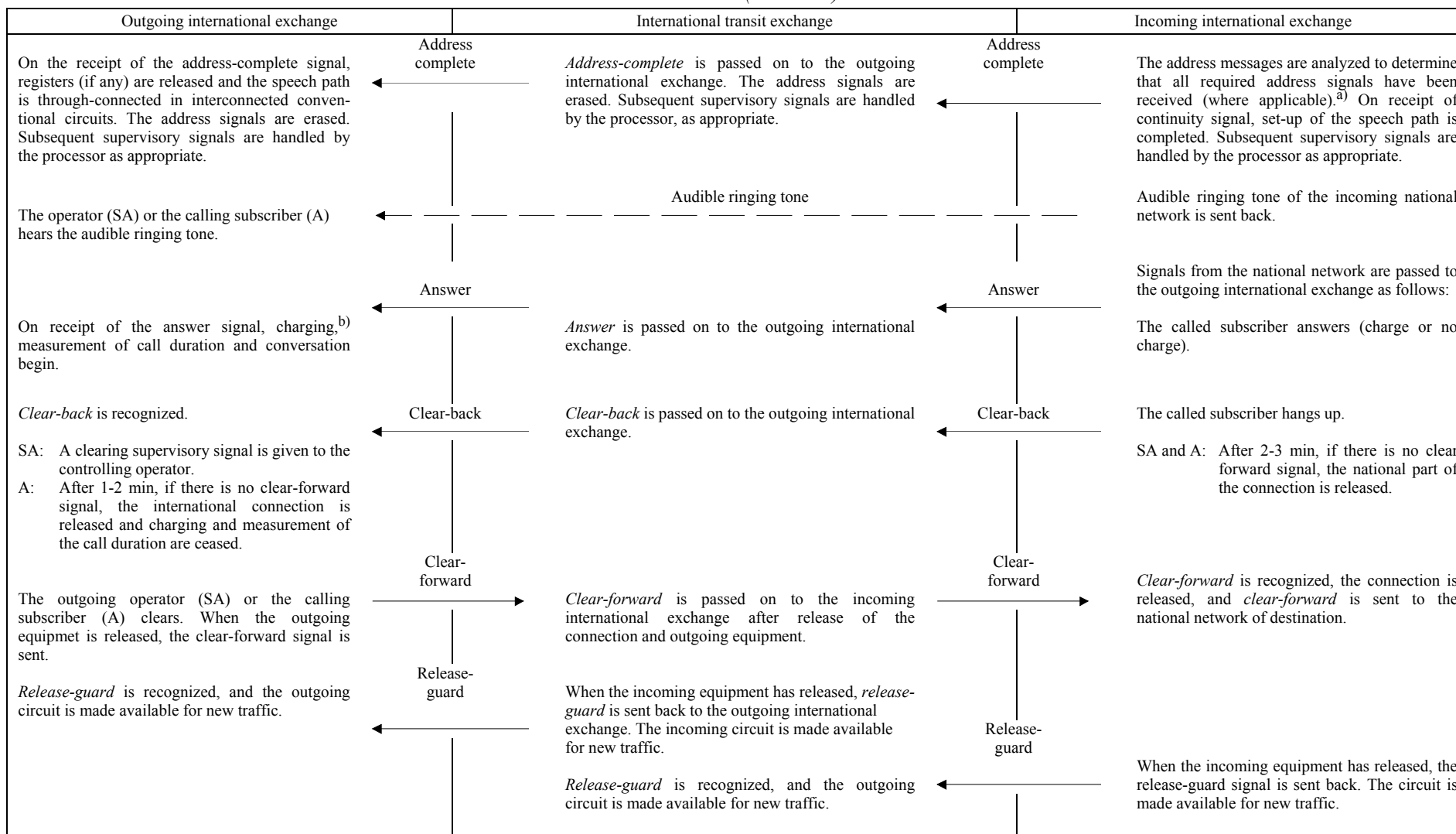

TABLE A-2 (continued)



a) The address-complete signal may come from the national network.

b) Unless a no-charge answer or address-complete signal has been received.

TABLE A-2 (continued)

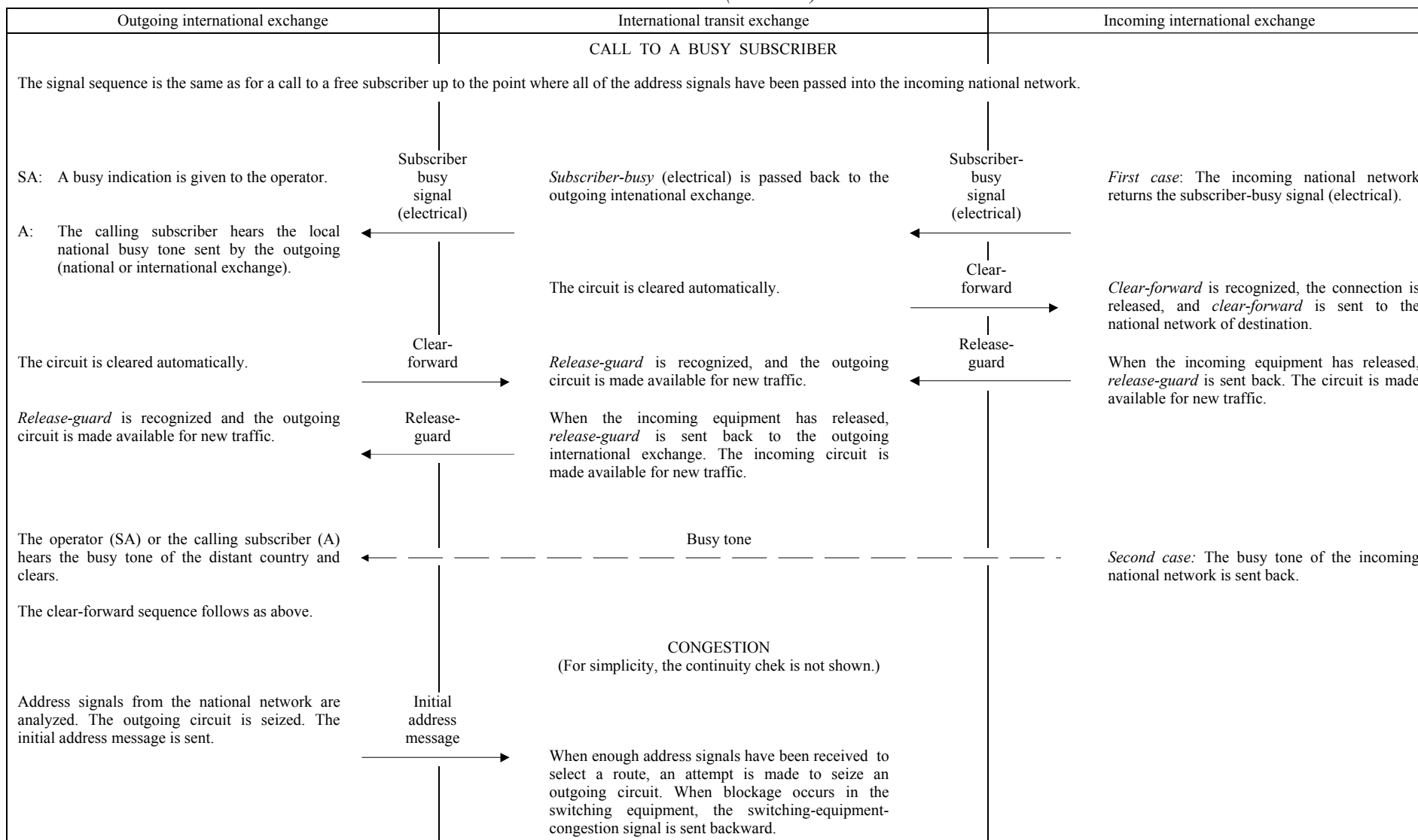
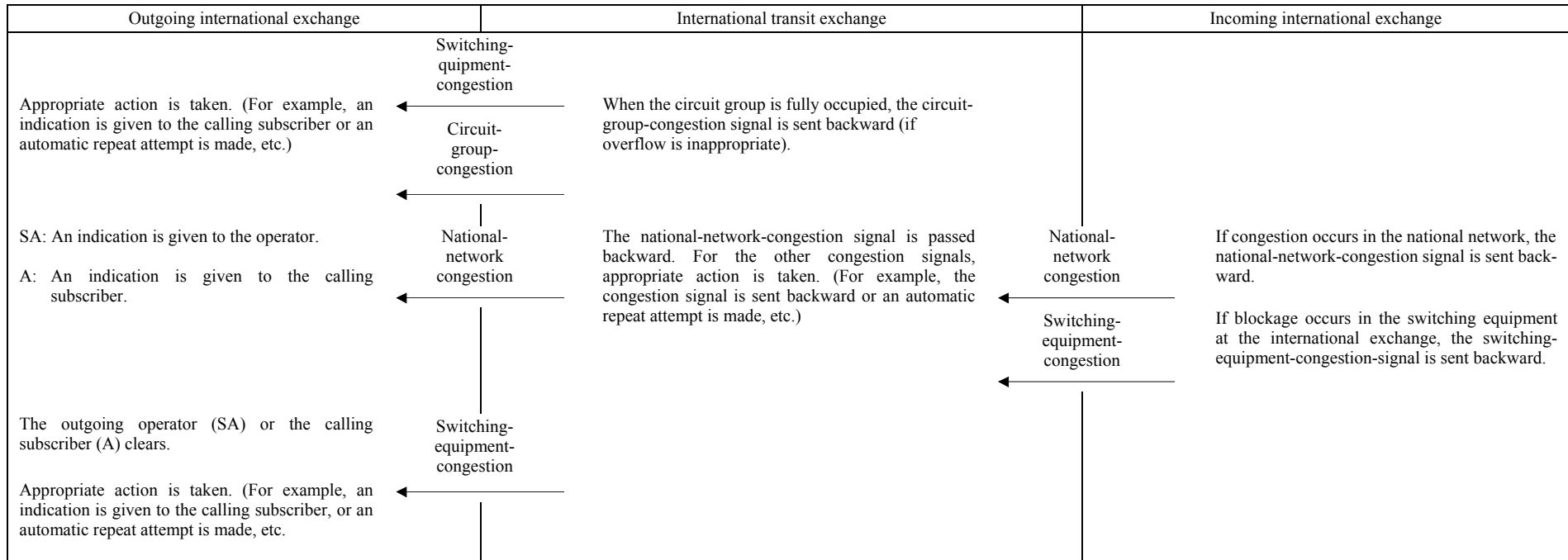

TABLE A-2 (concluded)





## ANNEX B TO SIGNALLING SYSTEM No. 6 SPECIFICATIONS

(see Recommendation Q.267)

### Reasonableness check tables

1 The following tables are provided:

Table B-1 refers to signal reception for an incoming call or an idle circuit or an undefined state of the circuit,

Table B-2 refers to signal transmission for an incoming call or an idle circuit or an undefined state of the circuit,

Table B-3 refers to signal reception for an outgoing call or for restoring circuits to service,

Table B-4 refers to signal transmission for an outgoing call or for restoring circuits to service,

Table B-5 contains the actions to be taken for blocking and unblocking sequences,

Table B-6 deals with timing intervals.

The *abbreviations* used for the signals in these tables are explained in the *List of abbreviations* following the glossary.

2 The reasonableness check tables consist of rows and columns.

The row on top of the table contains the telephone signals which may be received or transmitted.

The first and second columns from the left indicate the state of the circuit.

The first column contains the  $\zeta$ Circuit State Sequence Number (CSSN) and, in the second column, the state of the circuit is detailed by the signals already received (R) or sent (S).

CSSN 00 represents the idle condition of the circuit,

CSSN 01 represents an undefined state of the circuit (e.g. by memory mutilation),

CSSN 11 to 17 represent possible states for an incoming call,

CSSN 51 to 62 represent possible states for an outgoing call,

CSSN 63 and 64 represent possible states in restoring circuits to service,

CSSN 91 to 98 represent possible states for blocking and unblocking sequences.

In the intersections of rows and columns (small rectangles), the actions to be taken are shown. The *symbols* used are explained at the end of the reasonableness check tables. If the codes at the intersection require advance to another CSSN, the necessary actions must be taken to achieve the new CSSN. See example 2 below.

3 *Examples*

*Example 1:*

On receipt of an IAM (first signal column, Table B-1) at CSSN 11 (the state at which an IAM is received, or an IAM and one or more SAMs are received), the state is maintained (CSSN 11) and the new IAM is discarded if it is identical to the one previously received, or a confusion signal is sent backwards if the new IAM differs from the previous one.

*Example 2:*

If the circuit is idle (CSSN 00, Table B-1), and a confusion signal (COF) is received, the code 62 and PS appear at the intersection. In order to advance to CSSN 62 (Table B-4), it is necessary to send a clear-forward signal. The PS indicates that the selection of the circuit must be prevented until the requirements of CSSN 62 are met [receipt of release-guard signal (RLG)] to allow the circuit to return to idle (CSSN 00).

TABLE B-1

Signal reception for an incoming call or an idle circuit or an undefined state

	CSSN	State of the circuit	Signal received																					
			IAM	SAM	COT	FOT	CLF	CGC, NNC	ADI, SEC, SSB, SST, UNN, LOS	COF	ADC, ADN, ADX	AFC, AFN, AFX	ANC, ANN	CB 1	RA 1	CB 2	RA 2	CB 3	RA 3	RLG	CFL	MRF	RSC	RSB
Idle	00	Idle-RLG(S), RLG(R)	11	00 WP			00 WP	62 PS	62 PS	62 PS										62 PS	RR	00 SR	00 SA	
	01																					00 SR	00 SA	
Incoming call	11	IAM(R) or IAM(R)+SAM(R)	11 CP	11	12		00													62		00 SR	00 SA	
	12	IAM(R)+COT(R) or IAM(R)+SAM(R)+COT(R)	12 CP	12		12	00													62		00 SR	00 SA	
	13	COT(R)+ADC(S) or ADN(S) ou ADX(S)				13	00													62	RR	00 SR	00 SA	
	14	COT(R)+AFC(S) or AFN(S) or AFX(S)				14	00													62	RR	00 SR	00 SA	
	15	ADI(S), SEC(S), CGC(S) NNC(S), SSB(S), SST(S) UNN(S), LOS(S), COF(S)					00													62	RR	00 SR	00 SA	
	16	ANC(S) or ANN(S)				16	00													62	RR	00 SR	00 SA	
	17	CFL(S)					00													62	RR	00 SR	00 SA	

CCITT-26091

TABLE B-2

Signal transmission for an incoming call or an idle circuit or an undefined state

	CSSN	State of the circuit	Signal transmitted																						
			IAM	SAM	COT	FOT	CLF	CGC, NNC	ADI, SEC, SSB, SST, UNN, LOS	COF	ADC, ADN, ADX	AFC, AFN, AFX	ANC, ANN	CB 1	RA 1	CB 2	RA 2	CB 3	RA 3	RLG	CFL	RSC	RSB	RBA/RBI	
Idle	00	Idle-RLG(S), RLG(R)	51																					00	
	01	Undefined state																				63	64		
Incoming call	11	IAM(R) or IAM(R)+SAM(R)							15	15	15									17				00	
	12	IAM(R)+COT(R) or IAM(R)+SAM(R)+COT(R)							15	15	15	13	14	16 TL						17					00
	13	COT(R)+ADC(S) or ADN(S) or ADX(S)							15					16	13 TL	13 TL	13 TL	13 TL	13 TL	13 TL	17				00
	14	COT(R)+AFC(S) or AFN(S) or AFX(S)												16	14 TL	14 TL	14 TL	14 TL	14 TL	14 TL	17				00
	15	ADI(S), SEC(S), CGC(S) NNC(S), SSB(S), SST(S) UNN(S), LOS(S), COF(S)																		17					00
	16	ANC(S) or ANN(S)									16	16		16	16	16	16	16	16	16					00
	17	CFL(S)																		17					00

CCITT-26101

TABLE B-3  
Signal reception for an outgoing call

Outgoing call	CSSN	State of the circuit	Signal received																							
			IAM	SAM	COT	FOT	CLF	CGC, NNC	ADI, SEC, SSB, SST, UNN, LOS	COF	ADC, ADN, ADX	AFC, AFN, AFX	ANC, ANN	CB 1	RA 1	CB 2	RA 2	CB 3	RA 3	RLG	CFL	MRF	RSC	RSB	RBA/RBI	
51	IAM(S) or IAM(S)+SAM(S)		11 RT	51 WA	51 WA		51 WA 51 SR	62	62	62 RT										62 RT	62	RS	62 RT	00 SA		
52	IAM(S)+COT(S) or IAM(S)+SAM(S)+COT(S)		11 RT	52 WA	52 WA		52 WA 52 SR	62	62	62 RT	53	54	55	52 WO	52 WO	TR	TR	TR	TR	62 RT	62	RS	62 RT	00 SA		
53	ADC(R) or ADN(R) or ADX(R)							62					55	53 WO	53 WO	TR	TR	TR	TR		62	RR	62	00 SA		
54	AFC(R) or AFN(R) or AFX(R)												55	54 WO	54 WO	TR	TR	TR	TR		62	RR	62	00 SA		
55	ANC(R) or ANN(R)										55	55		56 WO	55 WO	55 WO	TR	TR	TR			RR	62	00 SA		
56	CB 1(R)													TR	57 WO	56 WO	56 WO	TR	TR			RR	62	00 SA		
57	RA 1 (R)													TR	TR		58 WO	57 WO	TR			RR	62	00 SA		
58	CB 2(R)													TR	TR	TR	59 WO	58 WO	58 WO			RR	62	00 SA		
59	RA 2(R)													59 WO	TR	TR	TR	60 WO	59 WO			RR	62	00 SA		
60	CB 3(R)													60 WO	60 WO	TR	TR	TR	61			RR	62	00 SA		
61	RA 3(R)													56 WO	61 WO	61 WO	TR	TR	TR			RR	62	00 SA		
62	CLF(S)		62 WA 62 SC					62 SR													00		RR	62	00 SA	
63	RSC(S)							00 SR													00		RR	63 SR	00 SA	
64	RSB(S)																							64 SR	64 SA	00

CCITT-26071

TABLE B-4  
Signal transmission for an outgoing call

Outgoing call	CSSN	State of the circuit	Signal transmitted																							
			IAM	SAM	COT	FOT	CLF	CGC, NNC	ADI, SEC, SSB, SST, UNN, LOS	COF	ADC, ADN, ADX	AFC, AFN, AFX	ANC, ANN	CB 1	RA 1	CB 2	RA 2	CB 3	RA 3	RLG	CFL	RSC	RSB	RBA/RBI		
51	IAM(S) or IAM(S)+SAM(S)			51	52		62																		00	
52	IAM(S)+COT(S) or IAM(S)+SAM(S)+COT(S)			52		52	62																			00
53	ADC(R) or ADN(R) or ADX(R)					53	62																			00
54	AFC(R) or AFN(R) or AFX(R)					54	62																			00
55	ANC(R) or ANN(R)					55	62																			00
56	CB 1(R)					56	62																			00
57	RA 1 (R)					57	62																			00
58	CB 2(R)					58	62																			00
59	RA 2(R)					59	62																			00
60	CB 3(R)					60	62																			00
61	RA 3(R)					61	62																			00
62	CLF(S)						62																			00
63	RSC(S)																				63		63	64		00
64	RSB(S)																						63			64

CCITT-26081

TABLE B-5

**Blocking and unblocking sequences**

CSSN	State of the circuit	Signal received						Signal transmitted					
		BLO	BLA	UBL	UBA	Note 2 RSC	Note 3 RSC	RSB	BLO	BLA	UBL	UBA	RBA/RBI
91	BLA(S)	91 SB		94 SN		94 SR	94 SF	94 SA	97	×	×	×	94
92	BLA(R) + BLA(S)	92 SB		93 SN		95 SO	95 SO	93 SA				98	93
93	BLA(R)	92 SB		93 SN		95 SO	95 SO	93 SA				96	93
94	Not blocked	91 SB		94 SN		94	94	94	95	×	×	×	94
95	BLO(S)	97 SB	93	95 SN		95 SO	95 SO	93 SA	95	×	×	×	93
96	UBL(S)	98 SB		96 SN	94	94 SR	94 SF	94 SA				96	94
97	BLA(S) + BLO(S)	97 SB	92	95 SN		95 SO	95 SO	93 SA	97	×	×	×	93
98	BLA(S) + UBL(S)	98 SB		96 SN	91	94 SR	94 SF	94 SA				98	94

CCITT-26061

*Symbols for Tables B-1 to B-5*

Discard received signal.



Inhibit signal sending.



Double seizure case (a: noncontrol, b: control).

CP ComPare received IAM with previous IAM:  
 –if identical, discard;  
 –if different, send confusion signal.

PS Prevent outgoing circuit Selection.

RR Retransmit the Refused signal on different signalling link, if possible (see Recommendation Q.266, § 4.6.2.3).

RS Reattempt outgoing call on a different Signalling link.

RT ReaTtempt outgoing call on a different circuit. Accept received IAM in double seizure case

SA Send reset-band. Acknowledgement signal.

SB Send Blocking-acknowledgement signal.

SC Send Confusion signal.

SF Send clear-forward signal.

SN Send uNblocking-acknowledgement signal.

SO Send blocking signal.

SR Send Release-guard signal.

TL Transfer received signal, at an intermediate common channel exchange. Inhibit sending signal at the last common channel exchange.

TR Transfer Received signal at an intermediate common channel exchange. Discard received signal at the first common channel exchange.

WA Wait.

WO Wait at the first common channel exchange Only. Transfer received signal at an intermediate common channel exchange.

WP Wait. Prevent outgoing circuit selection.

*Note 1* – These states can overlap call processing states.

*Note 2* – Received on idle or circuit serving an incoming call.

*Note 3* – Received on circuit serving a outgoing call.

*Note 4* – See Tables B-1 to B-4.

TABLE B-6  
Timing interval

CSSN	Signal received	State of the circuit	Timing interval (Note 1)	Stop timing on receipt of	Actions to be taken	
					Time out	Time in
00	SAM	Receipt of SAM in idle	500 ms + 2T <sub>p</sub>	IAM	Discard Remain at CSSN 00	Advance to CSSN 11
00	CLF	Receipt of CLF in idle	500 ms + 2T <sub>p</sub>	IAM	Send RLG Remain at CSSN 00	Discard IAM Send RLG Remain at CSSN 00
51 52	SAM	Receipt of SAM after IAM(S) or IAM(S) + SAM(S) at non-control exchange	500 ms + 2T <sub>p</sub>	IAM	Discard Remain at CSSN 51 or CSSN 52	Double seizure (Note 2)
51 52	COT	Receipt of COT before IAM at non-control exchange	500 ms + 2T <sub>p</sub>	IAM	Discard Remain at CSSN 51 or CSSN 52	Double seizure (Note 2)
51 52	CLF	Receipt of CLF after IAM(S) or IAM(S) + SAM(S) at non-control (Note 4)	500 ms + 2T <sub>p</sub>	IAM	Send RLG Remain at CSSN 51 or CSSN 52	Double seizure Send RLG Remain at CSSN 51 or CSSN 52
52 53 54	CB1, RA1	Receipt of CB1 or RA1 before ANC or ANN	500 ms + 2T <sub>p</sub>	ANC, ANN	Discard Remain at CSSN 52 or CSSN 53 or CSSN 54	(Note 5)
55 to 61	CB1, CB2, CB3, RA1, RA2, RA3	Sequence check of CB <sub>i</sub> and RA <sub>j</sub>	500 ms + 2T <sub>p</sub>	Missing CB <sub>i</sub> or RA <sub>j</sub>	Discard Remain at CSSN 55 to CSSN 61	(Note 6)
62	IAM	Receipt of IAM after CLF(S) at non-control exchange	500 ms + 2T <sub>p</sub>	RLG	Discard Remain at CSSN 62	Accept IAM Advance to CSSN 11

*Note 1* – The timing interval must allow for the maximum loop propagation of the signalling link (cable or satellite).

In the case of signals which are transferred by intermediate exchanges without detailed analysis and are resequenced at the first or last common channel exchange, such as SAM, ANC, CB1, etc., the worst case link may be any of the several links in the connection.

The timing interval is determined considering the following relations:

$$\begin{aligned}
 T_n &= 26T_e + 2T_c + 2T_p \text{ (for LSU),} \\
 &= 30T_e + 2T_c + 2T_p \text{ (for 5-SU IAM),} \\
 &< 500 \text{ ms} + 2T_p,
 \end{aligned}$$

where  $T_n$  is the maximum retransmission time for an erroneous signal.

*Note 2* – Accept incoming call and advance to CSSN 11.

Reattempt outgoing call on a different circuit.

*Note 3* – Accept incoming call and advance to CSSN 12.

Reattempt outgoing call on a different circuit.

*Note 4* – If a confusion, congestion, called-party's-line-condition or address-incomplete signal is received during the waiting period, release of the outgoing call attempt and sending clear-forward signal are delayed until time-out or receipt of an IAM.

*Note 5* –At the first common channel exchange, advance to CSSN 56 if clear-back 1 has been received or to CSSN 57 if re-answer 1 has been received. In the latter case send the answer signal backwards, irrespective of whether clear-back 1 has been received or not.

*Note 6* – Advance the CSSN to the highest in sequence CSSN 55-61 and send the appropriate clear-back or re-answer signal backwards if the state transition to the new highest CSSN makes this necessary.

## **PART II – INTERWORKING BETWEEN CCITT SIGNALLING SYSTEM No. 6 AND NATIONAL COMMON CHANNEL SIGNALLING SYSTEMS**

### **Recommendation Q.300**

#### **INTERWORKING BETWEEN CCITT SIGNALLING SYSTEM No. 6 AND NATIONAL COMMON CHANNEL SIGNALLING SYSTEMS**

### **1 Introduction**

This Recommendation deals with the philosophy that can provide for simplification of interworking between the CCITT Signalling System No. 6 employed in the international network and national common channel signalling systems for use in national networks. Three categories of such national signalling systems can be identified and are:

- i) Signalling System No. 6;
- ii) signalling system(s) derived from Signalling System No. 6;
- iii) other common channel signalling systems.

These are defined in § 3.2 below.

Through the aim of simplification, optimal operating conditions for the overall network are envisaged and thus an economic, high quality of service can be achieved. This is a matter for which all countries are interdependent.

The rapid introduction at all levels in the hierarchy of national networks can be advantageous in order to make full use of additional services and facilities of common channel signalling systems from the beginning and to facilitate the interworking problem.

### **2 Definitions of items concerning general principles**

#### **2.1 signalling interworking**

Signalling interworking is the controlled transfer of signalling information across the interface between signalling systems where the significance of the transferred information is identical or where the significance is translated in a defined manner.

#### **2.2 commonality**

The degree to which the basic features employed in two systems are identical.

#### **2.3 transparency**

A transparent state may be said to exist between two defined points when a signal which exists at one point can be transmitted to the second point without any loss or change of information. Signal is understood here in the sense the word has in signalling systems, i.e. a piece or item of information with a standardized meaning.

Transparency of the network of signalling channels would ensure that transfer of signalling information from one link to another is always achieved on a signal-per-signal basis. Thus, laborious analysis of several received signals for deciding which signal to transmit could be avoided.

Transparency is facilitated by the use of Signalling System No. 6 or a system derived from Signalling System No. 6, in national networks.

## 2.4 compatibility

Compatibility with respect to interworking implies a degree of transparency sufficient to support an acceptable grade of service with respect to a connection which transits the interworking office. Full compatibility implies full transparency.

## 2.5 basic features

The essential prime constituent characteristics on which a system is founded.

## 3 Items concerning signalling systems and interworking points

### 3.1 *Signalling System No. 6*

The specifications of System No. 6 are contained in Recommendations Q.251 to Q.295.

### 3.2 *National common channel signalling systems*

National common channel signalling systems may be used in:

- a) analogue networks;
- b) mixed analogue and digital networks;
- c) digital networks with or without service integration.

In national networks the following<sup>1)</sup> national common channel signalling systems may be used:

#### 1) Signalling System No. 6

Even when the signal units reserved for regional and/or national use are allocated in a different manner by various Administrations it is justified to consider this signalling system as Signalling System No. 6.

#### 2) Signalling system(s) derived from Signalling System No. 6

A signalling system is considered to be derived<sup>2)</sup> from Signalling System No. 6 when typical basic features of Signalling System No. 6 are employed:

The following are typical basic features of Signalling System No. 6:

- a) separate common signalling channel,
  - b) all inter-office signal transmission through the common signalling channel,
  - c) signal transfer on a link-by-link basis,
  - d) full duplex signal unit synchronous mode of transmission,
  - e) fixed signal unit length and block size,
  - f) error detection by check bits and error correction by retransmission,
  - g) continuity check on per-call basis,
  - h) quasi-associated signalling capability,
  - i) security arrangements for signalling channel,
- #### 3) Other common channel signalling system(s)

Although some similarity with Signalling System No. 6 may exist, basic features differ from the Signalling System No. 6 concept.

---

1) With regard to the order of the systems mentioned no preference is expressed.

2) Use of this expression is recommended instead of the term *based in Signalling System No. 6* in order to avoid ambiguity.



In Figure 1/Q.300, a signalling system *N* between exchanges *A* and *X* is a national common channel signalling system, while a system *IN* between exchanges *X* and *B* is System No. 6. All necessary interworking arrangements should be provided at exchange *X* (CT); thus interworking point is *X*.

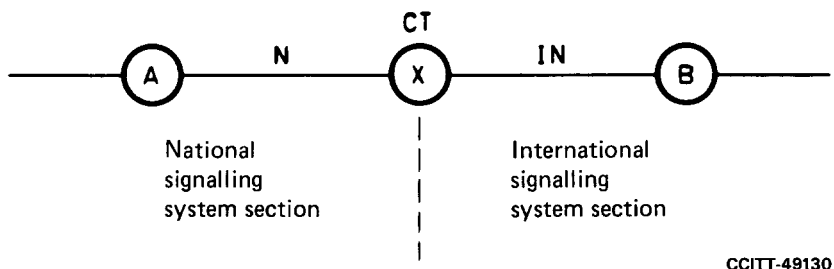

FIGURE 1/Q.300  
Interworking point, example 1

In Figure 2/Q.300, a signalling system *N* between exchanges *A* and *Y* is a national common channel signalling system, while a signalling system *IN* between exchanges *Z* and *B* is System No. 6.

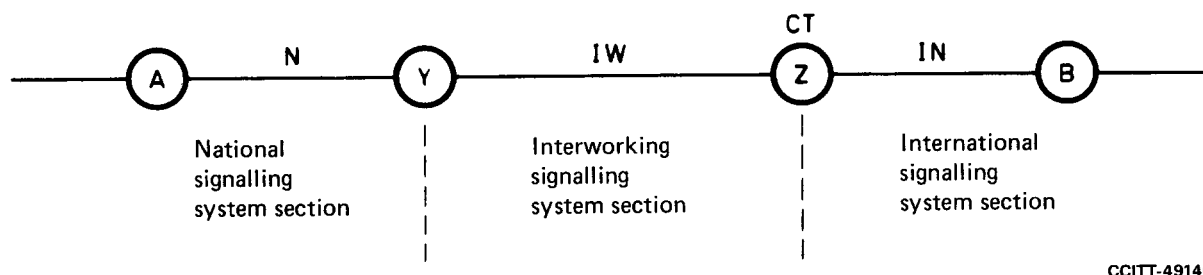

FIGURE 2/Q.300  
Interworking point, example 2

Signalling system *IW* applicable to the section between exchanges *Y* and *Z* (CT) can be any of

- 1) Signalling System No. 6,
- 2) national common channel signalling system,
- 3) signalling system for interworking use.

The interworking point is exchange *Y* for 1), and *Z* for 2). On the other hand, in the case of 3), the necessary interworking arrangement can be shared between exchanges *Y* and *Z*. interworking point in this case is divided into two sub-interworking points, i.e. national side sub-interworking point (exchange *Y*) and international side sub-interworking point (exchange *Z*).

## 4 Signalling procedures

### 4.1 Translation of signalling information

It is to be expected that in the future the long-distance network in many areas will be a mesh network of high density. Intensive use of transversal routes can be foreseen which in many cases will be operated with common channel signalling in the non-associated mode. Essentially, then, an overall signalling channel network will exist representing a link-by-link message switching system with messages and transfer procedures between different links due to the various national common channel signalling systems. In the nodes of that network, signal processing will be carried out, thereby including necessary signal translation operations if different common channel signalling systems are joining at the particular point.

Signal translation, however, may entail laborious processing procedures which require costly computer time likely to increase in proportion to telephone traffic. Evidently, it is desirable to reduce to a minimum such additional processing, which also may introduce faults.

Interworking is simplified if:

- supervisory signals have exactly the same meaning and the same function in both systems;
- the address information is sent in the same sequence in both systems;
- address-complete signal or its equivalent is used in the national system.

### 4.2 Signal conversions and originations

Some electrical signals in a national common channel signalling system may differ from the signals in the System No. 6. The international exchange or the national trunk exchange must convert such signals into corresponding signals according to the predetermined conversion table.

In order to provide for proper interworking between Signalling System No. 6 and national common channel signalling systems it is essential that a common channel exchange in the national network originates and sends on each connection one of the signals: address-complete, address-incomplete, congestion or called party's line condition. See also §§ 4.1.5 through 4.1.8 of Recommendation Q.261.

It is desired that some backward signals of System No. 6, which indicate conditions of an incoming national network or called subscribers, be converted, as directly as possible, into corresponding signals in the outgoing national network. If direct conversion is not possible, at least signals of the following two categories should be converted into relevant appropriate audible tones or recorded announcements at some appropriate interworking point:

1) In order to request that the calling subscriber re-dial:

switching-equipment-congestion signal	(SEC)
circuit-group-congestion signal	(CGC)
national-network-congestion signal	(NNC)
subscriber-busy signal	(SSB)

2) In order to send the information that the dialled telephone number is not available:

address-incomplete signal	(ADI)
unallocated-number signal	(UNN)
line-out-of-service signal	(LOS)
subscriber-transferred signal	(SST)

### 4.3 Continuity check

When no continuity check or a different continuity check from that in System No. 6 is applied in the national network, the transit exchange at the interworking point must be able to deal with both methods,

In a national network, a continuity check method differing from that of System No. 6 is necessary for the checking of two-wire circuits or circuits switched in two-wire exchanges.

An example of continuity check method for national use is as follows:

End-to-End continuity check facilities are provided on a pre-call basis between the first common channel signalling exchange and the last common channel signalling exchange. Two different tones ( $f_1$  and  $f_2$ ) are used for the checking.

The first exchange, on receipt of the backward tone  $f_2$  from the last exchange, sends the tone  $f_1$  forward. When the exchange detects the tone sent from the first exchange, the continuity check is successfully accomplished and Check-OK is sent backward to the first exchange to inform that the check was successful.

Another example employs link-by-link continuity check facilities on a per-call basis between the first common channel signalling exchange and the next common channel signalling exchange where the first exchange employs two-wire switching. Again, two frequencies  $f_1$  and  $f_2$  are employed, one in each direction of transmission and if a successful continuity check is achieved a continuity signal is transmitted. A similar check would be used between the next to last and the last common channel signalling exchanges.

#### 4.4 *Signals for national use*

Interworking of common channel signalling systems may require certain extra common channel signals which may be used exclusively in a national common channel signalling system.

A possible example is given below:

In order to avoid ineffective occupation of international circuits by unsuccessful calls, it is desired to send back relevant electrical signals to the preceding exchanges indicating that the call has not succeeded so that the connection may be cleared and an appropriate tone connected as close as possible to the calling subscriber.

When a national common channel signalling system is interworking with existing national signalling and switching systems, however, appropriate backward electrical signals that can indicate non-success of a call (e.g. national-network-congestion, etc.) may not always be available, and indications may be restricted to audible tones. In this case, an extra interworking signal, say *non-common-channel-connected* signal, may be provided. Such a signal would request the incoming interworking exchange to withhold the address-complete signal for a certain period of time so as to permit the audible tone sent back from beyond the last exchange of the national common channel signalling section to be received and converted into an appropriate electrical signal.

**GLOSSARY OF TERMS  
SPECIFIC TO SIGNALLING SYSTEM CCITT No. 6**

<b>acknowledgement signal unit (ACU):</b>	The twelfth signal unit of a block, which carries information as to whether or not the signal units in the block indicated were received correctly.
<b>associated signalling:</b>	A mode of operation of System No. 6 in which the signals carried by the system relate to a group of speech circuits which terminate in the same System No. 6 exchanges as the signalling system.
<b>block:</b>	A group of 12 signal units on the signalling channel.
<b>block-acknowledged counter:</b>	A cyclic counter provided within the signalling terminal to count the number of blocks acknowledged as received at the distant end.
<b>block-completed counter:</b>	A cyclic counter provided within the signalling terminal to count the number of completed blocks transmitted.
<b>changeback:</b>	The procedure of transferring signalling traffic from a reserve signalling link to the regular signalling link, when the regular link is again serviceable.
<b>changeover:</b>	The procedure of transferring signalling traffic from one signalling link to another, when the link in use fails or is required to be cleared of traffic.
<b>check loop:</b>	A device which is attached to interconnect the GO and RETURN paths of a circuit at the incoming end of a circuit to permit the outgoing end to make a continuity check on a loop basis.
<b>common channel exchange:</b>	An exchange utilizing a common channel signalling system, which has the facilities of System No. 6 from an interworking standpoint.
<b>common channel exchange, first:</b>	The exchange closest to the calling party in each common channel section of a connection where, unless it is the calling party's exchange, interworking with other signalling systems takes place.
<b>common channel exchange, intermediate:</b>	A transit exchange where interworking between common channel signalling system takes place.
<b>common channel exchange, last:</b>	The exchange closest to the called party in each common channel of a connection where, unless it is the called party's exchange, interworking with other signalling systems takes place.
<b>common channel signalling:</b>	A signalling method, using a signalling link common to a number of speech circuits, for the transmission of all signals necessary for the traffic via these circuits.
<b>continuity check:</b>	A check made of the circuit or circuits in a connection to verify that a speech path exists.
<b>continuity check transceiver:</b>	A combination of the check-tone transmitter and receiver.
<b>cross-office check:</b>	A check made across the exchange to verify that a speech path exists.

<b>data carrier failure detector:</b>	A monitoring unit designed to indicate that the level of the data carrier on a voice-frequency channel is below the minimum sensitivity of the receiver.
<b>data channel, analogue:</b>	A one-way path for data signals which includes a voice-frequency channel and an associated data modulator and demodulator.
<b>data channel, digital:</b>	A one-way path for data signals which includes a digital channel and associated interface adaptors at each end.
<b>data channel failure detector:</b>	A data carrier failure detector or loss of frame alignment detector.
<b>drift compensation:</b>	The process of adjusting for the difference in relationship of the backward acknowledgement information contained in the ACU to the forward signal units it acknowledges which occurs as a result of drift in the bit rates of the data channels.
<b>emergency restart:</b>	The procedure of re-established signalling communication, when the regular and all reserve signalling links fail.
<b>error control loop:</b>	The number of signal units transmitted on the signalling link between the time a particular signal unit is sent and the time that the acknowledgement of that signal unit is recognized.
<b>error rate monitor:</b>	A device which receives an indication for each signal unit found in error and which measures the rate of occurrence of errors according to a prescribed rule.
<b>faulty link information:</b>	Information sent on a signalling link to indicate a failure of that link. The information consists of alternate blocks of changeover signals and of synchronization signal unit.
<b>field:</b>	A subdivision of a signal unit, which carries a certain type or classification of information – e.g. label field, signal information field, etc.
<b>fully dissociated signalling:</b>	A form of non-associated signalling in which the path that signals may take through the network is only restricted by the rules and configuration of the signalling network.
<b>initial address message (IAM):</b>	A multi-unit message which is sent as the first message in a call set-up, consisting of a minimum of three and a maximum of six signal units, and containing enough information to route the call through the international network.
<b>initial signal unit (ISU):</b>	The first signal unit of a multi-unit message.
<b>interface adaptor:</b>	A unit required between the signalling terminal and the digital channel to provide for holdover clock, loss of frame alignment indication and where necessary, for clock and data rate conversion.
<b>label:</b>	The 11-bit binary code within a signal message used to identify the particular speech circuit with which the message is associated. The label is subdivided into a band number and a circuit number.
<b>load transfer:</b>	The transfer of signalling traffic from one signalling link to another.
<b>lone signal unit (LSU):</b>	A signal unit carrying a one-unit message.

<b>loss of frame alignment detector:</b>	A monitoring unit, designed to indicate to the signalling terminal that frame alignment of the PCM system has been lost.
<b>management signals:</b>	Signals concerning the management or maintenance of the speech circuit network and the signalling network.
<b>multi-block:</b>	A group of 8 blocks or 96 signal units on the signalling channel.
<b>multi-block synchronization signal unit (MBS):</b>	A signal unit carrying a signal concerning the multi-block synchronization of the signalling system.
<b>multi-unit message (MUM):</b>	A signal message which consists of more than one signal unit.
<b>non-associated signalling:</b>	A mode of operation in which the signals for a group of speech circuits are sent over two or more common signalling links in tandem. The signals being processed and forwarded to the next link by equipment at one or more signal transfer points.
<b>one-unit message:</b>	A signal message which is transmitted entirely within one signal unit.
<b>quasi-associated signalling:</b>	A form of non-associated signalling in which the route the signals may take through the network is prescribed.
<b>queueing delay:</b>	The delay incurred by a signal message as a result of the sequential transmission of signal units on the signalling channel.
<b>reasonableness check tables:</b>	Tables which define procedures used to avoid or resolve ambiguous call situations.
<b>security arrangements:</b>	The measures provided to ensure continuity of service of the signalling system in the event of the failure of one or both of the data channels.
<b>signalling channel:</b>	A data channel in combination with the associated signalling terminal equipment at each end.
<b>signalling data link:</b>	A combination of two data channels operating together in a single signalling system.
<b>signalling link:</b>	A combination of two signalling channels operating together in a single signalling system.
<b>signalling system:</b>	The combination of all of the equipment and channels necessary to provide signalling for one or more groups of circuits between two No. 6 exchanges. It thus includes a data link, signalling terminal equipment, and necessary portion of the processor at each No. 6 exchange.
<b>(signal) message:</b>	Signal information pertaining to a call, management action, etc., sent at one time on the signalling channel. A message may consist of one or more signals transmitted in one or more signal units.
<b>signal transfer point:</b>	A signal relay centre handling and transferring signals from one signalling link to another in a non-associated mode of operation.
<b>signal unit (SU):</b>	The smallest defined group of bits on the signalling channel (28 bits), used for the transfer of signal information.

<b>subsequent address message (SAM):</b>	An address message, which may be either a one-unit or a multi-unit message, sent following the initial address message.
<b>subsequent signal unit (SSU):</b>	A signal unit of a multi-unit message other than the initial signal unit.
<b>synchronization signal unit (SYU):</b>	A signal unit containing a bit pattern and information designed to facilitate rapid synchronization and which is sent on the signalling channel when synchronizing or when no signal messages are available for transmission.
<b>system control signal unit (SCU):</b>	A signal unit carrying a signal concerning the operation of the signalling system – e.g. changeover, load-transfer.
<b>system No. 6 exchange:</b>	An exchange utilizing Signalling System No. 6.
<b>system No. 6 exchange, first:</b>	The exchange closest to the calling party in each No. 6 section of a connection where, unless it is the calling party's exchange, interworking with other signalling systems takes place.
<b>system No. 6 exchange, intermediate:</b>	A transit exchange where interworking to and from Signalling System No. 6 takes place.
<b>system No. 6 exchange, last:</b>	The exchange closest to the called party in each No. 6 section of a connection where, unless it is the called party's exchange, interworking with other signalling systems takes place.
<b>telephone signal:</b>	Any signal which pertains to a particular telephone call or to a particular speech circuit.
<b>transfer channel:</b>	A voice-frequency channel or a digital channel.
<b>transfer link:</b>	A combination of two transfer channels operating together in a single signalling system.
<b>unreasonable message:</b>	A message with an inappropriate signal content, an incorrect signal direction, or an inappropriate place in the signal sequence.

## ABBREVIATIONS SPECIFIC TO SIGNALLING SYSTEM No. 6

ACU	Acknowledgement signal unit	LTA	Load-transfer-acknowledgement signal
ADC	Address-complete signal, charge	LTR	Load-transfer signal
ADI	Address-incomplete signal	MBS	Multi-block synchronization signal unit
ADN	Address-complete signal, no charge	MCA	Manual-changeover-acknowledgement signal
ADX	Address-complete signal, coin-box	MCO	Manual-changeover signal
AFC	Address-complete signal, subscriber-free, charge	MMM	Multiunit network management and maintenance message
AFN	Address-complete signal, subscriber-free, no charge	MRF	Message-refusal signal
AFX	Address-complete signal, subscriber-free, coin-box	MUM	Multi-unit message
ANC	Answer signal, charge	NMM	Network-management and maintenance signal
ANN	Answer signal, no charge	NNC	National-network-congestion signal
BLA	Blocking-acknowledgement signal	RA1-3	Reanswer signal No. 1-No. 3
BLO	Blocking signal	RBA	Reset-band-acknowledgement message
CB1-3	Clear-back signal No. 1-No. 3	RBI	Reset-band-acknowledgement, all circuits idle signal
CFL	Call-failure signal	RLG	Release-guard signal
CGC	Circuit-group-congestion signal	RSB	Reset-band signal
CLF	Clear-forward signal	RSC	Reset-circuit signal
COF	Confusion signal	SAM1-7	Subsequent address message No. 1-No. 7
COT	Continuity signal	SBR	Standby-ready signal
COV	Changeover signal	SCU	System-control signal unit
CSSN	Circuit state sequence number	SEC	Switching-equipment-congestion signal
ELT	Emergency-load-transfer signal	SNM	Signalling-network-management signal
FOT	Forward-transfer signal	SRA	Standby-ready-acknowledgement signal
IAM	Initial address message	SSB	Subscriber-busy signal (electrical)
ISU	Initial signal unit	SST	Send-special-information tone signal
LOS	Line-out-of-service signal	SSU	Subsequent signal unit
LSU	Lone signal unit	SU	Signal unit



SYN	Synchronization signal unit	UBA	Unblocking-acknowledgement signal
TAA	Transfer-allowed-acknowledgement signal	UBL	Unblocking signal
TFA	Transfer-allowed signal	UNN	Unallocated-number signal
TFP	Transfer-prohibited signal		





## SERIES OF ITU-T RECOMMENDATIONS

Series A	Organization of the work of ITU-T
Series B	Means of expression: definitions, symbols, classification
Series C	General telecommunication statistics
Series D	General tariff principles
Series E	Overall network operation, telephone service, service operation and human factors
Series F	Non-telephone telecommunication services
Series G	Transmission systems and media, digital systems and networks
Series H	Audiovisual and multimedia systems
Series I	Integrated services digital network
Series J	Cable networks and transmission of television, sound programme and other multimedia signals
Series K	Protection against interference
Series L	Construction, installation and protection of cables and other elements of outside plant
Series M	TMN and network maintenance: international transmission systems, telephone circuits, telegraphy, facsimile and leased circuits
Series N	Maintenance: international sound programme and television transmission circuits
Series O	Specifications of measuring equipment
Series P	Telephone transmission quality, telephone installations, local line networks
<b>Series Q</b>	<b>Switching and signalling</b>
Series R	Telegraph transmission
Series S	Telegraph services terminal equipment
Series T	Terminals for telematic services
Series U	Telegraph switching
Series V	Data communication over the telephone network
Series X	Data networks and open system communications
Series Y	Global information infrastructure and Internet protocol aspects
Series Z	Languages and general software aspects for telecommunication systems