



INTERNATIONAL TELECOMMUNICATION UNION

**ITU-T**

TELECOMMUNICATION  
STANDARDIZATION SECTOR  
OF ITU

**Q.2630.1**

(12/1999)

SERIES Q: SWITCHING AND SIGNALLING

Broadband ISDN – Common aspects of B-ISDN  
application protocols for access signalling and network  
signalling and interworking

---

**AAL type 2 signalling protocol – Capability set 1**

ITU-T Recommendation Q.2630.1

(Formerly CCITT Recommendation)

---

ITU-T Q-SERIES RECOMMENDATIONS  
**SWITCHING AND SIGNALLING**

SIGNALLING IN THE INTERNATIONAL MANUAL SERVICE	Q.1–Q.3
INTERNATIONAL AUTOMATIC AND SEMI-AUTOMATIC WORKING	Q.4–Q.59
FUNCTIONS AND INFORMATION FLOWS FOR SERVICES IN THE ISDN	Q.60–Q.99
CLAUSES APPLICABLE TO ITU-T STANDARD SYSTEMS	Q.100–Q.119
SPECIFICATIONS OF SIGNALLING SYSTEMS No. 4 AND No. 5	Q.120–Q.249
SPECIFICATIONS OF SIGNALLING SYSTEM No. 6	Q.250–Q.309
SPECIFICATIONS OF SIGNALLING SYSTEM R1	Q.310–Q.399
SPECIFICATIONS OF SIGNALLING SYSTEM R2	Q.400–Q.499
DIGITAL EXCHANGES	Q.500–Q.599
INTERWORKING OF SIGNALLING SYSTEMS	Q.600–Q.699
SPECIFICATIONS OF SIGNALLING SYSTEM No. 7	Q.700–Q.849
DIGITAL SUBSCRIBER SIGNALLING SYSTEM No. 1	Q.850–Q.999
PUBLIC LAND MOBILE NETWORK	Q.1000–Q.1099
INTERWORKING WITH SATELLITE MOBILE SYSTEMS	Q.1100–Q.1199
INTELLIGENT NETWORK	Q.1200–Q.1699
SIGNALLING REQUIREMENTS AND PROTOCOLS FOR IMT-2000	Q.1700–Q.1799
BROADBAND ISDN	Q.2000–Q.2999
General aspects	Q.2000–Q.2099
Signalling ATM adaptation layer (SAAL)	Q.2100–Q.2199
Signalling network protocols	Q.2200–Q.2299
<b>Common aspects of B-ISDN application protocols for access signalling and network signalling and interworking</b>	<b>Q.2600–Q.2699</b>
B-ISDN application protocols for the network signalling	Q.2700–Q.2899
B-ISDN application protocols for access signalling	Q.2900–Q.2999

*For further details, please refer to the list of ITU-T Recommendations.*

## **ITU-T Recommendation Q.2630.1**

### **AAL type 2 signalling protocol – Capability set 1**

#### **Summary**

This ITU-T Recommendation specifies the inter-node protocol and nodal functions that control AAL type 2 point-to-point connections.

The AAL type 2 signalling protocol specified in this ITU-T Recommendation is usable in switched and non-switched environments and can operate in public or private networks over a range of signalling transport protocol stacks.

It also provides maintenance capabilities, carriage of user-plane protocol stack information and carriage of an identifier to link the connection control protocol with other higher layer control protocols.

#### **Source**

ITU-T Recommendation Q.2630.1 was prepared by ITU-T Study Group 11 (1997-2000) and approved under the WTSC Resolution 1 procedure on 3 December 1999.

## FOREWORD

The International Telecommunication Union (ITU) is the United Nations specialized agency in the field of telecommunications. The ITU Telecommunication Standardization Sector (ITU-T) is a permanent organ of ITU. ITU-T is responsible for studying technical, operating and tariff questions and issuing Recommendations on them with a view to standardizing telecommunications on a worldwide basis.

The World Telecommunication Standardization Conference (WTSC), which meets every four years, establishes the topics for study by the ITU-T study groups which, in turn, produce Recommendations on these topics.

The approval of ITU-T Recommendations is covered by the procedure laid down in WTSC Resolution 1.

In some areas of information technology which fall within ITU-T's purview, the necessary standards are prepared on a collaborative basis with ISO and IEC.

## NOTE

In this Recommendation, the expression "Administration" is used for conciseness to indicate both a telecommunication administration and a recognized operating agency.

## INTELLECTUAL PROPERTY RIGHTS

ITU draws attention to the possibility that the practice or implementation of this Recommendation may involve the use of a claimed Intellectual Property Right. ITU takes no position concerning the evidence, validity or applicability of claimed Intellectual Property Rights, whether asserted by ITU members or others outside of the Recommendation development process.

As of the date of approval of this Recommendation, ITU had not received notice of intellectual property, protected by patents, which may be required to implement this Recommendation. However, implementors are cautioned that this may not represent the latest information and are therefore strongly urged to consult the TSB patent database.

© ITU 2001

All rights reserved. No part of this publication may be reproduced or utilized in any form or by any means, electronic or mechanical, including photocopying and microfilm, without permission in writing from the ITU.

## CONTENTS

	<b>Page</b>
1	Scope..... 1
2	References..... 2
2.1	Normative references ..... 2
2.2	Bibliography (non-normative references)..... 3
3	Definitions ..... 3
4	Abbreviations..... 5
5	General framework of the AAL type 2 signalling protocol ..... 7
5.1	Interface between the AAL type 2 signalling entity and the AAL type 2 served user..... 9
5.1.1	Service provided by the AAL type 2 signalling entity..... 9
5.1.2	Primitives between AAL type 2 signalling entities and the AAL type 2 served user ..... 9
5.1.3	Parameters between AAL type 2 signalling entities and the AAL type 2 served user ..... 10
5.2	Interface between the AAL type 2 signalling entity and the generic signalling transport ..... 11
5.2.1	Service provided by the generic signalling transport service ..... 11
5.2.2	Primitives between AAL type 2 signalling entities and the generic signalling transport ..... 11
5.2.3	Parameters between AAL type 2 signalling entities and the generic signalling transport ..... 12
5.2.4	AAL type 2 signalling entity – initial conditions..... 12
5.2.5	State transition diagram for sequences of primitives of the generic signalling transport service ..... 12
5.3	Interface between the AAL type 2 signalling entity and layer management..... 12
5.3.1	Service provided by layer management..... 12
5.3.2	Primitives between AAL type 2 signalling entities and layer management .. 12
5.3.3	Parameters between AAL type 2 signalling entities and layer management . 14
6	Forward and backward compatibility ..... 14
6.1	Backward compatibility rules ..... 15
6.2	Forward compatibility mechanism..... 15
7	Format and coding of AAL type 2 signalling protocol ..... 15
7.1	Coding conventions for the AAL type 2 signalling protocol..... 15
7.1.1	Principles ..... 15
7.1.2	General format of messages..... 16
7.1.3	General format of parameters ..... 17
7.1.4	General format of fixed length fields..... 17

	<b>Page</b>
7.1.5	General format of variable length fields ..... 17
7.2	Format and coding of the AAL type 2 signalling protocol messages ..... 17
7.2.1	AAL type 2 signalling protocol messages ..... 17
7.2.2	Parameters of the AAL type 2 signalling protocol messages ..... 18
7.3	Parameter specification of the AAL type 2 signalling protocol messages ..... 20
7.3.1	Cause ..... 20
7.3.2	Connection element identifier ..... 20
7.3.3	Destination E.164 service endpoint address ..... 20
7.3.4	Destination NSAP service endpoint address ..... 21
7.3.5	Link characteristics ..... 21
7.3.6	Originating signalling association identifier ..... 21
7.3.7	Served user generated reference ..... 21
7.3.8	Served user transport ..... 22
7.3.9	Service specific information (audio) ..... 22
7.3.10	Service specific information (multirate) ..... 22
7.3.11	Service specific information (SAR-assured) ..... 22
7.3.12	Service specific information (SAR-unassured) ..... 23
7.3.13	Test connection indicator ..... 23
7.4	Field specification of the AAL type 2 signalling protocol parameters ..... 23
7.4.1	Compatibility ..... 23
7.4.2	Signalling association identifier ..... 23
7.4.3	AAL type 2 path identifier ..... 24
7.4.4	Channel identifier ..... 24
7.4.5	Organizational unique identifier ..... 24
7.4.6	Audio service ..... 25
7.4.7	Multirate service ..... 26
7.4.8	Segmentation and reassembly (assured data transfer) ..... 26
7.4.9	Segmentation and reassembly (unassured data transfer) ..... 26
7.4.10	Served user generated reference ..... 27
7.4.11	CPS-SDU bit rate ..... 27
7.4.12	CPS-SDU size ..... 27
7.4.13	Nature of address ..... 28
7.4.14	E.164 address ..... 28
7.4.15	NSAP address ..... 28
7.4.16	Cause value ..... 29
7.4.17	Diagnostics ..... 30
7.4.18	Served user transport ..... 30
8	Procedure of the AAL type 2 signalling protocol ..... 31
8.1	Compatibility ..... 31

	<b>Page</b>	
8.1.1	General requirements on receipt of unrecognized signalling information.....	31
8.1.2	Procedures for the handling of the unrecognized messages or parameters ...	33
8.1.3	Procedures for the handling of responses indicating unrecognized information has been sent .....	35
8.2	Nodal functions .....	35
8.2.1	Nodal functions for AAL type 2 nodes with served user interaction .....	35
8.2.2	Nodal functions for AAL type 2 nodes without served user interaction .....	43
8.3	Protocol entity .....	47
8.3.1	General protocol error handling.....	47
8.3.2	Outgoing protocol procedures .....	48
8.3.3	Incoming protocol procedures .....	54
8.3.4	Maintenance protocol procedures.....	61
8.4	List of timers .....	68
Annex A – Support for non-switched scenario.....		69
A.1	Introduction.....	69
A.2	References.....	70
A.3	Definitions .....	70
A.4	Abbreviations.....	70
A.5	General framework of the AAL type 2 signalling protocol .....	70
A.5.1	Interface between the AAL type 2 signalling entity and the AAL type 2 served user .....	72
A.5.2	Service provided by the generic signalling transport service .....	72
A.5.3	Interface between the AAL type 2 signalling entities and layer management.....	72
A.6	Forward and backward compatibility .....	72
A.7	Format and coding of AAL type 2 signalling protocol .....	72
A.7.1	Coding conventions for the AAL type 2 signalling protocol.....	72
A.7.2	Format and coding of the AAL type 2 signalling protocol messages.....	72
A.7.3	Parameter specification of the AAL type 2 signalling protocol messages ....	74
A.7.4	Field specification of the AAL type 2 signalling protocol parameters .....	74
A.8	Procedure of the AAL type 2 signalling protocol .....	74
A.8.1	Compatibility .....	75
A.8.2	Nodal functions.....	75
A.8.3	Protocol entity.....	77
A.8.4	List of timers.....	77
Appendix I – Example message sequences.....		78
I.1	Successful establishment and release.....	78
I.2	Unsuccessful establishment .....	79

	<b>Page</b>
I.3 Management message sequences .....	80
I.4 Release crossover/release collision.....	81
I.5 Resource contention.....	82



## **ITU-T Recommendation Q.2630.1**

### **AAL type 2 signalling protocol – Capability set 1**

#### **1 Scope**

This ITU-T Recommendation describes the AAL type 2 signalling protocol that supports the dynamic establishment and release of individual AAL type 2 point-to-point connections. It also describes the maintenance procedures, the framework of the protocol, and the interactions between an AAL type 2 signalling protocol entity and:

- the signalling protocol user;
- a signalling transport converter; and
- layer management.

This ITU-T Recommendation also describes the connection states, messages, parameters, timers, local, and peer-to-peer procedures used for the control of those connections. The scope of this ITU-T Recommendation is illustrated in Figure 1-1. The AAL type 2 signalling protocol can be deployed over a range of signalling transport protocol stacks.

This ITU-T Recommendation is based on the requirements defined in ITU-T Supplement 8 [21] "*Signalling requirements for AAL type 2 link control capability set 1*".

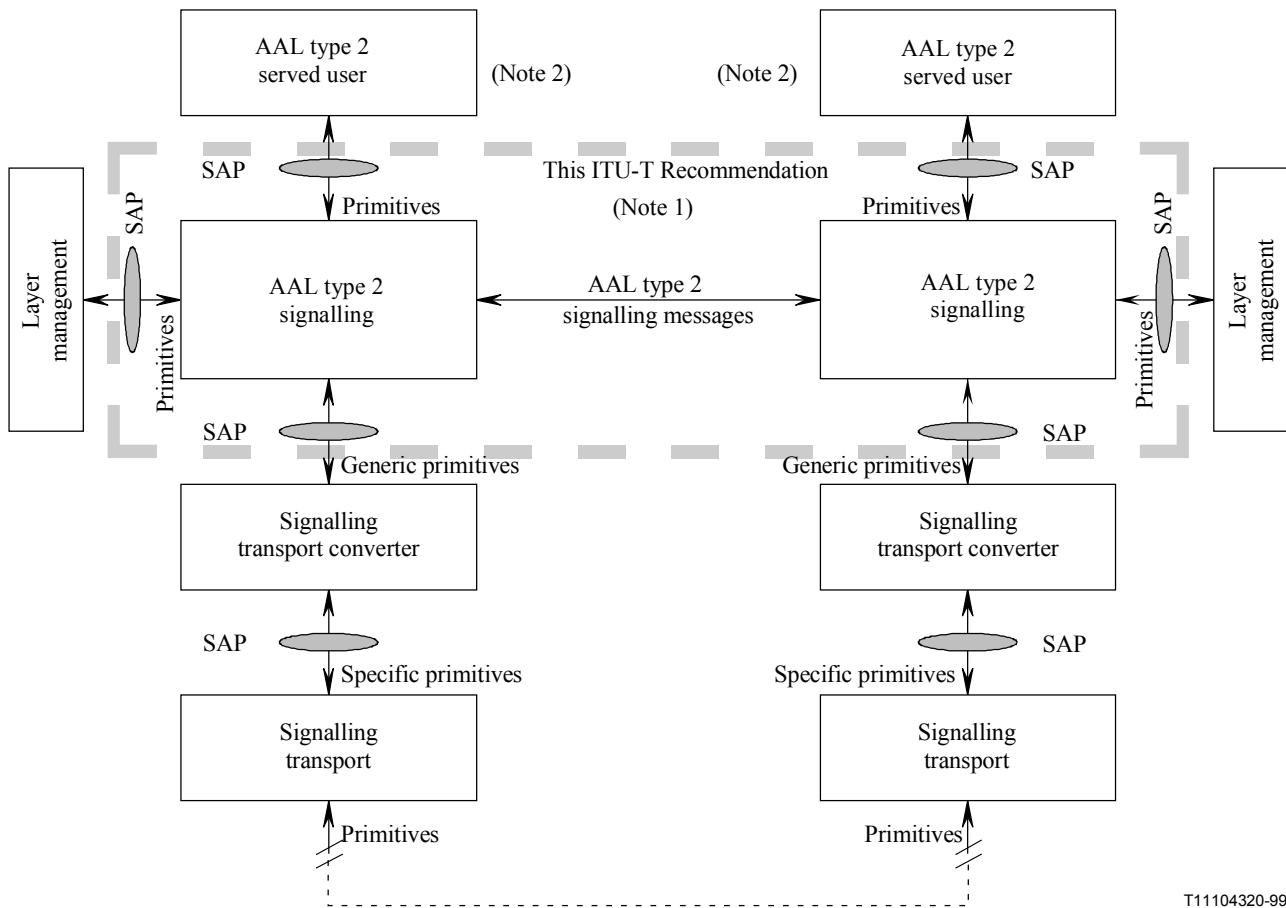

T11104320-99

NOTE 1 – The entities and Service Access Points (SAP) bounded by the gray broken line indicate the extent of the definitions specified in this ITU-T Recommendation.

NOTE 2 – There are cases where the AAL type 2 served user is not present.

**Figure 1-1/Q.2630.1 – Functional architecture of the AAL type 2 signalling**

## 2 References

### 2.1 Normative references

The following ITU-T Recommendations and other references contain provisions which, through reference in this text, constitute provisions of this Recommendation. At the time of publication, the editions indicated were valid. All Recommendations and other references are subject to revision; all users of this Recommendation are therefore encouraged to investigate the possibility of applying the most recent edition of the Recommendations and other references listed below. A list of the currently valid ITU-T Recommendations is regularly published.

- [1] ITU-T Recommendation I.363.2 (1997), *B-ISDN ATM Adaptation Layer (AAL) Specification: Type 2 AAL*.
- [2] ITU-T Recommendation I.361 (1999), *B-ISDN ATM layer specification*.
- [3] ITU-T Recommendation X.200 (1994) | ISO/IEC 7498-1:1994, *Information Technology – Open Systems Interconnection – Basic reference model: The basic model*.
- [4] ITU-T Recommendation X.210 (1993) | ISO/IEC 1073:1994, *Information Technology – Open Systems Interconnection – Basic reference model: Conventions for the definition of OSI services*.

- [5] ITU-T Recommendation X.213 (1995) | ISO/IEC 8348:1996, *Information Technology – Open Systems Interconnection – Network Service Definition*.
- [6] ITU-T Recommendation Q.850 (1998), *Usage of cause and location in the Digital Subscriber Signalling System No. 1 and the Signalling System No. 7 ISDN User Part*.
- [7] ITU-T Recommendation Q.2610 (1999), *Usage of cause and location in B-ISDN user part and DSS2*.
- [8] ITU-T Recommendation I.366.2 (1999), *AAL type 2 service specific convergence sublayer for trunking*.
- [9] ITU-T Recommendation I.366.1 (1998), *Segmentation and Reassembly Service Specific Convergence Sublayer for the AAL type 2*.
- [10] ITU-T Recommendation E.164 (1997), *The international public telecommunication numbering plan*.
- [11] IEEE Standard 802-1990, *IEEE Local and Metropolitan Area Networks: Overview and Architecture*.

## 2.2 Bibliography (non-normative references)

- [21] ITU-T Q-series Recommendations – Supplement 8 (1999), *Technical Report TRQ.2400: Transport control signalling requirements – Signalling requirements for AAL type 2 link control capability set 1*.
- [22] ITU-T Recommendation Q.2150.2 (1999), *AAL type 2 signalling transport converter on SSCOP*.
- [23] ITU-T Recommendation Q.2150.1 (1999), *AAL type 2 signalling transport converter on broadband MTP*.
- [24] ITU-T Recommendation Q.2210 (1996), *Message transfer part level 3 functions and messages using the services of ITU-T Recommendation Q.2140*.
- [25] ITU-T Recommendation Q.2110 (1994), *B-ISDN ATM adaption layer – Service specific connection oriented protocol (SSCOP)*.
- [26] ITU-T Recommendation Q.2130 (1994), *B-ISDN signalling ATM adaptation layer – Service specific coordination function for support of signalling at the user network interface (SSCF at UNI)*.
- [27] ITU-T Recommendation Q.2941.2 (1999), *Digital Subscriber Signalling System No. 2 – Generic identifier transport extensions*.

## 3 Definitions

This Recommendation is based upon the concepts developed in ITU-T Recommendations X.200 [3] and X.210 [4].

In addition, this Recommendation defines the following terms:

**3.1 AAL type 2 channel:** A concept used in ITU-T Recommendation I.363.2 [1] to describe transport of CPS-packets [1] associated in a common unique identifier value called CID on an ATM VCC.

**3.2 AAL type 2 connection:** The logical concatenation of one or more AAL type 2 links between two AAL type 2 service endpoints.

- 3.3 AAL type 2 link:** The logical user plane communication facility between two adjacent AAL type 2 switching points or service endpoints. An AAL type 2 link is designated by a single CID value.
- 3.4 AAL type 2 link characteristics:** Information that describes the attributes of the AAL type 2 link.
- 3.5 AAL type 2 node:** An AAL type 2 service endpoint or an AAL type 2 switch.
- 3.6 AAL type 2 Path:** An ATM VCC between two adjacent AAL type 2 nodes. This ATM VCC can either be an SVC, SPVC, or PVC.
- 3.7 AAL type 2 path identifier:** The identifier of the AAL type 2 path.
- 3.8 AAL type 2 service endpoint:** A termination point of an AAL type 2 connection.
- 3.9 AAL type 2 served user:** The user of an AAL type 2 signalling protocol.
- 3.10 AAL type 2 signalling protocol:** Control plane functions for establishing and releasing AAL type 2 connections and the maintenance functions associated with the AAL type 2 signalling.
- 3.11 AAL type 2 signalling transport:** A facility for carrying AAL type 2 signalling messages.
- 3.12 AAL type 2 signalling endpoint:** The termination point of an AAL type 2 signalling transport.
- 3.13 AAL type 2 switch:** A system capable of switching AAL type 2 connections.
- 3.14 ATM layer signalling:** Control plane functions for establishing, clearing and maintaining ATM VCCs.
- 3.15 ATM VCC:** The logical concatenation of one or more ATM virtual channel links between two ATM service endpoints.
- 3.16 field:** Information carried in a parameter in a message. A field can have fixed or variable length data.
- 3.17 generic signalling transport:** The function that enables an AAL type 2 signalling entity to communicate with a peer AAL type 2 signalling entity independently of the underlying signalling transport.
- 3.18 link characteristics:** (See AAL type 2 link characteristics.)
- 3.19 nodal function:** The functions that provide the bridge between incoming and outgoing protocol entities, perform the routing, and keep track of the AAL type 2 path resources.
- 3.20 parameter:** Information carried in a message. A parameter has a fixed, defined set of fields.
- 3.21 path identifier:** See AAL type 2 path identifier.
- 3.22 protocol entity:** The functions performed within an AAL type 2 signalling entity that relate to the exchange of AAL type 2 signalling information.
- 3.23 signalling association:** A signalling capability that exists between two adjacent AAL type 2 nodes to control the AAL type 2 connections that may exist in one or more AAL type 2 paths. There may be one or more signaling associations between two adjacent AAL type 2 nodes.
- 3.24 signalling transport:** A signalling link or network that connects two AAL type 2 nodes.
- 3.25 signalling transport converter:** A function that converts the services provided by a particular signalling transport to the services required by the generic signalling transport.
- 3.26 subfield:** The smallest unit of information in a field that has its own functional meaning.

## 4 Abbreviations

This Recommendation uses the following abbreviations:

A2EA	AAL type 2 Service Endpoint Address
A2P	AAL type 2 Path Identifier
A2SU	AAL type 2 Served User
AAL	ATM Adaptation Layer
AESA	ATM End System Address
ALC	AAL type 2 Link Characteristics
ANI	Adjacent AAL type 2 Node Identifier
ATM	Asynchronous Transfer Mode
ATM VCC	ATM Virtual Channel Connection
BCD	Binary Coded Decimal
BLC	Block Confirm Message
BLO	Block Request Message
CAS	Channel Associated Signalling
CAU	Cause Parameter
CEID	AAL type 2 Connection Element Identifier
CFN	ConFusioN Message
CID	Channel Identifier
CMD	Circuit Mode Data
CPS	(AAL type 2) Common Part Sublayer
DSAID	Destination Signalling Association Identifier
DTMF	Dual Tone Multi-Frequency
ECF	Establish Confirm Message
ERQ	Establish Request Message
ESEA	Destination E.164 Service Endpoint Address Parameter
FAX	Demodulated Facsimile Data
FRM	Frame Mode Data
GST	Generic Signalling Transport
ID	Identifier
IEC	International Electrotechnical Commission
IEEE	Institute of Electrical and Electronics Engineers
ISO	International Organization for Standardization
LM	Layer Management
LSB	Least Significant Bit
M	Mandatory
MF-R1	Multi-Frequency R1

MF-R2	Multi-Frequency R2
MSB	Most Significant Bit
MTP3b	Message Transfer Part level 3 using Q.2140
NF	Nodal Function
NSAP	Network Service Access Point
NSEA	Destination NSAP Service Endpoint Address Parameter
O	Optional
OSAID	Originating Signalling Association Identifier (Parameter)
OUI	Organizational Unique Identifier
PVC	Permanent Virtual Channel
REL	Release Request Message
RES	Reset Request Message
RLC	Release Confirm Message
RSC	Reset Confirm Message
SAAL	Signalling ATM Adaptation Layer
SAID	Signalling Association Identifier
SAP	Service Access Point
SAR	Segmentation and Reassembly (Sublayer)
SDL	Specification and Description Language
SDU	Service Data Unit
SPVC	Soft PVC
SSCOP	Service Specific Connection Oriented Protocol
SSCS	Service Specific Convergence Sublayer
SSIA	Service Specific Information (Audio) Parameter
SSIM	Service Specific Information (Multirate) Parameter
SSISA	Service Specific Information (SAR-assured) Parameter
SSISU	Service Specific Information (SAR-unassured) Parameter
SSSAR	Segmentation and Reassembly Service Specific Convergence Sublayer
STC	Signalling Transport Converter
SUGR	Served User Generated Reference
SUT	Served User Transport
SVC	Switched Virtual Channel
TCI	Test Connection Indication
TED	Transmission Error Detection
UBC	Unblock Confirm Message
UBL	Unblock Request Message
UU	User-user

VCC	Virtual Channel Connection
VPC	Virtual Path Connection

## **5 General framework of the AAL type 2 signalling protocol**

The AAL type 2 signalling protocol provides the signalling capability to establish, release and maintain AAL type 2 point-to-point connections across a series of ATM VCCs that carry AAL type 2 links. These services are accessible via the AAL type 2 served user service access point (A2SU-SAP).

The AAL type 2 signalling protocol also provides maintenance functions associated with the AAL type 2 signalling.

An AAL type 2 signalling endpoint shall be able to control AAL type 2 links on more than one AAL type 2 path. These AAL type 2 paths may be contained on different ATM VPCs, which in turn may be carried on different ATM physical interfaces.

Two peer AAL type 2 signalling entities rely on the generic signalling transport service to provide assured data transfer between them and service availability indications. These services are accessible via the Generic Signalling Transport Service Access Point (GST-SAP).

Note that primitives over the A2SU-SAP, GST-SAP, and LM-SAP are used for descriptive purpose only. They do not imply a specific implementation.

Both peer AAL type 2 signalling entities provide the same set of services.

The AAL type 2 signalling entity is subdivided into protocol entities and nodal functions as shown in Figure 5-1. At each AAL type 2 service endpoint, the AAL type 2 signalling entity communicates with the AAL type 2 served user. At an AAL type 2 switch, the AAL type 2 signalling entity does not communicate with an AAL type 2 served user.

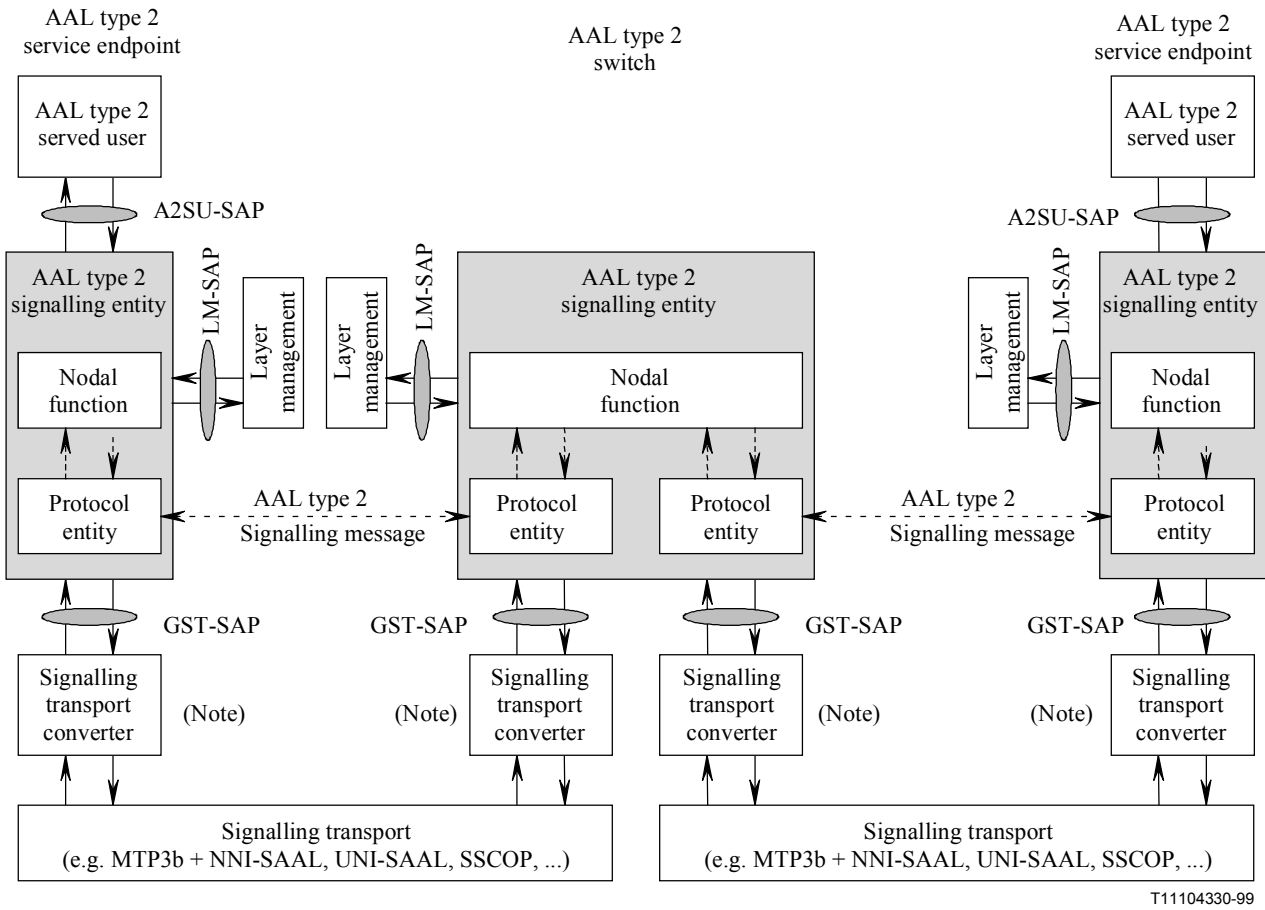

NOTE – In every AAL type 2 node, a signalling transport converter instance is associated with each AAL type 2 signalling transport.

**Figure 5-1/Q.2630.1 – AAL type 2 signalling protocol reference architecture**

Protocol Entities define the interactions between two adjacent AAL type 2 nodes. AAL type 2 messages are exchanged between peer protocol entities using the generic signalling transport service.

The AAL type 2 signalling is independent of the signalling transport, although an assured data transport is required and a message size limit applies. To adapt the generic signalling transport services to a specific signalling transport service, a signalling transport converter may be needed. The specification of signalling transport converters is beyond the scope of this ITU-T Recommendation (see ITU-T Recommendation Q.2150.2 [22] and ITU-T Recommendation Q.2150.1 [23]).

The protocol entity is divided into several procedures as shown in Figure 5-2.

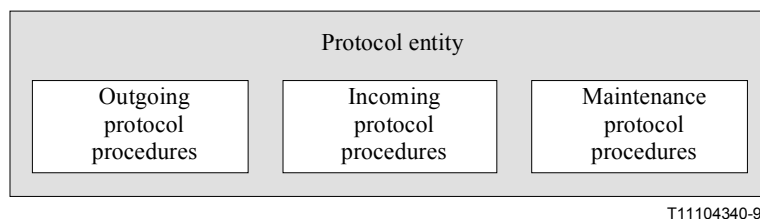

**Figure 5-2/Q.2630.1 – Internal structure of the AAL type 2 signalling protocol entity**



The outgoing protocol procedures provide the mechanism to initiate an AAL type 2 connection request. The incoming protocol procedures are applied when a request for an AAL type 2 connection is received from a peer entity. Both of these procedures provide for the orderly release of an AAL type 2 connection. The maintenance protocol procedures provide the mechanisms to align the status of the AAL type 2 resources at the two adjacent AAL type 2 nodes and the procedures to block and unblock an AAL type 2 path.

The unrecognized information procedures in the nodal function as well as in the protocol entities provide the forward compatibility mechanism which enables extension of the protocol in the future.

The nodal function provides the bridge between incoming and outgoing protocol entities, performs the routing functionality, and keeps track of the AAL type 2 path resources.

## 5.1 Interface between the AAL type 2 signalling entity and the AAL type 2 served user

### 5.1.1 Service provided by the AAL type 2 signalling entity

The AAL type 2 signalling entity provides the following services to the AAL type 2 served user across the A2SU-SAP:

- establishment of AAL type 2 connections; and
- release of AAL type 2 connections.

The AAL type 2 signalling protocol entity is independent of the AAL type 2 served user.

### 5.1.2 Primitives between AAL type 2 signalling entities and the AAL type 2 served user

The A2SU-SAP primitives are used:

- 1) by the originating served user to initiate AAL type 2 connection establishment and by the originating and destination served users to initiate the release of a connection; and
- 2) by the AAL type 2 signalling entities to indicate an incoming connection to the destination served user and notifying either the originating or destination served user of the release of a connection.

NOTE – When sending a primitive between the signalling protocol and its user, the primitive needs to be associated with a particular AAL type 2 connection instance. The mechanism used for this binding is considered to be an implementation detail and therefore is outside the scope of this ITU-T Recommendation.

The services are provided through the transfer of primitives which are summarized in Table 5-1, and are defined after the table.

The AAL type 2 served user passes information in parameters in the primitives. Some of those parameters are mandatory and some are optional; the appropriate usage of the parameters is described in clause 8.

**Table 5-1/Q.2630.1 – Primitives and parameters exchanged between the AAL type 2 signalling entities and the AAL type 2 served user**

Primitive generic name	Type			
	Request	Indication	Response	Confirm
ESTABLISH	A2EA, SUGR, SUT, TCI, SSCS, ALC	SUGR, SUT, TCI, SSCS	Not defined	–
RELEASE	Cause	Cause	Not defined	Cause
–: This primitive has no parameters.				

- a) **ESTABLISH.request:**  
This primitive is used by the AAL type 2 served user to initiate the establishment of a new AAL type 2 connection.
- b) **ESTABLISH.indication:**  
This primitive is used by the AAL type 2 signalling entities to indicate that an incoming connection has been successfully established.
- c) **ESTABLISH.confirm:**  
This primitive is used by the AAL type 2 signalling entities to indicate that the connection (which was previously requested by the served user) has successfully been established.
- d) **RELEASE.request:**  
This primitive is used by the AAL type 2 served user to initiate clearing of an AAL type 2 connection.
- e) **RELEASE.indication:**  
This primitive is used by the AAL type 2 signalling entities to indicate that an AAL type 2 connection has been released.
- f) **RELEASE.confirm:**  
This primitive is used as a negative acknowledgement for an ESTABLISH.request.

### 5.1.3 Parameters between AAL type 2 signalling entities and the AAL type 2 served user

- a) **AAL type 2 Service Endpoint Address (A2EA)**  
This parameter carries the endpoint address of the destination. It can have the form of an E.164 address or an NSAP address.
- b) **Served User Generated Reference (SUGR)**  
This parameter carries a reference provided by the originating AAL type 2 served user and this reference is transported unmodified to the destination served user.
- c) **Served User Transport (SUT)**  
This parameter carries the served user data that is transported unmodified to the destination served user.
- d) **Test Connection Indicator (TCI)**  
By its presence, this parameter indicates that the AAL type 2 connection to be established is a test connection.
- e) **SSCS information (SSCS)**  
This parameter identifies the type and the capabilities of an AAL type 2 SSCS protocol. This parameter can have the form of either:
- service specific information (audio) (see ITU-T Recommendation I.366.2 [8]);
  - Service specific information (multirate) (see ITU-T Recommendation I.366.2 [8]); or
  - Service specific information (SAR) (see ITU-T Recommendation I.366.1 [9]) with or without the additional parameters necessary for the assured data transfer.
- f) **Link Characteristics (ALC)**  
This parameter gives an indication of the resources required for the AAL type 2 connection and is used only for AAL type 2 path selection and connection admission control.
- g) **Cause**  
This parameter describes the reason for the release of the AAL type 2 connection. It also may indicate the reason why an AAL type 2 connection could not be established.

## 5.2 Interface between the AAL type 2 signalling entity and the generic signalling transport

### 5.2.1 Service provided by the generic signalling transport service

An AAL type 2 signalling protocol entity makes use of the generic signalling transport service which is provided by the signalling transport converter (for example see ITU-T Recommendations Q.2150.2 [22] and Q.2150.1 [23]). The generic signalling transport enables an AAL type 2 signalling entity to communicate with a peer AAL type 2 signalling entity independently of the underlying signalling transports, such as those specified in ITU-T Recommendation Q.2210 [24] and ITU-T Recommendation Q.2130 [26], or assured data transport, such as ITU-T Recommendation Q.2110 [25].

### 5.2.2 Primitives between AAL type 2 signalling entities and the generic signalling transport

The services are provided through the transfer of primitives which are summarized in Table 5-2, and are defined after the table.

**Table 5-2/Q.2630.1 – Primitives and parameters of the generic signalling transport sublayer**

Primitive generic name	Type			
	Request	Indication	Response	Confirm
IN-SERVICE	Not defined	Level	Not defined	Not defined
OUT-OF-SERVICE	Not defined	–	Not defined	Not defined
CONGESTION (Note)	Not defined	Level	Not defined	Not defined
TRANSFER	Sequence control, message	Message	Not defined	Not defined
–: This primitive has no parameters.				
NOTE – This primitive is optional.				

a) **IN-SERVICE.indication:**

A primitive indicating that the signalling transport is able to exchange signalling messages with the peer entity. This indication shall be provided without the AAL type 2 signalling entity requesting any service across the GST-SAP.

b) **OUT-OF-SERVICE.indication:**

A primitive indicating that the signalling transport is unable to exchange signalling messages with the peer entity. This indication shall be provided without the AAL type 2 signalling entity requesting any service across the GST-SAP.

c) **CONGESTION.indication:**

A primitive used to convey information concerning signalling congestion.

NOTE – Some signalling transport services may not issue the CONGESTION.indication primitive.

d) **TRANSFER.request:**

A primitive used by an AAL type 2 signalling entity to convey a signalling message to its peer entity.

e) **TRANSFER.indication:**

A primitive indicating the reception of a signalling message from the peer entity at an AAL type 2 signalling entity.

### 5.2.3 Parameters between AAL type 2 signalling entities and the generic signalling transport

#### a) Message

This parameter contains a complete signalling message. This parameter shall not be greater than 4000 octets.

#### b) Level

This parameter indicates the level of the congestion. This parameter shall have a value between 0 and 10, where 0 indicates no congestion and 10 indicates the maximum congestion.

#### c) Sequence control

This parameter allows the generic signalling transport service to perform load sharing between several signalling transports without violating in-sequence delivery requirements. Any signalling message accompanied by the same sequence control value shall be conveyed on the same signalling transport within the same signalling link.

### 5.2.4 AAL type 2 signalling entity – initial conditions

On the establishment of an AAL type 2 signalling transport and the associated signalling transport converter entity, for example at power up, the initial conditions of the AAL type 2 signalling entity shall be the same as if an OUT-OF-SERVICE.indication primitive had been conveyed across the GST-SAP.

### 5.2.5 State transition diagram for sequences of primitives of the generic signalling transport service

This subclause defines the constraints on the sequences in which the primitives may occur at the layer boundaries of the generic signalling transport service. The sequences are related to the states at one generic signalling transport endpoint between the generic signalling transport service provider and its user. The possible overall sequences of primitives are shown in the state transition diagram, Figure 5-3.

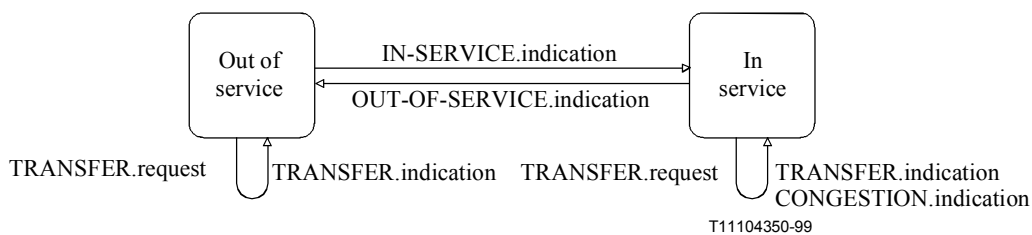

Figure 5-3/Q.2630.1 – State transition diagram for sequences of primitives between the GST and its user

This model assumes that a request primitive is never issued at the same time as an indication primitive. The model also assumes that the primitives are serviced immediately and in zero time.

## 5.3 Interface between the AAL type 2 signalling entity and layer management

### 5.3.1 Service provided by layer management

This interface provides the internal interface to the network management system.

### 5.3.2 Primitives between AAL type 2 signalling entities and layer management

The primitives are summarized in Table 5-3, and are defined after the table.

**Table 5-3/Q.2630.1 – Primitives and parameters exchanged between the AAL type 2 signalling entities and layer management**

Primitive generic name	Type			
	Request	Indication	Response	Confirm
BLOCK	ANI, A2P	Not defined	Not defined	Cause
UNBLOCK	ANI, A2P	Not defined	Not defined	Cause
RESET	ANI, CEID	ANI, CEID	Not defined	–
STOP-RESET	ANI, CEID	Not defined	Not defined	Not defined
ADD-PATH	Not defined	ANI, A2P, ownership	Not defined	Not defined
REMOVE-PATH	Not defined	ANI, A2P	Not defined	Not defined
ERROR	Not defined	ANI, CEID, cause	Not defined	Not defined
–: This primitive has no parameters.				

NOTE – When sending a primitive between the AAL type 2 signalling entity and layer management, the primitive needs to be associated with a particular management action instance. The mechanism used for this binding is considered to be an implementation detail and, therefore, is outside the scope of this ITU-T Recommendation.

a) **BLOCK.request:**

A primitive to request the AAL type 2 signalling entity to locally block a particular, unblocked AAL type 2 path and to indicate this to the peer AAL type 2 signalling entity.

b) **BLOCK.confirm:**

A primitive with no parameter indicates that the AAL type 2 signalling entity has successfully informed the peer AAL type 2 signalling entity of the blocking of a particular AAL type 2 path. A primitive with a cause parameter indicates that the AAL type 2 signalling entity has detected an error in the blocking procedures.

c) **UNBLOCK.request:**

A primitive to request the AAL type 2 signalling entity to locally unblock a particular, blocked AAL type 2 path and to indicate this to the peer AAL type 2 signalling entity.

d) **UNBLOCK.confirm:**

A primitive with no parameter indicates that the AAL type 2 signalling entity has successfully informed the peer signalling entity of the unblocking of a particular AAL type 2 path. A primitive with a cause parameter indicates that the AAL type 2 signalling entity has detected an error in the unblocking procedures.

e) **RESET.request:**

A primitive to request the AAL type 2 signalling entity to reset a particular channel, all channels on a particular AAL type 2 path, or all channels on all AAL type 2 paths associated with a signalling association to the "Idle" state and to indicate this to the peer AAL type 2 signalling entity.

f) **RESET.indication:**

A primitive indicating that the AAL type 2 signalling entity has reset a particular channel, all channels on a particular AAL type 2 path, or all channels on all AAL type 2 paths associated with a signalling association to the "Idle" state on the request of the peer AAL type 2 signalling entity.

- g) **RESET.confirm:**  
A primitive indicating that the AAL type 2 signalling entity has successfully informed the peer AAL type 2 signalling entity of the resetting of the channel or all the channels on a specific AAL type 2 path or on all AAL type 2 paths associated with a signalling association.
- h) **STOP-RESET.request:**  
A primitive to request the AAL type 2 signalling entity to stop a reset procedure.
- i) **ADD-PATH.indication:**  
This primitive informs the AAL type 2 signalling entity that a new AAL type 2 path has been established towards one of the adjacent AAL type 2 nodes.
- j) **REMOVE-PATH.indication:**  
This primitive informs the AAL type 2 signalling entity that an AAL type 2 path has been removed.
- k) **ERROR.indication:**  
A primitive to indicate any operational errors in the AAL type 2 signalling procedures.

### 5.3.3 Parameters between AAL type 2 signalling entities and layer management

- a) **AAL type 2 Path Identifier (A2P)**  
This parameter indicates an AAL type 2 path.
- b) **Connection Element Identifier (CEID)**  
This parameter allows for the identification of:
- i) all AAL type 2 paths between two adjacent AAL type 2 nodes associated with a signalling association;
  - ii) a particular AAL type 2 path; or
  - iii) a particular channel on a particular AAL type 2 path.
- c) **Cause**  
This parameter gives the reason of an operational error.
- d) **Ownership**  
This parameter indicates whether a newly established AAL type 2 path is owned by the AAL type 2 signalling entity or by its peer.
- e) **Adjacent AAL type 2 Node Identifier (ANI)**  
This parameter is used to unambiguously indicate an adjacent AAL type 2 node.

## 6 Forward and backward compatibility

The compatibility mechanism remains unchanged for all capability sets and/or subsets of the AAL type 2 protocol defined in this ITU-T Recommendation. It is based on forward compatibility information associated with all signalling information.

The compatibility method eases the network operation, for example:

- For the typical case of a AAL type 2 signalling protocol mismatch during a network upgrading;
- To interconnect two networks on a different functional level;
- For networks using a different subset of the same AAL type 2 protocol, etc.

NOTE – A node may be at a different functional level due to having implemented a different capability set or another subset of the protocol specified in this ITU-T Recommendation.

## 6.1 Backward compatibility rules

Compatible interworking between AAL type 2 protocol capability sets should be optimized by adhering to the following rules when specifying a new capability set (release):

- 1) Existing protocol elements, i.e. procedures, messages, parameters and subfield values, should not be changed unless a protocol error needs to be corrected or it becomes necessary to change the operation of the service that is being supported by the protocol.
- 2) The semantics of a message, a parameter, or of a field and subfield within a parameter should not be changed.
- 3) Established rules for formatting and encoding messages and parameters should not be modified.
- 4) The forward compatibility mechanism specified in 6.2 and 8.1 applies to this and future capability sets of this ITU-T Recommendation.

## 6.2 Forward compatibility mechanism

Compatibility between this and future capability sets will be guaranteed, in the sense that any two capability sets can be interconnected directly with each other, if the following requirements are fulfilled:

- i) *Protocol compatibility*  
Connections between any two AAL type 2 protocols do not fail for the reason of not satisfying protocol requirements.
- ii) *Service and functional compatibility*  
This feature may be considered as compatibility typically between originating and destination nodes. Services and functions available at these nodes, but possibly not yet taken into account in the intermediate nodes, are supported, provided that information related to these services and functions can be passed transparently through intermediate nodes.
- iii) *Resource control and management compatibility*  
For these functions, occurring only link-by-link, at least a backward notification is needed, if correct handling is not possible.

## 7 Format and coding of AAL type 2 signalling protocol

### 7.1 Coding conventions for the AAL type 2 signalling protocol

#### 7.1.1 Principles

The following principles shall apply for the coding of the AAL type 2 signalling protocol:

- a) The order of coding of messages shall consist of "destination signalling association identifier", "message identifier", "message compatibility", and any parameters.
- b) Messages shall carry zero or more parameters.
- c) The sequence of parameters is unconstrained.
- d) The order of coding of parameters shall consist of "parameter identifier", "parameter compatibility", "parameter length", and any fields.
- e) Parameters shall carry zero or more fields.
- f) A parameter shall always consist of the same sequence of fields.
- g) If new fields need to be added to a parameter or the length of a fixed size field needs to be changed, the modifications shall be carried in a new parameter (different parameter identifier); the existing parameter shall remain unchanged.

- h) Any sequence of fixed size fields and variable size fields is permissible.
- i) Fixed length fields shall consist of the "field" only; no length is indicated.
- j) Variable length fields shall consist of "field length" and "field".
- k) Fields shall be multiples of one octet.
- l) Fields are composed of one or more subfields.
- m) Reserved subfields shall be coded all zeroes and need not be interpreted by the receiver.
- n) If there is no information to be carried in a variable size field, its length shall be set to zero, i.e. only the field length octet will be present.
- o) If there is no information to be carried in a fixed size field, its content shall be set to zero in all octets.
- p) The presence or the interpretation of a field shall not depend on the value of a field in another parameter.

Consistent with the above coding principles, it is further specified that:

- The message length shall allow for lengths of up to 4000 octets.
- The parameter length shall allow for lengths of up to 255 octets.

### 7.1.2 General format of messages

The general format of a message is shown in Table 7-1.

NOTE – No "message length" needs to be carried in the message itself; the length of information passed via a primitive implicitly defines its length and the assured data transfer assures that no octets are lost or gained in transport.

**Table 7-1/Q.2630.1 – AAL type 2 message format**

	8	7	6	5	4	3	2	1	Octets
Header	Destination signalling association identifier								4
	Message identifier								1
	Message compatibility								1
Payload	Parameters								

The message header consists of the destination signalling association identifier field, the message identifier field, and the message compatibility field. The destination signalling association identifier field is coded the same as the signalling association identifier field (see 7.4.2), the coding of the message identifier field is specified in 7.2.1, and the message compatibility field is coded the same as the compatibility field (see 7.4.1).

The message payload consists of zero, one, or more parameters.

#### 7.1.2.1 Bit coding rules

When a field is contained within a single octet, the lowest bit number of the field represents the lowest order value.

When a field spans more than one octet, the order of bit values within each octet progressively decreases as the octet number increases; the lowest bit number associated with the field represents the lowest order value.

This leads to the following conventions:

- bits within an octet are sent in decreasing order, starting with bit 8;
- octets are sent in increasing order, starting with octet 1;



- for all fields, the first bit sent is the Most Significant Bit (MSB).  
(This coding conforms to the coding conventions specified in 2.1/I.361 [2].)

### 7.1.3 General format of parameters

The general format of a parameter is shown in Table 7-2.

**Table 7-2/Q.2630.1 – AAL type 2 parameter format**

	8	7	6	5	4	3	2	1	Octets
Header	Parameter identifier								1
	Parameter compatibility								1
	Parameter length								1
Payload	Fields								

The coding of the parameter identifier field is specified in 7.2.2 Table 7-7 and the parameter compatibility field is coded as a compatibility field (see 7.4.1). The coding of the parameter length is a binary value indicating the number of octets in the parameter payload, i.e. the count does not include the octets in the parameter header.

Each parameter has a defined number of fields of defined type and in a particular order.

### 7.1.4 General format of fixed length fields

The general format of a fixed length field is shown in Table 7-3.

**Table 7-3/Q.2630.1 – AAL type 2 field – fixed length format**

	8	7	6	5	4	3	2	1	Octet
Payload	Field								n

The field type is determined by the location of the field in the particular parameter.

### 7.1.5 General format of variable length fields

The general format of a variable length field is shown in Table 7-4.

**Table 7-4/Q.2630.1 – AAL type 2 field – variable length format**

	8	7	6	5	4	3	2	1	Octets
Payload	Field length								1
	Field								n

The coding of the field length is a binary value indicating the number of octets in the field payload, i.e. the count does not include the field length octet.

The field type is determined by the location of the field in the particular parameter.

## 7.2 Format and coding of the AAL type 2 signalling protocol messages

### 7.2.1 AAL type 2 signalling protocol messages

The AAL type 2 signalling protocol messages and their message identifiers are shown in Table 7-5.

**Table 7-5/Q.2630.1 – AAL type 2 messages and the coding of the message identifiers**

Message	Acronym	Message identifier
Block confirm	BLC	00000001
Block request	BLO	00000010
Confusion	CFN	00000011
Establish confirm	ECF	00000100
Establish request	ERQ	00000101
Release confirm	RLC	00000110
Release request	REL	00000111
Reset confirm	RSC	00001000
Reset request	RES	00001001
Unblock confirm	UBC	00001010
Unblock request	UBL	00001011

### 7.2.2 Parameters of the AAL type 2 signalling protocol messages

The parameters of the AAL type 2 signalling protocol messages are shown in Table 7-6. The indications of "mandatory" and "optional" are for information only. The authoritative definition is given in clause 8. If any difference between the indications in this clause and the definitions in clause 8 exists, the definitions in clause 8 take precedence.

Multiple presence of the same parameter in a single message is not permitted.

**Table 7-6/Q.2630.1 – Parameters of the AAL type 2 signalling protocol messages (part 1 of 2)**

Parameter	Message						
	ERQ	ECF	REL	RLC			
Cause	–	–	M	(Note 5)			
Connection element identifier	M	–	–	–			
Destination E.164 service endpoint address	(Note 3)	–	–	–			
Destination NSAP service endpoint address	(Note 3)	–	–	–			
Destination signalling association identifier (Note 1)	(Note 2)	M	M	M			
Link characteristics	O	–	–	–			
Originating signalling association identifier	M	M	–	–			
Served user generated reference	O	–	–	–			
Served user transport	O	–	–	–			
Service specific information (audio)	(Note 4)	–	–	–			
Service specific information (multirate)	(Note 4)	–	–	–			
Service specific information (SAR-assured)	(Note 4)	–	–	–			
Service specific information (SAR-unassured)	(Note 4)	–	–	–			
Test connection indicator	O	–	–	–			

**Table 7-6/Q.2630.1 – Parameters of the AAL type 2 signalling protocol messages  
(part 1 of 2) (concluded)**

M	Mandatory parameter
O	Optional parameter
–	Parameter not present
NOTE 1 – This row designates the destination signalling association identifier field in the message header.	
NOTE 2 – The destination signalling association identifier field contains the value "unknown".	
NOTE 3 – Exactly one of these parameters must be present in an instance of the message.	
NOTE 4 – At most one of these parameters is present in an instance of the message.	
NOTE 5 – The "Cause" parameter is present in the release confirm message if:	
a) the RLC is used to reject a connection establishment; or	
b) the cause reports unrecognized information received in the REL message.	

**Table 7-6/Q.2630.1 – Parameters of the AAL type 2 signalling protocol messages (part 2 of 2)**

Parameter	Message						
	RES	RSC	BLO	BLC	UBL	UBC	CFN
Cause	–	(Note 4)	–	(Note 4)	–	(Note 4)	M
Connection element identifier	M	–	M (Note 3)	–	M (Note 3)	–	–
Destination signalling association identifier (Note 1)	(Note 2)	M	(Note 2)	M	(Note 2)	M	M
Originating signalling association identifier	M	–	M	–	M	–	–

M Mandatory parameter  
O Optional parameter  
– Parameter not present

NOTE 1 – This row designates the destination signalling association identifier field in the message header.  
NOTE 2 – The destination signalling association identifier field contains the value "unknown".  
NOTE 3 – The channel identifier field is set to "Null", but the path identifier includes a value identifying an AAL type 2 path.  
NOTE 4 – The "Cause" parameter is present only if the cause reports unrecognized information received.

The identifiers of the AAL type 2 message parameters are defined in Table 7-7.

**Table 7-7/Q.2630.1 – Identifiers of the AAL type 2 message parameters**

AAL type 2 parameter	Ref.	Acronym	Identifier
Cause	7.3.1	CAU	00000001
Connection element identifier	7.3.2	CEID	00000010
Destination E.164 service endpoint address	7.3.3	ESEA	00000011
Destination NSAP service endpoint address	7.3.4	NSEA	00000100
Link characteristics	7.3.5	ALC	00000101
Originating signalling association identifier	7.3.6	OSAID	00000110
Served user generated reference	7.3.7	SUGR	00000111

**Table 7-7/Q.2630.1 – Identifiers of the AAL type 2 message parameters (concluded)**

<b>AAL type 2 parameter</b>	<b>Ref.</b>	<b>Acronym</b>	<b>Identifier</b>
Served user transport	7.3.8	SUT	00001000
Service specific information (audio)	7.3.9	SSIA	00001001
Service specific information (multirate)	7.3.10	SSIM	00001010
Service specific information (SAR-assured)	7.3.11	SSISA	00001011
Service specific information (SAR-unassured)	7.3.12	SSISU	00001100
Test connection indicator	7.3.13	TCI	00001101

### 7.3 Parameter specification of the AAL type 2 signalling protocol messages

#### 7.3.1 Cause

The sequence of fields in the cause parameter is shown in Table 7-8.

**Table 7-8/Q.2630.1 – Sequence of fields in the cause parameter**

<b>Field No.</b>	<b>Field</b>	<b>Ref.</b>
1	Cause value	7.4.16
2	Diagnostics	7.4.17

#### 7.3.2 Connection element identifier

The sequence of fields in the connection element identifier parameter is shown in Table 7-9.

**Table 7-9/Q.2630.1 – Sequence of fields in the connection element identifier parameter**

<b>Field No.</b>	<b>Field</b>	<b>Ref.</b>
1	Path identifier	7.4.3
2	Channel identifier	7.4.4

<b>AAL type 2 path identifier</b>	<b>Channel identifier</b>	<b>Meaning</b>
Null	Ignored	All AAL type 2 paths associated with a signalling association
Value	Null	AAL type 2 path identifier "Value"
Value	CID	Channel "CID" in AAL type 2 path identifier "Value"

#### 7.3.3 Destination E.164 service endpoint address

The sequence of fields in the destination E.164 [10] service endpoint address parameter is shown in Table 7-10.

**Table 7-10/Q.2630.1 – Sequence of fields in the destination E.164 service endpoint address parameter**

Field No.	Field	Ref.
1	Nature of address	7.4.13
2	E.164 address	7.4.14

#### 7.3.4 Destination NSAP service endpoint address

The sequence of fields in the destination NSAP [5] service endpoint address parameter is shown in Table 7-11.

**Table 7-11/Q.2630.1 – Sequence of fields in the destination NSAP service endpoint address parameter**

Field No.	Field	Ref.
1	NSAP address	7.4.15

#### 7.3.5 Link characteristics

The sequence of fields in the link characteristics parameter is shown in Table 7-12.

**Table 7-12/Q.2630.1 – Sequence of fields in the link characteristics parameter**

Field No.	Field	Ref.
1	Maximum CPS-SDU bit rate	(Note 1)
2	Average CPS-SDU bit rate	(Note 1)
3	Maximum CPS-SDU size	(Note 2)
4	Average CPS-SDU size	(Note 2)
NOTE 1 – This field is coded as a CPS-SDU bit rate field (see 7.4.11).		
NOTE 2 – This field is coded as a CPS-SDU size field (see 7.4.12).		

#### 7.3.6 Originating signalling association identifier

The sequence of fields in the originating signalling association identifier parameter is shown in Table 7-13.

**Table 7-13/Q.2630.1 – Sequence of fields in the originating signalling association identifier parameter**

Field No.	Field	Ref.
1	Originating signalling association	(Note)
NOTE – This field is coded as a signalling association identifier field (see 7.4.2).		

#### 7.3.7 Served user generated reference

The sequence of fields in the served user generated reference parameter is shown in Table 7-14.

**Table 7-14/Q.2630.1 – Sequence of fields in the served user generated reference parameter**

<b>Field No.</b>	<b>Field</b>	<b>Ref.</b>
1	Served user generated reference	7.4.10

### 7.3.8 Served user transport

The sequence of fields in the served user transport parameter is shown in Table 7-15.

**Table 7-15/Q.2630.1 – Sequence of fields in the served user transport parameter**

<b>Field No.</b>	<b>Field</b>	<b>Ref.</b>
1	Served user transport	7.4.18

### 7.3.9 Service specific information (audio)

The sequence of fields in the service specific information (audio) parameter is shown in Table 7-16.

**Table 7-16/Q.2630.1 – Sequence of fields in the service specific information (audio) parameter**

<b>Field No.</b>	<b>Field</b>	<b>Ref.</b>
1	Audio service	7.4.6
2	Organizational unique identifier	7.4.5

### 7.3.10 Service specific information (multirate)

The sequence of fields in the service specific information (multirate) parameter is shown in Table 7-17.

**Table 7-17/Q.2630.1 – Sequence of fields in the service specific information (multirate) parameter**

<b>Field No.</b>	<b>Field</b>	<b>Ref.</b>
1	Multirate service	7.4.7

### 7.3.11 Service specific information (SAR-assured)

The sequence of fields in the service specific information (SAR-assured) parameter is shown in Table 7-18.

**Table 7-18/Q.2630.1 – Sequence of fields in the service specific information (SAR-assured) parameter**

<b>Field No.</b>	<b>Field</b>	<b>Ref.</b>
1	Segmentation and reassembly (assured data transfer)	7.4.8

### 7.3.12 Service specific information (SAR-unassured)

The sequence of fields in the service specific information (SAR-unassured) parameter is shown in Table 7-19.

**Table 7-19/Q.2630.1 – Sequence of fields in the service specific information (SAR-unassured) parameter**

Field No.	Field	Ref.
1	Segmentation and reassembly (unassured data transfer)	7.4.9

### 7.3.13 Test connection indicator

The test connection indicator parameter has no fields, i.e. the parameter length is always zero.

## 7.4 Field specification of the AAL type 2 signalling protocol parameters

### 7.4.1 Compatibility

The structure of the compatibility field is shown in Table 7-20; the field is a fixed size field of 1 octet.

**Table 7-20/Q.2630.1 – Structure of the compatibility field**

8	7	6	5	4	3	2	1	Octet
Pass-on not possible				General action				1
Reserved	Send notification indicator	Instruction indicator		Reserved	Send notification indicator	Instruction indicator		

The following codes are used in the subfields of the compatibility information field.

- a) *Send notification indicator*
  - 0 Do not send notification.
  - 1 Send notification.
- b) *Instruction indicator*
  - 00 Pass on message or parameter (see Note 1).
  - 01 Discard parameter (see Note 2).
  - 10 Discard message.
  - 11 Release connection.

NOTE 1 – When used in a "pass-on not possible" instruction indicator, value "00" is interpreted so as to release the connection.

NOTE 2 – When used as message compatibility field, value "01" should not be used. If received, it is interpreted so as to discard the message.

### 7.4.2 Signalling association identifier

The structure of the signalling association identifier field is shown in Table 7-21; the field is a fixed size field of 4 octets.

**Table 7-21/Q.2630.1 – Structure of the signalling association identifier field**

8	7	6	5	4	3	2	1	Octets
								1
								2
								3
								4

The coding is implementation dependent.

If the signalling association identifier is used as a destination signalling association identifier that is not known, the field is set to zero indicating the value "unknown".

If the signalling association identifier is used as an originating signalling association identifier, the value zero shall not be used.

### 7.4.3 AAL type 2 path identifier

The structure of the AAL type 2 path identifier field is shown in Table 7-22; the field is a fixed size field of 4 octets.

**Table 7-22/Q.2630.1 – Structure of the AAL type 2 path identifier field**

8	7	6	5	4	3	2	1	Octets
								1
								2
								3
								4

The coding is implementation dependent. It identifies unambiguously an AAL type 2 path between a pair of adjacent AAL type 2 nodes. A value of "0" in all octets indicates "Null", therefore, the all zero code cannot be used to identify an AAL type 2 path.

NOTE – When the AAL type 2 path is a switched VCC between two adjacent AAL type 2 nodes, the procedure defined in 9.2/Q.2941.2 [27] may be used to assign the AAL type 2 path identifier field value at the time of the VCC establishment.

### 7.4.4 Channel identifier

The structure of the channel identifier field is shown in Table 7-23; the field is a fixed size field of 1 octet.

**Table 7-23/Q.2630.1 – Structure of the channel identifier field**

8	7	6	5	4	3	2	1	Octet
								1

The coding reflects the Channel Identifier (CID) as specified in ITU-T Recommendation I.363.2 [1]. CID values permitted in this field range from "8" to "255" inclusive. A value of "0" indicates "Null".

### 7.4.5 Organizational unique identifier

The structure of the organizational unique identifier field is shown in Table 7-24; the field is a fixed size field of 3 octets.



**Table 7-24/Q.2630.1 – Structure of the organizational unique identifier field**

8	7	6	5	4	3	2	1	Octets
								1
								2
								3

The coding reflects the Organizational Unique Identifier (OUI) specified by 5.1/IEEE 802-1990 [11].

#### 7.4.6 Audio service

The audio service for the AAL type 2 is defined in ITU-T Recommendation I.366.2 [8]. The structure of the audio service field is shown in Table 7-25; the field is a fixed size field of 5 octets.

**Table 7-25/Q.2630.1 – Structure of the audio service field**

8	7	6	5	4	3	2	1	Octets
Profile type		Reserved						1
Profile identifier								2
FRM	CMD	MF-R2	MF-R1	DTMF	CAS	FAX	A/μ-Law	3
Maximum length of frame mode data								4
								5

The following codes are used in the subfields of the audio service field:

a) *Profile type:*

- 00 The "Profile identifier" designates a profile specified in ITU-T Recommendation I.366.2 [8]; the organizational unique identifier field in the same parameter is ignored.
- 01 The "Profile identifier" designates a profile specified by an organization designated by the organizational unique identifier field in the same parameter.
- 10 The "Profile identifier" designates a custom profile; the organizational unique identifier field in the same parameter is ignored.
- 11 Reserved.

b) *Profile identifier*

The "Profile identifier" designates a profile as specified in either ITU-T Recommendation I.366.2 [8], by an organization designated by the organizational unique identifier field in the same parameter, or a custom profile depending of the value of the "Profile type".

- c)
- |       |    |  |
|-------|----|--|
| FRM   | 0: | Transport of frame mode data disabled                          |
|       | 1: | Transport of frame mode data enabled                           |
| CMD   | 0: | Transport of circuit mode data (64 kbit/s) disabled            |
|       | 1: | Transport of circuit mode data (64 kbit/s) enabled             |
| MF-R2 | 0: | Transport of multi-frequency R2 dialled digits disabled        |
|       | 1: | Transport of multi-frequency R2 dialled digits enabled         |
| MF-R1 | 0: | Transport of multi-frequency R1 dialled digits disabled        |
|       | 1: | Transport of multi-frequency R1 dialled digits enabled         |
| DTMF  | 0: | Transport of dual tone multi-frequency dialled digits disabled |
|       | 1: | Transport of dual tone multi-frequency dialled digits enabled  |
| CAS   | 0: | Transport of channel associated signalling disabled            |
|       | 1: | Transport of channel associated signalling enabled             |

FAX	0:	Transport of demodulated facsimile data disabled
	1:	Transport of demodulated facsimile data enabled
A/ $\mu$ -Law	0:	Interpretation of generic PCM coding: A-Law
	1:	Interpretation of generic PCM coding: $\mu$ -Law

#### 7.4.7 Multirate service

The multirate service for the AAL type 2 is defined in ITU-T Recommendation I.366.2 [8]. The structure of the multirate service field is shown in Table 7-26; the field is a fixed size field of 3 octets.

**Table 7-26/Q.2630.1 – Structure of the multirate service field**

8	7	6	5	4	3	2	1	Octets
FRM	Reserved		Multiplier n for $n \times 64$ kbit/s					1
Maximum length of frame mode data								2
								3

FRM 0: Transport of frame mode data disabled

1: Transport of frame mode data enabled

n  $1 \leq n \leq 31$  Multiplier for  $n \times 64$  kbit/s

#### 7.4.8 Segmentation and reassembly (assured data transfer)

The segmentation and reassembly service for the AAL type 2 is defined in ITU-T Recommendation I.366.1 [9]. The structure of the segmentation and reassembly (assured data transfer) field is shown in Table 7-27; the field is a fixed size field of 14 octets.

**Table 7-27/Q.2630.1 – Structure of the segmentation and reassembly (assured data transfer) field**

8	7	6	5	4	3	2	1	Octets
Maximum length of SSSAR-SDU in the forward direction								1
								2
								3
Maximum length of SSSAR-SDU in the backward direction								4
								5
								6
Maximum length of SSCOP-SDU in the forward direction								7
								8
Maximum length of SSCOP-SDU in the backward direction								9
								10
Maximum length of SSCOP-UU in the forward direction								11
								12
Maximum length of SSCOP-UU in the backward direction								13
								14

#### 7.4.9 Segmentation and reassembly (unassured data transfer)

The structure of the segmentation and reassembly (unassured data transfer) field is shown in Table 7-28; the field is a fixed size field of 7 octets.

**Table 7-28/Q.2630.1 – Structure of the segmentation and reassembly (unassured data transfer) field**

8	7	6	5	4	3	2	1	Octets
Maximum length of SSSAR-SDU in the forward direction								1
								2
								3
Maximum length of SSSAR-SDU in the backward direction								4
								5
								6
TED		Reserved						7

TED 0: Transmission error detection disabled

1: Transmission error detection enabled

#### 7.4.10 Served user generated reference

The structure of the served user generated reference field is shown in Table 7-29; the field is a fixed size field of 4 octets.

**Table 7-29/Q.2630.1 – Structure of the served user generated reference field**

8	7	6	5	4	3	2	1	Octets
								1
								2
								3
								4

#### 7.4.11 CPS-SDU bit rate

The structure of the CPS-SDU bit rate field is shown in Table 7-30; the field is a fixed size field of 4 octets.

**Table 7-30/Q.2630.1 – Structure of the CPS-SDU bit rate field**

8	7	6	5	4	3	2	1	Octets
CPS-SDU bit rate in the forward direction								1
								2
CPS-SDU bit rate in the backward direction								3
								4

This field may be used to convey the maximum CPS-SDU bit rate or the average CPS-SDU bit rate.

The maximum CPS-SDU bit rate is defined as the maximum bandwidth, available to the AAL type 2 served user in the specified direction. The maximum bandwidth is the maximum ratio of the amount of bits transported during the inter-departure time between two subsequent CPS-SDUs, and that inter-departure time. Allowed values are 0 to 2048 kbit/s. The granularity is 64 bit/s.

The average CPS-SDU bit rate is defined as the total expected amount of bits transported in the specified direction during the holding time of the connection, divided by the holding time of the connection. The average bit rate is also expected to be valid for the time interval between any two active periods. Allowed values are 0 to 2048 kbit/s. The granularity is 64 bit/s.

#### 7.4.12 CPS-SDU size

The structure of the CPS-SDU size field is shown in Table 7-31; the field is a fixed size field of 2 octets.

**Table 7-31/Q.2630.1 – Structure of the CPS-SDU size field**

8	7	6	5	4	3	2	1	Octets
CPS-SDU size in the forward direction								1
CPS-SDU size in the backward direction								2

This field may be used to convey the maximum CPS-SDU size or the average CPS-SDU size.

The maximum CPS-SDU size is defined as the largest CPS-SDU size, in octets, allowed to be sent in the specified direction during the holding time of the connection. Allowed values are 1 to 45.

The average CPS-SDU size is defined in the specified direction as the expected number of transported octets divided by the number of transported CPS-SDUs during the holding time of the connection. The average CPS-SDU size is also expected to be valid for the time interval between any two active periods. Allowed values are 1 to 45.

#### 7.4.13 Nature of address

The structure of the nature of address field is shown in Table 7-32; the field is a fixed size field of 1 octet.

**Table 7-32/Q.2630.1 – Structure of the nature of address field**

8	7	6	5	4	3	2	1	Octet
Reserved	Nature of address code							1

The "nature of address code" has the following meaning:

0000000	spare	0000110	} spare
0000001	subscriber number (national use)	to	
0000010	unknown (national use) (Note 1)	1101111	} reserved for national use
0000011	national (significant) number	1110000	
0000100	international number	to	
0000101	network-specific number (national use) (Note 2)	1111110	

NOTE 1 – This codepoint is used when the type of number is indicated using the digits in the E.164 address field. The E.164 address field is organized according to the network dialling plan; e.g. prefix digits might be present; in addition, escape digits may also be present.

NOTE 2 – This codepoint is used to indicate an administration/service number specific to the serving network.

#### 7.4.14 E.164 address

The structure of the E.164 address field is shown in Table 7-33; the field is a variable size field.

**Table 7-33/Q.2630.1 – Structure of the E.164 address field**

8	7	6	5	4	3	2	1	Octets
Field length								1
Reserved				First hexadecimal digit of address				2
				-----				
				Last hexadecimal digit of address				n

#### 7.4.15 NSAP address

The structure of the NSAP [5] address field is shown in Table 7-34; the field is a fixed size field of 20 octets.

**Table 7-34/Q.2630.1 – Structure of the NSAP address field**

8	7	6	5	4	3	2	1	Octets
NSAP								1
								20

#### 7.4.16 Cause value

The structure of the cause value field is shown in Table 7-35; the field is a fixed size field of 2 octets.

**Table 7-35/Q.2630.1 – Structure of the cause value field**

8	7	6	5	4	3	2	1	Octets
Reserved						Coding standard		1
Reserved	Cause							2

#### Coding standard

- 00 ITU-T standardized coding as described in ITU-T Recommendations Q.850 [6] and Q.2610 [7]
- 01 ISO/IEC standard (Note)
- 10 national standard (Note)
- 11 standard defined for the network (either public or private) present on the network side of the interface (Note)

NOTE – These other coding standards should be used only when the parameter contents cannot be represented with the ITU-T standardized coding.

The procedures defined in clause 8 make use of ITU-T standardized codes described in ITU-T Recommendations Q.850 [6] and Q.2610 [7]. The codes are listed here for convenience. If there exists any difference in the names and codepoints of the following causes, the definitions in ITU-T Recommendations Q.850 and Q.2610 take precedence.

#### Code Cause description

- 1 Unallocated (unassigned) number
- 3 No route to destination
- 31 Normal, unspecified
- 34 No circuit/channel available
- 38 Network out of order
- 41 Temporary failure
- 42 Switching equipment congestion
- 44 Requested circuit/channel not available
- 47 Resource unavailable, unspecified
- 93 AAL parameters cannot be supported
- 95 Invalid message, unspecified
- 96 Mandatory information element is missing
- 97 Message type non-existent or not implemented
- 99 Information element/parameter non-existent or not implemented

- 100 Invalid information element contents
- 102 Recovery on timer expiry
- 110 Message with unrecognized parameter, discarded

### 7.4.17 Diagnostics

The structure of the diagnostics field is shown in Table 7-36; the field is a variable size field.

**Table 7-36/Q.2630.1 – Structure of the diagnostic field**

8	7	6	5	4	3	2	1		
Field length									Octets
									1
Diagnostic									2
									n

The coding is specified in ITU-T Recommendation Q.2610 [7] except when associated with one of the following causes:

- message type non-existent or not implemented;
- information element/parameter non-existent or not implemented; or
- message with unrecognized parameter, discarded.

In these cases, the diagnostics field is shown in Table 7-37; the field is a variable size field.

**Table 7-37/Q.2630.1 – Structure of the diagnostic field for compatibility causes**

8	7	6	5	4	3	2	1			
Field length									Octets	
									1	
Message identifier									2	
									3	
first pair			Parameter identifier							
									4	
second pair			Parameter identifier							
									5	
pair			Field number							
									6	
									n	
last pair			Parameter identifier							
									n	
pair			Field number							
									n	

The diagnostic field for compatibility always starts – after the field length – with an octet containing the copy of the message identifier (of the message that gave rise to a compatibility diagnostic) followed by 0 to 125 octet pairs each containing a parameter identifier and a field number. If the field number octet is zero, the whole parameter is designated.

### 7.4.18 Served user transport

The structure of the served user transport field is shown in Table 7-38; the field is a variable size field.

**Table 7-38/Q.2630.1 – Structure of the served user transport field**

8	7	6	5	4	3	2	1		
Field length									Octets
									1
Served user transport									2
									n

The served user transport length can be from 1 to 254 octets.

## **8 Procedure of the AAL type 2 signalling protocol**

Before an ATM VCC (AAL type 2 path) is put into service between a pair of adjacent AAL type 2 nodes, certain actions need to be performed. An identifier called the AAL type 2 path identifier is assigned to the ATM VCC. This identifier is used to refer to the ATM VCC in the AAL type 2 signalling protocol messages. The AAL type 2 path identifier shall uniquely identify the ATM VCC between the two adjacent AAL type 2 nodes.

On any ATM VCC used for AAL type 2 connections, all CID values from "8" to "255" are available for assignment.

Any time a new ATM VCC is put into service, the ownership of the ATM VCC shall be determined before AAL type 2 connections are established in it. In case of switched ATM VCC, the owner of the VCC shall be the AAL type 2 node that initiated the establishment of the VCC. In case of PVC and soft PVC, it is the responsibility of the management system to determine the owner of the VCC.

The nodal function is informed by layer management of a newly established AAL type 2 path by the use of the ADD-PATH.indication primitive containing the adjacent AAL type 2 node identifier, the AAL type 2 path identifier, and the ownership. The nodal function is informed by layer management of the removal of an AAL type 2 path by use of the REMOVE-PATH.indication primitive containing the adjacent AAL type 2 node identifier and the AAL type 2 path identifier.

In order to minimize the likelihood of CID collision, the following CID allocation mechanism shall be used:

- if the AAL type 2 node owns the AAL type 2 path that carries the new connection, it allocates CID values from CID value 8 upwards; and
- if the AAL type 2 node does not own the AAL type 2 path that carries the new connection, it allocates CID values from CID value 255 downwards.

Each AAL type 2 connection request (regardless of whether it comes directly from an AAL type 2 served user or from an adjacent AAL type 2 node) shall contain an AAL type 2 service endpoint address which indicates the destination of the intended AAL type 2 connection instance. This information is used to route the AAL type 2 connection via the AAL type 2 network to its destination endpoint. In capability set 1, the supported address formats are: NSAP and E.164.

It is up to the application area or the operator of a particular network to decide what addressing plan is used in the AAL type 2 network. The addressing plan in the AAL type 2 network can be a reuse of the addressing plan in the underlying ATM network but it can also be an independent addressing plan defined exclusively for the AAL type 2 network.

NOTE – Causes in the procedures defined in clause 8 specify which ITU-T standardized code should be used in cause parameters of AAL type 2 signalling protocol messages. Implementation dependent non-standardized causes may be used for AAL type 2 signalling entity internal processing and for A2SU-SAP and LM-SAP cause primitive parameters.

The service endpoint address, the served user generated reference, the served user transport parameter, the link characteristics, the SSCS information, and the test connection indicator shall not be modified by the nodal function. The served user generated reference and the served user transport are parameters with significance to the served user only, therefore, they shall not be examined by the nodal function.

### **8.1 Compatibility**

#### **8.1.1 General requirements on receipt of unrecognized signalling information**

It may happen that a node receives unrecognized signalling information, i.e. messages, parameter types or subfield values. This can typically be caused by the upgrading of the signalling system used

by other nodes in the network. In these cases the following compatibility procedures are invoked to ensure the predictable network behaviour.

All messages and parameters shall include a compatibility field generated by the nodal function.

The procedures to be used on receipt of unrecognized information make use of:

- compatibility field received in the same message as the unrecognized information;
- the cause parameter containing a cause value and diagnostics;
- the confusion message and the release request message (maintaining the signalling association); and
- the release confirm message, the reset confirm message, the block confirm message, and the unblock confirm message (terminating the signalling association).

The following causes are used:

- "message type non-existent or not implemented";
- "information element/parameter non-existent or not implemented"; or
- "message with unrecognized parameter, discarded".

For all the above causes a diagnostic field is included containing, dependant on the cause, the message identifier and zero, one, or more pairs of parameter identifier and field number.

The procedures are based on the following assumptions:

- i) Since nodes can be both national and international nodes, the compatibility mechanism is applicable to the national and international network.
- ii) If a node receives a confusion message, a release request message, a release confirm message, a reset confirm message, a block confirm message, or an unblock confirm message indicating an unrecognized message or parameter received, it assumes interaction with a node supporting a different functional level.

NOTE 1 – A node may be at a different functional level due to having implemented a different capability set or another subset of the protocol specified in this ITU-T Recommendation.

When an unrecognized parameter or message is received, the node will find some corresponding instructions contained in the parameter compatibility information or message compatibility field respectively. The message compatibility field contains the instructions specific for the handling of the complete message.

The instruction indicators consist of two subfields, one to indicate how to handle unrecognized parameters or messages and the other to indicate what to do when an unrecognized parameter or message cannot be passed on. The following general rules apply to the interpretation of these instruction indicators:

- a) "Reserved" subfields of the compatibility field are not examined. They may be used by future capability sets of this ITU-T Recommendation; in this case, the future capability sets will set the currently defined instruction indicators to a reasonable value for nodes implementing the current capability set. This rule ensures that more types of instructions can be defined in the future without creating a backward compatibility problem.
- b) At an AAL type 2 node, the connection is released, using normal release procedures, if the instruction indicator is set to "release connection".
- c) At an AAL type 2 node if the instruction indicator is set to: "Discard message", or "Discard parameter", the message or parameter is discarded, as instructed. If the send notification indicator is set to "send notification", the appropriate message is issued towards the node that sent the unrecognized information:
  - A confusion message is sent in response to an establish request message, an establish confirm message or in response to an unrecognized message.



- The appropriate confirm message is sent in response to a release request message, block request message, unblock request message, or reset request message.
  - No response is returned in response to a confusion message, release confirm message, block confirm message, unblock confirm message, or reset confirm message.
- d) At an AAL type 2 node, if the instruction indicator is set to "pass-on", the unrecognized message or parameter is passed to the signalling association on the other side of the AAL type 2 switch used for this connection. If the ability to "pass-on" is not possible at an AAL type 2 switch, then the instruction indicators "pass-on not possible" are examined.
- NOTE 2 – Examples of where "pass-on" might not be possible are: At AAL type 2 endpoints, or in AAL type 2 switches in inter-operator situations, where "pass-on" might depend on bilateral agreements.
- e) For the case of an unrecognized parameter, it is possible for the instruction to require that either the unrecognized parameter or the whole message is discarded. This provides for the case where the sending node determines that it is not acceptable for the message to continue being processed without this parameter.

### 8.1.2 Procedures for the handling of the unrecognized messages or parameters

If the unrecognized signalling information is received, an ERROR.indication primitive with an appropriate cause (described in the following subclauses) is sent to layer management, except when the action taken is to pass on the message or parameter transparently.

A confusion message must not be issued in response to the following messages:

- |                   |                   |                   |
|-------------------|-------------------|-------------------|
| • Confusion       | • Block request   | • Block confirm   |
| • Release request | • Unblock request | • Unblock confirm |
| • Release confirm | • Reset request   | • Reset confirm   |

Any unrecognized parameters received in the following messages are discarded:

- |                   |                 |                   |
|-------------------|-----------------|-------------------|
| • Confusion       | • Block confirm | • Unblock confirm |
| • Release confirm | • Reset confirm |                   |

#### 8.1.2.1 Unrecognized messages

Depending on the instructions received in the message compatibility field, a node receiving an unrecognized message will either:

- a) transfer the message transparently;
- b) discard the message;
- c) discard the message and send notification; or
- d) release the connection.

The release request in case d) and the confusion message in case c) shall include the cause "Message type non-existent or not implemented", followed by a diagnostic field containing only the message identifier.

#### 8.1.2.2 Unrecognized parameters

Unexpected parameters (a parameter in the "wrong" message) are handled like unrecognized parameters.

Depending on the instructions received in the parameter compatibility information field, a node receiving an unrecognized parameter will either:

- a) transfer the parameter transparently;
- b) discard the parameter;

- c) discard the parameter and send notification;
- d) discard the message;
- e) discard the message and send notification; or
- f) release the connection.

In case c), the confusion message shall include the cause "Information element/parameter non-existent or not implemented" followed by a diagnostic field containing the message identifier and containing pairs of parameter identifier and field number for each unrecognized parameter; the field number in each pair is set to "zero".

In case e), the confusion message shall include the cause "Message with unrecognized parameter, discarded", followed by a diagnostic field containing the message identifier and a parameter identifier (of the first detected unrecognized parameter which caused the message to be discarded) and a field number set to "zero". A confusion message may refer to multiple unrecognized parameters.

A node receiving a message including multiple unrecognized parameters shall process the different instruction indicators, associated with those parameters, according to the following order:

- 1) release the connection;
- 2) discard the message and send notification;
- 3) discard the message.

A release request message shall include the cause "Information element/parameter non-existent or not implemented" followed by a diagnostic field containing the message identifier, the parameter identifier (of the first detected unrecognized parameter which caused the connection to be released), and a field number set to "zero".

If a release request message is received containing an unrecognized parameter, depending on the instructions received in the parameter compatibility field the node will either:

- transfer the parameter transparently;
- discard the parameter; or
- discard the parameter and send a cause "Information element/parameter non-existent or not implemented", in the release confirm message; the diagnostic field contains the message identifier and one or more pairs of parameter identifier and field number indicating all parameters that match the cause value; the field number of all pairs contains the null value.

If a block request message is received containing an unrecognized parameter, depending on the instructions received in the parameter compatibility field the node will either:

- discard the parameter; or
- discard the parameter and send a cause "Information element/parameter non-existent or not implemented", in the block confirm message; the diagnostic field contains the message identifier and one or more pairs of parameter identifier and field number indicating all parameters that match the cause value; the field number of all pairs contains the null value.

If an unblock request message is received containing an unrecognized parameter, depending on the instructions received in the parameter compatibility field the node will either:

- discard the parameter; or
- discard the parameter and send a cause "Information element/parameter non-existent or not implemented", in the unblock confirm message; the diagnostic field contains the message identifier and one or more pairs of parameter identifier and field number indicating all parameters that match the cause value; the field number of all pairs contains the null value.

If a reset request message is received containing an unrecognized parameter, depending on the instructions received in the parameter compatibility field the node will either:

- discard the parameter; or
- discard the parameter and send a cause "Information element/parameter non-existent or not implemented", in the reset confirm message; the diagnostic field contains the message identifier and one or more pairs of parameter identifier and field number indicating all parameters that match the cause value; the field number of all pairs contains the null value.

### **8.1.2.3 Unrecognized fields**

There exists no specific compatibility information for each field. For all fields contained in a parameter, the compatibility information of the parameter applies.

Any value in a subfield that is marked as "spare", "reserved" or "national use" is regarded as unrecognized and the procedures as stated for unrecognized parameters apply except that the field number is coded in the diagnostics field.

### **8.1.3 Procedures for the handling of responses indicating unrecognized information has been sent**

Action taken on receipt of responses indicating unrecognized information has been sent at an originating or terminating AAL type 2 node will depend on the connection state and the affected service.

The definition of any procedure that is outside the basic connection setup protocol, as defined in this ITU-T Recommendation, should include procedures for handling responses that indicate that another node has received, but not recognized, information belonging to that procedure. The procedure receiving this response should take the appropriate actions.

The default action taken on receipt of a confusion message is to discard the message without disrupting normal connection processing.

## **8.2 Nodal functions**

### **8.2.1 Nodal functions for AAL type 2 nodes with served user interaction**

#### **8.2.1.1 Connection control**

##### **8.2.1.1.1 Successful connection set up**

###### **8.2.1.1.1.1 Actions at the originating AAL type 2 endpoint**

When the nodal function receives an ESTABLISH.request primitive from the AAL type 2 served user, it analyses the routing information and selects a route with sufficient AAL type 2 path resources to the succeeding AAL type 2 node. It then selects an AAL type 2 path from within that route which is able to accommodate the new connection.

Routing typically is based on:

- addressing information;
- the test connection indicator;
- link information (link characteristics); and
- other information (such as SCS information).

AAL type 2 node internal resources are allocated to establish an AAL type 2 node internal path for the new connection from the originating AAL type 2 served user to the outgoing AAL type 2 path.

On the selected outgoing AAL type 2 path, the CID and other resources (e.g. indicated by link characteristic or SSCS information) are allocated for the outgoing AAL type 2 link.

An outgoing protocol entity instance is invoked and the following parameters are passed to it: the AAL type 2 service endpoint address, the AAL type 2 path identifier, and a CID value. The nodal function shall pass the following parameters to the outgoing protocol entity instance only if they were conveyed by the originating AAL type 2 served user: the link characteristics, the SSCS information, the served user generated reference, the served user transport, and the test connection indicator.

NOTE – Through-connection of the transmission path at AAL type 2 endpoints is not specified by this ITU-T Recommendation. It may be controlled by the AAL type 2 served user.

After receiving an indication of the successful AAL type 2 connection setup from the outgoing protocol entity instance, an ESTABLISH.confirm primitive is sent to the AAL type 2 served user.

#### **8.2.1.1.2 Actions at the destination AAL type 2 endpoint**

Upon receiving an indication from an incoming protocol entity instance requesting a new connection, the nodal function checks the availability of the CID value and other resources, e.g. indicated by link characteristic or SSCS information, in the incoming AAL type 2 path.

If the test connection indicator parameter is present, a "locally blocked" or "remotely blocked" AAL type 2 path shall be acceptable for the incoming connection.

If the CID and the other resources are available for the new connection, they are allocated to the new connection and then the AAL type 2 service endpoint address is examined. The nodal function determines that the destination AAL type 2 service endpoint has been reached.

AAL type 2 node internal resources are allocated to establish an AAL type 2 node internal path for the new connection from the incoming AAL type 2 path to the destination AAL type 2 served user.

The nodal function acknowledges the successful AAL type 2 connection establishment towards the incoming protocol entity instance.

An ESTABLISH.indication primitive is sent to the AAL type 2 served user to inform it of the successfully established new connection. The nodal function shall pass the following parameters to the destination AAL type 2 served user only if they were conveyed by the incoming protocol entity instance: the SSCS information, the served user transport, the served user generated reference, and the test connection indicator.

NOTE – Through-connection of the transmission path at AAL type 2 endpoints is not specified by this ITU-T Recommendation. It may be controlled by the AAL type 2 served user.

#### **8.2.1.1.2 Unsuccessful/abnormal connection set up**

##### **8.2.1.1.2.1 Actions at the originating AAL type 2 endpoint**

If the AAL type 2 path selection or the allocation of a CID and other resources for the outgoing AAL type 2 link described in 8.2.1.1.1 fails, a RELEASE.confirm primitive is returned to the AAL type 2 served user with one of the following causes:

- "Unallocated (unassigned) number";
- "No route to destination";
- "No circuit/channel available";
- "Resource unavailable, unspecified";
- "Network out of order"; or
- "Temporary failure".

If AAL type 2 node internal resources are not available to establish an AAL type 2 node internal path, a RELEASE.confirm primitive is sent to the AAL type 2 served user with the cause "Switching equipment congestion".

Upon receiving a negative acknowledgement for the connection setup request from the outgoing protocol entity instance, all the resources associated with this AAL type 2 link are released and made available for new traffic. The association to the outgoing protocol entity instance is released. Features that enable a further connection attempt, involving the selection of a different AAL type 2 path within the same route or of an alternative route, may be implemented. If no further connection attempt is made, the AAL type 2 node internal resources are released and a RELEASE.confirm primitive is sent to the AAL type 2 served user with the cause received from the outgoing protocol entity instance.

Upon receiving an indication from the outgoing protocol entity instance that a timer has expired, the association to the outgoing protocol entity instance is released and a reset procedure is started [see 8.2.1.2.1.1 case 3 a)]. The AAL type 2 node internal resources are released. A RELEASE.confirm primitive is sent to the AAL type 2 served user with the cause received from the outgoing protocol entity instance, i.e. "Recovery on timer expiry".

#### **8.2.1.1.2.2 Actions at the destination AAL type 2 endpoint**

If resources on the incoming AAL type 2 path are not available, the nodal function requests the incoming protocol entity instance to reject the AAL type 2 connection with one of the following causes as applicable:

- "Resource unavailable, unspecified"; or
- "Requested circuit/channel not available".

If the nodal function is aware that the SSCS parameters are not supported, it requests the incoming protocol entity instance to reject the AAL type 2 connection with the cause "AAL parameters cannot be supported".

The association between the nodal function entity and its incoming protocol entity instance is released.

If an AAL type 2 path is "locally blocked" and an indication from an incoming protocol entity instance of the request for a new connection other than a test connection is received, the following actions are taken:

- 1) The indication of the request for a new connection establishment is ignored and the incoming protocol entity instance is instructed to terminate and enter state "Idle"; the association with the incoming protocol entity instance is released and an ERROR.indication primitive with the CEID and the cause "Temporary failure" is sent to layer management.
- 2) The blocking procedure specified in 8.2.1.2.2.1 case b) is initiated for the AAL type 2 path on which the new connection was requested to be established.

If an AAL type 2 path is "remotely blocked" and an indication from an incoming protocol entity instance of the request for a new connection other than a test connection is received, the following actions are taken:

- i) The AAL type 2 path is set to "remotely unblocked".  
NOTE – This procedure shall not be considered as the normal way to remove the "remotely blocked" condition.
- ii) The incoming connection establishment request is processed normally, i.e. as if the AAL type 2 path was not "remotely blocked" to begin with.

If AAL type 2 node internal resources are not available to establish an AAL type 2 node internal path, a negative acknowledgement for the connection setup request shall be returned to the incoming

protocol entity instance with the cause "Switching equipment congestion". The resources allocated to the incoming AAL type 2 path are released and the association between the incoming protocol entity instance and the nodal function is released.

### **8.2.1.1.3 Normal connection release**

#### **8.2.1.1.3.1 Actions at the AAL type 2 endpoint that originates the release**

When the nodal function at an AAL type 2 endpoint receives a RELEASE.request primitive from the AAL type 2 served user, it requests the protocol entity instance to release the connection. The request carries the cause of the release which shall be "Normal, unspecified" in case of normal connection release or "AAL parameters cannot be supported" if the AAL type 2 served user determines that it cannot support the SSCS parameters.

Upon acknowledgement of the successful connection release from the protocol entity instance, all the resources associated with this AAL type 2 link are released and made available for new traffic, and the AAL type 2 node internal resources are released. The association to the protocol entity instance is released.

#### **8.2.1.1.3.2 Actions at the AAL type 2 endpoint that receives the release**

When the nodal function at an AAL type 2 endpoint receives a request from a protocol entity instance to clear the connection, all the resources associated with this AAL type 2 link are released and made available for new traffic, and the AAL type 2 node internal resources are released. The release is confirmed to the protocol entity instance and a RELEASE.indication primitive with the cause received from the protocol entity instance is sent to the AAL type 2 served user. The association between the nodal function and the protocol entity instance is released.

### **8.2.1.1.4 Abnormal connection release procedures**

When the nodal function at an AAL type 2 endpoint receives an indication from the protocol entity instance that a timer has expired, the association to the protocol entity instance is released and a maintenance protocol entity instance is ordered to start a reset procedure.

## **8.2.1.2 Maintenance control**

### **8.2.1.2.1 Reset**

The reset procedure is invoked under abnormal conditions such as when the current status of the channels is unknown or ambiguous, for example, an AAL type 2 switching system that has suffered memory mutilation will not know the status of channels in one or several AAL type 2 paths. All the affected channels and any associated resources (e.g. bandwidth, etc.) between the two adjacent AAL type 2 nodes shall be released. The resources are made available for new traffic.

The reset procedure covers the following three cases:

- 1) Case 1: Reset all channels used for user plane traffic (see Note) in all AAL type 2 paths associated with a signalling association between two adjacent AAL type 2 nodes.
- 2) Case 2: Reset all channels used for user plane traffic (see Note) in a single AAL type 2 path between two adjacent AAL type 2 nodes represented by an AAL type 2 Path Identifier.
- 3) Case 3: Reset a single channel between two adjacent AAL type 2 nodes.

NOTE – Channels used for user plane traffic refers to channels that are under the control of the AAL type 2 signalling entity. They are identified by CID values "8" ... "255". Other channels are unaffected by the reset procedure.

The reset procedure should be initiated when:

- a) Signalling anomalies are detected by the AAL type 2 signalling entity. The following anomalies are detected by the protocol procedures and are indicated to the nodal function:
  - Timer "Timer\_ERQ" expiry – Action: Reset the single AAL type 2 channel associated with the outgoing protocol entity instance.
  - Timer "Timer\_REL" expiry – Action: Reset the single AAL type 2 channel associated with the incoming or outgoing protocol entity instance.
- b) Maintenance action is required to recover from abnormal conditions such as loss or ambiguity of association information (e.g. caused by memory mutilation) between SAID(s) and the channel status of either a specific channel in a specific AAL type 2 path, all channels in a specific AAL type 2 path, or all AAL type 2 paths associated with a signalling association between two AAL type 2 signalling nodes. – Action: Reset a single AAL type 2 channel in a specific AAL type 2 path, all AAL type 2 channels in a single AAL type 2 path or all AAL type 2 channels in all AAL type 2 paths associated with a signalling association between two adjacent AAL type 2 nodes respectively.

#### **8.2.1.2.1.1 Actions at reset initiating AAL type 2 node**

Reset procedures can be initiated to reset:

- 1) all AAL type 2 paths associated with a signalling association between two adjacent AAL type 2 nodes;
- 2) a specific AAL type 2 path;
- 3) a single AAL type 2 channel.

For case 1), layer management passes a RESET.request together with the indication "All AAL type 2 paths associated with a signalling association" to the nodal function which in turn invokes a maintenance protocol entity and passes a request for reset to that entity together with an indication that all AAL type 2 paths associated with a signalling association must be reset.

For case 2), layer management passes a RESET.request together with the AAL type 2 path identifier to the nodal function which in turn invokes a maintenance protocol entity and passes a request for reset together with the AAL type 2 path identity.

For case 3), there are two possible subcases, one due to timer expiry and the other due to layer management action:

- a) After the expiry of Timer\_ERQ or Timer\_REL, the nodal function invokes a maintenance protocol entity by passing a request for a reset together with the identity of the AAL type 2 path and the channel.
- b) Layer management invokes the nodal function which in turn invokes a maintenance protocol entity by passing a request for a reset together with the identity of the AAL type 2 path and the channel.

In cases 1), 2) and 3 b), the nodal function requests any affected incoming or outgoing protocol entity instances to terminate and enter state "Idle". The associations to the incoming or outgoing protocol entity instances are released. The affected AAL type 2 served users are informed with a RELEASE.indication primitive with the cause "Temporary failure".

Upon receiving a reset confirmation from the maintenance protocol entity instance, the nodal function will make the affected resources available for new connections, and the AAL type 2 node internal resources are released. The association to the maintenance protocol entity instance is released. In case 3 a), a RESET.indication primitive with a CEID parameter is sent to layer management; in all other cases, a RESET.confirm primitive is sent to the layer management.

NOTE – The local blocking states are not affected.

For cases 1) and 2), the remote blocking state for the affected path(s) is set to "remotely unblocked".

#### **8.2.1.2.1.2 Actions at reset responding node**

Upon receiving a reset indication from the maintenance protocol entity, the nodal function analyses the received information to determine which AAL type 2 channels are to be reset.

- 1) If an indication that all AAL type 2 paths associated with a signalling association must be reset is received, then all AAL type 2 channels associated with a signalling association between the two adjacent AAL type 2 nodes are reset.
- 2) If an indication that all the channels within the identified AAL type 2 path must be reset is received, all AAL type 2 channels within that path are reset.
- 3) If an indication that a specific channel within an AAL type 2 path must be reset is received, only that channel is reset.

In cases 1) and 2), for "locally blocked" AAL type 2 paths, blocking procedures [refer to 8.2.1.2.2.1 case b)] are initiated prior to the sending of the reset confirmation.

If resources have been assigned to any of the channels that are reset, the nodal functions make the affected resources available for new connections, and the AAL type 2 node internal resources are released. It also returns a reset confirmation to the maintenance protocol entity. The association between the nodal function and the maintenance protocol entity instance is released. The nodal function informs layer management about the receipt of the reset request by sending a RESET.indication primitive with the same CEID parameter as has been received in the RES message (reset request).

The nodal function also requests the affected incoming or outgoing protocol entity instances (if any) to terminate and enter state "Idle". The associations to the incoming or outgoing protocol entity instances are released. The affected AAL type 2 served user is informed with a RELEASE.indication primitive with the cause "Temporary failure".

#### **8.2.1.2.1.3 Abnormal reset procedures**

Upon receiving a negative acknowledgement with a cause "Switching equipment congestion" from the maintenance protocol entity instance, the nodal function repeats the request for the reset.

Upon receiving a negative acknowledgement with another cause from the maintenance protocol entity instance, an ERROR.indication primitive including the cause received from the maintenance protocol entity instance and the CEID parameter is sent to layer management.

Upon receiving a STOP-RESET.request primitive with adjacent AAL type 2 node identifier and connection element identifier parameters from layer management, the nodal function will make the affected resources available for new connections. The nodal function requests the maintenance protocol entity instance to terminate and enter state "Idle". The association between the nodal function and the maintenance protocol entity instance is released.

#### **8.2.1.2.2 Blocking and unblocking of AAL type 2 paths**

The AAL type 2 path blocking procedure is provided to prevent an AAL type 2 path from being selected for carrying new connections other than test connections. Existing connections on the AAL type 2 path are not affected.

Blocking can be initiated by either signalling endpoint that controls an AAL type 2 path. When blocking is invoked, both ends of the AAL type 2 path are put into a blocked state. A blocked AAL type 2 path cannot be selected for new, non-test traffic by either AAL type 2 node.

An acknowledgment is required for each blocking and unblocking request. The acknowledgment is not sent until the appropriate action – blocking or unblocking – has been taken.

Unblocking can only be initiated by the same AAL type 2 node which initiated the blocking procedures. It is performed by sending an unblocking request. At either end, the blocked state is removed and the AAL type 2 path is made available again for all new connections.



An AAL type 2 path is considered "unblocked" if it is both "locally unblocked" and "remotely unblocked".

#### **8.2.1.2.2.1 Initiating blocking**

Blocking can be initiated either by layer management, by the reset procedure, or by the connection establishment procedure.

Case a): When a BLOCK.request primitive is received from layer management for an AAL type 2 path that is currently "locally unblocked", the AAL type 2 path becomes "locally blocked". The AAL type 2 path is made unavailable for the selection to accommodate new non-test connections.

Case b): A request for blocking can also be received from the reset procedure (see 8.2.1.2.1.2) or from establishment procedure (see 8.2.1.1.2.2).

In both cases, a maintenance protocol entity is then invoked and the AAL type 2 path identifier and a request for blocking is passed to it.

When confirmation of the blocking is received from the maintenance protocol entity, a BLOCK.confirm primitive is sent to layer management and the association to the maintenance protocol entity instance is released.

#### **8.2.1.2.2.2 Initiating unblocking**

When an UNBLOCK.request is received from layer management for an AAL type 2 path that is currently "locally blocked", a maintenance protocol entity is invoked and the AAL type 2 path identifier and a request for unblocking is passed to it.

When confirmation of the unblocking is received from the maintenance protocol entity, the AAL type 2 path becomes "locally unblocked" and the AAL type 2 path is made available again to accommodate new connections (if it is not "remotely blocked"). An UNBLOCK.confirm is sent to layer management and the association to the maintenance protocol entity instance is released.

#### **8.2.1.2.2.3 Receiving blocking**

When an indication of blocking is received from a maintenance protocol entity for an AAL type 2 path that is currently "remotely unblocked", the AAL type 2 path becomes "remotely blocked" and the AAL type 2 path is made unavailable to accommodate new non-test connections. A response is then sent to the maintenance protocol entity indicating the acceptance of the blocking and the association to the maintenance protocol entity instance is released.

#### **8.2.1.2.2.4 Receiving unblocking**

When an indication of unblocking is received from a maintenance protocol entity for an AAL type 2 path that is currently "remotely blocked", the AAL type 2 path becomes "remotely unblocked" and the AAL type 2 path is made available to accommodate new connections (if it is not "locally blocked"). A response is then issued to the maintenance protocol entity indicating the acceptance of the unblocking and the association to the maintenance protocol entity instance is released.

#### **8.2.1.2.2.5 Abnormal blocking and unblocking procedures**

- a) If an indication for blocking is received from a maintenance protocol entity for an AAL type 2 path which is already "remotely blocked", a blocking confirmation is sent to the maintenance protocol entity and the association to the maintenance protocol entity instance is released. No further actions are performed.
- b) If an indication for unblocking is received from a maintenance protocol entity for an AAL type 2 path which is "remotely unblocked", an unblocking confirmation is sent to the maintenance protocol entity and the association to the maintenance protocol entity instance is released. No further actions are performed.

- c) If a BLOCK.request primitive is received from layer management for an AAL type 2 path that is already "locally blocked", the procedure in 8.2.1.2.2.1 is performed.
- d) If an UNBLOCK.request primitive is received from layer management for an AAL type 2 path that is already "locally unblocked", the procedure in 8.2.1.2.2.2 is performed.
- e) If an ERROR.indication is received from the maintenance protocol entity, a BLOCK.confirm primitive or an UNBLOCK.confirm primitive with the cause received from the maintenance protocol entity instance is sent to layer management. The association to the maintenance protocol entity is released.

#### **8.2.1.2.3 Transmission fault handling**

Fully digital transmission systems are provided between all AAL type 2 nodes. They have some inherent fault indication features that give an indication to the switching system when faults are detected on the transmission path level and/or on the virtual path level. On receipt of a fault indication from layer management, the routing function in the switching system inhibits selection of the AAL type 2 path (or paths) concerned for the period that the fault condition persists. No special action is required for active connections.

#### **8.2.1.2.4 AAL type 2 signalling entity signalling congestion control**

On receipt of a CONGESTION.indication primitive from the generic signalling transport service, the AAL type 2 signalling entity should alter traffic load (e.g. connection attempts) toward the affected AAL type 2 nodes to align with the congestion level indicated by the primitive.

#### **8.2.1.2.5 Adjacent AAL type 2 node availability**

On receipt of an OUT-OF-SERVICE.indication primitive from the generic signalling transport service, the following action is required:

- All AAL type 2 paths to the affected adjacent AAL type 2 node are marked as unavailable in the routing function prohibiting new (test or user) connection establishments to that AAL type 2 node. Already established connections need not be released even though signalling messages cannot be sent to the affected node.

On receipt of an IN-SERVICE.indication primitive from the generic signalling transport service, the following action is required:

- All AAL type 2 paths to the affected adjacent AAL type 2 node, that are both "locally unblocked" and "remotely unblocked", are again marked available in the routing function and any of the unallocated channels can be used for connections immediately consistent with the congestion level in the primitive. Reset procedures that may have started during the period of signalling isolation continue and ensure that affected channels are returned to state "Idle". Connections that are in state "Established" are unaffected.

#### **8.2.1.3 Error handling**

A message received indicating an AAL type 2 path or CID value that is not controlled by the nodal function shall be discarded and layer management shall be informed with an ERROR.indication primitive with a cause "Invalid information element contents".

If a parameter is present more than once in a message where this parameter is allowed only once, only the first parameter shall be processed; all subsequent instances of the parameter shall be ignored.

When receiving a message which does not contain the minimum set of parameters required to continue processing, a protocol error is reported to layer management with an ERROR.indication primitive with a cause "Mandatory information element is missing" and the message is discarded.

## **8.2.2 Nodal functions for AAL type 2 nodes without served user interaction**

### **8.2.2.1 Connection control**

#### **8.2.2.1.1 Successful connection set up**

Upon receiving notification from an incoming protocol entity instance requesting a new connection, the nodal function checks the availability of the CID value and other resources, e.g. indicated by link characteristic or SSCS information, in the incoming AAL type 2 path.

If the test connection indicator parameter is present, "locally blocked" or "remotely blocked" AAL type 2 paths shall be acceptable for the incoming connection.

If the CID and the other resources are available for the incoming AAL type 2 link, the resources are allocated to the new connection.

The AAL type 2 service endpoint address is then examined. The nodal function determines that the AAL type 2 connection needs to be routed further to reach the destination AAL type 2 service endpoint and analyses the routing information and selects a route with sufficient AAL type 2 path resources to the next AAL type 2 node. It then selects an AAL type 2 path from within the route which is able to accommodate the new connection.

Routing typically is based on:

- addressing information;
- the test connection indicator;
- link information (link characteristics); and
- other information (such as SSCS information).

AAL type 2 node internal resources are allocated to establish an AAL type 2 node internal path for the new connection from the incoming AAL type 2 path to the outgoing AAL type 2 path.

On the selected outgoing AAL type 2 path, the CID and other resources (e.g. indicated by link characteristic or SSCS information) are allocated for the outgoing AAL type 2 link.

An outgoing protocol entity instance is invoked and the following parameters are passed to it: the AAL type 2 service endpoint address, the CID value, and the identifier for the outgoing AAL type 2 path. The nodal function shall pass the following parameters to the outgoing protocol entity instance only if they were conveyed by the incoming protocol entity instance: The link characteristics, the SSCS information, the served user generated reference, the served user transport, and the test connection indicator.

Through-connection of the transmission path in both directions will then be completed.

After receiving an indication of the successful AAL type 2 connection setup from the outgoing protocol entity instance, the incoming protocol entity instance is informed of the successful AAL type 2 connection setup.

#### **8.2.2.1.2 Unsuccessful/abnormal connection set up**

If resources on the incoming AAL type 2 path are not available, the nodal function requests the incoming protocol entity instance to reject the connection with one of the following causes as applicable:

- "Resource unavailable, unspecified"; or
- "Requested circuit/channel not available".

The association between the nodal function entity and its incoming protocol entity instance is released.

If an AAL type 2 path is "locally blocked" and an indication from an incoming protocol entity instance of the request for a new connection other than a test connection is received, the following actions are taken:

- 1) The indication of the request for a new connection establishment is ignored and the incoming protocol entity instance is instructed to terminate and enter state "Idle"; the association with the incoming protocol entity instance is released and an ERROR.indication primitive with the CEID and the cause "Temporary failure" is sent to layer management.
- 2) The blocking procedure specified in 8.2.1.2.2.1 case b) is initiated for the AAL type 2 path on which the new connection was requested to have been established.

If an AAL type 2 path is "remotely blocked" and an indication from an incoming protocol entity instance of the request for a new connection other than a test connection is received, the following actions are taken:

- i) The AAL type 2 path is set to "remotely unblocked".  
NOTE – This procedure shall not be considered as the normal way to remove the "remotely blocked" condition.
- ii) The incoming connection establishment request is processed normally, i.e. as if the AAL type 2 path was not "remotely blocked" to begin with.

If AAL type 2 node internal resources are not available to establish an AAL type 2 node internal path, a negative acknowledgement for the connection setup request shall be returned to the incoming protocol entity instance with the cause "Switching equipment congestion". The resources allocated to the incoming AAL type 2 path are released and the association between the incoming protocol entity instance and the nodal function is released.

If the AAL type 2 path selection or the allocation of a CID and other resources for the outgoing AAL type 2 link described in 8.2.2.1.1 fails, a negative acknowledgement for the connection setup request shall be returned to the incoming protocol entity instance with one of the following causes:

- "Unallocated (unassigned) number";
- "No route to destination";
- "No circuit/channel available";
- "Resource unavailable, unspecified";
- "Network out of order"; or
- "Temporary failure".

The resources allocated to the preceding AAL type 2 path are released and the association between the incoming protocol entity instance and the nodal function is released.

Upon receiving a negative acknowledgement from the outgoing protocol entity instance, all resources associated with the outgoing AAL type 2 link are released and made available for new traffic. The association to the outgoing protocol entity instance is released. Features that enable a further connection attempt, involving the selection of a different AAL type 2 path within the same route or of an alternative route may be implemented. If no further connection attempt is made, the AAL type 2 node internal resources are released, the rejection of the connection establishment is forwarded to the incoming protocol entity instance with the cause received from the outgoing protocol entity instance and all the resources associated with the incoming AAL type 2 link are released and made available for new traffic. The association to the incoming protocol entity instance is released.

Upon receiving an indication from the outgoing protocol entity instance that a timer has expired, the association to the outgoing protocol entity instance is released and a reset procedure is started [see 8.2.1.2.1.1 case 3 a)]. The AAL type 2 node internal resources are released. The rejection of the connection establishment is forwarded to the incoming protocol entity instance with the cause

received from the outgoing protocol entity instance (i.e. "Recovery on timer expiry") and all the resources associated with the incoming AAL type 2 link are released and made available for new traffic. The association to the incoming protocol entity instance is released.

### **8.2.2.1.3 Normal connection release**

When the nodal function has received a request from a (first) protocol entity instance to release the connection, an acknowledgement is returned to that protocol entity instance and all the resources associated with the AAL type 2 link being governed by the protocol entity instance are released and made available for new traffic. The association to the protocol entity instance is released.

The AAL type 2 node internal resources are released.

The request to release the connection is forwarded to the companion incoming or outgoing (second) protocol entity instance with the cause received from the first protocol entity instance.

After receiving the acknowledgement of the successful connection release from the second protocol entity instance, all the resources associated with the AAL type 2 link being governed by the protocol entity instance are released and made available for new traffic. The association to the protocol entity instance is released.

### **8.2.2.1.4 Abnormal connection release procedures**

#### **8.2.2.1.4.1 Actions at the AAL type 2 switch that initiates the release**

When the nodal function receives an indication from the second protocol entity instance that a timer has expired, the association to that protocol entity instance is released and a reset procedure is started [see 8.2.2.2.1.1, case 3 a)].

### **8.2.2.2 Maintenance control**

#### **8.2.2.2.1 Reset**

Refer to 8.2.1.2.1.

##### **8.2.2.2.1.1 Actions at reset initiating node**

Reset procedures can be initiated to reset:

- 1) all AAL type 2 paths between two adjacent AAL type 2 nodes associated with a signalling association;
- 2) a specific AAL type 2 path;
- 3) a single AAL type 2 channel.

For case 1), layer management passes a RESET.request together with the indication "All AAL type 2 paths associated with a signalling association" to the nodal function which in turn invokes a maintenance protocol entity and passes the request for reset to that entity together with an indication that all AAL type 2 paths associated with a signalling association must be reset.

For case 2), layer management passes a RESET.request together with the AAL type 2 path identifier to the nodal function which in turn invokes a maintenance protocol entity and passes a request for reset to that entity together with the identity of the AAL type 2 path.

For case 3), there are two possible subcases, one due to timer expiry and the other due to layer management action:

- a) After the expiry of Timer\_ERQ or Timer\_REL, the nodal function invokes a maintenance protocol entity by passing a request for a reset together with the identity of the AAL type 2 path and the channel.

- b) Layer management invokes the nodal function which in turn invokes a maintenance protocol entity by passing a request for a reset together with the identity of the AAL type 2 path and the channel.

In cases 1), 2), and 3 b), the nodal function requests any affected incoming or outgoing protocol entity instances to terminate and enter state "Idle". The associations to the incoming or outgoing protocol entity instances are released. The affected AAL type 2 served users are informed with a RELEASE.indication primitive with the cause "Temporary failure".

Upon receiving a reset confirmation from the maintenance protocol entity instance, the nodal function will make the affected resources available for new connections, and the AAL type 2 node internal resources are released. The association to the maintenance protocol entity instance is released. In case 3 a), a RESET.indication primitive with a CEID parameter is sent to layer management; in all other cases, a RESET.confirm primitive is sent to the layer management.

NOTE – The local blocking states are not affected.

For cases 1) and 2), the remote blocking state for the affected path(s) is set to "remotely unblocked".

#### **8.2.2.2.1.2 Actions at reset responding node**

Upon receiving a reset indication from the maintenance protocol entity, the nodal function analyses the received information to determine which AAL type 2 channels are to be reset.

- 1) If an indication that all AAL type 2 paths associated with a signalling association must be reset is received, then all AAL type 2 channels associated with a signalling association between the two adjacent AAL type 2 nodes are reset.
- 2) If an indication that all the channels within the identified AAL type 2 path must be reset is received, all AAL type 2 channels within that path are reset.
- 3) If an indication that a specific channel within an AAL type 2 path must be reset is received, only that channel is reset.

In cases 1) and 2), for "locally blocked" AAL type 2 paths, blocking procedures [refer to 8.2.1.2.2 case b)] are initiated prior to the sending of the reset confirmation.

If resources have been assigned to one of the channels that are reset, the nodal functions make the affected resources available for new connections, and the AAL type 2 node internal resources are released. It also returns a reset confirmation to the maintenance protocol entity. The association between the nodal function and the maintenance protocol entity instance is released. The nodal function informs layer management about the receipt of the reset request by sending a RESET.indication primitive with the same CEID parameter as has been received in the RES message (Reset Request).

The nodal function also requests the affected incoming or outgoing protocol entity instances (if any) to terminate and enter state "Idle". The associations to the incoming or outgoing protocol entity instances are released. The affected AAL type 2 served user is informed with a RELEASE.indication primitive with the cause "Temporary failure".

#### **8.2.2.2.1.3 Abnormal reset procedures**

Refer to 8.2.1.2.1.3.

#### **8.2.2.2.2 Blocking and unblocking of AAL type 2 path**

Refer to 8.2.1.2.2.

#### **8.2.2.2.3 Transmission fault handling**

Refer to 8.2.1.2.3.

#### **8.2.2.2.4 AAL type 2 signalling entity signalling congestion control**

Refer to 8.2.1.2.4.

#### **8.2.2.2.5 Adjacent AAL type 2 node availability**

Refer to 8.2.1.2.5.

#### **8.2.2.3 Error handling**

Refer to 8.2.1.3.

### **8.3 Protocol entity**

The following rules relating to Signalling Association Identifiers (SAIDs) apply:

- The AAL type 2 signalling system that does not issue the value of such a field is not allowed to modify it but shall use it in the destination signalling association identifier field in the header of a messages directed towards the issuer.
- When a message is received at the generic signalling transport service access point (GST-SAP), the destination signalling association identifier field of the incoming message is used to distribute the messages to the appropriate protocol entity instance.
- If a received message contains a destination signalling association identifier set to the "unknown" value and an originating signalling association identifier, a new incoming protocol entity instance or a new maintenance protocol entity instance is created and marked with a newly allocated signalling association identifier. The originating signalling association identifier parameter in the first response message issued by the new protocol entity instance will inform the peer protocol entity instance of the newly allocated signalling association identifier.
- If a new protocol entity instance is created by the nodal function, a signalling association identifier is allocated for it and the signalling association identifier is conveyed to the peer AAL type 2 signalling entity as the originating signalling association identifier parameter in the first message issued by the new protocol entity instance. The DSAID field in the header in this message is set to "unknown".
- If a protocol entity instance sends a message to its peer, the message includes the signalling association identifier of the peer in the destination signalling association identifier field.
- If a new maintenance protocol entity instance is created as a result of an incoming maintenance message, no signalling association identifier is allocated for it and no originating signalling association identifier parameter is conveyed to the peer AAL type 2 signalling entity in the first (and only) message issued by the new maintenance protocol entity instance.

The sequence control parameter of the TRANSFER.request primitive across the GST-SAP is allocated on a cyclic basis per protocol entity instance.

Example message sequences are shown in Appendix I where usage of originating and destination signalling association identifiers is also described.

All messages are sent in a TRANSFER.request primitive. All messages are received in a TRANSFER.indication primitive.

#### **8.3.1 General protocol error handling**

If a message is received that is too short to contain a complete message (i.e. less than 6 octets), it shall be ignored.

The message is discarded and layer management informed with an ERROR.indication in the following cases:

- If the parameter length points beyond the end of the message – cause "Message with unrecognized parameter, discarded" is indicated.
- If the field length points beyond the end of the parameter – cause "Message with unrecognized parameter, discarded" is indicated.
- If an unrecognized message containing a destination signalling association identifier set to the "unknown" value – cause "Message type non-existent or not implemented" is indicated.  
NOTE – If an unrecognized message containing a valid destination signalling association identifier is received, the message is conveyed to the addressed protocol entity instance as if it were a recognized message.
- If the message contains a destination signalling association identifier with an illegal/invalid value – cause "Invalid information element contents" is indicated.
- If the message is considered unexpected by the signalling procedures – cause "Invalid message, unspecified" is indicated.
- If a mandatory originating signalling association identifier parameter is not present – cause "Mandatory information element is missing" is indicated.
- If the originating signalling association identifier field is set to "zero" – cause "Invalid information element contents" is indicated.

## **8.3.2 Outgoing protocol procedures**

### **8.3.2.1 Successful connection setup**

When an outgoing protocol entity instance in state "Idle" receives a request for a new connection from the nodal function, a free Signalling Association Identifier (SAID) is allocated for the outgoing protocol entity instance.

Upon allocating an SAID, an ERQ message (establish request) is sent to the adjacent AAL type 2 node, entering state "Outgoing establishment pending" and starting Timer\_ERQ. The ERQ message contains a destination signalling association identifier field set to the "unknown" value and an originating signalling association identifier parameter in addition to those parameters given by the nodal function.

If an ECF (establish confirm) message is received in state "Outgoing establishment pending", Timer\_ERQ is stopped, the nodal function is informed and state "Established" is entered.

### **8.3.2.2 Unsuccessful connection setup**

If the SAID allocation specified in 8.3.2.1 fails, the nodal function is informed by passing the cause "Resource unavailable, unspecified".

If Timer\_ERQ expires, the nodal function is informed by passing the cause "Recovery on timer expiry". The SAID allocated to this particular outgoing protocol entity instance is released and made available for new traffic and state "Idle" is entered.

If an RLC (release confirm) message is received in state "Outgoing establishment pending", the nodal function is informed about the rejection of the establishment request (including the cause from the RLC message). Timer\_ERQ is stopped. The SAID allocated to this particular outgoing protocol entity instance is released and made available for new traffic and state "Idle" is entered.

### **8.3.2.3 Normal connection release**

In state "Established", an REL message (release request) containing a cause parameter can be received. The protocol entity instance informs the nodal function with the received cause and enters



state "Incoming Release Pending". After the nodal function acknowledges the release, an RLC message (release confirm) is sent to the peer protocol entity instance (without a cause parameter). The SAID allocated to the protocol entity instance is released and made available for new traffic and state "Idle" is entered.

In state "Established", the nodal function can request the release of the connection. In this case an REL message is sent, Timer\_REL is started and state "Outgoing release pending" is entered. The REL message contains the cause received from the nodal function.

If an RLC message is received, Timer\_REL is stopped and the nodal function is informed. The SAID allocated to the protocol entity instance is released and made available for new traffic and state "Idle" is entered.

#### **8.3.2.4 Release request collision**

If an REL message (release request) is received in state "Outgoing Release Pending", an RLC message (release confirm) is immediately sent back to the peer protocol entity instance and state "Release collision" is entered.

When an RLC message is received in state "Release collision", Timer\_REL is stopped and the nodal function is informed. The SAID allocated to the protocol procedure entity instance is released and made available for new traffic and state "Idle" is entered.

#### **8.3.2.5 Abnormal connection release procedures**

If Timer\_REL expires in states "Outgoing release pending" or "Release collision" the nodal function is informed with a cause "Recovery on timer expiry". The SAID allocated to the protocol entity instance is released and made available for new traffic and state "Idle" is entered.

If in any state except state "Idle" a request to terminate an outgoing protocol procedure entity instance from the nodal function is received, all timers are stopped. The SAID allocated to the protocol entity instance is released and made available for new traffic and state "Idle" is entered.

#### **8.3.2.6 Unrecognized information procedures**

When an unrecognized message, parameter, or subfield value is received, the message, the parameter, or the subfield value respectively is conveyed to the nodal function for appropriate action.

When a request to pass on an unrecognized message, parameter, or subfield value is received from the nodal function, the unrecognized message is passed on and an unrecognized parameter or subfield value is sent in the recognized message being constructed respectively.

When a request to send a CFN message (confusion) is received from the nodal function in any state except "Idle" and "Outgoing establishment pending", the message is sent. The CFN message (confusion) contains a cause parameter provided by the nodal function.

When a request to send a cause parameter in an RLC message (release confirm) as a response to an unrecognized parameter or subfield value received in an REL message (release request) is received from the nodal function in any State except "Incoming release pending" and "Outgoing release pending", the cause parameter provided by the nodal function is sent in the RLC message (release confirm).

When a CFN message (confusion) is received in any state except "Idle", the message is conveyed to the nodal function for appropriate action.

When a cause parameter is received in an RLC message (release confirm) in state "Outgoing release pending", the cause parameter is conveyed to the nodal function for appropriate action.

### 8.3.2.7 State transition model

#### 8.3.2.7.1 State transition

The state transition diagram for the outgoing protocol procedure is shown in Figure 8-1.

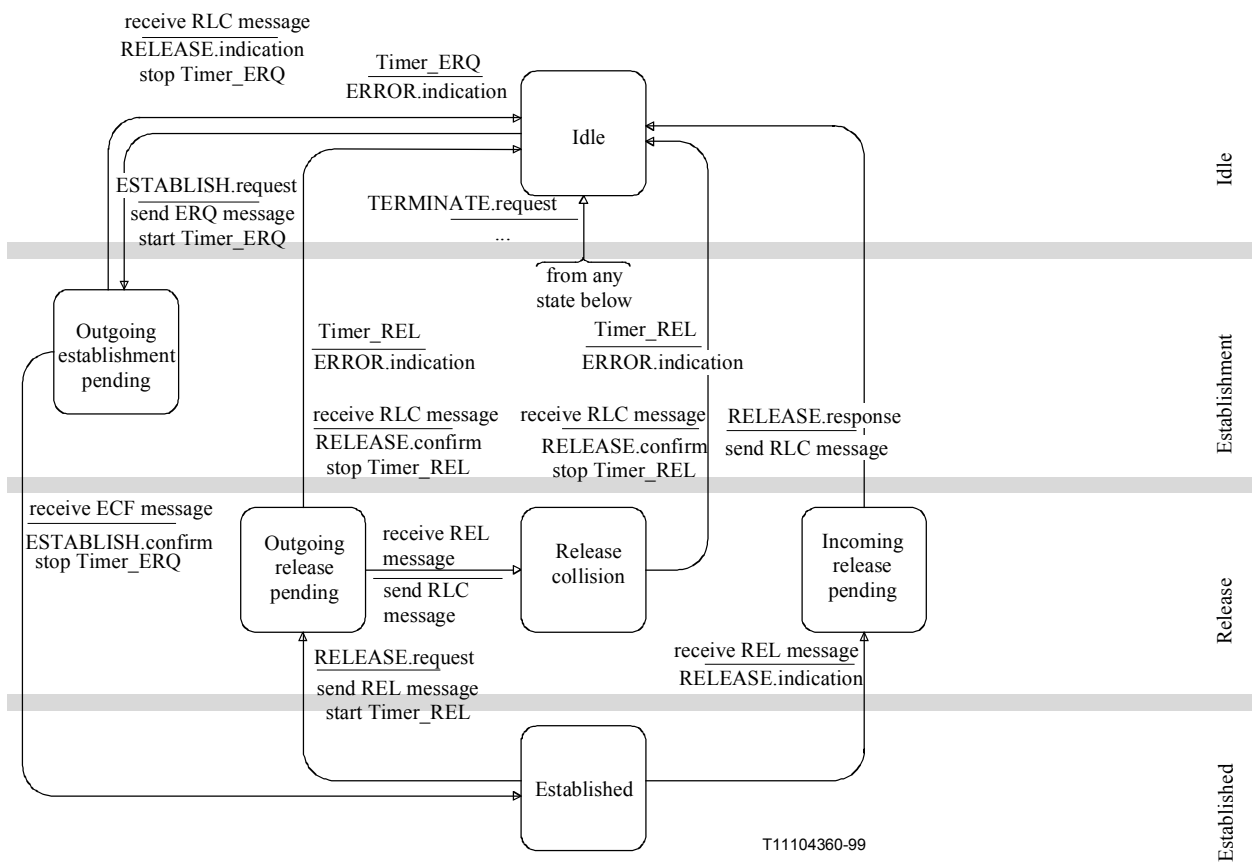

**Figure 8-1/Q.2630.1 – State transition diagram for the outgoing protocol procedure**

#### 8.3.2.7.2 SDL diagrams for the outgoing protocol procedures

The SDL diagram for the outgoing protocol procedure is shown in Figure 8-2 (parts 1 to 4).

The SDL diagrams contained in Figure 8-2 (parts 1 to 4) are an introduction to the procedures described in detail in 8.3.2.

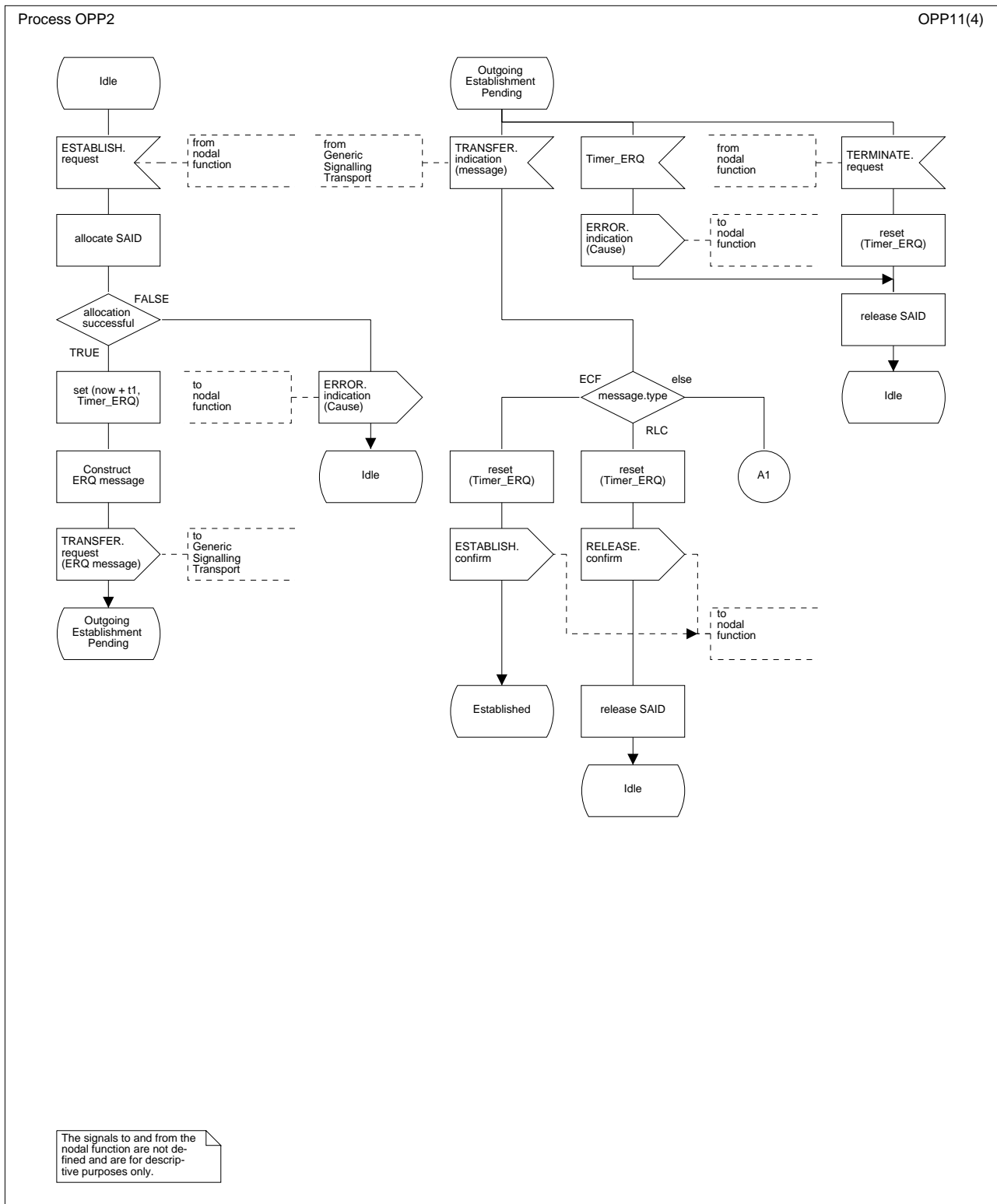

Figure 8-2/Q.2630.1 – SDL diagram for the outgoing protocol procedure (part 1 of 4)

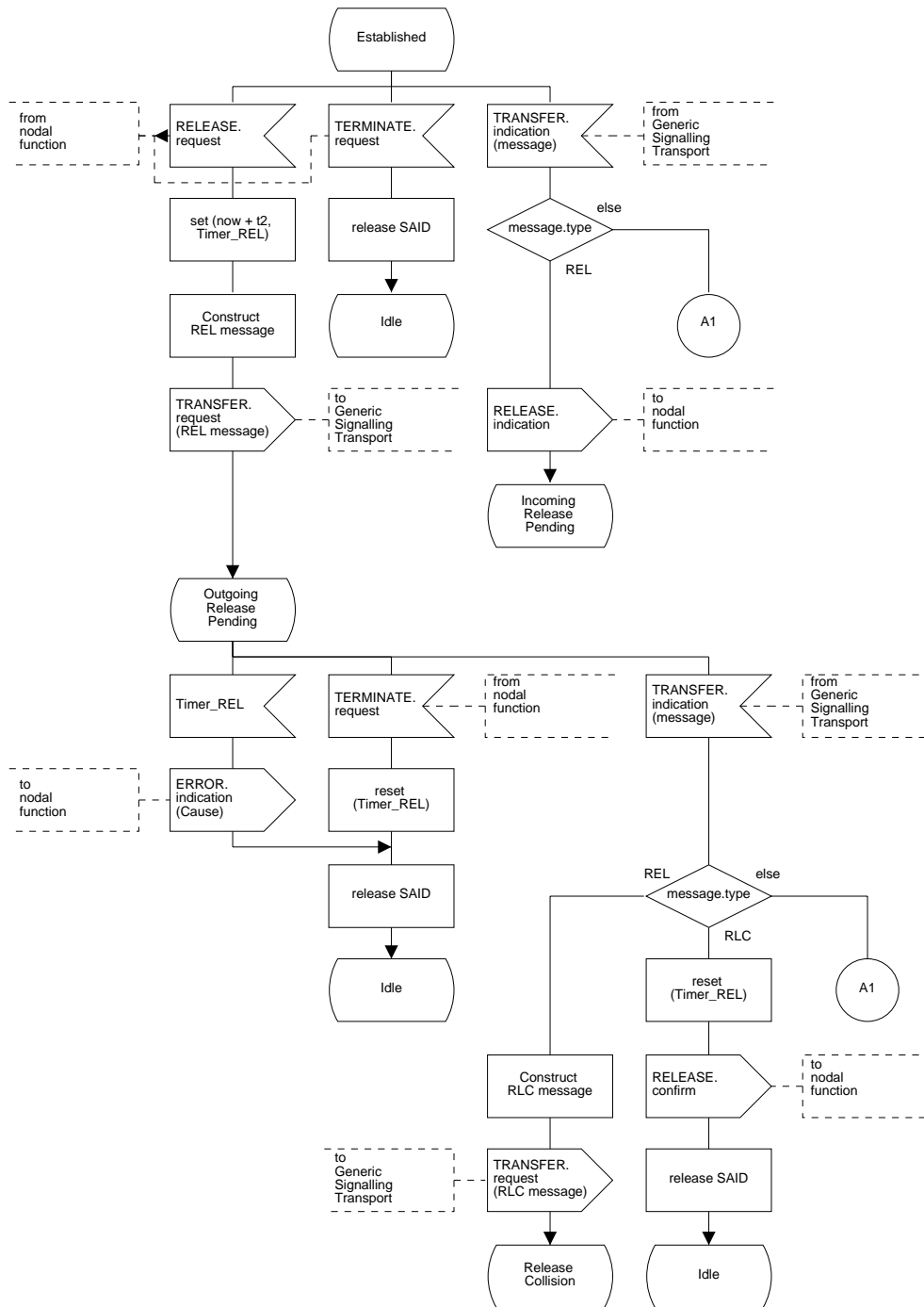

Figure 8-2/Q.2630.1 – SDL diagram for the outgoing protocol procedure (part 2 of 4)

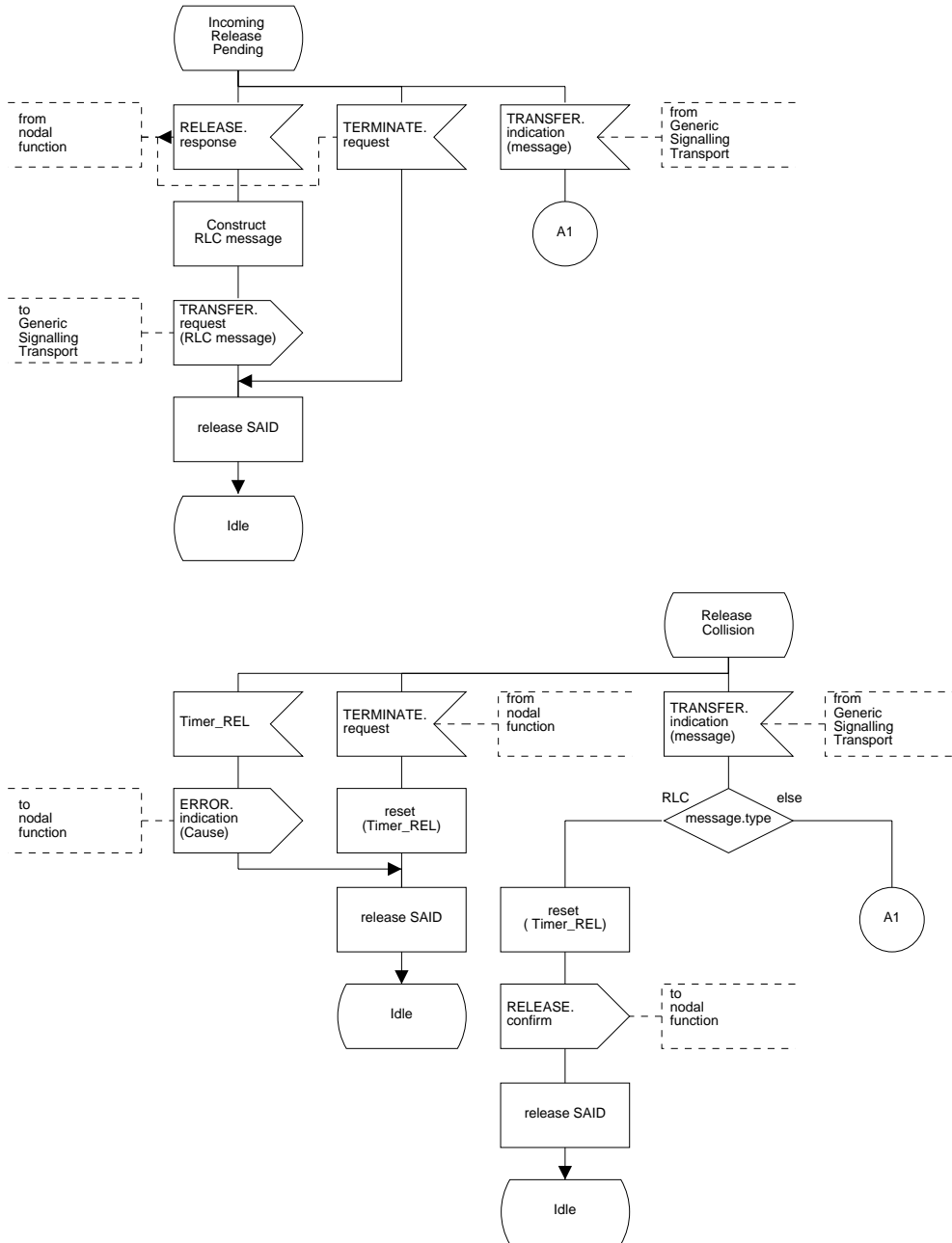

Figure 8-2/Q.2630.1 – SDL diagram for the outgoing protocol procedure (part 3 of 4)

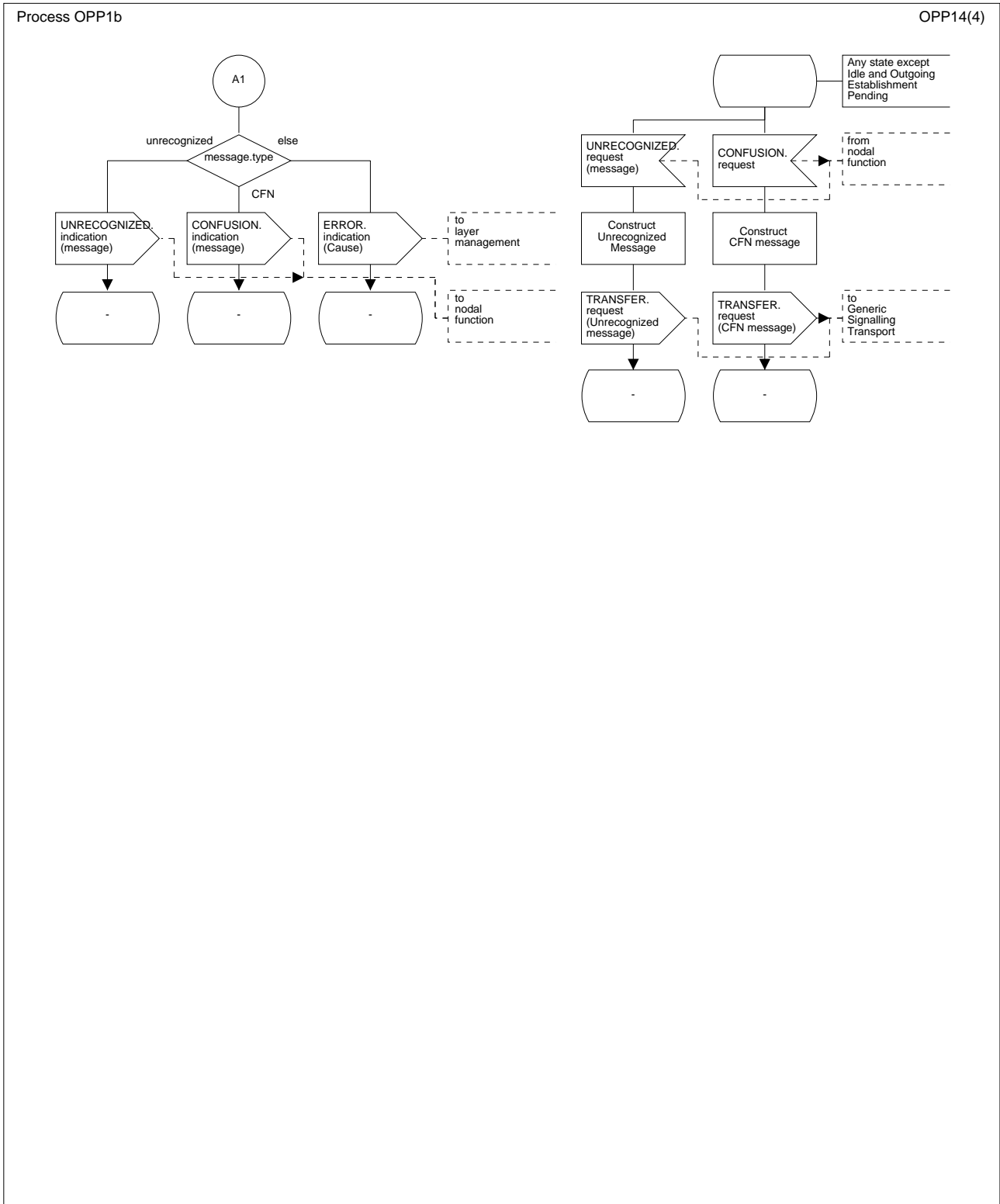

Figure 8-2/Q.2630.1 – SDL diagram for the outgoing protocol procedure (part 4 of 4)

### 8.3.3 Incoming protocol procedures

#### 8.3.3.1 Successful connection setup

Upon receiving an ERQ message (establish request) in state "Idle" with the DSAID set to "unknown", a Signalling Association Identifier (SAID) is allocated for the new incoming protocol entity instance.

The incoming protocol entity instance informs the nodal function of the request for a new connection and state "Incoming establishment pending" is entered.

After receiving an acknowledgement from the nodal function that the connection establishment is accepted, an ECF message (establish confirm) is sent to the preceding AAL type 2 node and state "Established" is entered.

#### **8.3.3.2 Unsuccessful connection setup**

If a Signalling Association Identifier (SAID) allocation for the incoming protocol entity instance fails, an RLC message (release confirm) is returned containing the cause "Resource unavailable, unspecified".

If a request to terminate the connection establishment from the nodal function is received, the SAID allocated to this particular incoming protocol entity instance is released and made available for new traffic and state "Idle" is entered.

If the nodal function informs the incoming protocol entity instance that the connection establishment is not accepted, an RLC message is issued towards the preceding AAL type 2 node with the cause provided by the nodal function. The SAID allocated to this particular incoming protocol entity instance is released and made available for new traffic and state "Idle" is entered.

#### **8.3.3.3 Normal connection release**

Refer to 8.3.2.3.

#### **8.3.3.4 Release request collision**

Refer to 8.3.2.4.

#### **8.3.3.5 Abnormal connection release procedures**

Refer to 8.3.2.5.

#### **8.3.3.6 Unrecognized information procedures**

Refer to 8.3.2.6.

#### **8.3.3.7 State transition model**

##### **8.3.3.7.1 State transition**

The state transition diagram for the incoming protocol procedure is shown in Figure 8-3.

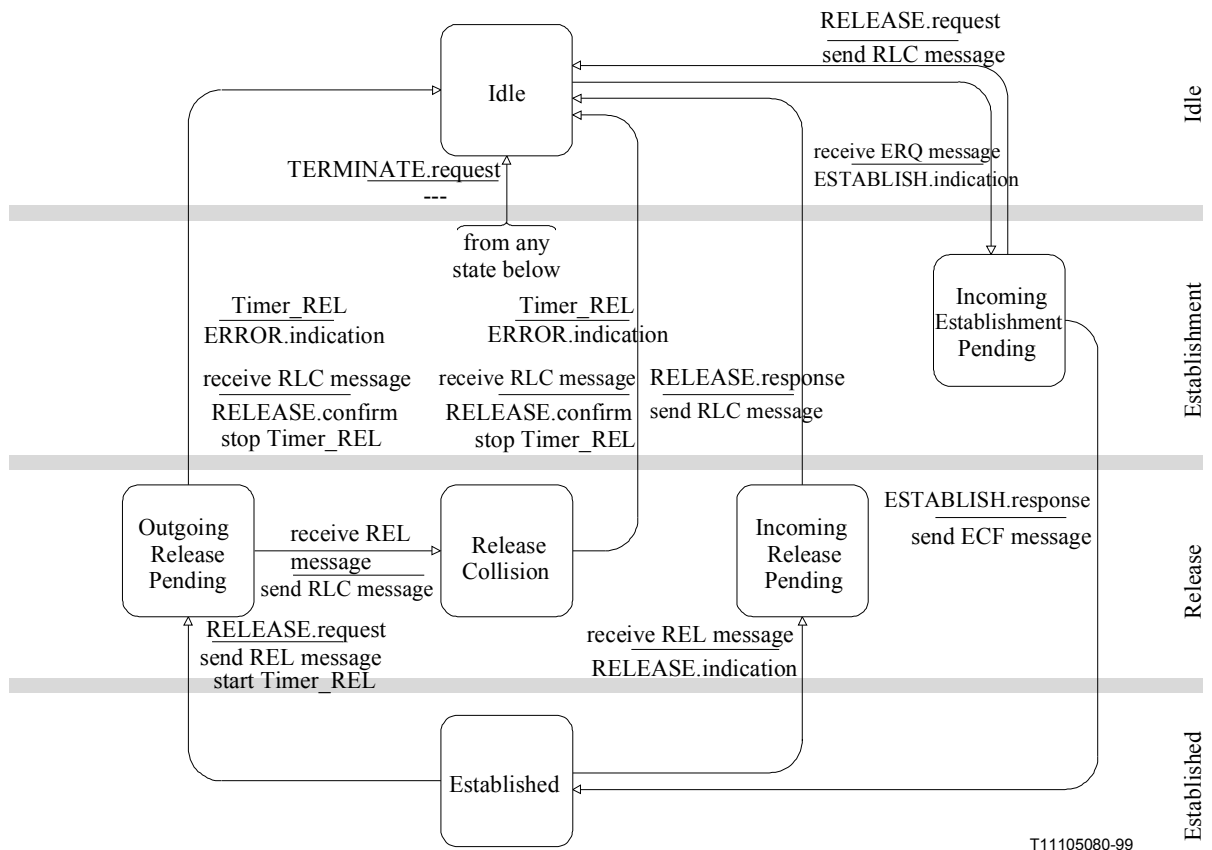

**Figure 8-3/Q.2630.1 – State transition diagram for the incoming protocol procedure**

### 8.3.3.7.2 SDL diagrams for the incoming protocol procedures

The SDL diagram for the incoming protocol procedure is shown in Figure 8-4 (parts 1 to 4).

The SDL diagrams contained in Figure 8-4 (parts 1 to 4) are an introduction to the procedures described in detail in 8.3.3.



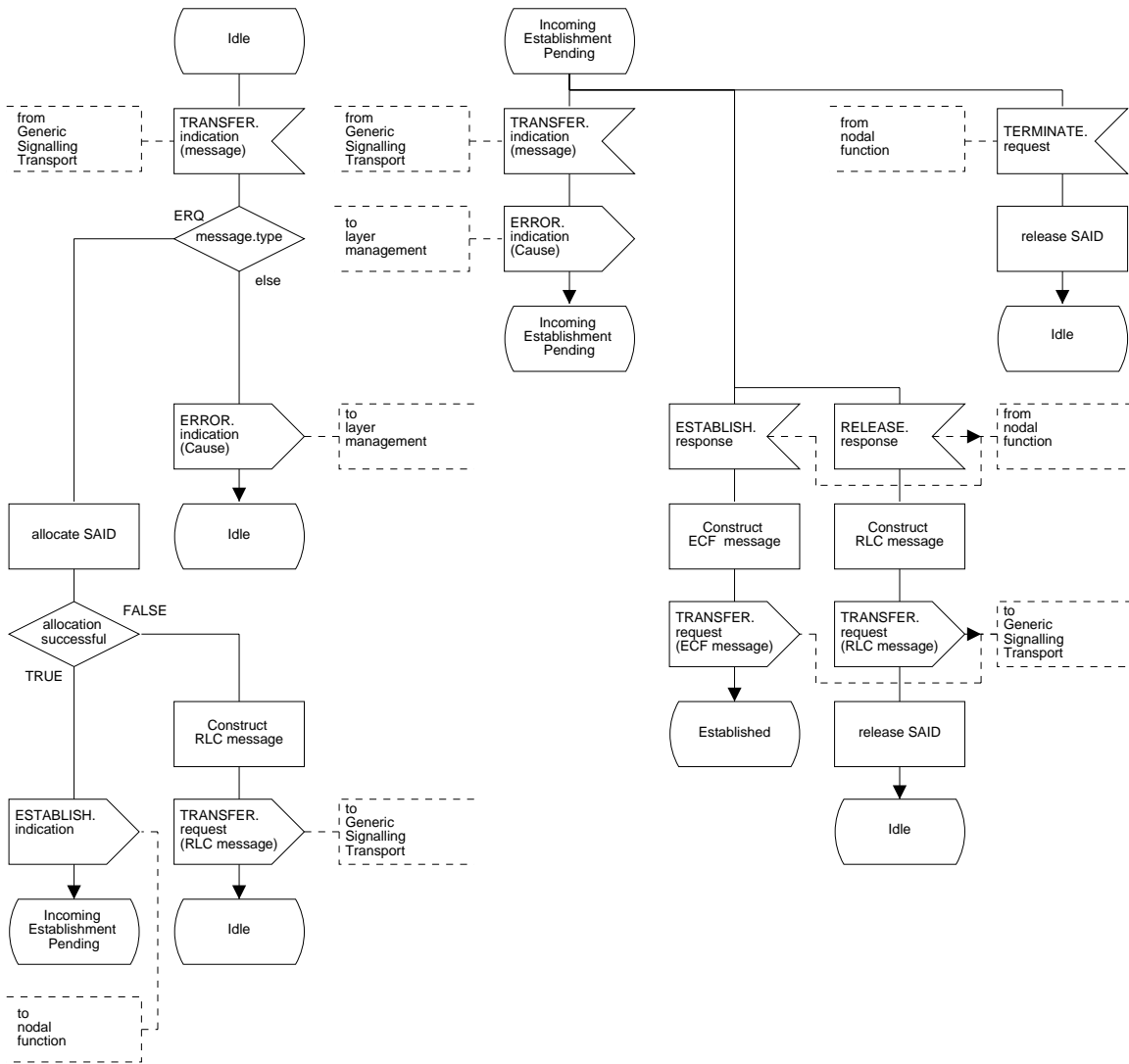

The signals to and from the nodal function are not defined and are for descriptive purposes only.

Figure 8-4/Q.2630.1 – SDL diagram for the incoming protocol procedure (part 1 of 4)

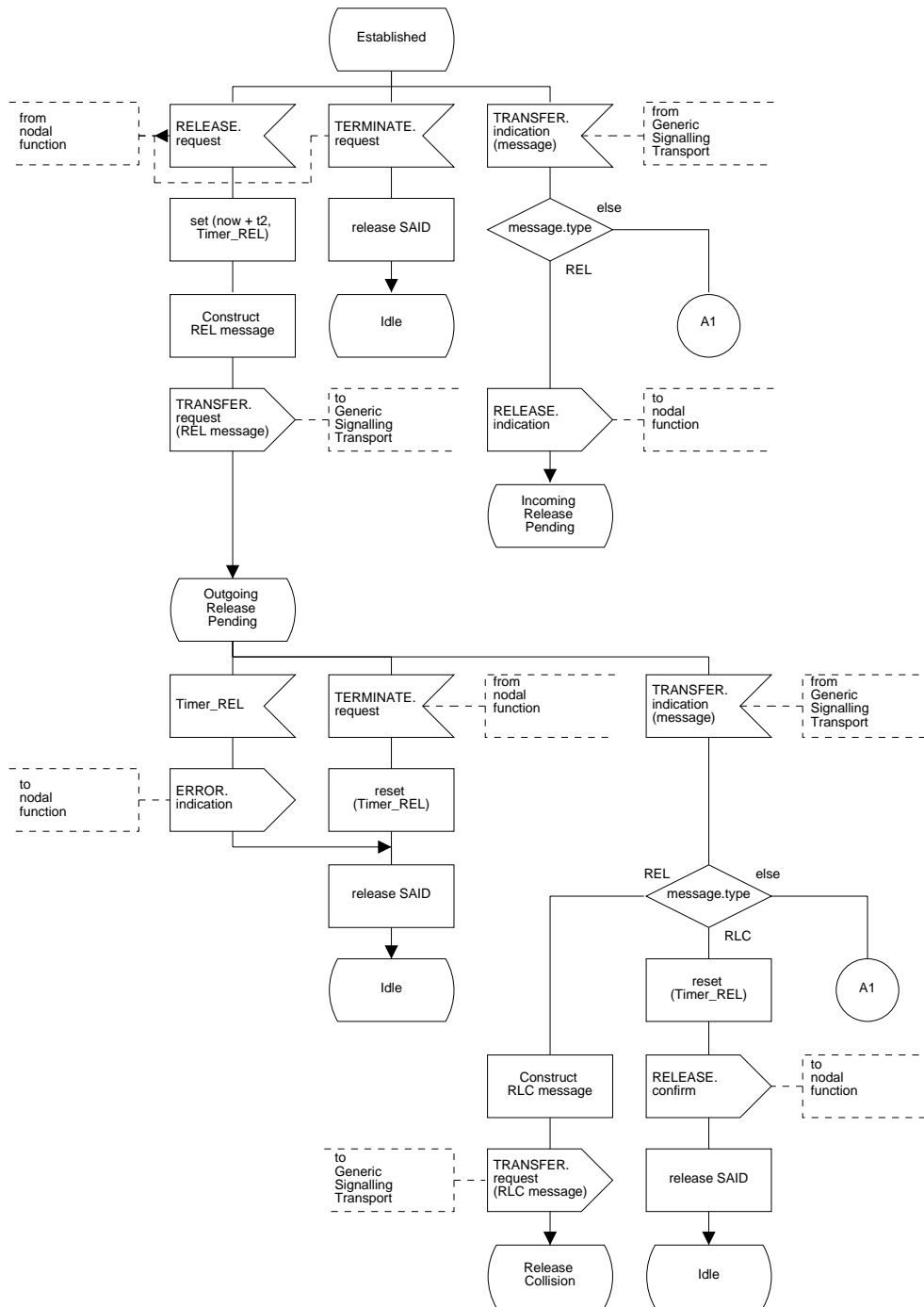

Figure 8-4/Q.2630.1 – SDL diagram for the incoming protocol procedure (part 2 of 4)

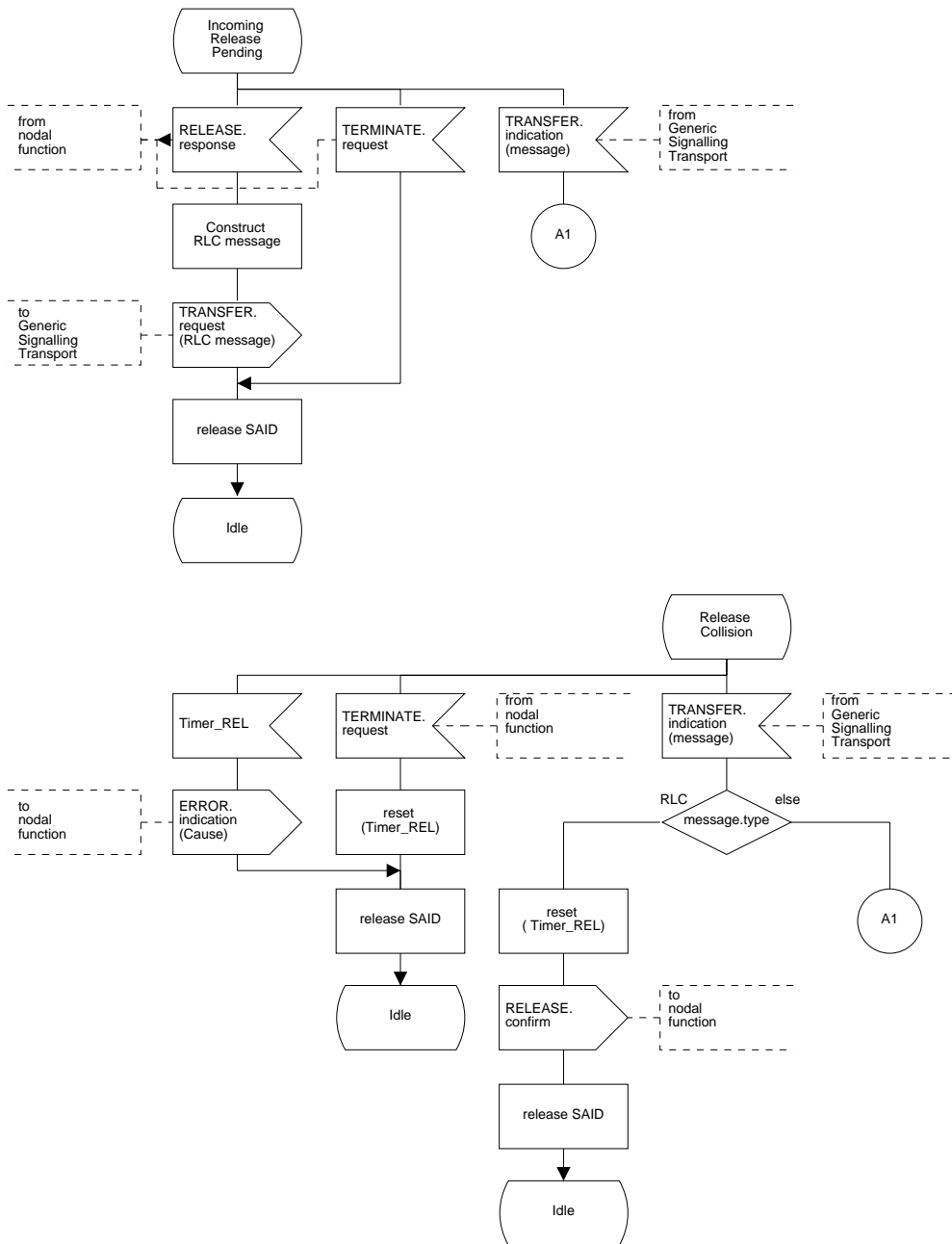

Figure 8-4/Q.2630.1 – SDL diagram for the incoming protocol procedure (part 3 of 4)

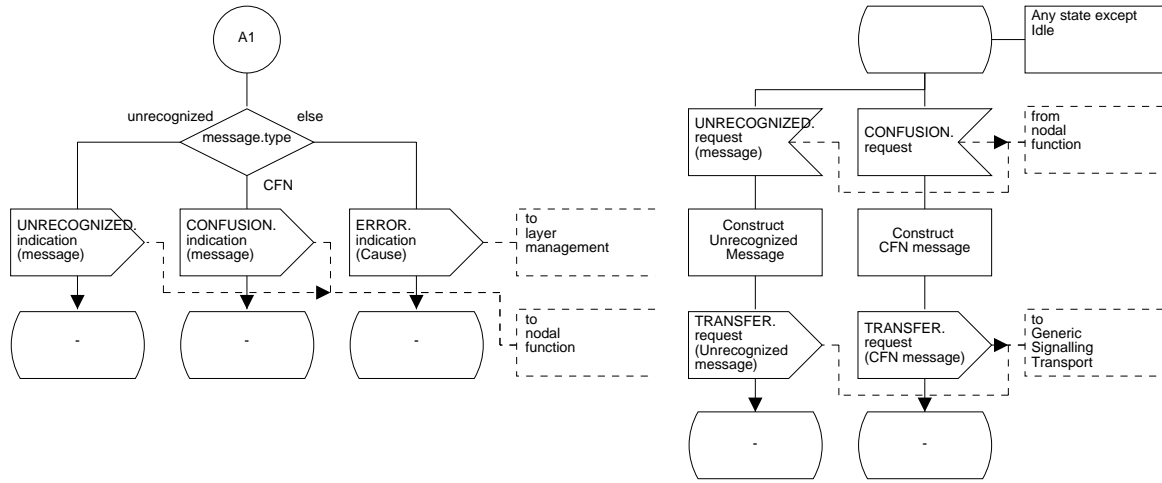

Figure 8-4/Q.2630.1 – SDL diagram for the incoming protocol procedure (part 4 of 4)

## **8.3.4 Maintenance protocol procedures**

### **8.3.4.1 Reset**

#### **8.3.4.1.1 Sending reset**

When a request for reset is received from the nodal function, a maintenance protocol entity instance is created and an SAID allocated to it.

If the request indicates all AAL type 2 paths associated with a signalling association are to be reset, a RES message (reset request) containing the Connection Element Identifier parameter – with both the Path Identifier and the Channel Identifier coded with a "Null" value – is sent to the adjacent AAL type 2 node.

If the request contains the identity of an AAL type 2 path with the channel identifier coded with a "Null" value, a RES message containing the connection element identifier parameter – with the path identifier set to indicate the path and the channel identifier coded with the "Null" value – is sent to the adjacent AAL type 2 node.

If the request contains the identity of a path and a channel, a RES message containing the connection element identifier parameter – with the path identifier set to indicate the path and the channel identifier set to indicate the channel – is sent to the adjacent AAL type 2 node.

When the RES message is sent, Timer\_RES is started and state "Outgoing reset pending" is entered.

If an RSC message (reset confirm) is received in state "Outgoing reset pending", a reset confirmation is passed to the nodal function and Timer\_RES is stopped. The SAID allocated to the maintenance protocol entity instance is released and made available for new traffic. The maintenance protocol entity instance enters state "Idle".

#### **8.3.4.1.2 Receiving reset**

When a RES message (reset request) is received, a maintenance protocol entity instance will be invoked.

If the Path Identifier field in the CEID parameter included in the RES message is coded with the "Null" value, an indication that all AAL type 2 paths associated with the signalling association must be reset is passed to the nodal function.

If the path identifier field in the CEID parameter included in the RES message is coded with a "non-Null" value but the channel identifier field with a "Null" value, an indication that all channels within the AAL type 2 path must be reset is passed to the nodal function.

If the RES message contains the CEID parameter with both a "non-Null" path identifier field and a "non-Null" channel identifier field, an indication that the channel within the identified path must be reset is passed to the nodal function.

After notifying the nodal function, state "Incoming reset pending" is entered.

When a Reset response is received from the nodal function, a RSC message (reset confirm) is sent to the peer protocol entity instance. The maintenance protocol entity instance enters state "Idle".

#### **8.3.4.1.3 Exceptional reset procedures**

If the SAID allocation fails, the nodal function is informed with a cause "Switching equipment congestion" and the maintenance protocol entity instance enters state "Idle".

When Timer\_RES expires in state "Outgoing reset pending", the RES message is sent again, the nodal function is informed with a cause "Recovery on timer expiry", state "Outgoing reset continuing" is entered, and Timer\_RES is started again.

When Timer\_RES expires in state "Outgoing reset continuing", the RES message is sent again and Timer\_RES is started again; the nodal function is not informed.

When an RSC message (reset confirm) is received in state "Outgoing reset continuing", a reset confirmation is passed to the nodal function and Timer\_RES is stopped. The SAID allocated to the maintenance protocol entity instance is released and made available for new traffic. The maintenance protocol entity instance enters state "Idle".

When a request to terminate the repetition of the reset procedure is received, Timer\_RES is stopped. The SAID allocated to the maintenance protocol entity instance is released and made available for new traffic. The maintenance protocol entity instance enters state "Idle".

#### 8.3.4.1.4 State transition model

The state transition diagram for the reset procedure is shown in Figure 8-5.

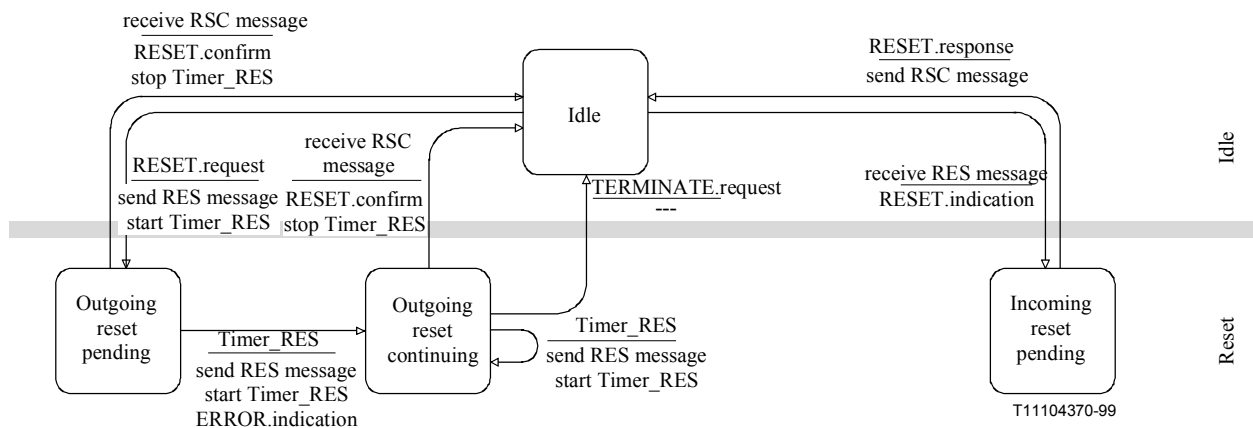

Figure 8-5/Q.2630.1 – State transition diagram for the maintenance control procedure (reset)

#### 8.3.4.2 Blocking and unblocking of AAL type 2 paths

##### 8.3.4.2.1 Sending blocking/unblocking

When a request for blocking is received from the nodal function, a new maintenance protocol entity instance is created, a new SAID is allocated and a BLO message (block request) is sent to the peer AAL type 2 signalling entity. The BLO message contains a connection element identifier with the path identifier coded to indicate the AAL type 2 path to be blocked (as instructed from the nodal function) and the channel identifier coded with the "Null" value. Timer\_BLO is started and state "Outgoing block pending" is entered.

When a BLC message (block confirm) is received from the peer AAL type 2 signalling entity in state "Outgoing block pending", a confirmation of blocking is sent to the nodal function and Timer\_BLO is stopped. The SAID allocated to the maintenance procedure entity instance is released and made available for new traffic and state "Idle" is entered.

When a request for unblocking is received from the nodal function, a new maintenance protocol entity instance is created, a new SAID is allocated and an UBL message (unblock request) is sent to the peer AAL type 2 signalling entity. The UBL message contains a connection element identifier with the path identifier coded to indicate the AAL type 2 path to be unblocked (as instructed from the nodal function) and the channel identifier coded with the "Null" value. Timer\_UBL is started and state "Outgoing unblock pending" is entered.

When an UBC message (unblock confirm) is received from the peer AAL type 2 signalling entity in state "Outgoing unblock pending", a confirmation of unblocking is sent to the nodal function and

Timer\_UBL is stopped. The SAID allocated to the maintenance protocol entity instance is released and made available for new traffic and state "Idle" is entered.

### 8.3.4.2.2 Receiving blocking/unblocking

When a BLO message (block request) is received from the peer AAL type 2 signalling entity, a new maintenance protocol entity instance is created, an indication of the blocking is sent to the nodal function and state "Incoming block pending" is entered.

When a response to the blocking is received from the nodal function in state "Incoming block pending", a BLC message (block confirm) is sent to the peer AAL type 2 signalling entity and state "Idle" is entered.

When an UBL message (unblock request) is received from the peer AAL type 2 signalling entity, a new maintenance protocol entity instance is created, an indication of the unblocking is sent to the nodal function and state "Incoming unblock pending" is entered.

When a response to the unblocking is received from the nodal function in state "Incoming unblock pending", an UBC message (unblock confirm) is sent to the peer AAL type 2 signalling entity and state "Idle" is entered.

### 8.3.4.2.3 Exceptional blocking and unblocking procedures

If the SAID allocation fails, the nodal function is informed with a cause "Switching equipment congestion" and the maintenance protocol entity instance enters state "Idle".

If Timer\_BLO expires, the nodal function is informed with a cause "Recovery on timer expiry", the SAID is released, and state "Idle" is entered.

If Timer\_UBL expires, the nodal function is informed with a cause "Recovery on timer expiry", the SAID is released, and state "Idle" is entered.

### 8.3.4.2.4 State transition

The state transition diagram for the path blocking procedure is shown in Figure 8-6.

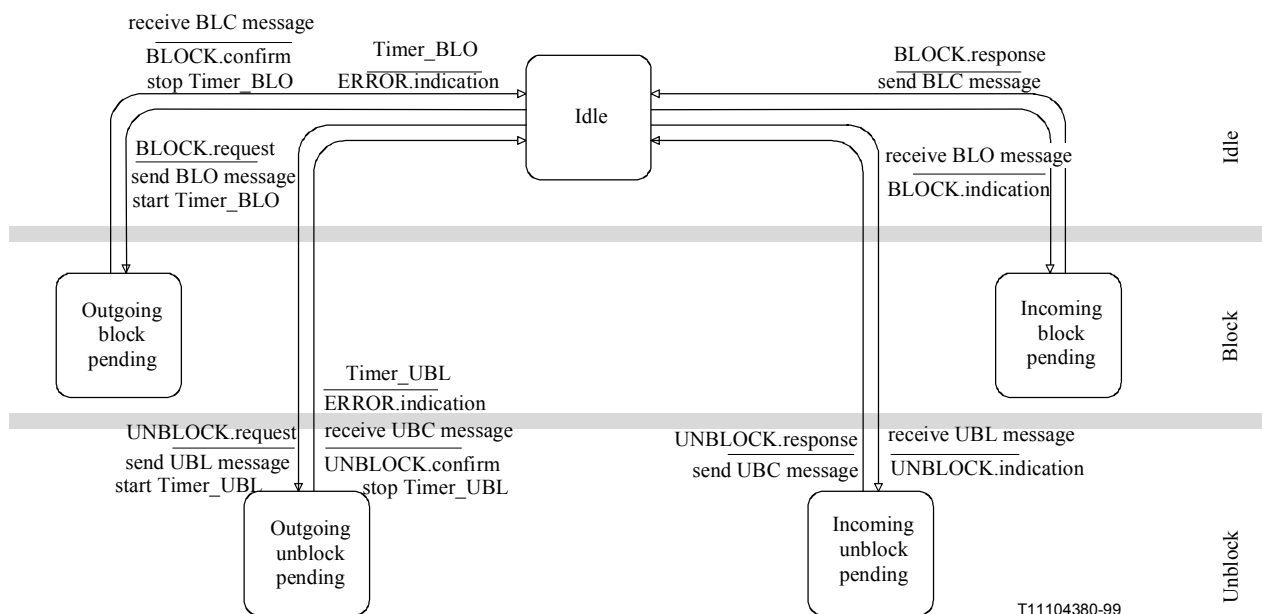

Figure 8-6/Q.2630.1 – State transitions of the maintenance control procedure (blocking and unblocking)

#### **8.3.4.3 Unrecognized information procedures**

When an unrecognized message, parameter, or subfield value is received, the message, the parameter, or the subfield value respectively is conveyed to the nodal function for the appropriate action.

If a request to send a notification of receipt of unrecognized information is received from the nodal function, the BLC message (block confirm), UBC message (unblock confirm), or RSC message (reset confirm) shall contain the cause received from the nodal function.

When a cause parameter is received in a BLC message (block confirm), UBC message (unblock confirm), or RSC message (reset confirm), the cause parameter is conveyed to the nodal function for the appropriate action.

#### **8.3.4.4 SDL diagrams for the maintenance control procedures**

The SDL diagram for the maintenance control procedure is shown in Figure 8-7 (parts 1 to 4).

The SDL diagrams contained in Figure 8-7 (parts 1 to 4) are an introduction to the procedures described in detail in 8.3.4.



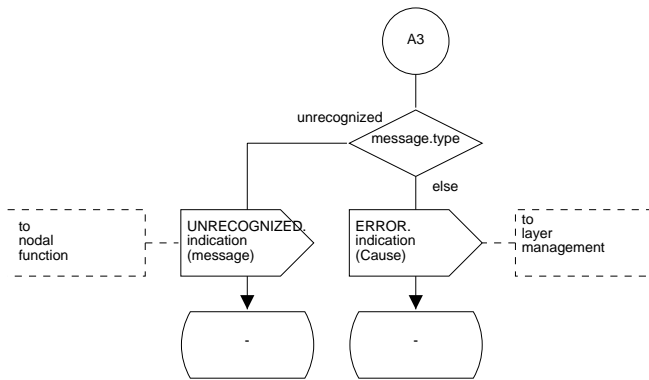
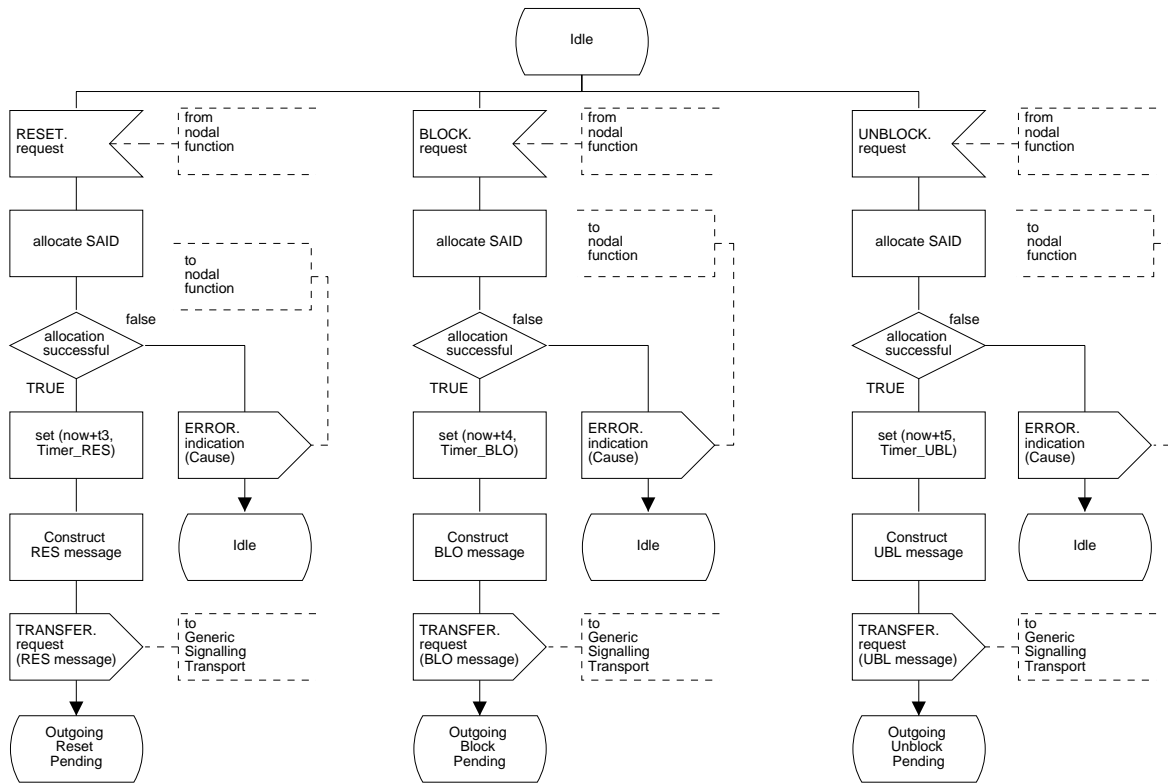

The signals to and from the nodal function are not defined and are for descriptive purposes only.

Figure 8-7/Q.2630.1 – SDL diagram for the maintenance control procedure (part 1 of 4)

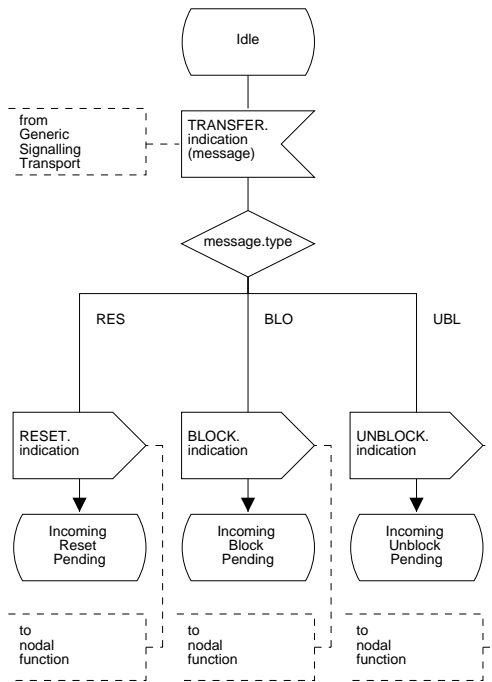

Figure 8-7/Q.2630.1 – SDL diagram for the maintenance control procedure (part 2 of 4)

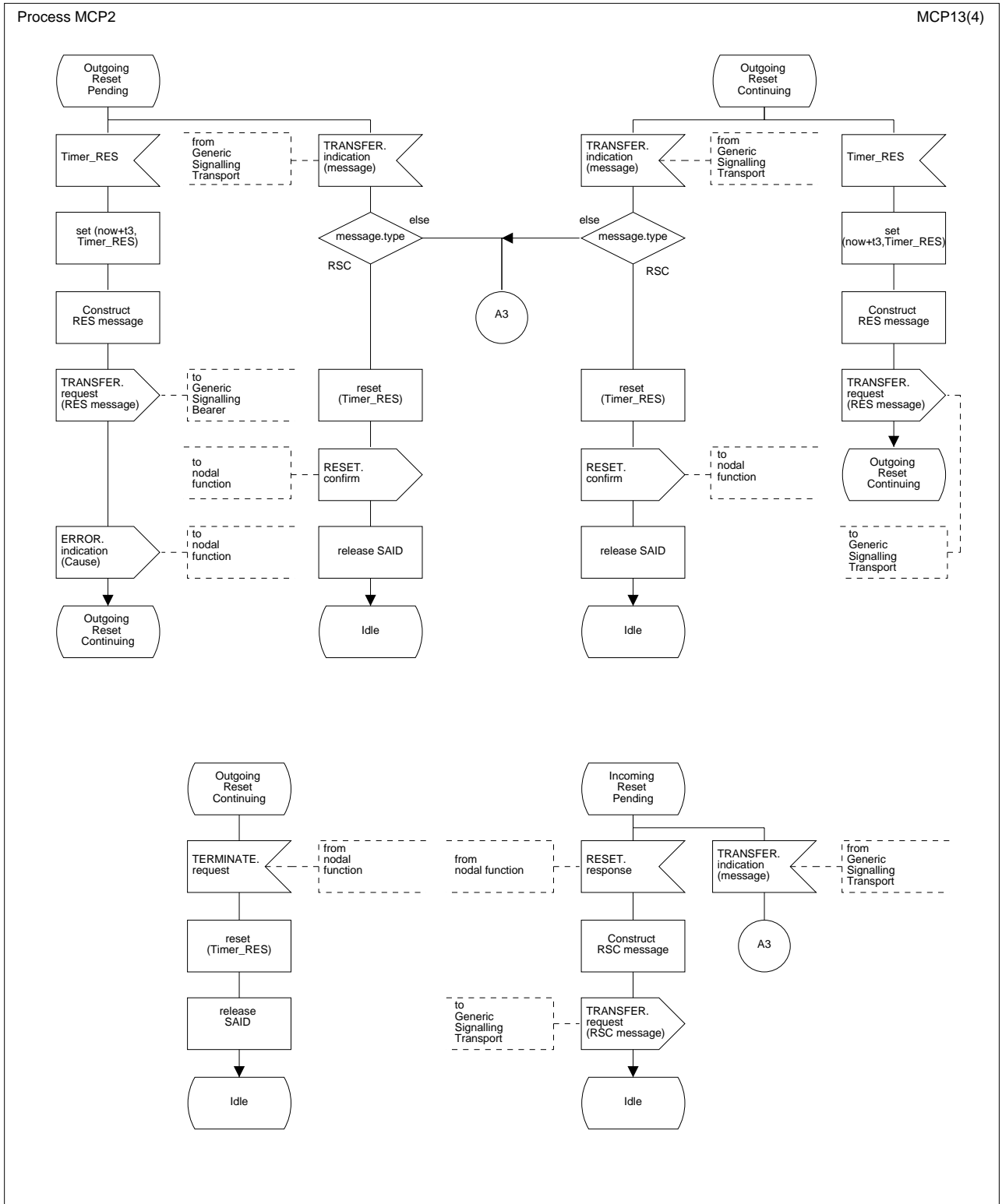

Figure 8-7/Q.2630.1 – SDL diagram for the maintenance control procedure (part 3 of 4)

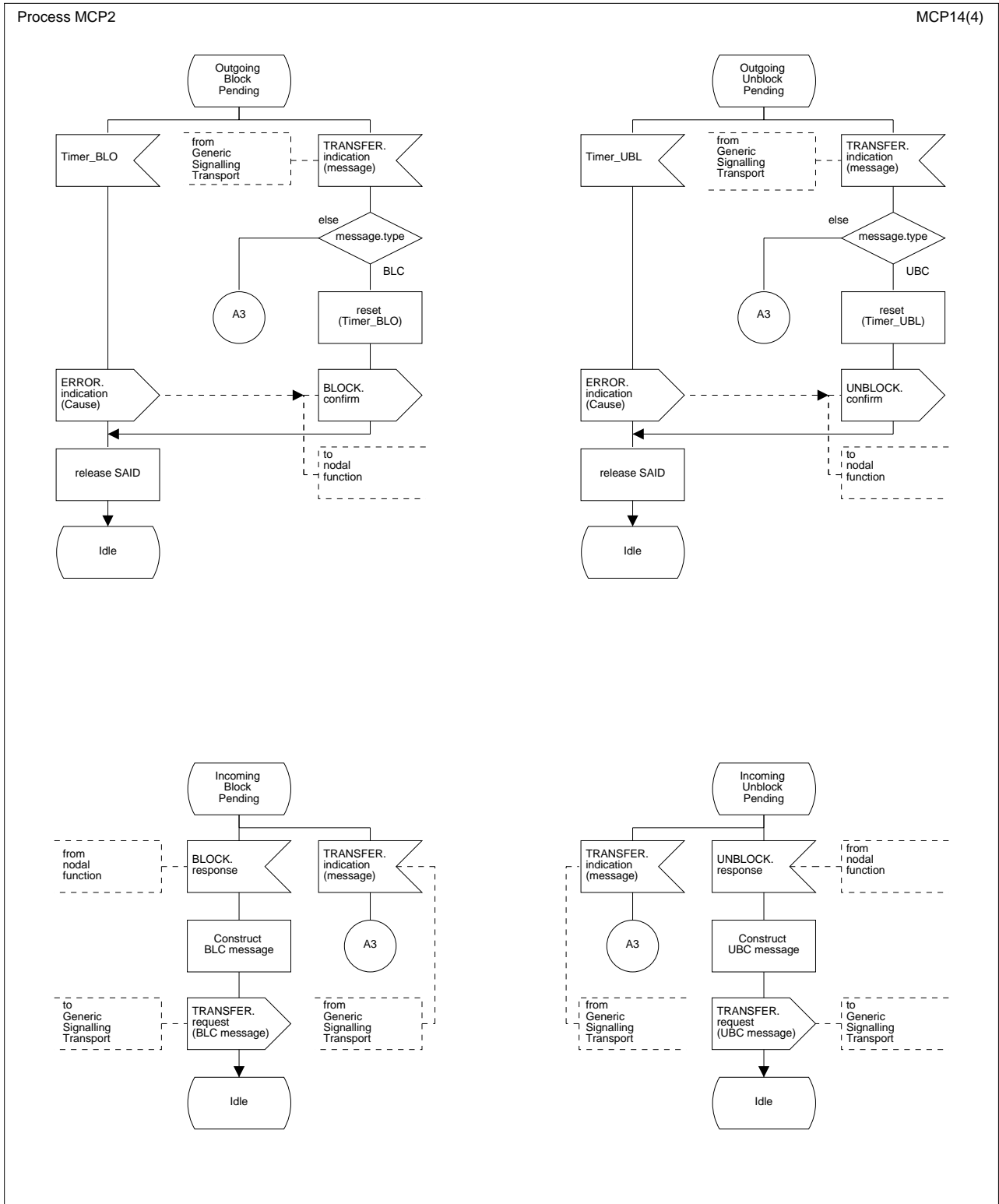

Figure 8-7/Q.2630.1 – SDL diagram for the maintenance control procedure (part 4 of 4)

#### 8.4 List of timers

The timers used in the procedures described in 8.3 are listed in Table 8-1 together with a timeout value range, their cause for setting the timer, resetting the timer, and the action at expiry of the timer.

**Table 8-1/Q.2630.1 – List of timers**

Timer	Time-out value	Cause for initiation	Normal termination	At expiry
Timer_ERQ	5-30 s (t1)	When an ERQ message is sent	At the receipt of ECF message	Release all resources and the connection, send RES message.
Timer_REL	2-60 s (t2)	When an REL message is sent	At the receipt of RLC message	Release resources, send RES message.
Timer_RES	2-60 s (t3)	When an RES message is sent	At the receipt of RSC message	Repeat RES message, restart Timer_RES, at first expiry: inform the nodal function.
Timer_BLO	2-60 s (t4)	When a BLO message is sent	At the receipt of BLC message	Alert maintenance system, inform the nodal function.
Timer_UBL	2-60 s (t5)	When an UBL message is sent	At the receipt of UBC message	Alert maintenance system, inform the nodal function.
NOTE – In the diagnostic field associated with a cause field indicating "Recovery on timer expiry", the timer number is included. Timer_ERQ is coded as the IA5 character "1".				

ANNEX A

**Support for non-switched scenario**

**A.1 Introduction**

The AAL type 2 signalling protocol described in this ITU-T Recommendation can be deployed in support of a non-switched scenario as depicted in Figure A.1.



**Figure A.1/Q.2630.1 – Non-switched scenario**

In this scenario, the originating AAL type 2 service endpoint has one signalling association with each neighbouring AAL type 2 endpoint and there is no AAL type 2 switch. If this endpoint is originating an AAL type 2 connection, routing selection may have been performed when directing the request to another endpoint, but this is outside the scope of this ITU-T Recommendation. If this endpoint is terminating an AAL type 2 connection, no routing decisions are required in the AAL type 2 signalling layer.

This annex describes the subset of the signalling requirements needed to support the non-switched scenario. Because most signalling procedures are link-by-link, there are few differences from the switched scenario. Since the non-switched scenario is a subset of the switched scenario, there are no additional requirements to support non-switched.

**Subclauses below correspond with similarly numbered subclauses in the body of this ITU-T Recommendation.**

## **A.2 References**

Clause 2 applies.

## **A.3 Definitions**

Clause 3 applies.

## **A.4 Abbreviations**

Clause 4 applies.

## **A.5 General framework of the AAL type 2 signalling protocol**

The AAL type 2 signalling protocol provides the signalling capability to establish, release and maintain AAL type 2 point-to-point connections across a single ATM VCC that carries AAL type 2 links. These services are accessible via the AAL type 2 User Service Access Point (A2SU-SAP).

Two peer AAL type 2 signalling entities rely on the generic signalling transport service to provide assured data transfer between them and service availability indications. These services are accessible via the Generic Signalling Transport Service Access Point (GST-SAP).

Note that primitives over the A2SU-SAP, SB-SAP, and LM-SAP are used for descriptive purpose only. They do not imply a specific implementation.

Both peer AAL type 2 signalling entities provide the same set of services.

The AAL type 2 signalling entity is subdivided into protocol entities and nodal functions as shown in Figure A.5-1. At each AAL type 2 service endpoint, the AAL type 2 signalling entity communicates with the AAL type 2 served user.

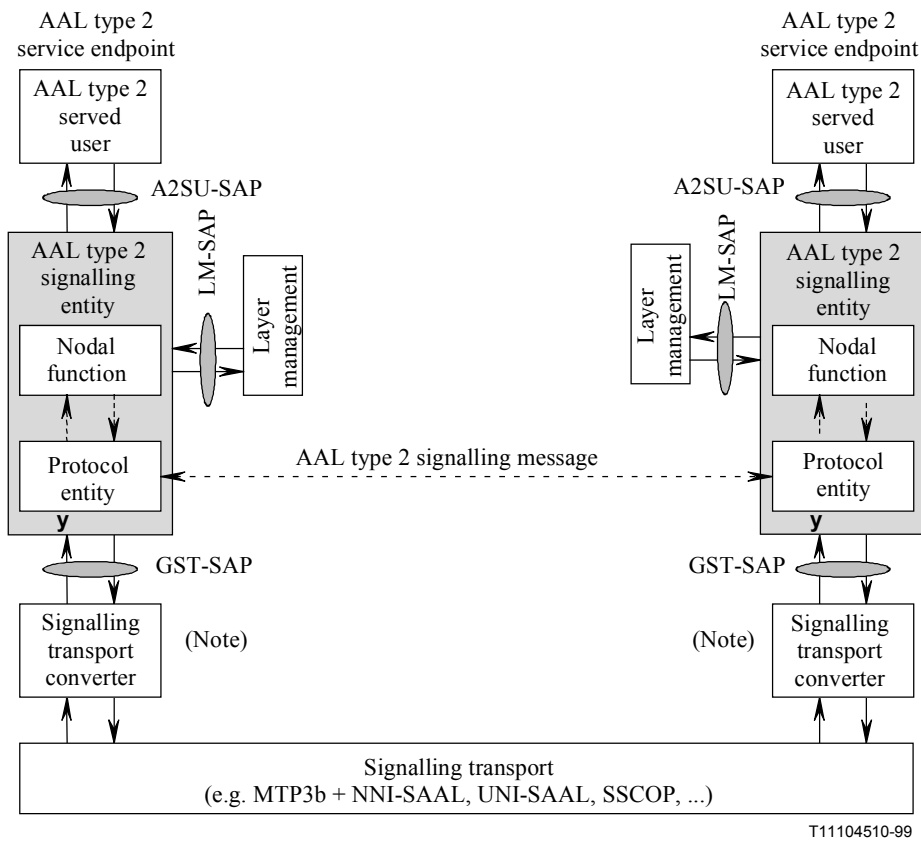

NOTE – A signalling transport converter instance is associated with each AAL type 2 signalling transport.

**Figure A.5-1/Q.2630.1 – AAL type 2 signalling protocol reference architecture for the non-switched scenario**

Protocol Entities define the interactions between two adjacent AAL type 2 nodes. AAL type 2 messages are exchanged between peer protocol entities using the generic signalling transport service.

The AAL type 2 signalling is independent of the signalling transport, although an assured data transport is required and a message size limit applies. To adapt the signalling transport services to a specific signalling transport service, a signalling bearer converter may be needed. The specification of signalling bearer converters is beyond the scope of this ITU-T Recommendation (see ITU-T Recommendations Q.2150.2 [22] and Q.2150.1 [23]).

The protocol entity is divided into several procedures as shown in Figure A.5-2.

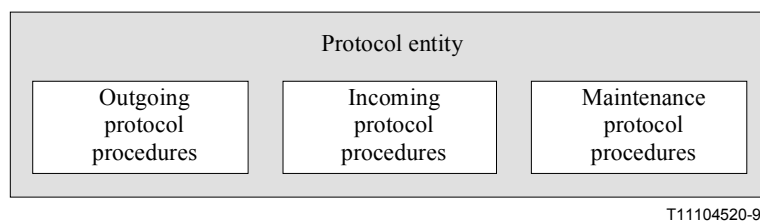

**Figure A.5-2/Q.2630.1 – Internal structure of the AAL type 2 signalling protocol entity**

The outgoing protocol procedures provide the mechanism to initiate an AAL type 2 connection request. The incoming protocol procedures are applied when a request for an AAL type 2 connection is received from a peer entity. Both of these procedures provide for the orderly release of an AAL type 2 connection. The maintenance protocol procedures provide the mechanisms to align the status of the AAL type 2 resources within the two adjacent AAL type 2 nodes and procedures to block and unblock an AAL type 2 path.

The unrecognized information procedures in the nodal function as well as in the protocol entities provide the forward compatibility mechanism which enables extension of the protocol in the future.

The nodal function keeps track of the AAL type 2 path resources.

#### **A.5.1 Interface between the AAL type 2 signalling entity and the AAL type 2 served user**

Subclause 5.1 applies, except for the following:

In the ESTABLISH.request primitive, AAL type 2 Service Endpoint Address (A2EA) is not included.

#### **A.5.2 Service provided by the generic signalling transport service**

Subclause 5.2 applies except for the following:

CONGESTION.indication primitive does not apply.

#### **A.5.3 Interface between the AAL type 2 signalling entities and layer management**

Subclause 5.3 applies.

#### **A.6 Forward and backward compatibility**

Clause 6 applies.

#### **A.7 Format and coding of AAL type 2 signalling protocol**

Clause 7 applies.

##### **A.7.1 Coding conventions for the AAL type 2 signalling protocol**

Subclause 7.1 applies.

##### **A.7.2 Format and coding of the AAL type 2 signalling protocol messages**

###### **A.7.2.1 AAL type 2 signalling protocol messages**

Subclause 7.2.1 applies.

###### **A.7.2.2 Parameters of the AAL type 2 signalling protocol messages**

Subclause 7.2.2 applies as modified below:

The parameters of the AAL type 2 signalling protocol messages are shown in Table A.7-6. The indications of "mandatory" and "optional" are for information only. The authoritative definition is given in A.8. If any difference between the indications in this subclause and the definitions in A.8 exists, the definitions in A.8 take precedence.

Multiple presence of the same parameter in a single message is not permitted.



**Table A.7-6/Q.2630.1 – Parameters of the AAL type 2 signalling protocol messages (part 1 of 2)**

AAL type 2 parameter	AAL type 2 message						
	ERQ	ECF	REL	RLC			
Cause	–	–	M	(Note 4)			
Connection element ID	M	–	–	–			
Destination signalling association identifier (Note 1)	(Note 2)	M	M	M			
Link characteristics	O	–	–	–			
Originating signalling association identifier	M	M	–	–			
Served user generated reference	O	–	–	–			
Served user transport	O	–	–	–			
Service specific information (audio)	(Note 3)	–	–	–			
Service specific information (multirate)	(Note 3)	–	–	–			
Service specific information (SAR-assured)	(Note 3)	–	–	–			
Service specific information (SAR-unassured)	(Note 3)	–	–	–			
Test connection indicator	O	–	–	–			
<p>M Mandatory parameter  O Optional parameter  – Parameter not present</p> <p>NOTE 1 – This row designates the destination signalling association identifier field in the message header.  NOTE 2 – The destination signalling association identifier field contains the value "unknown".  NOTE 3 – At most one of these parameters is present in an instance of the message.  NOTE 4 – The "Cause" parameter is present in the release confirm message if:  a) the RLC is used to reject a connection establishment; or  b) the cause reports unrecognized unknown information received in the REL message.</p>							

**Table A.7-6/Q.2630.1 – Parameters of the AAL type 2 signalling protocol messages (part 2 of 2)**

AAL type 2 parameter	AAL type 2 message						
	RES	RSC	BLO	BLC	UBL	UBC	CFN
Cause	–	(Note 4)	–	(Note 4)	–	(Note 4)	M
Connection element ID	M	–	M (Note 3)	–	M (Note 3)	–	–
Destination signalling association identifier (Note 1)	(Note 2)	M	(Note 2)	M	(Note 2)	M	M
Originating signalling association identifier	M	–	M	–	M	–	–
<p>M Mandatory parameter  O Optional parameter  – Parameter not present</p> <p>NOTE 1 – This row designates the destination signalling association identifier field in the message header.  NOTE 2 – The destination signalling association identifier field contains the value "unknown".  NOTE 3 – The channel identifier field is set to "Null".  NOTE 4 – The "Cause" parameter is present only if the cause reports unrecognized information received.</p>							

The identifiers of the AAL type 2 message parameters are defined in Table A.7-7.

**Table A.7-7/Q.2630.1 – Identifiers of the AAL type 2 message parameters**

AAL type 2 parameter	Ref.	Acronym	Identifier
Cause	7.3.1	CAU	00000001
Connection element ID	7.3.2	CEID	00000010
Link characteristics	7.3.5	ALC	00000101
Originating signalling association identifier	7.3.6	OSAID	00000110
Served user generated reference	7.3.7	SUGR	00000111
Served user transport	7.3.8	SUT	00001000
Service specific information (audio)	7.3.9	SSIA	00001001
Service specific information (multirate)	7.3.10	SSIM	00001010
Service specific information (SAR-assured)	7.3.11	SSISA	00001011
Service specific information (SAR-unassured)	7.3.12	SSISU	00001100
Test connection indicator	7.3.13	TCI	00001101

### **A.7.3 Parameter specification of the AAL type 2 signalling protocol messages**

Applicable parameters are specified in 7.3 except:

- For 7.3.3 "Destination E.164 service endpoint address" and 7.3.4 "Destination NSAP service endpoint address" which are not applicable.

### **A.7.4 Field specification of the AAL type 2 signalling protocol parameters**

Applicable fields are specified in 7.4 except:

- In 7.4.12 add the following sentence: "Optionally, it is possible to increase the CPS-SDU size to 64 octets".
- Subclauses 7.4.13, 7.4.14, and 7.4.15 are not applicable.
- In 7.4.16, cause "Unallocated (unassigned) number" is not applicable.

### **A.8 Procedure of the AAL type 2 signalling protocol**

Before an ATM VCC (AAL type 2 path) is put into service between a pair of adjacent AAL type 2 nodes, certain actions need to be performed. An identifier called the AAL type 2 path identifier is assigned to the ATM VCC. This identifier is used to refer to the ATM VCC in the AAL type 2 signalling protocol messages. The AAL type 2 path identifier shall uniquely identify the ATM VCC between the two adjacent AAL type 2 nodes.

On any ATM VCC used for AAL type 2 connections, all CID values from "8" to "255" are available for assignment.

Any time a new ATM VCC is put into service, the ownership of the ATM VCC shall be determined before AAL type 2 connections are established in it. In case of switched ATM VCC, the owner of the VCC shall be the AAL type 2 node that initiated the establishment of the VCC. In case of PVC and soft PVC, it is the responsibility of the management system to determine the owner of the VCC.

The nodal function is informed by layer management of a newly established AAL type 2 path by the use of the ADD-PATH.indication primitive containing the adjacent AAL type 2 node identifier, the AAL type 2 path identifier, and the ownership. The nodal function is informed by layer management of the removal of an AAL type 2 path by use of the REMOVE-PATH.indication primitive containing the adjacent AAL type 2 node identifier and the AAL type 2 path identifier.

In order to minimize the likelihood of CID collision, the following CID allocation mechanism shall be used:

- if the AAL type 2 node owns the AAL type 2 path that carries the new connection, it allocates CID values from CID value 8 upwards; and
- if the AAL type 2 node does not own the AAL type 2 path that carries the new connection, it allocates CID values from CID value 255 downwards.

NOTE – Causes in the procedures defined in clause 8 specify which ITU-T standardized code should be used in cause parameters of AAL type 2 signalling protocol messages. Implementation dependent non-standardized causes may be used for AAL type 2 signalling entity internal processing and for A2SU-SAP and LM-SAP cause primitive parameters.

The service endpoint address, the served user generated reference, the served user transport parameter, the link characteristics, the SSCS information, and the test connection indicator shall not be modified by the nodal function. The served user generated reference and the served user transport are parameters with significance to the served user only, therefore, they shall not be examined by the nodal function.

### **A.8.1 Compatibility**

Subclause 8.1 applies with the following modifications:

- a) In 8.1.1 "General requirements on receipt of unrecognized signalling information", item d) and the Note below it are not applicable.
- b) In 8.1.2.1 "Unrecognized messages", the bullet item "transfer the message transparently" is not applicable.
- c) In 8.1.2.2 "Unrecognized parameters", the bullet item "transfer the parameter transparently" appears twice and is not applicable in either location.

### **A.8.2 Nodal functions**

#### **A.8.2.1 Nodal functions for AAL type 2 nodes with served user interaction**

Subclause 8.2.1 applies with the modification below.

- a) Subclause 8.2.1.1.1 "Actions at the originating AAL type 2 endpoint" is replaced by the following paragraphs:

When the nodal function receives an ESTABLISH.request primitive from the AAL type 2 served user, it determines the availability of a route with enough AAL type 2 path resources and selects an AAL type 2 path to the succeeding AAL type 2 service endpoint.

Selection of an AAL type 2 path typically is based on:

- the test connection indicator;
- link information (link characteristics); and
- other information (such as SSCS information).

AAL type 2 node internal resources are allocated to establish an AAL type 2 node internal path for the new connection from the originating AAL type 2 served user to the outgoing AAL type 2 path.

On the selected outgoing AAL type 2 path, the CID and other resources (e.g. indicated by link characteristic or SSCS information) are allocated for the outgoing AAL type 2 link.

An outgoing protocol entity instance is invoked and the following parameters are passed to it: the AAL type 2 Path Identifier, and a CID value. The nodal function shall pass the following parameters to the outgoing protocol entity instance only if they were conveyed by the originating AAL type 2 served user: the link characteristics, the SSCS information, the served user generated reference, the served user transport, and the test connection indicator.

NOTE 1 – Through-connection of the transmission path at AAL type 2 endpoints is not specified by this ITU-T Recommendation. It may be controlled by the AAL type 2 served user.

After receiving an indication of the successful AAL type 2 connection setup from the outgoing protocol entity instance, an ESTABLISH.confirm primitive is sent to the AAL type 2 served user.

- b) Subclause 8.2.1.1.2 "Actions at the destination AAL type 2 endpoint" is replaced by the following paragraphs:

Upon receiving an indication from an incoming protocol entity instance requesting a new connection, the nodal function checks the availability of the CID value and other resources, e.g. indicated by link characteristic or SSCS information in the incoming AAL type 2 path.

If the test connection indicator parameter is present, a "locally blocked" or "remotely blocked" AAL type 2 path shall be acceptable for the incoming connection.

If the CID and the other resources are available, they are allocated to the new connection.

AAL type 2 node internal resources are allocated to establish an AAL type 2 node internal path for the new connection from the incoming AAL type 2 path to the destination AAL type 2 served user.

The nodal function acknowledges the successful AAL type 2 connection establishment towards the incoming protocol entity instance.

An ESTABLISH.indication primitive is sent to the AAL type 2 served user to inform it of the successfully established new connection. The nodal function shall pass the following parameters to the outgoing protocol entity instance only if they were conveyed by the incoming protocol entity instance: the SSCS information, the served user transport, the served user generated reference, and the test connection indicator.

NOTE 2 – Through-connection of the transmission path at AAL type 2 endpoints is not specified by this ITU-T Recommendation. It may be controlled by the AAL type 2 served user.

- c) Subclause 8.2.1.1.2.1 "Actions at the originating AAL type 2 endpoint" is replaced by the following paragraphs:

If the AAL type 2 path selection or the CID and other resources allocation described in 8.2.1.1.1.1 fails, a RELEASE.confirm primitive is returned to the AAL type 2 served user with one of the following causes:

- "No route to destination";
- "No circuit/channel available";
- "Resource unavailable, unspecified";
- "Network out of order"; or
- "Temporary failure".

If AAL type 2 node internal resources are not available to establish an AAL type 2 node internal path, a RELEASE.confirm primitive is sent to the AAL type 2 served user with the cause "Switching equipment congestion".

Upon receiving a negative acknowledgement for the connection setup request from the outgoing protocol entity instance, all the resources associated with this AAL type 2 link are released and made available for new traffic. The association to the outgoing protocol entity instance is released. Features that enable a further connection attempt, involving the selection of a different AAL type 2 path within the same route, may be implemented. If no further connection attempt is made, the AAL type 2 node internal resources are released and a RELEASE.confirm primitive is sent to the AAL type 2 served user with the cause received from the outgoing protocol entity instance.

Upon receiving an indication from the outgoing protocol entity instance that a timer has expired, the association to the outgoing protocol entity instance is released and a reset procedure is started [see 8.2.1.2.1.1 case 3 a)]. The AAL type 2 node internal resources are released. A RELEASE.confirm primitive is sent to the AAL type 2 served user with the cause received from the outgoing protocol entity instance, i.e. "Recovery on timer expiry".

d) Subclause 8.2.1.2.4 is not applicable.

#### **A.8.2.2 Nodal functions for AAL type 2 nodes without served user interaction**

Subclause 8.2.2 is not applicable.

#### **A.8.3 Protocol entity**

Subclause 8.3 applies.

#### **A.8.4 List of timers**

Subclause 8.4 applies.

APPENDIX I

Example message sequences

I.1 Successful establishment and release

Figure I.1 illustrates the message sequences for a successful AAL type 2 connection establishment and its release.

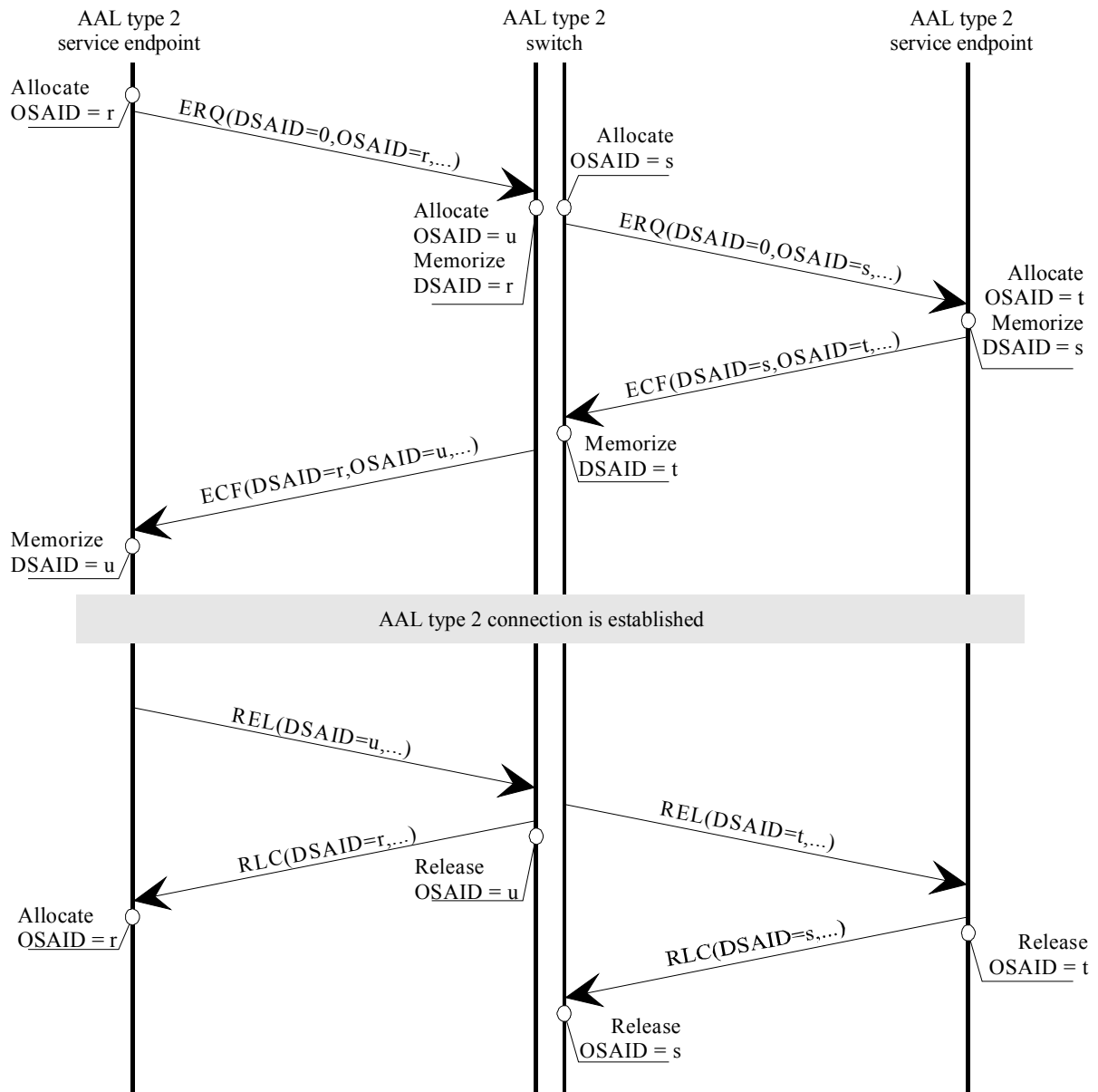

T11104530-99

Figure I.1/Q.2630.1 – Example of successful AAL type 2 connection establishment and release message sequences

Signalling Association Identifiers (SAIDs) are treated in the following way:

- 1) Whenever a new signalling association is created, a new protocol entity instance is created and an OSAID is allocated to it; this ID is then transported in the first message in the OSAID parameter. The DSAID in this message contains the value "unknown", i.e. all octets are set to "0". (In the figures, this is indicated by "DSAID = 0".)
- 2) Upon receipt of a message that has a DSAID field set to "unknown", a new protocol entity instance is created and an OSAID is allocated to it.
- 3) In the first message returned to the originator of the association, the OSAID of the sending protocol entity instance is transported in the OSAID parameter. The DSAID field carries the previously received OSAID of the originator of the association.
- 4) In all subsequent messages, the DSAID field carries the previously received OSAID of the destination entity.
- 5) If the first message returned to the originator of the association is also the last one for this signalling association (see Figures I.2 or I.3), no OSAID parameter is carried in the message. The DSAID field carries the previously received OSAID of the originator of the association.

## I.2 Unsuccessful establishment

Figure I.2 illustrates the message sequences for an unsuccessful AAL type 2 connection establishment.

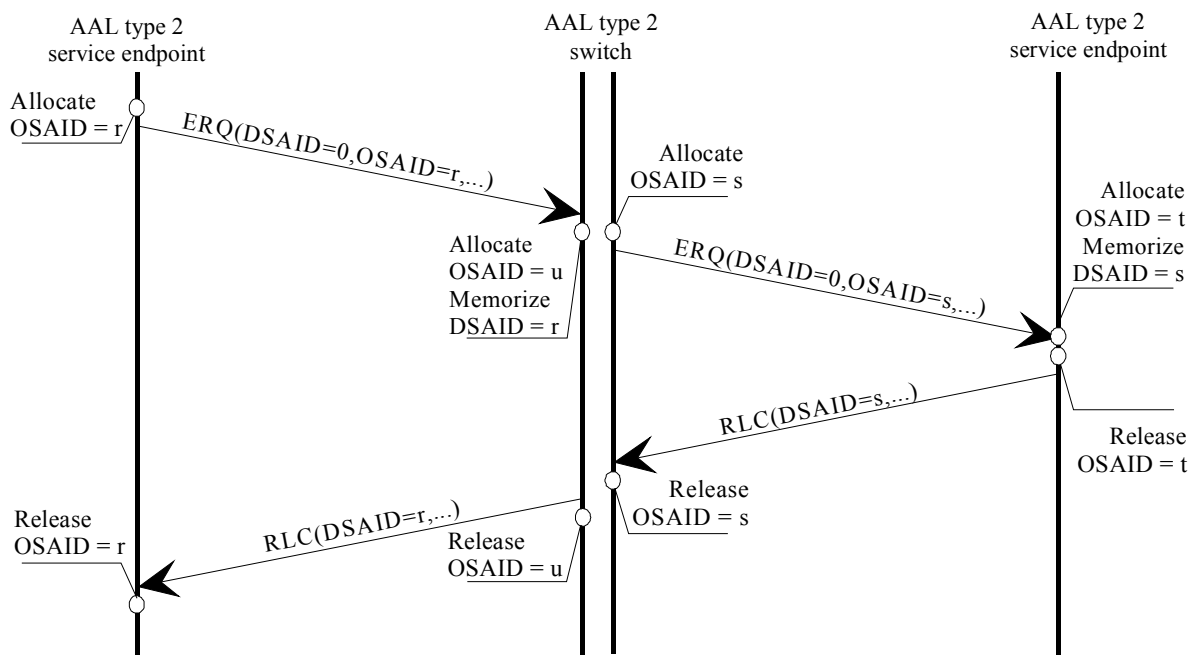

T11104540-99

**Figure I.2/Q.2630.1 – Example of a message sequence for an unsuccessful AAL type 2 connection establishment**

### I.3 Management message sequences

Figure I.3 illustrates the message sequences for a management operation. Management operations include:

- reset procedures;
- blocking procedures;
- unblocking procedures.

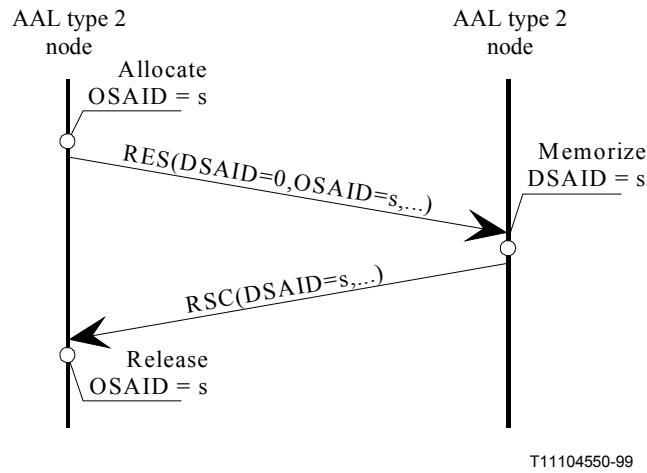

**Figure I.3/Q.2630.1 – Example of a message sequence for a management operation**

NOTE – Message sequences for blocking or unblocking are the same as for reset except that instead of "RES" and "RSC":

- for blocking, the messages "BLO" and "BLC" are used respectively; and
- for unblocking, the messages "UBL" and "UBC" are used respectively.



#### I.4 Release crossover/release collision

Figure I.4 illustrates the message sequences for release collision on an AAL type 2 connection release.

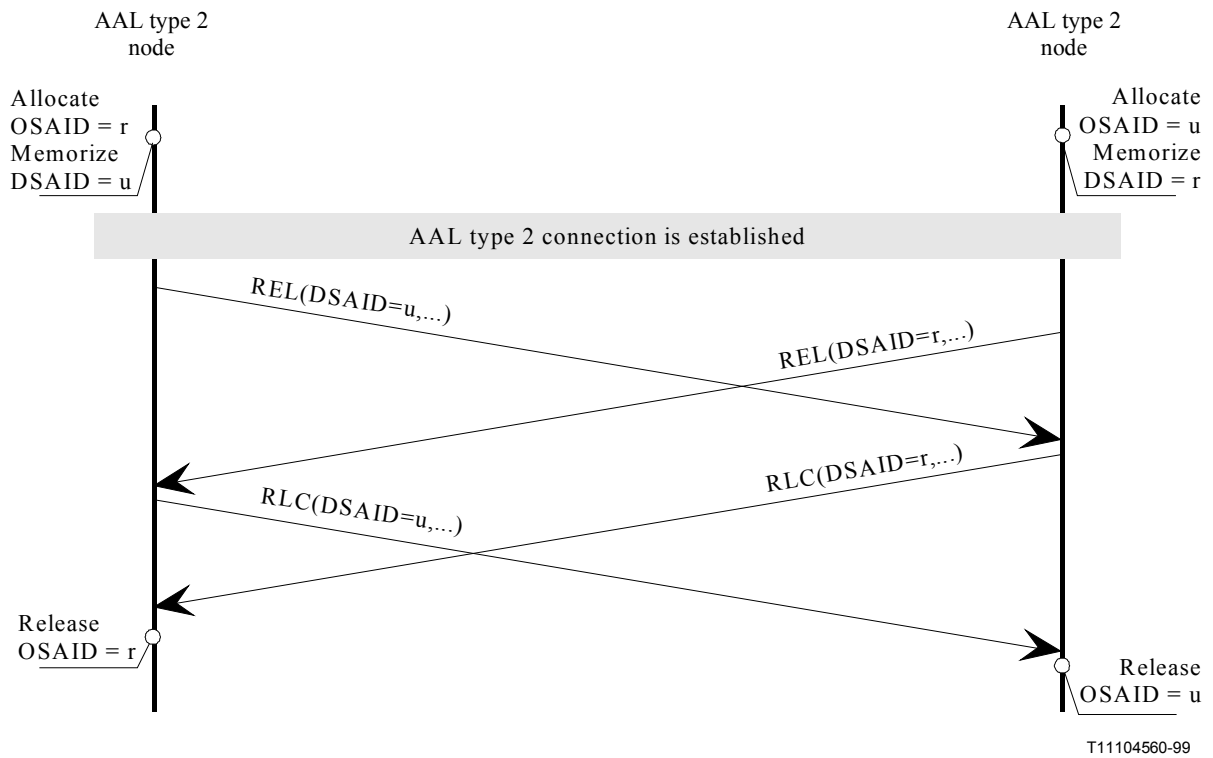
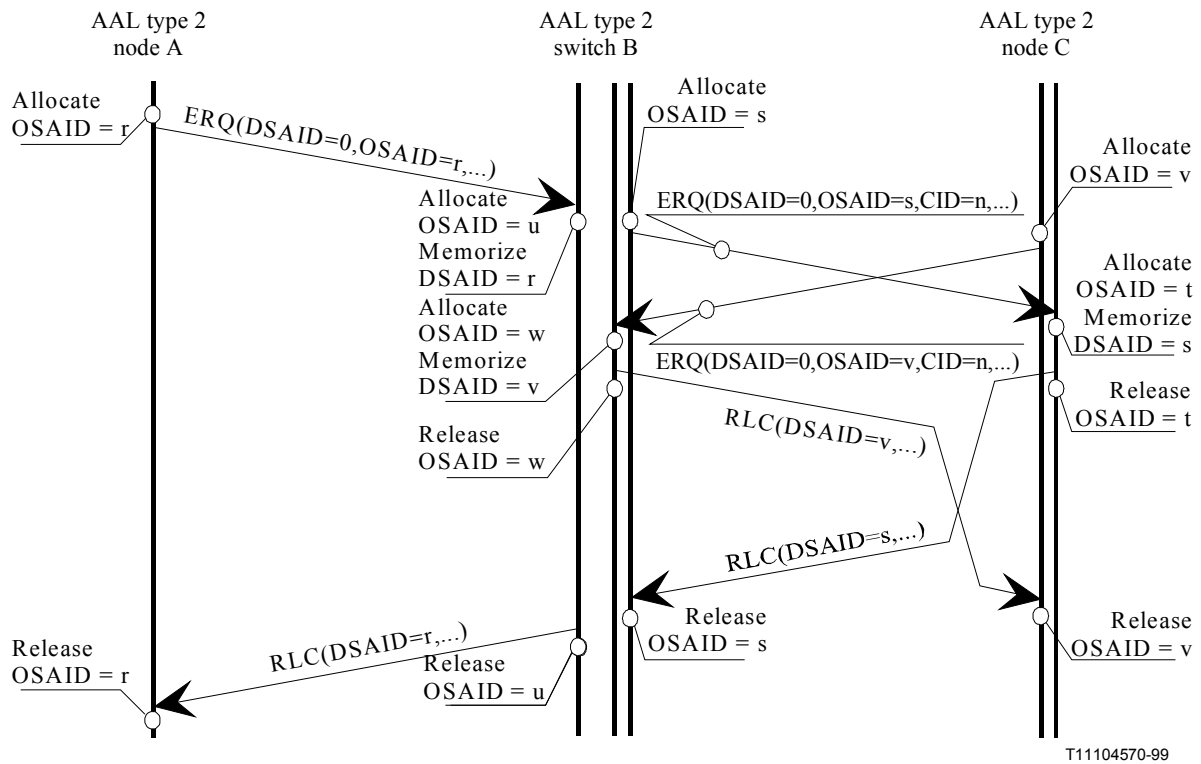

Figure I.4/Q.2630.1 – Example of a message sequence for a release collision on an AAL type 2 connection

## I.5 Resource contention

Figure I.5 illustrates the message sequences for a resource contention on an AAL type 2 connection establishment.



**Figure I.5/Q.2630.1 – Example of a message sequence for a resource contention on two AAL type 2 connections**

NOTE – The resource contention is shown for a CID value "n" that is attempting to be assigned to two new AAL type 2 connections.

## **SERIES OF ITU-T RECOMMENDATIONS**

Series A	Organization of the work of ITU-T
Series B	Means of expression: definitions, symbols, classification
Series C	General telecommunication statistics
Series D	General tariff principles
Series E	Overall network operation, telephone service, service operation and human factors
Series F	Non-telephone telecommunication services
Series G	Transmission systems and media, digital systems and networks
Series H	Audiovisual and multimedia systems
Series I	Integrated services digital network
Series J	Transmission of television, sound programme and other multimedia signals
Series K	Protection against interference
Series L	Construction, installation and protection of cables and other elements of outside plant
Series M	TMN and network maintenance: international transmission systems, telephone circuits, telegraphy, facsimile and leased circuits
Series N	Maintenance: international sound programme and television transmission circuits
Series O	Specifications of measuring equipment
Series P	Telephone transmission quality, telephone installations, local line networks
<b>Series Q</b>	<b>Switching and signalling</b>
Series R	Telegraph transmission
Series S	Telegraph services terminal equipment
Series T	Terminals for telematic services
Series U	Telegraph switching
Series V	Data communication over the telephone network
Series X	Data networks and open system communications
Series Y	Global information infrastructure and Internet protocol aspects
Series Z	Languages and general software aspects for telecommunication systems