



INTERNATIONAL TELECOMMUNICATION UNION

ITU-T

TELECOMMUNICATION
STANDARDIZATION SECTOR
OF ITU

Q.2981

(12/1999)

SERIES Q: SWITCHING AND SIGNALLING

Broadband ISDN – B-ISDN application protocols for
access signalling

**Broadband integrated services digital network
(B-ISDN) and broadband private integrated
services network (B-PISN) – Call control
protocol**

ITU-T Recommendation Q.2981

(Formerly CCITT Recommendation)

ITU-T Q-SERIES RECOMMENDATIONS

SWITCHING AND SIGNALLING

SIGNALLING IN THE INTERNATIONAL MANUAL SERVICE	Q.1–Q.3
INTERNATIONAL AUTOMATIC AND SEMI-AUTOMATIC WORKING	Q.4–Q.59
FUNCTIONS AND INFORMATION FLOWS FOR SERVICES IN THE ISDN	Q.60–Q.99
CLAUSES APPLICABLE TO ITU-T STANDARD SYSTEMS	Q.100–Q.119
SPECIFICATIONS OF SIGNALLING SYSTEMS No. 4 AND No. 5	Q.120–Q.249
SPECIFICATIONS OF SIGNALLING SYSTEM No. 6	Q.250–Q.309
SPECIFICATIONS OF SIGNALLING SYSTEM R1	Q.310–Q.399
SPECIFICATIONS OF SIGNALLING SYSTEM R2	Q.400–Q.499
DIGITAL EXCHANGES	Q.500–Q.599
INTERWORKING OF SIGNALLING SYSTEMS	Q.600–Q.699
SPECIFICATIONS OF SIGNALLING SYSTEM No. 7	Q.700–Q.849
DIGITAL SUBSCRIBER SIGNALLING SYSTEM No. 1	Q.850–Q.999
PUBLIC LAND MOBILE NETWORK	Q.1000–Q.1099
INTERWORKING WITH SATELLITE MOBILE SYSTEMS	Q.1100–Q.1199
INTELLIGENT NETWORK	Q.1200–Q.1699
SIGNALLING REQUIREMENTS AND PROTOCOLS FOR IMT-2000	Q.1700–Q.1799
BROADBAND ISDN	Q.2000–Q.2999
General aspects	Q.2000–Q.2099
Signalling ATM adaptation layer (SAAL)	Q.2100–Q.2199
Signalling network protocols	Q.2200–Q.2299
Common aspects of B-ISDN application protocols for access signalling and network signalling and interworking	Q.2600–Q.2699
B-ISDN application protocols for the network signalling	Q.2700–Q.2899
B-ISDN application protocols for access signalling	Q.2900–Q.2999

For further details, please refer to ITU-T List of Recommendations.

ITU-T RECOMMENDATION Q.2981

BROADBAND INTEGRATED SERVICES DIGITAL NETWORK (B-ISDN) AND BROADBAND PRIVATE INTEGRATED SERVICES NETWORK (B-PISN) – CALL CONTROL PROTOCOL

Summary

This Recommendation specifies a signalling protocol for the purpose of call control at the Q_B , S_B , T_B , and co-incident S_B/T_B reference points within, between, and at the access to Broadband Private Integrated Services Networks and within, between, and at the access to Broadband Integrated Services Digital Networks. The protocol operates between two adjacent call control entities. The protocol is applicable to a terminal or network node in a separated call and bearer (connection) control environment for the support of calls having none, a single bearer or multiple bearers. The protocol is applicable to a two-party call. The protocol also provides forward compatibility to the extent that an implementation can also operate within a multi-party call with other implementations that use additional capabilities, provided the implementation is deployed where it does not need to be aware of more than two parties.

Source

ITU-T Recommendation Q.2981 was prepared by ITU-T Study Group 11 (1997-2000) and was approved under the WTSC Resolution 1 procedure on 3 December 1999.

Keywords

Bearer control, call control, separation.

FOREWORD

ITU (International Telecommunication Union) is the United Nations Specialized Agency in the field of telecommunications. The ITU Telecommunication Standardization Sector (ITU-T) is a permanent organ of the ITU. The ITU-T is responsible for studying technical, operating and tariff questions and issuing Recommendations on them with a view to standardizing telecommunications on a worldwide basis.

The World Telecommunication Standardization Conference (WTSC), which meets every four years, establishes the topics for study by the ITU-T Study Groups which, in their turn, produce Recommendations on these topics.

The approval of Recommendations by the Members of the ITU-T is covered by the procedure laid down in WTSC Resolution 1.

In some areas of information technology which fall within ITU-T's purview, the necessary standards are prepared on a collaborative basis with ISO and IEC.

NOTE

In this Recommendation, the expression "Administration" is used for conciseness to indicate both a telecommunication administration and a recognized operating agency.

INTELLECTUAL PROPERTY RIGHTS

The ITU draws attention to the possibility that the practice or implementation of this Recommendation may involve the use of a claimed Intellectual Property Right. The ITU takes no position concerning the evidence, validity or applicability of claimed Intellectual Property Rights, whether asserted by ITU members or others outside of the Recommendation development process.

As of the date of approval of this Recommendation, the ITU had not received notice of intellectual property, protected by patents, which may be required to implement this Recommendation. However, implementors are cautioned that this may not represent the latest information and are therefore strongly urged to consult the TSB patent database.

© ITU 2001

All rights reserved. No part of this publication may be reproduced or utilized in any form or by any means, electronic or mechanical, including photocopying and microfilm, without permission in writing from the ITU.

CONTENTS

	Page
1	Scope..... 1
2	References..... 1
3	Definitions 2
4	Abbreviations..... 3
5	Basic model..... 3
5.1	Separation of call control and bearer control..... 3
5.2	Point-to-point and multi-party call control 3
5.3	Call control architecture..... 4
5.4	Relationship to bearer control architecture 5
5.5	Screening function 5
6	Operational requirements..... 7
6.1	Provision and withdrawal 7
6.2	Transport mechanism..... 7
7	Primitive definitions and state definitions 7
7.1	Service primitives 7
7.1.1	Service primitive architecture..... 7
7.1.2	ESTABLISH-CALL 8
7.1.3	COMPLETE-CALL..... 8
7.1.4	STATUS-CALL 9
7.1.5	RELEASE-CALL 9
7.1.6	PROCEED-CALL 10
7.1.7	ERROR..... 10
7.2	Parameters..... 11
7.2.1	Call segment ID 11
7.2.2	Call description..... 11
7.2.3	Call changed parameter 11
7.2.4	Await complete indicator..... 11
7.2.5	Bearer establishment address..... 11
7.2.6	Release cause..... 11
7.2.7	Result..... 12
7.2.8	Diagnostics 12
7.3	Call control states..... 12
7.3.1	Call Idle 12
7.3.2	Call Initiated 12
7.3.3	Outgoing Call Proceeding..... 12

	Page
7.3.4 Call Ready	12
7.3.5 Call Present.....	12
7.3.6 Incoming Call Proceeding	12
7.3.7 Await Call Completion.....	12
7.3.8 Call Active.....	12
7.3.9 Call Release Request	12
7.3.10 Call Release Indication	13
8 Coding requirements.....	13
8.1 Abstract definition of the call control operations	13
8.2 Definition of Call Control Object Super Class	18
8.3 Definitions of Call Control Object Classes in the Information Model	18
9 Procedures.....	21
9.1 Call establishment request	21
9.1.1 Preceding CC entity.....	21
9.1.2 Succeeding CC entity	21
9.2 Call Proceeding.....	21
9.2.1 Preceding CC entity.....	21
9.2.2 Succeeding CC entity	22
9.3 Call accepted.....	22
9.3.1 Preceding CC entity.....	22
9.3.2 Succeeding CC entity	22
9.4 Completion of call establishment	23
9.4.1 Preceding CC entity.....	23
9.4.2 Succeeding CC entity	23
9.5 Call status change report.....	23
9.5.1 General.....	23
9.5.2 Initiating CC entity	23
9.5.3 Receiving CC entity.....	24
9.6 Call establishment failure	24
9.6.1 Preceding CC entity.....	24
9.6.2 Succeeding CC entity	24
9.7 Call clearing.....	25
9.7.1 Procedures at the CC entity that initiates call clearing	25
9.7.2 Procedures at the CC entity that responds to clearing	25
9.7.3 Call clearing collision.....	26
9.8 Exceptional procedures.....	26
9.8.1 Timer expiry	26
9.8.2 Receipt of APDUs with unknown Call Segment Id	26

	Page
9.8.3 Receipt of APDUs with duplicated Call Segment Id.....	26
9.8.4 Receipt of APDUs out of sequence	26
9.8.5 Receipt of reject APDUs	27
9.8.6 Handling of unrecognized parameters within CC-Operations.....	28
10 Parameter values (Timers)	28
11 Transport mechanism.....	29
12 SDL Diagrams	29
12.1 Outgoing CC-ASE	32
12.2 Incoming CC-ASE.....	38
Annex A – Bearer coordination requirements for CC signalling service users	47
A.1 Requirements at a CC entity that establishes a bearer towards an adjacent CC entity	47
A.2 Requirements at a CC entity that receives a bearer establishment from an adjacent CC entity	48
A.3 Additional requirements at a transit CC	49
A.4 Requirement on call clearing	49
Annex B – Call description handling requirements for CC signalling service users.....	49
B.1 Call description handling at a CC signalling service user within an originating CC entity	49
B.2 Call description handling at a CC signalling service user within a transit CC entity .	50
B.3 Call description handling at a CC signalling service user within a terminating CC entity	50
B.4 Call description errors.....	50
B.5 End-to-end relevant object handling at a CC signalling service user within a transit CC entity	51
B.6 Changes to the Information Model	51
B.6.1 Deletion of a Service Component Object.....	51
B.6.2 Addition of a Service Component Object.....	52
B.6.3 Changes to the attributes of the Party Object	52
B.6.4 Changes to the Open Call attribute of the Call Object	52
Annex C – Interworking	54
C.1 Interworking with networks not supporting separation of Call Control and Bearer Control	54
C.1.1 Outgoing call establishment	54
C.1.2 Incoming bearer establishment	54
C.1.3 Addition of bearers to an existing call.....	54
C.2 Interworking with simultaneous call and bearer establishment	54

	Page
C.2.1 Outgoing call establishment	54
C.2.2 Incoming call and bearer establishment.....	55
C.2.3 Addition of bearers to an existing call.....	55
Annex D – Transport mechanisms.....	55
D.1 Connection oriented-Bearer independent.....	55
D.2 Connectionless-Bearer independent.....	55
Appendix I – Information flow diagrams.....	56
I.1 Call Establishment using a two-message sequence	57
I.2 Call Establishment using a three-message sequence	58
I.3 Call Release	59
Appendix II – Imported ASN.1 definitions.....	59
Appendix III – Object identifiers defined in this Recommendation	61

Recommendation ITU-T Q.2981

BROADBAND INTEGRATED SERVICES DIGITAL NETWORK (B-ISDN) AND BROADBAND PRIVATE INTEGRATED SERVICES NETWORK (B-PISN) – CALL CONTROL PROTOCOL

(Geneva, 1999)

1 Scope

This Recommendation specifies a signalling protocol for the purpose of call control at the Q_B , S_B , T_B , and co-incident S_B/T_B reference points within, between, and at the access to Broadband Private Integrated Services Networks and within, between, and at the access to Broadband Integrated Services Digital Networks. The protocol operates between two adjacent call control entities. The protocol is applicable to a terminal or network node in a separated call and bearer (connection) control environment for the support of calls having none, a single bearer or multiple bearers. The protocol is applicable to a two-party call. The protocol also provides forward compatibility to the extent that an implementation can also operate within a multi-party call with other implementations that use additional capabilities, provided the implementation is deployed where it does not need to be aware of more than two parties.

This Recommendation is related to other Recommendations in this series which will describe the architecture of a separated call and bearer control environment and scenarios in which such an architecture can be applied.

The protocol specified in this Recommendation is independent of the supporting transport service.

The protocol specified in this Recommendation is independent of the protocol used for bearer establishment.

2 References

The following ITU-T Recommendations and other references contain provisions which, through reference in this text, constitute provisions of this Recommendation. At the time of publication, the editions indicated were valid. All Recommendations and other references are subject to revision; all users of this Recommendation are therefore encouraged to investigate the possibility of applying the most recent edition of the Recommendations and other references listed below. A list of the currently valid ITU-T Recommendations is regularly published.

- [1] ITU-T Recommendation X.680 (1997) | ISO/IEC 8824-1:1998, *Information technology – Abstract Syntax Notation One (ASN.1): Specification of basic notation.*
- [2] ITU-T Recommendation X.681 (1997) | ISO/IEC 8824-2:1998, *Information technology – Abstract Syntax Notation One (ASN.1): Information object specification.*
- [3] ITU-T Recommendation X.682 (1997) | ISO/IEC 8824-3:1998, *Information technology – Abstract Syntax Notation One (ASN.1): Constraint specification.*
- [4] ITU-T Recommendation X.683 (1997) | ISO/IEC 8824-4:1998, *Information technology – Abstract Syntax Notation One (ASN.1): Parameterization of ASN.1 specifications.*
- [5] ITU-T Recommendation X.690 (1997) | ISO/IEC 8825-1:1998, *Information technology – ASN.1 encoding rules: Specification of Basic Encoding Rules (BER), Canonical Encoding Rules (CER) and Distinguished Encoding Rules (DER).*

- [6] ITU-T Recommendation X.880 (1994) | ISO/IEC 13712:1995, *Information technology – Remote operations: Concepts, model and notation*.
- [7] ITU-T Recommendation Z.100 (1993), *CCITT specification and description language*.
- [8] ITU-T Recommendation Q.2932.1 (1996), *Digital subscriber signalling system No. 2 – Generic functional protocol: Core functions*.
- [9] ITU-T Recommendation Q.932 (1998), *Digital subscriber signalling system No. 1 – Generic procedures for the control of ISDN supplementary services*.

3 Definitions

This Recommendation defines the following terms:

- 3.1 call:** An association between two or more users using a telecommunication service to communicate through one or more networks.
- 3.2 call segment:** A part of a call located between two adjacent call control entities.
- 3.3 call control:** Functionality and signalling in and between networks and terminals to effect the control of a call, excluding the control of individual bearers.
- 3.4 call control entity (CC entity):** An entity that is located in a terminal or a network and that participates in call control.
- 3.5 bearer control:** Functionality and signalling in and between networks and terminals to effect the control of a bearer, that bearer being part of a call.
- 3.6 bearer control entity (BC entity):** An entity that is located in a terminal or a network and that participates in bearer control.
- 3.7 bearer:** A connection for the transport of user plane information between users involved in a call.
- 3.8 adjacent call control entities (adjacent CC entities):** Within the context of a single call, two CC entities that signal directly to each other with no intervening CC entity.
- 3.9 preceding CC entity:** The CC entity that initiates call establishment across a given call segment.
- 3.10 succeeding CC entity:** The CC entity at the opposite end of a call segment from the preceding CC entity.
- 3.11 originating CC entity:** The CC entity that initiates call establishment and is located in a terminal or equipment that functions like a terminal (e.g. a server in the network).
- 3.12 terminating CC entity:** The CC entity to which call establishment is directed and that is located in a terminal or equipment that functions like a terminal.
- 3.13 transit CC entity:** A CC entity through which a call passes, excluding the originating and terminating CC entity.
- 3.14 call control signalling service provider:** An entity which provides the signalling services of call control.
- 3.15 call control signalling service user:** An entity within the CC entity to which the signalling services of call control are provided.

NOTE – The call control signalling service user performs the Call Description handling, provides the interactions with bearer control, and in a network node, coordinates the incoming and outgoing side of the CC entity (Figure 6).

- 3.16 information model:** A representation of the service and abstract communications configuration using an object oriented technique.
- 3.17 party:** An addressable signalling endpoint.
- 3.18 calling party:** The party which initiates the call establishment.
- 3.19 called party:** Any party in a call other than the calling party.

4 Abbreviations

This Recommendation uses the following abbreviations:

APDU	Application Protocol Data Unit
ASN.1	Abstract Syntax Notation One
B-ISDN	Broadband Integrated Services Digital Network
B-PISN	Broadband Private Integrated Services Network
BC	Bearer Control
CC	Call Control
M	Mandatory
O	Optional
PDU	Protocol Data Unit
ROSE	Remote Operation Service Element

5 Basic model

5.1 Separation of call control and bearer control

The protocol specified in this Recommendation is applicable to an environment in which the control of a call is separate from the control of the bearer or bearers that exist within the context of that call.

In order for two users to communicate using a telecommunication service, an association, or call, is established between the two users. Within the context of the call, one or more bearers can be established for transporting user plane information between the users. However, bearers are not normally established until the call has been accepted by the called terminal, and therefore resources required by bearers are not occupied unnecessarily if the call cannot be established, e.g. if the called terminal is unable to accept the call because resources are not available. During the lifetime of the call, bearers can be added or cleared down as required. The call is terminated by one of the two users when there is no further need for communication. Termination of the call implies that all bearers (if any) are cleared down.

Although for some telecommunication services a single bearer is sufficient, other telecommunication services benefit from the use of multiple bearers, each tailored to suit the characteristics of the user plane information to be transported. This is particularly true for multimedia applications involving audio, video and data. The call provides a context in which the various bearers can exist and a means of binding the bearers together.

5.2 Point-to-point and multi-party call control

In a point-to-point configuration the protocol specified in this Recommendation operates between any two adjacent call control entities between the calling party and the called party.

In a multi-party configuration the protocol specified in this Recommendation operates between any two adjacent call control entities on the point-to-point leg between a coordination point in the network and a called party. In this case, a network node in the calling party's network takes responsibility for coordinating the responses from multiple point-to-point signalling associations to the called parties into one signalling association to the calling party. Enhancements to be made to the Call Control protocol in order to make it suitable also for this signalling association to the calling party in case of a multi-party call are outside the scope of this Recommendation.

Figure 1 shows an example configuration for a multi-party call with two called parties involved.

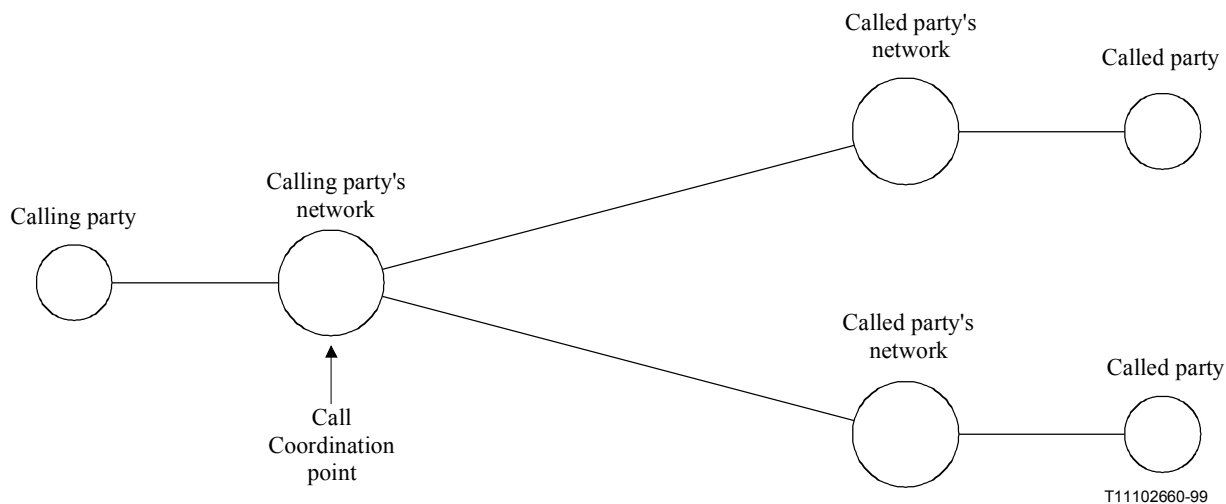

Figure 1/Q.2981 – Multi-party call with two called parties

5.3 Call control architecture

Call control provides the means of establishing, maintaining and clearing down a call, including the operation of any supplementary services that relate to the call rather than to individual bearers. Control of a call is effected by means of a number of call control entities (CC entities) located in the users' terminals and in various network nodes. Whereas bearer control involves a bearer control entity (BC entity) at each network node through which a bearer passes, call control requires a CC entity only at those network nodes that provide call-related functionality, e.g. the nodes serving the terminals concerned or nodes that, in the context of the call, provide interworking between networks. In particular, CC entities are not required at nodes that would only provide transit functionality. The precise criteria for determining whether a network node needs to provide CC functionality for a given call are outside the scope of this Recommendation.

The various CC entities involved in a given call are linked in series by signalling associations. These CC entities and signalling associations are created during call establishment and cleared down when the call is cleared down. The protocol specified in this Recommendation provides such an association between adjacent CC entities and conveys call-related signalling information between those CC entities. That part of a call between two CC entities that communicate directly via a single signalling association is known as a call segment. This is illustrated in Figure 2 for a call that involves four CC entities (e.g. one at each terminal and one at each node serving those terminals) and consequently three call segments.

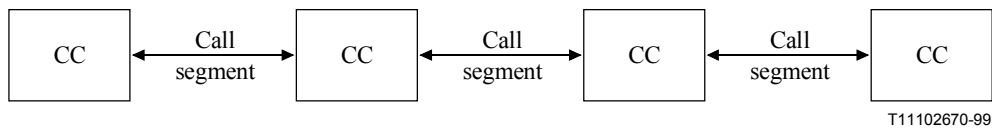

Figure 2/Q.2981 – Call Control involving four CC entities (three call segments)

5.4 Relationship to bearer control architecture

Bearer control requires functionality, and hence a BC entity, at each terminal and at every network node through which the bearer is routed. This is in contrast to call control, which involves a CC entity only at the terminals and selected network nodes. Each bearer can be routed independently of other bearers and independently of the routing of call control signalling associations. However, each bearer is required to be routed through each network node at which there is a CC entity, and hence have a BC entity at each of these nodes, so that the CC entity can manage the bearer if required. This is illustrated in Figure 3 for the same call as in Figure 2 and a single bearer that has a BC entity collocated with each CC entity and an additional BC entity (e.g. at a transit node) located between the second and third CC entities.

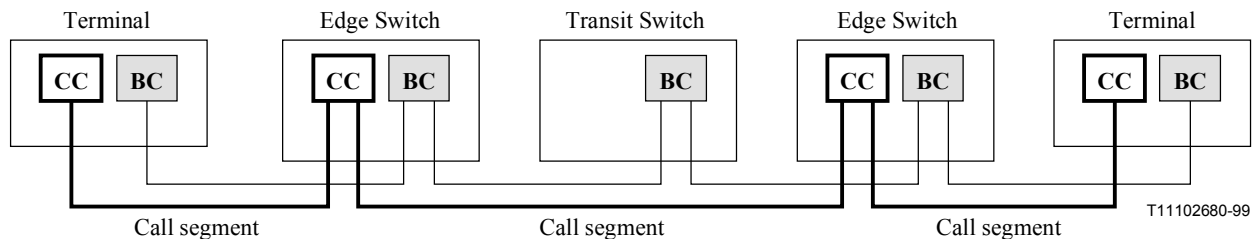

Figure 3/Q.2981 – Relationship of call control and bearer control architecture

NOTE – Signalling between BC entities is outside the scope of this Recommendation.

5.5 Screening function

The model for call and bearer control functional entities (Figure 3) shows all call control (CC) entities existing at the same location as bearer control (BC) entities. While bearer control can exist independently of call control, the opposite does not apply. Each CC entity includes bearer coordination capabilities.

Although at network boundaries, CC entities will normally be present, network boundaries can also be crossed without provision of a CC entity and the connections associated with those calls can be routed differently from each other and from the call, thereby crossing network boundaries at different locations or even being routed through different networks.

Where a call crosses a network boundary, a number of functions will need to be performed within call control that do not require the presence of a connection. These include:

- a) Service control. Control of the provision of basic and supplementary services, and subscription arrangements. Identification of correct service profile.
- b) Translation of numbering plans where the two networks use different numbering plans (e.g. public to private). Even where the same numbering plan is used, the addition of the country code may be necessary.
- c) Provision of some supplementary services that provide security control on a network basis, e.g. closed user group.

- d) Support of supplementary services related to numbering (e.g. DDI, MSN) and restriction of numbers (CLIR, COLR).

The functions listed above are outside the scope of this Recommendation.

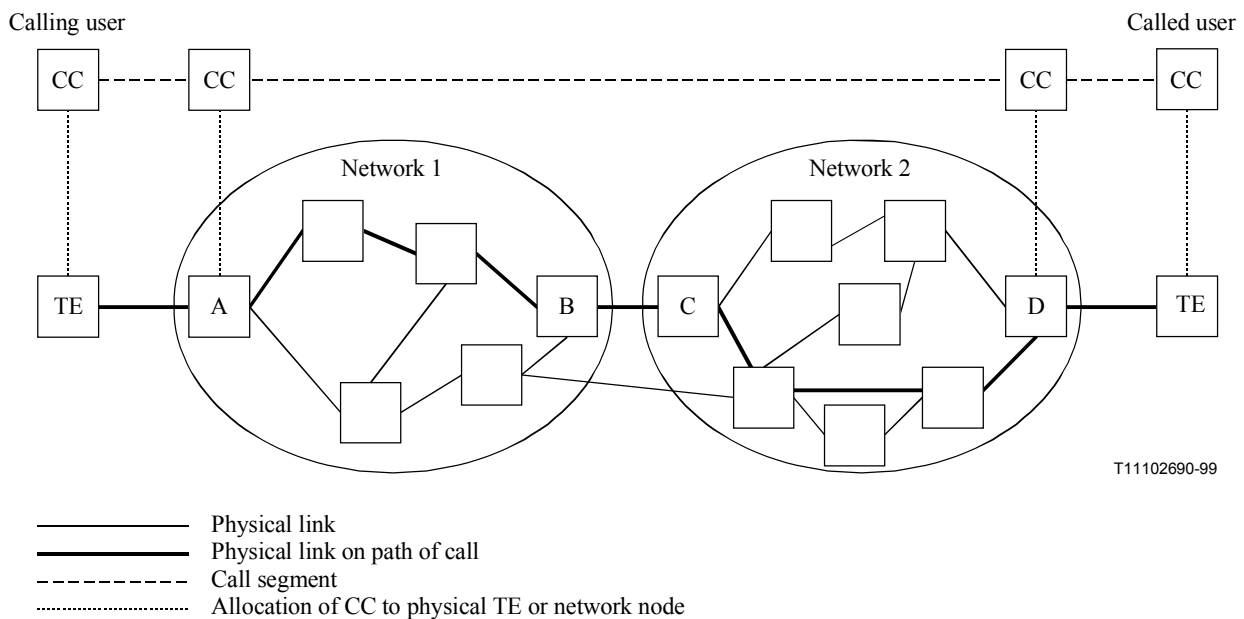

Figure 4/Q.2981 – Call originating and terminating in different networks

Figure 4 shows an example of a call originating and terminating in different networks. If calling line identification restriction (CLIR) applies to the call, this information will be known at the CC at node A, which can add a presentation restricted indicator to the calling party number forwarded on across the next call segment. Normally, on exit from one network to another, a calling party number with an associated presentation restricted indicator is not forwarded, but instead just the presentation restricted indicator is forwarded. The absence of a CC at node B (point of egress to network 2) means that there will be no opportunity to filter out the calling party number until the CC at node D is reached. This is clearly insecure.

Possible alternatives are:

- 1) Ensure that there is a CC at node B (and similarly at node C to handle this type of situation in the reverse direction). However, CCs are points of bearer coordination, and the presence of CCs at nodes B and C would force all bearers to go via nodes B and C. This would deny the possibility of using other routes between the two networks. For some bearers, the route via nodes B and C might not be the cheapest, or may be congested, or may not provide the desired quality of service. It is desirable to minimize the number of CCs in order to provide maximum flexibility for routing bearers.
- 2) Ensure that the CC at node A performs the filtering. However, this requires node A to have knowledge that the call segment leads to another network. This knowledge may not always be available.

To solve the problem without introducing the disadvantages of alternatives 1 and 2, filtering (screening) functionality may be provided at node B (and node C). A functional entity (screening function) may optionally appear between call control entities, and is located as necessary at incoming and outgoing gateways between networks. Figure 5 shows an example.

The screening functional entity has no impact on the information flows, except that this functional entity may impose itself as a transit point on an existing flow.

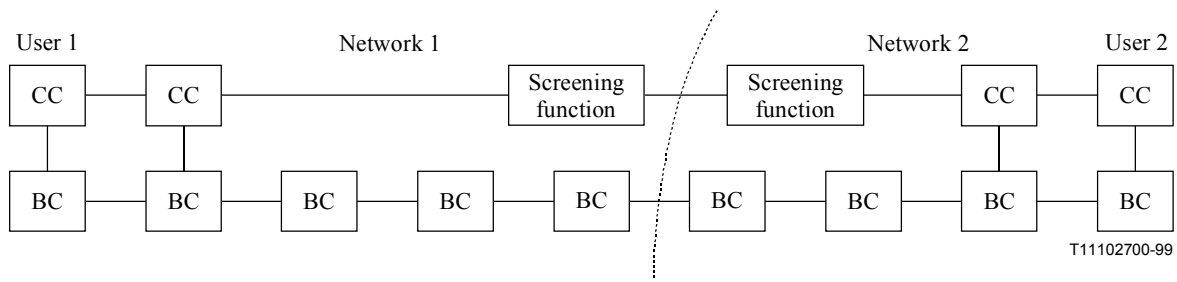

Figure 5/Q.2981 – Screening functional entities at network boundaries

6 Operational requirements

6.1 Provision and withdrawal

The provision of this capability within a network is a network provider option.

The provision of this capability between networks or between a network and a user is by bilateral agreement.

6.2 Transport mechanism

The choice of the underlying transport mechanism within a network is a network provider option.

The choice of the transport mechanism between networks or between a network and a user is by bilateral agreement.

7 Primitive definitions and state definitions

7.1 Service primitives

7.1.1 Service primitive architecture

The following services for call establishment and release are defined:

ESTABLISH-CALL	confirmed
RELEASE-CALL	confirmed
COMPLETE-CALL	unconfirmed
STATUS-CALL	unconfirmed
PROCEED-CALL	unconfirmed
ERROR	indication

Figure 6 shows the architecture which is assumed for two concatenated call segments.

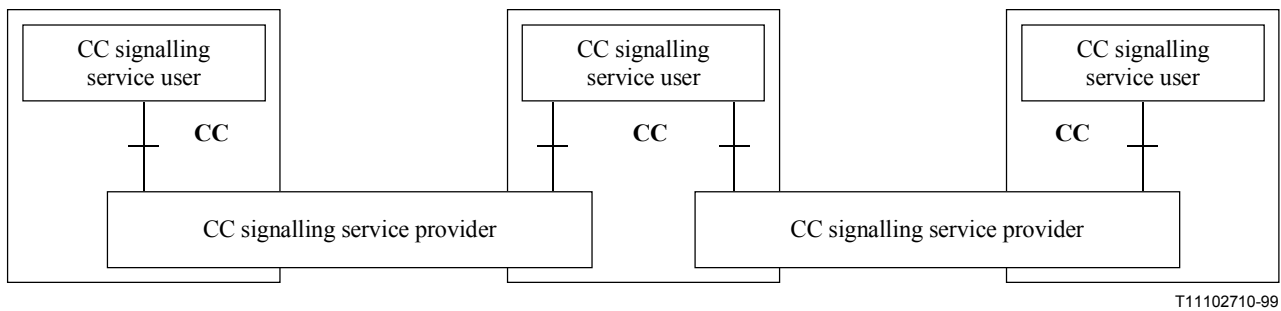

Figure 6/Q.2981 – Architecture

7.1.2 ESTABLISH-CALL

This service is used by the call control signalling service user to establish a call and its information model. It is a confirmed service. See Figure 7. Table 1 shows the parameters of the ESTABLISH-CALL primitive.

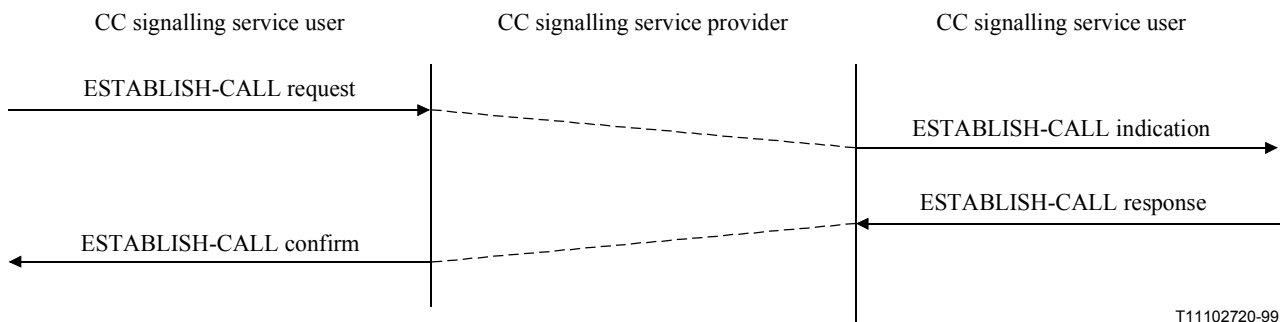

Figure 7/Q.2981 – ESTABLISH-CALL service

Table 1/Q.2981 – ESTABLISH-CALL parameters

Parameter name	request	indication	response	confirmation
Call segment ID	M	M	M	M
Bearer establishment address	M	M	O	O
Await complete indicator	M	M	–	–
Call description	M	M	O (Note)	O (Note)
Result	–	–	M	M
Diagnostics	–	–	M	M

NOTE – Mandatory if Result is positive, else optional.

7.1.3 COMPLETE-CALL

This service is used by the call control signalling service user to complete establishment of a call and its information model. It is an unconfirmed service. See Figure 8. Table 2 shows the parameters of the COMPLETE-CALL primitive.

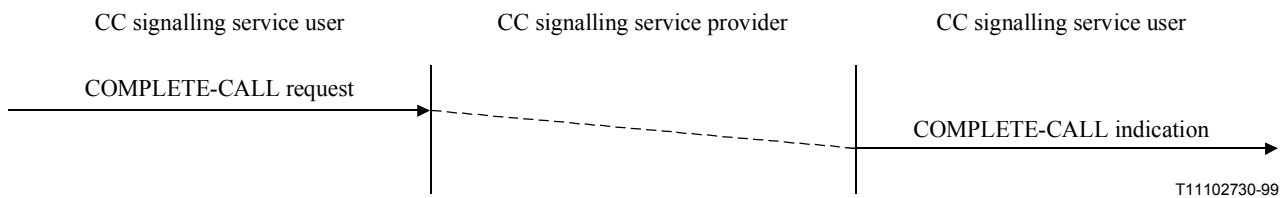

Figure 8/Q.2981 – COMPLETE-CALL service

Table 2/Q.2981 – COMPLETE-CALL parameters

Parameter name	request	indication
Call segment ID	M	M

7.1.4 STATUS-CALL

This service is used by the call control signalling service user to report a change to the information model. It is an unconfirmed service. See Figure 9. Table 3 shows the parameters of the STATUS-CALL primitive.

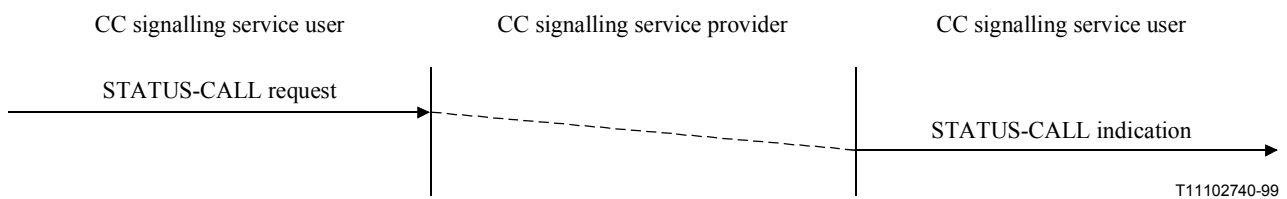

Figure 9/Q.2981 – STATUS-CALL service

Table 3/Q.2981 – STATUS-CALL parameters

Parameter name	request	indication
Call segment ID	M	M
Call changed parameter	M	M

7.1.5 RELEASE-CALL

This service is used by the call control signalling service user to release a call and its information model. It is a confirmed service. See Figure 10. Table 4 shows the parameters of the RELEASE-CALL primitive.

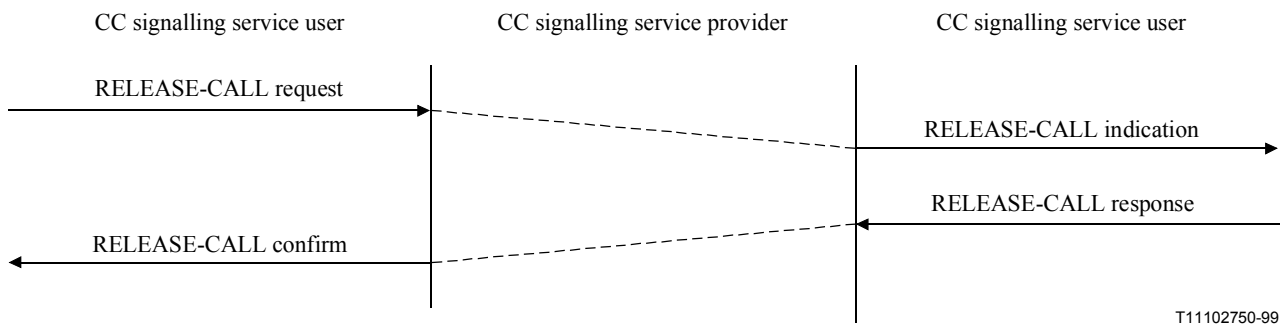

Figure 10/Q.2981 – RELEASE-CALL service

Table 4/Q.2981 – RELEASE-CALL parameters

Parameter name	request	indication	response	confirmation
Call segment ID	M	M	M	M
Release cause	M	M	–	–

7.1.6 PROCEED-CALL

This service is used by the call control signalling service user to indicate receipt of a call at the succeeding side of a call segment. It is an unconfirmed service. See Figure 11. Table 5 shows the parameters of the PROCEED-CALL primitive.

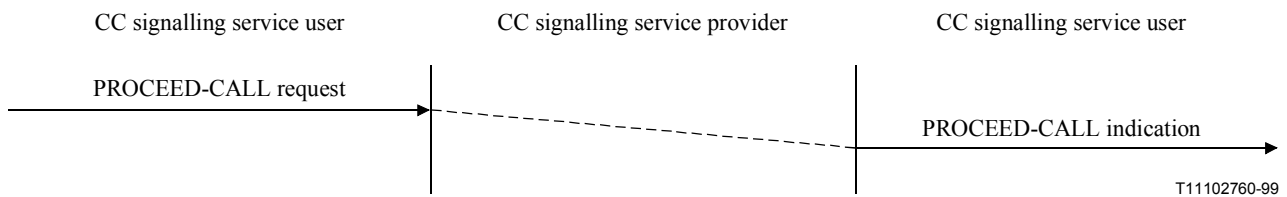

Figure 11/Q.2981 – PROCEED-CALL service

Table 5/Q.2981 – PROCEED-CALL parameters

Parameter name	request	indication
Call segment ID	M	M
Bearer establishment address	M	M

7.1.7 ERROR

This indication primitive is used by the call control signalling service provider to indicate the occurrence of an exceptional condition to the call control signalling service user. Table 6 shows the parameters of the ERROR indication primitive.

Table 6/Q.2981 – ERROR parameters

Parameter name	indication
Call segment ID	M
Diagnostics	M

7.2 Parameters

7.2.1 Call segment ID

A pair of values which together uniquely identify the call at the two adjacent CC entities bounding a call segment.

7.2.2 Call description

The type CallDescription, as used in the operation callEstablish, contains an information model which describes the properties of a call. The information model comprises sequences of network relevant and end-to-end relevant object descriptions. An object description consists of:

- an object reference, used to refer to particular instances of objects, which should therefore be unique within a particular call description;
- an object status, which is used for example to indicate whether the object is optional or mandatory;
- an identifier that identifies the class of object to which the instance belongs; and
- an argument of type specific to the class of object to which the instance belongs.

A call control object class is a class of object that inherits the properties of the super class CALLCONTROBJECT. Each object class in this super class comprises an identifier and an optional argument. The type of the argument depends on the particular object class in the super class, as identified by the identifier. The argument defines the type of attributes of an object of this class.

The OpenCall parameter indicates to the non-call owners in a communications configuration their rights to modify the configuration. The OpenCall parameter is an attribute of the call that is set by the user (call control signalling service user); it is stored in the information model and is transferred in the call description. The call control protocol provides the procedures for exchanging information in an orderly manner. The call status change report provides the mechanism for informing all call control signalling service users involved in the call of one or more changes in the call permissions.

7.2.3 Call changed parameter

The type CallChangedParameter, as used in the operation callStatus, contains a list of those objects of the information model which have been modified and the modification of which has to be reported to the other call control signalling service users involved in the call.

7.2.4 Await complete indicator

Has the value TRUE if call and information model establishment uses a three-message sequence or FALSE if call and information model establishment uses an two-message sequence.

7.2.5 Bearer establishment address

The address of a network node/terminal to which bearer (connection) establishment shall be routed.

7.2.6 Release cause

Reason for a call release request.

7.2.7 Result

Positive/negative result for an ESTABLISH-CALL request or indication.

7.2.8 Diagnostics

Further explanation of the result (e.g. error values) in an ESTABLISH-CALL response/confirm or the explanation of the exceptional condition that caused an ERROR indication.

7.3 Call control states

This subclause describes the states which exist for a CC signalling service provider within a CC entity.

7.3.1 Call Idle

No call exists.

7.3.2 Call Initiated

This state exists at a preceding CC entity when a request for call establishment has been sent to the succeeding CC entity but no response has been received.

7.3.3 Outgoing Call Proceeding

This state exists at a preceding call control entity when acknowledgement that the call is accepted for this call segment has been received from the succeeding call control entity.

7.3.4 Call Ready

This state exists at a preceding call control entity when an indication has been received from the succeeding CC entity that it is ready to complete the establishment of the call and its information model.

7.3.5 Call Present

This state exists at a succeeding call control entity that has not yet responded to the request for call establishment.

7.3.6 Incoming Call Proceeding

This state exists at a succeeding call control entity that has sent to the preceding call control entity acknowledgement that the call is accepted for this call segment.

7.3.7 Await Call Completion

This state exists at a succeeding call control entity that is awaiting an indication from the preceding CC entity that establishment of the call and its information model is to be completed.

7.3.8 Call Active

This state exists at a preceding call control entity that has received an indication that the called user has answered from the succeeding call control entity. This state exists at a succeeding call control entity that has sent an indication that the called user has answered to the preceding call control entity.

7.3.9 Call Release Request

This state exists when a call control entity has sent out a request for call release but a response has not yet been received.

7.3.10 Call Release Indication

This state exists when a call control entity has received a call release indication but the user has not yet answered.

8 Coding requirements

8.1 Abstract definition of the call control operations

Table 7 shows the definition of the operations, errors and types required for the Call Control protocol using ASN.1 as defined in ITU-T Recommendations X.680, X.681, X.682 and X.683 and using the OPERATION and ERROR object classes as defined in ITU-T Recommendation X.880.

APDUs based on these operations shall be of types invoke, returnResult, returnError and reject as defined in Table B.1/Q.2932.1. The Basic Encoding Rules (BER) as defined in ITU-T Recommendation X.690 shall be applied to the encoding of APDUs based on these operations and errors.

Table 7/Q.2981 – Definition of operations for the Call Control protocol

```
CC-Operations {itu-t recommendation q 2981 cc-operations(1)} DEFINITIONS
AUTOMATIC TAGS ::=
BEGIN

EXPORTS CcOperations, CallSegmentId;

IMPORTS
  OPERATION, ERROR
  FROM Remote-Operations-Information-Objects {joint-iso-itu-t(2)
    remote-operations(4) informationObjects(5) version1(0)}
  PartyNumber
  FROM Addressing-Data-Elements {itu-t recommendation q 932
    addressing-data-elements(7)}
  -- The definition of PartyNumber is reproduced in Appendix II
  CALLCONTROBJECTCLASS
  FROM Call-Control-Object-Super-Class {itu-t recommendation q
    2981 call-control-object-super-class(4)}
  -- The definition of CALLCONTROBJECTCLASS is given in subclause 8.2
  call, localPartyEP, remotePartyEP, directCallAssociation,
  remoteCallAssociation, serviceComponent
  FROM Call-Object-Class-Definitions {itu-t recommendation q 2981
    call-object-class-definitions(5)};

-- The definition of call, localPartyEP, remotePartyEP, directCallAssociation,
remoteCallAssociation,
-- serviceComponent is given in subclause 8.3
CcOperations OPERATION ::=
  {callEstablish | callProceeding | callComplete | callRelease |
  callStatus}

ccOperationsDefinitions OBJECT IDENTIFIER ::=
  {itu-t recommendation q 2981 cc-operations-definitions(2)}

-- The callEstablish operation is used to establish a call and its information
model. It is a confirmed operation.
callEstablish OPERATION ::= {
  ARGUMENT
    SEQUENCE {callSegmentId          CallSegmentId,
              callDescription        CallDescription,
```

```

        bearerEstablAddress      BearerEstablishmentAddress,
        awaitCompleteIndicator   BOOLEAN,
        parameterActionIndicator ParameterActionIndicator,
        ...}
RESULT
  SEQUENCE {callSegmentId      CallSegmentId,
            callDescription     CallDescription,
            parameterActionIndicator ParameterActionIndicator,
            bearerEstablAddress BearerEstablishmentAddress OPTIONAL,
            ...}
ERRORS
  {callDescriptionNotAccepted | unallocatedNumber |
   noUserResponding | noAnswerFromUser | callRejected |
   destinationOutOfOrder | addressIncomplete | networkOutOfOrder |
   temporaryFailure | userBusy | userNotReachable | unspecified}
CODE      global:{ccOperationsDefinitions 1}}

-- The callProceeding operation is used by the succeeding call control entity to
inform the preceding call control entity
-- that the call is in progress and connection establishment may start for this
segment. It is an unconfirmed operation.
callProceeding OPERATION ::= {
  ARGUMENT
    SEQUENCE {callSegmentId      CallSegmentId,
              bearerEstablAddress BearerEstablishmentAddress,
              parameterActionIndicator ParameterActionIndicator,
              ...}
  RETURN RESULT      FALSE
  ALWAYS RESPONDS    FALSE
  CODE                global:{ccOperationsDefinitions 2}}

-- The callRelease operation is used to release an existing call and its
information model. It is a confirmed operation.
callRelease OPERATION ::= {
  ARGUMENT
    SEQUENCE {callSegmentId      CallSegmentId,
              releaseCause       ReleaseCause,
              parameterActionIndicator ParameterActionIndicator,
              ...}
  RESULT
    SEQUENCE {callSegmentId      CallSegmentId,
              parameterActionIndicator ParameterActionIndicator,
              ...}
  CODE      global:{ccOperationsDefinitions 3}}

-- The callComplete operation is used to indicate completion of establishment of
a call and its information model.
-- It is an unconfirmed operation.
callComplete OPERATION ::= {
  ARGUMENT
    SEQUENCE {callSegmentId      CallSegmentId,
              parameterActionIndicator ParameterActionIndicator,
              ...}
  RETURN RESULT      FALSE
  ALWAYS RESPONDS    FALSE
  CODE                global:{ccOperationsDefinitions 4}}

-- The callStatus operation is used to report a change to the information model.
It is an unconfirmed operation.
callStatus OPERATION ::= {
  ARGUMENT
    SEQUENCE {callSegmentId      CallSegmentId,
              callChangedParameter

```

```

        SEQUENCE OF CallChangedParameter,
        parameterActionIndicator ParameterActionIndicator,
        ...}
RETURN RESULT FALSE
ALWAYS RESPONDS FALSE
CODE global:{ccOperationsDefinitions 5}}

ParameterActionIndicator ::= ENUMERATED {
    clearCallAndItsInformationModel(0), discardApduAndReject(1),
    discardApduNoReject(2),
    discardParameterAndPassApduToApplication(3),
    ignoreParameterAndPassApduToApplication(4)}

-- Used to indicate action to be taken if a parameter in an operation is not
-- recognized
BearerEstablishmentAddress ::=
    PartyNumber

NetworkRelevantObjectClassSet CALLCONTROBJECTCLASS ::=
    {call | localPartyEP | remotePartyEP | directCallAssociation |
    remoteCallAssociation, ...}

EndToEndRelevantObjectClassSet CALLCONTROBJECTCLASS ::=
    {serviceComponent, ...}

CallDescription ::= SEQUENCE {
    networkRelevantPart
        SEQUENCE OF
            NetworkRelevantObjectDescription{{NetworkRelevantObjectClassSet}},
    endToEndRelevantPart
        SEQUENCE OF
            EndToEndRelevantObjectDescription{{EndToEndRelevantObjectClassSet}}
        OPTIONAL}

NetworkRelevantObjectDescription{CALLCONTROBJECTCLASS:NetworkRelevantObjectClassSet}
 ::= SEQUENCE {
    objectReference INTEGER,
    objectActionInd ObjectActionIndicator,
    objectStatus ObjectStatus,
    objectClassId
        CALLCONTROBJECTCLASS.&objectClassIdentifier
        ({NetworkRelevantObjectClassSet}),
    objectArgument
        CALLCONTROBJECTCLASS.&ArgumentType
        ({NetworkRelevantObjectClassSet}{@objectClassId}) OPTIONAL,
    ...}

EndToEndRelevantObjectDescription{CALLCONTROBJECTCLASS:EndToEndRelevantObjectClassSet}
 ::= SEQUENCE {
    objectReference INTEGER,
    objectActionInd ObjectActionIndicator,
    objectStatus ObjectStatus,
    objectClassId
        CALLCONTROBJECTCLASS.&objectClassIdentifier
        ({EndToEndRelevantObjectClassSet}),
    objectArgument
        CALLCONTROBJECTCLASS.&ArgumentType
        ({EndToEndRelevantObjectClassSet}{@objectClassId}) OPTIONAL,
    ...}

CallChangedParameter ::= SEQUENCE {
    modifiedNetworkRelevantPart

```

```

SEQUENCE OF
  ModifiedNetworkRelevantObjectDescription{{NetworkRelevantObjectClassSet}},
modifiedEndToEndRelevantPart
SEQUENCE OF
  ModifiedEndToEndRelevantObjectDescription{{EndToEndRelevantObjectClassSet}}
  OPTIONAL}

ModifiedNetworkRelevantObjectDescription{CALLCONTROBJECTCLASS:NetworkRelevantOb
jectClassSet}
 ::= SEQUENCE {
  operation
    ENUMERATED {deleteObject(0), modifyAttributes(1), ...
    },
  objectReference    INTEGER,
  objectActionInd   ObjectActionIndicator,
  modifiedArgument
    CALLCONTROBJECTCLASS.&ArgumentType
    ({NetworkRelevantObjectClassSet}) OPTIONAL}

ModifiedEndToEndRelevantObjectDescription{CALLCONTROBJECTCLASS:EndToEndRelevant
ObjectClassSet}
 ::= SEQUENCE {
  operation
    ENUMERATED {deleteObject(0), modifyAttributes(1), ...
    },
  objectReference    INTEGER,
  objectActionInd   ObjectActionIndicator,
  modifiedArgument
    CALLCONTROBJECTCLASS.&ArgumentType
    ({EndToEndRelevantObjectClassSet}) OPTIONAL}

ObjectActionIndicator ::= ENUMERATED {
  clearCall(0), discardNotify(1), discardUnknown(2),
  progressTransit(3), ...
}

-- Used to indicate action to be taken if an object or object attribute is not
recognized
ObjectStatus ::= ENUMERATED {
  mandatory(0), optional(1), conditional(2), ...
}

CallSegmentId ::= SEQUENCE {
  precedingSideCallSegId  CallSegmentIdComponent,
  succeedingSideCallSegId CallSegmentIdComponent}

CallSegmentIdComponent ::=
  INTEGER(-2147483648..2147483647) -- 4 octets

-- The value 0 is to be used as a null value for the succeeding side call segment
identifier
-- in the callEstablish invoke APDU.
ReleaseCause ::= SEQUENCE {
  causeValue CauseValue,
  location    Location,
  ...}

CauseValue ::= ENUMERATED {
  callDescriptionNotAccepted(0), normalCallClearing(3),
  temporaryFailure(11), recoveryOnTimerExpiry(12), unspecified(4),
  ...
}

```



```

Location ::= ENUMERATED {
    unspecified(0), user(1), networkLocalCallSegment(2),
    networkNonLocalCallSegment(3), ...
}

ccOperationsErrors OBJECT IDENTIFIER ::=
    {itu-t recommendation q 2981 cc-operations-errors(3)}

callDescriptionNotAccepted ERROR ::= {
    PARAMETER
        SEQUENCE {callSegmentId    CallSegmentId,
                  location          Location,
                  callDescription  CallDescription OPTIONAL,
                  ...}
    CODE          global:{ccOperationsErrors 1}}

userBusy ERROR ::= {
    PARAMETER
        SEQUENCE {callSegmentId    CallSegmentId,
                  location          Location,
                  callDescription  CallDescription OPTIONAL,
                  ...}
    CODE          global:{ccOperationsErrors 2}}

unallocatedNumber ERROR ::= {
    PARAMETER
        SEQUENCE {callSegmentId    CallSegmentId,
                  location          Location,
                  ...}
    CODE          global:{ccOperationsErrors 3}}

noUserResponding ERROR ::= {
    PARAMETER
        SEQUENCE {callSegmentId    CallSegmentId,
                  location          Location,
                  ...}
    CODE          global:{ccOperationsErrors 4}}

noAnswerFromUser ERROR ::= {
    PARAMETER
        SEQUENCE {callSegmentId    CallSegmentId,
                  location          Location,
                  ...}
    CODE          global:{ccOperationsErrors 5}}

callRejected ERROR ::= {
    PARAMETER
        SEQUENCE {callSegmentId    CallSegmentId,
                  location          Location,
                  ...}
    CODE          global:{ccOperationsErrors 6}}

destinationOutOfOrder ERROR ::= {
    PARAMETER
        SEQUENCE {callSegmentId    CallSegmentId,
                  location          Location,
                  ...}
    CODE          global:{ccOperationsErrors 7}}

addressIncomplete ERROR ::= {
    PARAMETER
        SEQUENCE {callSegmentId    CallSegmentId,
                  location          Location,
                  ...}

```

```

CODE          global:{ccOperationsErrors 8}}

networkOutOfOrder ERROR ::= {
  PARAMETER
    SEQUENCE {callSegmentId  CallSegmentId,
              location        Location,
              ...}
  CODE          global:{ccOperationsErrors 9}}

temporaryFailure ERROR ::= {
  PARAMETER
    SEQUENCE {callSegmentId  CallSegmentId,
              location        Location,
              ...}
  CODE          global:{ccOperationsErrors 10}}

userNotReachable ERROR ::= {
  PARAMETER
    SEQUENCE {callSegmentId  CallSegmentId,
              location        Location,
              ...}
  CODE          global:{ccOperationsErrors 11}}

unspecified ERROR ::= {
  PARAMETER
    SEQUENCE {callSegmentId  CallSegmentId,
              location        Location,
              ...}
  CODE          global:{ccOperationsErrors 12}}

END

```

8.2 Definition of Call Control Object Super Class

Table 8 shows the definition of the Call Control Object Super Class using ASN.1 as defined in ITU-T Recommendations X.680, X.681, X.682 and X.683.

Table 8/Q.2981 – Definition of Call Control Object Super Class

```

BEGIN

EXPORTS CALLCONTROBJECTCLASS;

CALLCONTROBJECTCLASS ::= CLASS {
  &ArgumentType          OPTIONAL,
  &argumentTypeOptional  BOOLEAN OPTIONAL,
  &objectClassIdentifier OBJECT IDENTIFIER UNIQUE}
WITH SYNTAX {
  [ARGUMENT &ArgumentType
  [OPTIONAL &argumentTypeOptional]]
  IDENTIFIER &objectClassIdentifier}

END -- Call-Control-Object-Super-Class

```

8.3 Definitions of Call Control Object Classes in the Information Model

Call control object classes are inherited from the super class CALLCONTROBJECTCLASS, used for the purpose of object descriptions within the call description. For each object class, the ARGUMENT type and unique IDENTIFIER are defined.

Table 9 shows the definition of the Call Control Object Classes in the information model using ASN.1 as defined in ITU-T Recommendations X.680, X.681, X.682 and X.683.

Table 9/Q.2981 – Definition of Call Control Object Classes in the Information Model

```

BEGIN

EXPORTS
    call, localPartyEP, remotePartyEP, directCallAssociation,
        remoteCallAssociation, serviceComponent, BearerId;

IMPORTS
    CALLCONTROBJECTCLASS
        FROM Call-Control-Object-Super-Class {itu-t recommendation q
            2981 call-control-object-super-class(4)}
    PresentedAddressScreened, PartyNumber, PartySubaddress
        FROM Addressing-Data-Elements {itu-t recommendation q 932
            addressing-data-elements(7)};

ccObjectClasses OBJECT IDENTIFIER ::=
    {itu-t recommendation q 2981 cc-object-classes(6)}

call CALLCONTROBJECTCLASS ::= {
    ARGUMENT
        SEQUENCE {localPEPID                ObjectReferenceId,
                    remotePEPID            ObjectReferenceId,
                    serviceReference        ObjectReferenceId OPTIONAL,
                    directCallAssociationIds ObjectReferenceIdList,
                    remoteCallAssociationIds
                        ObjectReferenceIdList OPTIONAL,
                    bearerIdList           BearerIdList OPTIONAL,
                    telecomsServiceType     TelecomsServiceType,
                    callPermissions         OpenCall}
    IDENTIFIER {ccObjectClasses 1}}

ObjectReferenceId ::= INTEGER(-2147483648..2147483647) -- 4 octets

-- refers to an object reference, unique to each object within a call
ObjectReferenceIdList ::= SEQUENCE OF ObjectReferenceId

BearerIdList ::= SEQUENCE OF BearerId

BearerId ::= OCTET STRING(SIZE (1..3))

OpenCall ::= BIT STRING {
    reserved(7), externalPartyAddAllowed(6),
    existingPartyAddAllowed(5), notifyAllPartiesFlag(4),
    notifyOwnerFlag(3), permissionRequiredFlag(2),
    addConnectionAllowed(1), addServiceComponentAllowed(0)}

TelecomsServiceType ::= ENUMERATED {
    realtimeMultiMedia(0), nonRealtimeMultiMedia(1), unspecified(2),
    ...
}

localPartyEP CALLCONTROBJECTCLASS ::= {
    ARGUMENT PartyObjectArgument
    IDENTIFIER {ccObjectClasses 2}}

```

```

remotePartyEP CALLCONTROBJECTCLASS ::= {
  ARGUMENT PartyObjectArgument
  IDENTIFIER {ccObjectClasses 3}}

PartyObjectArgument ::= SEQUENCE {
  partyAddress
    SEQUENCE {presentedAddressScreened PresentedAddressScreened,
              defaultAddress          DefaultAddress OPTIONAL,
              networkInternalAddress
                NetworkInternalAddress OPTIONAL},
  partyOwnerPEPId          ObjectReferenceId,
  associatedResourcePEPIds ObjectReferenceIdList OPTIONAL,
  associatedPEPIds         ObjectReferenceIdList OPTIONAL,
  partyType
    ENUMERATED {initiator(0), receiver(1), callOwner(2), ...
    },
  partyStatus
    ENUMERATED {confirmed(0), virtual(1), alerting(2), ...
    }}

DefaultAddress ::= OCTET STRING(SIZE (1..21))

NetworkInternalAddress ::= OCTET STRING(SIZE (1..21))

directCallAssociation CALLCONTROBJECTCLASS ::= {
  ARGUMENT SEQUENCE {remotePEPId ObjectReferenceId}
  IDENTIFIER {ccObjectClasses 4}}

remoteCallAssociation CALLCONTROBJECTCLASS ::= {
  ARGUMENT
    SEQUENCE {localPEPId ObjectReferenceId,
              remotePEPId ObjectReferenceId}
  IDENTIFIER {ccObjectClasses 5}}

serviceComponent CALLCONTROBJECTCLASS ::= {
  ARGUMENT
    SEQUENCE {callPEPId ObjectReferenceId,
              serviceComponentCharacteristics
                ServiceComponentCharacteristics OPTIONAL,
              communicationConfiguration
                CommunicationConfiguration OPTIONAL,
              serviceTrafficDescriptorRequirements
                ServiceTrafficDescriptorRequirements OPTIONAL,
              serviceComponentQoSRequirements
                ServiceQoSRequirements OPTIONAL,
              associatedServiceModuleId
                ObjectReferenceId OPTIONAL,
              associatedResourceComponentId
                ObjectReferenceId OPTIONAL}
  IDENTIFIER {ccObjectClasses 6}}

ServiceComponentCharacteristics ::= OCTET STRING

CommunicationConfiguration ::= ENUMERATED {
  source(0), sink(1), biDirectional(2), ...
}

ServiceTrafficDescriptorRequirements ::= OCTET STRING

ServiceQoSRequirements ::= OCTET STRING

END

```

9 Procedures

9.1 Call establishment request

9.1.1 Preceding CC entity

On receipt of an ESTABLISH-CALL request primitive from the call control signalling service user, the preceding CC entity shall initiate call establishment by sending a callEstablish invoke APDU towards the succeeding CC entity and start timer T703. Following the transmission of the APDU, the preceding CC entity shall enter the Call Initiated state.

The preceding CC entity shall include element awaitCompleteIndicator in the callEstablish invoke APDU reflecting the value (TRUE or FALSE) of the Await Complete Indicator parameter within the ESTABLISH-CALL request primitive and store this value locally as "Await Complete Indicator".

The callEstablish invoke APDU shall contain the callSegmentId with the precedingSideCallSegId set to the value provided by the call control signalling service user and the succeedingSideCallSegId set to the null value. Within the argument of the callEstablish invoke APDU, element bearerEstablishmentAddress shall contain an address which, when used as a destination address for bearer establishment in the backward direction from the subsequent CC entity, causes the bearer to be routed to the preceding CC entity's terminal or network node, i.e. to the terminal or network node at the start of the call segment.

The preceding CC entity shall include element callDescription in the callEstablish invoke APDU, as provided by the call control signalling service user.

Prior to sending the callEstablish invoke APDU towards the succeeding CC entity, the preceding CC entity shall initiate establishment of a transport mechanism connection to the succeeding CC entity or use an existing transport mechanism (e.g. an already existing connection or a permanently available transport mechanism).

NOTE – The CC protocol is independent of the underlying transport mechanism. It is therefore out of the scope of this Recommendation which transport mechanism is used.

9.1.2 Succeeding CC entity

On receipt of a callEstablish invoke APDU, the succeeding CC entity shall enter the Call Present state.

The succeeding CC entity shall store the contents of element awaitCompleteIndicator as "Await Complete Indicator".

The receipt of the callEstablish invoke APDU is indicated to the call control signalling service user with an ESTABLISH-CALL indication primitive.

9.2 Call Proceeding

9.2.1 Preceding CC entity

On receipt of a callProceeding invoke APDU while in state Call Initiated, the preceding CC entity shall stop timer T703, start timer T710, and enter the Outgoing Call Proceeding state.

The receipt of the callProceeding invoke APDU is indicated to the call control signalling service user with a PROCEED-CALL indication primitive.

NOTE – This is the earliest time at which the CC signalling service user can establish bearer connections across this segment.

9.2.2 Succeeding CC entity

On request of the call control signalling service user (PROCEED-CALL request primitive) and while in state Call Present, the succeeding CC entity shall send a callProceeding invoke APDU to the preceding CC entity and enter the Incoming Call Proceeding state.

The callProceeding invoke APDU shall contain the element callSegmentId with the precedingSideCallSegId set to the value as received in the callEstablish invoke APDU and the succeedingSideCallSegId set to the value provided by the call control signalling service user.

Within the argument of the callProceeding invoke APDU, element bearerEstablishmentAddress shall contain an address which, when used as a destination address for bearer establishment in the forward direction from the preceding CC entity, causes the bearer to be routed to the succeeding CC entity's terminal or network node, i.e. to the terminal or network node at the end of the call segment.

NOTE 1 – This is the earliest time at which the CC signalling service user can establish bearer connections across this segment.

NOTE 2 – A bearer establishment can be initiated from either the call originating user or from the call destination user.

9.3 Call accepted

9.3.1 Preceding CC entity

On receipt of the callEstablish return result APDU while in state Call Initiated or Outgoing Call Proceeding, the preceding CC entity shall stop timer T703 or T710 and:

- if the value of stored item "Await Complete Indicator" is TRUE, then enter state Call Ready;
- if the value of stored item "Await Complete Indicator" is FALSE, then enter state Call Active.

The receipt of the callEstablish return result APDU is indicated to the call control signalling service user with an ESTABLISH-CALL confirm primitive.

NOTE – If the callEstablish return result APDU was the first response received to a callEstablish invoke, this is the earliest time at which the CC signalling service user can establish bearer connections across this segment.

9.3.2 Succeeding CC entity

On request of the call control signalling service user (ESTABLISH-CALL response primitive), the succeeding CC entity shall send a callEstablish return result APDU to the preceding CC entity and:

- if the value of stored item "Await Complete Indicator" is TRUE, then enter state Await Call Completion and start timer T701;
- if the value of stored item "Await Complete Indicator" is FALSE, then enter state Call Active.

The callEstablish return result APDU shall contain the element callSegmentId. If the succeeding CC entity has not previously sent a callProceeding invoke APDU, the argument of the callEstablish return result APDU shall contain element callSegmentId with the precedingSideCallSegId set to the value as received in the callEstablish invoke APDU and the succeedingSideCallSegId set to the value provided by the call control signalling service user. If it has previously sent a callProceeding invoke APDU, the argument of the callEstablish return result APDU shall contain element callSegmentId as indicated by the CC signalling service user.

The callEstablish return result APDU shall contain the element CallDescription, as provided by the call control signalling service user in the ESTABLISH-CALL response primitive.

If the succeeding CC entity has not previously sent a callProceeding invoke APDU, the argument of the callEstablish return result APDU shall contain element bearerEstablishmentAddress. This element shall contain an address which, when used as a destination address for bearer establishment in the forward direction from the preceding CC entity, causes the bearer to be routed to the succeeding CC entity's terminal or network node, i.e. to the terminal or network node at the end of the call segment.

NOTE – This is the earliest time at which the CC signalling service user can establish bearer connections across this segment.

9.4 Completion of call establishment

9.4.1 Preceding CC entity

On receipt of a COMPLETE-CALL request primitive while in state Call Ready, the preceding CC entity shall send a callComplete invoke APDU to the succeeding CC entity and enter state Call Active.

The preceding CC entity shall include element callSegmentId in the callComplete invoke APDU.

9.4.2 Succeeding CC entity

On receipt of a callComplete invoke APDU in state Await Call Completion, the succeeding CC entity shall enter state Call Active, stop timer T701 and give a COMPLETE-CALL indication primitive to the call control signalling service user.

9.5 Call status change report

9.5.1 General

A change of the information model of a call is reflected in the Call Description belonging to that call. In order to report such a change to the peer CC entity, the callStatus operation, which contains the element callChangedParameter, shall be used. This element indicates changes to the original call description:

- addition and deletion of a service component object;
- changes to the attributes of a party object (i.e. modification of the status of a party);
- changes to the OpenCall attribute of the call object (i.e. modification of the call permissions).

A call status change report indicates one or more changes, but any deleted object shall not be referenced in a modified attribute.

9.5.2 Initiating CC entity

On receipt of a STATUS-CALL request primitive while in state Await Call Completion or Call Active, the initiating CC entity shall send a callStatus invoke APDU and remain in the same state.

The initiating CC entity shall include elements callSegmentId and callChangedParameter in the callStatus invoke APDU as indicated by the CC signalling service user.

The element callChangedParameter contains a list of the changed objects such that:

- where an object specified in the original Call Description is deleted, the value "deleteObject" shall be used, the objectReference shall be included, and modifiedArgument shall not be included;
- where an object specified in the original Call Description is modified, the value "modifyAttributes" shall be used.

9.5.3 Receiving CC entity

On receipt of a callStatus invoke APDU in state Call Ready or Call Active, the receiving CC entity shall give a STATUS-CALL indication primitive to the call control signalling service user and remain in the same state.

9.6 Call establishment failure

9.6.1 Preceding CC entity

On receipt of a callEstablish return error APDU while in state Call Initiated or Outgoing Call Proceeding, the preceding CC entity shall stop all timers (if timers are running) and enter the Call Idle state.

Call establishment failure is indicated to the call control signalling service user by an ESTABLISH-CALL confirm primitive with negative Result parameter.

NOTE – The call control signalling service user gives an indication to BC that the bearer connections for this call shall be cleared.

Call establishment failure can also be indicated from the preceding CC entity while in state Call Ready to the succeeding CC entity by the use of the procedures for call clearing as defined in 9.7.

9.6.2 Succeeding CC entity

On call control signalling service user request (ESTABLISH-CALL response primitive with negative Result parameter) and while in state Call Present or Incoming Call Proceeding, the succeeding CC entity shall send a callEstablish return error APDU with a suitable error value and enter the Call Idle state.

Suitable error values are:

- callDescriptionNotAccepted, if the received call description was not accepted by the CC signalling service user. In this case an alternative call description may be returned together with the error value;
- userBusy, if the called user is busy. In this case, if the received call description was not acceptable by the CC signalling service user, an alternative call description may be returned as additional information together with the error value;
- unallocatedNumber, if the received call description contained an unallocated number;
- noUserResponding, if the called user did not respond to the callEstablish invoke APDU;
- noAnswerFromUser, if no answer from the called user to the callEstablish invoke APDU was received;
- callRejected, if the called user rejected the call;
- destinationOutOfOrder, if the called user's equipment is out of order;
- addressIncomplete, if an address contained in the received call description was incomplete;
- networkOutOfOrder, if equipment in the network is out of order;
- temporaryFailure, if a temporary failure has occurred;
- userNotReachable, if the called user is not reachable;
- unspecified in any other case.

When sending the callEstablish return error APDU, the Location parameter shall indicate the location at which the failure occurred. When an Error is first generated in a user's terminal, the location value "user" shall be used. When an Error is first generated in a network node, the location value "networkLocalCallSegment" shall be used. If that Error is passed on by a CC entity to another call segment, the value shall be changed to "networkNonLocalCallSegment".

The callEstablish return error APDU may contain a Call Description element if provided by the CC signalling service user.

NOTE – The call control signalling service user gives an indication to BC that the bearer connections for this call shall be cleared.

Call establishment failure can also be indicated from the preceding CC entity to the succeeding CC entity while in state Await Call Completion by the use of the procedures for call clearing as defined in 9.7.

9.7 Call clearing

9.7.1 Procedures at the CC entity that initiates call clearing

On receipt of a RELEASE-CALL request primitive from the call control signalling service user, the CC entity initiating call clearing shall send a callRelease invoke APDU, stop all timers, start timer T708, and enter the Call Release Request state.

The argument of the callRelease invoke APDU shall contain a causeValue and the appropriate location parameter in element releaseCause. Valid cause values are "normalCallClearing", "callDescriptionNotAccepted", or "temporaryFailure", depending on the reason why the call control signalling service user initiates call clearing.

Cause values shall be used as follows:

- normalCallClearing, if call release was initiated by one of the involved users;
- callDescriptionNotAccepted, if the received call description was not accepted by the CC signalling service user;
- temporaryFailure, if a temporary failure has occurred.

The location parameter shall indicate the location at which the failure occurred. When a releaseCause is first generated in a user's terminal, the location value "user" shall be used. When a releaseCause is first generated in a network node, the location value "networkLocalCallSegment" shall be used. If that releaseCause is passed on by a CC entity to another call segment the value shall be changed to "networkNonLocalCallSegment".

The callRelease invoke APDU shall only be sent with a complete callSegmentId. Therefore, a CC entity which has initiated a call establishment, i.e. has sent a callEstablish invoke APDU, shall not initiate call clearing before either a callEstablish return result or callProceeding invoke APDU has been received.

On receipt of the callRelease return result APDU while in state Call Release Request, the CC entity initiating clearing shall stop timer T708 and enter the Call Idle state.

The receipt of the callRelease return result APDU is indicated to the call control signalling service user with a RELEASE-CALL confirm primitive.

NOTE – When sending the RELEASE-CALL request primitive to the CC signalling service provider, the call control signalling service user also requests BC that the bearer connections for this call shall be cleared.

9.7.2 Procedures at the CC entity that responds to clearing

In any state except Call Idle, Call Release Request, and Call Release Indication the CC entity receiving a callRelease invoke APDU shall stop any timers that are running and enter the Call Release Indication state. The receipt of the callRelease invoke APDU is indicated to the call control signalling service user with a RELEASE-CALL indication primitive.

On call control signalling service user request (RELEASE-CALL response primitive), the receiving CC entity shall send a callRelease return result APDU and return to the Call Idle state.

NOTE – When receiving the RELEASE-CALL indication primitive, the call control signalling service user requests BC that the bearer connections for this call shall be cleared.

9.7.3 Call clearing collision

In case of call clearing collision, i.e. on receipt of a callRelease invoke APDU while in state Call Release Request, the CC entity shall stop timer T708 and enter the Call Idle state.

9.8 Exceptional procedures

9.8.1 Timer expiry

9.8.1.1 Procedures at the preceding CC entity

If timer T703 expires, i.e. if no response to the callEstablish invoke APDU is received, the preceding CC entity shall clear the call internally, release the CallSegmentId, and enter the Call Idle state.

Call clearing is indicated to the call control signalling service user by an ESTABLISH-CALL confirm primitive with negative Result parameter.

If timer T710 expires, i.e. if a callProceeding invoke APDU has been received as a response to the callEstablish invoke APDU, but no callEstablish return result or return error APDU is received, the preceding CC entity shall clear the call by sending a callRelease invoke APDU, stop all timers, start timer T708, and enter the Call Release Request state. The callRelease invoke APDU sent to initiate call clearing shall contain causeValue "recovery on timer expiry" and an appropriate location value in element releaseCause.

Call clearing is indicated to the call control signalling service user by an ESTABLISH-CALL confirm primitive with negative Result parameter.

9.8.1.2 Procedures at the succeeding CC entity

If timer T701 expires, i.e. if no callComplete invoke APDU is received in the Await Call Completion state, the succeeding CC entity shall clear the call internally, release the CallSegmentId, and enter the Call Idle state.

This exceptional condition is indicated to the call control signalling service user by an ERROR indication primitive with an appropriate Diagnostics parameter.

9.8.1.3 Procedures at the CC entity that initiates call clearing

If timer T708 expires, i.e. if no response to the callRelease invoke APDU is received, the CC entity shall release the call segment ID and enter the Call Idle state.

A RELEASE-CALL confirm primitive is given to the call control signalling service user if call clearing has been initiated on user request.

9.8.2 Receipt of APDUs with unknown Call Segment Id

If an APDU other than a callEstablish invoke is received containing an unknown CallSegmentId, this APDU shall be ignored.

9.8.3 Receipt of APDUs with duplicated Call Segment Id

If a callEstablish invoke APDU is received containing a CallSegmentId which is already in use, this APDU shall be ignored.

9.8.4 Receipt of APDUs out of sequence

If an APDU out of sequence is received, i.e. a callProceeding invoke after a callEstablish return result, with the same CallSegmentId, this APDU shall be ignored.

9.8.5 Receipt of reject APDUs

9.8.5.1 Receipt of a reject APDU that is correlated to a callEstablish invoke

On receipt of a reject APDU that is correlated to a callEstablish invoke APDU while in state Call Initiated, the preceding CC entity shall stop timer T703, clear the call internally, release the CallSegmentId, and enter the Call Idle state.

Call establishment failure is indicated to the call control signalling service user by an ESTABLISH-CALL confirm primitive with negative Result parameter.

9.8.5.2 Receipt of a reject APDU that is correlated to a callProceeding invoke

On receipt of a reject APDU that is correlated to a callProceeding invoke APDU while in state Incoming Call Proceeding, the succeeding CC entity shall remain in this state.

This exceptional condition is indicated to the call control signalling service user by an ERROR indication primitive with an appropriate Diagnostics parameter.

9.8.5.3 Receipt of a reject APDU that is correlated to a callComplete invoke

On receipt of a reject APDU that is correlated to a callComplete invoke APDU while in state Call Active, the preceding CC entity shall clear the call by sending a callRelease invoke APDU, start timer T708, and enter the Call Release Request state. The callRelease invoke APDU sent to initiate call clearing shall contain causeValue "temporary failure" and an appropriate location value in element releaseCause.

This exceptional condition is indicated to the call control signalling service user by an ERROR indication primitive with an appropriate Diagnostics parameter.

9.8.5.4 Receipt of a reject APDU that is correlated to a callStatus invoke

On receipt of a reject APDU that is correlated to a callStatus invoke APDU while in state Await Call Completion or Call Active, the CC entity shall remain in the same state.

This exceptional condition is indicated to the call control signalling service user by an ERROR indication primitive with an appropriate Diagnostics parameter.

9.8.5.5 Receipt of a reject APDU that is correlated to a callRelease invoke

On receipt of a reject APDU that is correlated to a callRelease invoke APDU while in state Call Release Request, the CC entity shall stop timer T708, release the call segment ID, and enter the Call Idle state.

A RELEASE-CALL confirm primitive is given to the call control signalling service user if call clearing has been initiated on user request.

9.8.5.6 Receipt of a reject APDU that is correlated to a callEstablish return result

On receipt of a reject APDU that is correlated to a callEstablish return result APDU while in state Call Active or Await Call Completion, the succeeding CC entity shall clear the call internally, release the CallSegmentId, and enter the Call Idle state.

This exceptional condition is indicated to the call control signalling service user by an ERROR indication primitive with an appropriate Diagnostics parameter.

9.8.5.7 Receipt of a reject APDU that is correlated to a callEstablish return error

On receipt of a reject APDU that is correlated to a callEstablish return error APDU, no action shall be taken.

9.8.5.8 Receipt of a reject APDU that is correlated to a callRelease return result

On receipt of a reject APDU that is correlated to a callRelease return result APDU, no action shall be taken.

9.8.6 Handling of unrecognized parameters within CC-Operations

On receipt of an APDU containing a CC-Operation with one or more unrecognized parameters, the receiving CC entity shall examine the parameterActionIndicator contained in this operation and follow the procedures described below as appropriate:

- If the parameterActionIndicator is set to "clearCallAndItsInformationModel", the receiving CC entity shall clear the call and its information model in accordance with the procedures specified in 9.7.
- If the parameterActionIndicator is set to "discardApduAndReject", the receiving CC entity shall discard the entire APDU and initiate sending of a reject APDU back to the peer CC entity.
- If the parameterActionIndicator is set to "discardApduNoReject", the CC entity shall discard the entire APDU and not initiate sending of a reject APDU.
- If the parameterActionIndicator is set to "discardParameterAndPassApduToApplication", the receiving CC entity shall discard the unrecognized parameter and pass the APDU without the unrecognized parameter on to the CC signalling service user.
- If the parameterActionIndicator is set to "ignoreParameterAndPassApduToApplication", the receiving CC entity shall ignore the unrecognized parameter and pass the APDU including the unrecognized parameter on to the CC signalling service user.

10 Parameter values (Timers)

Timer number	Timer value	Call state	Cause for start	Normally terminated	Action to be taken when timer expires	Succeeding CC	Preceding CC
T703	3 s-15 s (Note)	Call Initiated	On sending of a callEstablish invoke APDU	On receipt of a callEstablish return result/return error, or callProceeding invoke APDU	Clear call internally, release CallSegmentId, enter Call Idle state	–	M
T708	30 s	Call Release Request	On sending of a callRelease invoke APDU	On receiving a callRelease return result APDU	Release call segment ID and enter Call Idle state	M	M
T710	30 s	Outgoing Call Proceeding	callProceeding invoke APDU received	On receiving a callEstablish return result/return error APDU	Clear call	–	M
T701	180 s	Await Call Completion	On sending of a callEstablish return result APDU	On receipt of a callComplete invoke APDU	Clear call internally, release CallSegmentId, enter Call Idle state	M	–

NOTE – The value of T703 shall be chosen based on the underlying transport mechanism to be used.

For timer value T703 the tolerance shall be $-300\text{ ms}/+3\text{ s}$.

For the other timer values specified in this clause, the tolerance shall be $\pm 10\%$.

11 Transport mechanism

The design of this protocol does not demand for a special transport mechanism. However, a reliable transport mechanism is required.

Transport mechanisms which can be used are listed in Annex D. Subclauses Annex D for the various transport mechanisms specify how a particular mechanism shall be used if it has been chosen.

NOTE – Annex D is normative but not exclusive, i.e. other reliable transport mechanisms which are not mentioned there can be used as well.

12 SDL Diagrams

The diagrams in this Recommendation use the Specification and Description Language defined in ITU-T Recommendation Z.100 (1993).

The diagrams represent the behaviour of the CC signalling service provider, which is split into outgoing CC-ASE and incoming CC-ASE (Application Service Element).

Input signals from the left and output signals to the left represent primitives to and from the CC signalling service user. Also protocol timer expiry is indicated by an input signal from the left.

Input signals from the right and output signals to the right represent APDUs sent to and received from the peer CC entity.

The following abbreviations are used:

inv.	invoke APDU	EST	ESTABLISH	req.	request primitive
res.	return result APDU	REL	RELEASE	ind.	indication primitive
err.	return error APDU	PROC	PROCEED	resp.	response primitive
rej.	reject APDU			conf.	confirm primitive
				(+)	positive result
				(-)	negative result

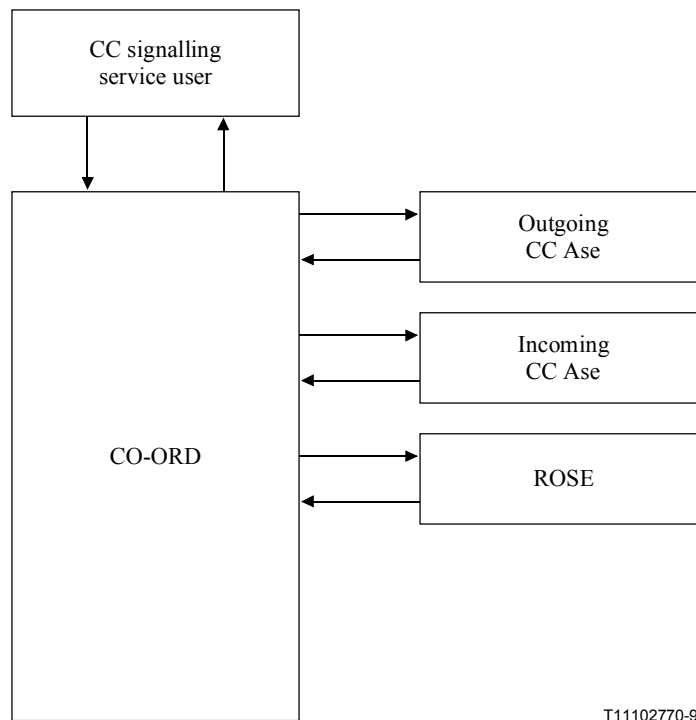

T11102770-99

Figure 12-1/Q.2981 – Block diagram

Table 12-1/Q.2981 – Signal routes

CO-ORD_to_Outgoing-CC-ASE	Incoming-CC-ASE_to_CO-ORD
Primitives: ESTABLISH_CALL_request COMPLETE_CALL_request STATUS_CALL_request RELEASE_CALL_request RELEASE_CALL_response	Primitives: ESTABLISH_CALL_indication COMPLETE_CALL_indication STATUS_CALL_indication RELEASE_CALL_indication RELEASE_CALL_confirm ERROR_indication
APDUs: callProceeding_invoke callEstablish_return_result callEstablish_return_error callEstablish_reject callStatus_invoke callRelease_invoke callRelease_return_result callRelease_reject	APDUs: callProceeding_invoke callEstablish_return_result callEstablish_return_error callStatus_invoke callRelease_invoke callRelease_return_result

Table 12-1/Q.2981 – Signal routes (concluded)

Outgoing-CC-ASE_to_CO-ORD	CO-ORD_to_Incoming-CC-ASE
Primitives: ESTABLISH_CALL_confirm PROCEED_CALL_indication STATUS_CALL_indication RELEASE_CALL_indication RELEASE_CALL_confirm ERROR_indication	Primitives: ESTABLISH_CALL_response PROCEED_CALL_request STATUS_CALL_request RELEASE_CALL_request RELEASE_CALL_response
APDUs: callEstablish_invoke callComplete_invoke callStatus_invoke callRelease_invoke callRelease_result	APDUs: callEstablish_invoke callComplete_invoke callStatus_invoke callRelease_invoke callRelease_return_result callRelease_reject callEstablish_reject

12.1 Outgoing CC-ASE

See Figures 12-2 to 12-9.

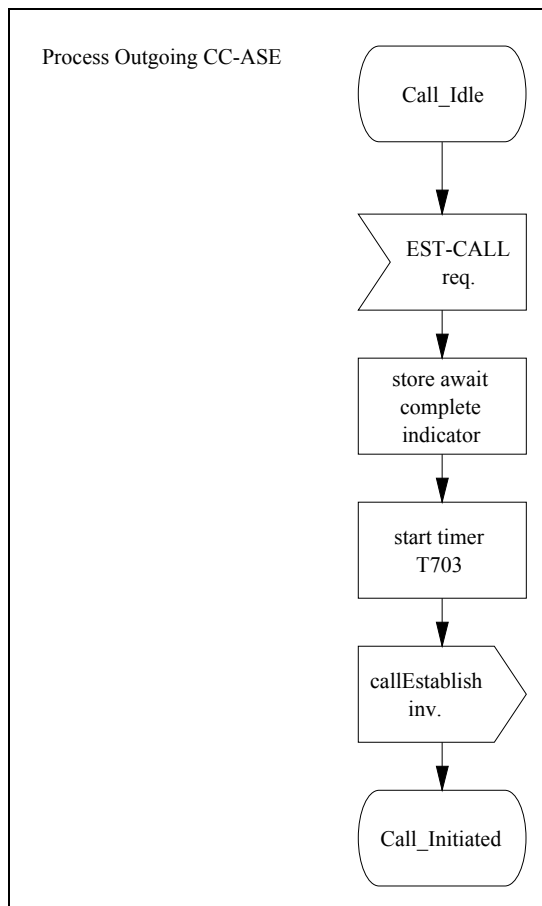

Figure 12-2/Q.2981 – SDL for Call Control, outgoing call

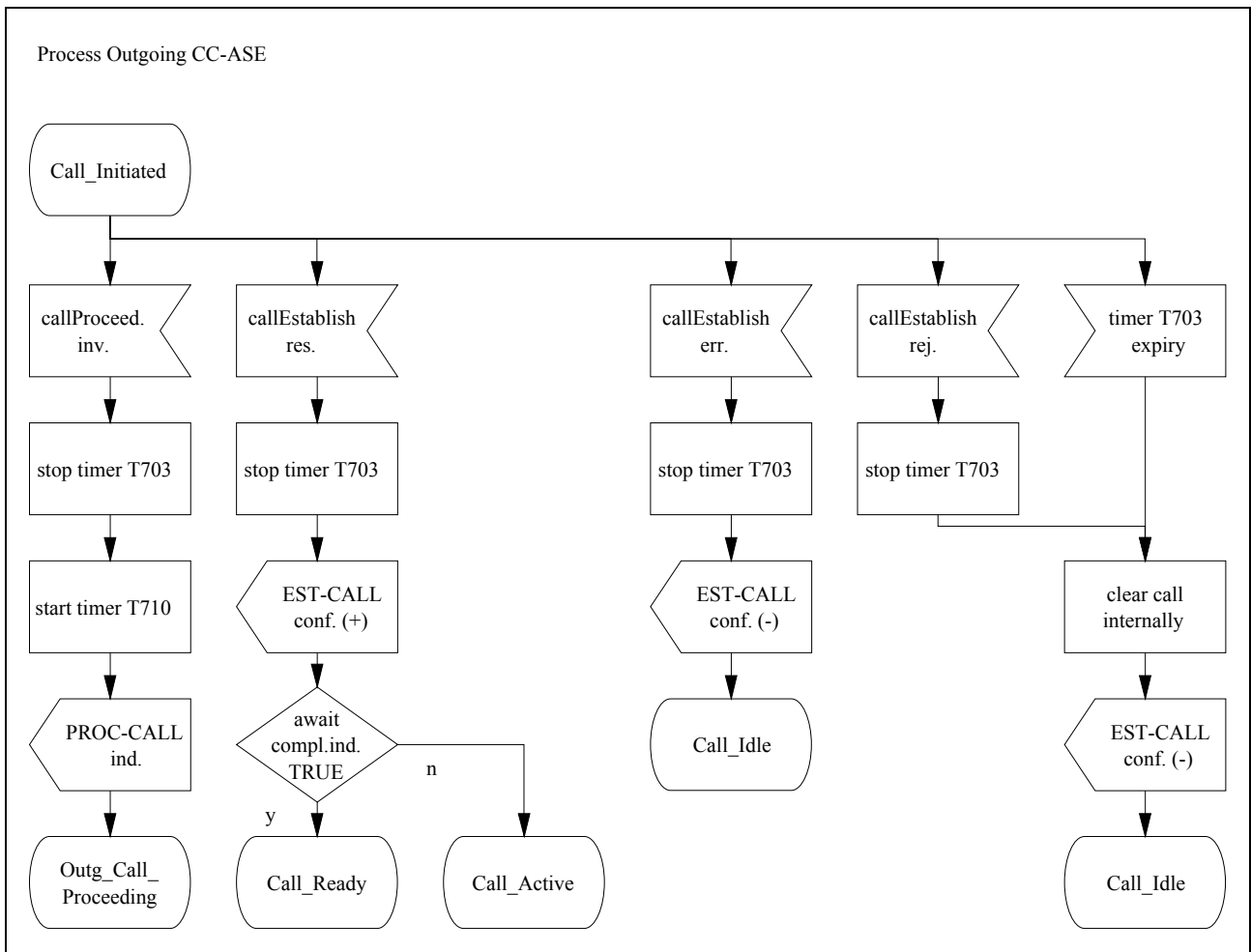

Figure 12-3/Q.2981 – SDL for Call Control, outgoing call

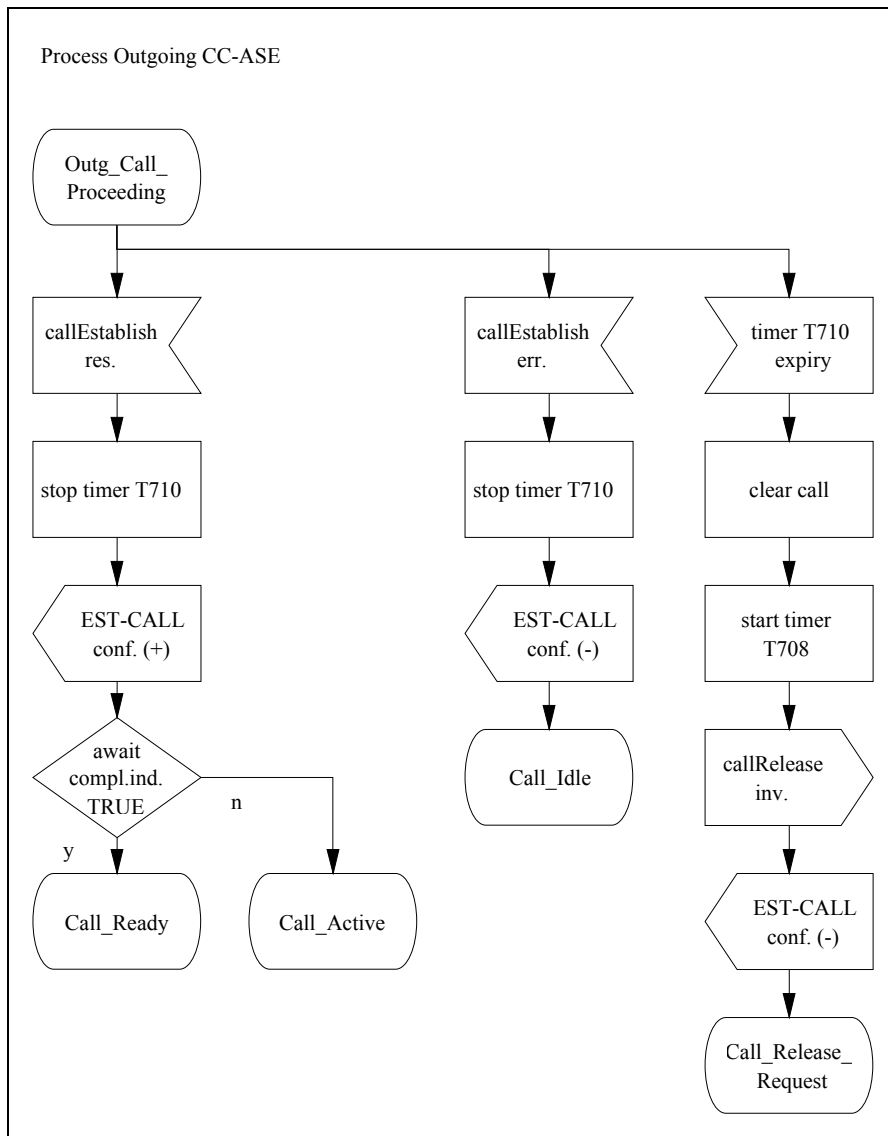

Figure 12-4/Q.2981 – SDL for Call Control, outgoing call

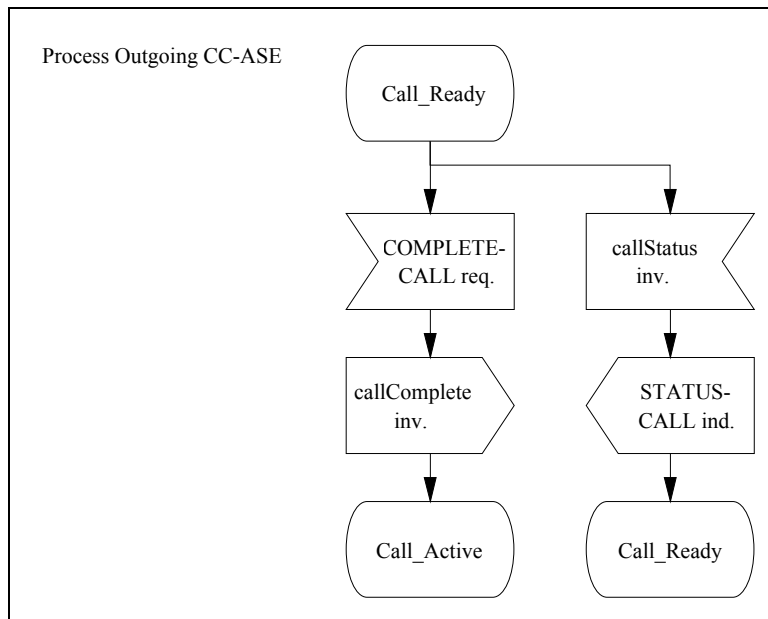

Figure 12-5/Q.2981 – SDL for Call Control, outgoing call

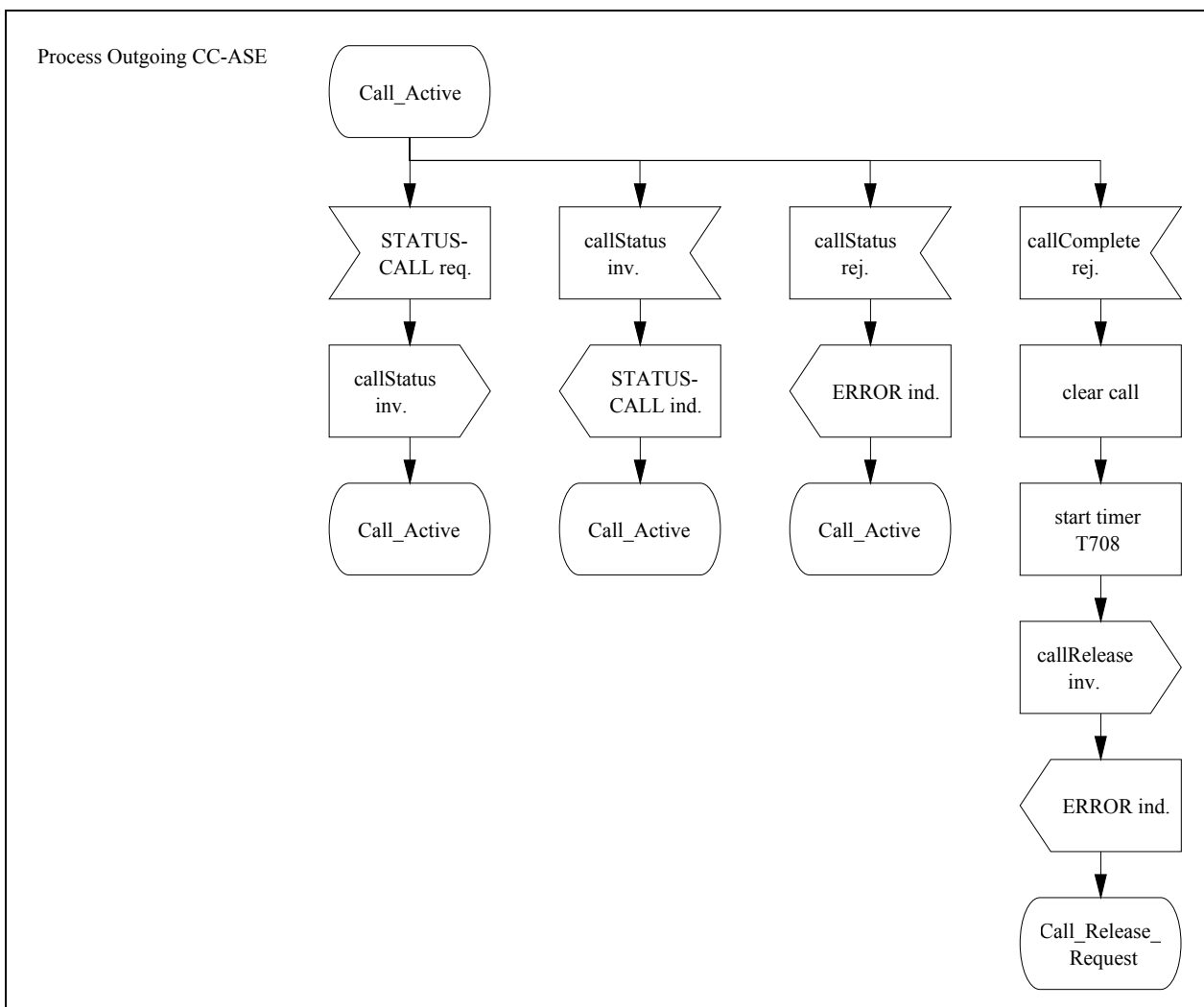

Figure 12-6/Q.2981 – SDL for Call Control, outgoing call

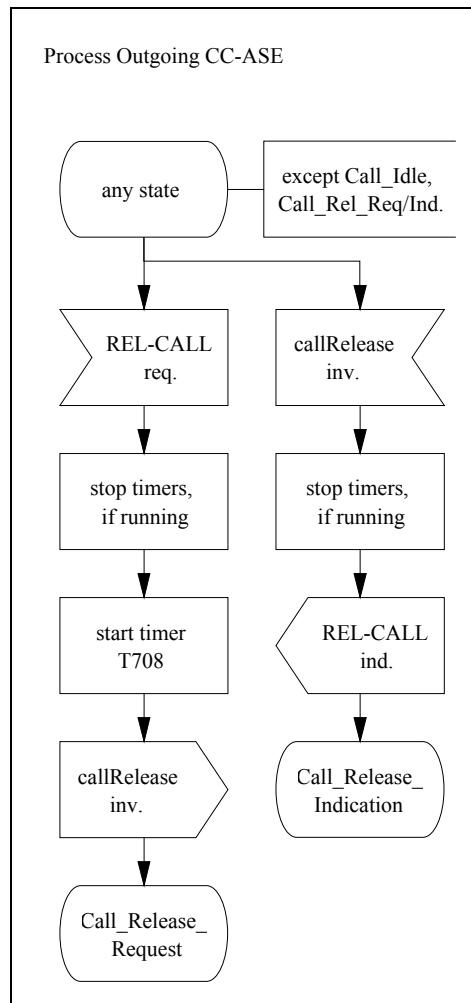

Figure 12-7/Q.2981 – SDL for Call Control, outgoing call, call release

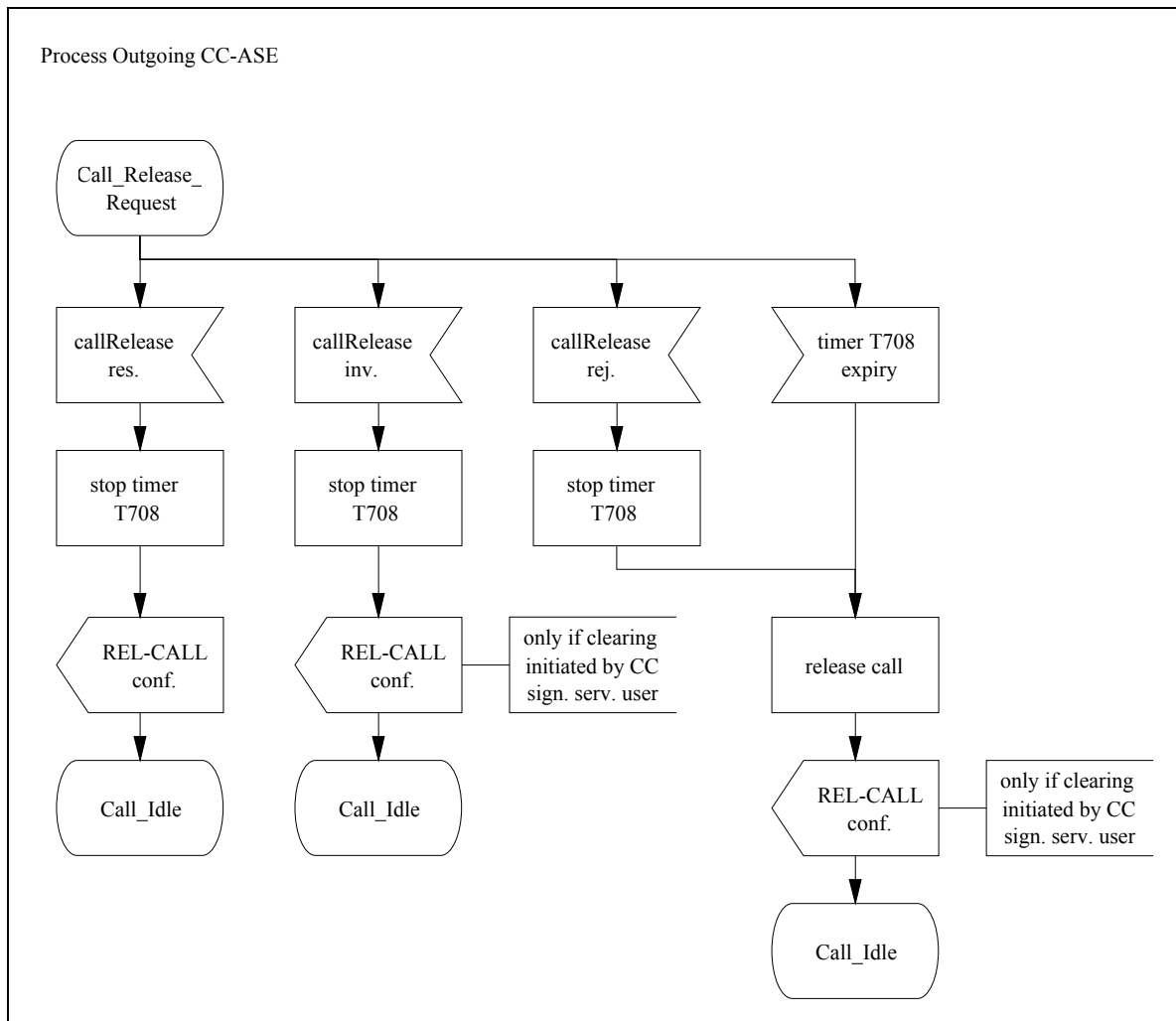

Figure 12-8/Q.2981 – SDL for Call Control, outgoing call, call release

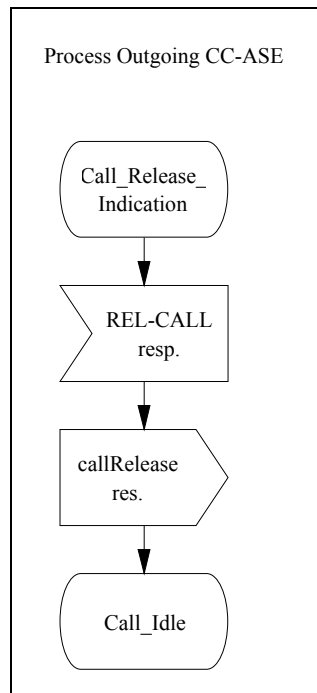

Figure 12-9/Q.2981 – SDL for Call Control, outgoing call, call release

12.2 Incoming CC-ASE

See Figures 12-10 to 12-18.

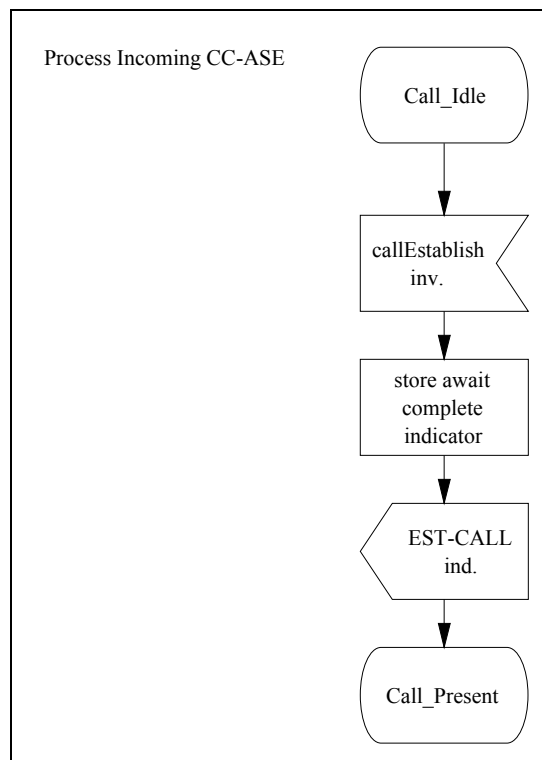

Figure 12-10/Q.2981 – SDL for Call Control, incoming call

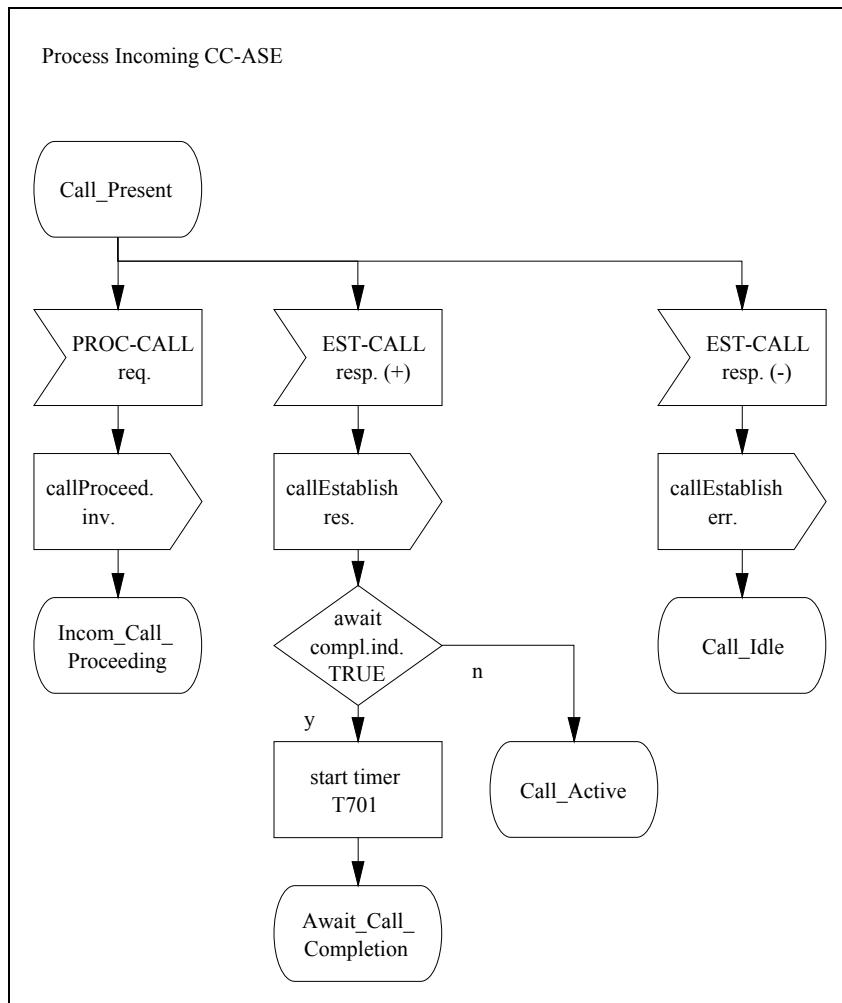

Figure 12-11/Q.2981 – SDL for Call Control, incoming call

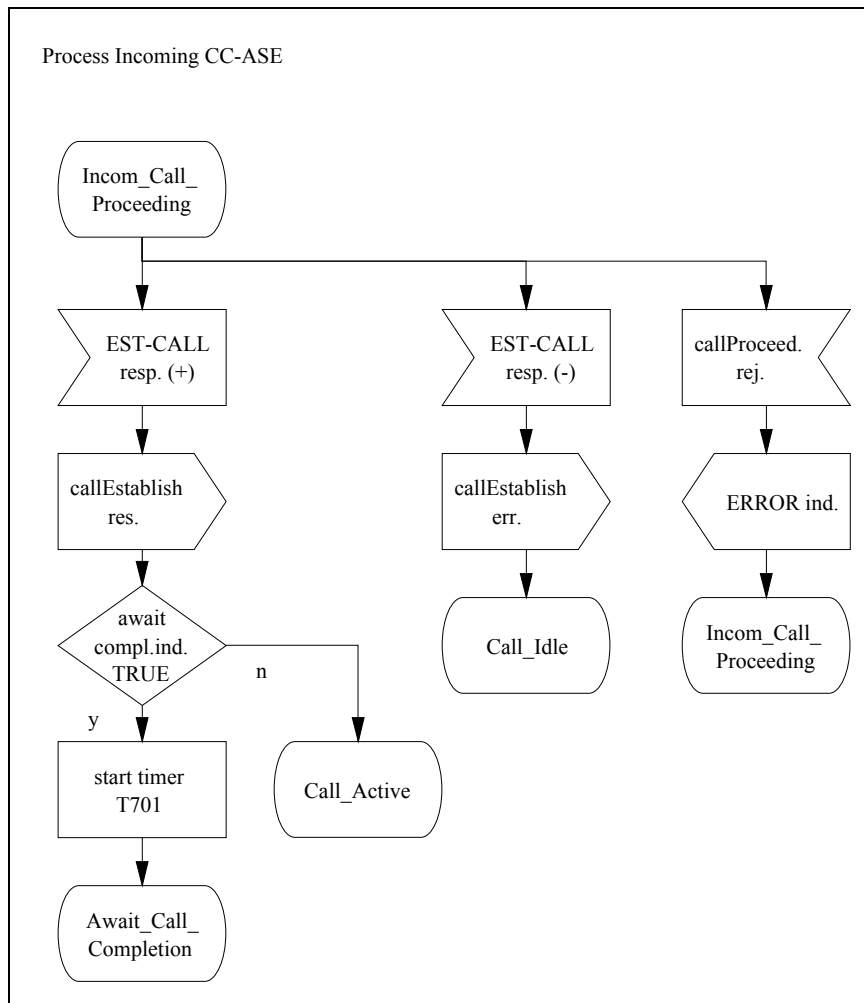

Figure 12-12/Q.2981 – SDL for Call Control, incoming call

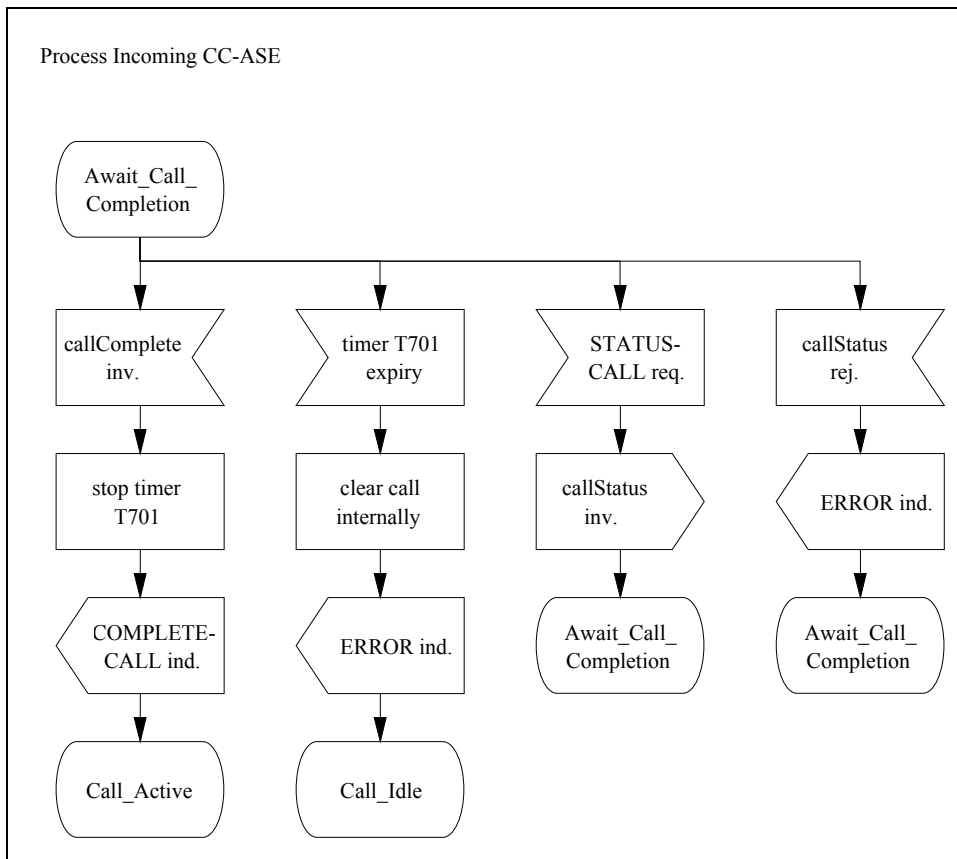

Figure 12-13/Q.2981 – SDL for Call Control, incoming call

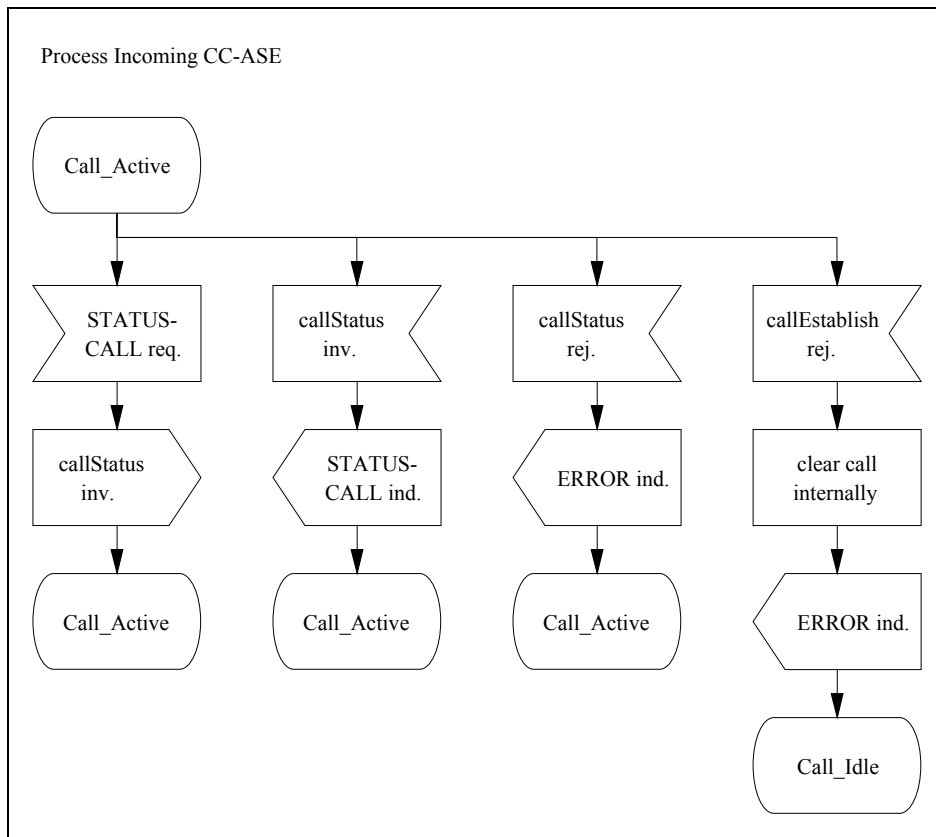

Figure 12-14/Q.2981 – SDL for Call Control, incoming call

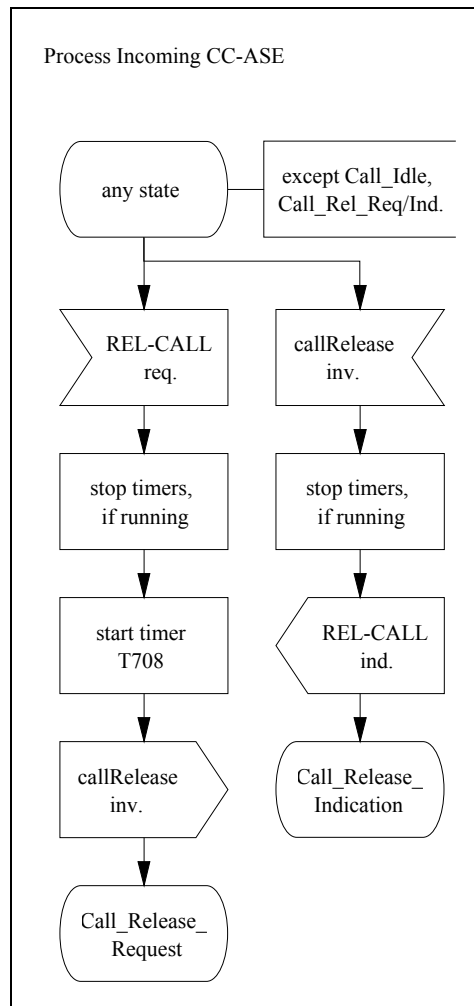

Figure 12-15/Q.2981 – SDL for Call Control, incoming call, call release

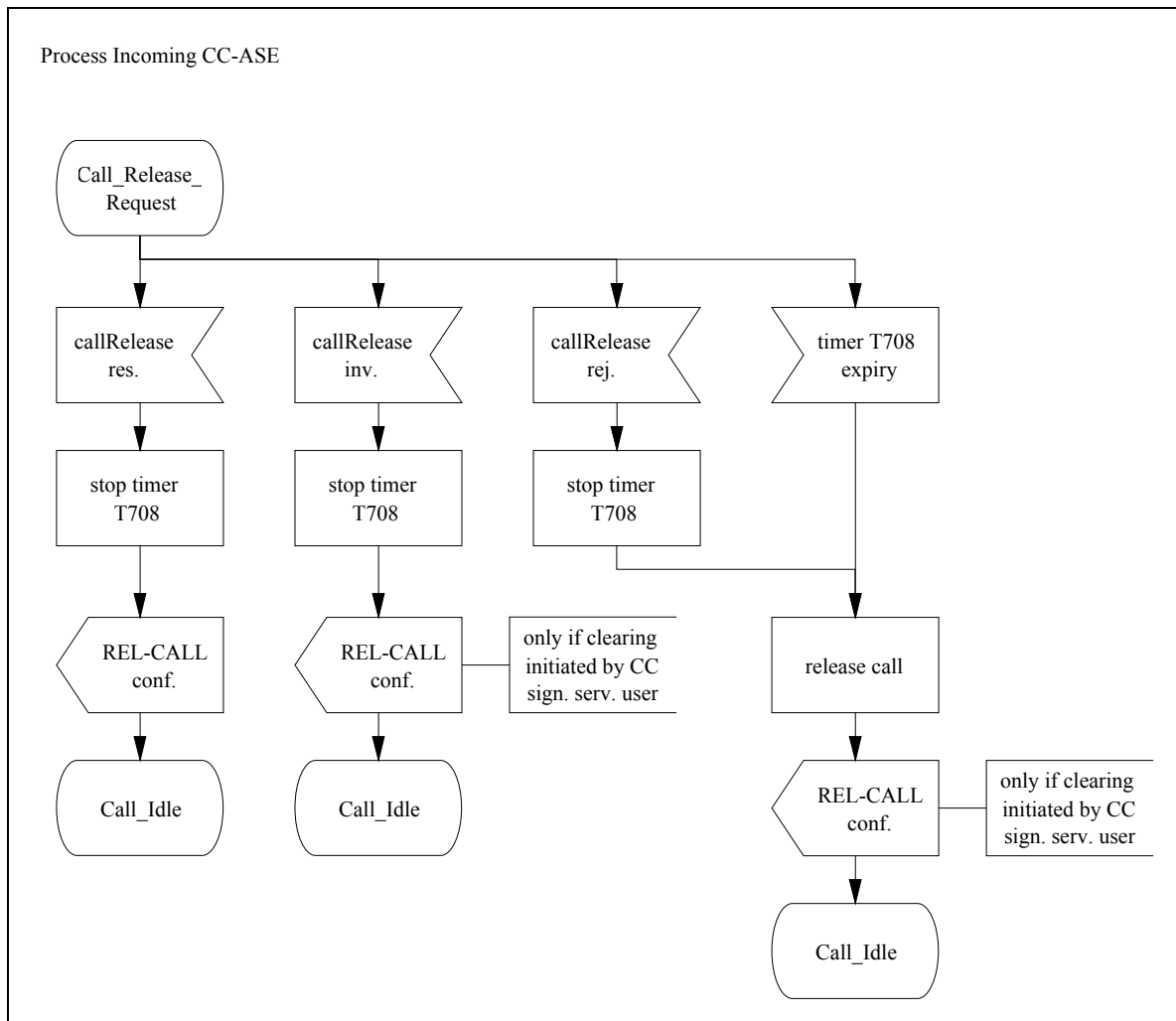

Figure 12-16/Q.2981 – SDL for Call Control, incoming call, call release

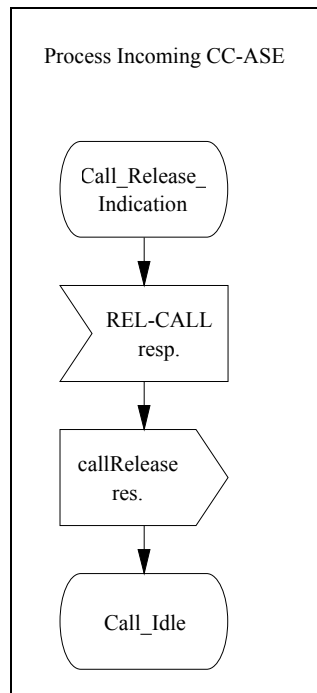

Figure 12-17/Q.2981 – SDL for Call Control, incoming call, call release

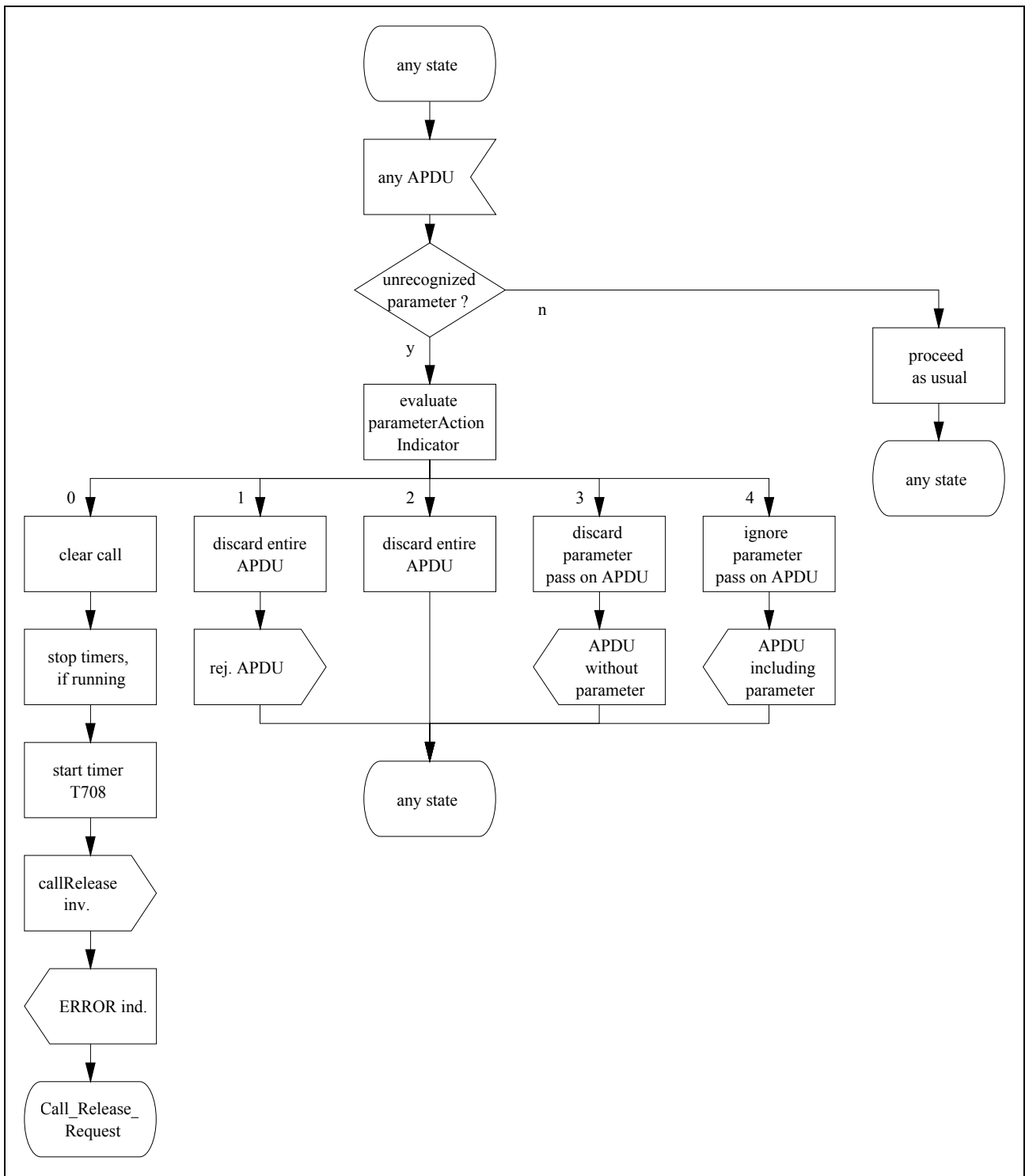

Figure 12-18/Q.2981 – SDL for the handling of unrecognized parameters within CC operations

ANNEX A

Bearer coordination requirements for CC signalling service users

Signalling for bearer control is outside the scope of this Recommendation. The way in which a CC entity coordinates the call's bearers is also outside the scope of this Recommendation, except that the following requirements shall be met.

A.1 Requirements at a CC entity that establishes a bearer towards an adjacent CC entity

The requirements in this subclause apply to an end CC entity that initiates bearer establishment towards the adjacent CC entity on request of the application. An end CC entity can be an originating CC entity that initiates bearer establishment in the forward direction (with respect to the direction of call establishment) or a terminating CC entity that initiates bearer establishment in the backward direction (with respect to the direction of call establishment).

The requirements in this subclause also apply to a transit CC entity that continues bearer establishment towards the subsequent CC entity following receipt of an incoming bearer from the preceding CC entity (such a bearer being in the forward direction with respect to the direction of call establishment), or that continues bearer establishment towards the preceding CC entity following receipt of an incoming bearer from the subsequent CC entity (such a bearer being in the backward direction with respect to the direction of call establishment).

Bearer establishment in the forward direction shall not commence before one of the following APDUs has been received from the subsequent CC entity:

- callProceeding invoke APDU; or
- callEstablish return result APDU.

The contents of elements bearerEstablishmentAddress and callSegmentId in the first of the above APDUs to be received shall be used as the destination address and the call segment identifier respectively for bearer establishment.

NOTE 1 – Omission of either of these elements from the first of these APDUs constitutes a protocol error.

Bearer establishment in the backward direction shall not commence before one of the following APDUs has been sent to the preceding CC entity:

- callProceeding invoke APDU; or
- callEstablish return result APDU.

The contents of element callSegmentId in the first of the above APDUs to be transmitted and element bearerEstablishmentAddress in the received callEstablish invoke APDU shall be used as the call segment identifier and the destination address respectively for bearer establishment.

NOTE 2 – For bearer establishment in either direction, the value used for the bearer destination address will cause the bearer to be routed to the terminal or network node where the CC entity at the opposite end of the call segment is located.

NOTE 3 – For bearer establishment in either direction, the call segment identifier is conveyed transparently by bearer control signalling to the terminal or network node where the CC entity at the opposite end of the call segment is located, thereby allowing that terminal or network node to link the bearer to the call.

NOTE 4 – Call control signalling service users should ensure that bearer connection elements established by associated bearer control prior to call acceptance are consistent with all variants of selectable options within the call description included in the call establishment request. After call establishment call control entities should ensure that bearer connection elements are consistent with the final call description. Bearer connection elements and bearer connection establishment requests failing these criteria should be rejected or released as appropriate.

For bearer establishment in either direction, an address representing the local CC entity (i.e. the CC entity at the start of the segment) shall be used as the calling address of the bearer.

For bearer establishment in either direction, a bearer identifier value by which the bearer is to be known by the two CC entities at either end of the call segment may be provided as part of the bearer establishment request. The bearer identifier value shall have significance across the call segment concerned.

NOTE 5 – For bearer establishment in either direction, the bearer identifier value, if provided in the bearer establishment request, is conveyed transparently by bearer control signalling to the terminal or network node where the CC entity at the opposite end of the call segment is located. Its purpose is to allow that CC entity to associate the bearer establishment with a bearer reference conveyed within call control signalling (e.g. as an attribute of an Attachment object). If call control signalling has already made reference to this bearer, prior to its establishment, the bearer identifier value used in the bearer establishment request should be the same as the bearer reference already used by call control signalling. Any further call control signalling that needs to refer to this bearer should use the bearer identifier value used in the bearer establishment request.

Bearer establishment shall not commence after a callRelease invoke APDU has been sent or received across the segment concerned.

A.2 Requirements at a CC entity that receives a bearer establishment from an adjacent CC entity

The requirements in this subclause apply to a CC entity that receives an incoming bearer establishment from an adjacent CC entity. This can be from the preceding CC entity (in the case of a bearer established in the forward direction with respect to the direction of call establishment) or from the subsequent CC entity (in the case of a bearer established in the backward direction with respect to the direction of call establishment).

A terminal or network node that receives an incoming bearer establishment signal containing a destination address that indicates that that terminal or network node is the destination of the bearer shall attempt to match the received call segment identifier with a call segment identifier assigned to a call segment that is associated with a CC entity on that terminal or network node. If a match is found, the CC entity concerned shall proceed with establishment of the bearer.

NOTE 1 – In the case of a transit CC, the time at which bearer establishment is continued across the next call segment is outside the scope of this Recommendation, apart from being subject to the restrictions in A.1.

NOTE 2 – In the case of an end CC, the bearer should be presented to the application.

NOTE 3 – Call control signalling service users should ensure that bearer connection elements established by associated bearer control prior to call acceptance are consistent with all variants of selectable options within the call description included in the call establishment request. After call establishment call control entities should ensure that bearer connection elements are consistent with the final call description. Bearer connection elements and bearer connection establishment requests failing these criteria should be rejected or released as appropriate.

If the terminal or network node is the destination of the bearer but is unable to match the received call segment identifier with a call segment identifier assigned to a call segment that is associated with a CC entity on that terminal or network node, the terminal or network node shall reject the bearer establishment request.

Even though a succeeding CC entity is required to send a callProceeding invoke APDU or callEstablish return result APDU before commencing bearer establishment in the backward direction, it is possible for a bearer establishment request to arrive at a preceding CC entity before any of the above APDUs arrives. In this case, the preceding CC shall await the arrival of one of the above APDUs before continuing to process the bearer establishment request. If timer T703 expires, the bearer establishment request shall be released.

NOTE 4 – If the received bearer establishment request contains a bearer identifier value, this value should be used by the CC entity in any future call control signalling relating to this bearer. If call control signalling has already made reference to this bearer, prior to its establishment, using this value, the incoming bearer establishment request should be associated with that bearer reference.

A.3 Additional requirements at a transit CC

A transit CC shall relay an alerting or answer indication from the outgoing bearer on to the incoming bearer.

A transit CC shall relay a release indication from either bearer on to the other bearer, except that a release indication from an outgoing bearer that is in the bearer establishment phase may instead, depending on the cause of release, result in re-routing of the outgoing bearer.

A transit CC shall pass on any subaddress information from one bearer unchanged to the other bearer.

A transit CC shall pass on any low layer or high layer compatibility information (e.g. Q.2931 B-HLI, B-LLI, N-HLC, N-LLC or N-BC information elements) from one bearer unchanged to the other bearer.

A transit CC shall pass on any bearer-related supplementary service information from one bearer, unless acted upon at the network node concerned, unchanged to the other bearer.

A.4 Requirement on call clearing

On sending or receiving a callRelease invoke APDU across a call segment, the CC entity shall immediately initiate the release of any bearers across that call segment that are not already in the process of being released.

ANNEX B

Call description handling requirements for CC signalling service users

B.1 Call description handling at a CC signalling service user within an originating CC entity

When requesting the CC signalling service provider to send a callEstablish invoke APDU, a CC signalling service user within an originating CC shall include a call description containing the following objects:

Network relevant objects:

- one Call object, with status mandatory;
- two Call Party End Point objects, one indicated in the Call object as local and identifying the local user, the other indicated in the Call object as remote, and both with status mandatory;
- one Call Party End Point Association object referencing the two Call Party End Point objects, with status conditional;
- optionally one or more Service Component objects, each with status either mandatory or optional.

End-to-end relevant objects:

- for each Service Component object, two Participation objects (one per Call Party End Point object), each with status conditional.

B.2 Call description handling at a CC signalling service user within a transit CC entity

A CC signalling service user within a transit CC may modify the network relevant objects contained in a call description received in a callEstablish invoke APDU prior to requesting the CC signalling service provider to pass it on in a callEstablish invoke APDU towards the next CC. Modification shall be limited to the following:

- the removal of one or more objects with status optional; and
- the removal of any objects with status conditional that depend on other objects removed.

NOTE 1 – This means, for example, that objects cannot be added, objects with status mandatory cannot be deleted, and object attributes cannot be modified.

If a CC signalling service user within a transit CC is unable to accept the network relevant objects contained in the call description as received and is unable to achieve an acceptable call description by means of modification in accordance with the rules above, it shall reject the call with an appropriate error value, e.g. callDescriptionNotAccepted.

NOTE 2 – A return error APDU with error value callDescriptionNotAccepted can contain an alternative call description that would be acceptable to the CC signalling service user.

A CC signalling service user within a transit CC shall not modify a call description passed on in any other APDU (i.e. callEstablish return result or callEstablish return error), nor the callChangedParameter in a callStatus invoke APDU.

A CC signalling service user within a transit CC shall pass on transparently the end-to-end relevant objects contained in a call description received in a callEstablish invoke APDU.

B.3 Call description handling at a CC signalling service user within a terminating CC entity

A CC signalling service user within a terminating CC may modify the end-to-end and network relevant objects contained in call description received in a callEstablish invoke APDU prior to requesting the CC signalling service provider to send back a callEstablish return result APDU. Modification shall be limited to the following:

- the removal of one or more objects with status optional; and
- the removal of any objects with status conditional that depend on other objects removed.

NOTE 1 – This means, for example, that objects cannot be added, objects with status mandatory cannot be deleted, and object attributes cannot be modified.

If a CC signalling service user within a terminating CC is unable to accept the call description as received and is unable to achieve an acceptable call description by means of modification in accordance with the rules above, it shall reject the call with an appropriate error value, e.g. callDescriptionNotAccepted, userBusy, callRejected.

NOTE 2 – A return error APDU with error value callDescriptionNotAccepted or userBusy can contain an alternative call description that would be acceptable to the CC signalling service user.

NOTE 3 – One reason for a received call description being unacceptable is that it has been sent by equipment that supports enhanced capabilities beyond the scope of this Recommendation and therefore contains additional objects (e.g. more than two Party End Point objects).

B.4 Call description errors

When a call description parameter is received which has one or more unexpected object identifiers or object identifiers with unrecognized attributes (arguments), the receiving entity shall examine the object action indicator, and follow the procedures described in a), b), c), d) or e) below as appropriate.

If more than one object identifiers and/or object attributes are received in error, only one response shall be given. The response shall be according to the handling of the object action indicator attribute according to the following order of priority: "clearCall" (highest priority), "discardNotify", "discardUnknown", "progressTransit".

a) *Object action indicator attribute = clearCall*

If the object action indicator attribute is equal to "clear call object model", the call shall be cleared according to the procedures defined in 9.7 except that the Cause information element shall contain the cause "call DescriptionNotAccepted".

b) *If the object action indicator attribute = discardNotify*

The call description shall be ignored and a returnError APDU with error value "callDescriptionNotAccepted" shall be returned.

c) *Object action indicator attribute = discardUnknown*

If the object action indicator attribute is equal to "discard unknown item and proceed", the unknown item (either the entire object or only the unknown attribute) shall be ignored and the call description shall be processed as if the unknown information was not received. No returnError APDU shall be sent.

d) *Object action indicator attribute = progressTransit*

The unknown object or unknown attribute shall be progressed as an octet string parameter to succeeding call control (if the operation requires so), but shall not be retained by the call control service user once the operation is complete.

e) *Object action indicator attribute = unknown value*

If an unknown object or unknown attribute has an associated object action indicator that contains an unknown value, then the receiver shall handle the call description as if the object action indicator attribute had been set to "progressTransit".

B.5 End-to-end relevant object handling at a CC signalling service user within a transit CC entity

End-to-end relevant objects (service components) shall always be handled by a CC signalling service user within a transit CC entity as unknown objects with an object action indicator attribute set to "progressTransit", regardless of the value that the object action indicator attribute is actually set to. The operation shall always be progressed when this type of object is the only unknown error.

B.6 Changes to the Information Model

The Call Control protocol provides a single mechanism to indicate changes to the information model, the Status Call procedure. This procedure provides for a single unconfirmed flow and therefore represents only non-negotiable changes that reflect events that have already happened. The changes to the information model that the CC signalling service user shall indicate using this procedure are:

- addition and deletion of a service component object;
- changes to the attributes of a party object (i.e. modification of the status of a party);
- changes to the OpenCall attribute of the call object (i.e. modification of the call permissions).

B.6.1 Deletion of a Service Component Object

The deletion of a service component reflects the ability of any user application to discontinue using some portion of an implementation's functionality. Any CC signalling service user at an originating or terminating CC entity can delete a service component in the information model. An attempt to

delete a service component that does not exist shall not cause an error, but shall be ignored by the CC signalling service user at the peer originating or terminating CC entity.

B.6.2 Addition of a Service Component Object

The addition of a service component using the Status Call procedure reflects the ability of an originating or terminating CC entity to begin using some portion of an implementation's functionality. The Status Call procedure does not support either confirmation or negotiation of this functionality and so it is assumed that this does not place any additional requirements on the bearer. The CC signalling service user at the peer originating or terminating CC entity, receiving an indication of an added service component, may choose to ignore the indication.

B.6.3 Changes to the attributes of the Party Object

The changes to the attributes of a party object that the CC signalling service user shall indicate are:

- changes to the status of a party (e.g. alerting);
- changes to the type of a party.

The procedures associated with the status call require that the complete party object shall be provided.

B.6.4 Changes to the Open Call attribute of the Call Object

The OpenCall attribute of the call object defines the rights of parties to modify the call by the addition of parties, connections or service components. The permissions provide the requirements for notification and requesting call owner permission.

The OpenCall parameter contains the following Boolean indications which shall take the values shown:

- externalPartyAddAllowed:
Value: False.
Usage: Indicates that another party, not currently part of the call, shall not join the call configuration.
- existingPartyAddAllowed:
Value: False.
Usage: Indicates that a non-call owner party shall not introduce another party, not currently part of the configuration, into the call.
- notifyAllPartiesFlag:
Value: True.
Usage: Indicates whether a party successfully joining the call is required to be notified to all the existing members of the call. This indication is provided for future capability and is not currently used. It shall be set to true as this is more restrictive.
- notifyOwnerFlag:
Value: True.
Usage: Indicates whether a party successfully joining the call is required to be notified to the call owner. This indication is provided for future capability and is not currently used. It shall be set to true as this is more restrictive.

- permissionRequiredFlag:
Value: True.
Usage: Indicates whether a party may join the call only after the call owners permission has been sought. This indication is provided for future capability and is not currently used. It shall be set to true as this is more restrictive.
- addConnectionAllowed:
Value: True or False.
Usage: Indicates whether the non-call owner is permitted to add a connection to an existing call. If the value is set to true then any party may add a connection and also the CC signalling service provider shall refuse any request to change this value from true to false. A change from false to true is permitted.
- addServiceComponentAllowed:
Value: True or False.
Usage: Indicates whether the non-call owner is permitted to add a service component to an existing call. If the value is set to true then any party may add a service component to a connection. The CC signalling service provider shall refuse any request to change this value from true to false. A change from false to true is permitted.

The call permissions are indicated to the non-call owner as part of the call description during call establishment. The call permissions are not a subject for negotiation and shall not be changed by any CC signalling service user except the call owner CC signalling service user.

Changes to the call permissions that reduce or restrict the modification rights of non-call owners can result in conflicts. To prevent protocol clashes, any call control protocol service provider shall refuse to accept a request by a CC signalling service user to alter the OpenCall parameter if such an alteration removes a capability already granted. A refusal shall result in the changes to the OpenCall attribute of the call object being ignored and not being passed on to any succeeding CC signalling service user.

A CC signalling service user that receives a STATUS-CALL indication primitive that alters the call modification permission shall store the new permissions and pass on unchanged the OpenCall parameter towards the next CC using the STATUS-CALL request.

The CC signalling service user that initiated the call may allow another party to add either connections or service components at call establishment by initiating a call with either the addConnectionAllowed flag set to TRUE or the addServiceComponentAllowed flag to TRUE or both. The CC signalling service user that initiated the call may change the permissions to allow another party to add either connections or service components after call establishment using the call status procedure to change either of the above flags from false to true. The call status procedure shall not be used to change either of the flags from TRUE to FALSE. The call status procedure shall not be used to change any of the other flags in the OpenCall parameter.

ANNEX C

Interworking

Interworking occurs with other networks, which do not support the separation of Call Control and Bearer Control or which send simultaneous call and bearer establishment requests.

Interworking with such networks requires both Call Control and Bearer Control functions in the gateway node at the boundary to these networks.

The interworking is performed by the CC signalling service user of the Call Control entity in the gateway node.

C.1 Interworking with networks not supporting separation of Call Control and Bearer Control

C.1.1 Outgoing call establishment

In case of an outgoing call establishment to a network which does not support the separation of Call Control and Bearer Control, the Call Control entity in the gateway node shall act as the terminating CC entity for that call. When the call establishment has been accepted by the terminating CC entity in the gateway node, subsequent bearer establishment requests which match with that call shall be forwarded to the other network.

C.1.2 Incoming bearer establishment

In case of an incoming bearer establishment from a network which does not support the separation of Call Control and Bearer Control, the establishment can optionally be progressed in accordance with this Recommendation. In this case the Call Control entity in the gateway node shall act as the originating CC entity and initiate establishment of a call, that matches with the required bearer. When the call establishment has been accepted, i.e. after receipt of a callProceeding invoke APDU or callEstablish return result APDU, the bearer establishment shall be progressed.

C.1.3 Addition of bearers to an existing call

When a call exists between an originating CC entity and the CC entity in a gateway node to a network which does not support the separation of Call Control and Bearer Control, and a bearer has to be added to that call, the decision as to whether or not the additional bearer is supported is not taken in the gateway, but another bearer establishment shall be made across the other network to the same addressed terminal.

C.2 Interworking with simultaneous call and bearer establishment

In this case of interworking the other network supports the separation of Call Control and Bearer Control but only the capability of simultaneous establishment of a call with one bearer is supported.

C.2.1 Outgoing call establishment

In case of an outgoing call establishment to a network which only supports simultaneous call and bearer establishment, the Call Control entity in the gateway node shall act as the terminating CC entity for that call. When the call establishment has been accepted by the terminating CC entity in the gateway node and when a subsequent bearer establishment request belonging to that call is received, a simultaneous call and bearer establishment shall be initiated towards the other network.

C.2.2 Incoming call and bearer establishment

In case of an incoming call and bearer establishment, the Call Control entity in the gateway node shall act as the originating CC entity and initiate separate establishment of a corresponding call. When the call establishment has been accepted, i.e. after receipt of a callProceeding invoke APDU or callEstablish return result APDU, the bearer establishment shall be progressed.

C.2.3 Addition of bearers to an existing call

When a call exists between a CC entity and the CC entity in a gateway node to a network which only supports simultaneous call and bearer establishment, and a bearer in outgoing direction has to be added to that call, the decision as to whether or not the additional bearer is supported is not taken in the gateway, but another bearer establishment shall be made across the other network to the same addressed terminal. If a bearer in incoming direction has to be added to that call, i.e. if an incoming bearer establishment is received, the gateway shall forward it to the corresponding destination.

ANNEX D

Transport mechanisms

This annex lists transport mechanisms which can be used with the call control protocol and specifies how to use them.

NOTE – This annex is normative but not exclusive, i.e. other reliable transport mechanisms which are not mentioned here can be used as well.

D.1 Connection oriented-Bearer independent

The connection oriented-bearer independent (CO-BI) transport mechanism is specified in ITU-T Recommendation Q.2932.1 [8] for the S_B and coincident S_B/T_B reference point. If the CO-BI transport mechanism is chosen, the following shall apply:

- The operations defined in 8.1 shall be coded in the Facility information element in accordance with ITU-T Recommendation Q.2932.1 [8].
- The instruction indicator in the Facility information element shall be coded in accordance with ITU-T Recommendation Q.2932.1 [8].
- The Facility information element shall be conveyed in the messages for the CO-BI transport mechanism as specified in ITU-T Recommendation Q.2932.1 [8].
- The instruction indicator in the messages for the CO-BI transport mechanism shall be coded in accordance with ITU-T Recommendation Q.2932.1 [8].

Additionally for the Q_B reference point:

- When conveying the invoke APDU of operations defined in 8.1, the NFE (Network Facility Extension) shall either be omitted or be included.
- When conveying the invoke APDU of operations defined in 8.1, the Interpretation APDU shall either be omitted or be included].

D.2 Connectionless-Bearer independent

The connectionless-bearer independent (CL-BI) transport mechanism is specified in ITU-T Recommendation Q.2932.1 [8] for the S_B and coincident S_B/T_B reference point. If the CL-BI transport mechanism is chosen, the following shall apply:

- The operations defined in 8.1 shall be coded in the Facility information element in accordance with ITU-T Recommendation Q.2932.1 [8].

- The instruction indicator in the Facility information element shall be coded in accordance with ITU-T Recommendation Q.2932.1 [8].
- The Facility information element shall be conveyed in the FACILITY message for the CL-BI transport mechanism as specified in ITU-T Recommendation Q.2932.1 [8].
- The instruction indicator in the FACILITY message for the CL-BI transport mechanism shall be coded in accordance with ITU-T Recommendation Q.2932.1 [8].

Additionally for the Q_B reference point:

- When conveying the invoke APDU of operations defined in 8.1, the NFE (Network Facility Extension) shall either be omitted or be included.
- When conveying the invoke APDU of operations defined in 8.1, the Interpretation APDU shall either be omitted or be included.

APPENDIX I

Information flow diagrams

This appendix describes some typical information flows for Call Control. The following conventions are used in the figures of this appendix:

- The figures show APDUs exchanged between CC entities involved in Call Control. Only APDUs relevant to Call Control are shown.
- The figures show protocol states related to the incoming and outgoing side of the call control signalling service provider within a CC entity.
- The figures show the primitives to and from the call control signalling service user within the user CC which correspond to the exchanged APDUs.

I.1 Call Establishment using a two-message sequence

See Figure I.1.

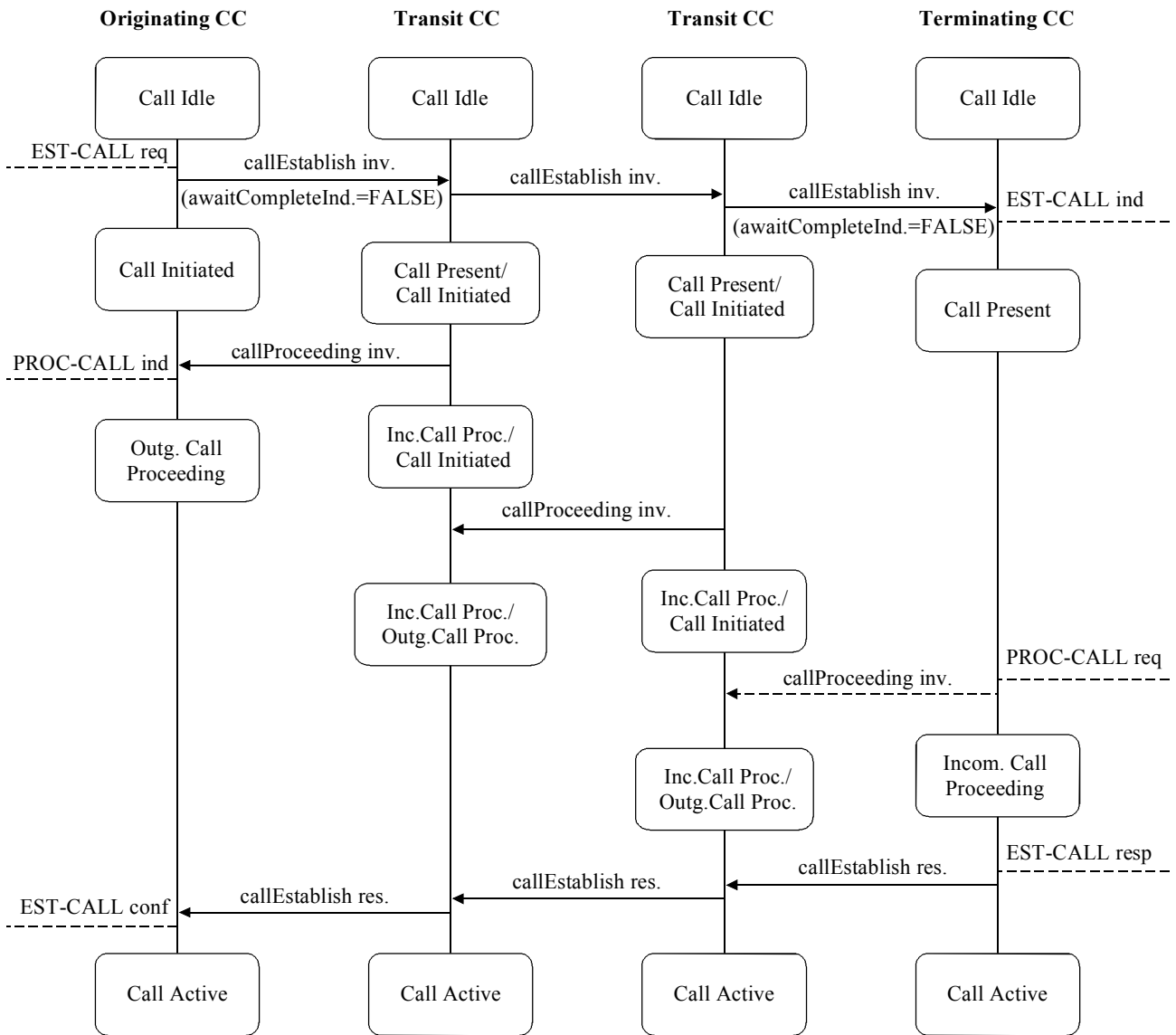

T11102780-99

Figure I.1/Q.2981 – Example information flow for a successful call establishment using a two-message sequence

I.2 Call Establishment using a three-message sequence

See Figure I.2.

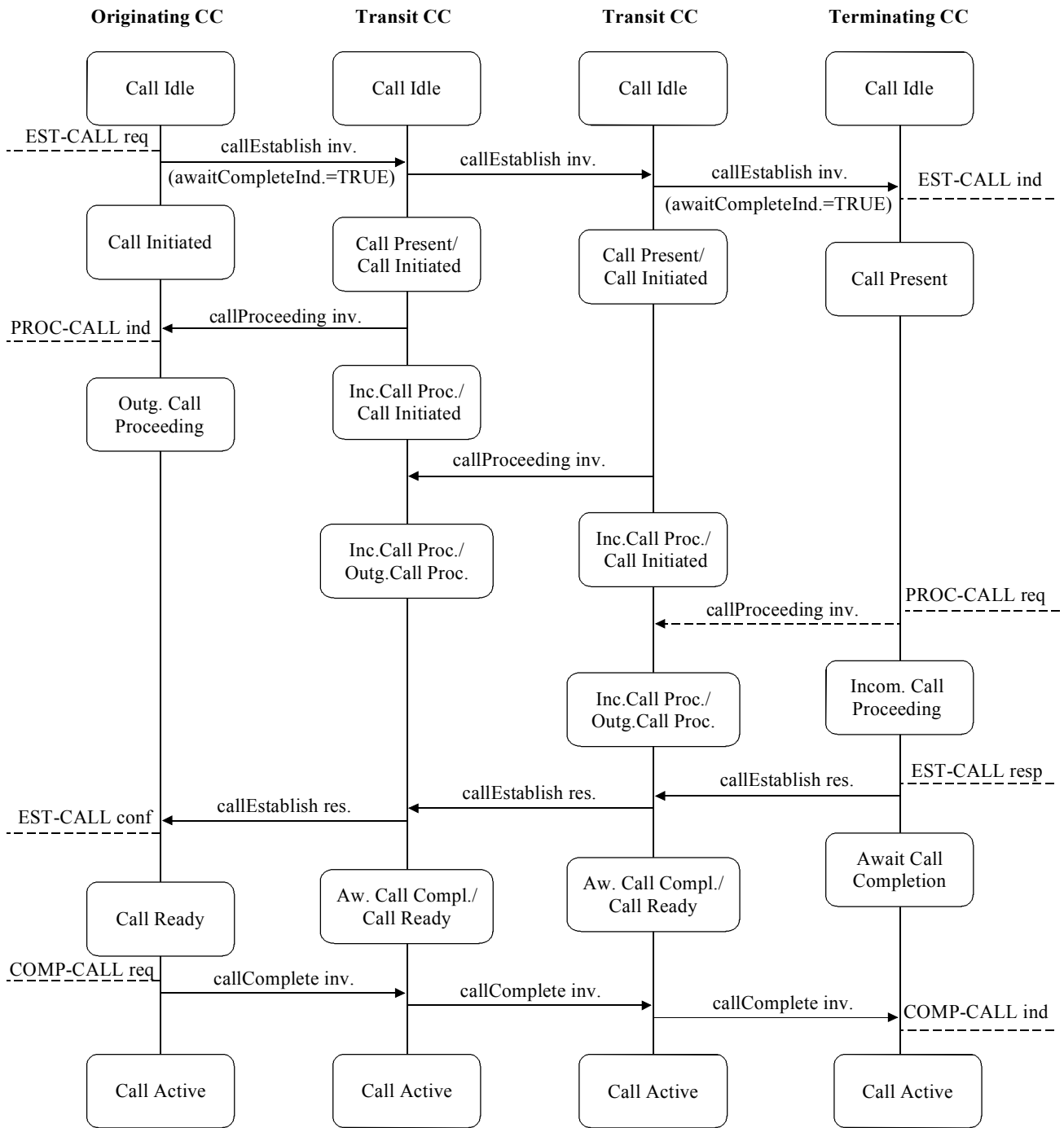

T11102790-99

Figure I.2/Q.2981 – Example information flow for a successful call establishment using a three-message sequence

I.3 Call Release

See Figure I.3.

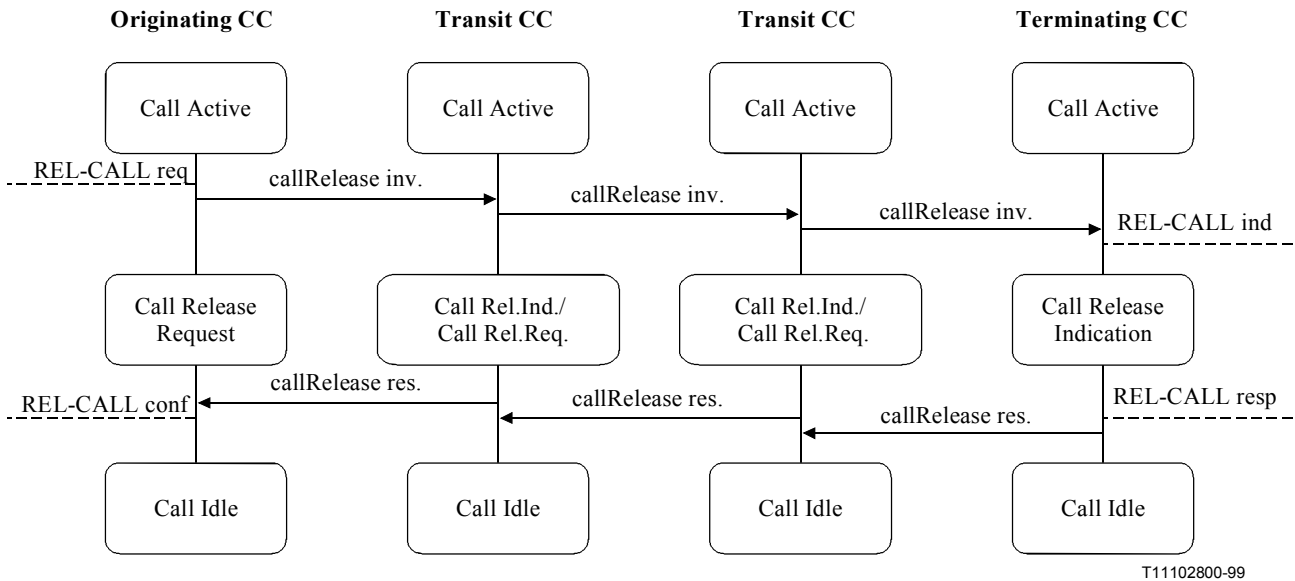

Figure I.3/Q.2981 – Example information flow for call release

APPENDIX II

Imported ASN.1 definitions

Table II.1 is an extract from module Addressing-Data-Elements in Q.932.

Table II.1/Q.2981 – Imported ASN.1 Definitions Addressing-Data-Elements

```
Addressing-Data-Elements {itu-t recommendation q 932
  addressing-data-elements(7)} DEFINITIONS ::=
BEGIN

EXPORTS
  PresentedAddressScreened, PartyNumber, PartySubaddress,
  ScreeningIndicator;

PresentedAddressScreened ::= CHOICE {
  presentationAllowedAddress      [0] IMPLICIT AddressScreened,
  presentationRestricted           [1] IMPLICIT NULL,
  numberNotAvailableDueToInterworking [2] IMPLICIT NULL,
  presentationRestrictedAddress    [3] IMPLICIT AddressScreened}

AddressScreened ::= SEQUENCE {
  partyNumber      PartyNumber,
  screeningIndicator ScreeningIndicator,
  partySubaddress  PartySubaddress OPTIONAL}

PartyNumber ::= CHOICE {
  unknownPartyNumber      [0] IMPLICIT NumberDigits,
  -- the numbering plan is the default numbering plan of
  -- the network.
```

```

-- it is recommended that this values is used.
publicPartyNumber      [1] IMPLICIT PublicPartyNumber,
-- the numbering plan is according to Rec. E.163 and
-- E.164
nsapEncodedNumber      [2] IMPLICIT NsapEncodedNumber,
-- ATM endsystem address encoded as an NSAP address
dataPartyNumber        [3] IMPLICIT NumberDigits,
-- not used, value reserved
telexPartyNumber       [4] IMPLICIT NumberDigits,
-- not used, value reserved
privatePartyNumber     [5] IMPLICIT PrivatePartyNumber,
nationalStandardPartyNumber [8] IMPLICIT NumberDigits}

-- not used, values reserved
PublicPartyNumber ::= SEQUENCE {
    publicTypeOfNumber PublicTypeOfNumber,
    publicNumberDigits NumberDigits}

PrivatePartyNumber ::= SEQUENCE {
    privateTypeOfNumber PrivateTypeOfNumber,
    privateNumberDigits NumberDigits}

NumberDigits ::= NumericString(SIZE (1..20))

PublicTypeOfNumber ::= ENUMERATED {
    unknown(0),
    -- if used number digits carry prefix indicating type of
    -- number according to national recommendations.
    internationalNumber(1), nationalNumber(2),
    networkSpecificNumber(3),
    -- not used, value reserved
    subscriberNumber(4), abbreviatedNumber(6)}

-- valid only for called party number at the outgoing access,
-- network substitutes appropriate number.
PrivateTypeOfNumber ::= ENUMERATED {
    unknown(0), level2RegionalNumber(1), level1RegionalNumber(2),
    pISNSpecificNumber(3), localNumber(4), abbreviatedNumber(6)}

NsapEncodedNumber ::= OCTET STRING(SIZE (1..20))

PartySubaddress ::= CHOICE {
    userSpecifiedSubaddress UserSpecifiedSubaddress,
    -- not recommended
    nSAPSubaddress          NSAPSubaddress}

-- according to Rec. X.213.
UserSpecifiedSubaddress ::= SEQUENCE {
    subaddressInformation SubaddressInformation,
    oddCountIndicator     BOOLEAN OPTIONAL}

-- used when the coding of subaddress is BCD
NSAPSubaddress ::= OCTET STRING(SIZE (1..20))

-- specified according to X.213. some networks may limit
-- the subaddress value to some other length, e.g. 4 octets.
SubaddressInformation ::= OCTET STRING(SIZE (1..20))

-- coded according to user requirements. some networks
-- may limit the subaddress value to some other length,
-- e.g. 4 octets.
ScreeningIndicator ::= ENUMERATED {
    userProvidedNotScreened(0),
    -- number was provided by a remote user terminal

```

```

-- equipment, and has been screened by a network that
-- is not the local public or the local private network.
userProvidedVerifiedAndPassed(1),
-- number was provided by a remote user terminal
-- equipment (or by a remote private network), and has
-- been screened by the local public or the local private
-- network.
userProvidedVerifiedAndFailed(2),
-- not used, value reserved.
networkProvided(3)}

-- number was provided by local public or local private
-- network.
END -- of Addressing-Data-Elements

```

APPENDIX III

Object identifiers defined in this Recommendation

This appendix lists the object identifier values assigned in this Recommendation and data types, values and macros that are exported from any modules identified by those values. All the object identifiers in this Recommendation are defined using the ITU-T object identifier tree. This means that each object identifier value is assigned in the tree:

ccObjectIdTree ::= itu-t recommendation q 2981

Table III.1 lists the module number values and the data types, values and Macros which are exported from these modules.

Table III.1/Q.2981 – ASN.1 Module Object identifiers used in this Recommendation

Object Identifier	Reference	Notes
{ ccObjectIdTree cc-operations (1) }	Table 7	Exports: CcOperations, callSegmentId
{ ccObjectIdTree cc-operations-definitions (2) }	Table 7	
{ ccObjectIdTree cc-operations-errors (3) }	Table 7	
{ ccObjectIdTree call-control-object-super-class (4) }	Table 8	Exports: CALLCONTROBJECTCLASS
{ ccObjectIdTree call-object-class-definitions (5) }	Table 9	Exports: call, localPartyEP, remotePartyEP, directCallAssociation, remoteCallAssociation, serviceComponent, BearerId
{ ccObjectIdTree cc-object-classes (6) }	Table 9	

SERIES OF ITU-T RECOMMENDATIONS

Series A	Organization of the work of ITU-T
Series B	Means of expression: definitions, symbols, classification
Series C	General telecommunication statistics
Series D	General tariff principles
Series E	Overall network operation, telephone service, service operation and human factors
Series F	Non-telephone telecommunication services
Series G	Transmission systems and media, digital systems and networks
Series H	Audiovisual and multimedia systems
Series I	Integrated services digital network
Series J	Transmission of television, sound programme and other multimedia signals
Series K	Protection against interference
Series L	Construction, installation and protection of cables and other elements of outside plant
Series M	TMN and network maintenance: international transmission systems, telephone circuits, telegraphy, facsimile and leased circuits
Series N	Maintenance: international sound programme and television transmission circuits
Series O	Specifications of measuring equipment
Series P	Telephone transmission quality, telephone installations, local line networks
Series Q	Switching and signalling
Series R	Telegraph transmission
Series S	Telegraph services terminal equipment
Series T	Terminals for telematic services
Series U	Telegraph switching
Series V	Data communication over the telephone network
Series X	Data networks and open system communications
Series Y	Global information infrastructure and Internet protocol aspects
Series Z	Languages and general software aspects for telecommunication systems