

# Recommendation **ITU-T Q.4160 (12/2023)**

SERIES Q: Switching and signalling, and associated measurements and tests

Protocols and signalling for Quantum key distribution networks

---

## **Quantum key distribution networks – Protocol framework**



ITU-T Q-SERIES RECOMMENDATIONS

Switching and signalling, and associated measurements and tests

SIGNALLING IN THE INTERNATIONAL MANUAL SERVICE	Q.1-Q.3
INTERNATIONAL AUTOMATIC AND SEMI-AUTOMATIC WORKING	Q.4-Q.59
FUNCTIONS AND INFORMATION FLOWS FOR SERVICES IN THE ISDN	Q.60-Q.99
CLAUSES APPLICABLE TO ITU-T STANDARD SYSTEMS	Q.100-Q.119
SPECIFICATIONS OF SIGNALLING SYSTEMS NO. 4, 5, 6, R1 AND R2	Q.120-Q.499
DIGITAL EXCHANGES	Q.500-Q.599
INTERWORKING OF SIGNALLING SYSTEMS	Q.600-Q.699
SPECIFICATIONS OF SIGNALLING SYSTEM NO. 7	Q.700-Q.799
Q3 INTERFACE	Q.800-Q.849
DIGITAL SUBSCRIBER SIGNALLING SYSTEM NO. 1	Q.850-Q.999
PUBLIC LAND MOBILE NETWORK	Q.1000-Q.1099
INTERWORKING WITH SATELLITE MOBILE SYSTEMS	Q.1100-Q.1199
INTELLIGENT NETWORK	Q.1200-Q.1699
SIGNALLING REQUIREMENTS AND PROTOCOLS FOR IMT-2000	Q.1700-Q.1799
SPECIFICATIONS OF SIGNALLING RELATED TO BEARER INDEPENDENT CALL CONTROL (BICC)	Q.1900-Q.1999
BROADBAND ISDN	Q.2000-Q.2999
SIGNALLING REQUIREMENTS AND PROTOCOLS FOR THE NGN	Q.3000-Q.3709
SIGNALLING REQUIREMENTS AND PROTOCOLS FOR SDN	Q.3710-Q.3899
TESTING SPECIFICATIONS	Q.3900-Q.4099
PROTOCOLS AND SIGNALLING FOR PEER-TO-PEER COMMUNICATIONS	Q.4100-Q.4139
PROTOCOLS AND SIGNALLING FOR COMPUTING POWER NETWORKS	Q.4140-Q.4159
<b>PROTOCOLS AND SIGNALLING FOR QUANTUM KEY DISTRIBUTION NETWORKS</b>	<b>Q.4160-Q.4179</b>
SIGNALLING REQUIREMENTS AND PROTOCOLS FOR IMT-2020	Q.5000-Q.5049
COMBATING COUNTERFEITING AND STOLEN ICT DEVICES	Q.5050-Q.5069

*For further details, please refer to the list of ITU-T Recommendations.*

# Recommendation ITU-T Q.4160

## Quantum key distribution networks – Protocol framework

### Summary

Recommendation ITU-T Q.4160 specifies a framework for signalling and protocols for quantum key distribution network (QKDN).

### History \*

Edition	Recommendation	Approval	Study Group	Unique ID
1.0	ITU-T Q.4160	2023-12-14	11	11.1002/1000/15725

### Keywords

Protocol, protocol suites, QKD (quantum key distribution), QKDN (QKD network).

---

\* To access the Recommendation, type the URL <https://handle.itu.int/> in the address field of your web browser, followed by the Recommendation's unique ID.

## FOREWORD

The International Telecommunication Union (ITU) is the United Nations specialized agency in the field of telecommunications, information and communication technologies (ICTs). The ITU Telecommunication Standardization Sector (ITU-T) is a permanent organ of ITU. ITU-T is responsible for studying technical, operating and tariff questions and issuing Recommendations on them with a view to standardizing telecommunications on a worldwide basis.

The World Telecommunication Standardization Assembly (WTSA), which meets every four years, establishes the topics for study by the ITU-T study groups which, in turn, produce Recommendations on these topics.

The approval of ITU-T Recommendations is covered by the procedure laid down in WTSA Resolution 1.

In some areas of information technology which fall within ITU-T's purview, the necessary standards are prepared on a collaborative basis with ISO and IEC.

## NOTE

In this Recommendation, the expression "Administration" is used for conciseness to indicate both a telecommunication administration and a recognized operating agency.

Compliance with this Recommendation is voluntary. However, the Recommendation may contain certain mandatory provisions (to ensure, e.g., interoperability or applicability) and compliance with the Recommendation is achieved when all of these mandatory provisions are met. The words "shall" or some other obligatory language such as "must" and the negative equivalents are used to express requirements. The use of such words does not suggest that compliance with the Recommendation is required of any party.

## INTELLECTUAL PROPERTY RIGHTS

ITU draws attention to the possibility that the practice or implementation of this Recommendation may involve the use of a claimed Intellectual Property Right. ITU takes no position concerning the evidence, validity or applicability of claimed Intellectual Property Rights, whether asserted by ITU members or others outside of the Recommendation development process.

As of the date of approval of this Recommendation, ITU had not received notice of intellectual property, protected by patents/software copyrights, which may be required to implement this Recommendation. However, implementers are cautioned that this may not represent the latest information and are therefore strongly urged to consult the appropriate ITU-T databases available via the ITU-T website at <http://www.itu.int/ITU-T/ipr/>.

© ITU 2024

All rights reserved. No part of this publication may be reproduced, by any means whatsoever, without the prior written permission of ITU.

## Table of Contents

	<b>Page</b>
1 Scope.....	1
2 References.....	1
3 Definitions .....	1
3.1 Terms defined elsewhere .....	1
3.2 Terms defined in this Recommendation.....	2
4 Abbreviations and acronyms .....	3
5 Conventions .....	3
6 Overview.....	3
7 Protocol suites and stacks .....	5
Appendix I – Signalling procedures.....	7
I.1 Key supply upon request mode .....	7
I.2 Proactive key supply mode.....	7
I.3 Key relay for a distributed QKDN .....	9
I.4 Key relay for a centralized QKDN .....	10
I.5 Key request, key relay, and key supply .....	12
Bibliography.....	15



# Recommendation ITU-T Q.4160

## Quantum key distribution networks – Protocol framework

### 1 Scope

This Recommendation specifies a framework for signalling aspects of a quantum key distribution network (QKDN), especially in the following areas:

- Overview of signalling and protocols for QKDN;
- Protocol suites and stacks for QKDN.

NOTE – QKD protocols which perform between a pair of QKD modules through QKD links are outside the scope of this Recommendation.

### 2 References

The following ITU-T Recommendations and other references contain provisions which, through reference in this text, constitute provisions of this Recommendation. At the time of publication, the editions indicated were valid. All Recommendations and other references are subject to revision; users of this Recommendation are therefore encouraged to investigate the possibility of applying the most recent edition of the Recommendations and other references listed below. A list of the currently valid ITU-T Recommendations is regularly published. The reference to a document within this Recommendation does not give it, as a stand-alone document, the status of a Recommendation.

- [ITU-T X.1710] Recommendation ITU-T X.1710 (2020), *Security framework for quantum key distribution networks*.
- [ITU-T X.1712] Recommendation ITU-T X.1712 (2021), *Security requirements and measures for quantum key distribution networks – key management*.
- [ITU-T Y.3800] Recommendation ITU-T Y.3800 (2019), *Overview on networks supporting quantum key distribution*.
- [ITU-T Y.3801] Recommendation ITU-T Y.3801 (2020), *Functional requirements for quantum key distribution networks*.
- [ITU-T Y.3802] Recommendation ITU-T Y.3802 (2020), *Quantum key distribution networks – Functional architecture*.
- [ITU-T Y.3803] Recommendation ITU-T Y.3803 (2020), *Quantum key distribution networks – Key management*.
- [ITU-T Y.3804] Recommendation ITU-T Y.3804 (2020), *Quantum key distribution networks – Control and management*.

### 3 Definitions

#### 3.1 Terms defined elsewhere

This Recommendation uses the following terms defined elsewhere:

**3.1.1 information theoretically secure (IT-secure)** [ITU-T Y.3800]: Secure against any deciphering attack with unbounded computational resources.

**3.1.2 key management** [ITU-T Y.3800]: All activities performed on keys during their life cycle starting from their reception from the quantum layer, storage, formatting, relay, synchronization, authentication, to supply to a cryptographic application and deletion or preservation depending on the key management policy.

**3.1.3 key manager (KM)** [ITU-T Y.3800]: A functional module located in a quantum key distribution (QKD) node to perform key management in the key management layer.

**3.1.4 key manager link (KM link)** [ITU-T Y.3800]: A communication link connecting key managers (KMs) to perform key management.

**3.1.5 key relay** [ITU-T Y.3800]: A method to share keys between arbitrary quantum key distribution (QKD) nodes via intermediate QKD node(s).

**3.1.6 key supply agent (KSA)** [ITU-T Y.3802]: A functional element to supply keys to a cryptographic application, being located between a key management agent (KMA) and the client.

NOTE – Application interfaces for cryptographic applications are installed into the key supply agent (KSA). The KSA synchronizes keys and verifies their integrity via a KSA link before supplying them to the client.

**3.1.7 key supply agent-key (KSA-key)** [ITU-T Y.3803]: Key data stored and processed in a key supply agent (KSA), and securely shared between a KSA and a matching KSA.

**3.1.8 key management agent (KMA)** [ITU-T Y.3802]: A functional element to manage keys generated by a quantum key distribution (QKD) module/QKD modules in a QKD node (trusted node).

**3.1.9 quantum key distribution (QKD)** [b-ETSI GR QKD 007]: Procedure or method for generating and distributing symmetrical cryptographic keys with information theoretical security based on quantum information theory.

**3.1.10 quantum key distribution link (QKD link)** [ITU-T Y.3800]: A communication link between two quantum key distribution (QKD) modules to operate the QKD.

NOTE – A QKD link consists of a quantum channel for the transmission of quantum signals, and a classical channel used to exchange information for synchronization and key distillation.

**3.1.11 quantum key distribution module (QKD module)** [ITU-T Y.3800]: A set of hardware and software components that implements cryptographic functions and quantum optical processes, including quantum key distribution (QKD) protocols, synchronization, distillation for key generation, and is contained within a defined cryptographic boundary.

NOTE – A QKD module is connected to a QKD link, acting as an endpoint module in which a key is generated. These are two types of QKD modules, namely, the transmitters (QKD-Tx) and the receivers (QKD-Rx).

**3.1.12 quantum key distribution network (QKDN)** [ITU-T Y.3800]: A network comprised of two or more quantum key distribution (QKD) nodes connected through QKD links.

NOTE – A QKDN allows sharing keys between the QKD nodes by a key relay when they are not directly connected by a QKD link.

**3.1.13 quantum key distribution network controller (QKDN controller)** [ITU-T Y.3800]: A functional module, which is located in a quantum key distribution (QKD) network control layer to control a QKD network.

**3.1.14 quantum key distribution network manager (QKDN manager)** [ITU-T Y.3800]: A functional module, which is located in a quantum key distribution (QKD) network management layer to monitor and manage a QKD network.

**3.1.15 quantum key distribution node (QKD node)** [ITU-T Y.3800]: A node that contains one or more quantum key distribution (QKD) modules protected against intrusion and attacks by unauthorized parties.

NOTE – A QKD node can contain a key manager (KM).

## **3.2 Terms defined in this Recommendation**

None.



## 4 Abbreviations and acronyms

This Recommendation uses the following abbreviations and acronyms:

CNCF	Cloud Native Computing Foundation
IT-secure	Information Theoretically-secure
KM	Key Manager
KMA	Key Management Agent
KSA	Key Supply Agent
QKD	Quantum Key Distribution
QKDN	Quantum Key Distribution Network
RPC	Remote Procedure Call

## 5 Conventions

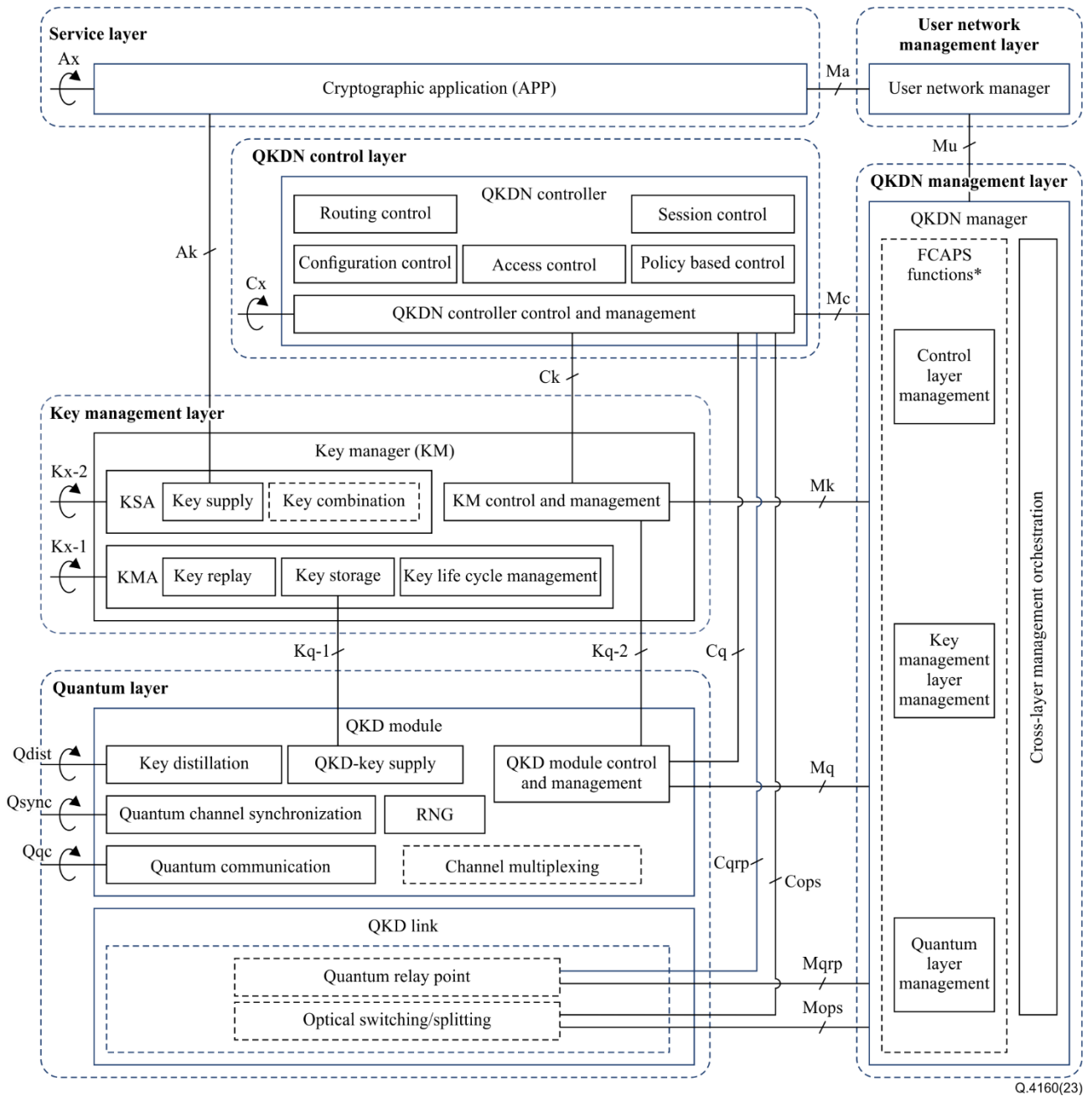
None.

## 6 Overview

Basic functions and layered structures of the QKDN are defined in [ITU-T Y.3800]. Functional requirements and architectures are specified in [ITU-T Y.3801] and [ITU-T Y.3802], respectively. A security framework for the QKDN is specified in [ITU-T X.1710], by addressing the security threats against the QKDN, and deriving the general security requirements and the security measures for the QKDN. Representative signalling procedures and corresponding message parameters are given as protocol examples for some QKDN reference points in [b-ITU-T FG-QIT4N D2.3-Part2].

This Recommendation describes a framework of signalling requirements and protocols for QKDN. Various kinds of protocols can be used in a QKDN. This Recommendation specifies a framework of signalling requirements and protocols for key management layer, QKDN control layer, and QKDN management layer. Protocols for quantum layer which are performed between two QKD modules are outside the scope of this Recommendation.

Figure 1 shows the functional architecture of QKDN which is defined in [ITU-T Y.3802].



**Figure 1 – A functional architecture model of QKDN defined in [ITU-T Y.3802]**

The following reference points are defined in [ITU-T Y.3802].

- reference points of QKD modules: Qqc, Qsync, Qdist
- reference points of KMs: Kq-1, Kq-2, Kx-1, Kx-2
- reference points of QKDN controllers: Ck, Cq, Cops, Cqrp, Cx
- reference points of QKDN managers: Mq, Mops, Mqrp, Mk, Mc, Mu, Mx
- reference points of user network managers: Ma
- reference points of cryptographic applications: Ak, Ax

The functional architecture model in Figure 1 and the above reference points defined in [ITU-T Y.3802] are the references of this Recommendation.

Reference points of Qqc, Qsync, Qdist in the quantum layer, and reference points of Ma, and Ax in the user network are outside the scope of this Recommendation.

## 7 Protocol suites and stacks

This clause specifies protocol suites and stacks of each reference points. Key file format and metadata are defined in [ITU-T Y.3803]. Control and management information is discussed in [ITU-T Y.3804]. Security requirements and measures on key data, metadata and control and management information are specified in [ITU-T X.1712].

Table 1 summarises information which is transferred at each reference point.

**Table 1 – Transferred information at reference points**

Reference points	Transferred information			Note
	Key data	Metadata	Control and management information	
Kq-1	✓	✓	✓	
Kq-2		✓	✓	
Kx-1	✓	✓	✓	Information theoretically-secure (IT)-secure encryption for key relay such as OTP is highly recommended.
Kx-2		✓	✓	
Ck		✓	✓	
Cq		✓	✓	
Cops			✓	
Cqrp			✓	
Cx		✓	✓	
M interfaces			✓	M interfaces includes Mq, Mops, Mqrp, Mk, Mc, Mu and Mx.
Ak	✓	✓		

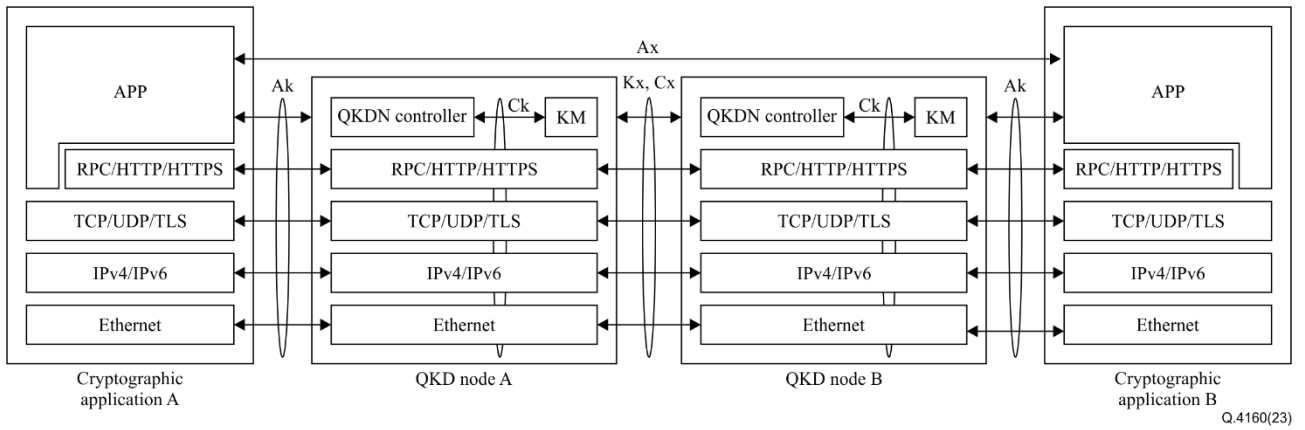
Appropriate protocols can be selected for each reference point and network interface.

Table 2 includes a list of protocols which can be applied at each reference point.

**Table 2 – Protocol suites**

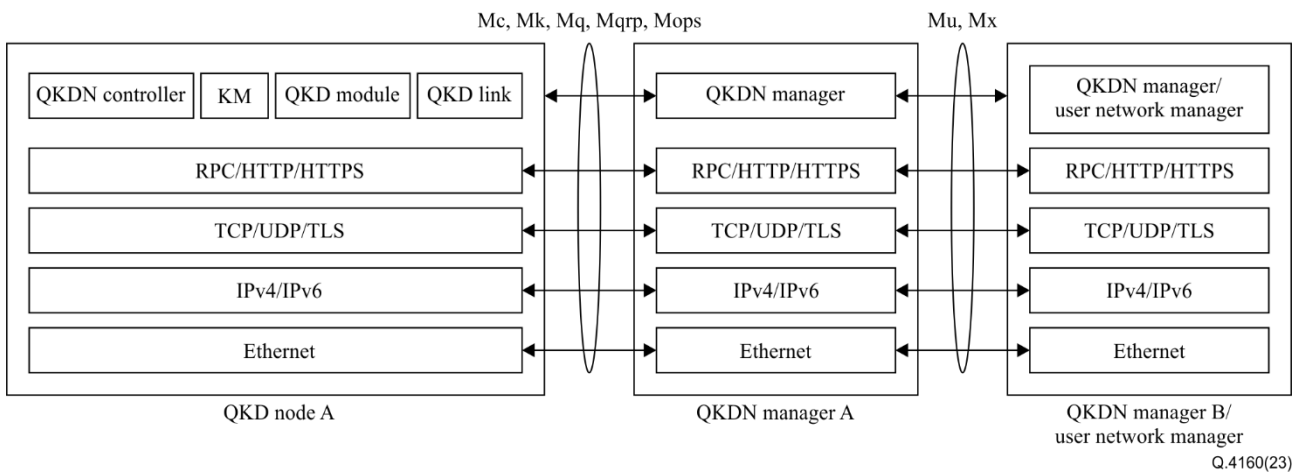
		Reference	Note
High layer protocols	Remote procedure call (RPC) gRPC HTTP/HTTPS	<i>RFC 5531 [b-IETF RFC 5531]</i> Cloud native computing foundation (CNCF) gRPC [b-CNCF gRPC] <i>RFC 9110 [b-IETF RFC 9110]</i>	
L4 protocols	TLS TCP UDP	<i>RFC 5246 [b-IETF RFC 5246]</i> <i>RFC 9293 [b-IETF RFC 9293]</i> <i>RFC 768 [b-IETF RFC 768]</i>	
L3 protocols	IPv4 IPv6	<i>RFC 791 [b-IETF RFC 791]</i> <i>RFC 8200 [b-IETF RFC 8200]</i>	
L2 protocols	Ethernet	<i>IEEE 802.3 [b-IEEE 802.3]</i>	

Figure 2 illustrates protocol stacks for Ak, Ck, Kx and Cx interfaces for QKDN.



**Figure 2 – Protocol stacks for Ak, Ck, Kx and Cx interfaces for QKDN**

Figure 3 illustrates protocol stacks for M interfaces for QKDN.



**Figure 3 – Protocol stacks for M interfaces for QKDN**

# Appendix I

## Signalling procedures

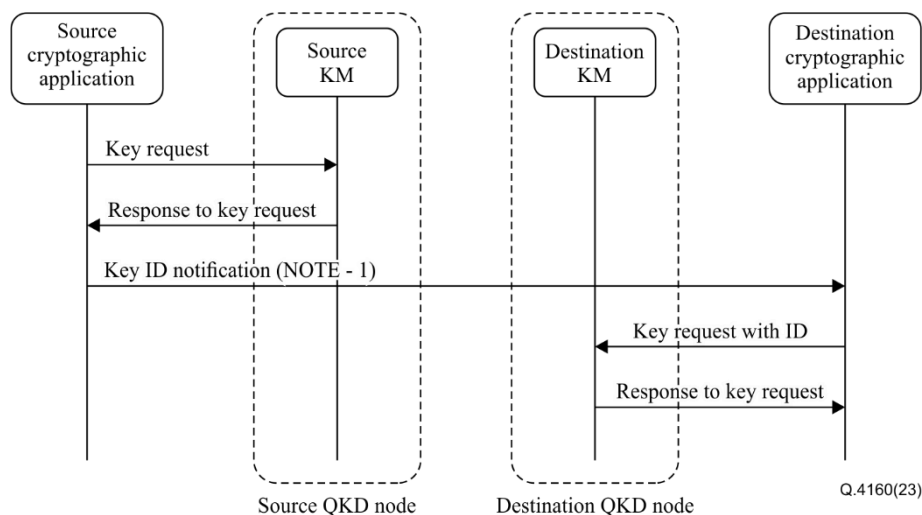
(This appendix does not form an integral part of this Recommendation.)

### I.1 Key supply upon request mode

Figure I.1 shows typical signalling procedures for key supply upon request mode implemented by two QKD nodes.

The typical signalling procedures shown in Figure I.1 are briefly described as follows:

- 1) The source cryptographic application sends a "key request" message to the source KM at the source QKD node.
- 2) The source KM responds "response to key request" message to the source cryptographic application with the keys requested and the corresponding key IDs.
- 3) The source cryptographic application sends a "key ID notification" message to the destination cryptographic application with the key IDs.
- 4) The destination cryptographic application sends a "key request with ID" message with the received key IDs to the destination KM at the destination QKD node.
- 5) The destination KM responds "response to key request" message to the destination cryptographic application with the keys requested.



**Figure I.1 – Typical signalling procedures for key supply upon request mode implemented by two QKD nodes**

NOTE – Key ID notification message is transmitted through the Ax reference point between two cryptographic applications. This signalling message is outside the scope of this Recommendation.

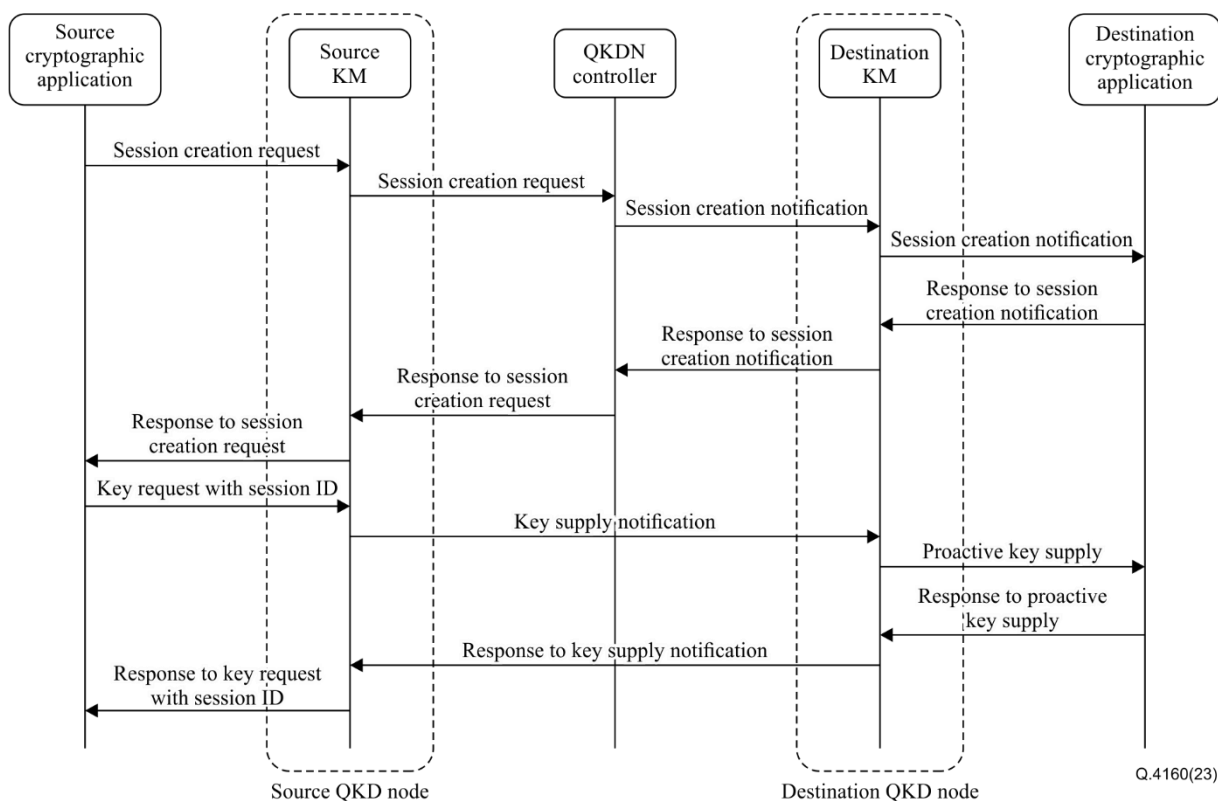
### I.2 Proactive key supply mode

Besides the procedure of key supply upon key request as described in clause I.1, there is another mode at the Ak interface to supply keys proactively. In the mode, the KM at the source QKD node initiates a key supply upon request, and then instructs the KM at the destination QKD node to make a proactive key supply. The proactive key supply mode can be adopted in scenarios where the cryptographic applications on both sides are restricted to having no direct communication before they have KSA-keys.

Figure I.2 shows typical signalling procedures for proactive key supply mode implemented by two QKD nodes.

The typical signalling procedures shown in Figure I.2 are briefly described as follows:

- 1) The source cryptographic application sends a "session creation request" message to the source KM at the source QKD node.
- 2) The source KM sends a "session creation request" message to the corresponding QKDN controller.
- 3) The QKDN controller generates a session ID and sends a "session creation notification" message with the session ID to the destination KM at the destination QKD node. If there are distributed QKDN controllers, the "session creation notification" message will be sent from the QKDN controller at the source QKD node to the QKDN controller at the destination QKD node, and then relayed to the destination KM.
- 4) The destination KM sends a "session creation notification" message with the received session ID to the destination cryptographic application.
- 5) The destination cryptographic application responds "response to session creation notification" message to the destination KM with the session creation result.
- 6) The destination KM responds "response to session creation notification" message to the corresponding QKDN controller with the received session creation result. If there are distributed QKDN controllers, the "response to session creation notification" message will be sent from the destination KM to the QKDN controller at the destination QKD node, and then relayed to the QKDN controller at the source QKD node.
- 7) As the session is successfully created, the QKDN controller responds "response to session creation request" message to the source KM with the session ID in the source QKD node.
- 8) The source KM responds "response to session creation request" message to the source cryptographic application with the received session ID.
- 9) The source cryptographic application sends a "key request with session ID" message to the source KM in the source QKD node with the received session ID.
- 10) The source KM in the source QKD node sends a "key supply notification" message to the destination KM in the destination QKD node with the number of keys to be supplied.
- 11) The destination KM sends a "proactive key supply" message to the destination cryptographic application with the notified number of keys.
- 12) The destination cryptographic application responds "response to proactive key supply" message to the destination KM with the key IDs of the received keys.
- 13) The destination KM responds "response to key supply notification" message to the source KM with the received key IDs.
- 14) The source KM responds "response to key request with session ID" message to the source cryptographic application with keys corresponding to the received key IDs.

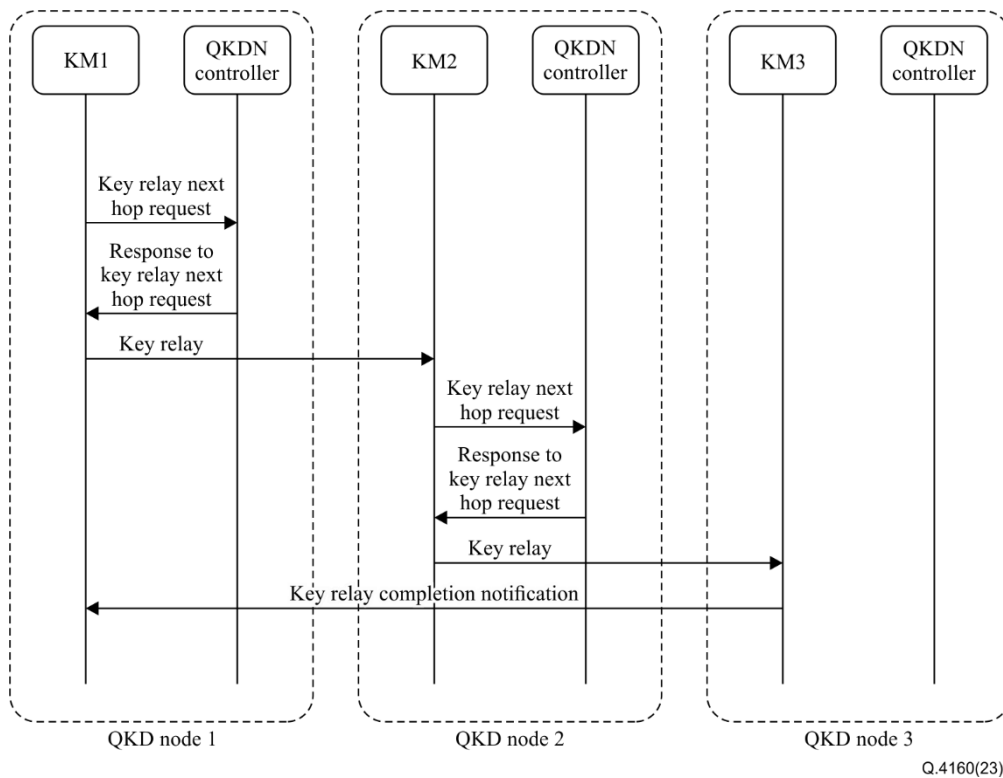


**Figure I.2 – Typical signalling procedures for proactive key supply mode implemented by two QKD nodes**

### I.3 Key relay for a distributed QKDN

Figure I.3 shows typical signalling procedures for key relay for a distributed QKDN which is defined in [ITU-T Y.3802].

- 1) The KM1 sends "key relay next hop request" message to the QKDN controller in the QKD node 1, and the QKDN controller responds "response to key relay next hop request" message with the next hop destination for key relay, then the KM1 relays key along with the response.
- 2) The KM2 and the QKDN controller in the QKD node 2 performs the same procedures as the KM1 of the QKD node 1.
- 3) When the key reaches the destination QKD node which is the nearest node to the destination cryptographic application, the KM (shown as KM3 in the figure) sends a "key relay completion notification" message to the source KM (shown as the KM1 in the figure).
- 4) The nearest KM (shown as KM3 in the figure) responds "response to key request" message with keys.



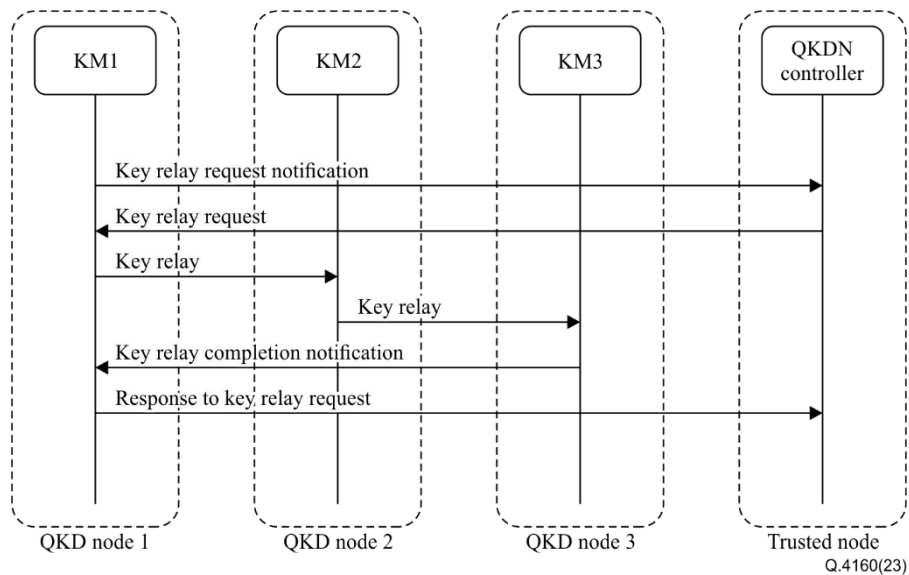
**Figure I.3 – Typical signalling procedures for key relay for a distributed QKDN**

#### I.4 Key relay for a centralized QKDN

Figure I.4a shows typical signalling procedures for key relay for a centralized QKDN which is defined in [ITU-T Y.3802] under the key relay scheme case 2 defined in [ITU-T Y.3803]. KM1 starts signalling procedures for the key relay to the corresponding QKDN controller.

- 1) The KM1 in the QKD node 1 sends a "key relay request notification" message to the QKDN controller in the trusted node, and the QKDN controller responds "key relay request" message with the full key relay route to the destination node.
- 2) The KM1 starts the key relay according to the key relay route. The KM1 sends a "key relay" message to the KM2 in the QKD node 2.
- 3) The KM2 in QKD node 2 performs a key relay to the KM3 in the QKD node 3 according to the key relay route.
- 4) When the key reaches the destination QKD node which is the nearest node to the destination cryptographic application, the KM (shown as KM3 in the figure) sends "key relay completion notification" message to the source KM (shown as KM1 in the figure), then the KM1 sends "response to key relay request" message to the QKDN controller in the trusted node.

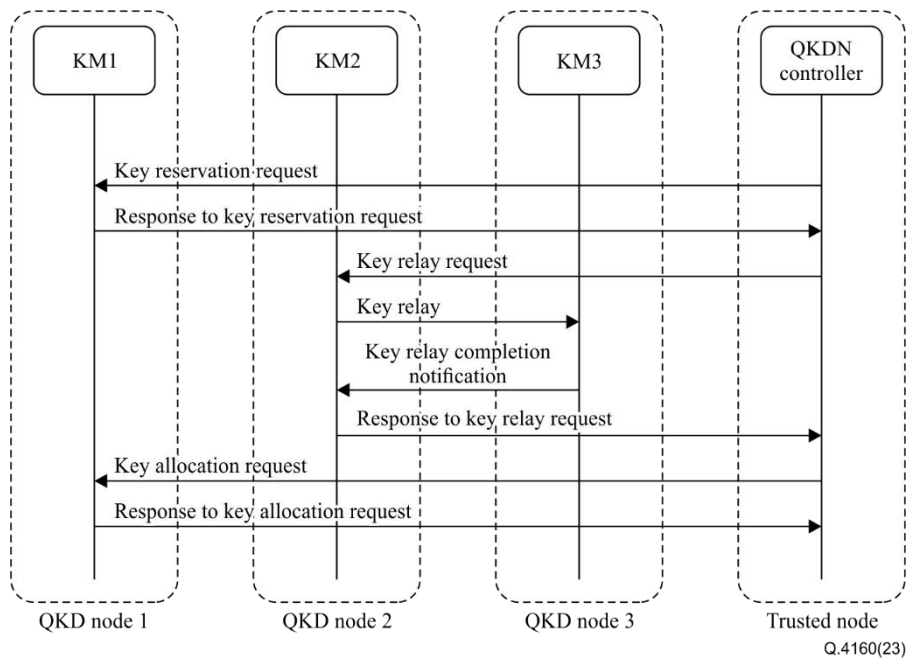




**Figure I.4a – Typical signalling procedures for key relay for a centralized QKDN**

Figure I.4b shows typical signaling procedures for key relay for a centralized QKDN with key reservation under the key relay scheme case 1 in [ITU-T Y.3803].

- 1) The QKDN controller sends a "key reservation request" to the KM1 to reserve the key that will be relayed to the destination KM. The KM1 sends a response to the QKDN controller by "response to key reservation request".
- 2) Then the corresponding QKDN controller sends a "key relay request" message to the KM2 with the full key relay route to the destination node, and the KM2 starts the key relay.
- 3) When the key reaches the destination QKD node which is the nearest node to the destination cryptographic application, the KM (shown as KM3 in the figure) sends "key relay completion notification" message to the source KM (shown as KM2 in the figure), then the KM2 sends "response to key relay request" message to the QKDN controller in the trusted node.
- 4) The QKDN controller sends a "key allocation request" to allocate the reserved key to share with the destination KM3, and KM1 responds to the QKDN controller with "response to key allocation request" message in the trusted node.

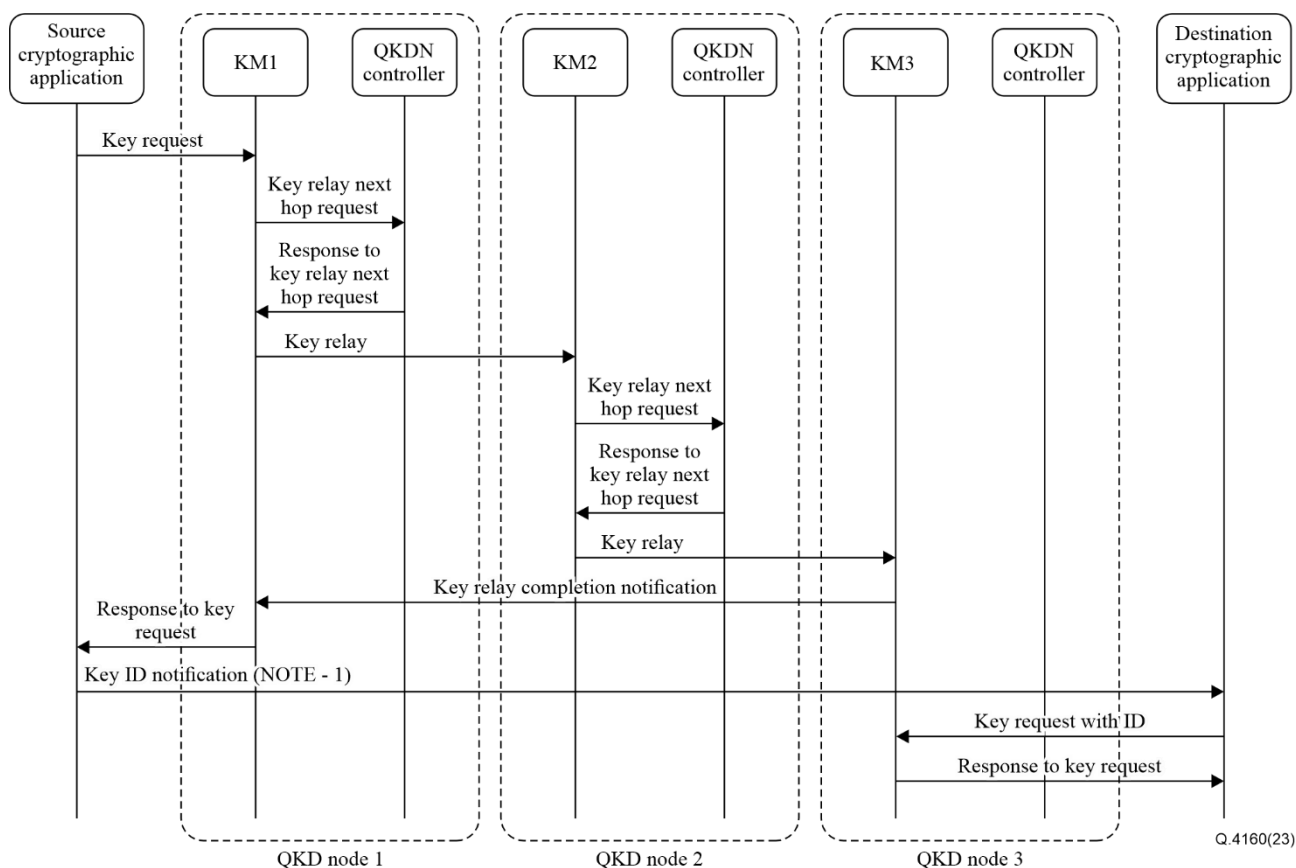


**Figure I.4b – Typical signalling procedures for key relay for a centralized QKDN with key reservation**

### I.5 Key request, key relay, and key supply

Figure I.5a shows typical signalling procedures for key request, key relay, and key supply for a distributed QKDN which is defined in [ITU-T Y.3802].

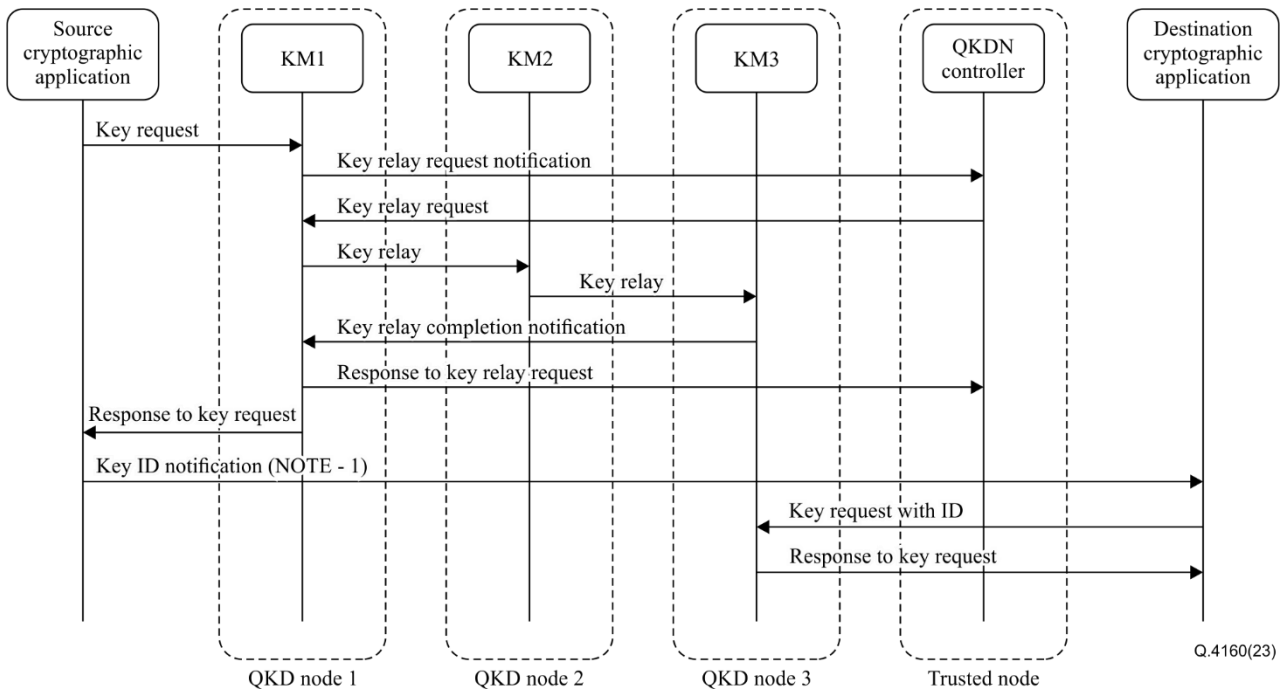
- 1) The source cryptographic application sends a "key request" message to the KM1 in the QKD node 1, which is the nearest node of the source cryptographic application.
- 2) The KM1 sends "key relay next hop request" message to the QKDN controller in the QKD node 1, and the QKDN controller responds "response to key relay next hop request" message with the next hop destination for key relay, then the KM1 relays the key along with the response to the KM2.
- 3) The KM2 and the QKDN controller in the QKD node 2 performs the same procedures as the KM1 of the QKD node 1.
- 4) When the key reaches the destination QKD node which is the nearest node to the destination cryptographic application, the KM (shown as KM3 in the figure) sends "key relay completion notification" message to the source KM (shown as the KM1 in the figure), then the KM1 responds "response to key request" message to the source cryptographic application with keys.
- 5) The source cryptographic application sends a "key ID notification" message to the destination cryptographic application with a key ID.
- 6) The destination cryptographic application sends a "key request with ID" message with key ID which was received from the source cryptographic application (see step 5) to the nearest KM (shown as KM3 in the figure).
- 7) The nearest KM (shown as KM3 in the figure) responds "response to key request" message with keys to the destination cryptographic application.



**Figure I.5a – Typical signalling procedures for key request, key relay, and key supply for distributed QKDNs**

Figure I.5b shows typical signalling procedures for key request, key relay, and key supply for a centralized QKDN which is defined in [ITU-T Y.3802].

- 1) The source cryptographic application sends "key request" message to the KM1 in the QKD node 1, which is the nearest node of the source cryptographic application.
- 2) The KM1 sends "key relay request notification" message to the QKDN controller in the trusted node, and the QKDN controller responds "key relay request" message with the full key relay route to the destination node.
- 3) The KM1 starts key relay along with the key relay route. The KM2 in QKD node 2 performs key relay according to the key relay route.
- 4) When the key reaches the destination QKD node which is the nearest node to the destination cryptographic application, the KM (shown as KM3 in the figure) sends "key relay completion notification" message to the source KM (shown as KM1 in the figure), then the KM1 sends "response to key relay request" message to the QKDN controller in the trusted node, and also responds "response to key request" message to the source cryptographic application with keys.
- 5) The source cryptographic application sends "key ID notification" message to the destination cryptographic application with the key ID.
- 6) The destination cryptographic application sends "key request with ID" message with a key ID which was received from the source cryptographic application (see step 5) to the nearest KM (shown as KM3 in the figure).
- 7) The nearest KM (shown as KM3 in the figure) responds "response to key request" message with keys to the destination cryptographic application.



**Figure I-5b – Typical signalling procedures for key request, key relay, and key supply for centralized QKDNs**

NOTE 1 – Key ID notification message is transmitted through the Ax reference point between two cryptographic applications. This signalling message is outside the scope of this Recommendation.

NOTE 2 – Figures I.5a and I.5b illustrate signalling procedures for case 2 of the key relay scheme which is specified in [ITU-T Y.3803].

## Bibliography

- [b-ITU-T FG-QIT4N D2.3-Part2] Technical Report ITU-T FG QIT4N D2.3-Part 2 (2021), *Quantum key distribution network protocols: Key management layer, QKDN control layer and QKDN management layer.*
- [b-CNCF gRPC] gRPC.  
<<https://grpc.io/docs/what-is-grpc/>>  
<<https://www.cnfc.io/projects/grpc/>>
- [b-ETSI GR QKD 007] ETSI GR QKD 007 V1.1.1 (2018), *Quantum Key Distribution (QKD); Vocabulary.*  
<[https://www.etsi.org/deliver/etsi\\_gr/QKD/001\\_099/007/01.01.01\\_60/gr\\_QKD007v010101p.pdf](https://www.etsi.org/deliver/etsi_gr/QKD/001_099/007/01.01.01_60/gr_QKD007v010101p.pdf)>
- [b-IEEE 802.3] IEEE 802.3-2018, *IEEE Standard for Ethernet.*  
<<https://standards.ieee.org/ieee/802.3/7071/>>
- [b-IETF RFC 768] IETF RFC 768 (1980), *User Datagram Protocol.*  
<<https://datatracker.ietf.org/doc/html/rfc768/>>
- [b-IETF RFC 791] IETF RFC 791 (1981), *Internet Protocol.*  
<<https://datatracker.ietf.org/doc/html/rfc791/>>
- [b-IETF RFC 5246] IETF RFC 5246 (2008), *The Transport Layer Security (TLS) Protocol Version 1.2.*  
<<https://datatracker.ietf.org/doc/html/rfc5246/>>
- [b-IETF RFC 5531] IETF RFC 5531 (2009), *RPC: Remote Procedure Call Protocol Specification Version 2.*  
<<https://datatracker.ietf.org/doc/html/rfc5531/>>
- [b-IETF RFC 8200] IETF RFC 8200 (2017), *Internet Protocol, Version 6 (IPv6) Specification.*  
<<https://datatracker.ietf.org/doc/html/rfc8200/>>
- [b-IETF RFC 9110] IETF RFC 9110 (2022), *HTTP Semantics.*  
<<https://datatracker.ietf.org/doc/rfc9110/>>
- [b-IETF RFC 9293] IETF RFC 9293 (2022), *Transmission Control Protocol (TCP).*  
<<https://datatracker.ietf.org/doc/html/rfc9293/>>





## SERIES OF ITU-T RECOMMENDATIONS

Series A	Organization of the work of ITU-T
Series D	Tariff and accounting principles and international telecommunication/ICT economic and policy issues
Series E	Overall network operation, telephone service, service operation and human factors
Series F	Non-telephone telecommunication services
Series G	Transmission systems and media, digital systems and networks
Series H	Audiovisual and multimedia systems
Series I	Integrated services digital network
Series J	Cable networks and transmission of television, sound programme and other multimedia signals
Series K	Protection against interference
Series L	Environment and ICTs, climate change, e-waste, energy efficiency; construction, installation and protection of cables and other elements of outside plant
Series M	Telecommunication management, including TMN and network maintenance
Series N	Maintenance: international sound programme and television transmission circuits
Series O	Specifications of measuring equipment
Series P	Telephone transmission quality, telephone installations, local line networks
<b>Series Q</b>	<b>Switching and signalling, and associated measurements and tests</b>
Series R	Telegraph transmission
Series S	Telegraph services terminal equipment
Series T	Terminals for telematic services
Series U	Telegraph switching
Series V	Data communication over the telephone network
Series X	Data networks, open system communications and security
Series Y	Global information infrastructure, Internet protocol aspects, next-generation networks, Internet of Things and smart cities
Series Z	Languages and general software aspects for telecommunication systems