



INTERNATIONAL TELECOMMUNICATION UNION

**ITU-T**

TELECOMMUNICATION  
STANDARDIZATION SECTOR  
OF ITU

**Q.614**

(03/93)

**INTERWORKING OF SIGNALLING SYSTEMS**

---

**INTERWORKING OF SIGNALLING SYSTEMS –  
LOGIC PROCEDURES FOR INCOMING  
SIGNALLING SYSTEM No. 7 (TUP)**

**ITU-T Recommendation Q.614**

(Previously “CCITT Recommendation”)

---

## FOREWORD

The ITU Telecommunication Standardization Sector (ITU-T) is a permanent organ of the International Telecommunication Union. The ITU-T is responsible for studying technical, operating and tariff questions and issuing Recommendations on them with a view to standardizing telecommunications on a worldwide basis.

The World Telecommunication Standardization Conference (WTSC), which meets every four years, established the topics for study by the ITU-T Study Groups which, in their turn, produce Recommendations on these topics.

ITU-T Recommendation Q.614 was revised by the ITU-T Study Group XI (1988-1993) and was approved by the WTSC (Helsinki, March 1-12, 1993).

---

## NOTES

1 As a consequence of a reform process within the International Telecommunication Union (ITU), the CCITT ceased to exist as of 28 February 1993. In its place, the ITU Telecommunication Standardization Sector (ITU-T) was created as of 1 March 1993. Similarly, in this reform process, the CCIR and the IFRB have been replaced by the Radiocommunication Sector.

In order not to delay publication of this Recommendation, no change has been made in the text to references containing the acronyms "CCITT, CCIR or IFRB" or their associated entities such as Plenary Assembly, Secretariat, etc. Future editions of this Recommendation will contain the proper terminology related to the new ITU structure.

2 In this Recommendation, the expression "Administration" is used for conciseness to indicate both a telecommunication administration and a recognized operating agency.

© ITU 1994

All rights reserved. No part of this publication may be reproduced or utilized in any form or by any means, electronic or mechanical, including photocopying and microfilm, without permission in writing from the ITU.

**Recommendation Q.614**

**INTERWORKING OF SIGNALLING SYSTEMS – LOGIC PROCEDURES  
FOR INCOMING SIGNALLING SYSTEM No. 7 (TUP)**

*(Geneva, 1980, modified at Helsinki, 1993)*

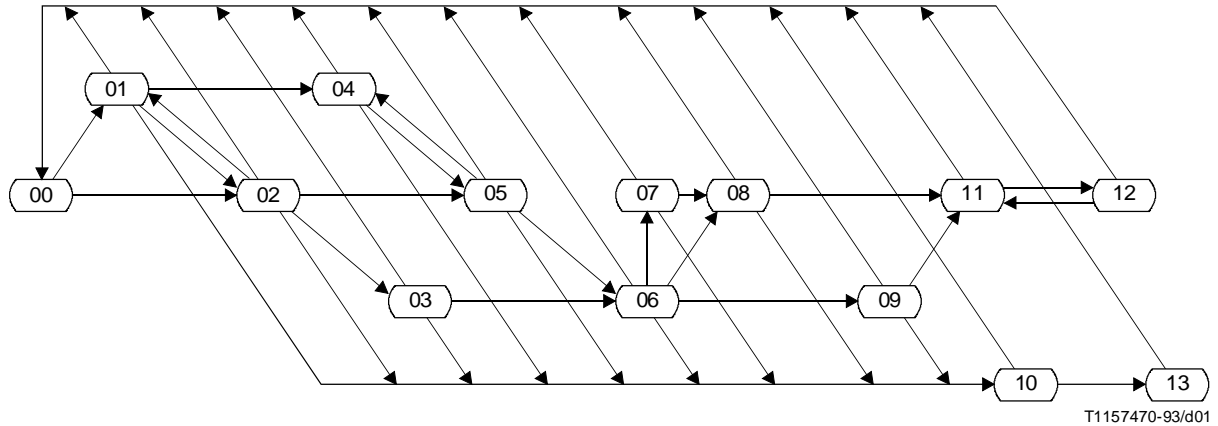

State number	State description	Sheet reference	Timers running
00	Idle	1, 13	
01	Wait for further digits	2	$t_1, t_2$
02	Wait for digit analysis	4	$t_1, t_2$ or $t_3$
03	Wait for continuity check (COT)	7	$t_1, t_2$ or $t_3$
04	Wait for further digits (COT received)	3	$t_2$
05	Wait for digit analysis (COT received)	3	$t_2$ or $t_3$
06	Wait for address complete (COT received)	9	$t_2$ or $t_3$
07	Wait for register deactivation	10	
08	Address complete – Wait for answer	12	
09	Address complete, subscriber free – Wait for answer	13	
10	Call unsuccessful – Wait for clear-forward	11	$t_4$
11	Answered	13	
12	Clear-back	13	
13	Call failure wait for clear forward	11	

FIGURE 1/Q.614

State overview diagram for incoming Signalling System No. 7 (TUP)

**Supervisory timers for incoming Signalling System No. 7 (TUP)**

$t_1 = 10 - 15$ s	6.4.2, a)/Q.724	$t_4 = 4 - 15$ s	6.4.2 b)/Q.724
$t_2 = 15 - 20$ s	1.7/Q.724	$t_5 = 1$ min	6.4.2 b)/Q.724
$t_3 = 20 - 30$ s	6.4.3/Q.724		

**Procedures not shown**

The following procedures, not directly relevant to interworking, are not shown in the logic procedures:

- dual seizure;
- blocking and unblocking sequences;
- user part selection (see Note);
- confusion and message refusal signals;
- reset circuit procedures;
- test call procedures;
- out of service;
- national procedures.

## Signal abbreviations used

The signal abbreviations used correspond to those of the Signalling System No. 7 specifications unless otherwise indicated on the same sheet.

The signal abbreviations used are listed below with their meanings:

ACM	Address complete message
ADC	Address complete, charge
ADI	Address incomplete
ADN	Address complete, no charge
ADX	Address complete, coin box
AFC	Address complete, subscriber free, charge
AFN	Address complete, subscriber free, no charge
AFX	Address complete, subscriber free, coin box
ANC	Answer charge
ANN	Answer no charge
CBK	Clear-back signal
CCF	Continuity-failure signal
CCH	Continuity check indicator
CFL	Call failure
CGC	Circuit group congestion
CLF	Clear-forward signal
COT	Continuity
CPCI	Calling party category indicator
ESI	Echo suppressor indicator
FOT	Forward-transfer signal
IAM	Initial address message
LOS	Line-out-of-service
NCI	Nature of circuit indicator
NNC	National network congestion
NAI	Nature of address indicator
RAN	Re-answer signal
RLG	Release-guard signal
SAM	Subsequent address message
SAO	Subsequent address message with one address digit
SEC	Switching equipment congestion
SSB	Subscriber busy
SST	Send special information tone
UNN	Unallocated number

NOTE – This SDL diagram relates only to the International Telephony User Part (TUP) specified for Signalling System No. 7 in Recommendations Q.721-Q.725. The selection of the TUP is assumed to have been made on a per message basis by the Level 3 message distribution process.

FIGURE 2/Q.614

### Notes to incoming Signalling System No. 7 (TUP)

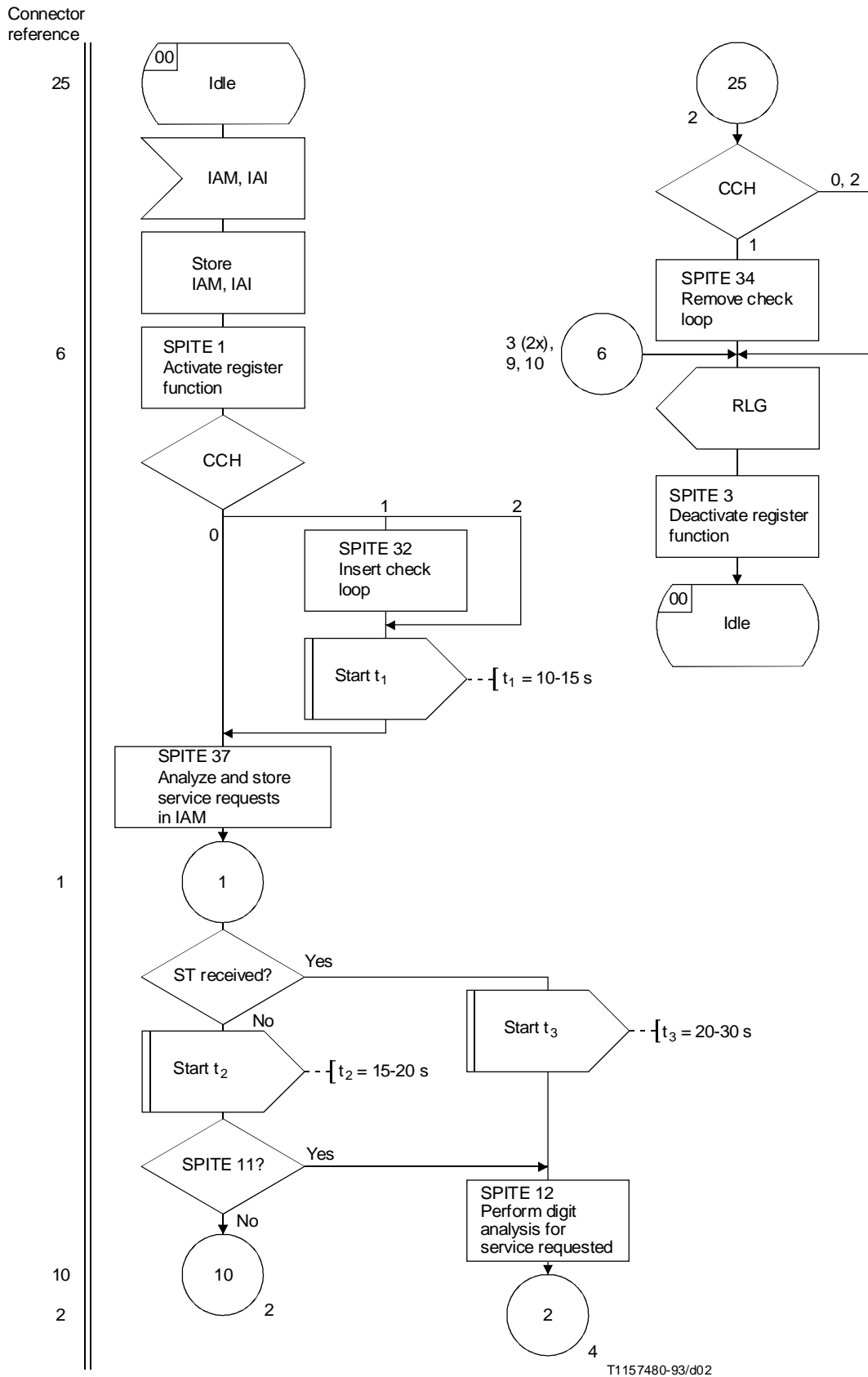

FIGURE 3/Q.614 (sheet 1 of 14)  
**Incoming Signalling System No. 7 (TUP)**

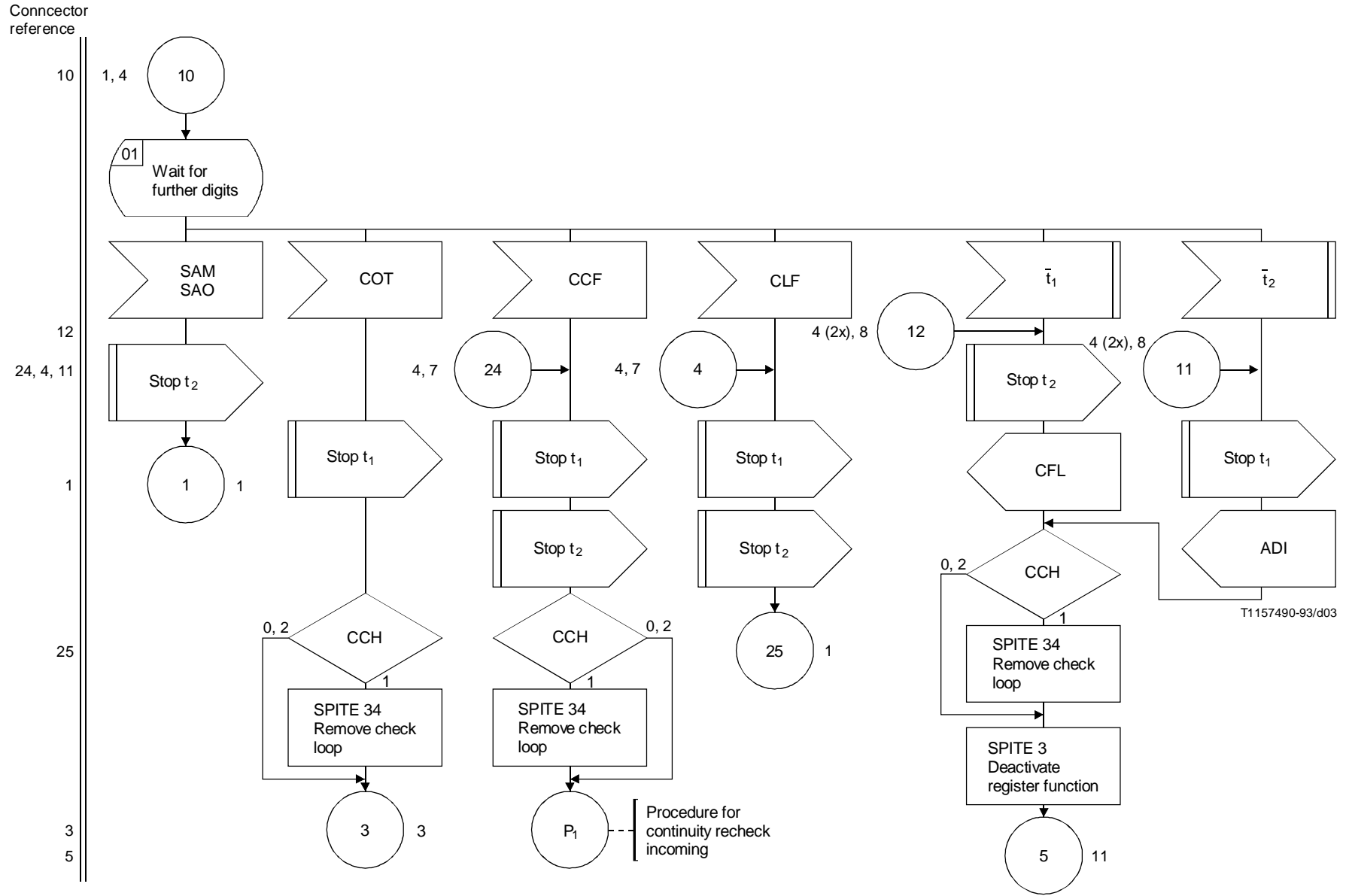
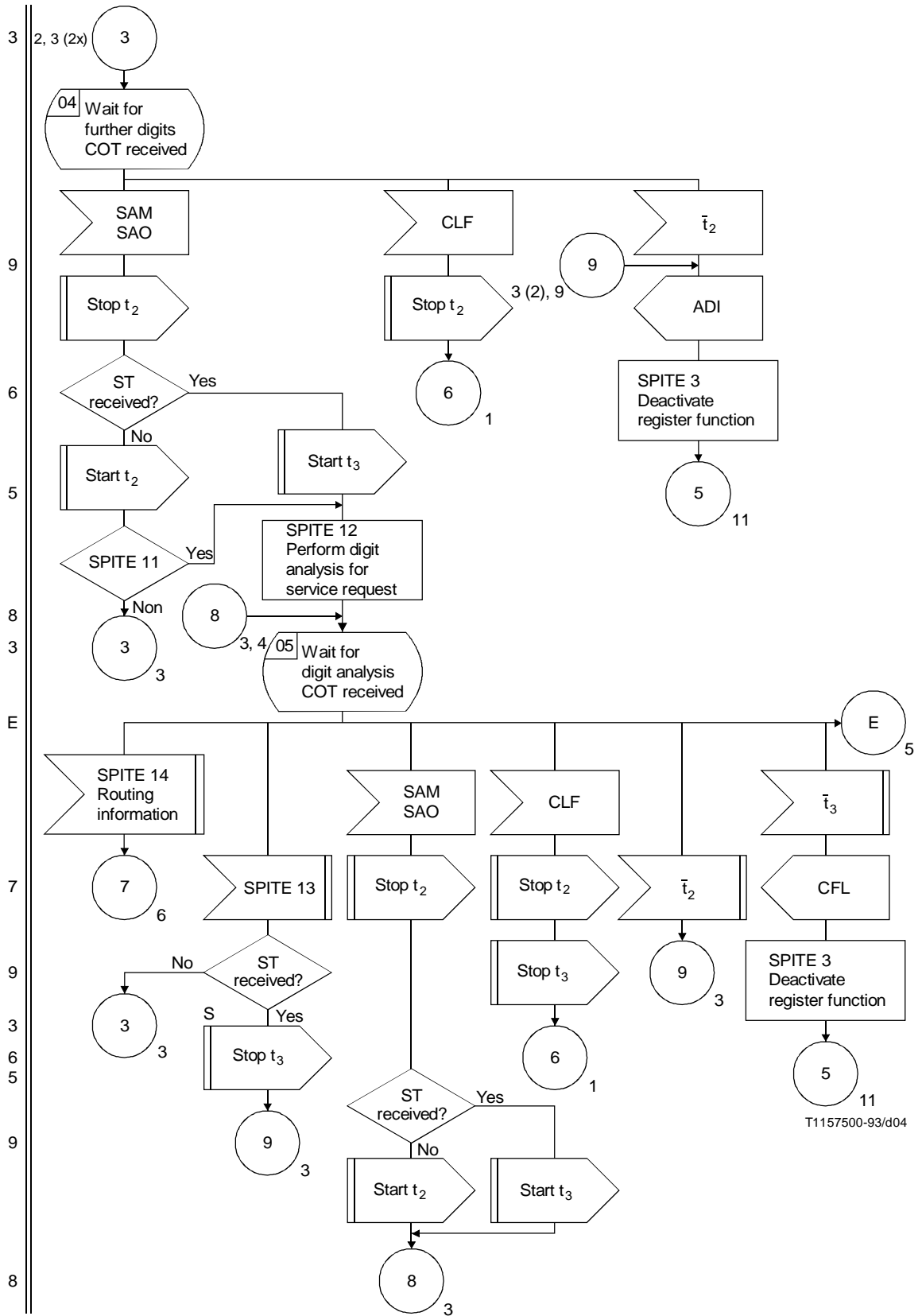

FIGURE 3/Q.614 (sheet 2 of 14)  
**Incoming Signalling System No. 7 (TUP)**

Connector reference



T1157500-93/d04

FIGURE 3/Q.614 (sheet 3 of 14)  
Incoming Signalling System No. 7 (TUP)

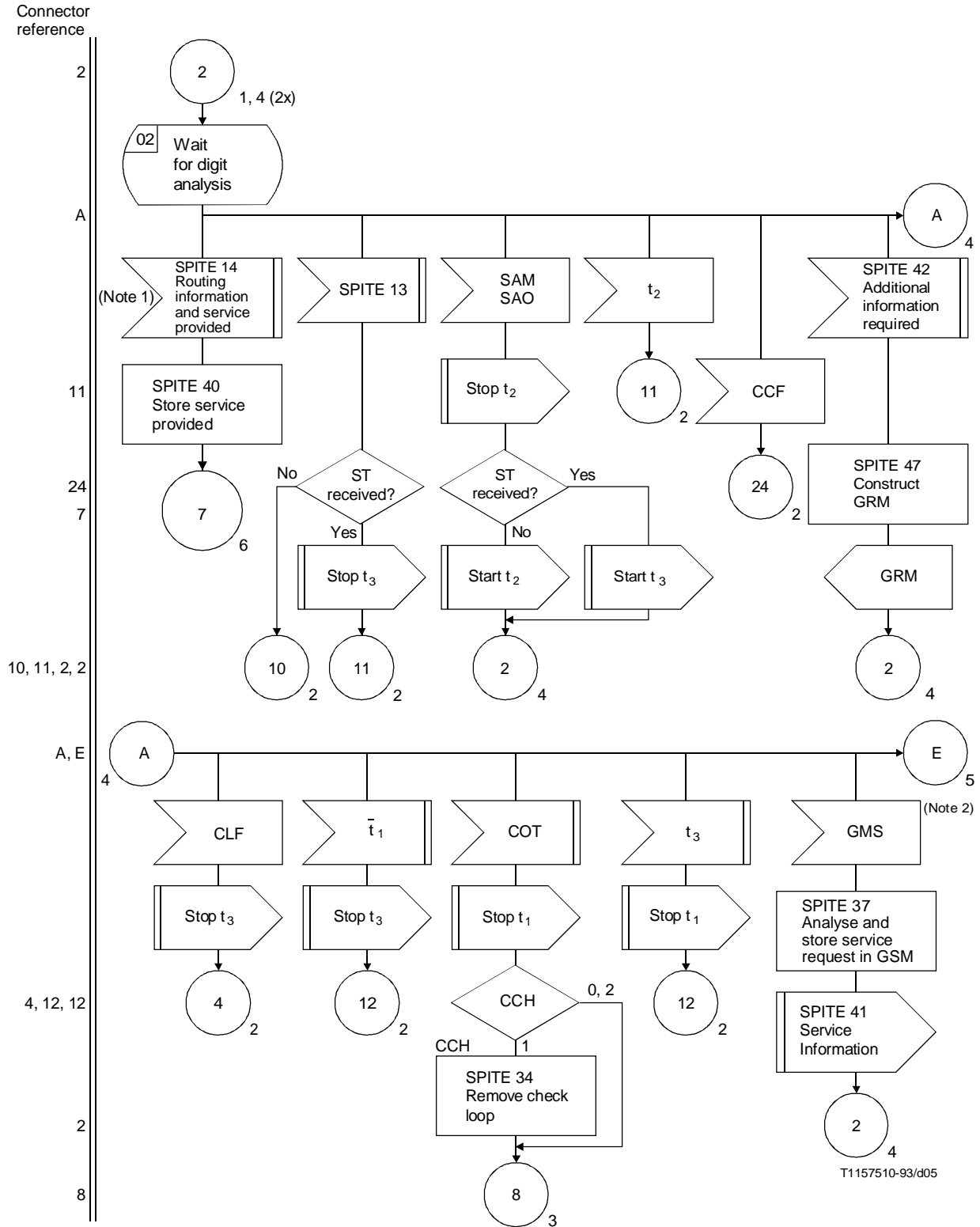

NOTES

- 1 It is assumed that if a transit exchange has requested additional information, then routing information will not be received until after the requested information has been received.
- 2 It is assumed that GRQ was sent.

FIGURE 3/Q.614 (sheet 4 of 14)  
**Incoming Signalling System No. 7 (TUP)**



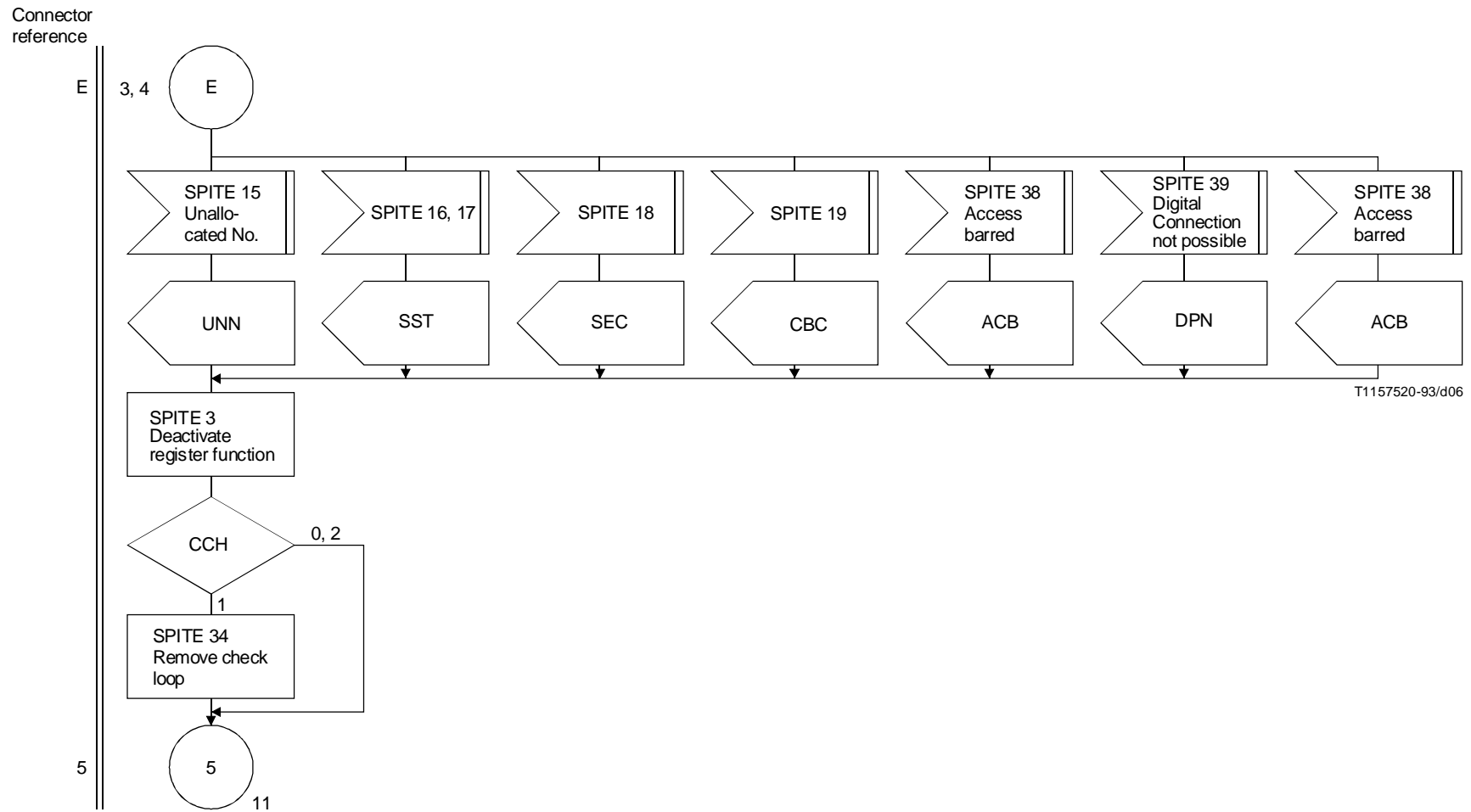

NOTE – It is assumed that if a transit exchange has requested additional information then routing information will not be received until after the requested information has been received.

FIGURE 3/Q.614 (sheet 5 of 14)  
**Incoming Signalling System No. 7 (TUP)**

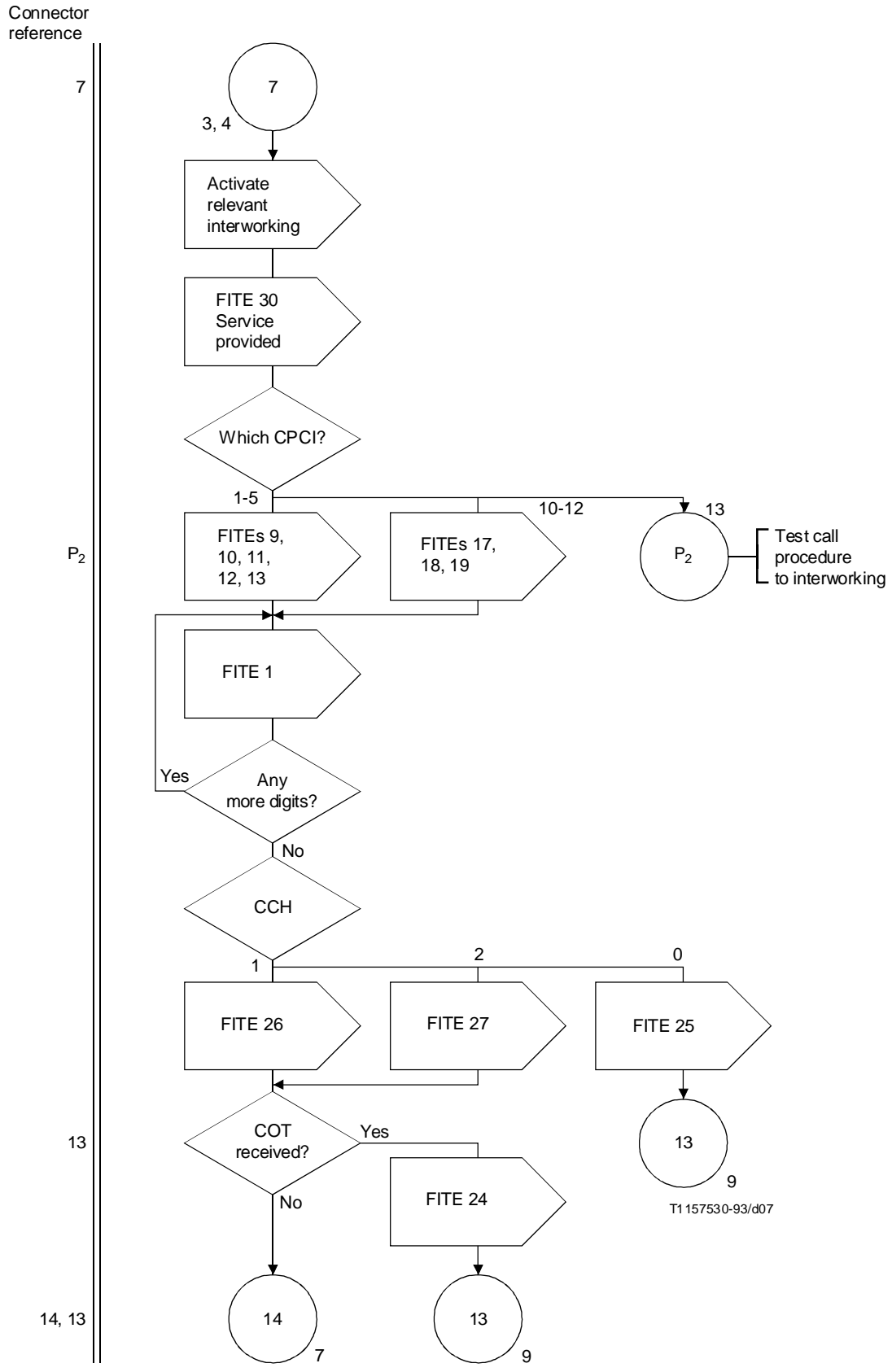
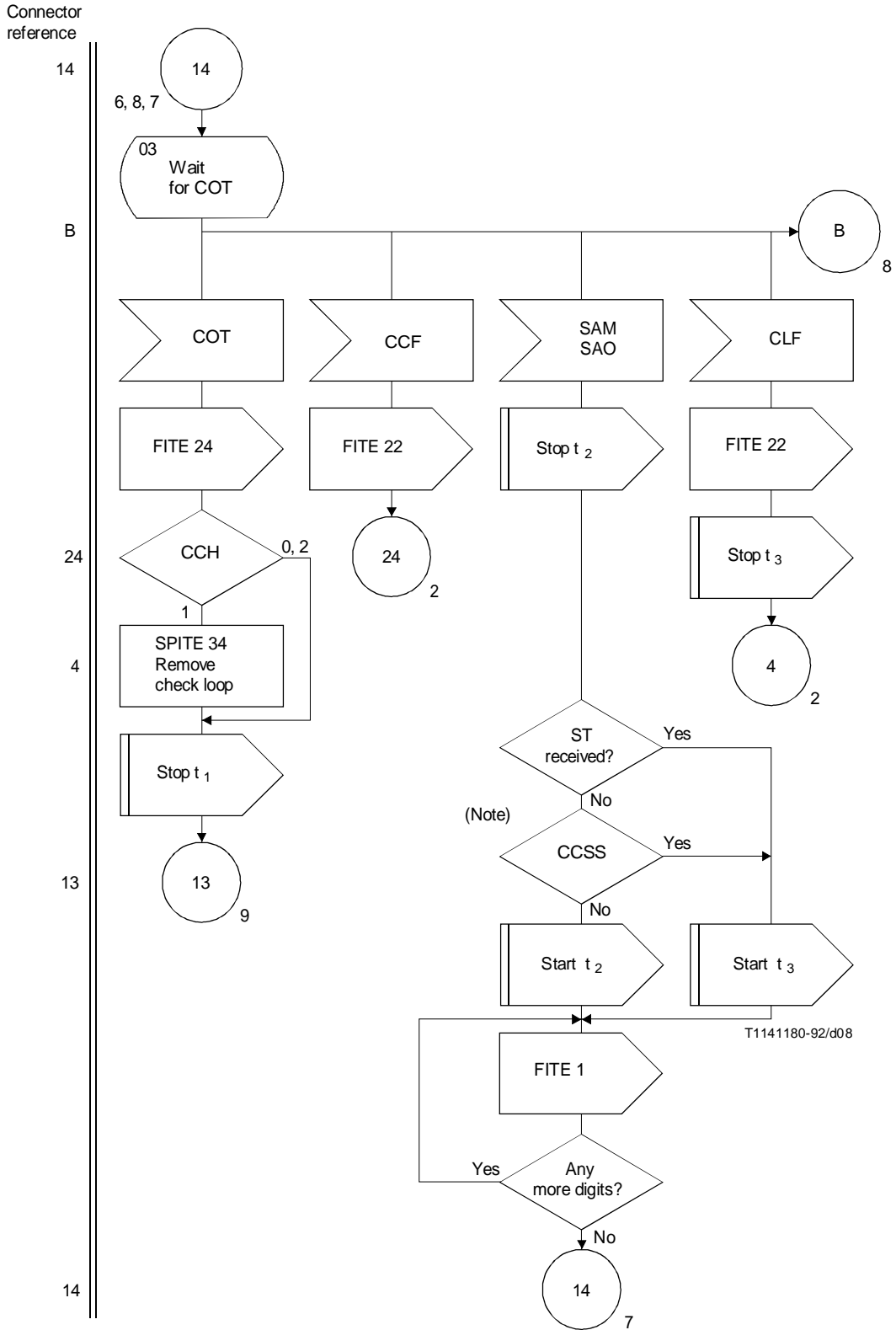

FIGURE 3/Q.614 (sheet 6 of 14)  
**Incoming Signalling System No. 7 (TUP)**



NOTE – Is outgoing link common channel signalling system?

FIGURE 3/Q.614 (sheet 7 of 14)  
**Incoming Signalling System No. 7 (TUP)**

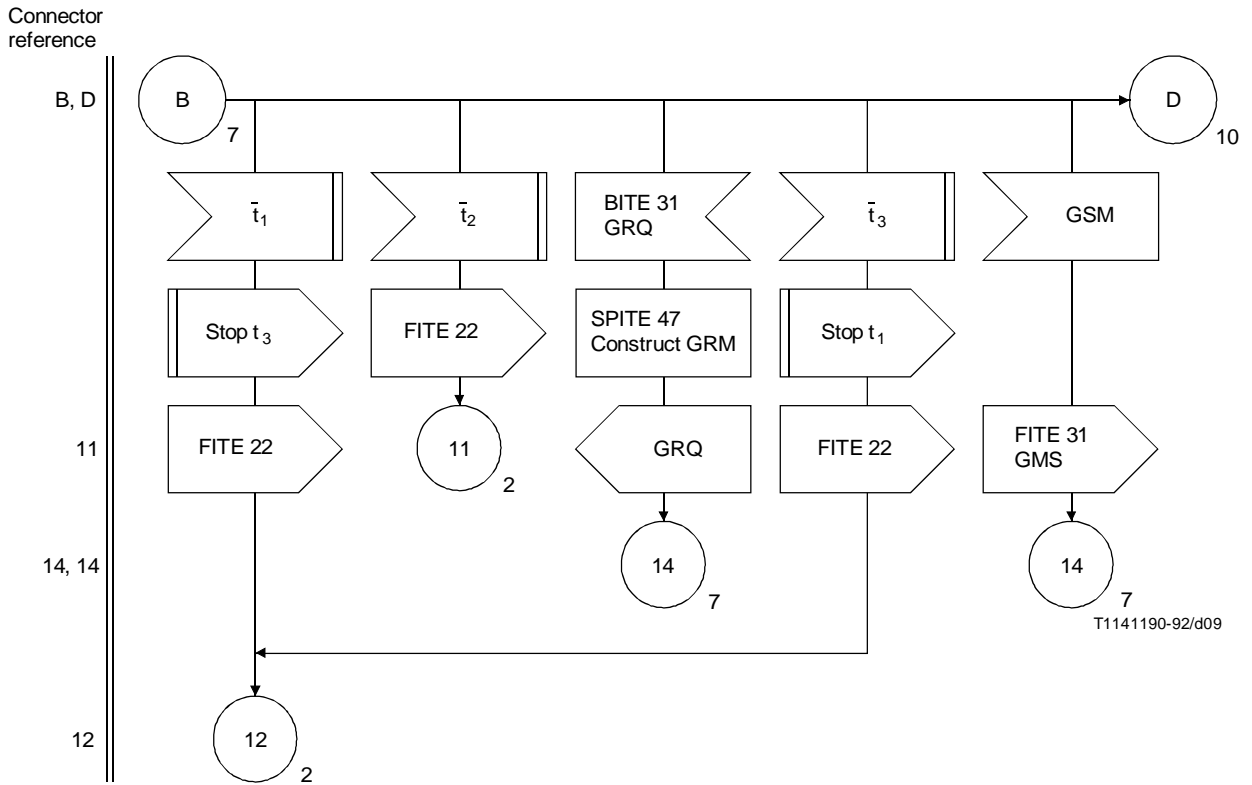
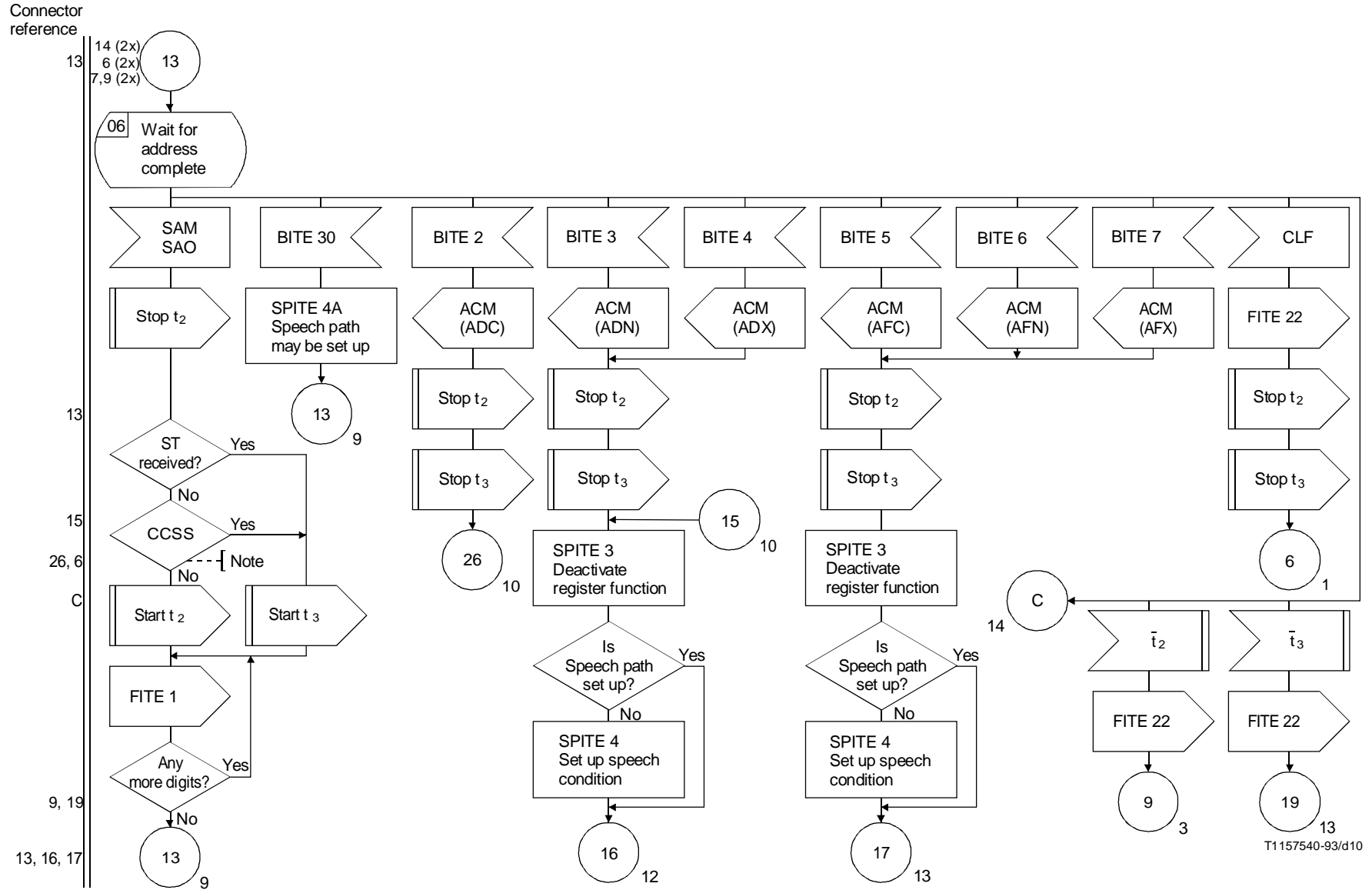

FIGURE 3/Q.614 (sheet 8 of 14)  
**Incoming Signalling System No. 7 (TUP)**



T1157540-93/d10

NOTE – Is outgoing link common channel signalling system?

FIGURE 3/Q.614 (sheet 9 of 14)

**Incoming Signalling System No. 7 (TUP)**

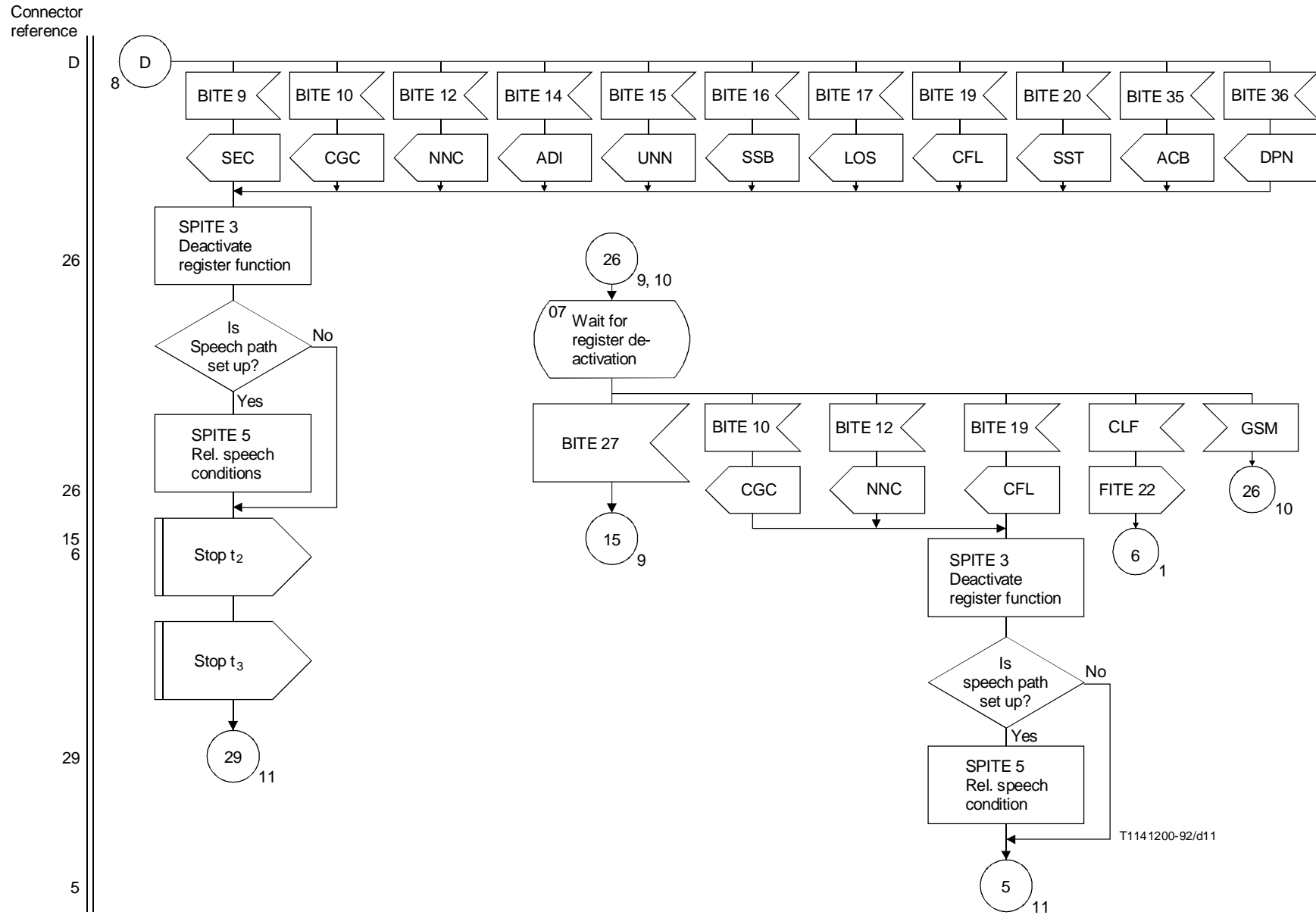
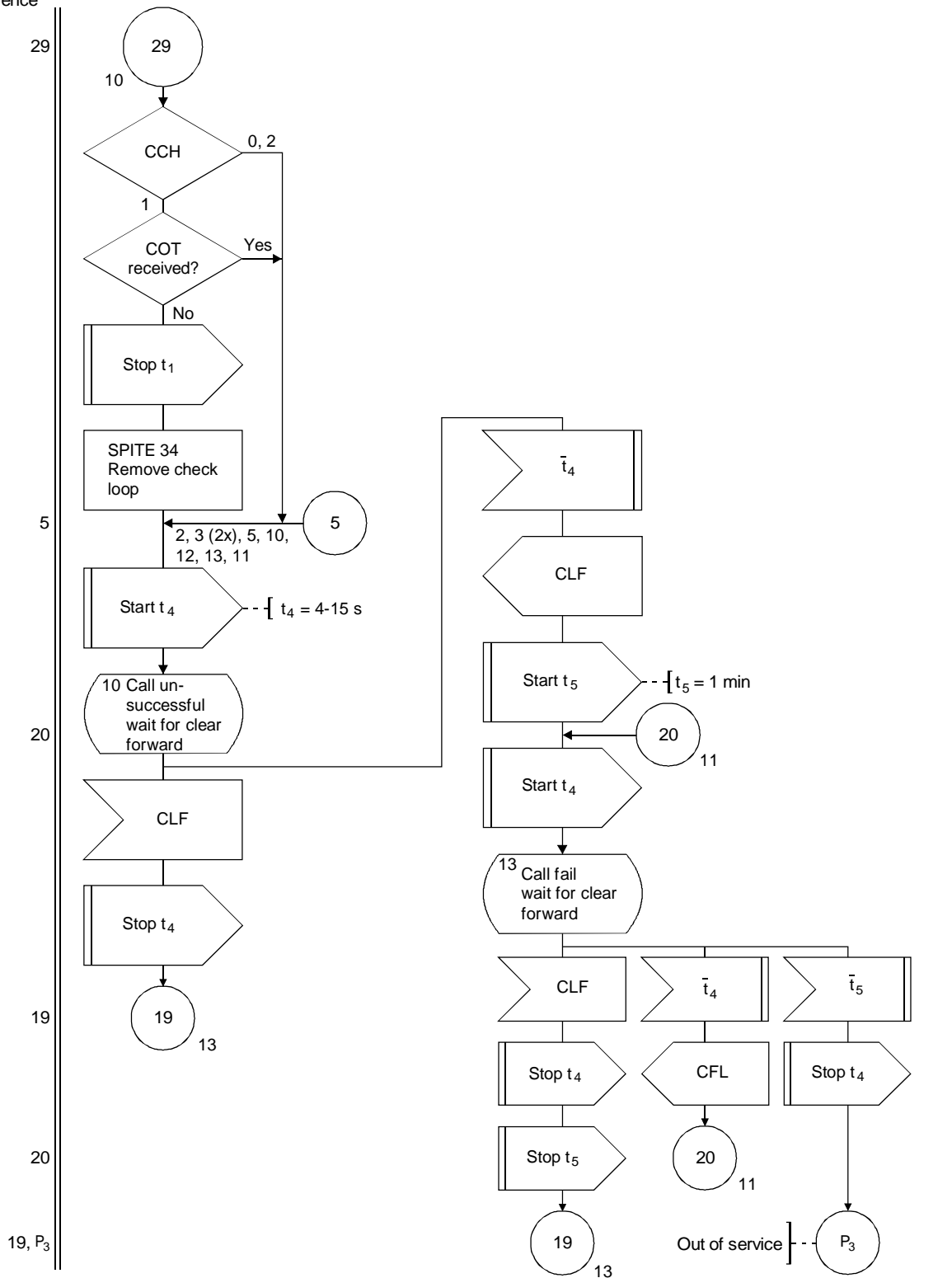

FIGURE 3/Q.614 (sheet 10 of 14)  
**Incoming Signalling System No. 7 (TUP)**

Connector reference



T1157550-93/d12

FIGURE 3/Q.614 (sheet 11 of 14)  
Incoming Signalling System No. 7 (TUP)

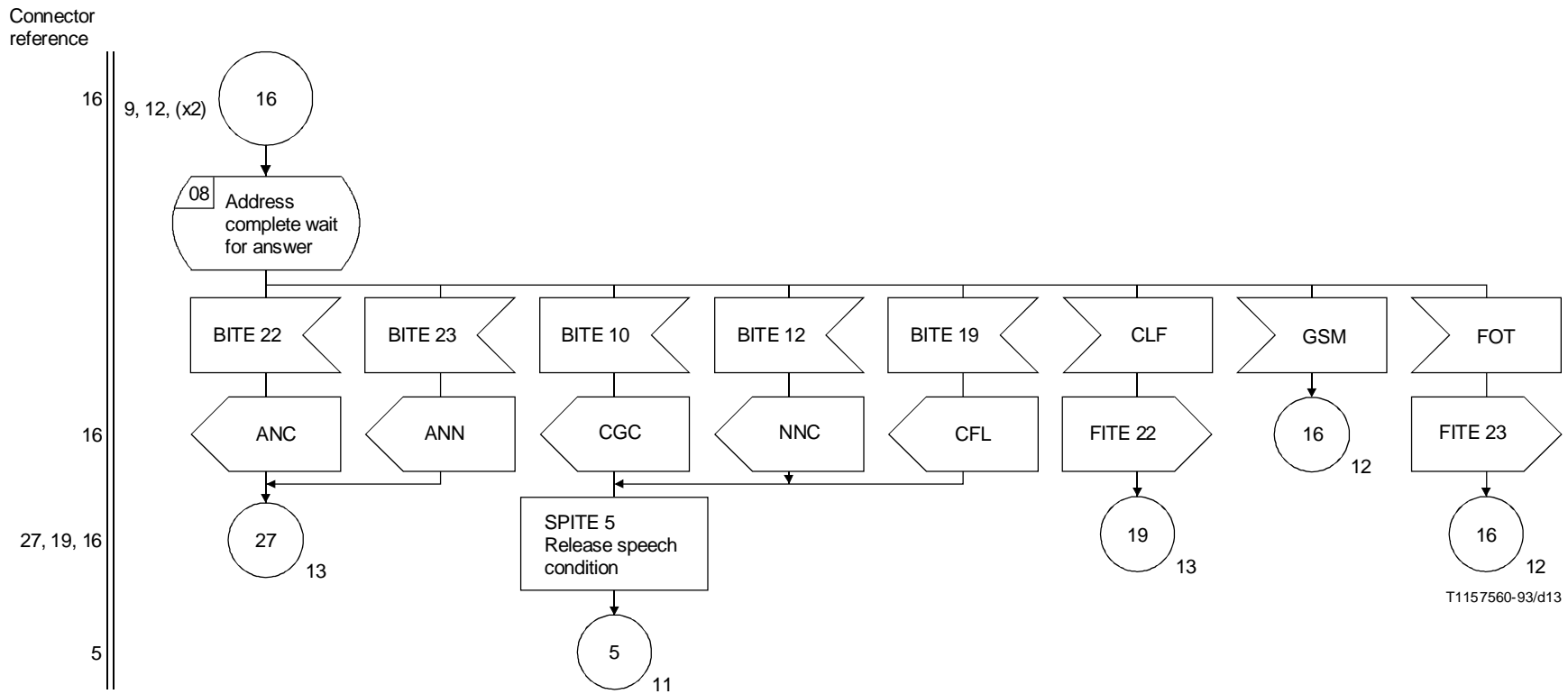

FIGURE 3/Q.614 (sheet 12 of 14)  
**Incoming Signalling System No. 7 (TUP)**



Connector reference

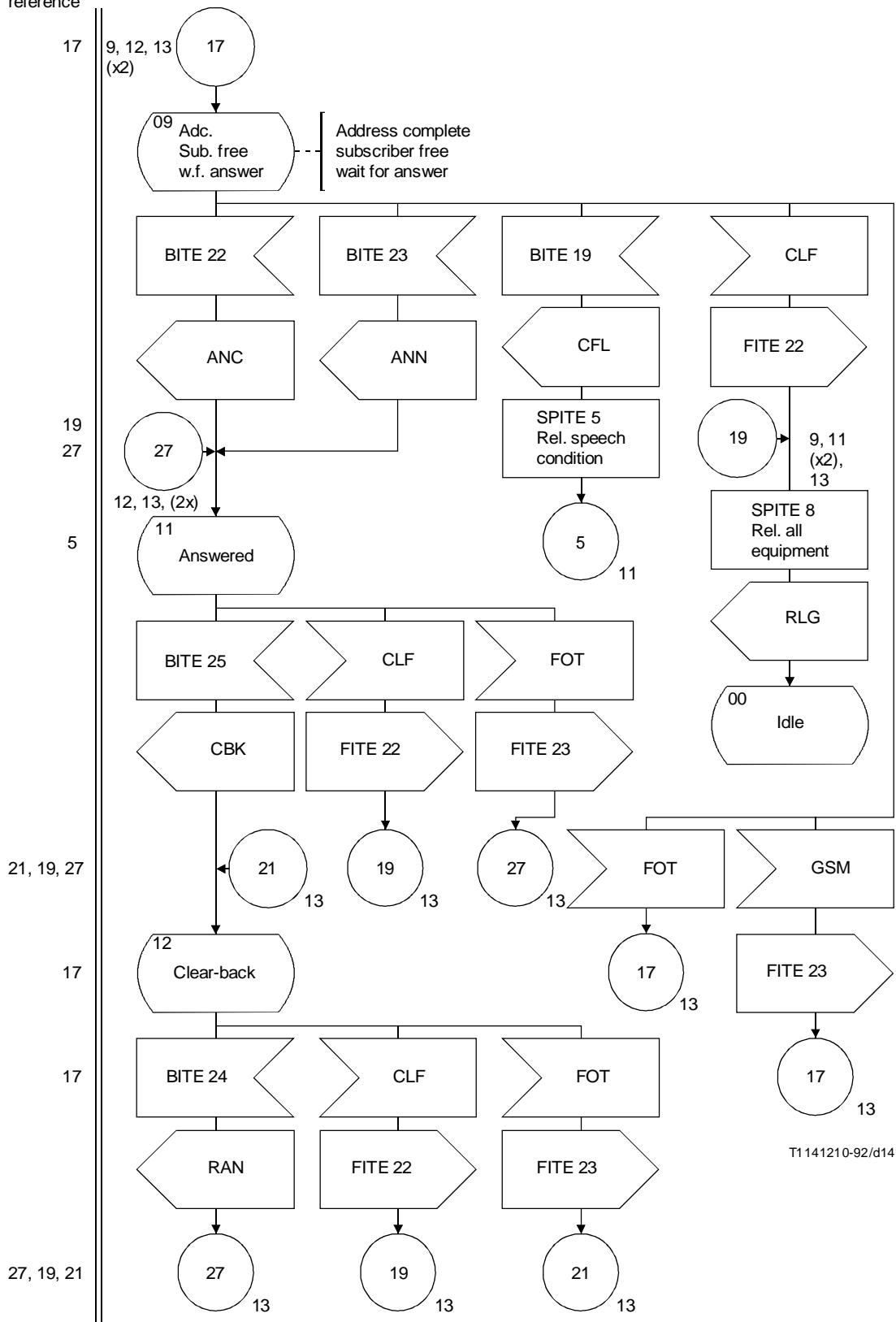
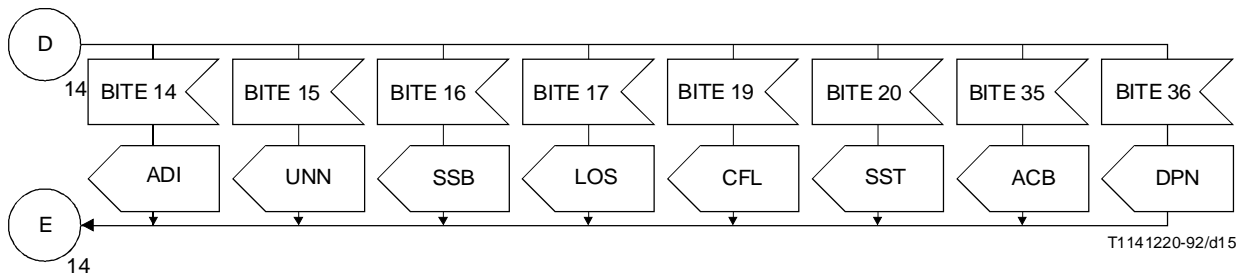
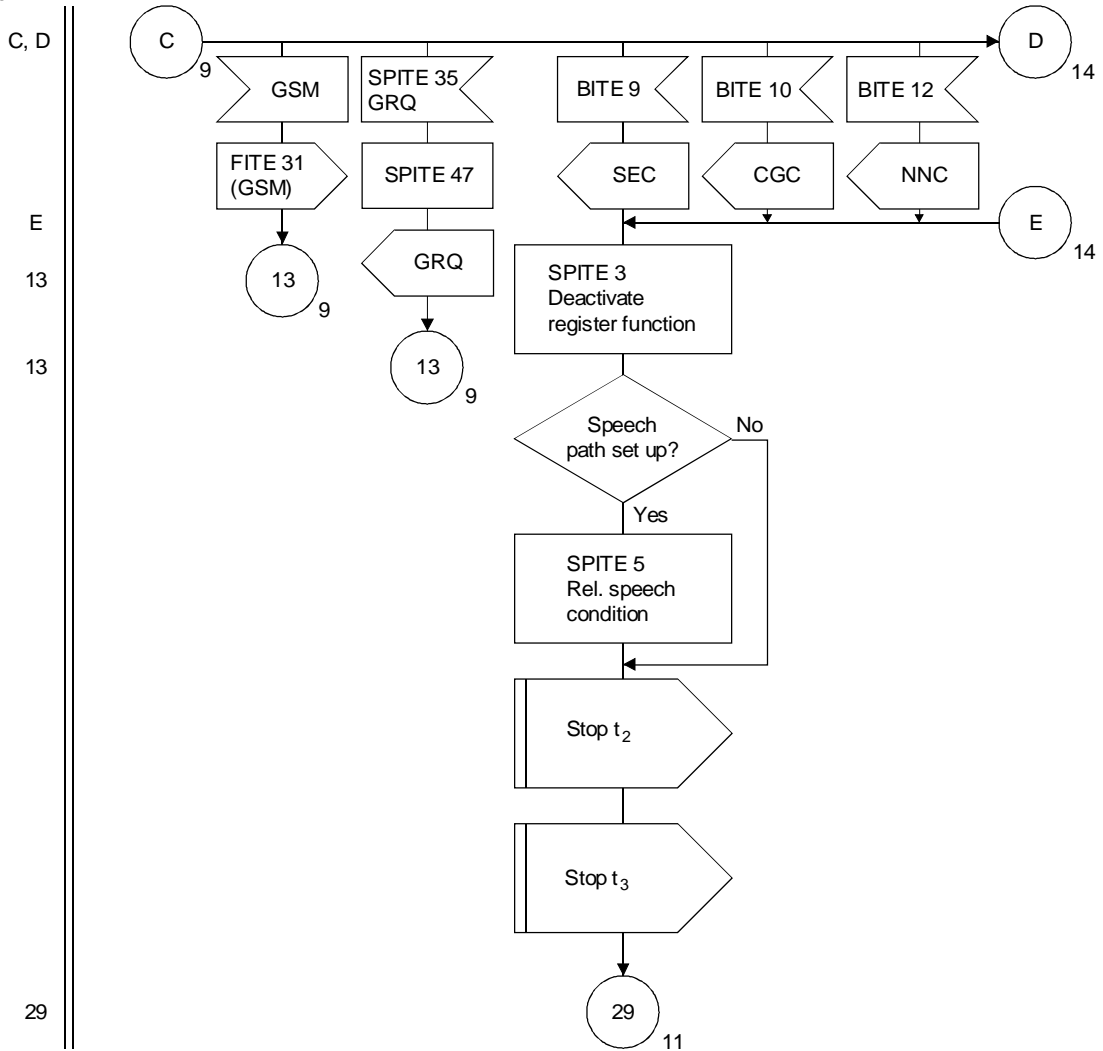

FIGURE 3/Q.614 (sheet 13 of 14)  
**Incoming Signalling System No. 7 (TUP)**

Connector  
reference



T1141220-92/d15

FIGURE 3/Q.614 (sheet 14 of 14)  
**Incoming Signalling System No. 7 (TUP)**