

ITU-T

TELECOMMUNICATION
STANDARDIZATION SECTOR
OF ITU

Q.731.5

(04/2019)

SERIES Q: SWITCHING AND SIGNALLING, AND
ASSOCIATED MEASUREMENTS AND TESTS

Specifications of Signalling System No. 7 – ISDN
supplementary services

**Stage 3 description for number identification
supplementary services using Signalling
system No.7 – Connected line identification
presentation**

Recommendation ITU-T Q.731.5

ITU-T Q-SERIES RECOMMENDATIONS
SWITCHING AND SIGNALLING, AND ASSOCIATED MEASUREMENTS AND TESTS

SIGNALLING IN THE INTERNATIONAL MANUAL SERVICE	Q.1–Q.3
INTERNATIONAL AUTOMATIC AND SEMI-AUTOMATIC WORKING	Q.4–Q.59
FUNCTIONS AND INFORMATION FLOWS FOR SERVICES IN THE ISDN	Q.60–Q.99
CLAUSES APPLICABLE TO ITU-T STANDARD SYSTEMS	Q.100–Q.119
SPECIFICATIONS OF SIGNALLING SYSTEMS No. 4, 5, 6, R1 AND R2	Q.120–Q.499
DIGITAL EXCHANGES	Q.500–Q.599
INTERWORKING OF SIGNALLING SYSTEMS	Q.600–Q.699
SPECIFICATIONS OF SIGNALLING SYSTEM No. 7	Q.700–Q.799
General	Q.700
Message transfer part (MTP)	Q.701–Q.710
Signalling connection control part (SCCP)	Q.711–Q.719
Telephone user part (TUP)	Q.720–Q.729
ISDN supplementary services	Q.730–Q.739
Data user part	Q.740–Q.749
Signalling System No. 7 management	Q.750–Q.759
ISDN user part	Q.760–Q.769
Transaction capabilities application part	Q.770–Q.779
Test specification	Q.780–Q.799
Q3 INTERFACE	Q.800–Q.849
DIGITAL SUBSCRIBER SIGNALLING SYSTEM No. 1	Q.850–Q.999
PUBLIC LAND MOBILE NETWORK	Q.1000–Q.1099
INTERWORKING WITH SATELLITE MOBILE SYSTEMS	Q.1100–Q.1199
INTELLIGENT NETWORK	Q.1200–Q.1699
SIGNALLING REQUIREMENTS AND PROTOCOLS FOR IMT-2000	Q.1700–Q.1799
SPECIFICATIONS OF SIGNALLING RELATED TO BEARER INDEPENDENT CALL CONTROL (BICC)	Q.1900–Q.1999
BROADBAND ISDN	Q.2000–Q.2999
SIGNALLING REQUIREMENTS AND PROTOCOLS FOR THE NGN	Q.3000–Q.3709
SIGNALLING REQUIREMENTS AND PROTOCOLS FOR SDN	Q.3710–Q.3899
TESTING SPECIFICATIONS	Q.3900–Q.4099
SIGNALLING REQUIREMENTS AND PROTOCOLS FOR IMT-2020	Q.5000–Q.5049
COMBATING COUNTERFEITING AND STOLEN ICT DEVICES	Q.5050–Q.5069

For further details, please refer to the list of ITU-T Recommendations.

Recommendation ITU-T Q.731.5

Stage 3 description for number identification supplementary services using Signalling system No.7 – Connected line identification presentation

Summary

Recommendation ITU-T Q.731.5 provides a signalling procedure for connected line identification presentation (COLP). It specifies service description, coding requirements and operation requirements of COLP. It also presents the signalling requirements for originating local exchange, transit exchange, international gateway exchange and destination local exchange. Interaction with other supplementary services, interaction with other network and dynamic description are also considered.

History

Edition	Recommendation	Approval	Study Group	Unique ID*
1.0	ITU-T Q.731.5	1993-03-12	XI	11.1002/1000/2201
2.0	ITU-T Q.731.5	2019-04-29	11	11.1002/1000/13880

Keywords

Number identification, COLP, COLR, Signalling system No. 7.

* To access the Recommendation, type the URL <http://handle.itu.int/> in the address field of your web browser, followed by the Recommendation's unique ID. For example, <http://handle.itu.int/11.1002/1000/11830-en>.

FOREWORD

The International Telecommunication Union (ITU) is the United Nations specialized agency in the field of telecommunications, information and communication technologies (ICTs). The ITU Telecommunication Standardization Sector (ITU-T) is a permanent organ of ITU. ITU-T is responsible for studying technical, operating and tariff questions and issuing Recommendations on them with a view to standardizing telecommunications on a worldwide basis.

The World Telecommunication Standardization Assembly (WTSA), which meets every four years, establishes the topics for study by the ITU-T study groups which, in turn, produce Recommendations on these topics.

The approval of ITU-T Recommendations is covered by the procedure laid down in WTSA Resolution 1.

In some areas of information technology which fall within ITU-T's purview, the necessary standards are prepared on a collaborative basis with ISO and IEC.

NOTE

In this Recommendation, the expression "Administration" is used for conciseness to indicate both a telecommunication administration and a recognized operating agency.

Compliance with this Recommendation is voluntary. However, the Recommendation may contain certain mandatory provisions (to ensure, e.g., interoperability or applicability) and compliance with the Recommendation is achieved when all of these mandatory provisions are met. The words "shall" or some other obligatory language such as "must" and the negative equivalents are used to express requirements. The use of such words does not suggest that compliance with the Recommendation is required of any party.

INTELLECTUAL PROPERTY RIGHTS

ITU draws attention to the possibility that the practice or implementation of this Recommendation may involve the use of a claimed Intellectual Property Right. ITU takes no position concerning the evidence, validity or applicability of claimed Intellectual Property Rights, whether asserted by ITU members or others outside of the Recommendation development process.

As of the date of approval of this Recommendation, ITU had not received notice of intellectual property, protected by patents, which may be required to implement this Recommendation. However, implementers are cautioned that this may not represent the latest information and are therefore strongly urged to consult the TSB patent database at <http://www.itu.int/ITU-T/ipr/>.

© ITU 2019

All rights reserved. No part of this publication may be reproduced, by any means whatsoever, without the prior written permission of ITU.

Table of Contents

	Page
1 Scope.....	1
2 References.....	1
3 Definitions	2
3.1 Terms defined elsewhere	2
3.2 Terms defined in this Recommendation.....	2
4 Abbreviations and acronyms	2
5 Conventions	3
6 Connected line identification presentation	3
6.1 Description	3
6.2 Operational requirements	4
6.3 Coding requirements	4
6.4 Signalling requirements.....	5
6.5 Interaction with other supplementary services	8
6.6 Interaction with other networks.....	10
6.7 Signalling flows.....	10
6.8 Parameter value (timers).....	10
6.9 Dynamic description.....	10

Recommendation ITU-T Q.731.5

Stage 3 description for number identification supplementary services using Signalling system No.7 – Connected line identification presentation

1 Scope

This Recommendation provides signalling procedure for connected line identification presentation (COLP). It specifies service description, coding requirements and operation requirements of COLP. It also presents the signalling requirements for originating local exchange, transit exchange, international gateway exchange and destination local exchange. Interaction with other supplementary services, interaction with other network and dynamic description are included as well.

2 References

The following ITU-T Recommendations and other references contain provisions which, through reference in this text, constitute provisions of this Recommendation. At the time of publication, the editions indicated were valid. All Recommendations and other references are subject to revision; users of this Recommendation are therefore encouraged to investigate the possibility of applying the most recent edition of the Recommendations and other references listed below. A list of the currently valid ITU-T Recommendations is regularly published. The references to a document within this Recommendation do not give it, as a stand-alone document, the status of a Recommendation.

- [ITU-T E.164] Recommendation ITU-T E.164 (2010), *The international public telecommunication numbering plan*.
- [ITU-T I.251.5] Recommendation ITU-T I.251.5 (1995), *Number identification supplementary services: Connected Line Identification Presentation (COLP)*.
- [ITU-T I.330] Recommendation ITU-T I.330 (1988), *ISDN numbering and addressing principles*.
- [ITU-T Q.81.5] Recommendation ITU-T Q.81.5 (1991), *Stage 2 description for number identification supplementary services: Connected line identification, presentation and restriction (COLP) and (COLR)*.
- [ITU-T Q.730] Recommendation ITU-T Q.730 (1999), *ISDN User Part supplementary services*.
- [ITU-T Q.761] Recommendation ITU-T Q.761 (1999), *Signalling System No. 7 – ISDN User Part functional description*.
- [ITU-T Q.762] Recommendation ITU-T Q.762 (1999), *Signalling System No. 7 – ISDN User Part general functions of messages and signals*.
- [ITU-T Q.763] Recommendation ITU-T Q.763 (1999), *Signalling System No. 7 – ISDN User Part formats and codes*.
- [ITU-T Q.764] Recommendation ITU-T Q.764 (1999), *Signalling System No. 7 – ISDN User Part signalling procedures*.
- [ITU-T Q.767] Recommendation ITU-T Q.767 (1991), *Application of the ISDN User Part of CCITT signalling system No. 7 for international ISDN interconnections*.
- [ITU-T Q.951.5] Recommendation ITU-T Q.951.5 (1993), *Stage 3 description for number identification supplementary services using DSS 1: Connected line identification presentation*.

3 Definitions

3.1 Terms defined elsewhere

None.

3.2 Terms defined in this Recommendation

This Recommendation defines the following term:

3.2.1 connected line identification presentation (COLP): A supplementary service offered to the calling party which provides the connected party's ISDN number, with additional address information (e.g., connected party sub-address) if any, to the calling party at the call establishment phase.

4 Abbreviations and acronyms

This Recommendation uses the following abbreviations and acronyms:

3PTY	Three-Party service
AOC	Advice Of Charge
CCBS	Completion of Calls to Busy Subscriber
CD	Call Deflection
CFB	Call Forwarding Busy
CFNR	Call Forwarding No Reply
CFU	Call Forwarding Unconditional
CLIP	Calling Line Identification Presentation
CLIR	Calling Line Identification Restriction
COL	Connected Line identity
COLP	Connected Line identification Presentation
COLR	Connected Line identification Restriction
CONF	Conference calling
CUG	Closed User Group
DDI	Direct Dialling-In
HOLD	call Hold
ISDN	Integrated Services Digital Network
ISUP	Integrated Services Digital Network User Part
LH	Line Hunting
MCID	Malicious Call Identification
MLPP	Multi-Level Precedence and Pre-Emption
MSN	Multiple Subscriber Number
PNP	Private Numbering Plan
PNX	Private Network exchange
REV	Reverse charging

SS	Signalling System
SUB	Sub-addressing
TP	Terminal Portability
UUS	User-to-User Signalling
UUS1	User-to-User Signalling, service 1
UUS2	User-to-User Signalling, service 2
UUS3	User-to-User Signalling, service 3

5 Conventions

None.

6 Connected line identification presentation

6.1 Description

6.1.1 General description

Connected line identification presentation (COLP) is a user facility that enables a user to be informed, on outgoing calls, of the address of the connected party. When provided, the facility applies to all outgoing calls except for when the connected party has the connected line identity restriction (COLR) facility active.

The connected number may be provided by the destination local exchange or by the access signalling system of the connected user. If the connected number is received from the connected user, the information is normally verified and passed to the originating exchange. If no information is received from the connected user, the destination exchange shall generate the connected number.

By special arrangement, verification of the connected number information provided by the user may be inhibited. The information is conveyed by the network in the generic number parameter field of the answer (ANM) or connect (CON) message. The service has no impact on the signalling procedures.

The connected line identity (COL) is the ISDN number of the connected party (with additional address information,

e.g., connected party sub-address, if any) which may be provided by the network or by the connected party or partially by the network with the rest provided by the connected party.

Only full international number, i.e., including the country code, should be passed across the international boundary.

Moreover, the information on the COL may include address information generated by the connected user and transparently transported by the network. The sub-address is subject to a maximum of 20 octets. The network is not responsible for the content of this additional address information.

The stage 1 CCITT definition for the COLP service is given in [ITU-T I.251.5]. The stage 2 CCITT description is contained in [ITU-T Q.81.5]. The stage 3 DSS 1 description is given in [ITU-T Q.951.5]. This stage 3 description of COLP and COLR uses the ISDN user part protocol as defined in [ITU-T Q.761] to [ITU-T Q.764] and [ITU-T Q.730].

6.1.2 Specific terminology

In addition to the term defined in clause 3, this Recommendation uses the following specific terminology:

ISDN number – A number conforming to the numbering plan and structure specified in [ITU-T E.164].

Sub-address – See Clause 5.4 of [ITU-T I.330].

Served access – It is the user of a particular ISDN number who has subscribed to the presentation of the connected line identification information in association with outgoing calls. The served user may also be known as the calling access.

Connected access – It is the user that receives an incoming call from the served user. The connected access need not have subscribed to the COLP supplementary service.

Default number – A national significant ISDN number registered within the public ISDN following prior arrangement between the connected access and the public ISDN.

Special arrangement – An arrangement between a customer and a public network operator whereby customer supplied connected numbers are not screened by the public network.

Access signalling system – A part in the local exchange which handles the user-network interface protocol. It also includes the screening functions.

6.1.3 Qualification on the applicability to telecommunication services

Not applicable.

6.1.4 State definitions

No specific state definitions are required.

6.2 Operational requirements

6.2.1 Provision/withdrawal

See clause 3.1 of [ITU-T I.251.5].

6.2.2 Requirements on the originating network side

Not applicable.

6.2.3 Requirements in the network

No specific requirements are needed in the network.

6.2.4 Requirements on the terminating network side

Not applicable.

6.3 Coding requirements

Clause 3.16 of [ITU-T Q.763], clause 3.38 of [ITU-T Q.763] and clause 3.26 of [ITU-T Q.763] give the coding for the connected number, optional forward call indicators, generic number parameters and the access transport parameter fields which are required to support this service.

The purpose of the generic number parameter field is to transport a connected number provided by the connected user with a special arrangement. This screening indicator shall be set to "user provided, not verified".

The generic number parameter is accompanied by the parameter compatibility information parameter. The procedures for compatibility are defined in [ITU-T Q.764].

Allowed codings for the generic number parameter

- a) *Number qualifier indicator*
00000101 additional connected number

- b) *Odd/even indicator*
See clause 3.26 b) of [ITU-T Q.763]
- c) *Nature of address indicator*
 - 0000001 subscriber number (for national use)
 - 0000010 unknown (national use)
 - 0000011 national (significant) number
 - 0000100 international number
- d) *Internal network number indicator/number incomplete indicator*
 - 0 (not used)
- e) *Numbering plan indicator*
 - 001 ISDN (Telephony) numbering plan ([ITU-T E.164])
- f) *Address presentation restricted indicator*
 - 1 presentation allowed
 - 2 presentation restricted
- g) *Screening indicator*
 - 00 user provided, not verified
- h) *Address signals*
 - 0000 digit 0
 - 0001 digit 1
 - 0010 digit 2
 - 0011 digit 3
 - 0100 digit 4
 - 0101 digit 5
 - 0110 digit 6
 - 0111 digit 7
 - 1000 digit 8
 - 1001 digit 9
- i) *Filler*
See clause 3.26 i) of [ITU-T Q.763].

6.4 Signalling requirements

6.4.1 Activation/deactivation/registration

Not applicable.

6.4.2 Invocation and operation

6.4.2.1 Actions at the originating local exchange

6.4.2.1.1 Normal operation

When the calling party has subscribed to the COLP facility, the exchange shall include in the optional forward call indicator in the IAM, a request to use the COLP facility for this call.

The COL information is conveyed by the network in the connected number parameter field of the answer (ANM) or connect (CON) message, unless the user has an agreement to provide unscreened information, in which case the connected number parameter field will convey the network default

number, and the user provided unscreened information will be carried as received from the access signalling system in the generic number parameter also conveyed in the ANM or CON message.

When the generic number parameter field with a number qualifier set to "additional connected number" is provided together with the connected number, then this number shall be sent in addition, to the calling access. The address presentation restricted indicator and screening indicator sent to the calling access shall be passed transparently.

When the calling party has not subscribed to the COLP facility no particular actions are required. When a request for the COL is not included in the IAM, the connected number parameter should not be included in either the answer or connect message. However, if this information is included, it shall not be considered as a protocol error and the call should continue.

It is a function of the user-network interface to check whether the calling user has subscribed to the COLP supplementary service, and not to present the COL or sub-address if no subscription exists.

6.4.2.1.2 Exceptional procedures

No exceptional procedures are identified.

6.4.2.2 Actions at the transit exchange

6.4.2.2.1 Normal operation

The transit exchange shall transparently pass on all information related to the COLP supplementary service.

6.4.2.2.2 Exceptional procedures

No exceptional procedures are identified.

6.4.2.3 Actions at the outgoing international gateway exchange

6.4.2.3.1 Normal operation

The exchange shall check if the country code of the connected number is the network's own country code. If this is the case then the country code shall be removed. The nature of address indicator shall be set to "national (significant) number". The address presentation restricted indicator and the screening indicator shall be transferred transparently.

NOTE – As a national option, the outgoing international gateway exchange may add a prefix to the connected number. In this case the nature of address indicator shall be set to "unknown".

If the generic number parameter field is received and its number qualifier indicates "additional connected number", and the numbering plan indicator is coded "ISDN (Telephony) numbering plan ([ITU-T E.164])", then the generic number parameter shall be treated in the same manner as the connected number parameter.

6.4.2.3.2 Exceptional procedures

No exceptional procedures are identified.

6.4.2.4 Actions at the incoming international gateway exchange

6.4.2.4.1 Normal operation

At the international boundary, the destination gateway can remove the COL digits if it cannot be released to the originating network and set the address presentation restricted indicator to "address not available".

If the address presentation restricted indicator of the received connected number parameter field is set to "presentation restricted", the destination international gateway exchange shall act according to the bilateral agreement between the two networks. If the connected number parameter field is not

sent across the international section, then the generic number parameter field shall also be omitted from the CON or ANM message if its number qualifier indicates "additional connected number".

The exchange shall convert the connected number parameter field to an international number (if necessary) and set the nature of address indicator to "international number". The address presentation restricted indicator and the screening indicator shall be transferred transparently.

If the generic number parameter field is received and its number qualifier indicates "additional connected number" and the numbering plan indicator is coded "ISDN (Telephony) numbering plan ([ITU-T E.164])", then the generic number parameter shall be treated in the same manner as the connected number parameter.

6.4.2.4.2 Exceptional procedures

No exceptional procedures identified.

6.4.2.5 Actions at the destination local exchange

6.4.2.5.1 Normal operation

The exchange shall deliver the COL only if it was requested at call set-up. However, if it is included in the answer or connect message when it has not been requested it should not be considered as a protocol error and the call should be allowed to continue.

In the case where a connected party is a PNX, the network sends the ISDN number and the DDI number of the extension as the COL if the extension digits are provided by the connected party. If the extension digits are not provided the network sends the ISDN default number. The default number is stored within the network but the value is agreed between the Administration and the customer concerned.

When the COL is provided by the user or PNX, it might be verified or screened for validity by the network, i.e., the COL provided by the user is within the known number range for that user.

- i) If the user provided COL is valid the connected number parameter field contains the COL in the address signals with the screening indicator set to "user provided verified and passed".
- ii) If the user provided COL is not valid the destination exchange inserts the default number for the address signals with the screening indicator set to "network provided".
- iii) If the user has a special arrangement with the network, that the user provided COL is not screened, then the destination local exchange shall disregard any value of the screening indicator, if received from the connected access.

The connected number received from the called access shall be entered in the generic number parameter field. In this parameter field, the number qualifier indicator shall be set to "additional connected number", the screening indicator set to "user provided, not verified". The numbering plan indicator is coded "ISDN (Telephony) numbering plan ([ITU-T E.164])" if the numbering plan indicator received from the access signalling system indicates "unknown". The nature of address indicator shall be set to "international number" or "national (significant) number" as received from the connected access.

In addition, the destination local exchange shall enter the default number associated with the connected user in the connected number parameter field. In this parameter field, the screening indicator shall be set to "network provided" and the nature of address indicator to "national (significant) number".

- iv) If there is no agreement and the user provided COL is not valid, the destination exchange defaults to the network provided COL for the address signals of the connected number parameter field with the screening indicator set to "network provided".

Optionally, a connected party sub-address may be included, if received from the called access, in the connected sub-address information element which is transported in the access transport parameter.

If the COL cannot be transferred (because it is not allowed to be passed or because the national network cannot provide the number) then the connected number parameter should be included in the ANM or CON messages with the indication "presentation restricted" or "address not available" set as appropriate in the address presentation restriction indicator and set the screening indicator to "network provided".

The numbering plan indicator of the connected number parameter field shall be set to "ISDN (Telephony) numbering plan ([ITU-T E.164])".

The numbering plan indicator of the generic number parameter field shall be set to "ISDN (Telephony) numbering plan ([ITU-T E.164])" if the numbering plan indicator received from the access signalling system indicates "unknown".

The address presentation restricted indicators of the connected number and the generic number parameter fields shall be set to "presentation allowed" or "presentation restricted" as received from the access signalling system.

6.4.2.5.2 Exceptional procedures

No exceptional procedures are identified.

6.5 Interaction with other supplementary services

6.5.1 Call waiting (CW)

No impact on ISUP.

6.5.2 Call transfer services

No applicable interaction at this time.

6.5.3 Connected line identification presentation (COLP)

Not applicable.

6.5.4 Connected line identification restriction (COLR)

The COLR supplementary service shall take precedence over the COLP supplementary service.

The COLP supplementary service can take precedence over the COLR supplementary service when the calling access has an override category. This is a national option.

6.5.5 Calling line identification presentation (CLIP)

No impact on ISUP.

6.5.6 Calling line identification restriction (CLIR)

No impact on ISUP.

6.5.7 Closed user group (CUG)

No impact on ISUP.

6.5.8 Conference calling (CONF)

No impact on ISUP.

6.5.9 Direct dialling-in (DDI)

No impact on ISUP.

6.5.10 Call diversion services

6.5.10.1 Call forwarding busy (CFB)

No impact on ISUP.

6.5.10.2 Call forwarding no reply (CFNR)

No impact on ISUP.

6.5.10.3 Call forwarding unconditional (CFU)

No impact on ISUP.

6.5.10.4 Call deflection (CD)

No impact on ISUP.

6.5.11 Line hunting (LH)

No impact on ISUP.

6.5.12 Three party service (3PTY)

No impact on ISUP.

6.5.13 User-to-user signalling (UUS)

6.5.13.1 User-to-user signalling, service 1 (UUS1)

No impact on ISUP.

6.5.13.2 User-to-user signalling, service 2 (UUS2)

No impact on ISUP.

6.5.13.3 User-to-user signalling, service 3 (UUS3)

No impact on ISUP.

6.5.14 Multiple subscriber number (MSN)

If the multiple subscriber number supplementary service is applicable to the public network access interface of the connected party, then this party can provide the appropriate connected party multiple subscriber number digits or full ISDN number on call answer. If no special arrangement has been made with the connected subscriber, then the network shall check the user provided connected number information for validity on the corresponding access. If the check fails or if no connected number information is provided by the user, then the network shall apply the default number of the connected number.

If the multiple subscriber number supplementary service is applicable to the public network access interface of the calling access, then neither supplementary service shall affect the operation of the other supplementary service.

6.5.15 Call hold (HOLD)

No impact on ISUP.

6.5.16 Advice of charge (AOC)

No impact on ISUP.

6.5.17 Sub-addressing (SUB)

No impact on ISUP.

6.5.18 Terminal portability (TP)

No impact on ISUP.

6.5.19 Completion of calls to busy subscriber (CCBS)

No applicable interaction at this time.

6.5.20 Malicious call identification (MCID)

No impact on ISUP.

6.5.21 Reverse charging (REV)

No applicable interaction at this time.

6.5.22 Multi-level precedence and preemption (MLPP)

No impact on ISUP.

6.5.23 Private numbering plan (PNP)

No applicable interaction at this time.

6.5.24 Charge card

No applicable interaction at this time.

6.6 Interaction with other networks

On calls from ISDN networks where the preceding signalling section supports only one connected number to be carried, the information contained in the connected number parameter field shall be returned. The generic number parameter field shall be discarded.

On calls incoming from non-ISDNs, the COL will be discarded, if received.

On a call where COL has been requested, to networks not supporting the service, the request will be discarded.

6.7 Signalling flows

Indicated in Figures 6-1 to 6-4.

6.8 Parameter value (timers)

No specific timers are required.

6.9 Dynamic description

The dynamic description is specified in Figures 6-5 to 6-8.

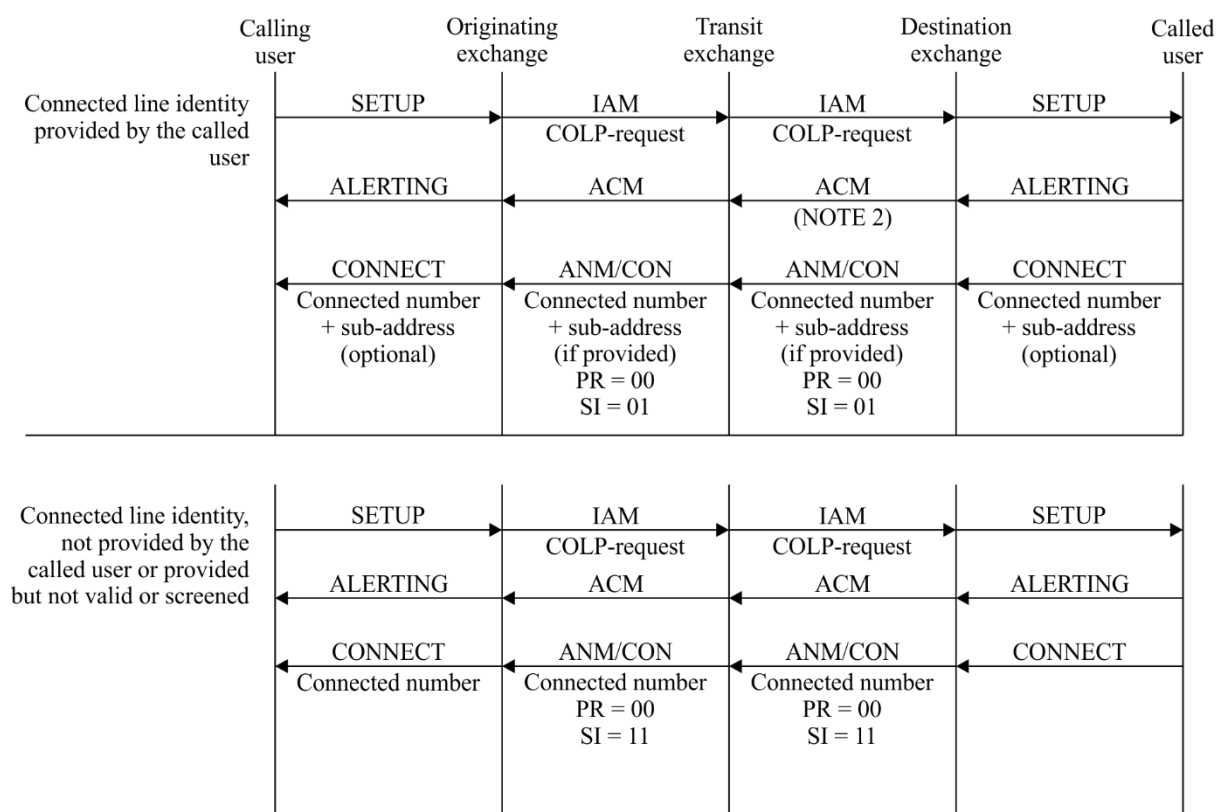

Q.731.5(19)_F6-1

NOTE 1 – This service subscribed by the calling user and the request is included by originating exchange.

NOTE 2 – The connect message is appropriate only if the answer condition is detected prior to the return of the address complete message.

Figure 6-1 – Connected line identification presentation

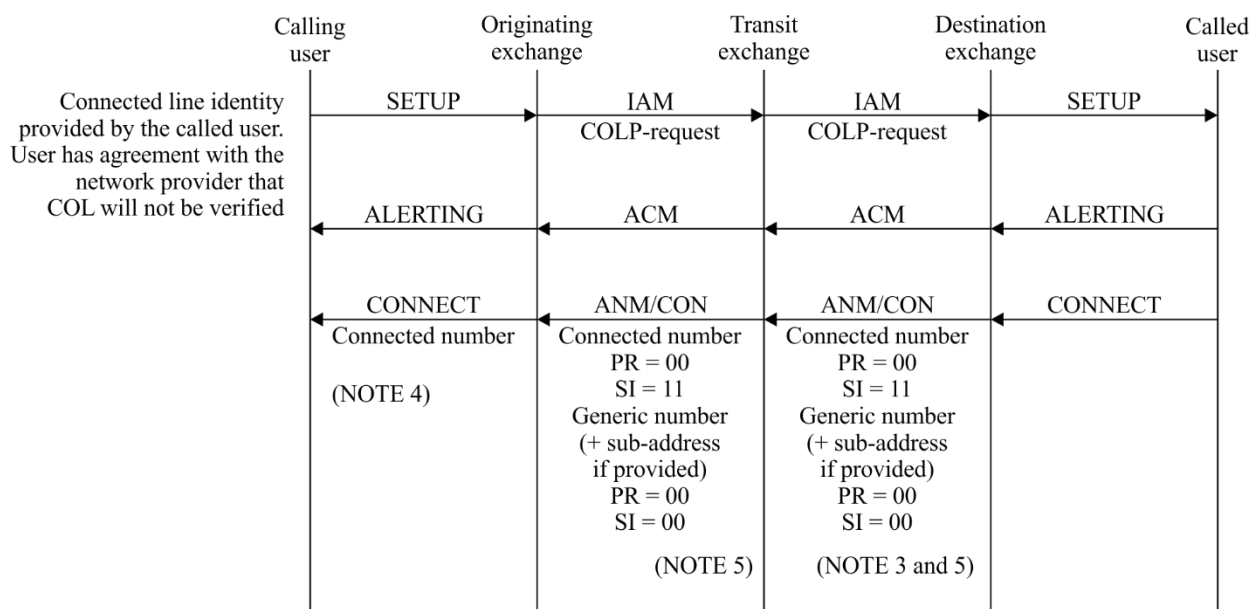

Q.731.5(19)_F6-2

NOTE 1 – This service is subscribed by the calling user and the request is included by the originating exchange.

NOTE 2 – The connect message is appropriate only if the answer condition is detected prior to the return of the address complete message.

NOTE 3 – It is the responsibility of the calling party access or private network ISDN to determine which COL to present to the calling user.

NOTE 4 – If the setting of the presentation restriction indicator in the connected number parameter is in conflict with the setting of the presentation restriction indicator in the generic number, the presentation will be assumed to be restricted.

NOTE 5 – Subaddress is conveyed in the ATP.

Figure 6-2 – Connected line identification presentation

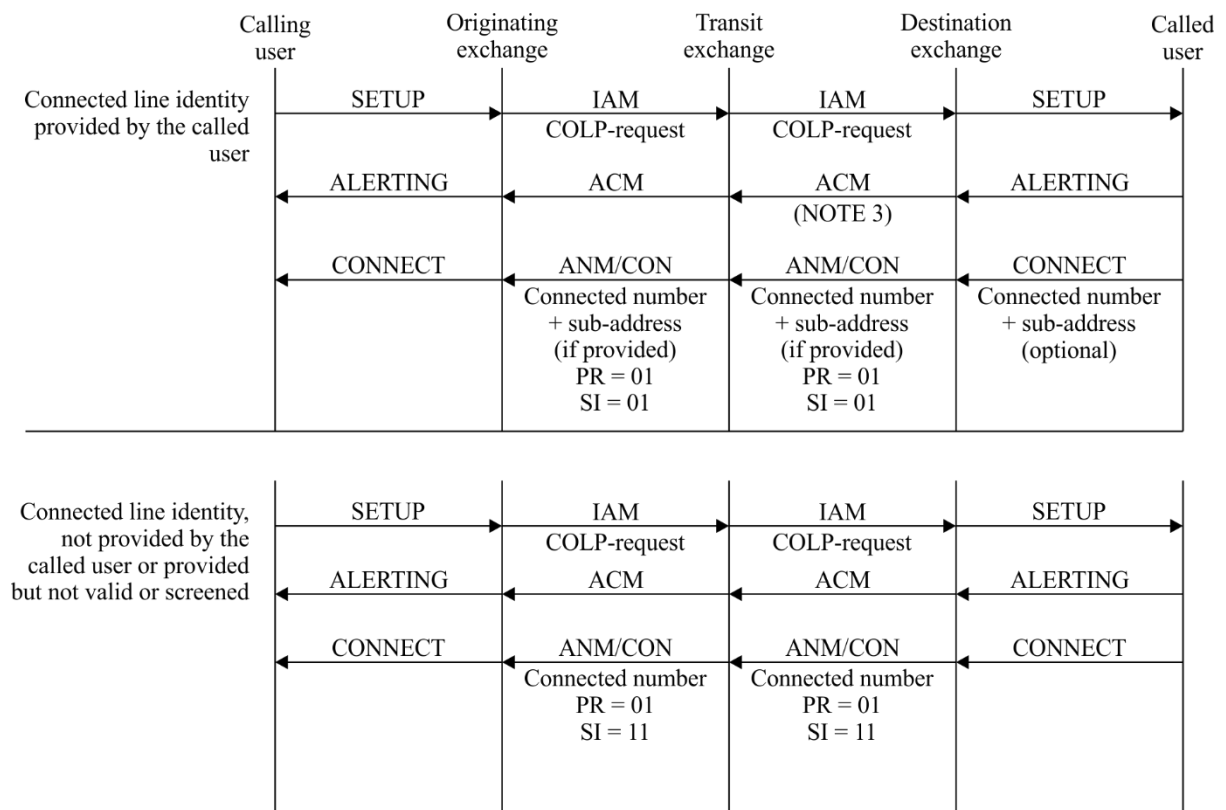

Q.731.5(19)_F6-3

NOTE 1 – This service subscribed by the calling user and the request is included by the originating exchange.

NOTE 2 – This service is subscribed by the called user and stored at the destination exchange.

NOTE 3 – The connect message is appropriate only if the answer condition is detected prior to the return of the address complete message.

Figure 6-3 – Connected line identification restriction

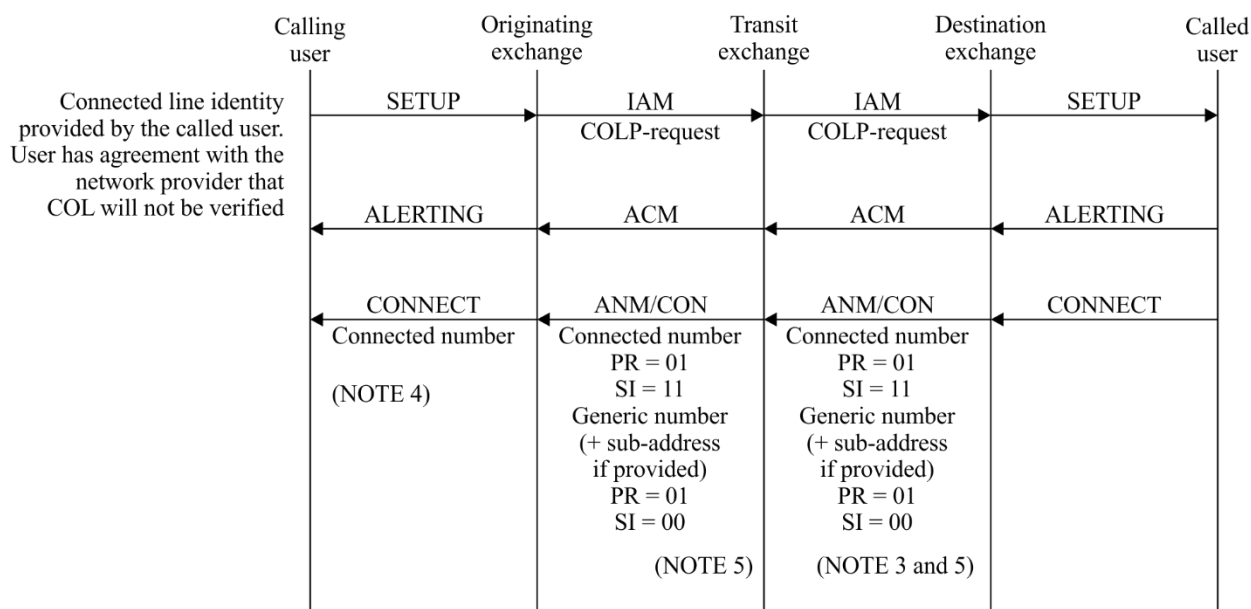

Q.731.5(19)_F6-4

NOTE 1 – This service is subscribed by the calling user and the request is included by the originating exchange.

NOTE 2 – The connect message is appropriate only if the answer condition is detected prior to the return of the address complete message.

NOTE 3 – It is the responsibility of the calling party access or private network ISDN to determine which COL to present to the calling user.

NOTE 4 – If the setting of the presentation restriction indicator in the connected number parameter is in conflict with the setting of the presentation restriction indicator in the generic number, the presentation will be assumed to be restricted.

NOTE 5 – Sub-address is conveyed in the ATP.

Figure 6-4 – Connected line identification restriction

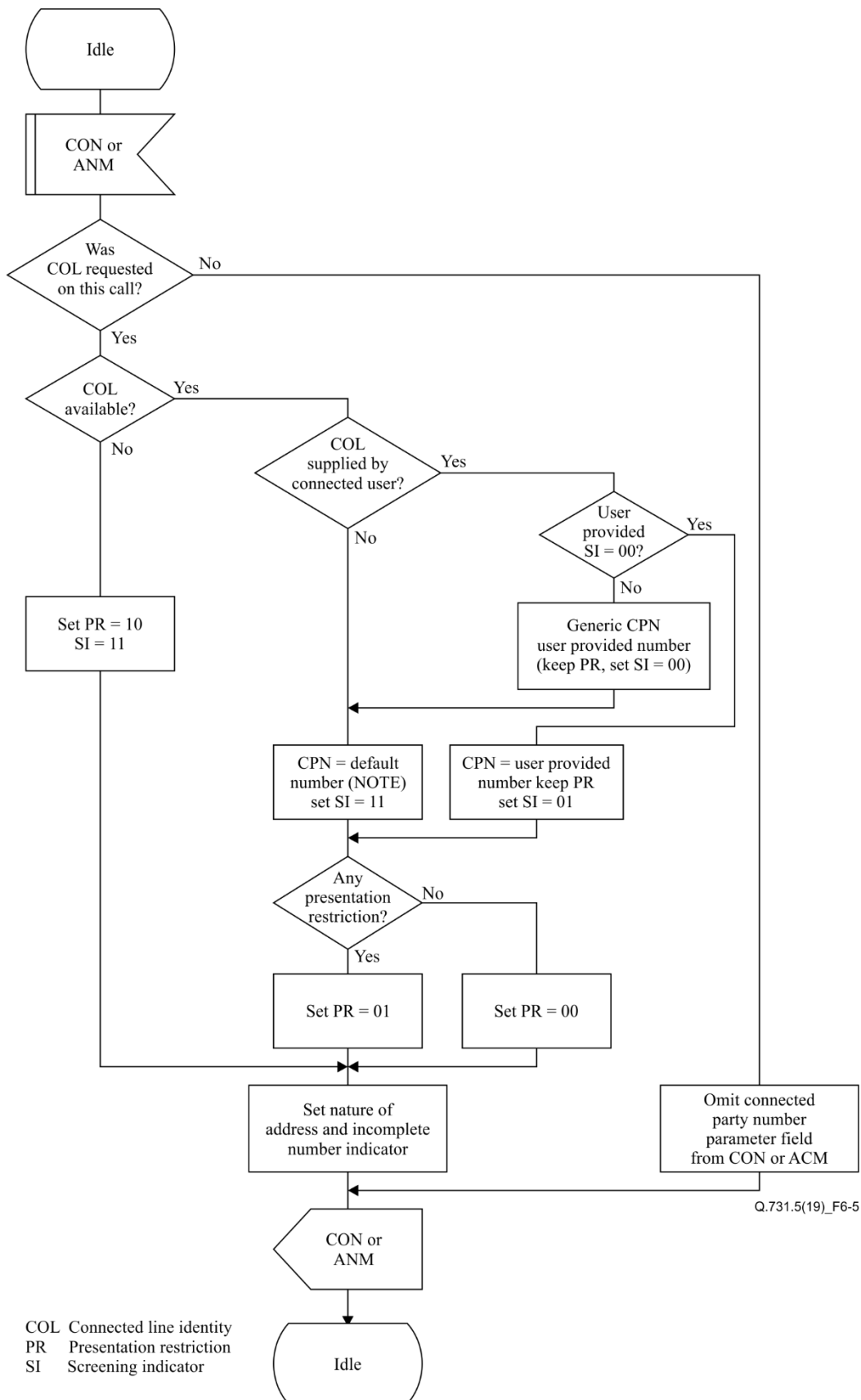

NOTE – The default number is a network supplied default number.

Figure 6-5 – Nodal signalling functions for COLP and COLR Destination local exchange

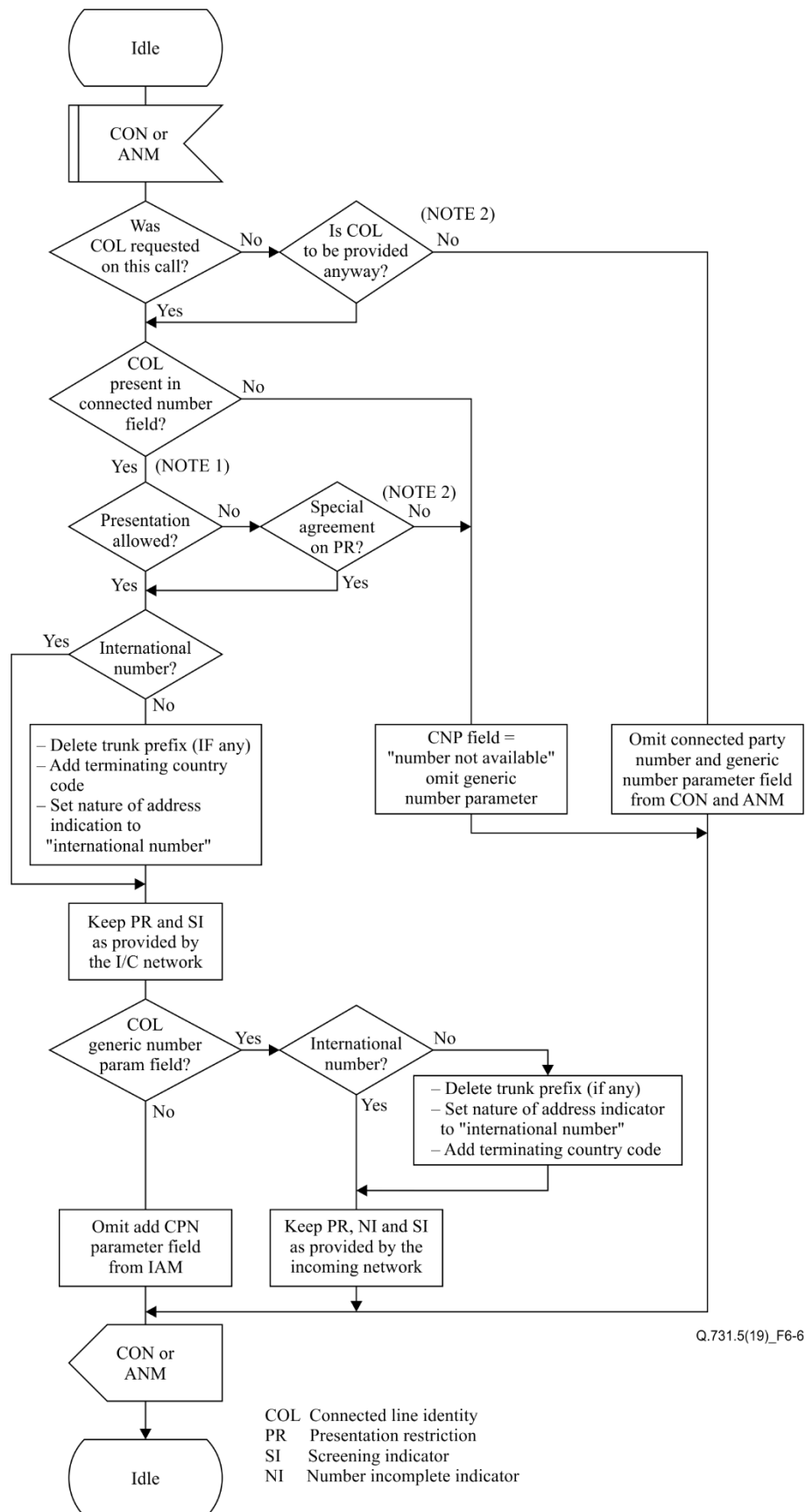

NOTE 1 – This flow assumes that there is no restriction on passing non-restricted COL's across the international boundary. If no such agreement exists then any COL in the incoming CON or ANM will be removed and the PR indicator set to 10, "COL not available".

NOTE 2 – Based on bilateral agreement.

Figure 6-6 – Nodal signalling functions for COLP and COLR Incoming international gateway

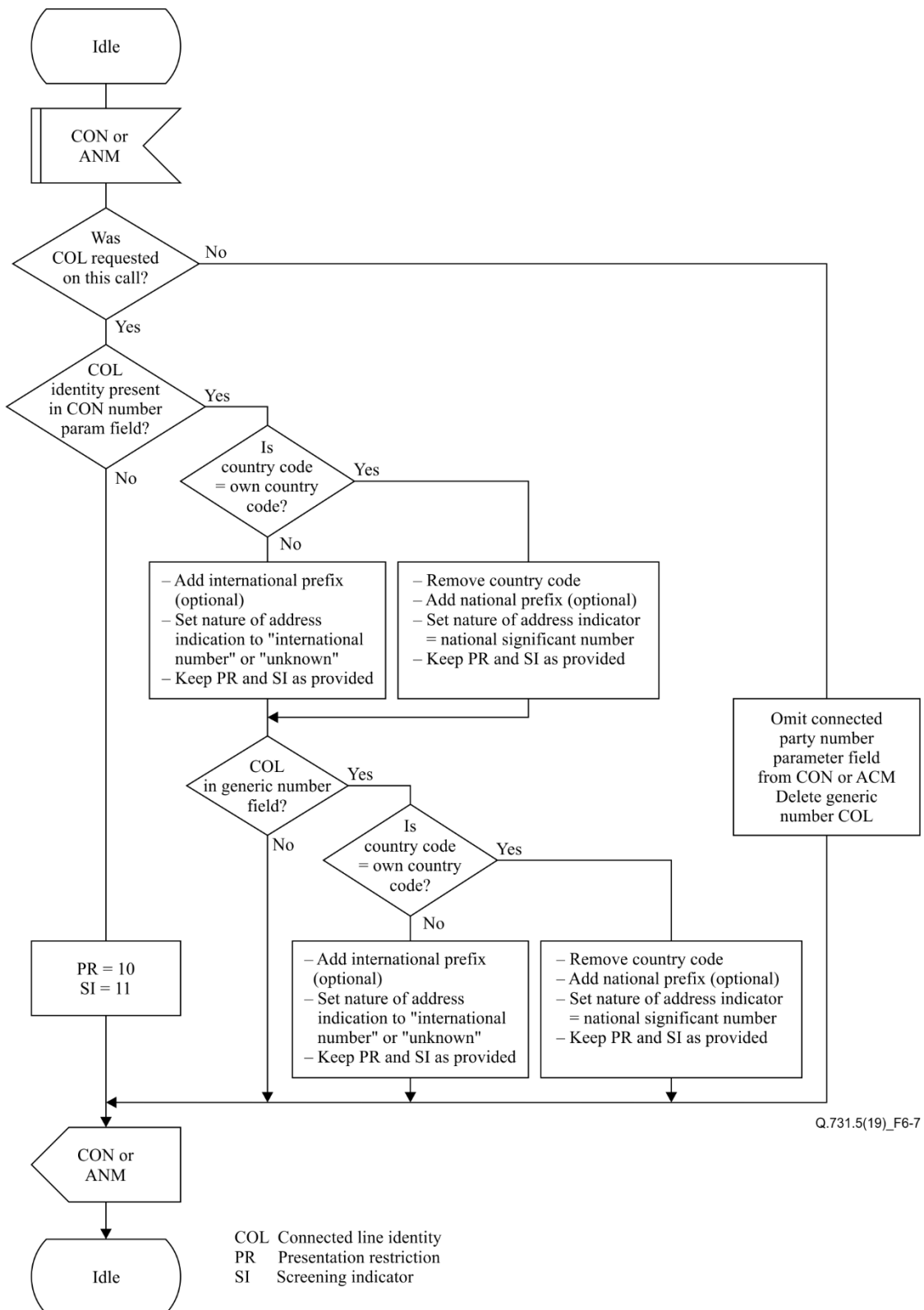
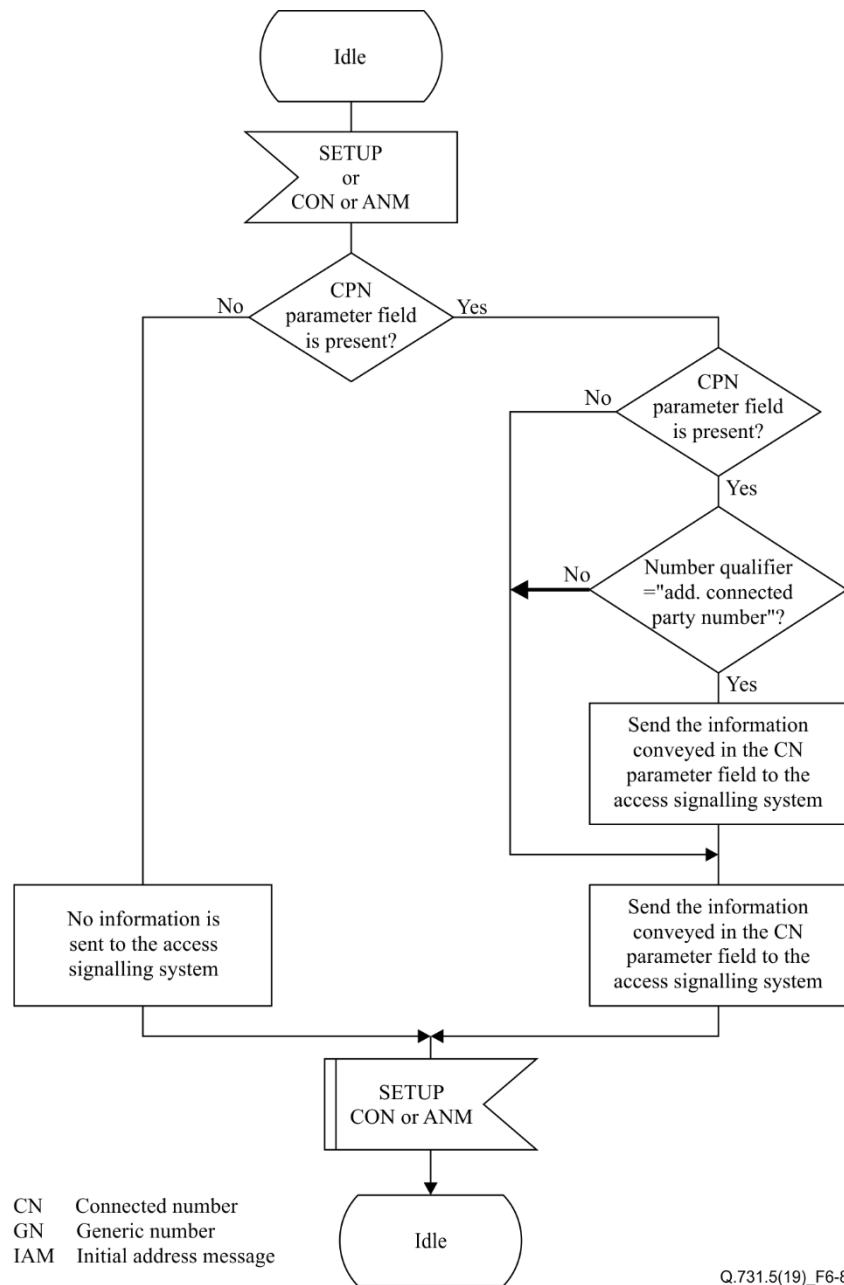

Figure 6-7 – Nodal signalling functions for COLP and COLR Outgoing international gateway exchange



NOTE 1 – It is a function of the access signalling system to check if the COLP supplementary service is applicable and not to present presentation restricted numbers to the calling user.

NOTE 2 – The request option is not supported by private networks (identity always included). The request procedure can only be used to obtain the connected line identity.

NOTE 3 – This transition specifies additional processing to that described in Annex B of [ITU-T Q.764].

Figure 6-8 – Originating local exchange

SERIES OF ITU-T RECOMMENDATIONS

Series A	Organization of the work of ITU-T
Series D	Tariff and accounting principles and international telecommunication/ICT economic and policy issues
Series E	Overall network operation, telephone service, service operation and human factors
Series F	Non-telephone telecommunication services
Series G	Transmission systems and media, digital systems and networks
Series H	Audiovisual and multimedia systems
Series I	Integrated services digital network
Series J	Cable networks and transmission of television, sound programme and other multimedia signals
Series K	Protection against interference
Series L	Environment and ICTs, climate change, e-waste, energy efficiency; construction, installation and protection of cables and other elements of outside plant
Series M	Telecommunication management, including TMN and network maintenance
Series N	Maintenance: international sound programme and television transmission circuits
Series O	Specifications of measuring equipment
Series P	Telephone transmission quality, telephone installations, local line networks
Series Q	Switching and signalling, and associated measurements and tests
Series R	Telegraph transmission
Series S	Telegraph services terminal equipment
Series T	Terminals for telematic services
Series U	Telegraph switching
Series V	Data communication over the telephone network
Series X	Data networks, open system communications and security
Series Y	Global information infrastructure, Internet protocol aspects, next-generation networks, Internet of Things and smart cities
Series Z	Languages and general software aspects for telecommunication systems