



INTERNATIONAL TELECOMMUNICATION UNION

CCITT

THE INTERNATIONAL
TELEGRAPH AND TELEPHONE
CONSULTATIVE COMMITTEE

Q.764

(11/1988)

SERIES Q: SWITCHING AND SIGNALLING

Interworking of Signalling Systems

**INTEGRATED SERVICES DIGITAL NETWORK
USER PART (ISUP) – SIGNALLING
PROCEDURES**

Reedition of CCITT Recommendation Q.764 published in
the Blue Book, Fascicle VI.8 (1988)

NOTES

1 CCITT Recommendation Q.764 was published in Fascicle IV.8 of the *Blue Book*. This file is an extract from the *Blue Book*. While the presentation and layout of the text might be slightly different from the *Blue Book* version, the contents of the file are identical to the *Blue Book* version and copyright conditions remain unchanged (see below).

2 In this Recommendation, the expression “Administration” is used for conciseness to indicate both a telecommunication administration and a recognized operating agency.

Recommendation Q.764

SIGNALLING PROCEDURES

1 General

1.1 *Relationship with other Recommendations*

This Recommendation describes the signalling procedures for the set-up and clear-down of national and international ISDN connections. The messages and signals are defined in Recommendation Q.762 and their format and content are given in Recommendation Q.763. Recommendation Q.730 contains the procedures for supplementary services. (These were previously § 4 of Recommendation Q.764.)

1.2 *Numbering* (see Recommendations E.163, E.164)

The procedures described assume that the ISDN uses the international numbering plan defined for the ISDN and thus provides a basic circuit switched service between ISDN terminals or between ISDN terminals and terminals being connected to the existing international telephony network.

1.3 *Address signalling*

In general, the call set-up procedure described is standard for both speech and non-speech connections using en-bloc address signalling for calls between ISDN terminals. Overlap address signalling is also specified.

1.4 *Basic procedures*

The basic call control procedure is divided into three phases; call set-up, the data/conversation phase and call clear-down. Messages on the signalling link are used to establish and terminate the different phases of a call. Standard inband supervisory tones and/or recorded announcements are returned to the caller on speech and 3.1 kHz connections to provide information on call progress. Calls originating from ISDN terminals may be supplied with more detailed call progress information by means of additional messages in the access protocol supported by a range of messages in the network.

1.5 *Signalling methods*

Two signalling methods are used in this Recommendation:

- link-by-link;
- end-to-end.

The link-by-link method is primarily used for messages that need to be examined at each exchange (see § 2). The end-to-end methods are used for messages of end point significance (see Recommendation Q.730).

The link-by-link method may be used for messages of end point significance. (However, the messages may be affected by processing delays.)

1.6 *Layout of Recommendation Q.764*

The procedures specified in § 2 of this Recommendation relate to basic calls (i.e. calls not involving supplementary services). Section 3 of this Recommendation specifies the procedures relating to end-to-end signalling connections. The additional requirements to be met in the case of calls involving supplementary services and network utilities are specified in Recommendation Q.730. The timers used in this Recommendation are summarized in Annex A. The SDLs for the ISDN-UP are presented in Annex B.

1.7 *Interworking with other signalling systems or user parts*

Only some examples are included in this Recommendation and these should not be used as a definitive interworking guide.

2 Basic call control and signalling procedures

Figures 1/Q.764 to 10/Q.764 at the end of this section show the ISDN call set-up sequences which are described below.

2.1 Successful call set-up

2.1.1 Forward address signalling – en bloc operation

2.1.1.1 Actions required at originating exchange

a) Circuit selection

When the originating exchange has received the complete selection information from the calling party, and has determined that the call is to be routed to another exchange, selection of a suitable, free, inter-exchange circuit takes place and an initial address message is sent to the succeeding exchange.

Appropriate routing information is either stored at the originating exchange or at a remote database to which a request may be made.

The selection of the route will depend on the called party number, connection type required and the network signalling capability required. This selection process may be performed at the exchange or with the assistance of the remote database.

In addition, in the case of a subscriber with digital access, the set-up message contains bearer capability information which is analyzed by the originating exchange to determine the correct connection type and network signalling capability. The bearer capability information will be mapped into the user service information parameter of the initial address message. The information received from the access interface is used to set the value of the transmission medium requirement parameter. The first value of bearer information received will be used to set the initial mode of the connection.

The connection types allowed are:

- speech;
- 3.1 kHz audio;
- 64 kbit/s unrestricted;
- alternate speech/64 kbit/s unrestricted;
- alternate 64 kbit/s unrestricted/speech.

The network signalling capabilities allowed are:

- ISDN-UP preferred;
- ISDN-UP required;
- ISDN-UP not required (any signalling system).

The information used to determine the routing of the call by the originating exchange will be included in the initial address message, (as transmission medium requirement and forward call indicators), to enable correct routing at intermediate exchanges. The initial address message conveys implicitly the meaning that the indicated circuit has been seized.

In the case where N×64 kbit/s (N2) connections are required, the procedures for a single 64 kbit/s connection may be used if the N×64 kbit/s are contiguous 64 kbit/s channels and are pre-assigned for N×64 kbit/s use.

If subaddress information is received from the calling access, this information is passed unchanged to the destination exchange in the access transport parameter of the initial address message.

b) Address information sending sequence

The sending sequence of address information on international calls will be the country code (not sent to an incoming international exchange) followed by the national (significant) number. On national connections, the address information may be the local number or the national (significant) number as required by the Administration concerned. For calls to international operator positions (Code 11 and Code 12) refer to Recommendation Q.107.

The end of pulsing (ST) signal will be used whenever the originating exchange or the outgoing exchange is in a position to know by digit analysis that the final digit has been sent.

c) *Initial address message*

The initial address message (IAM) in principle contains all the information that is required to route the call to the destination exchange and connect the call to the called party.

All initial address messages will include a protocol control indicator (in the forward call indicator parameter) and a transmission medium requirement parameter.

The originating exchange will set the parameters in the protocol control indicator and in the ISDN-UP preference indicator to indicate:

- i) the type of end-to-end method that can be accommodated (§ 3);
- ii) the availability of Signalling System No. 7 signalling;
- iii) the use of the ISDN-UP;
- iv) whether further information is available (to be requested before the called party is alerted);
- v) network signalling capability required, e.g. ISDN-UP required all the way.

The ISDN-UP preference indicator is set according to the bearer service, teleservice and supplementary service(s) requested. The exact setting depends on the service demand conditions and may be different depending on individual cases. In principle, if the service demand requires ISDN-UP to be essential then the indicator is set to “required”, if the service required is optional but preferred it is set to “preferred”, otherwise it is set to “not required”. The indicator is set to either “required” or “preferred”, or “not required”, according to the most stringent condition required by one or more of the parameters in the initial address message. In addition, if end-to-end signalling is essential to provide the requested service the indicator should always be set to “required” (see Recommendation E.172).

The transmission medium requirement parameter contains the connection type required information, e.g. 3.1 kHz audio.

The originating exchange may also include in the initial address message:

- i) a call reference (including the point code of the originating exchange) to enable the destination exchange to establish an end-to-end connection (§ 3);
- ii) the calling party number if this is to be passed forward without being requested. The calling party number could contain Code 11 or 12 if the call is from an international operator;
- iii) an SCCP connection request parameter; and
- iv) other information related to supplementary services and network utilities.

The initial address message can contain an access transport parameter.

d) *Transfer of information not included in the initial address message*

As an alternative to the inclusion of call set-up user facility information in the initial address message, any call set-up user facility information that need not be examined at intermediate exchanges and which can be requested from by the destination exchange (see Recommendation Q.763, § 3.22), may be transported between the originating and destination exchange. The method of transportation for this information can be by the link-to-link method (see § 2.1.6) or via the end-to-end methods (see § 3).

e) *Completion of transmission path*

Through connection of the transmission path will be completed in the backward direction (the transmission path is completed in the forward direction on receipt of a connect or answer message) at the originating exchange immediately after the sending of the initial address message, except in those cases where conditions on the outgoing circuit prevent it (see § 2.1.9).

It is also acceptable that on speech or 3.1 kHz audio calls, through-connection of the transmission path will be completed in both directions immediately after the initial address message has been sent, except in those cases where conditions on the outgoing circuit prevent it (see § 2.1.9).

f) *Network protection timer*

When the originating exchange or the controlling exchange has sent the initial address message the awaiting address complete timer (T_7) is started. If timer (T_7) expires the connection is released and an indication is returned to the calling subscriber.

2.1.1.2 *Actions required at an intermediate exchange*

a) *Circuit selection*

An intermediate exchange, on receipt of an initial address message will analyze the called party number and the other routing information (§ 2.1.1.1 a)) to determine the routing of the call. If the intermediate exchange can route the call using the connection type specified in the transmission medium requirement parameter, a free inter-exchange circuit is seized and an initial address message is sent to the succeeding exchange. Within a network if the intermediate exchange does not route the call using just the connection type specified in the transmission medium requirement parameter, the exchange may also examine the user service information containing the bearer capability information (if available) to determine if a suitable route can be selected. In this case if a new connection type is provided the transmission medium requirement parameter is modified to the new connection type.

For calls between networks, the gateway exchange (e.g. outgoing ISC) must ensure that the transmission medium requirement parameter is set according to the service requested by the customer (see Recommendation E.172). More specifically this parameter is carried unchanged within the international network.

When no echo suppressor or nature-of-circuit indication is received from a preceding exchange using a signalling system with fewer facilities, the indicators will be considered as received “no” unless positive knowledge is available.

b) *Parameters in the initial address message*

An intermediate exchange may modify signalling information received from the preceding exchange according to the capabilities used on the outgoing route. Signalling information that may be changed are nature of connection indicator, end-to-end method indicator; the most significant digits in the called party number may be amended or omitted (see § 2.1.1.1 b)). A change of the end-to-end method used may also alter parameters (see § 3). Other signalling information is passed on transparently, e.g. the access transport parameter, user service information, etc.

c) *Completion of transmission path*

Through-connection of the transmission path in both directions will be completed at an intermediate exchange immediately after the initial address message has been sent, except in those cases where conditions on the outgoing circuit prevent it (see § 2.1.9).

2.1.1.3 *Actions required at the destination exchange*

a) *Selection of called party*

Upon receipt of an initial address message the destination exchange will analyze the called party number to determine to which party the call should be connected. It will also check the called party's line condition and perform various checks to verify whether or not the connection is allowed. These checks will include correspondence of compatibility checks, e.g. checks associated with supplementary services.

At this point, certain call set-up information may need to be obtained from an originating or controlling exchange (see § 2.1.6). Examination of the protocol control indicator will show whether end-to-end information is necessary to be obtained before further processing of the call, in this case the SCCP, pass along or information request and information messages can be used.

In this case where the connection is allowed, the destination exchange will set up a connection to the called party. If a continuity check has to be performed on one or more of the circuits involved in a connection, setting up of the connection to the called party must be prevented until the continuity of such circuits has been verified.

2.1.2 *Forward address signalling – Overlap operation*

2.1.2.1 *Actions required at originating exchange*

a) *Circuit selection*

When the originating exchange has received sufficient information [see § 2.1.2.1 c)] from the calling party to determine that the call is to be routed to another exchange, selection of a suitable, free, inter-exchange circuit takes place and an initial address message is sent to the succeeding exchange.

Appropriate routing information is either stored at the originating exchange or at a remote database to which a request may be made.

The selection of the route will depend on the called party number, connection type required and the network signalling capability required. This selection process may be performed at the exchange or with the assistance of a remote database.

In addition, in the case of a subscriber with digital access, the set-up message contains bearer capability information which is analyzed by the originating exchange to determine the correct connection type and network signalling capability. The bearer capability information will be mapped into the user service information parameter of the initial address message. The information received from the access interface is used to set the value of the transmission medium requirement parameter. The first value of bearer information received will be used to set the initial mode of the connection.

The connection types allowed are:

- speech;
- 3.1 kHz audio;
- 64 kbit/s unrestricted;
- alternate speech/64 kbit/s unrestricted;
- alternate 64 kbit/s unrestricted/speech.

The network signalling capabilities allowed are:

- ISDN-UP preferred;
- ISDN-UP required;
- ISDN-UP not required (any signalling system).

The information used to determine the routing of the call by the originating exchange will be included in the IAM, (as transmission medium requirement and forward call indicators), to enable correct routing at intermediate exchanges. The IAM conveys implicitly the meaning that the indicated circuit has been seized.

In the case where $N \times 64$ kbit/s ($N \geq 2$) connections are required, the procedures for a single 64 kbit/s connection may be used if the $N \times 64$ kbit/s are contiguous 64 kbit/s channels and are pre-assigned for $N \times 64$ kbit/s use.

If subaddress information is received from the calling access, this information is passed unchanged to the destination exchange in the access transport parameter of the initial address message only.

b) *Address information sending sequence*

The sending sequence of address information on international calls will be the country code (not sent to an incoming international exchange) followed by the national (significant) number. On national connections, the address information may be the local number or the national (significant) number as required by the Administration concerned. For calls to international operator positions (Code 11 and Code 12) refer to Recommendation Q.107.

The end of pulsing (ST) signal will be used whenever the originating exchange or the outgoing exchange is in a position to know by digit analysis that the final digit has been sent.

c) *Content of initial and subsequent address messages*

The initial and subsequent address messages in principle contain all of the information that is required to route the call to the destination exchange and connect the call to the called party. The contents of the initial address message is the same as described in § 2.1.1.1 c). The only purpose of the subsequent address message is to carry further digits.

All digits required for routing the call through the international network will be sent in the IAM. On calls with a country code in the number (except in the case of calls to special operators), the IAM will contain a minimum of 4 digits and should contain as many digits as are available. Within national networks the address information contained within the IAM may vary depending on the routing requirement within the network.

The remaining digits of the number may be sent in subsequent address messages containing one or several digits as they are received. Efficiency can be gained by grouping together as many digits as possible. However, to prevent an increase in postsending delay in those cases where overlap operation with subscribers' dialling is used, it may be desirable to send the last few digits individually.

The end-of-pulsing (ST) signal is always sent in the following situations:

- i) semi-automatic calls;
- ii) test calls; and
- iii) when the end-of-pulsing (ST) signal is received.

In automatic working, the end-of-pulsing (ST) signal will be sent whenever the originating or outgoing exchange is in a position to know, by digit analysis, that the final digit has been sent. Digit analysis may consist of an examination of the country code and counting the maximum (or fixed) number of digits of the national number. In other cases, the end-of-pulsing signal is not sent and the end-of-address information is determined by the receipt of the address complete message or connect message from the incoming exchange.

d) *Transfer of information not included in the initial address message*

As an alternative to the inclusion of call set-up user facility information in the initial address message, any call set-up user facility information that need not be examined at intermediate exchanges and which can be requested by the destination exchange (see Recommendation Q.763, § 3.22), may be transported between the originating and destination exchange. The method of transportation for this information can be by the link-by-link method (see § 2.1.6) or via the end-to-end methods (see § 3).

e) *Completion of transmission path*

Through connection of the transmission path in the backward direction (the transmission path is completed in the forward direction on receipt of connect or answer message) at the originating exchange will be completed except in the cases where conditions on the outgoing circuit prevent it (see § 2.1.9):

- i) immediately after the sending of the initial address message, or
- ii) when digit analysis or timer (T_{10}), or receipt of the address complete message indicates that all digits have been received.

It is also acceptable that on speech or 3.1 kHz audio calls, through connection of the transmission path will be completed in both directions immediately after the initial address message has been sent, except in the cases where conditions on the outgoing circuit prevent it (see § 2.1.9).

f) *Network protection timer*

Each time when the originating exchange has sent an address message the awaiting address complete timer (T_7) is started. If timer (T_7) expires the connection is released and an indication is sent to the calling subscriber.

2.1.2.2 *Actions required at an intermediate exchange*

a) *Circuit selection*

An intermediate exchange, on receipt of an IAM, will analyze the digits available and the other routing information [see § 2.1.2.1 a)] to determine the routing of the call. If the intermediate exchange can route the call using the connection type specified in the transmission medium requirement parameter a suitable free inter-exchange circuit is seized and an IAM is sent to the succeeding exchange. If the number of digits in the called party number are not sufficient to route the call the routing will be carried out when the intermediate exchange has received additional digits in subsequent address message(s). Any address digits received in subsequent address messages during the circuit selection process may be included in this IAM. Any subsequent address messages received after the IAM has been sent, are forwarded to the succeeding exchange as subsequent address message(s).

Within the network if the intermediate exchange does not route the call just using the connection type specified in the transmission medium requirement parameter, the exchange may also examine the user service information containing the bearer capability information (if available) to determine if a suitable route can be selected. In this case the transmission medium requirement parameter is modified to the new connection type.

For calls between networks, the gateway exchange (e.g. outgoing ISC) must ensure that the transmission medium requirement parameter is set according to the service requested by the customer (see Recommendation E.172). More specifically this parameter is carried unchanged within the international network.

When no echo suppressor or nature-of-circuit indication is received from a preceding exchange using a signalling system with fewer facilities the indicators will be considered as received "no" unless positive knowledge is available.

Selection of the outgoing national circuit normally can start at an incoming international exchange on receipt of the IAM and signalling can proceed on the first national link.

b) *Parameters in the initial address message*

An intermediate exchange may modify signalling information received from the preceding exchange according to the capabilities used on the outgoing route. Signalling information that may be changed are nature of connection indicator, end-to-end method indicator; the most significant digits in the called party number may be amended or omitted [see § 2.1.1.1 b)]. A change of the end-to-end method used may also alter parameters (see § 3). Other signalling information is passed on transparently, e.g. the access transport parameter, user service information, etc.

c) *Completion of transmission path*

Through-connection of the transmission path in both directions will be completed at an intermediate exchange immediately after the initial address message has been sent, except in those cases where conditions on the outgoing circuit prevent it (see § 2.1.9).

2.1.2.3 *Actions required at the destination exchange*

a) *Selection of called party*

Upon the receipt of the sufficient called party number information the destination exchange will analyze the called party number to determine to which party the call should be connected. It will also check the called party's line condition and perform various checks, to verify whether or not the connection is allowed. These checks will include correspondence of compatibility checks, e.g. checks associated with supplementary services.

At this point, certain call set-up information may need to be obtained from an originating or controlling exchange (see § 2.1.6). Examination of the protocol control indicator will show whether end-to-end information is necessary to be obtained before further processing of the call, in this case the SCCP, pass along or information request and information messages can be used.

In the case where the connection is allowed, the destination exchange will set up a connection to the called party. If a continuity check has to be performed on one or more of the circuits involved in a connection, setting up of the connection to the called party must be prevented until the continuity of such circuits has been verified.

2.1.3 *Calling party number*

The calling party number can either be included in the initial address message [§§ 2.1.1.1 c) and 2.1.2.1 c)] or requested by the destination exchange (see § 2.1.6). If the calling party number is required at the destination exchange but is not included in the initial address message, the destination exchange will analyze the protocol control indicator to determine if the request and response should be conducted by one of the procedures in § 3. The destination exchange will investigate the presence/absence of the calling party number parameter to determine whether a request is useful or not. Further it may be necessary to withhold the sending of the address complete message until the calling party number has been successfully delivered.

2.1.4 *Address complete message, connect message and call progress message*

2.1.4.1 *Return of address complete message from destination exchange*

An address complete message will be sent from the destination exchange as soon as it has been determined that the complete called party number has been received, or an indication received from the called party that an inband tone is being connected (for this case see §§ 2.1.5 and 2.2.4). However there is no direct mapping from alerting, received from the access signalling system, to address complete in the network. In the case that the continuity check is performed the destination exchange will withhold sending the address complete message until a successful continuity indication has been received (see § 2.1.9).

Address complete is sent from the destination exchange in the following conditions:

- 1) In the case where the terminating access is non ISDN the following action takes place at the destination exchange:
 - a) In all cases an address complete message is sent as soon as it has been determined that the complete called party number has been received, and the destination exchange established that the subscriber is free. Indicators in the address complete message will be set to indicate:
 - call line status: “Subscriber free”
 - ISDN access indicator: “Non ISDN”
 - b) In the case of a PBX an address complete message is sent as soon as it has been determined that the called party number has been received. Indicators in the address complete message will be set to indicate:
 - called line status: “No indication”
 - ISDN access indicator: “Non ISDN”.
- 2) In the case where the terminating access is ISDN, the following conditions can apply:
 - a) If an indication that the address is complete or no status indication has been received from the ISDN access prior to the destination exchange determining that the complete called party number has been received, the indicators in the address complete message will be set as follows:
 - called line status: “No indication”
 - ISDN access indicator: “ISDN”.

Note – In case a) the indication that the destination user is being alerted is transferred in a call progress message (see § 2.1.5).
 - b) The destination exchange concludes from the receipt of an indication from the ISDN access that the complete called party number has been received. In this case the indicators in the address complete message will be set as follows:
 - called line status: “Subscriber free”
 - ISDN access indicator: “ISDN”.

2.1.4.2 *Return of connect message from the destination exchange*

If a connect indication is received from the ISDN access under the following conditions:

- no alerting indication received from the ISDN access and
- an address complete message has not yet been sent by the destination exchange,

a connect message is sent by the destination exchange. This connect message signifies both address complete and answer conditions.

Indicators in the connect message will indicate:

- called line status: “Subscriber free”
- ISDN access indicator: “ISDN”.

The destination exchange will through-connect before the connect message is sent.

2.1.4.3 *Receipt of address complete message or connect message at an intermediate exchange*

Upon receipt of an address complete message an intermediate exchange will send the corresponding address complete message to the preceding exchange. If a connect message is received at an intermediate exchange instead of an address complete message, a connect message will be sent to the preceding exchange.

2.1.4.4 *Receipt of address complete message or the connect message at the originating exchange*

- a) When the originating exchange receives an address complete message the appropriate exchange functions take place.
- b) On receipt of an address complete message with the called line status indicator set to “subscriber free” an alerting indication is passed to the calling party if possible.
- c) On receipt of the address complete message the awaiting address complete timer (T_7) is stopped and the awaiting answer timer (T_9) is started. If timer (T_9) expires the connection is released and an indication is sent to the calling subscriber.

- d) If the connect message is received then the appropriate exchange functions take place. The awaiting address complete timer (T_7) is stopped (see § 2.1.7.2).

2.1.4.5 *Through-connection and awaiting answer indication at the destination exchange*

The sending of the awaiting answer indication (e.g. ring tone) at the destination exchange depends on the type of call. On speech and 3.1 kHz calls and call to an analogue called party the awaiting answer indication is applied to the transmission path to the calling party from the destination exchange on receipt of an alerting indication from the called party or from information contained within the destination exchange that the called party will not or is prohibited from providing inband tone.

Regardless of whether tones are to be provided or not, the destination exchange will through-connect after the reception of the connection indication from the called party and before sending the answer/connect message to the preceding exchange.

If the destination exchange does not send the awaiting answer indication because the destination user provides for the sending of tones, then the destination exchange will through-connect the transmission path in the backward direction on receipt of the progress indication.

The complete through-connection of the transmission path at answer is covered in § 2.1.7.

2.1.4.6 *Address complete message with charging information*

The address complete message carries a charge indicator.

2.1.4.7 *Address complete message with other information*

Additional information can be included in the address complete messages (e.g. related to supplementary services, see Recommendation Q.730).

2.1.4.8 *Return of address complete message in interworking situations*

An address complete message will not be sent until the cross-office check is made, if applicable (see § 2.1.10).

If the succeeding network does not provide electrical called-party's-line-condition indications the last Signalling System No. 7 exchange shall originate and send an address complete message when the end of address signalling has been determined:

- a) by receipt of an end-of-pulsing (ST) signal; or
- b) by receipt of the maximum number of digits used in the national numbering plan; or
- c) by analysis of the national (significant) number to indicate that a sufficient number of digits has been received to route the call to the called party; or
- d) by receipt of an end-of-selection signal from the succeeding network (e.g. number received signal in Signalling System No. 5); or
- e) exceptionally, if the succeeding network uses overlap signalling and number analysis is not possible, by observing that timer (T_{10}) has elapsed since the last digit was received, and that no fresh information has been received; in such circumstances, transmission to the national network of the last digit received must be prevented until the end of the waiting period which causes an address complete message to be sent backward. In this way, it is enofed that no national answer signal can arrive before an address complete message has been sent.

If in normal operation, a delay in the receipt of an address complete signal from the succeeding network is expected, the last common channel signalling exchange will originate and send an address complete message 15 to 20 seconds (timer (T_{11})) after receiving the latest address message. The time-out condition is an upper limit considering the clauses of § 2.9.10.3 (20 to 30 seconds waiting for address complete message timer (T_7) for outgoing international exchanges in abnormal release conditions).

2.1.4.9 *Return of sub-address information in address complete message, connect message or call progress message*

If sub-address information is received from the called access this information is passed unchanged to the originating exchange in the access transport parameter of the address complete message, connect message or call progress message.

2.1.5 *Call progress*

The call progress message is sent (either before or after the address complete message) from an exchange in the backward direction indicating that an event has occurred during call set-up which should be relayed to the calling party.

2.1.5.1 *Return of call progress message from the destination exchange*

The call progress message is sent from the destination exchange if the address complete message has been sent and subsequently:

- an indication is received that the called party is being alerted,
the call progress message contains an event indicator that is set to “alerting”
- a progress indication is received from the called party,
the call progress message contains an event indicator that is set to “progress”.

If the indication received from the called party contains a “progress indication”, this is carried by the call progress message in the access transport parameter (transported unchanged across the public network).

The destination exchange may on receipt of the indication from the called party, that contains an appropriate progress indicator, through-connect the speech path, see § 2.1.4.5.

In the case of call failure and the connection of a tone or announcement being returned before the address complete message has been returned, see § 2.2.4.

2.1.5.2 *Action at an intermediate exchange*

On receipt of a call progress message an intermediate exchange will send the corresponding call progress message to the preceding exchange.

2.1.5.3 *Actions at the originating exchange*

On receipt of a call progress message at the originating exchange, no state change occurs (i.e. the awaiting address complete or the awaiting answer timer are not stopped), and the appropriate indication is sent to the calling user. If the call progress message contained information carried in the access transport parameter it is transferred unaltered into the indication returned to the calling user.

2.1.6 *Information messages*

2.1.6.1 *Requesting information*

An information request message may be sent to any exchange in the forward (backward) call establishment direction after sending (receiving) an IAM during call set-up.

2.1.6.2 *Sending information*

On sending an information request message a timer (T_{33}) is started. No second information request message may be sent in the same direction until a response information message is received. If the timer (T_{33}) expires before the response message is received, see § 2.10.7. The value of this timer (T_{33}) is 12-15 seconds to allow for a cascade of information request messages, as described in item ii). The response information message may be sent as follows:

- i) if all the information requested is available locally, then an information message containing all the required information is sent in response;
- ii) if all the information is not available locally, but may be available remotely, then an information request message may be sent to a subsequent exchange in the connection in an attempt to extract the information not locally available. (This information request message may be delayed if one has already been sent and the response not yet received.) On receipt of a response, all the information necessary to respond to the original information message is sent in an information message;
- iii) if all the information is not available locally or remotely, then an information message containing only the available information is sent and the requested but not delivered information is indicated as “not available”, using either the indication in the information indicator or an appropriate coding in the requested parameter.

2.1.6.3 *Sending unsolicited information*

Information that is available at an exchange and that does not correspond to information which can be or has been requested by an information request message, can be sent in the information message with the solicited information indicator set to signify that the message has been sent unsolicited.

The unsolicited information message can be used only if the ISDN user part has been used all the way. It can be sent in any direction in any call state (except in the awaiting release complete state).

Solicited and unsolicited information must not be sent in the same information message; if unsolicited information is to be sent at the same time together with solicited information, this has to be done in a separate message with the solicited information indicator set to “unsolicited”.

2.1.6.4 *Receiving an information message*

Upon receipt of an information message which does neither contain the requested information nor an indication that the requested information is not available, the actions taken will depend on whether the call can be progressed.

2.1.7 *Answer message*

2.1.7.1 *Return of answer message from destination exchange*

When the called party answers, the destination exchange connects through the transmission path and the ringing tone is removed if applicable. An answer message to the preceding exchange is sent. If the destination exchange is the exchange controlling charging, then charging may begin.

2.1.7.2 *Receipt of answer message at intermediate exchange*

Upon receipt of an answer message, an intermediate exchange sends the corresponding answer message to the preceding exchange and, if this is the exchange controlling charging, charging may begin, and timer (T₉) is stopped.

2.1.7.3 *Receipt of answer message at originating exchange*

When the originating exchange receives an answer message indicating the required connection has been completed, the transmission path is connected-through in the forward direction, if not already connected. The awaiting answer timer (T₉) is stopped. If the originating exchange is the exchange controlling charging, charging may begin if applicable. The calling party is informed.

2.1.7.4 *Return of answer from automatic terminals*

When connections are set-up to terminals having an automatic answer feature, the alerting indication may not be received from the called party. If a destination exchange receives an answer indication an answer message is sent provided that an address complete message has been sent, otherwise the connect message is sent.

2.1.7.5 *Answer with charging information*

The answer message received from the destination exchange or from a succeeding network carries a charge indicator.

2.1.8 *Continuity-check*

Because the signalling in Signalling System No. 7 does not pass over the circuit, facilities should be provided for making a continuity-check of the circuit in the circumstances described below.

The application of the continuity-check depends on the type of the transmission system used for the circuit.

For transmission systems having some inherent fault indication features giving an indication to the switching system in case of fault, a continuity-check is not required. However, a per call continuity-check may be needed on fully digital circuits when circuits or bundles of circuits in primary multiplex groups are dropped and inserted en route between switches, and alarm indications carried on bits of the primary multiplex frame structure are lost in passing through an intermediate transmission facility that does not relay them transparently. Typical, per call continuity-checks may be needed when the transmission link between switches contains a TDMA satellite system, a digital circuit multiplication system or a digital access and cross connection system, where fault indications are lost (see Recommendation Q.33).

When an initial address message is received with a request for a continuity-check relating to a digital circuit having inherent fault indication, one of the following actions is taken:

- either
- a) the continuity-check request is disregarded;
- or
- b) a continuity-check loop is connected and the maintenance system is alerted. In this case the call may fail since no continuity signal may be received from the distant end.

Note – The reception of such a request could only be caused by an abnormal condition such as administrative errors or the occurrence of signalling errors.

When the circuit type is unknown to an SS No. 7 exchange, or in an application where both analogue and digital circuits may be served or when no inherent fault indication is available, a continuity-check loop should always be connected in the following case:

- i) when the exchange has the capability to process initial address messages with continuity-check request and such messages are received;
- ii) when continuity-check request messages are received.

Means should be provided in SS No. 7 to detect circuit identification code misunderstandings between SS No. 7 exchanges.

For exchanges having both analogue and digital circuits served by SS No. 7, the continuity-check initiated by a continuity-check request message could be used to test for proper alignment of circuit code identities. On those exchanges, reception of a continuity-check request message should always cause a loop to be attached to the circuit.

Alternative methods for detection of circuit identity misunderstandings in exchanges with all digital circuits may be employed.

The continuity-check is not intended to eliminate the need for routine testing of the transmission path.

The continuity check of the circuit will be done, link-by-link, on a per call basis or by a statistical method prior to the commencement of conversation. Procedures and requirements are specified in Recommendation Q.724, § 7.

The actions to be taken when pilot supervision is used are described in Recommendation Q.724, § 9.

2.1.9 *Special procedures at an interworking point*

2.1.9.1 *Completion of transmission path at an interworking exchange*

In general, completion of the transmission path at an interworking point should occur as soon as possible during the call set-up phase. The actual point of switch-through will vary depending on the interworking signalling system, e.g. whether inband or outband signalling is used or whether a continuity-check procedure is applied.

When interworking with other internationally specified signalling systems, the following rules on switch-through should be applied:

SS No. 7 → SS No. 7	When no continuity-check is to be made on the outgoing circuit, through-connection should occur after sending the initial address message. When continuity-check is to be made on the outgoing circuit, through-connection should occur after residual check tone has propagated through the return path of the circuit (see Recommendation Q.724, § 7.3).
SS No. 6 → SS No. 7 SS No. 5 → SS No. 7 R1 → SS No. 7 SS No. 7 → SS No. 6	When no continuity-check is to be made on the outgoing circuit, through-connection can occur after sending the initial address message. When a continuity-check is to be made on the outgoing circuit, through-connection can occur after residual check tone has propagated through the return path of the circuit (see Recommendation Q.724, § 7.3).
R2 → SS No. 7	Through-connection should occur after receipt of address complete.
SS No. 7 → SS No. 5 SS No. 7 → R1	Through-connection can occur after sending ST (end of pulsing) signal and removal of a possible check loop.
SS No. 7 → R2	Through-connection should occur after sending of address complete.

When a continuity-check is made on the outgoing circuit, and early connection is made, there is a possibility that the calling party has its go and return paths temporarily looped (from the instant of through-connection to the instant of loop removal of the incoming end of the circuit). This problem can be prevented by using the optional single report continuity-check procedure given in Recommendation Q.724, § 7.3.

2.1.9.2 *Alerting of called party*

If in an interworking situation a continuity-check has to be performed on one or more of the circuits involved in the connection preceding the interworking point, appropriate measures must be taken to prevent alerting of the called party until the continuity of such circuits has been verified. Interworking situations which could be discriminated are:

- a) SS No. 7 → any non No. 7 signalling system.
- b) International SS No. 7 → national SS No. 7 not performing continuity-check.

For a) the last digit(s) of the national number have to be withheld in any (interworking) transit exchange or terminating exchange in case of DDI (direct dialling in) or the alerting of the called party is postponed in the terminating exchange in case of non DDI.

For b) either the last digit(s) of the national number are withheld in the incoming international transit exchange, a transit exchange in the national network or the terminating exchange in case of DDI (direct dialling in) or the setting up of the connection to the called party is postponed in the terminating exchange in case of non DDI.

2.1.10 *Cross office check*

For digital exchanges, the requirements mentioned in Recommendation Q.543 shall be met. For other exchanges, Administrations shall ensure the reliability of a connection through a switching machine (cross-office check) either on a per call basis or by a statistical method. With either method, the probability of the connection being established with an unacceptable transmission quality should not exceed 0.00001 as the long-term average.

2.1.11 *Charging procedures*

2.1.11.1 *Basic call charging*

Charging will normally begin when the exchange(s) controlling charging receives the answer or connect message from the network. Optionally an Administration may wish to begin charging prior to the receipt of the answer or connect message for national and/or international calls.

2.1.11.2 *Network charging messages (national option)*

When the charging exchange does not have the capability to determine the charge rate for a particular call, charge information may be received during the call set-up. Also, charge rate information may be returned during call set-up, followed subsequently by further charge information messages during the conversation/data phase, should the original rate require to be changed during the call.

2.1.12 *Forward transfer message*

The forward transfer message may be sent in telephony semi-automatic working in either of the following two cases:

- a) following a call switched automatically to a subscriber, or following a call established via a special operator, the controlling operator wishes to call in an assistance operator. On receipt of the forward transfer message at the incoming international exchange, an assistance operator is called in;
- b) following a call via codes 11 and 12, the controlling operator wishes to recall the incoming international exchange. Receipt of the forward transfer message at the incoming international exchange recalls the incoming operator on calls completed via the operator positions at the exchange.

2.1.13 *Transit network selection (national option)*

If transit network selection information is included in the set-up information from the calling party or is provided on a subscription basis, this information is carried in the transit network selection parameter, and is used for routing of the call, e.g. to a specific carrier.

A sequence of transit networks may be specified by the calling party, in which case the transit network selection parameter is repeated in the order specified.

2.2 *Unsuccessful call set-up*

If at any time in the call set-up the connection cannot be completed a release message is returned. This message contains the reason.

2.2.1 *Actions at exchange initiating a release message*

The initiating exchange immediately starts the release of the switched path (if established). The exchange sends a release message to the preceding exchange and a timer (T_1) is started to ensure that a release complete message is received from the preceding exchange within time T_1 [expiration of timer (T_1) is covered in § 2.10.6].

2.2.2 *Actions at intermediate exchange*

On receipt of a release message from the succeeding exchange, an intermediate exchange:

- i) immediately start the release of the switched path; when the circuit is reselectable, a release complete message is returned to the succeeding exchange;
- ii) at the same time as the start of the release of the switched path, a release message is sent to the preceding exchange. A timer (T_1) is started to ensure that a release complete message is received from the preceding exchange within time T_1 (expiration of this time is covered in § 2.10.6).

2.2.3 *Actions at the controlling exchange (i.e. the exchange controlling the call)*

On receipt of a release message from the succeeding exchange, the controlling exchange starts the release of the switched path.

In addition, the controlling exchange will: (if applicable)

- a) return an indication (in band or out band) to the calling party (see § 2.2.4); or
- b) attempt to re-route the call set-up; or
- c) initiate release procedures to the preceding exchange (as described in § 2.2.4).

In case a) above an indication is carried in the call progress message or address complete message indicating in-band information is available, (see § 2.2.4).

When the controlling exchange is ready for circuit re-selection, a release complete message is sent to the succeeding exchange.

2.2.4 *Tones and announcements*

If a call set-up fails and an in-band tone or announcement has to be returned to the calling party from an exchange or called party, the exchange or user concerned connects the in-band tone to the transmission path.

If an address complete message has been returned to the preceding exchange a call progress message indicating that in-band tone information is available, is returned to the preceding exchange (see § 2.1.5).

If an address complete message has not been returned to the preceding exchange already, an address complete message, with the appropriate cause parameter and the "in-band information" indicator set in the optional backward call indicator, will be returned to the originating exchange.

2.3 *Normal call release*

The release procedures are based on a two message (release, release complete) approach whereby the release message initiates release of the circuit switched connection.

The same procedures are used in the network irrespective of whether they are initiated by the calling party, the called party or the network. The normal release procedure can be prevented by the network if this is required on a particular call (§ 2.6).

To satisfy the need for rapid transfer of release across the network, it is required that the circuit is selectable from the subsequent exchange within the mean cross-office transfer time, T_{CU} , for simple messages as specified in Recommendation Q.766.

2.3.1 *Release initiated by a calling party*

a) *Actions at the originating exchange*

On receipt of a request to release the call from the calling party, the originating exchange immediately starts the release of the switched path. A release message is sent to the succeeding exchange and a timer (T_1) is started to ensure that a release complete message is received from the succeeding exchange within T_1 (expiration of this time is covered in § 2.10.6).

b) *Actions at an intermediate exchange*

On receipt of a release message from the preceding exchange, an intermediate exchange:

- i) immediately starts the release of the switched path; when the circuit is reselectable, a release complete message is returned to the preceding exchange;
- ii) at the same time as the start of the release of the switched path, sends a release message to the succeeding exchange. A timer (T_1) is started to ensure that a release complete message is received from the succeeding exchange within time T_1 (expiration of this time is covered in § 2.10.6).

c) *Actions at the destination exchange*

On receipt of a release message from the preceding exchange, the destination exchange will start the release of the switched path. When the circuit is ready for reselection a release complete message is returned to the preceding exchange.

d) *Charging*

Charging is stopped upon receipt of the release message at the charging exchange or on receipt of a request to release the call from the calling party when the charging exchange is the originating local exchange.

e) *Collision of release messages*

In the case when two points in the connection both initiate the release of a call, a release message may be received at an exchange from a succeeding or preceding exchange after the release of the switched path is initiated. In this case, the exchange will return a release complete message to the exchange from which the concerned release message was received. The release complete message will be sent when the circuit is ready for re-selection.

2.3.2 *Release initiated by a called party*

The procedures in § 2.3.1 apply, except that the functions at the originating and destination exchanges are transposed.

2.3.3 *Release initiated by the network*

The procedures in § 2.3.1 apply, except that they can be initiated at any exchange (originating, destination or intermediate).

2.3.4 *Storage and release of IAM information*

Each exchange of the connection shall store during the call set-up the information contained in the initial address message sent (the originating exchange) or received (intermediate or destination exchange). The information to be stored includes all parameters in the IAM. The contents of the IAM information shall be updated, if the value of parameters change during the call set-up.

The IAM information can be released from memory:

- a) in the originating exchange when the address complete message or connect message has been received and the calling party does not subscribe to a supplementary service which would cause a new call set-up (e.g. call transfer). The release of the information when the calling party does subscribe to a supplementary service is covered in Recommendation Q.730;
- b) in the intermediate exchange when the address complete message or the connect message has been received;
- c) in the destination exchange when the address complete message or connect message has been sent and the called party does not subscribe to a supplementary service which would cause a new call set-up (e.g. call transfer). The release of the information when the called party does subscribe to a supplementary service is covered in Recommendation Q.730,

and when the call is released earlier and no automatic repeat attempt is to be attempted.

2.4 *Transfer of user-to-user information*

2.4.1 *Requirements for transfer of user-to-user data*

See Recommendation Q.730.

2.5 *Suspend, resume*

2.5.1 *Suspend*

The suspend message indicates a temporary cessation of communication without releasing the call. It can only be accepted during the conversation/data phase. A suspend message can be either generated in response to a suspend request from the calling/called party or generated by the network in response to a clearback indication from an interworking node or an on-hook condition from an analogue called (telephone) party.

2.5.1.1 *Suspend initiated by a calling party*

A suspend message is generated in response to a suspend request from a calling party.

a) *Actions at originating exchange*

On receipt of a suspend request from the calling party, the originating exchange sends a suspend message to the succeeding exchange.

b) *Actions at an intermediate exchange*

On receipt of the suspend message from the preceding exchange the intermediate exchange sends a suspend message to the succeeding exchange.

c) *Actions at destination exchange*

On receipt of the suspend message from the preceding exchange, the destination exchange informs the called party that a suspend has been requested.

d) *Actions at the suspend request controlling exchange*

On receipt of the suspend request from a user or the suspend message, the controlling exchange starts a timer (T_2) to ensure that a resume request or resume message is received within timer (T_2). If the timer (T_2) expires, the procedures in § 2.5.3 apply.

2.5.1.2 *Suspend initiated by a called party*

The procedures in § 2.5.1.1 apply, except that the functions at the originating and destination exchanges are transposed.

2.5.1.3 *Suspend initiated by the network*

A suspend message can be generated by the network in response to a clearback indication from an interworking node or an on-hook condition from an analogue called party.

a) *Action at the terminating exchange (destination) or an interworking exchange*

On receipt of an on-hook condition in the terminating exchange or a clearback signal at the interworking exchange, the exchange may send a suspend (network) message to the preceding exchange.

b) *Action at the intermediate exchange*

On receipt of a suspend message the exchange will send a suspend message to the preceding exchange.

c) *Action at the controlling exchange*

On receipt of the on-hook condition or clearback indication or suspend message, the controlling exchange starts a timer (T_6) to ensure that an off-hook condition, a re-answer indication, a resume (network) message or a release message is received. The value of this timer (T_6) is covered in Recommendation Q.118. If the timer (T_6) expires, the procedures in § 2.5.3 apply.

2.5.2 *Resume*

A resume message indicates a request to recommence communication. A request to release the call received from the calling or called party will override the suspend/resume sequence and the procedures given in § 2.3 will be followed.

2.5.2.1 *Resume initiated by a calling party*

Having initiated a suspend condition, a calling party may request a reconnection within timer T_2 . The procedures in § 2.5.1.1 items a), b) and c) apply except that the resume message replaces the suspend message. On receipt of the resume message, the controlling exchange cancels the timer (T_2).

2.5.2.2 *Resume initiated by a called party*

The procedures in § 2.5.2.1 apply except that the functions at the originating and destination exchange are transposed.

2.5.2.3 *Resume initiated by the network*

A resume message is initiated by the network, if a suspend message had previously been sent, in response to a re-answer indication from an interworking node or an off-hook condition from an analogue called party.

a) *Action at the terminating exchange or interworking exchange*

On receipt of a re-answer indication at the interworking exchange or an off-hook condition in the terminating exchange, the exchange may send a resume (network) message to the preceding exchange if a suspend (network) message had previously been sent.

b) *Actions of the intermediate exchange*

On receipt of a resume message the exchange will send a resume message to the preceding exchange.

c) *Action of the controlling exchange (i.e. exchange controlling the call)*

On receipt of the off-hook condition, re-answer signal, release message or resume message the controlling exchange stops the timer (T_6) [started in § 2.5.1.3 c)].

2.5.3 *Expiration of timer (T_2) or timer (T_6)*

If a request for reconnection or a resume message is not received within timer (T_2) or timer (T_6) covered in Recommendation Q.118 then the controlling exchange will initiate the release procedure outlined in § 2.3.3.

2.6 *Delayed release (national option)*

The delayed release message is generated by the network in response to a request from the calling/called party to release the call if the network is applying a hold to the connection. The delayed release message can be sent in either direction.

The local exchange receiving the release request sends a delayed release message. The connection is split, timer (T_3) is started (to prevent network lock-up) and charging is stopped. At the other end of the connection, the delayed release message causes an indication to be sent to the called/calling party.

Receipt of a connect or reconnection request from the called/calling party during the held state (after the delayed release message has been sent) will not cause the network to set up or resume the connection. When the hold condition is removed or the timer (T_3) matures, the network generates the normal release sequence (§ 2.3.3).

2.7 *In-call modification*

At the start of the call, it is required to know whether the call is an alternate speech/64 kbit/s or alternate 64 kbit/s/speech unrestricted call request. If this is the case then the following procedures apply:

Following call set-up the calling or called party may choose to modify the characteristics of the call during the conversation/data phase. During call set-up, the network will have chosen a suitable route (e.g. 64 kbit/s and ISDN user part signalling used all the way) according to information included in the initial address message.

2.7.1 *Successful completion*

2.7.1.1 *Actions required at the exchange originating the call modification*

- a) On receipt of a call modification request from the called/calling party, the initiating exchange checks that call modification is allowed and that the necessary resources are available. If acceptable, the resources are reserved and the call modification request message is sent. A timer (T_4) is started to ensure that a call modification completed message is received within timer (T_4).
- b) On receipt of the call modification complete message, the exchange modifies the resource and, when complete, informs the initiating party that the modification is complete. The timer (T_4) is cancelled.

2.7.1.2 *Actions required at intermediate exchanges*

- a) On receipt of the call modification request message an intermediate exchange checks that the necessary resources are available. If acceptable, the resources are reserved and the call modification request message is passed on to the next exchange.
- b) On receipt of a call modification completed message, the intermediate exchange modifies the resource and, when complete, sends a call modification completed message to the next exchange.

2.7.1.3 *Actions required at the local exchange receiving the request call for in-call modification*

- a) On receipt of a call modification request message the exchange checks that call modification is allowed and that the necessary resources are available. If acceptable, the resources are reserved and the call modification indication is sent to the called/calling party.
- b) After the calling/called party has changed state and the modification in the local exchange has been completed, a call modification complete message is returned to the network.

2.7.2 *Unsuccessful completion*

Basically three cases of unsuccessful completion can be identified:

- i) If the in call modification request fails at an intermediate or at the remote exchange, i.e. because no resources are available or in call modification is not allowed, a call modification reject message is returned in the direction of the exchange originating the in call modification request. The connection is maintained in its current mode.
- ii) If an intermediate exchange or the exchange initiating the call modification request fails to modify the characteristics of the transmission path, the connection is released.
- iii) If at the exchange initiating the call modification request timer (T_4) expires, the connection is released.

2.7.2.1 *Actions required at the local exchange initiating the call modification*

On receipt of the call modification reject message the exchange keeps the characteristics of the transmission path in the current mode, stops the timer (T_4) and informs the initiating party. If resources have been reserved upon reception of the call modification request, they are released.

2.7.2.2 *Actions required at an intermediate exchange*

If the in call modification request fails or if the call modification reject message is received by the intermediate exchange the characteristics of the transmission path are kept in the current mode and the call modification reject message is returned in the initiating direction. If resources have been reserved upon reception of the call modification request message, they are released.

If an intermediate exchange, upon receipt of a call modification complete message, fails to change the characteristics of the transmission path, it initiates the release of the connection in both directions.

2.7.2.3 *Action required at the remote local exchange receiving the call modification request from the network*

If at the remote local exchange the in call modification cannot be performed, the characteristics of the transmission path are kept in the current mode and the call modification reject message is returned to the network. If resources have been reserved upon reception of the call modification request message, they are released.

2.8 *Echo control procedure*

2.8.1 *General*

The echo control procedure is used on a per call basis to convey information between exchange nodes about the demand and ability to insert echo control devices.

The procedure is invoked when a call is to be routed on a connection for which echo control is necessary. It could be initiated at the originating exchange or at an intermediate exchange.

2.8.2 *Forward direction*

2.8.2.1 *Actions at the originating exchange*

If an originating exchange has sufficient information to determine that echo control is necessary for the outgoing circuit then:

- an outgoing half echo control device is enabled; and
- the echo control device indicator of the nature of connection indicators parameter field in the IAM is set.

2.8.2.2 *Actions at an intermediate exchange*

If an intermediate exchange has sufficient information to determine that echo control is required for the outgoing circuit then one of the following actions can occur:

- a) When the nature of connection indicators parameter field in the IAM indicates that an echo control device is already included:
 - no change to the nature of connection indicators parameter field in the IAM is made;
 - an incoming half echo control device is reserved; and
 - any outgoing half echo control device is disabled.
- b) When the nature of connection indicators parameters in the IAM does not indicate that an echo control device is already included:
 - an outgoing half echo control device is enabled; and
 - the echo control device indicator in the nature of connection indicators parameter field is set.

If the intermediate exchange has sufficient information to determine that echo control is not required for the outgoing circuit then one of the following actions can occur:

- a) When the nature of connection indicators parameter field in the IAM indicates that an echo control device is already included:
 - no change to the nature of connection indicators parameter field in the IAM is made; and
 - an incoming half echo control device is reserved.
- b) When the nature of connection indicator parameter field in the IAM does not indicate that an echo control device is already included:
 - no additional action is required.

2.8.2.3 *Actions at the destination exchange*

See § 2.8.3.1 below.

2.8.3 *Backward direction*

2.8.3.1 *Actions at the destination exchange*

Upon the receipt of an IAM with the indication “outgoing half echo control device included” in the nature of connection indicators parameter field, the following action is taken:

- an incoming half echo control device is enabled; and
- the echo control device indicator of the backward call indicators parameter field in the first backward message (i.e. ACM or connect or call progress) is set.

If the destination exchange is unable to include an incoming half echo control device, the information is conveyed to the preceding exchange by an echo control device indicator in the nature of connection indicators field not being set in the first backward message.

2.8.3.2 *Actions at an intermediate exchange*

Upon receipt of the first backward message (i.e. ACM or connect or call progress) in response to an IAM with echo control indication, then one of the following actions can occur:

- a) When the backward call indicators parameter field indicates that an incoming half echo control device is not already included:
 - the reserved incoming half echo control device is included; and
 - the echo control device indicator in the backward call indicators parameter field is set.
- b) When the backward call indicators parameter field indicates that an incoming half echo control device is already included:
 - the reserved incoming half echo control is released; and
 - no change to the backward call indicators parameter field in the backward message is made.

2.8.3.3 *Actions at the originating exchange*

No additional action is required.

2.9 *Network features*

2.9.1 *Automatic repeat attempt*

Automatic repeat attempt, as defined in Recommendation Q.12, is provided in Signalling System No. 7. An automatic repeat attempt will be made (up to the point when the initial address message information is released, see § 2.3.4):

- i) on detection of dual seizure (at the non-control exchange) (see § 2.10.1.4);
- ii) on receipt of the blocking message after sending an address message and before any backward message has been received (see § 2.9.2);
- iii) on receipt of a reset circuit message after sending an address message and before a backward message has been received [see § 2.10.3.1 e)];
- iv) on failure of continuity-check, when a continuity check is performed;
- v) on receipt of an unreasonable message during call set up (see § 2.10.5).

2.9.2 *Blocking and unblocking of circuits and circuit groups*

The blocking (unblocking) message and the circuit group blocking (unblocking) message are provided to permit the switching equipment or maintenance system to remove from (and return to) traffic the distant terminal(s) of a circuit or group of circuits because of a fault or to permit testing.

Since the circuits served by the ISDN user part have both-way capability, the blocking message or circuit group blocking message can be originated by either exchange. The receipt of a blocking message or a circuit group blocking message will have the effect of prohibiting non test calls on the relevant circuit(s) outgoing from the exchange until an unblocking message or an appropriate circuit group unblocking message is received, but will not prohibit test calls incoming to that exchange. An acknowledgement sequence is always required for the blocking and unblocking message as well as for the circuit group blocking message and circuit group unblocking messages using the blocking acknowledgement message, the unblocking acknowledgement message, the appropriate circuit group blocking acknowledgement messages and the appropriate circuit group unblocking acknowledgement message respectively. The acknowledgement is not sent until the appropriate action – either blocking or unblocking – has been taken. The release message should not override a blocking message and return circuits to service which might be faulty. The blocked circuit(s) will be returned to service on transmission of the unblocking acknowledgement message or the appropriate circuit group unblocking acknowledgement message at one exchange and on receipt of the unblocking

acknowledgement message or the appropriate circuit group unblocking acknowledgement message at the other exchange.

2.9.2.1 *Other actions on receipt of a blocking message*

In the event of a blocking message being received, after an initial address message has been sent in the opposite direction on that circuit, and before a backward message relating to that call has been received, an automatic repeat attempt will be made on another circuit. The exchange receiving the blocking message releases the original call attempt in the normal manner after sending the blocking acknowledgement message and will not seize that circuit for subsequent calls.

If the blocking message is received:

- after an initial address message has been sent for that circuit in the opposite direction and after at least one backward message relating to that call has been received, or
- after an initial address message has been received for that circuit beforehand,

the exchange will not seize that circuit for subsequent calls.

The fact that the circuit is engaged on a call will not delay transmission of the blocking (unblocking) acknowledgement message.

If a blocking message is sent and subsequently an initial address message is received in the opposite direction, the following action is taken:

- for test calls, the call should be accepted, if possible. In the case where the test call cannot be accepted, the blocking message must be returned;
- for calls other than test calls, the blocking message must be returned and the initial address message discarded.

When a circuit is blocked by use of the blocking message the maintenance system should be informed at both ends of the circuit.

2.9.2.2 *Circuit group blocking and unblocking messages*

The following circuit group blocking (unblocking) messages and their corresponding acknowledgement messages are provided:

- maintenance oriented circuit group blocking (unblocking) message;
- hardware failure oriented circuit group blocking (unblocking) message;

The circuits to be blocked (unblocked) are indicated in the status field.

The maximum number of circuits to be blocked (unblocked) with one circuit group blocking (unblocking) message is limited to 32.

A received circuit group blocking (unblocking) acknowledgement message has to match in the parameter value of the circuit identification code, the circuit group supervision message type indicator, and the range field (see Recommendation Q.763) with the previously sent group blocking (unblocking) message in order to be considered a valid acknowledgement.

A circuit is controlled by the ISDN user part if it can be used by the ISDN user part as a circuit switched bearer. Hence, time slots in a digital path that are used for synchronisation (e.g. time slot 0 in a 2048 kbit/s digital path) or as signalling channels are not circuits whose control is allocated to the ISDN user part.

Some of the circuit identification code values covered by the range field of a circuit group blocking (unblocking acknowledgement) message may not be allocated to any circuit. Then the corresponding status bits in the status field are set to 0. This is not allowed for the circuit identification code values related to status bits being set to 1. Those circuit identification code values must always be allocated to circuits whose control is allocated to the ISDN user part. In particular the circuit identification code value indicated in the label of a message must be allocated to a circuit.

The maintenance oriented circuit group blocking (unblocking) procedures set (remove) the same blocking states as the blocking (unblocking) procedures. This means that a blocking state set by a maintenance oriented circuit group blocking message or indicated as blocked for maintenance purposes in the status field of a circuit group reset acknowledgement message can be removed by an unblocking message. Similarly, a blocking state set by a blocking message can be removed by a maintenance oriented circuit group unblocking message.

The maintenance blocked state set by maintenance oriented circuit group blocking message, by a status indicator in a circuit group reset acknowledgement message or a blocking message cannot be removed by a hardware oriented circuit group unblocking message.

The range of circuits to be blocked (unblocked) is indicated in the range field. Those circuits within the range that have to be blocked (unblocked) are indicated in the status field. The same rule applies to the acknowledgements.

For the circuits blocked for maintenance reasons the same conditions apply and the same actions have to be taken as described in § 2.9.2.1.

For the circuits seized by ongoing calls or call attempts and blocked for reasons of hardware failure the following actions will be taken:

- all interconnected circuits have to be released by the appropriate messages;
- the affected circuits are set to the condition “idle hardware blocked” without any exchange of release messages.

The fact that a circuit is engaged on a call will not delay the transmission of the corresponding circuit group blocking (unblocking) acknowledgement message.

The hardware blocked state can only be removed by a hardware failure oriented circuit group unblocking message.

For all instances of circuit group blocking the maintenance system should be notified at both ends of the circuit(s).

2.9.2.3 *Abnormal blocking and circuit group blocking procedures*

The following procedures are designed to cover abnormal cases which may occur in the circuit group blocking/unblocking procedures.

- i) If a circuit group blocking message is received relating to remotely blocked circuits then blocking acknowledgement indications for those circuits are given in the status field of the corresponding circuit group blocking acknowledgement message which will be sent in response.
- ii) If a circuit group unblocking message is received relating to circuits which are not in the state remotely blocked, then unblocking acknowledgement indications for those circuits are given in the status field of the corresponding circuit group unblocking acknowledgement message which will be sent in response.
- iii) When an exchange upon receipt of a circuit group blocking (unblocking) message is not able to give an appropriate blocking (unblocking) acknowledgement indication for each circuit identification code (e.g. because that/those circuit identification code(s) is(are) not allocated to any circuit at the receiving exchange) for which also a blocking (unblocking) indication is given in the status field of the received group blocking (unblocking) message, then no blocking (unblocking) acknowledgement indication relating to that/those circuit identification code(s) will be given in the status field of the corresponding circuit group blocking (unblocking) acknowledgement message which will be sent in response.
- iv) If a circuit group blocking acknowledgement message in response to a circuit group blocking message is received containing in the status field the indications no blocking acknowledgement for the circuits which are to be blocked due to the previously sent circuit group blocking message, then (a) circuit group blocking message(s) will be repeated for the circuits concerned (see § 2.10.4). The same rule applies to the unblocking procedures.
- v) If a circuit group blocking acknowledgement message in response to a circuit group blocking message is received containing in the status field blocking acknowledgement indications for the circuits which are not to be blocked due to the previously sent circuit group blocking message and are not marked locally blocked, then a circuit group unblocking message will be sent for the circuits concerned.
- iv) If a circuit group unblocking acknowledgement message in response to a group unblocking message is received containing in the status field unblocking acknowledgement indications for circuits which are not to be unblocked due to the previously sent circuit group unblocking message and have to remain marked locally blocked, then a circuit group blocking message will be sent for the circuits concerned.
- vii) If a circuit group blocking acknowledgment message which is not expected as an acknowledgment for any circuit group blocking message is received:
 - relating to circuits which all are in the status locally blocked the received circuit group blocking acknowledgement will be discarded;
 - relating to circuits part or all of which are not in the status locally blocked then a circuit group unblocking message will be sent for the relevant circuits.
- viii) If a circuit group unblocking acknowledgement message which is not expected as an acknowledgement for any circuit group unblocking message is received:

- relating to circuits none of which is in the status locally blocked then the circuit group unblocking acknowledgement message will be discarded;
 - relating to circuits part or all of which are locally blocked then a circuit group blocking message will be sent for the relevant circuits.
- ix) If a circuit group blocking (unblocking) message or a circuit group blocking (unblocking) acknowledgement message refers to status changes for more than 32 circuits the receiving exchange may discard that message.
- x) If a blocking message is received for a blocked circuit, a blocking acknowledgement message will be sent.
- xi) If an unblocking message is received for an unblocked circuit, an unblocking acknowledgement message will be sent.
- xii) If a blocking acknowledgement message, which is not expected as an acknowledgement for a blocking message, is received:
- relating to a circuit which is locally blocked, the blocking acknowledgement message is discarded;
 - relating to a circuit which is not locally blocked, then an unblocking message will be sent;
- xiii) If an unblocking acknowledgement message, which is not an expected response to an unblocking message, is received:
- relating to a circuit which is not locally blocked, the received unblocking acknowledgement message is discarded;
 - relating to a circuit which is locally blocked then a blocking message will be sent.
- xiv) If a non test initial address message is received on a remotely blocked circuit, the remotely blocked state of the circuit is removed and the initial address message is processed normally unless the circuit is also locally blocked in which case the initial address message is discarded. This applies to the blocking state whether maintenance, hardware or both. However it should not be the preferred method of unblocking a circuit.

2.9.3 *Circuit group query*

2.9.3.1 *General*

The circuit group query test allows an exchange to audit the state of a circuit on a demand or routine basis.

The value N of the range field of the circuit group query message, including N=0 for a single circuit, indicates the range to be tested. The maximum value of N is 31. If that value is exceeded the circuit group query message is discarded.

2.9.3.2 *Interpretation of circuit states*

For the purposes of circuit query procedures, there are states which are classified into four major categories, as follows:

- 1) unequipped and transient conditions,
- 2) call processing states,
- 3) maintenance blocking states,
- 4) hardware blocking states.

The two states “unequipped” and “transient” do not overlap with other states.

Call processing states include:

- 1) idle,
- 2) circuit incoming busy,
- 3) circuit outgoing busy.

Maintenance blocking states include:

- 1) unblocked,
- 2) remotely blocked,
- 3) locally blocked,
- 4) locally and remotely blocked.

Hardware blocking states include:

- 1) unblocked,
- 2) remotely blocked,
- 3) locally blocked,
- 4) locally and remotely blocked.

A circuit is “unequipped” if the circuit is not available for ISDN user part. Call processing or maintenance action cannot be performed on it. This is a unique state and will not overlap with any other state.

The “transient” state refers to any transient call processing or maintenance states.

Call processing is in a transient state

- a) after having sent an initial address message and waiting for the first backward message (whether a suspended call is in a transient state in the context of circuit group query is for further consideration), or
- b) after having sent a release message and waiting for the release complete message.

Transient maintenance states are those, where the exchange after having sent a (group) (un)blocking message is awaiting the proper (group) (un)blocking acknowledgement message from the remote exchange.

The circuit state is also considered transient as long as a circuit (group) reset message has not been acknowledged.

The “idle” state is a call-processing state of an equipped, non-busy circuit. The “circuit incoming busy” or “circuit outgoing busy” refers to a stable call processing state.

The hardware or maintenance “remotely blocked” state refers to the state marked by the exchange when the far-end exchange initiates blocking. The maintenance blocking state can co-exist with “idle”, “circuit incoming busy”, or “circuit outgoing busy” state. The hardware blocking state can only co-exist with the “idle” call processing state, as calls are immediately released when hardware blocking is invoked.

The hardware or maintenance “locally blocked” state refers to the state marked by the exchange when it initiated blocking to the far-end exchange and the proper acknowledgement was received. The maintenance blocking state can co-exist with “idle”, “circuit incoming busy”, or “circuit outgoing busy” state. The hardware blocking state can only co-exist with the “idle” call processing state, as calls are immediately released when hardware blocking is invoked.

To initiate the circuit group query procedure, the sending exchange sends a circuit group query message indicating in the routing label and range field those circuits to be audited. If no response to the circuit group query message is received before timer (T₃₄ 12-15 seconds) expires, maintenance systems should be informed.

The receiving exchange will process the circuit group query message, and return a circuit group query response message setting the circuit state indicators to the state of the circuits being audited.

If this circuit group procedure uncovers discrepancies in the state of a circuit as perceived at the two ends. The action to be taken in order to align the two views are for further study.

2.10 *Abnormal conditions*

2.10.1 *Dual seizure*

Because Signalling System No. 7 circuits have the capability of bothway operation, it is possible that the two exchanges will attempt to seize the same circuit at approximately the same time.

2.10.1.1 *Unguarded interval*

The exchange must detect dual seizure and take action as defined in § 2.10.1.4.

2.10.1.2 *Detection of dual seizure*

A dual seizure is detected by an exchange from the fact that it receives an initial address message for a circuit for which it has sent an initial address message, but before it receives a valid backwards message.

2.10.1.3 *Preventive action*

Different methods for circuit selection can be envisaged to minimise the occurrence of dual seizure. In the following, two methods are described. Further study is required to determine the field of application of each method and to enofe that the two methods do inter-work satisfactorily.

Other methods for circuit selection may also be used provided that they give the same degree of protection against dual seizure also when one of the methods specified is used at the other end.

Method 1

An opposite order of selection is used at each exchange of a bothway circuit group.

Method 2

Each exchange of a bothway circuit group has priority access to the group of circuits which it is controlling (see § 2.10.1.4). Of this group the circuit which has been released the longest is selected (first-in, first-out). In addition each exchange of a bothway circuit group has non-priority access to the group of circuits which it is non-controlling. Of this group the latest released circuit is selected (last-in, first-out) if all circuits in the group are busy.

For call control purposes a bothway circuit group can be subdivided into subgroups in an exchange.

It is necessary to take preventive action in cases where Signalling System No. 7 uses a signalling data link with long propagation time.

2.10.1.4 Action to be taken on detection of dual seizures

Each exchange will control one half of the circuits in a bothway circuit group. On detection of a dual seizure, the call being processed by the control exchange for that circuit will be completed and the received initial address message will be disregarded.

Under these conditions, the call being processed by the control exchange will be allowed to mature. The call being processed by the non-control exchange will be backed off and the switch-path released. A release message will not be sent. The non-control exchange will make an automatic repeat attempt on the same or on an alternative route.

For the purpose of resolution of dual seizure on bothway circuits, the exchange with the higher signalling point code will control all even-numbered circuits (circuit identification code) and the other exchange the odd-numbered circuits. The designation of control may also be used for maintenance system purposes.

2.10.2 Transmission alarm handling for digital inter-exchange circuits

When fully digital circuits are provided between two exchanges, which have some inherent fault indication feature giving an indication to the switching system when faults on transmission systems are detected, the switching system should inhibit selection of the circuits concerned for the period the fault conditions persist.

2.10.3 Reset of circuits and circuit groups

In systems which maintain circuit status in memory there may be occasions when the memory becomes mutilated. In such a case the circuits must be reset to the idle condition at both exchanges to make them available for new traffic. Since the exchange with the mutilated memory does not know whether the circuits are idle, busy outgoing, busy incoming, blocked, etc., reset circuit messages or a circuit group reset message should be sent as appropriate for the affected circuits.

2.10.3.1 Reset circuit message

If only a few circuits are concerned a reset circuit message should be sent for each affected circuit.

On receipt of a reset circuit message the receiving (unaffected) exchange will:

- a) if it is the incoming or outgoing exchange on a connection in any state of call set-up or during a call, accept the message as a release message and respond by sending a release complete message, after the circuit has been made idle;
- b) if the circuit is in the idle condition, accept the message as a release message and respond by sending a release complete message;
- c) if it has previously sent a blocking message, or if it is unable to release the circuit as described above, respond by the blocking message. If an incoming or outgoing call is in progress, this call should be released and the circuit returned to the "idle, blocked" state. A release complete message is sent following the blocking message. The blocking message should be acknowledged by the affected exchange. If the acknowledgement is not received, the repetition procedure specified in § 2.10.4 should be followed;
- d) if it has previously received a blocking message, respond by releasing a possible outgoing call or call attempt on the circuit, remove the blocked condition, restore the circuit to the idle state, and respond with a release complete message;
- e) if the message is received after the sending of an initial address message but before receipt of a backward message relating to that call, clear the circuit and make an automatic repeat attempt on another circuit if appropriate;
- f) if the message is received after having sent a reset circuit message, respond by a release complete message. The circuit should be restored to the idle state;

- g) clear any interconnected circuits by the appropriate method (e.g. release).

The affected exchange will then reconstruct its memory according to the received response(s) to the reset circuit and respond to the message(s) in the normal way, i.e. blocking acknowledgement message in response to a blocking message.

If no release complete message is received in acknowledgement to the reset circuit message before 4-15 seconds, the reset circuit message should be repeated. If an acknowledgement for the message is not received within 1 minute after the initial reset circuit message, the maintenance system should be notified. However, the sending of the reset circuit message should continue at 1 minute intervals until maintenance intervention occurs.

2.10.3.2 *Circuit group reset message*

If a considerable number of circuits or all circuits are affected by a memory mutilation, (a) circuit group reset message(s) should be used to make them available for new traffic.

The maximum number of circuits to be reset with a circuit group reset message is limited to 32.

On receipt of a circuit group reset message the receiving (unaffected) exchange will:

- a) restore the circuits to the idle state;
- b) send the appropriate circuit group blocking message(s) if it had previously sent a hardware failure oriented circuit group blocking message;
- c) respond by a circuit group reset acknowledgement message in which the status indicator bits of the circuits available for service or blocked for reasons of hardware failure are coded 0 and the status indicator bits of all circuits blocked for maintenance reasons are set to 1;
- d) if it had previously received (a) blocking message(s) or (a) circuit group blocking message(s) for one or more of the circuit(s) involved, the blocked condition will be removed and the circuits will be made available for service;
- e) if a circuit group reset message is received concerning circuits for which a circuit group reset message or reset circuit message(s) have been sent the circuits concerned are made available for service after receipt of the appropriate acknowledgement message;
- f) appropriate messages should be sent on interconnected circuits to release them.

The affected exchange will then reconstruct its memory according to the possibly received circuit group blocking messages and the received circuit group reset acknowledgement message. It will respond to the possibly received circuit group blocking messages in the normal way.

If no acknowledgement to a circuit group reset message is received before 4-15 seconds the circuit group reset message should be repeated. If an acknowledgement for the circuit group reset message is not received within 1 minute after sending the initial circuit group reset message the maintenance system should be notified. However, the sending of the circuit group reset message should continue at 1 minute intervals until maintenance intervention occurs.

A correct acknowledgement should match the original circuit group reset message in range and circuit identification code indicated in the routing label. The circuit identification code in the routing label of both circuit group reset messages and circuit group reset acknowledgement messages should belong to a circuit whose control is allocated to the ISDN-UP.

All circuit identification codes in the range of a circuit group reset and circuit group reset acknowledgement message must belong to circuits whose control is allocated to the ISDN-UP.

2.10.3.3 *Abnormal circuit group reset message procedures*

- i) If a circuit group reset message is received indicating reset of more circuits than allowed by the receiving exchange, it is discarded.
- ii) If a circuit group reset acknowledgement message is received which is not a correct response to a sent circuit group reset message, it is discarded.
- iii) If a circuit group reset message is received requesting reset of circuits that are not controlled by the ISDN user part, or a circuit group reset acknowledgement message that contains circuit identification codes that are not controlled by the ISDN-UP, the message is discarded.

2.10.4 *Failure in the blocking/unblocking sequence*

An exchange will repeat the blocking (unblocking) message or the circuit group blocking (unblocking) message on failure to receive the appropriate acknowledgement in response to one of these messages before 4-15 seconds (T_{12}). (See § 2.9.2).

If the appropriate acknowledgement is not received within a period of one minute (T_{20}) after sending the initial blocking (unblocking) message or group blocking (unblocking) message, the maintenance system should be alerted, the repetition of the blocking (unblocking) message or circuit group blocking (unblocking) message should be continued at one minute intervals until maintenance intervention occurs and the circuit(s) taken out of (returned to) service as appropriate.

2.10.5 *Receipt of unreasonable and unrecognized signalling information messages*

The message transfer part of the signalling system will avoid missequencing, or double delivery, of messages with a high reliability (Recommendation Q.706, § 2). However, undetected errors at the signalling link level and exchange malfunctions may produce signalling information messages that are either ambiguous or inappropriate.

The procedures listed below do not include the procedures for the blocking, circuit group blocking and the circuit group reset; these are covered in §§ 2.9.2.3 and 2.10.3.3 respectively.

2.10.5.1 *Handling of unexpected messages*

An unexpected message is one which is recognized and valid but has been received in the wrong phase of the call.

In order to resolve possible ambiguities in the state of a circuit when unexpected messages are received the following will apply:

- a) if a release message is received relating to an idle circuit it will be acknowledged with a release complete message;
- b) if a release complete message is received relating to an idle circuit it will be discarded;
- c) if a release complete message is received relating to a busy circuit for which a release message has not been sent, the circuit will be released and a release message will be sent (the possibility of maintaining the connection is for further study);
- d) if other unreasonable signalling information is received, the following actions will be undertaken:
 - if the circuit is idle, the reset circuit message is sent;
 - if the circuit has been seized by a call, after receipt of a backward message required for the call set-up, the unreasonable signalling information is discarded;
 - if the circuit has been seized by a call, before receipt of a backward message required for the call set-up, the reset circuit message is sent. If the circuit is seized by an incoming call, the call will be released. If the circuit is seized by an outgoing call, an automatic repeat attempt is provided on another circuit;
- e) if unreasonable signalling information caused by conflicting code point values in the protocol control indicator as specified in Recommendation Q.763 is received in a backwards call set-up message, and if the conflicting conditions can be reconciled by assuming lower network capability in the affected parameter, the call should be allowed to continue if the service requirements for the call can be satisfied.

Except in certain cases (see § 2.10.1) any other unexpected messages received will be discarded. If the discarding of the signalling information prevents a call from being completed, that call will eventually be released by the expiry of a time out.

2.10.5.2 *General requirements on receipt of unrecognized signalling information messages and parameters*

Normally an exchange knows the signalling system or version of a signalling system to be used to its adjacent exchanges. However, in certain circumstances (e.g. upgrading of a signalling system in the network) it may happen that an exchange receives unrecognized information, i.e. messages or parameters or parameter values. No distinction is being made between unrecognized and unimplemented functions.

The procedure to be used on receipt of unrecognized information, may use one of the following messages:

- confusion,
- release,
- release complete,
- facility reject.

It should be noted that the use of the confusion message is mainly to facilitate interworking with subsequent issues of the ISDN user part protocol. In these cases the message will include one of the following cause values with a diagnostic field containing either the unrecognized message type code or the unrecognized parameter name code (this information will be returned as soon as possible):

- unrecognized message,
- unrecognized parameter passed on (see Note),
- unrecognized parameter discarded (see Note).

Note – In a confusion message these parameters are always followed by the parameter name code in the diagnostic field.

The procedures are based on the following assumptions:

- Signalling for a facility completely provided between the originating and destination local exchanges will utilise one of the end-to-end methods defined in § 3, i.e. such facilities do not have to be supported by transit exchanges.
- As a minimum, all implementations must recognize all messages specified in Table 1/Q.764.
- If an exchange receives a confusion, release, release complete or facility reject message indicating an unrecognized message parameter or parameter value received it assumes interworking with an exchange at a different functional level.
- Unrecognized parameters only refer to optional parameters since mandatory parameters will always be recognized by their location in a message.

Action taken on receipt of these messages, will depend on the call state and the affected service. The default action taken on receipt of a confusion message is to discard the message without disrupting normal call processing. In addition, if the cause received indicates discarded information and that information is important, the call may be released with a release message with the cause “normal, unspecified”.

The actions taken at an intermediate node, e.g. transit exchange on receipt of a confusion message will be dependent on the call state.

If an intermediate node, e.g. transit exchange, does not have the capability to take action on receipt of a facility reject message, it should pass the message transparently to the preceding or succeeding exchange.

Action taken on receipt of a release complete message with cause indicating unrecognized information may be as for the normal procedures.

TABLE 1/Q.764

Minimum messages recognized

Address complete
Answer
Blocking
Blocking acknowledgement
Call progress
Circuit group blocking
Circuit group blocking acknowledgement
Circuit group reset
Circuit group reset acknowledgement
Circuit group unblocking
Circuit group unblocking acknowledgement
Connect
Continuity
Confusion
Facility reject
Facility request
Forward transfer
Information
Information request
Initial address
Release
Release complete
Reset circuit
Resume
Subsequent address
Suspend
Unblocking
Unblocking acknowledgement

2.10.5.3 *Procedures for the handling of the unrecognized messages or parameters*

A confusion message must not be sent in response to a received confusion message.

a) *Unrecognized messages*

If an unrecognized message is received at an exchange, the message is discarded and a confusion message returned. The confusion message will include the cause value “unrecognized message” followed by a diagnostic field containing the message type code.

Note – All messages not included in Table 1/Q.764 may be regarded as unrecognized. As a minimum all implementations must recognize all messages specified in Table 1/Q.764.

b) *Unrecognized parameters*

If an exchange receives and detects an unrecognized parameter the actions taken will be dependent on whether the call can be progressed or not.

If the call cannot be processed a release message is sent containing the cause “unrecognized parameter discarded” followed by the parameter name code in the diagnostic field.

If the call can be progressed, the call is processed and the message is sent to the succeeding/preceding exchange. The unrecognized parameter may be either passed on or discarded.

If the unrecognized parameter is discarded a confusion message is sent to the exchange from which the unrecognized parameter was received. The confusion message contains the cause “unrecognized parameter discarded”.

If the unrecognized parameter is passed on, a confusion message may be sent to the exchange from which the unrecognized parameter was received.

If a facility request message is received with unrecognized parameters the message is discarded and a facility reject message is returned including the cause “unrecognized parameter discarded” followed by the parameter name code in the diagnostic field.

If a release message is received with an unrecognized parameter, a release complete message is returned including the cause “unrecognized parameter passed on” followed by the parameter name code in the diagnostic field.

c) *Unrecognized parameter values*

If an exchange receives and detects a recognized parameter but the contents are unrecognized, then the actions taken are as defined below:

i) *Unrecognized mandatory parameter values*

If an exchange receives and detects an unrecognized mandatory parameter value, the actions taken will be dependent on whether the call can be progressed or not.

If the call can be progressed, the unrecognized mandatory parameter value shall be passed on unmodified. A confusion message with the cause “unrecognized parameter passed on” is sent to the exchange from which the unrecognized mandatory parameter value was received.

If the call cannot be progressed or the unrecognized mandatory parameter value cannot be passed unmodified, a release message with the cause “unrecognized parameter discarded” followed by the parameter name in the diagnostic field is returned.

If a facility request message is received with an unrecognized mandatory parameter value(s) the message is discarded and a facility reject message is returned including the cause “unrecognized parameter discarded” followed by the parameter name code in the diagnostic field.

If a release message is received with an unrecognized mandatory parameter value, a release complete message is returned including the cause “unrecognized parameter passed on” followed by the parameter name code in the diagnostic field.

ii) *Unrecognized optional parameter values*

If an exchange receives and detects an unrecognized optional parameter value, the actions taken will be dependent on whether the call can be progressed or not.

If the call can be progressed, the unrecognized optional parameter value may be passed on unmodified or discarded. If the unrecognized optional parameter value has been passed on unmodified, a confusion message with the cause “unrecognized parameter passed on” may be sent to the exchange from which the unrecognized optional parameter value was received. If the unrecognized parameter value has been discarded, a confusion message shall be returned.

If the call cannot be progressed, a release message with the cause “unrecognized parameter discarded” followed by the parameter name in the diagnostic field shall be returned.

If a facility request message is received with an unrecognized optional parameter value(s) the message is discarded and a facility reject message is returned including the clause “unrecognized parameter discarded” followed by the parameter name code in the diagnostic field.

If a release message is received with an unrecognized optional parameter value, a release complete message is returned including the cause “unrecognized parameter passed on” followed by the parameter name code in the diagnostic field.

2.10.6 *Failure to receive a “release complete” message – time T_1 and T_5*

If a release complete message is not received in response to a release message before time (T_1) the exchange will retransmit the release message.

On retransmitting the initial release message, a one minute timer (T_5) is started. If no release complete message is received on the expiry of this timer (T_5), the exchange shall:

- i) send a reset circuit message;
- ii) alert the maintenance system;

- iii) remove the circuit from service;
- iv) continue the sending of the reset circuit message at 1 minute intervals until maintenance action occurs.

2.10.7 *Failure to receive a response to an information request message*

If a response is not received in response to an information request message before timer (T_2) expires, the exchange will release the connection and the maintenance system may be informed.

2.10.8 *Other failure conditions*

2.10.8.1 *Inability to release in response to a release message*

If an exchange is unable to return the circuit to the idle condition in response to a release message, it should immediately remove the circuit from service, alert the maintenance system and send the blocking message.

Upon receipt of the blocking acknowledgement message, the release complete message is sent in acknowledgement of the release message.

2.10.8.2 *Call-failure*

The call-failure indication is sent in a release message (§ 2.2) whenever a call attempt fails and other specific signals do not apply. Reception of the release message at any Signalling System No. 7 exchange will cause the release message to be sent to preceding exchanges. If the signalling does not permit the release message to be sent, the appropriate signal, tone or announcement is sent to preceding exchanges.

2.10.8.3 *Abnormal release conditions*

If the conditions for normal release as covered in § 2.3 are not fulfilled, release will take place under the following conditions:

a) *Outgoing international or national controlling exchange*

The exchange shall:

- release all equipment and the connection on failure to meet the conditions for normal release of address and routing information before 20-30 seconds after sending the latest address message;
- release all equipment and release the connection on failure to receive an answer message within time (T_c) specified in Recommendation Q.118 after the receipt of the address complete message.

b) *Incoming international exchange*

An incoming international exchange shall release all equipment and the connection into the national network and send back a release message in the following cases:

- on failure to receive a continuity message if applicable before 10-15 seconds (T_s) after receipt of the initial address message; or
- on failure to receive a backward signal from a national network (where expected) before 20-30 seconds (T_r) after receipt of the latest address message; or
- on receipt of a release message after an address complete message has been generated.

The procedures for the release message are detailed in § 2.2.2.

c) *Transit exchange*

The exchange shall release all equipment and the connection and send back the release message in the following cases:

- on failure to receive a continuity message if applicable before 10-15 seconds after receipt of the initial address message; or
- on failure to meet the conditions for normal release as covered in § 2.3 before 20-30 seconds after sending the latest address message;

The procedures for the release message are detailed in § 2.2.2.

2.10.8.4 If messages are lost during an end-to-end transfer, appropriate actions will be taken according to the type of end-to-end technique being used.

2.10.8.5 For calls involving the SCCP, expiration of the call supervision timer (concerned with call set-up) will result in the SCCP being notified of an error condition.

2.10.9 *Temporary Trunk Blocking (TTB) (national use)*

TTB is essentially a means of blocking circuits, for a predetermined period, on a route or part of route, to reduce traffic to an exchange which has invoked load control. Circuits are removed from service on a per circuit basis under delay time out conditions applied by the unaffected exchange.

2.10.10 *Temporary trunk blocking before release of call (use of a discrete overload message)*

2.10.10.1 *Characteristics*

When load control is invoked IAMs associated with non-priority calls received on the circuits concerned are “backed-off” by return of the overload message in response to the IAM. Release of the circuit is then delayed by the unaffected node for a period, e.g. 2 minutes, after which the circuit is cleared by normal release procedures.

Calls backed-off by overload messages may be processed on alternative routes, if available, by-passing the affected nodes; if not they are released in the backward direction with reason (network) congestion.

Initial address messages marked as priority are not subject to the overload procedure; they are accepted by the affected node and processed as normal.

During the overload time-out period the circuit concerned is not available for traffic from the affected node to the unaffected node.

Recognition of the overload situation does not involve the examination of existing messages for detection of an optional TTB parameter.

2.10.10.2 *Procedures*

a) *Non priority call set-up to an exchange subject to load control*

i) *Actions at originating exchange*

In an originating exchange, calls originating from non-priority class lines will not set the calling party category parameter field to “subscriber with priority” in the outgoing IAM.

ii) *Actions at an intermediate or terminating exchange*

When an IAM is received by an exchange which is subject to load control and the calling party category parameter does not indicate a priority call the IAM is not processed and an overload message is returned to the preceding exchange.

iii) *Actions on receipt of the overload message*

At an originating, or intermediate exchange receipt of the overload message shall cause the following actions:

- A timer (T overload) is started, provisional value 2 minutes. On expiry of the timer the release procedure shall be initiated of the circuit concerned.
- The call attempt will be continued on an alternative route if available. If not the call will be released in the backward direction with cause “congestion”.

b) *Priority call set-up to an exchange subject to load control*

i) *Actions at originating exchange*

In an originating exchange, calls originating from priority class lines will set the calling party category parameter field to “subscriber with priority” in the outgoing IAM.

ii) *Actions at intermediate or terminating exchange*

At an intermediate or terminating exchange where load control has been invoked, the priority call will override the load control and the call will continue in its attempt to be set up.

2.11 *ISDN user part signalling congestion control*

2.11.1 *General*

On receipt of congestion indication primitives (see also Recommendation Q.704 § 11.2.3) the ISDN user part should reduce traffic load (e.g. call attempts) into the affected direction in several steps.

2.11.2 *Procedures*

When the first congestion indication primitive is received by the ISDN user part, the traffic load into the affected direction is reduced by one step. At the same time two timers T₂₉ and T₃₀ are started. During T₂₉ all received congestion indication primitives for the same direction are ignored in order not to reduce traffic too rapidly. Reception of

a congestion indication primitive after the expiry of T_{29} , but still during T_{30} , will decrease the traffic load by one more step and restart T_{29} and T_{30} . This stepwise reduction of the ISDN user part signalling traffic is continued until maximum reduction is obtained by arriving at the last step. If T_{30} expires (i.e. no congestion indication primitives having been received during the T_{30} period) traffic will be increased by one step and T_{30} will be restarted unless full traffic load has been resumed.

Timers T_{29} and T_{30} have the following values:

$T_{29} = 300\text{-}600$ ms,

$T_{30} = 5\text{-}10$ s.

The number of steps of traffic reduction and the type and/or amount of increase/decrease of traffic load at the various steps are considered to be an implementation matter.

2.12 *Automatic congestion control*

Automatic Congestion Control (ACC) is used when an exchange is in an overload condition (see also Recommendation Q.542). Two levels of congestion are distinguished, a less severe congestion threshold (congestion level 1) and a more severe congestion threshold (congestion level 2).

If either of the two congestion thresholds are reached, an automatic congestion level parameter is added to all release messages generated by the exchange. This parameter indicates the level of congestion (congestion level 1 or 2) to the adjacent exchanges. The adjacent exchanges, when receiving a release message containing an automatic congestion level parameter should reduce their traffic to the overload affected exchange.

If the overloaded exchange returns to a normal traffic load it will cease including automatic congestion level parameters in release messages.

The adjacent exchanges then, after a predetermined time, automatically return to their normal status.

2.12.1 *Receipt of a release message containing an automatic congestion level parameter*

When an exchange receives a release message containing an automatic congestion level parameter the ISDN user part should pass the appropriate information to the signalling system independent network management/overload control function within the exchange. This information consists of the received congestion level information and the circuit identification to which the release message applies.

ACC actions are applicable only at exchanges adjacent to the congested exchange. Therefore, an exchange that receives a release message containing an automatic congestion level parameter should discard that parameter after notifying the network management/overload control function.

2.12.2 *Actions taken during overload*

Whenever an exchange is in an overload state (congestion level 1 or 2), the signalling system independent network management/overload control function will direct the ISDN user part to include an automatic congestion level parameter in every release message transmitted by the exchange.

The network management/overload control function will indicate which congestion level (1 or 2) to code in the automatic congestion level parameter.

When the overload condition has ended the network management/overload control function will direct the ISDN user part to cease including automatic congestion level parameters in the transmitted release messages.

2.13 *Unequipped circuit identification code message (national option)*

An Unequipped Circuit Identification Code (UCIC) message is sent by an exchange in response to either the reception of an IAM, a CCR, a circuit supervision message, or a circuit group supervision message on which it is unable to act as a consequence of its inability to perform a circuit identification code translation. The sending of the UCIC in response to the reception of other messages with UCIC is for further study.

If an unequipped circuit identification code message is received for an SS No. 7 circuit which has been seized and an initial address message transmitted, the receiving exchange shall:

- 1) remove the indicated circuit from the service and report the circuit to the maintenance system for maintenance action;
- 2) re-attempt the call on another circuit providing the rejected attempt was a first attempt. If the rejected attempt was a second attempt, either a release message should be returned, (if the incoming circuit is an SS No. 7) or a recorded announcement connected (if the incoming circuit is conventional).

If an unequipped circuit identification code message is received in response to the transmission of a circuit supervision message, or a continuity check request message, the circuit should be removed from the service and the circuit reported to the maintenance system for maintenance action.

An exchange receiving a circuit group supervision message whose CIC in the routing label is unequipped should respond with a UCIC message for the circuit in the label. This in effect is the acknowledgement to the initial message. An exchange receiving a circuit group message where CIC in the routing label is equipped but one or more of the indicated circuits by the range field is unequipped merely responds in the manner that it would have if the circuit were equipped. The unequipped state of the circuit(s) will be recovered when an IAM, a CCR message, or circuit query message is received for the affected circuit(s).

An exchange receiving an unequipped CIC message after having transmitted a circuit group supervision message removes the indicated circuit from service, assumes the regular acknowledgement message will not be received and treats the other circuits as though the responding exchange had not taken the action on the affected circuits indicated in the initial message.

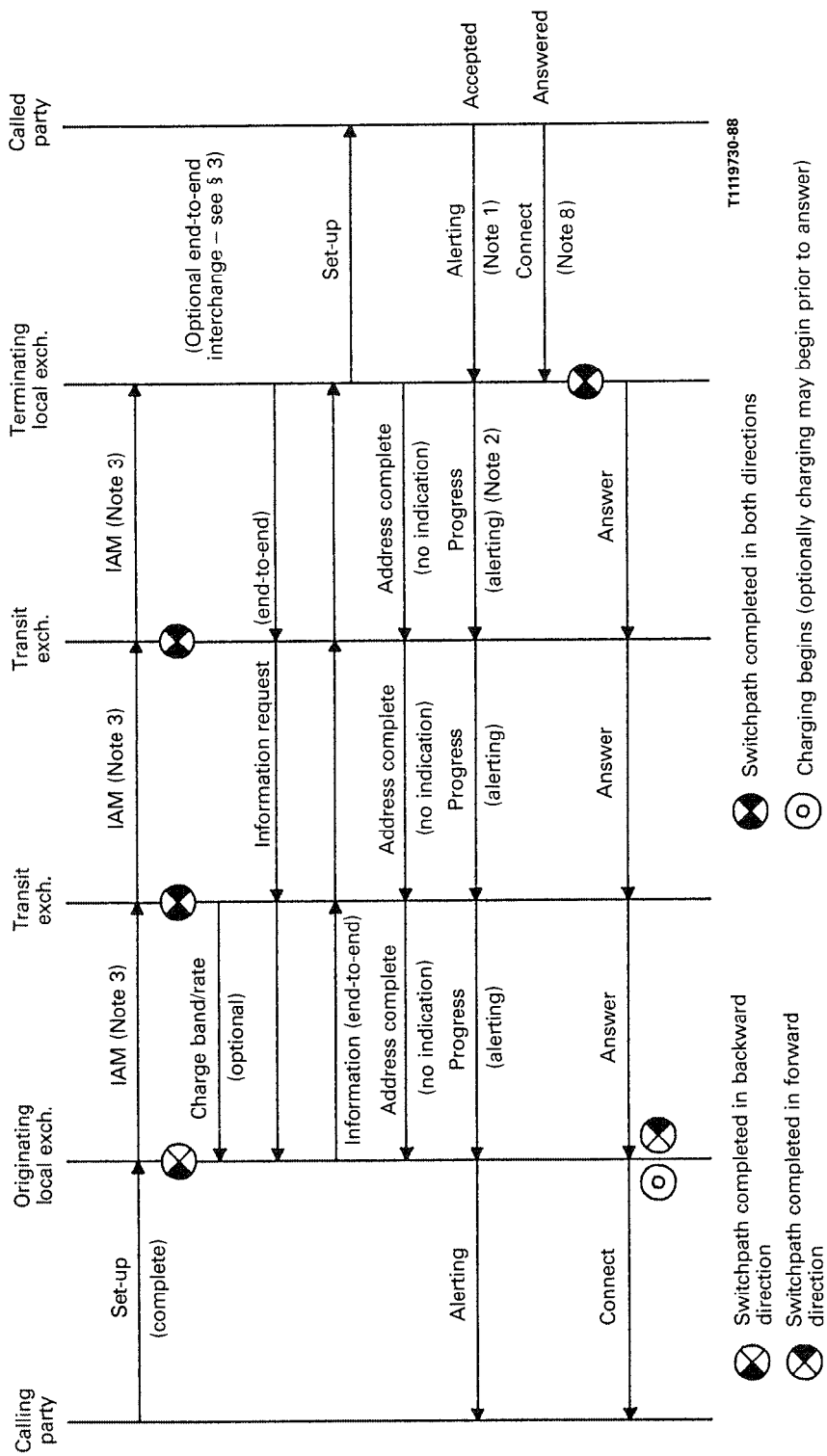

Note - For explanation of notes, see at the end of Figure 3/Q.764.

FIGURE 1/Q.764

Successful ordinary call (en block operation)

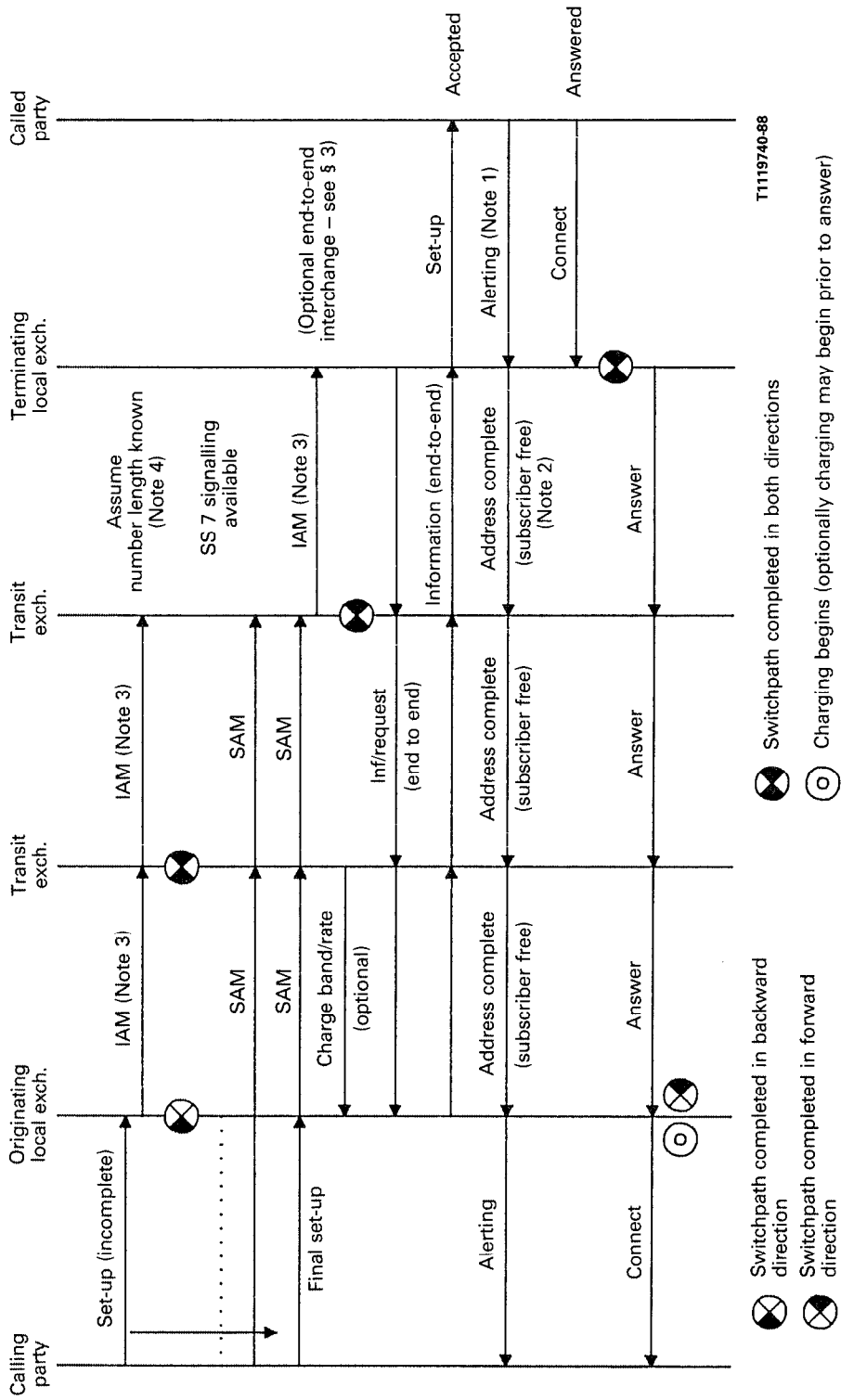

Note - For explanation of notes, see at the end of Figure 3/Q.764.

FIGURE 2/Q.764

Successful ordinary call (overlap operation)

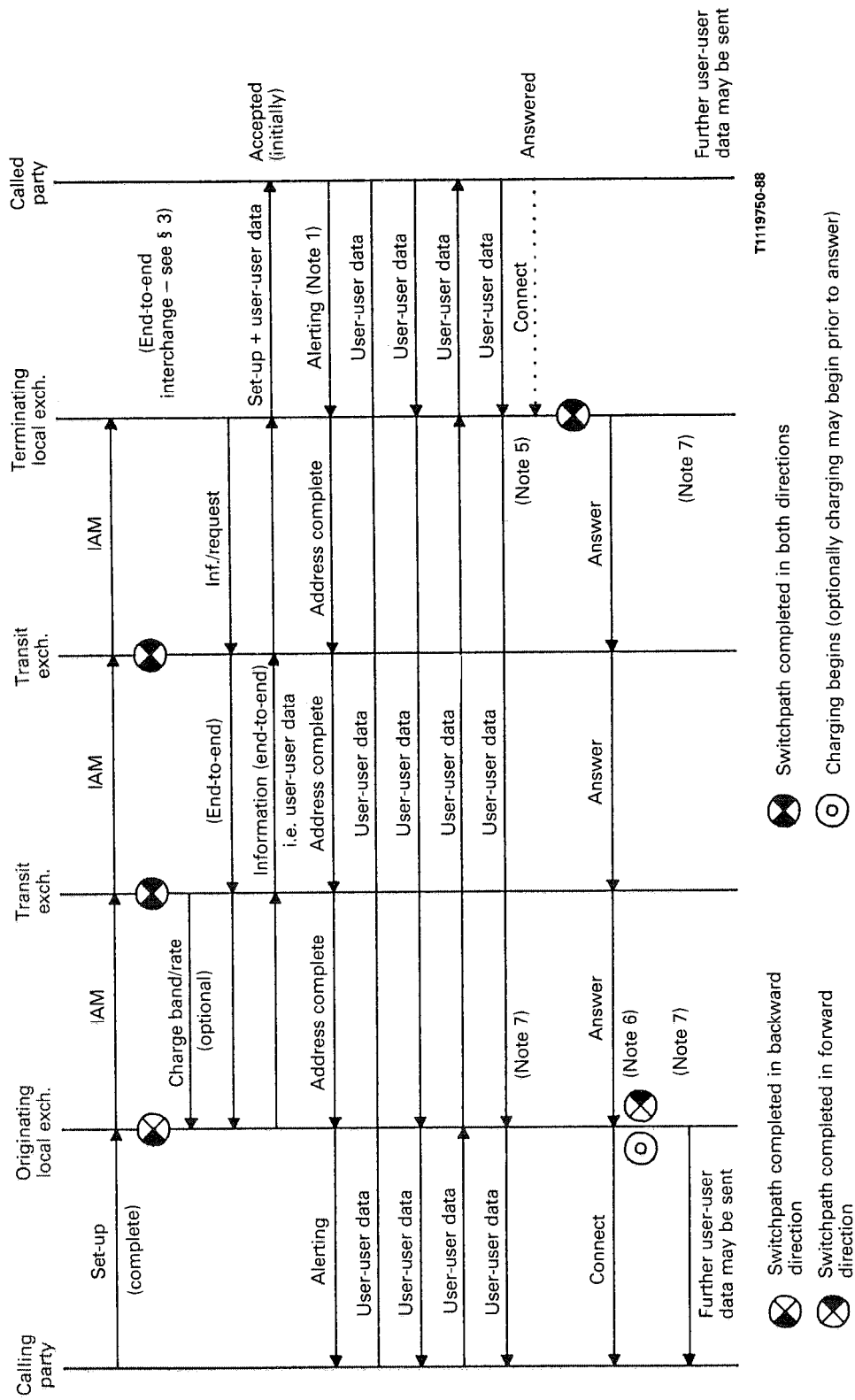

FIGURE 3/Q.764

Transfer of user-user data on call set-up

Notes referring to Figures 1/Q.764 to 3/Q.764

Note 1 – The alerting message may not be given by a called terminal having automatic answer. Under these circumstances the Connect Message will be sent as soon as the Connect Message is received and through-connection of the speech path has been completed.

Note 2 – For telephone calls within the ISDN, ringing tone will be applied by the terminating exchange as soon as it is known that the subscriber is free. In the case of a PABX connected to the access interface there is the option of an early through-connection of the switchpath so that the in-band call arrival indication generated in the PABX is returned to the calling user. For data calls, ringing tone is not applied.

Note 3 – The continuity check may be applicable on an intermediate circuit if analogue circuits are used.

Note 4 – This example assumes that the number length is known at the second transit exchange in order to illustrate the addition of SAMs to the IAM received. This function does not have to be performed in this way.

Note 5 – The call may be rejected by the user at this point following interchanges of user-user data, e.g. as a result of a failed compatibility check.

Note 6 – Charging for the transfer of user-user data requires further study.

Note 7 – Flow control of user-user data is achieved by the originating and destination exchanges by the use of “receive ready” and “receive not ready” messages throughout the conversation/data phase.

Note 8 – Access protocol example is for point-to-point operation only.

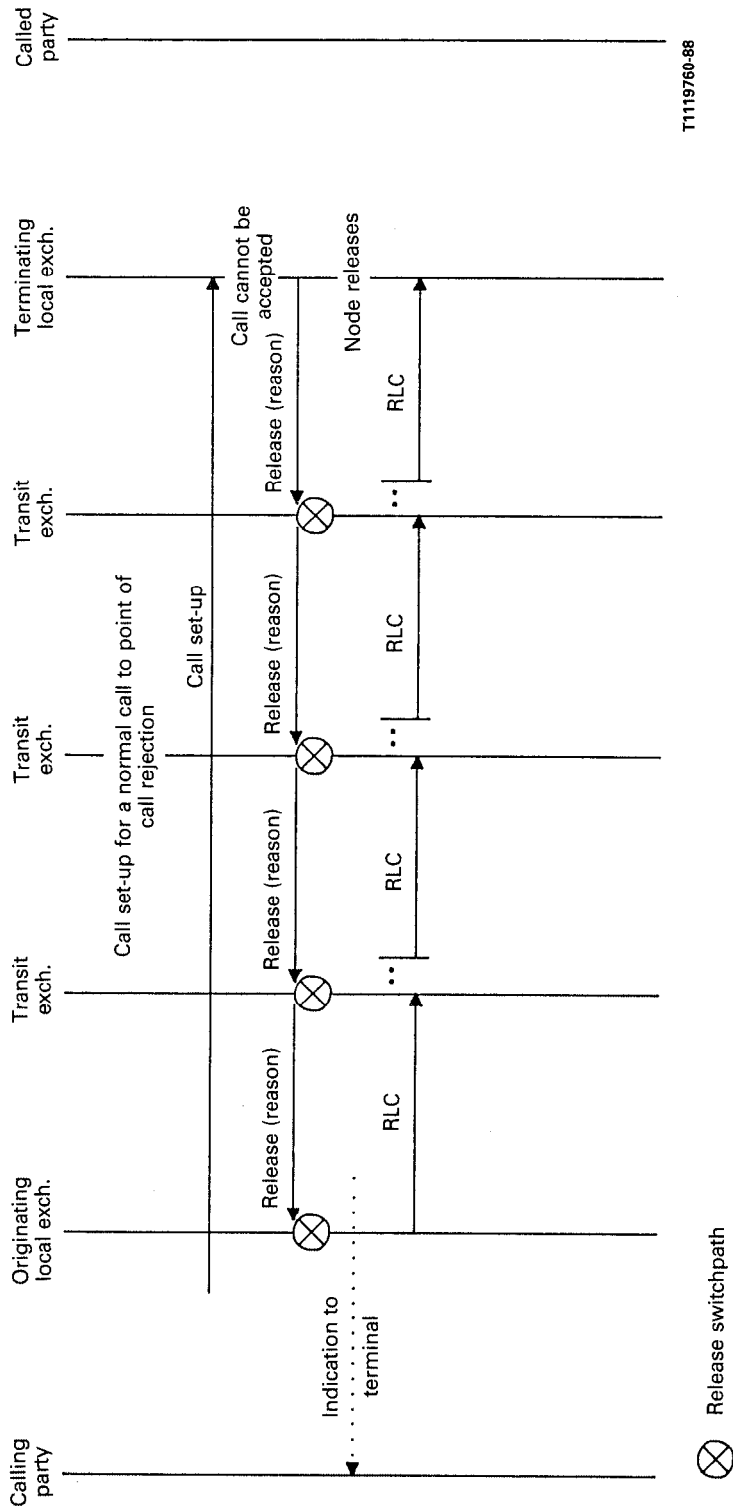

T1119760-88

FIGURE 4/Q.764

Unsuccessful call set-up - no rerouting

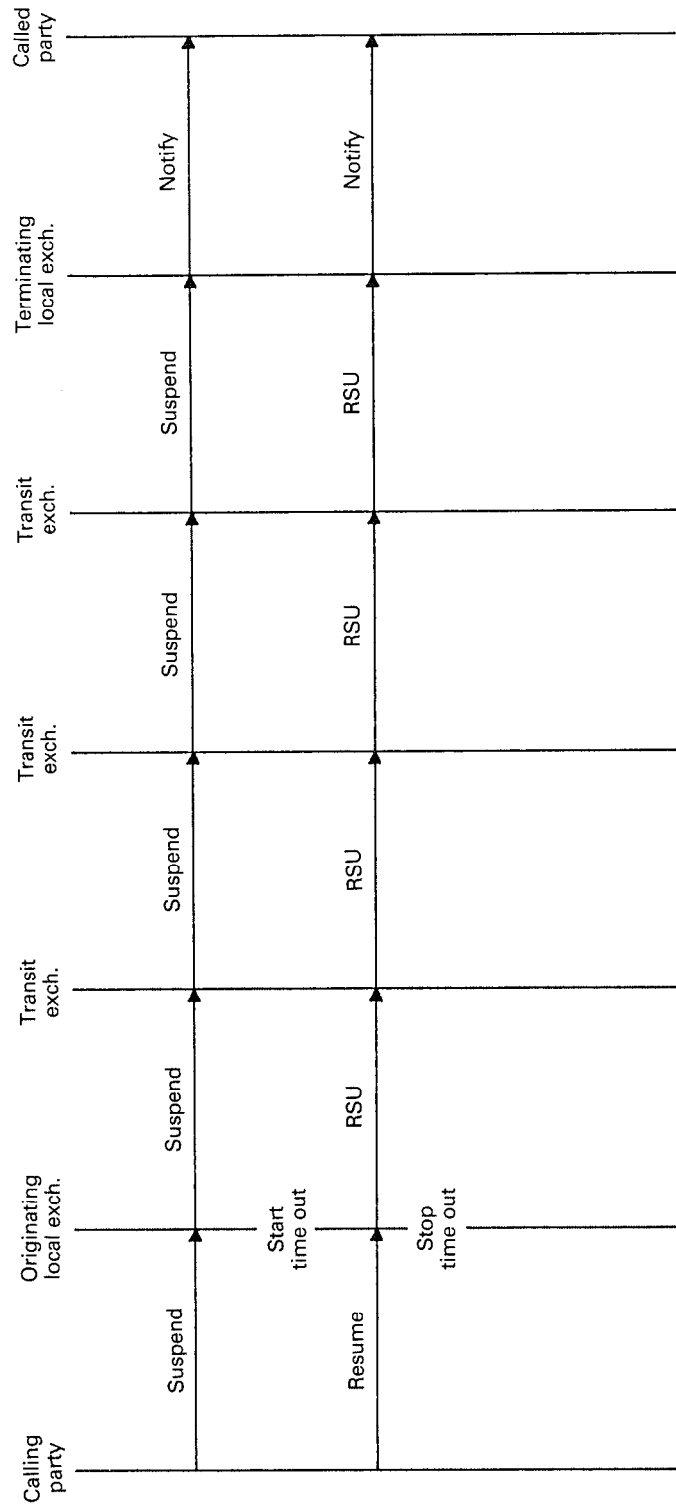

T1119770-88

FIGURE 5/Q.764

Suspend request and resume

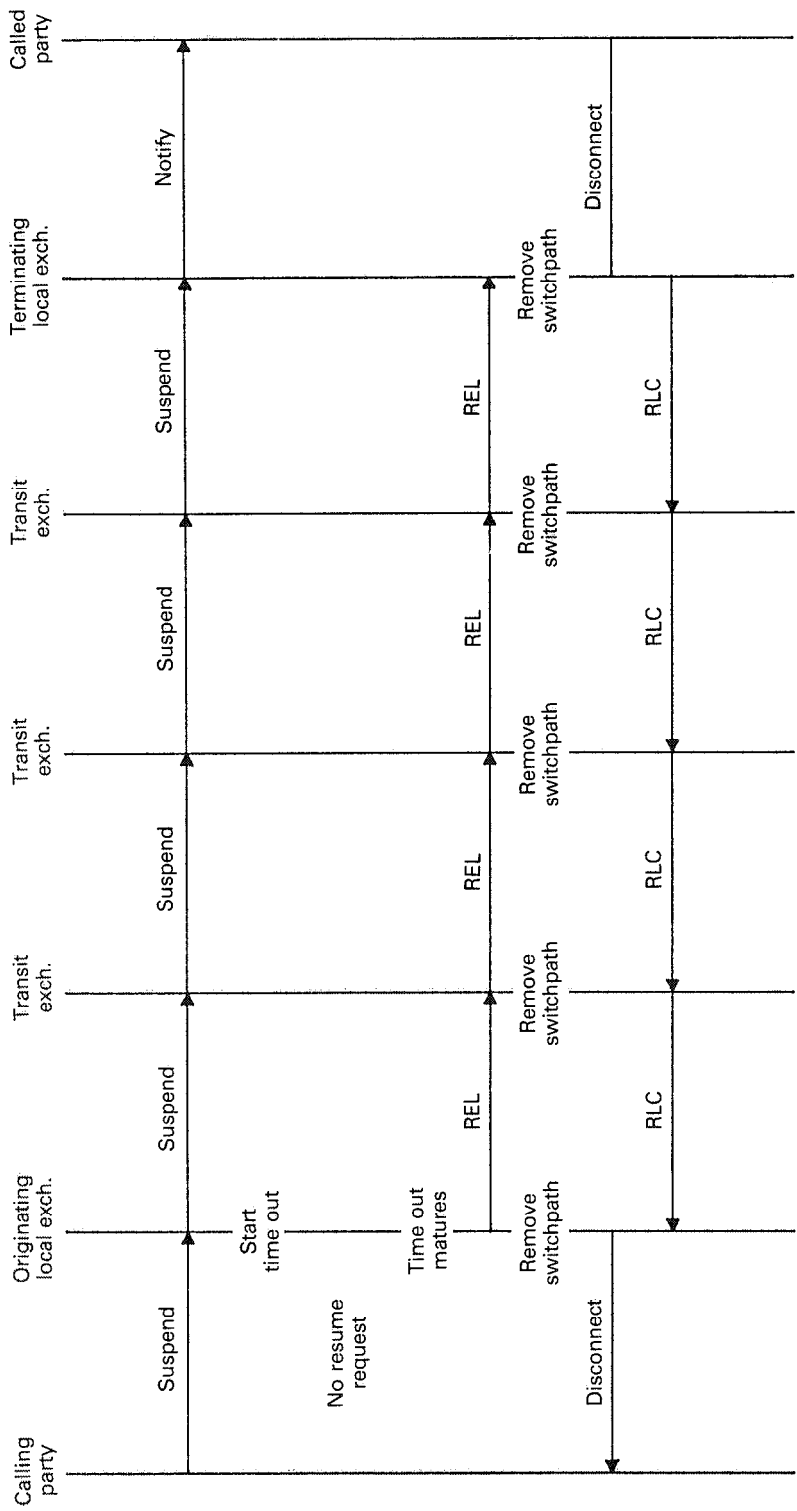

T1119780-88

FIGURE 6/Q.764

Suspend request with no connection

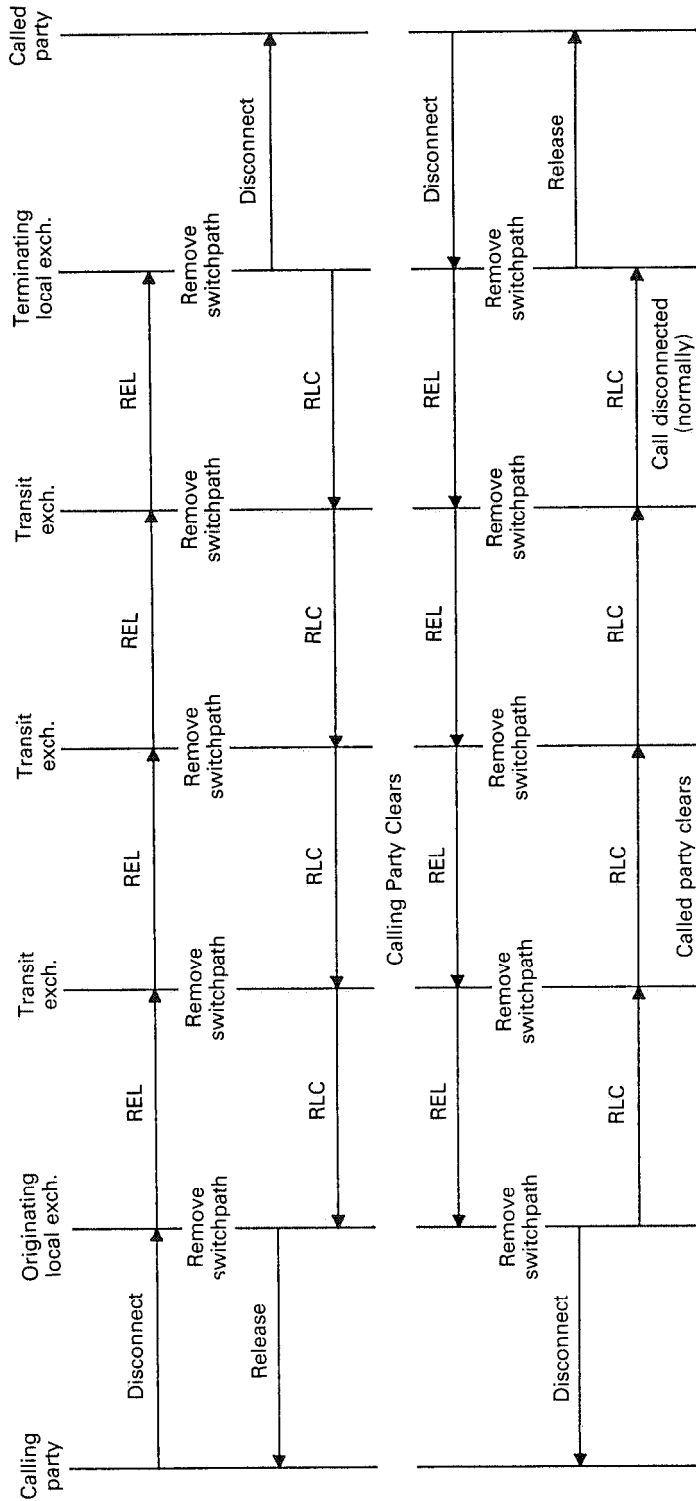

T1119790-88

FIGURE 7/Q.764

Normal call release

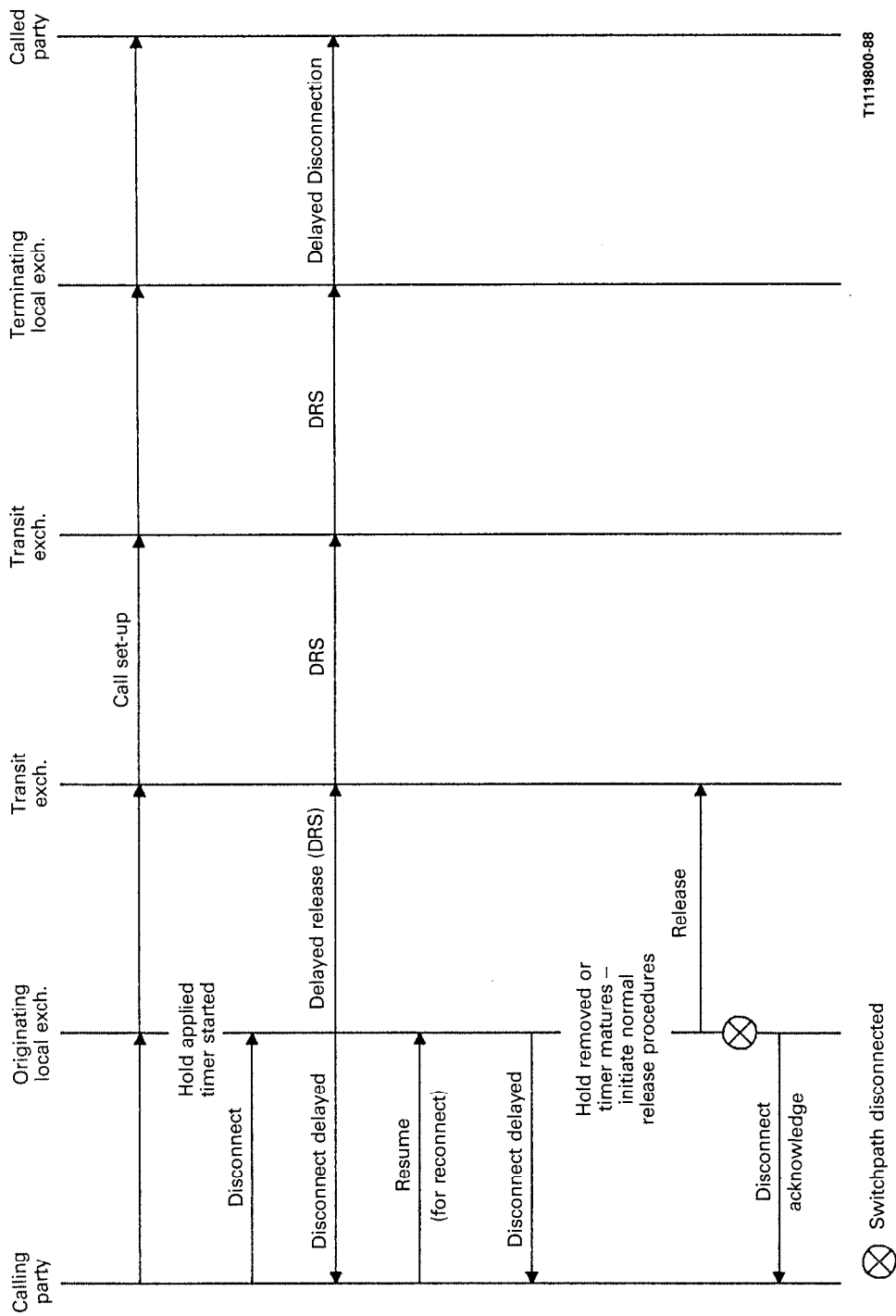

TI119800-88

FIGURE 8/Q.764

Delayed release

⊗ Switchpath disconnected

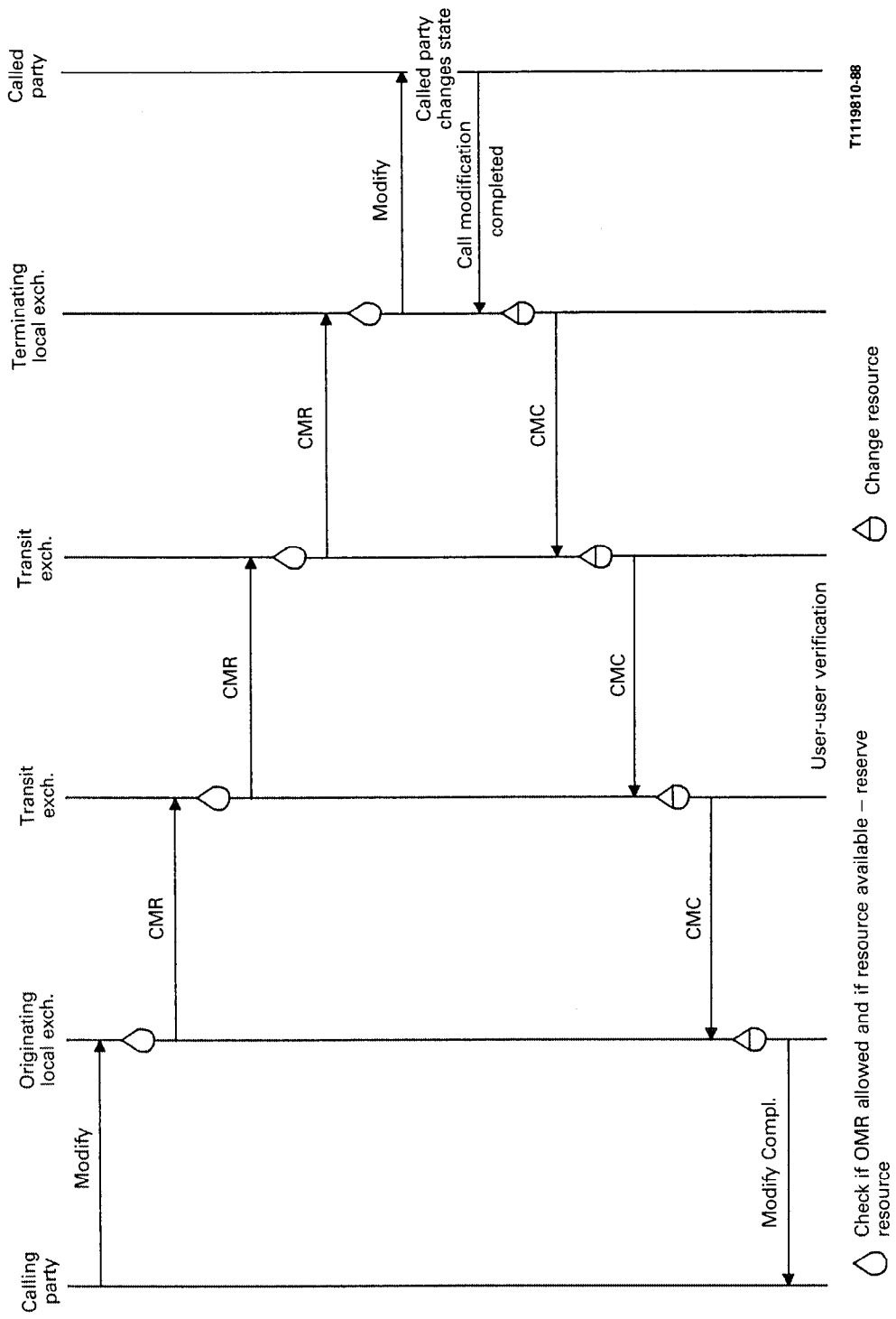

FIGURE 9/Q.764

In-call modification – successful

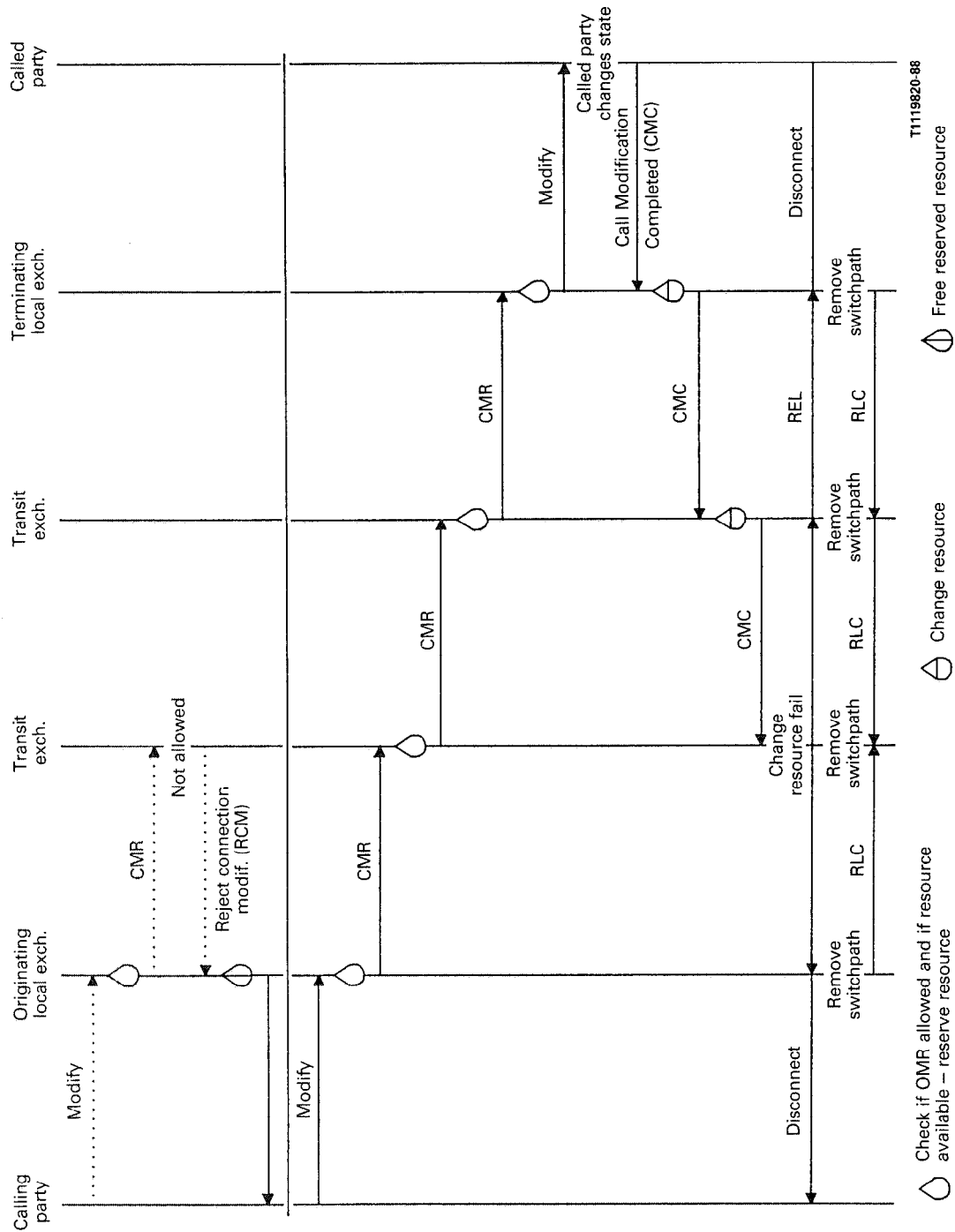

FIGURE 10/Q.764

In-call modification - not allowed and failed

3 End-to-end signalling

3.1 Introduction

End-to-end messages contain only information which is relevant for the “endpoints” of a circuit-switched connection. Endpoints are signalling points such as local exchanges and possibly exchanges at network boundaries, e.g. international gateway exchanges within the Signalling System No. 7 network.

Two methods are available for ISDN end-to-end signalling:

- the pass-along method; and
- the signalling connection control part (SCCP) method.

The choice of method is, to some extent, dependent on the size and architecture of the signalling network. Both methods may coexist in a given network.

The pass-along method and the SCCP method are specified for circuit-switched connections.

An end-to-end signalling connection established for end-to-end signalling is called an “ISDN user part end-to-end signalling connection” in this section.

§ 1.5 discusses the use of the end-to-end and link-by-link methods.

3.2 Pass-along method

In the pass-along method, use is made of an ISDN user part end-to-end signalling connection which in fact is being set up whenever a physical connection between two endpoints is established.

The ISDN user part end-to-end signalling connection in this case consists of a number of connection sections in tandem which run in parallel with and use the same identification code as the circuits in the physical connection.

The association of incoming and outgoing circuits in a transit exchange also establishes the coupling of the connection sections related to these circuits.

The pass-along method defines, section by section, the appropriate routing label for the message to be passed along via ISDN user part connection; but the content of pass-along messages is only evaluated and possibly changed at the endpoints. The pass-along message group is characterised by a special message type code as specified in Recommendation Q.763. One ISDN user part message to be passed along may be embedded in one pass-along message.

In a signalling connection for which pass-along method is available pass-along messages may be sent in either the forward or backward direction.

A forward pass-along message may not be sent until either a backward pass-along or the first backward set-up message has been received or after the physical connection is released.

Call control path information (see § 3.5) included in the initial address and backward set-up messages is used to indicate to the connection endpoints whether or not the call control path can support pass-along message transfer.

A pass-along message that has been received at a transit exchange and cannot be transferred to the subsequent exchange is discarded without affecting call states and timers in that exchange.

3.3 SCCP method

In the SCCP method the ISDN user part employs the services of the signalling connection control part (SCCP) for the transfer of end-to-end signalling information.

3.3.1 Call reference

The call reference is a circuit independent information identifying a particular call. It is needed when end-to-end signalling information associated with the call is to be transferred by a connectionless SCCP service. If, in turn, an SCCP connection request for connection-oriented SCCP service is carried embedded in an ISDN-UP message, the call reference is omitted.

References for a given call are allocated independently in the two concerned signalling points and are subsequently exchanged. The allocation of call references may be initiated by either side. The call reference consists of a call identity and the point code where the call identity is established. If, e.g. signalling point A initiates the exchange of call references, it selects a call identity CIA and transfers it together with the point code of A, PCA, to signalling point B. Signalling point B then allocates its own identity CIB to the call and returns it together with the signalling point code of B, PCB, to signalling point A. Subsequent call related end-to-end message transferred from signalling point A to signalling point B contain call identity CIB and are routed directly using destination point code PCB. Conversely,

end-to-end messages transferred from signalling point B to signalling point A contain call identity CIA and are routed using destination point code PCA.

A linkage of call references at network boundaries has to be provided.

3.3.2 *Coupling of connection sections*

An ISDN user part end-to-end signalling connection may consist of a number of connection sections in tandem. In order to couple two connection sections at the SCCP relay point, linkage of call references 3 (Ref 3) is performed by ISDN user part for connectionless SCCP service and linkage of local references is performed by SCCP for connection-oriented SCCP service.

An SCCP relay point where linkage of call references is performed by the ISDN user part is called an "intermediate relay node" in this section.

3.3.3 *Connectionless service*

For connectionless service, the ISDN user part transfers the data to be transmitted to the SCCP together with a request for the appropriate protocol class of service. The Ref 3 signalling information, transfer and delivery of this data to the distant ISDN user part is controlled entirely by the SCCP. The association between the transferred information and a call is made by the ISDN user part, which transfers the call reference as part of signalling information for this purpose.

The protocol class of service is assumed to be 0. Individual networks may choose class 1 based on the predetermined arrangement.

3.3.4 *Connection-oriented service*

3.3.4.1 *Connection request embedded in an ISDN user part message*

At the exchange initiating the establishment of an ISDN user part end-to-end signalling connection based on connection-oriented SCCP service, the ISDN user part requests the SCCP to provide the necessary information for a connection request for an SCCP end-to-end connection. This connection request is then carried embedded in an ISDN user part message. At the destination exchange the connection request is passed to the SCCP by the ISDN user part. The SCCP at the destination exchange then behaves as if the connection request had been sent directly by the SCCP from the originating exchange: it indicates the connection request to the ISDN user part and upon response from the ISDN user part it returns a connection confirm message to the SCCP at the originating exchange. The SCCP at the originating exchange confirms the set-up of the end-to-end connection to the ISDN user part. The contents in the embedded connection request is not evaluated by the ISDN user part at any exchange.

3.3.4.2 *Protocol class of service*

The protocol class of service is assumed to be 2. If the connection request is of protocol class 3, the ISDN user part connection request parameter must include explicit protocol class and credit indications in addition to the SCCP source local reference.

3.3.4.3 *Mechanism of coupling*

Although coupling of connection sections may not be appropriate in combination with the embedded method, coupling is necessary at network boundaries. In this case the ISDN user part at the intermediate point has knowledge that a coupling of end-to-end connections sections has to be performed, and therefore connection requests received embedded in an ISDN user part message are passed to the SCCP. The SCCP, in turn, furnishes the ISDN user part with a connection request for the new connection section in order to have it included in the outgoing ISDN user part message.

After the coupling of the connection sections has been successfully initiated by the ISDN user part, end-to-end signalling information passing through an intermediate point is not passed to the ISDN user part.

3.3.4.4 *Release of ISDN user part end-to-end signalling connection*

The SCCP end-to-end connection is released according to the procedures described in the Recommendation Q.714.

The physical connection and the ISDN user part end-to-end signalling connection can be released independently of each other.

Generally, both the ISDN user part end-to-end signalling connection and the physical connection are released simultaneously. However, for certain applications it is possible to maintain the SCCP end-to-end connection although the physical connection has already been released.

3.4 *Chaining of ISDN user part end-to-end signalling connections*

At an exchange where the contents of end-to-end signalling information may need to be evaluated by the ISDN user part, ISDN user part end-to-end signalling connections are chained. Chaining of two ISDN user part end-to-end

signalling connections means that one ISUP signalling connection terminates and another ISUP signalling connection associated with it originates with all end-to-end signalling information passing through the ISDN user part. The new ISUP signalling connection may have different characteristics from the previous one. See Figure 22/Q.764.

If chaining is not appropriate for the associated call when the service requirements cannot be satisfied because of it, the call may be released. In addition, if any of the ISDN user part end-to-end signalling connections under chaining cannot be established or is abnormally disconnected the associated call may be released if the required service cannot be completed without it.

3.5 *Use of the Protocol Control Indicator (PCI)*

The protocol control indicator is control information concerning the end-to-end signalling procedures. It is contained in the forward call indicator and the backward call indicator, respectively, and has to be examined to determine which end-to-end signalling method should be used if any (when an embedded connection request is not included in the appropriate message) for the end-to-end transfer of messages.

The following indications are provided:

- a) available information that could be transmitted (end-to-end) to the other endpoint;
- b) Signalling System No. 7 path between the two endpoints, no interworking along the route;
- c) pass-along method available;
- d) SCCP connection-oriented class available;
- e) SCCP connectionless class available;
- f) ISDN user part used all the way.

3.6 *Operation of the pass-along method*

Figure 11/Q.764 illustrates the operation of the pass-along protocol. In this Figure the PCI is the protocol control indicator in the IAM. "Interworking" in the IAM or ACM indicates that the control path is not wholly Signalling System No. 7.

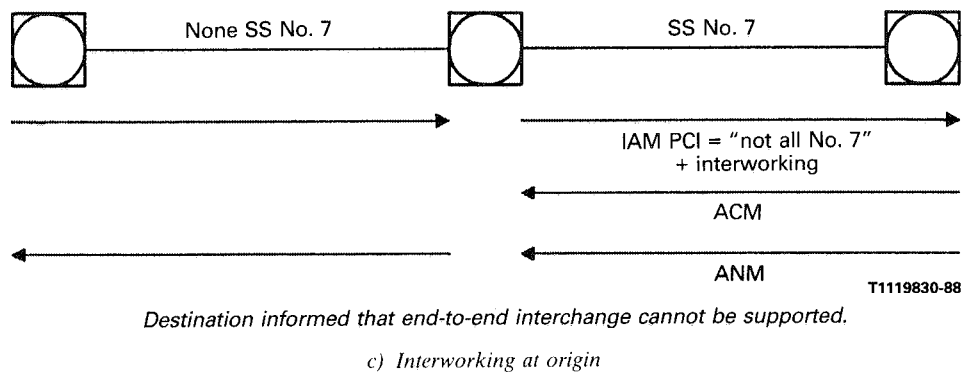
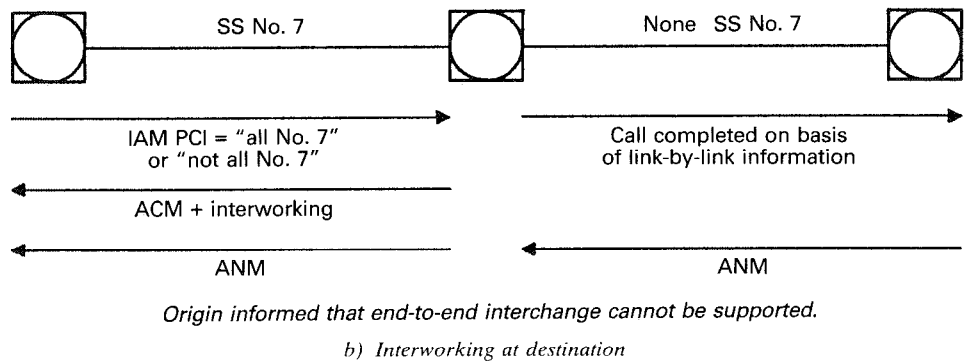
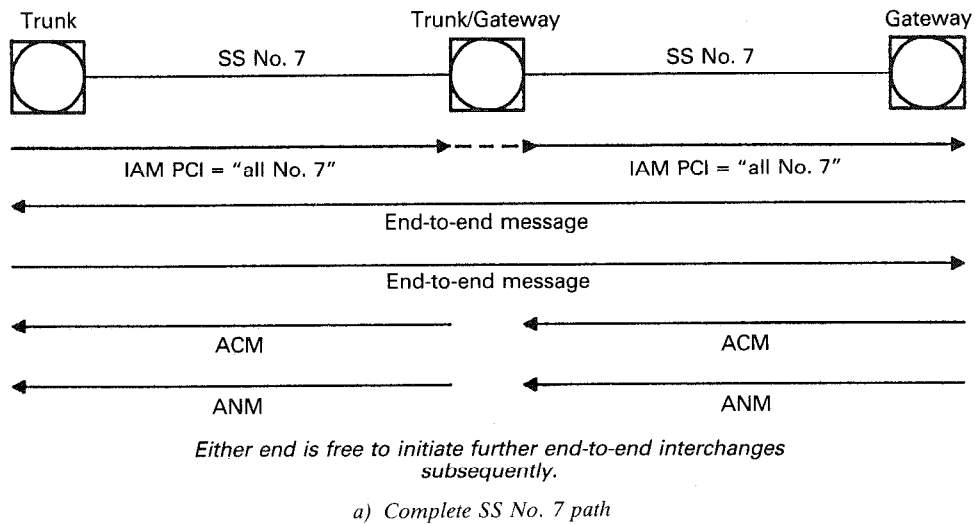

FIGURE 11/Q.764
Operation of end-to-end protocol (pass along method)

3.7 Operation of the SCCP method – connectionless services

3.7.1 Successful set-up of the ISDN user part end-to-end signalling connection

3.7.1.1 Simultaneous establishment of an ISDN user part end-to-end signalling connection and a physical connection

In the case of simultaneous establishment of a signalling connection with a physical connection, the initial address message from the originating exchange of a call contains the call reference consisting of the point code of the originating exchange and the call identity. The inclusion of the call reference implicitly indicates that the establishment of a signalling connection is requested. When the terminating exchange receives an IAM with a call reference in it and a signalling connection can be established, it responds to that with its own call reference included in the first backward message (e.g. an address complete message).

At an intermediate relay node where SCCP is terminated, its own call reference is allocated to the signalling connection and the coupling of call references is made. When the first backward message contains a call reference, an intermediate relay node replaces that with its own call reference and relays this message towards the originating exchange.

When the originating exchange receives the destination call reference from the exchange at the other end of the connection section the signalling connection is regarded as in a ready state and end-to-end signalling information can be transferred over this connection.

Figure 12/Q.764 shows the procedure for this case.

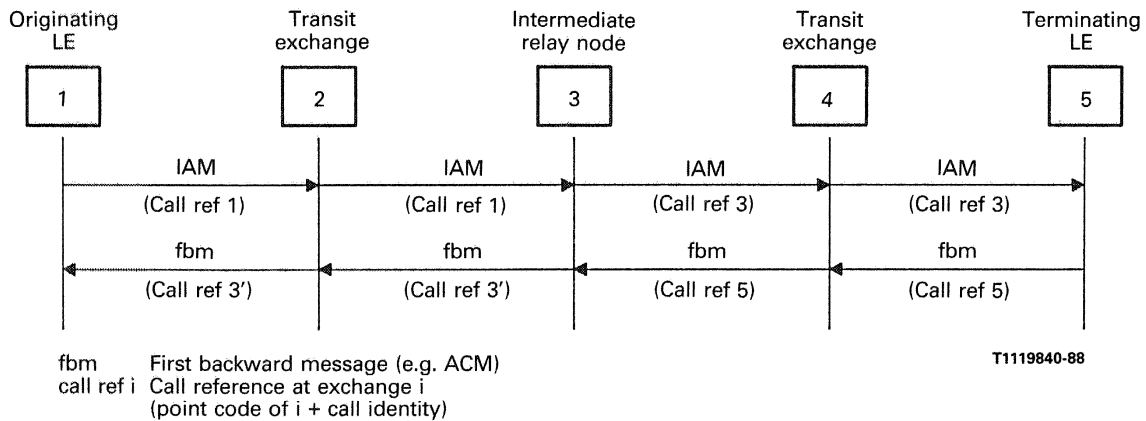

Note – Call ref 3 and call ref 3' may be the same or different.

FIGURE 12/Q.764

Simultaneous establishment of a bearer connection and an ISDN user part end-to-end signalling connection, based on SCCP connectionless class

3.7.1.2 Establishment of a signalling connection when the circuit-associated signalling path has been established

When the circuit-associated signalling path has already been established, the establishment of a signalling connection can be initiated either by the originating or the terminating exchange of a call. In this case, an Information Request message (INR) is transferred from the initiating exchange to the other end. This INR message contains a call reference as in the case of an IAM as described in § 3.6.1.1 above.

An information message (INF) containing a call reference as in the case of the first backward message in § 3.6.1.2 is returned to the initiating exchange and a signalling connection is successfully established.

Figure 13/Q.764 shows the procedure for this case.

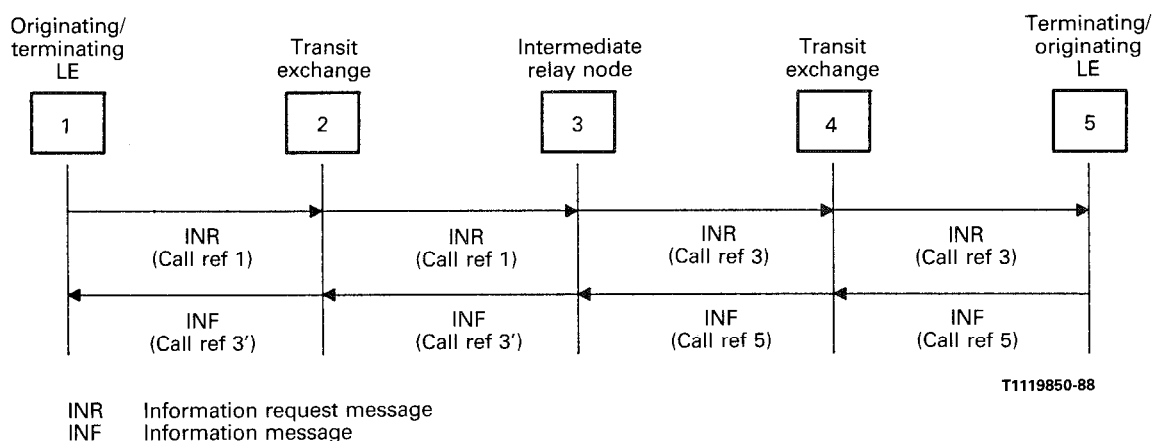

Note – Call ref 3 and call ref 3' may be the same or different.

FIGURE 13/Q.764

**Establishment of an ISDN signalling connection
based on SCCP connectionless class, after the
establishment of a circuit-associated signalling path**

3.7.2 *Unsuccessful set-up of a signalling connection*

In a case where a signalling connection cannot be established, e.g. due to interworking with a PSTN, the first backward message in response to the initial address message containing the originating call reference includes no call reference.

The procedure for this case is shown in Figure 14/Q.764.

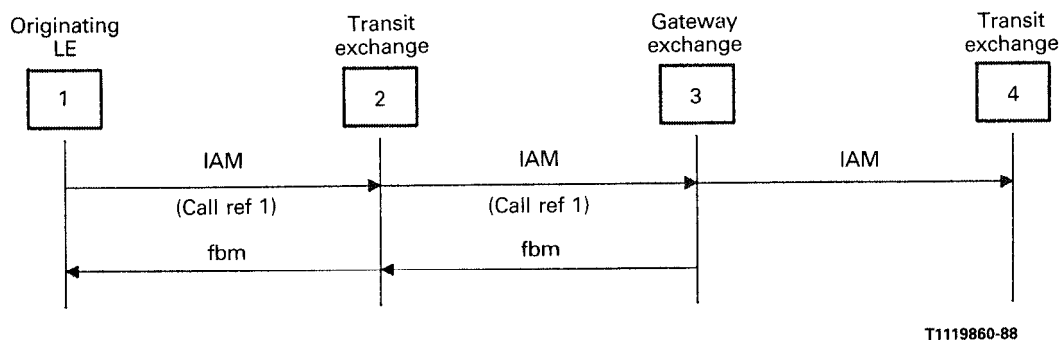

FIGURE 14/Q.764

**Unsuccessful establishment of an ISDN user part
end-to-end signalling connection, SCCP
connectionless class, e.g. due to interworking with a PSTN**

In a case where the establishment for a signalling connection is requested by an INR message as shown in Figure 13/Q.764 the initiating exchange usually knows the end-to-end signalling capability for the call concerned and a signalling connection can successfully be established. However, if a signalling connection cannot be established for some reason, an INF message containing no call reference is returned to the initiating exchange.

In these situations, the call may be released if the ISDN user part end-to-end signalling connection is essential to satisfy the service requirements of the call.

In these cases, the call reference(s) is frozen for the time (T_{31}) as described in § 3.7.4.

3.7.3 *Abnormal situations*

If no response to the INR message containing the originating call reference is received for the time T_{33} at the initiating exchange and if necessary (e.g. in the case of an interworking exchange of different end-to-end signalling schemes) at an intermediate relay node, the call is released (see § 2.9.7).

In this case, the call reference(s) is frozen for the time T_{31} as described in § 3.7.4.

The procedure for this case is shown in Figure 15/Q.764.

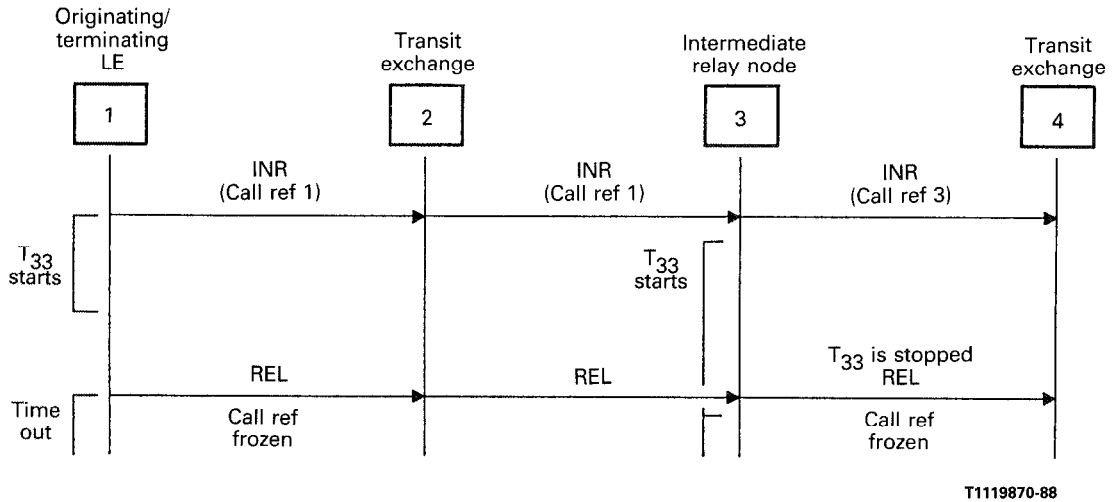

FIGURE 15/Q.764

No response from SCCP after time T_{33} after the transmission of the originating call reference, during the establishment of an ISDN user part end-to-end signalling connection based on SCCP connectionless class

3.7.4 *Release of a signalling connection*

3.7.4.1 *Simultaneous release of a physical connection and a signalling connection*

When the call is released, the ISDN user part end-to-end signalling connection is considered to be released simultaneously. Call references allocated at local exchanges and intermediate relay node(s) are frozen for time T_{31} as described in § 3.7.4.2 below.

The procedure for this case is shown in Figure 16/Q.764.

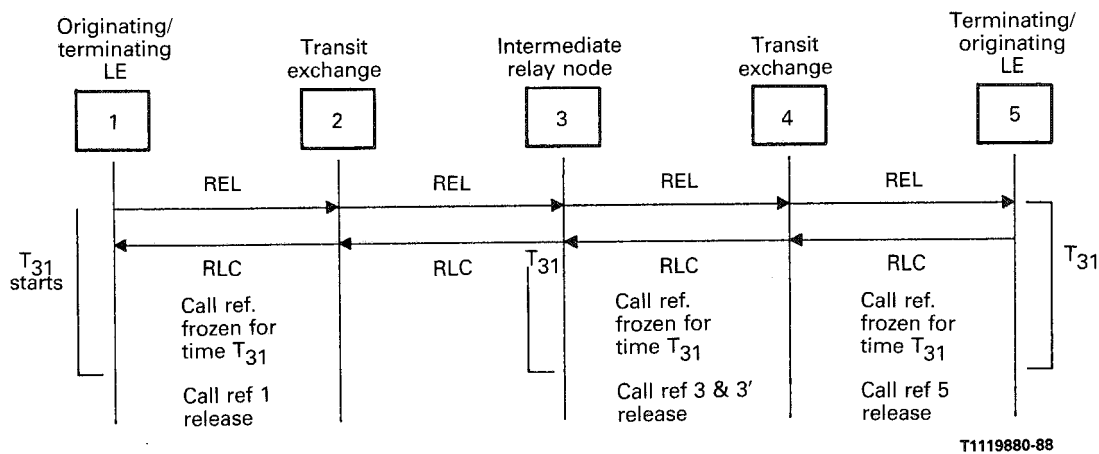

FIGURE 16/Q.764

Simultaneous release of a bearer connection and an ISDN user part end-to-end signalling connection based on SCCP connection class

3.7.4.2 *Frozen call reference*

When an ISDN user part end-to-end signalling connection is released, call references allocated for this signalling connection are frozen for time T_{31} . These references will not be used for another signalling connection during the frozen period. T_{31} is chosen to sufficiently reduce the probability of erroneously associating a message with the previously used call reference. Optionally call identities may be allocated to individual signalling connections in a cyclic manner so that a previously used call identity is not to be used again for sufficient amount of time.

If an end-to-end message containing a frozen call reference is received, it is discarded.

3.7.5 *End-to-end message transfer*

An end-to-end message is transferred in an SCCP unitdata (UDT) message according to the procedures defined in Recommendation Q.714. ISDN user part interfaces with SCCP via the primitives are defined in Recommendation Q.711 for this transfer. The unit-data request/indication primitive includes in its user data parameter an ISDN user part message beginning with the message type and ending with the parameters.

At the local exchange which has responded to the request of establishment of an ISDN user part end-to-end signalling connection from the other local exchange, an end-to-end message cannot be transferred for time T_{32} or until the first end-to-end message has been received from the other end. T_{32} is chosen to sufficiently reduce the probability that an end-to-end message from the responding local exchange is received at the initiating local exchange or the intermediate relay node, before the ISDN user part message which contains the response to the signalling connection establishment request.

If a relay exchange receives an end-to-end message in a UDT, in any case the UDT will be forwarded to the succeeding exchange if possible.

The procedure for this case is shown in Figure 17/Q.764.

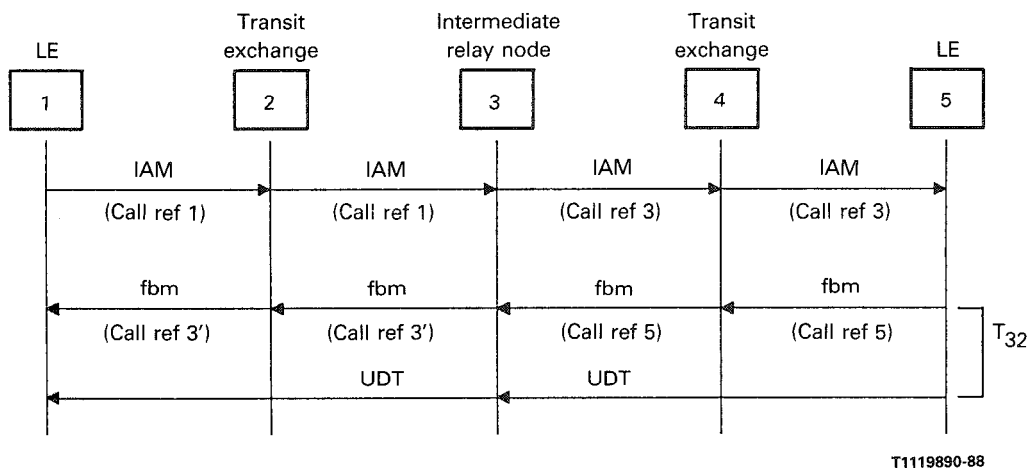

FIGURE 17/Q.764

**Transfer of UDT message from the local exchange
which has responded to the ISUP signalling
connection establishment request**

3.8 *Operation of the SCCP method – connection-oriented service*

The initial address message, the facility request message and the information message may be used for the embedded transfer of the connection request. The procedures described and the figures refer to the case where the connection request is sent in the forward direction. In principle, they also apply when the connection request is sent in the backward direction in the facility request or the information message.

For the connection request embedded in an ISDN user part message an additional interface is used. This functional interface is described in Recommendations Q.711 and Q.714 (signalling connection control part of Signalling System No. 7). The interface elements are listed in § 3.9.

Procedures concerning the SCCP are in accordance with those described in Recommendation Q.714 (signalling connection control part of Signalling System No. 7) and are described here only for illustrative purposes.

3.8.1 *Successful set-up of the ISDN user part end-to-end signalling connection*

The following actions are performed at the originating exchange and at the destination exchange for the set up of an SCCP end-to-end connection using embedded transfer of the connection request in an ISDN user part message (the numbers in the text correspond to the numbers in Figure 18/Q.764):

- 1) The ISDN user part (ISUP) at the originating exchange requests the SCCP to provide the necessary information for a connection request to the called address using the REQUEST type 1 interface element.
- 2) The SCCP at the originating exchange generates a connection request and transfers it to the ISDN user part using the REPLY interface element.
- 3) The ISDN user part at the originating exchange transmits the connection request embedded in an ISDN user part message to the ISDN user part at the destination exchange.
- 7) Upon receiving an embedded connection request in an ISDN user part message, the ISDN user part at the destination exchange transfers the received connection request to the SCCP using the REQUEST type 2 interface element.
- 8) The SCCP at the destination exchange informs the ISDN user part of a request to establish an end-to-end connection using the N-CONNECT indication primitive.
- 9) The ISDN user part responds to the request using the N-CONNECT response primitive.
- 10) Upon receiving the N-CONNECT response primitive from the ISDN user part, the SCCP at the destination exchange sends a connection confirm message into the backward direction.
- 12) Upon receiving a connection confirm message the SCCP at the originating exchange informs the ISDN user part using the N-CONNECT confirmation primitive.

At those transit exchanges which are not SCCP relay-points, the connection request embedded in an ISDN user part message is left unchanged by the ISDN user part and transferred into the forward direction.

An SCCP relay-point is an exchange where two connection sections belonging to the same end-to-end connection are coupled.

The following actions are performed at an SCCP relay-point for the coupling of two connection sections (the numbers in the text correspond to the numbers in Figure 18/Q.764):

- 4) Upon receiving an embedded connection request in an ISDN user part (ISUP) message, the ISDN user part at the SCCP relay-point transfers the received connection request to the SCCP using the REQUEST type 2 interface element with the reply request set.
- 5) The reply request in the REQUEST type 2 interface element causes the SCCP at the SCCP relay-point to provide a connection request for a new connection section. The new connection request is provided to the ISDN user part using the REPLY interface element.

Note – The SCCP allocates an outgoing local reference and associates the incoming and outgoing local references and their corresponding point codes.

- 6) The ISDN user part at the SCCP relay-point transmits the connection request embedded in an ISDN user part message.
- 11) Upon receiving a connection confirm message, the SCCP at the SCCP relay-point sends a connection confirm message into the backward direction.

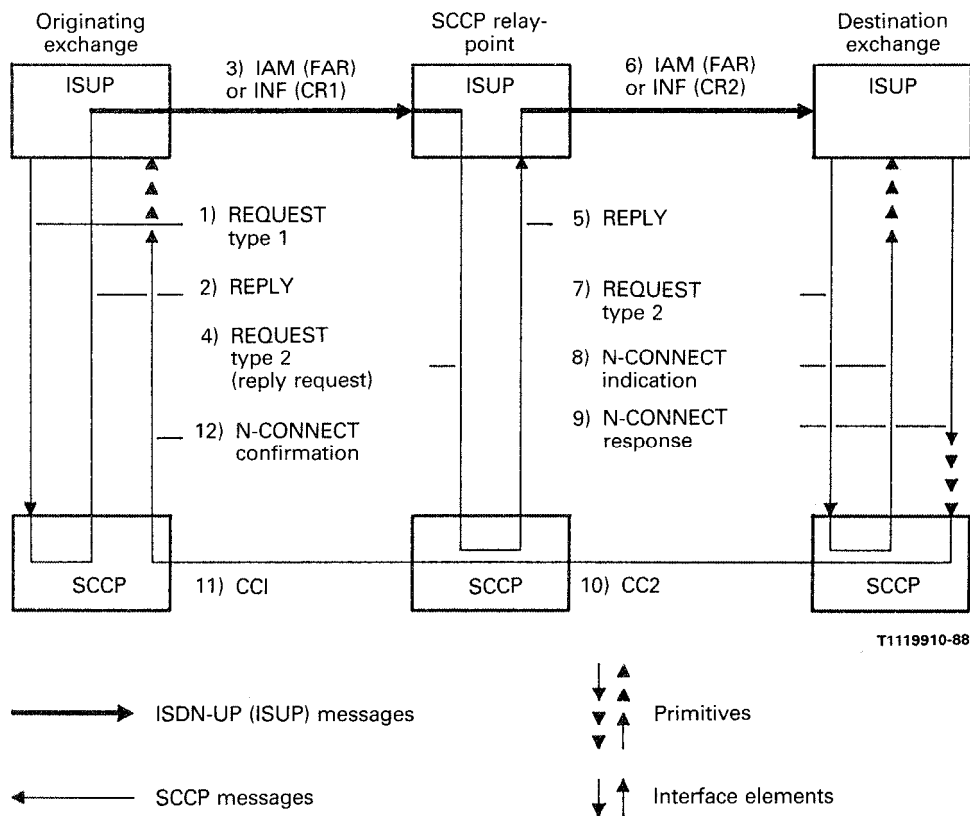

FIGURE 18/Q.764

Embedded transfer of the connection request action under successful set up of the SCCP end-to-end connection

3.8.2 Unsuccessful set-up of the SCCP end-to-end connection

If the ISDN user part end-to-end signalling connection cannot be extended beyond a transit exchange because (for instance) interworking occurs, the ISDN user part at this transit exchange initiates the refusal of the connection request which is then performed by the SCCP. The set-up of the physical connection may be continued.

If the ISDN user part initiates the refusal of a connection request received embedded in the initial address message, in general the following actions are performed. The numbers in the text correspond to the numbers in Figure 19/Q.764:

- 1) Upon receiving an embedded connection request, the ISDN user part transfers the received connection request to the SCCP using the REQUEST type 2 interface element with the refusal indicator set.
- 2) Upon receiving the REQUEST type 2 interface element with the refusal indicator set, the SCCP sends a connection refused message (CREF) into the backward direction.
- 3) Upon receiving a connection refused message, the SCCP at the originating exchange informs the ISDN user part using the N-DISCONNECT indication primitive.

If the SCCP at an SCCP relay-point receives a connection refused message instead of a connection confirm message, the incoming connection section is also released by sending a connection refused message into the backward direction.

If the SCCP at the destination exchange fails to set up the requested end-to-end connection, the following actions are performed to refuse the connection request received in a REQUEST type 2 interface element (the numbers in the text correspond to the numbers in Figure 20/Q.764):

- 1) The SCCP at the destination exchange sends an N-DISCONNECT indication primitive to the ISDN user part.
- 2) At the same time the SCCP sends a connection refused message into the backward direction.

In these situations, the call may be released if the ISDN user part end-to-end signalling connection is essential to satisfy the service requirements of the call.

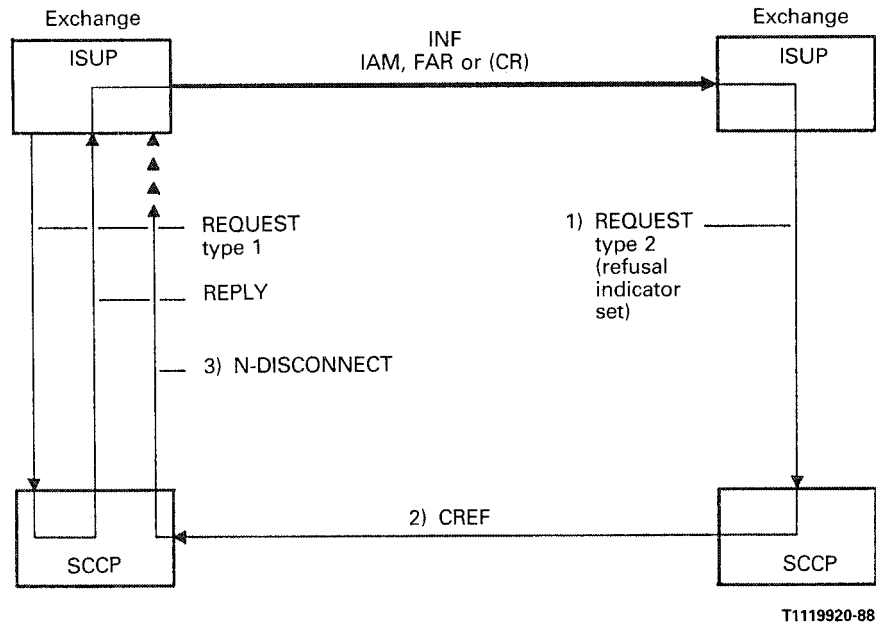

FIGURE 19/Q.764

**Embedded transfer of the connection request
Refusal of the connection request initiated by the ISDN user part.**

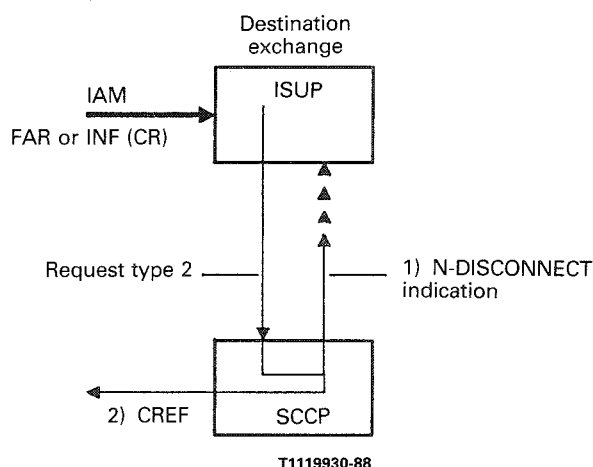

FIGURE 20/Q.764

**Embedded transfer of the connection request
Failure of the SCCP at the destination exchange in setting
up the requested end-to-end connection.**

3.8.3 *Unsuccessful set-up of the physical connection*

If the physical connection cannot be set up at a transit exchange, in addition to releasing the physical connection so far established the ISDN user part initiates the refusal of the connection request. The same actions are performed as at a transit exchange beyond which a logical connection cannot be extended.

If the physical connection cannot be set up at the destination exchange, the ISDN user part can initiate either the refusal or the confirmation of the connection request depending on supplementary services. It may be preferred to always confirm the connection request to allow for the initiation of supplementary services by the calling subscriber.

3.8.4 *Release of the ISDN user part (ISUP) end-to-end signalling connection*

3.8.4.1 *Simultaneous release of the physical and ISUP signalling connections*

The release of the ISDN user part end-to-end signalling connection is initiated from the exchange which initiates the release of the call concerned. At the initiating exchange of call release, when the ISDN user part release message (REL) is transmitted, ISDN user part requests SCCP to transmit a released message (RLSD). This RLSD message contains a cause value of "end user originated" in its cause parameter, if a normal call release initiated by a user is taking place.

Figure 21/Q.764 shows the procedure for this case.

In the case where no application requires the ISDN user part end-to-end signalling connection to be maintained, the ISDN user part at a local exchange, or an exchange performing chaining, requests the SCCP to release the SCCP end-to-end connection if it receives a release message (REL) and the SCCP has not yet received a released (RLSD) message at that time (see Figure 22/Q.764).

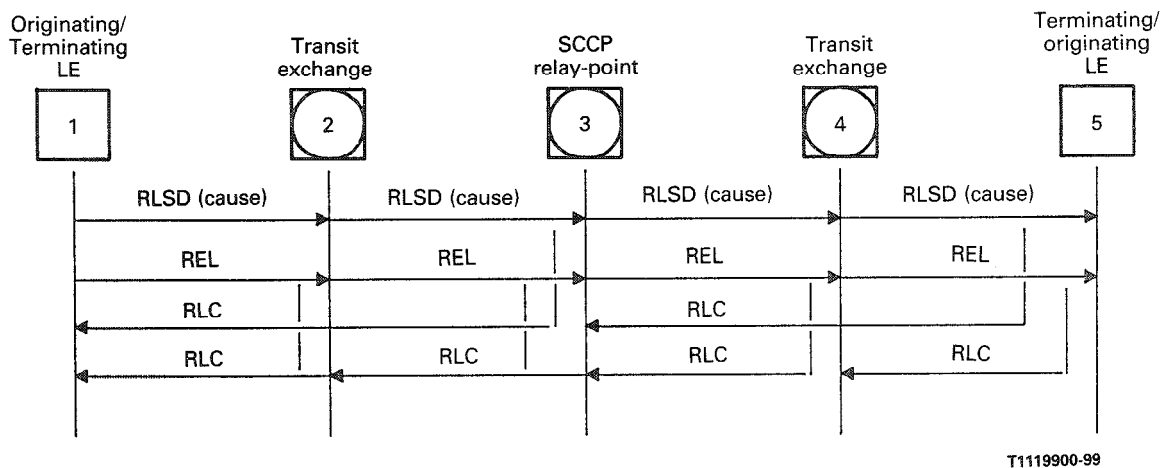

FIGURE 21/Q.764

Simultaneous release of a bearer connection and an ISDN user part end-to-end signalling connection based on SCCP connection-oriented class

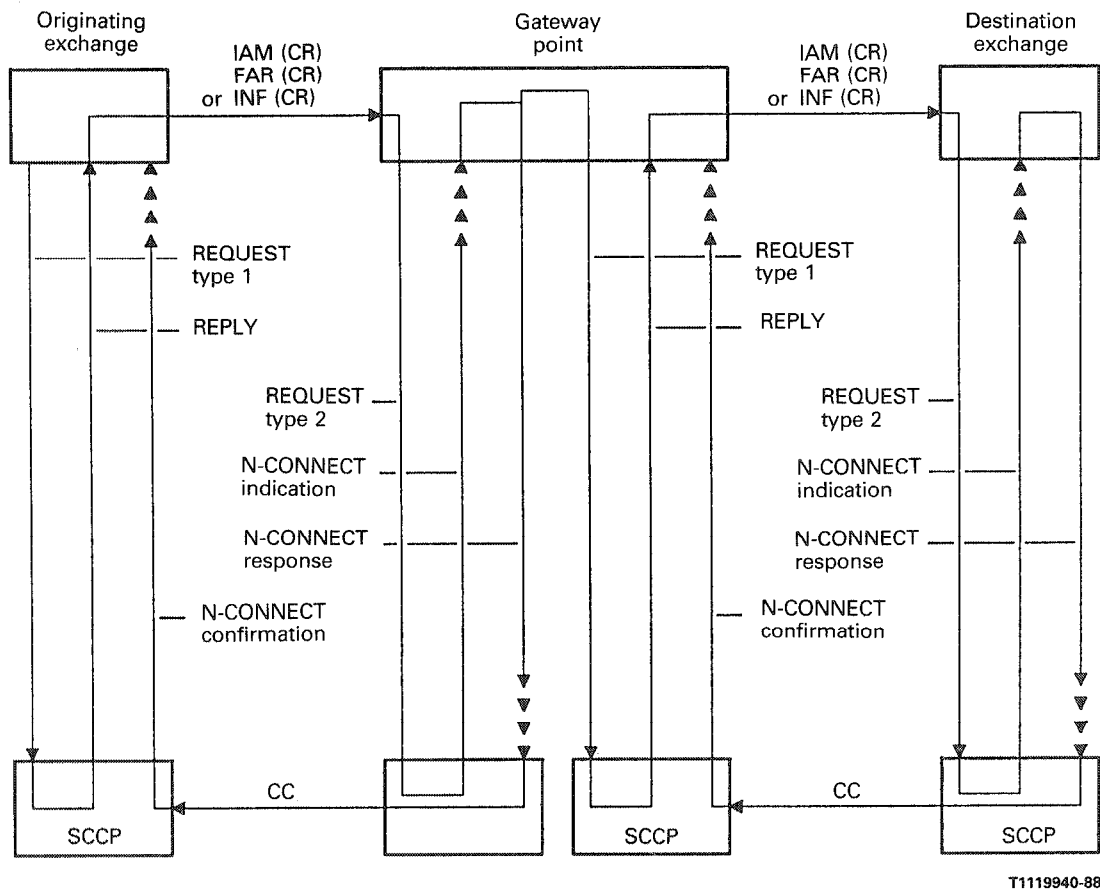

FIGURE 22/Q.764

Chaining of end-to-end connections
 (The outgoing end-to-end connection is assumed to be of the same type as the incoming end-to-end connection)

3.8.4.2 *Non-simultaneous release of the physical and the ISDN user part end-to-end signalling connections*

Procedures for non-simultaneous release of the physical and the ISDN user part end-to-end signalling connections are to be defined in appropriate supplementary services procedures.

3.8.5 *End-to-end message transfer*

An end-to-end message is transferred in an SCCP data (DT1/DT2) message according to the procedures defined in Recommendation Q.714. ISDN user part interfaces with SCCP via the primitives as defined in Recommendation Q.711 for this transfer. The data request/indication primitive includes in its user data parameter an ISDN user part message beginning with the message type code and ending with the parameters.

3.9 *Interface elements between ISDN user part and SCCP (embedded transfer)*

The ISDN user part may use the functional interface as defined in Recommendation Q.711.

Three interface elements are defined for this functional interface:

- a) the REQUEST type 1
- b) the REQUEST type 2
- c) the REPLY

The contents of these three interface elements are shown in Appendix I.

Figures 18/Q.764, 19/Q.764 and 21/Q.764 indicate the usage of the interface elements during set up of a circuit-switched connection together with an SCCP connection.

ANNEX A

(to Recommendation Q.764)

Timers used in Recommendation Q.764 (Sheet 1 of 6)

Symbol	Time-out value	Significance	Cause for initiation	Normal termination	At the first expiry	At the following expiry
T ₁	4-15 s	Local	When release message is sent	At the receipt of release complete message	Retransmit release message and reinitialize timer T ₁	Same as the first expiry
T ₂	3 min	Dual	When controlling exchange receives suspend (user) message	At the receipt of resume (user) message at controlling exchange	Initiate release procedure	—
T ₃	3 min	Dual	When local exchange sends delayed release message	When hold condition is removed	Initiate release procedure	—
T ₄	4-15 s	Dual	When local exchange sends call modification request message	At the reception call modification complete message		—
T ₅	1 min	Local	When initial release message is sent	At receipt of release complete message	Send reset circuit message, alert maintenance personnel, and remove the circuit from service	The sending of the de reset circuit message should continue at 1-min intervals until maintenance intervention occurs
T ₆	Covered in Q.118	Dual	When controlling exchange receives suspend (network)	At the receipt of resume (network) message	Initiate release procedure	—

Timers used in Recommendation Q.764 (Sheet 2 of 6)

Symbol	Time-out value	Significance	Cause for initiation	Normal termination	At the first expiry	At the following expiry
T ₇	20-30 s	Dual	When the latest address message is sent	When the condition for normal release of address and routing informations is met (receipt of ACM, CON, messages)	Release all equipment and connection (Send release message)	—
T ₈	10-15 s	Local	When transit of incoming international exchange receives initial address message	At receipt of continuity message	Release all equipment and connection into national network (Send release message)	—
T ₉	Interval specified in Q.118	Dual	When national controlling or outgoing international exchange sends latest address message after the receipt of ACM	At the receipt of answer	Release connection send back release message	—
T ₁₀	4-6 s	Dual	When last digit is received in interworking situations	At the receipt of fresh information	Send address complete message	—
T ₁₁	15-20 s	Dual	When latest address message is received in interworking situations	Send ACM	Send address complete message	—

Timers used in Recommendation Q.764 (Sheet 3 of 6)

Symbol	Time-out value	Significance	Cause for initiation	Normal termination	At the first expiry	At the following expiry
T ₁₂	4-15 s	Local	When blocking message is sent	At receipt of blocking acknowledgement	Retransmit blocking message and initiate T ₁₂	Same as the left until T ₁₃ expires
T ₁₃	1 min	Local	When initial blocking message is sent	At receipt of blocking acknowledgement	Retransmit blocking message and alert maintenance personnel and start T ₁₃ . Stop T ₁₂	The reception of message should be continued until maintenance intervention occurs and circuit taken out of service as appropriate
T ₁₄	4-15 s	Local	When unblocking message is sent	At receipt of unblocking acknowledgement	Retransmit unblocking message and initiate T ₁₄ timer	Same as the left until T ₁₅ expires
T ₁₅	1 min	Local	When initial unblocking message is sent	At receipt of unblocking acknowledgement	Retransmit unblocking message alert maintenance personnel, start T ₁₅ timer and stop T ₁₄	The repetition of message should be continued until maintenance intervention occurs and circuit taken out of service as appropriate
T ₁₆	4-15 s	Local	When reset circuit message is sent	At the receipt of the acknowledgement (RLC message)	Retransmit reset circuit message and restart T ₁₆	Same as the left until T ₁₇ expires
T ₁₇	1 min	Local	When initial reset circuit message is sent	At receipt of the acknowledgement	Alert maintenance personnel retransmit reset circuit message, restart T ₁₇ and stop T ₁₆	The repetition of message should be continued until maintenance intervention occurs

Timers used in Recommendation Q.764 (Sheet 4 of 6)

Symbol	Time-out value	Significance	Cause for initiation	Normal termination	At the first expiry	At the following expiry
T ₁₈	4-15 s	Local	When group blocking message is sent	At receipt of group blocking acknowledgement	Retransmit group blocking message and initiate T ₁₈	Same as the left until T ₁₈ expires
T ₁₉	1 min	Local	When initial group blocking message is sent	At receipt of group blocking acknowledgement	Retransmit group blocking message, alert maintenance personnel, initiate T ₁₉ and stop T ₁₈	The repetition of message should be continued until maintenance intervention occurs and circuits taken out of service as appropriate
T ₂₀	4-15 s	Local	When group unblocking message is sent	At receipt of group unblocking acknowledgement	Retransmit group unblocking message and initiate T ₂₀	Same as the left until T ₂₀ expires
T ₂₁	1 min	Local	When initial group unblocking message is sent	At receipt of group unblocking acknowledgement	Retransmit group unblocking message, alert maintenance personnel, initiate T ₂₁ and stop T ₂₀	The repetition of message should be continued until maintenance intervention occurs and circuits taken out of service as appropriate
T ₂₂	4-15 s	Local	When circuit group reset message is sent	At the receipt of the acknowledgement	Retransmit circuit group reset message and restart T ₂₂	Same as the first expiry until T ₂₃ expires

Timers used in Recommendation Q.764 (Sheet 5 of 6)

Symbol	Time-out value	Significance	Cause for initiation	Normal termination	At the first expiry	At the following expiry
T ₂₃	1 min	Local	When initial circuit group reset message is sent	At the receipt of the acknowledgement	Alert maintenance personnel and restart Timer T ₂₂ . Retransmit circuit group reset message. Stop timer T ₂₂	The reception of message should be continued until maintenance intervention occurs
T ₂₄	< 2 s	Local	When check tone is sent	At the receipt of backward check tone	Report failure	—
T ₂₅	1-10 s	Local	When continuity check failure is detected (on receipt of continuity recheck request)	—	Send CCR message	—
T ₂₆	1-3 min	Local	When second continuity check failure is detected	—	Send CCR message	—
T ₂₇	4 min	Local	When continuity recheck request is requested	At receipt of continuity check request message	Return to idle	—
T ₂₈	10 s	Local	When send CQM	At receipt of CQR	Alert maintenance	—

Timers used in Recommendation Q.764 (Sheet 6 of 6)

Symbol	Time-out value	Significance	Cause for initiation	Normal termination	At the first expiry	At the following expiry
T ₂₉	300-600 ms	Local	First congestion/first congestion indication after T ₃₀ expires	—	—	—
T ₃₀	5-10 s	Local	First congestion indication	—	—	—
T ₃₁	> 6 min	Local	Release of ISDN User part signalling connection based on CO SCCP	On expiry	—	Call reference reusable
T ₃₂	3-5 s	Local	On receipt of end-to-end message	On expiry	—	End-to-end message to be sent
T ₃₃	12-15 s	Local	When send INR	On receipt of INF	Release call	—
T ₃₄	12-15 s	Local	When send circuits group query	On receipt of circuits group query response	Maintenance action	—

ANNEX B
(to Recommendation Q.764)

State transition diagrams

Note – Should any conflict arise between the text and the SDL definition, the textual description is taken as definitive.

B.1 *General*

This Annex contains the description of the signalling procedures described in this Recommendation in the form of state transition diagrams according to the CCITT Specification and Description Language (SDL). In order to facilitate functional description, the ISDN User Part (ISDN-UP) signalling procedure is divided into main functional blocks, as shown in Figure B-1/Q.764. These blocks are as follows:

1) *Signalling procedure control (SPRC)*

SPRC provides procedures for sending ISDN-UP messages to Level 3 (SCCP or MTP) and distributing received messages to the other ISDN-UP functional blocks.

2) *Call processing control (CPC)*

CPC provides call control procedures for realizing basic circuit switched service according to user's request.

3) *Circuit supervision control (CSC)*

CSC provides procedures for circuit supervision control for maintenance purpose and for recovery from abnormal situation.

B.2 *Drafting convention*

a) External inputs and outputs are used for interactions with a remote exchange and interaction between SPRC and the other functional blocks. Internal inputs and outputs are used for interactions within each functional block, e.g., to indicate control of time-out. For these interactions, input and output symbols are used as shown in Figure B-2/Q.764.

b) Inputs and outputs symbols contain as part of their name acronyms of their source and destination functional block names with an arrow in between, e.g., Blocking BLS -> CPC.

c) A simple example of SDL diagram according to the above conventions is shown in Figure B-3/Q.764.

B.3 *Abbreviations, timers and primitives*

B.3.1 *Abbreviations*

1) Table B-1/Q.764:

Signalling procedure control.

2) Table B-2/Q.764:

Call processing control.

3) Table B-3/Q.764:

Circuit supervision control.

B.3.2 *Timers*

Timers used in the ISDN-UP SDL diagrams are shown in Table B-4/Q.764.

B.3.3 *Primitives*

Primitives used over the interface between call control and ISDN-UP are shown in Table B-5/Q.764.

B.4 *State transition diagrams and SDL diagrams*

Each ISDN-UP main functional block is further subdivided into the functional blocks. Functional diagrams and simple state transition diagrams for each main functional block are shown below:

- 1) Signalling procedure control (SPRC)
 - Figure B-4/Q.764
Functional diagrams
 - Figure B-5/Q.764
State transition diagrams
- 2) Call processing control (CPC)
 - Figure B-6/Q.764
Functional diagrams
 - Figures B-7/Q.764 to B-9/Q.764
State transition diagrams
- 3) Circuit supervision control (CSC)
 - Figure B-10/Q.764
Functional diagrams
 - Figures B-11/Q.764 to B-18/Q.764
State transition diagrams

The ISDN-UP SDL diagrams are described based on the three-blocks approach. In this approach, call control, which provides signalling-independent functions such as connect-through, circuit selection and digits analysis, is outside the ISDN-UP. These functions are described only in §§ 1-3. The ISDN-UP diagrams are provided for the above subdivided functional blocks, as shown below:

- 1) Signalling procedure control (SPRC)
 - Figure B-19/Q.764
Message sending control
 - Figure B-20/Q.764
Message distributing control
- 2) Call processing control (CPC)
 - Figure B-21/Q.764
Call processing control incoming (CPCI)
 - Figure B-22/Q.764
Call processing control outgoing (CPCO)
 - Figure B-23/Q.764
Continuity check incoming (CCI)
 - Figure B-24/Q.764
Continuity check outgoing (CCO)
- 3) Circuit supervision control (CSC)
 - Figure B-25/Q.764
Blocking/unblocking message sending (BLS)
 - Figure B-26/Q.764
Blocking/unblocking message reception (BLR)
 - Figure B-27/Q.764
Maintenance oriented circuit group blocking/unblocking sending (MGBS)
 - Figure B-28/Q.764
Blocking/unblocking reception (MGBR)
 - Figure B-29/Q.764
Hardware failure oriented locally blocking state (HLB)
 - Figure B-30/Q.764
Hardware failure oriented remotely blocking state (HRB)
 - Figure B-31/Q.764
Hardware failure oriented circuit group blocking/unblocking sending (HGBS):

- Figure B-32/Q.764
Hardware failure oriented circuit group blocking/unblocking reception (HGBR)
- Figure B-33/Q.764
Circuit reset sending (CRS)
- Figure B-34/Q.764
Circuit reset reception (CRR)
- Figure B-35/Q.764
Circuit group reset sending (CGRS)
- Figure B-36/Q.764
Circuit group reset reception (CGRR)
- Figure B-37/Q.764
Continuity recheck sending (CRCS)
- Figure B-38/Q.764
Continuity recheck reception (CRCR)
- Figure B-39/Q.764
Circuit group query sending (CQS)
- Figure B-40/Q.764
Circuit group query reception (CQR)

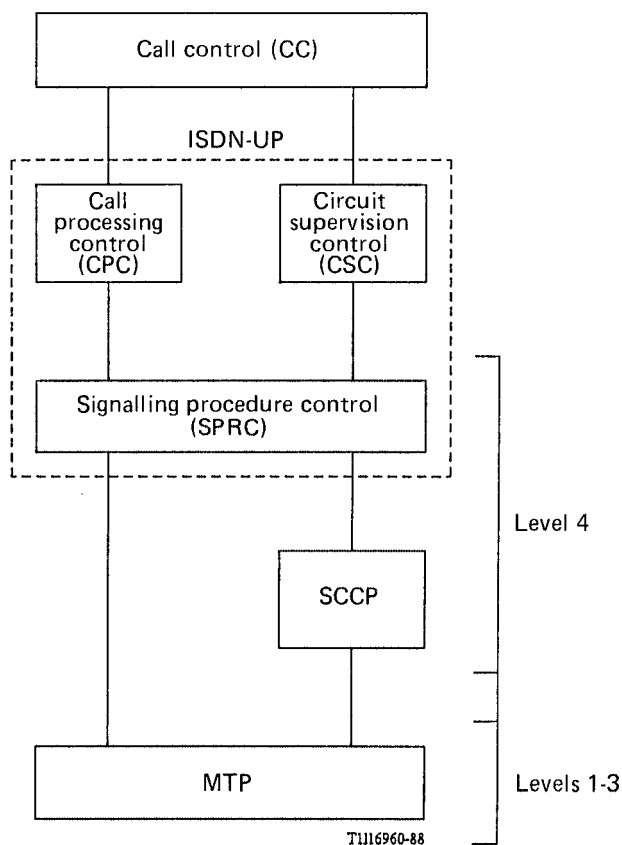
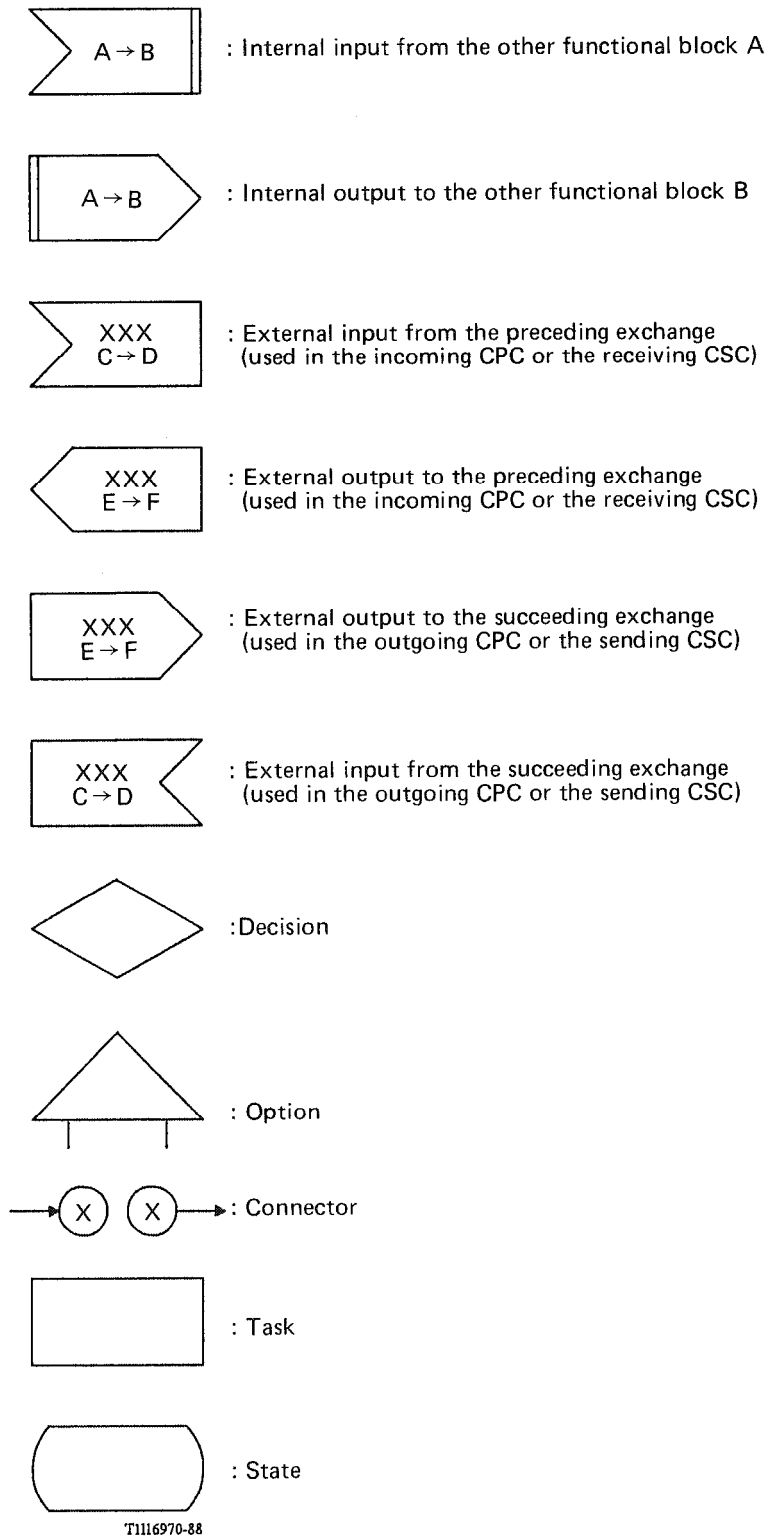

FIGURE B-1/Q.764

Overview functional block diagram for ISDN-UP



Note – Input which is not shown in SDL diagrams should be discarded.

FIGURE B-2/Q.764
Symbols used in SDL diagrams

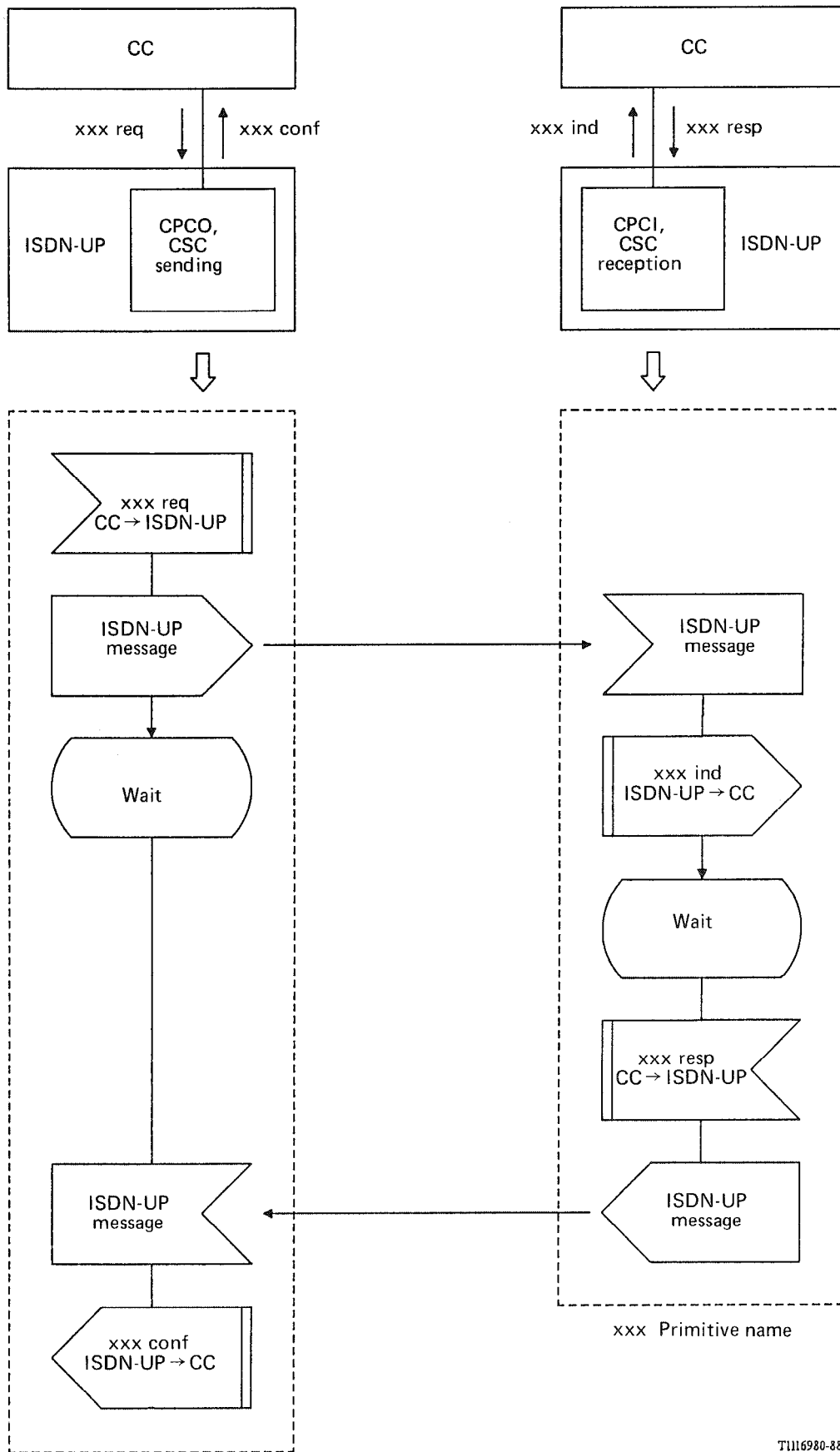

T1116980-88

FIGURE B-3/Q.764
SDL convention example

TABLE B-1/Q.764

Signalling procedure control acronym

	Acronym	Description
Functional block name	BLR	Blocking/Unblocking Message Reception
	BLS	Blocking/Unblocking Message Sending
	CCO	Continuity Check Outgoing
	CCI	Continuity Check Incoming
	CGRS	Circuit Group Reset Sending
	CGRR	Circuit Group Reset Reception
	CPC	Call Processing Control
	CRR	Circuit Reset Reception
	CRS	Circuit Reset Sending
	CSC	Circuit Supervision Control
	SPRC	Signalling Procedure Control
	MGBR	Maintenance Oriented Circuit Group Blocking/Unblocking Reception
	HGBR	Hardware Failure Oriented Circuit Group Blocking/Unblocking Reception
	MGBS	Maintenance Oriented Circuit Group Blocking/Unblocking Sending
	HGBS	Hardware Failure Oriented Circuit Group Blocking/Unblocking Sending
	CRCR	Continuity Recheck Control Reception
	CRCS	Continuity Recheck Control Sending
	CQR	Circuit Group Query Reception
	CQS	Circuit Group Query Sending
	MSDC	Message Sending Control
MDSC	Message Distributing Control	
BLA	Blocking Acknowledgement	
Message type	BLO	Blocking
	GRA	Group Reset Acknowledgement
	GRS	Group Reset
	CQR	Circuit Group Query Response
	CQM	Circuit Group Query
	UBA	Unblocking Acknowledgement
	UBL	Unblocking
	CCR	Continuity Check Request
	CGB	Circuit Group Blocking
	CGBA	Circuit Group Blocking Acknowledgement
	CGU	Circuit Group Unblocking
	CGUA	Circuit Group Unblocking Acknowledgement
	RSC	Reset Circuit
	CFN	Confusion

TABLE B-2/Q.764

Call processing control acronym

	Acronym	Description
General	OGC ICC CCH	Outgoing Trunk Circuit Incoming Trunk Circuit Continuity Check Indicator
Functional block name	CC SPRC CPC BLR BLS CCO CCI CGRR CRR CRS CPCI CPCO MGBR HGBR MGBS HGBS CRCR CRCS	Call control Signalling Procedure Control Call Processing Control Blocking/Unblocking Message Reception Blocking/Unblocking Message Sending Continuity Check Outgoing Continuity Check Incoming Circuit Group Reset Reception Circuit Reset Reception Circuit Reset Sending Call Processing Control Incoming Call Processing Control Outgoing Maintenance Oriented Circuit Group Unblocking/Blocking Reception Hardware Failure Oriented Circuit Group Blocking/Unblocking Reception Maintenance Oriented Circuit Group Unblocking/Blocking Sending Hardware Failure Oriented Circuit Group Blocking/Unblocking Sending Continuity Recheck Reception Continuity Recheck Sending
Message type	ACM ANM COT CPG IAM SUS RES REL RLC FOT SAM CON	Address Complete Answer Continuity Call Progress Initial Address Suspend (network-or user-initiated) Resume (network-or user-initiated) Release Release Complete Forward Transfer Subsequent Address Connect

TABLE B-3/Q.764

Circuit supervision control acronym

	Acronym	Description
Functional block name	BLR BLS CRS CRR CGRS CGRR MGBR HGBR MGBS HGBS CRCR CRCS CQR CQS HRB HLB	Blocking/Unblocking Reception Blocking/Unblocking Sending Circuit Reset Sending Circuit Reset Reception Circuit Group Reset Sending Circuit Group Reset Reception Maintenance Oriented Circuit Group Blocking/Unblocking Reception Hardware Failure Oriented Circuit Group Blocking/Unblocking Reception Maintenance Oriented Circuit Group Blocking/Unblocking Sending Hardware Failure Oriented Circuit Group Blocking/Unblocking Sending Continuity Recheck Reception Continuity Recheck Sending Circuit Group Query Reception Circuit Group Query Sending Hardware Failure Oriented Remotely Blocking Hardware Failure Oriented Locally Blocking State
Message type	BLA BLO COT CQR CQM GRA GRS RLC RSC UBA UBL CGB CGBA CCR CGU CGUA REL	Blocking Acknowledgement Blocking Continuity Circuit Group Query Response Circuit Group Query Group Reset Acknowledgement Group Reset Release Complete Reset Circuit Unblocking Acknowledgement Unblocking Circuit Group Blocking Circuit Group Blocking Acknowledgement Continuity Check Request Circuit Group Unblocking Circuit Group Unblocking Acknowledgement Release

TABLE B-4/Q.764

Timer

Timer	Symbol	Time-out value
First RLC timer	T1	4-15 s
Second RLC timer	T5	1 min
RES timer (network)	T6	Covered in Q.118
ACM timer	T7	20-30 s
COT timer	T8	10-15 s
ANM timer	T9	Interval specified in Q.118
First BLA timer	T12	4-15 s
Second BLA timer	T13	1 min
First UBA timer	T14	4-15 s
Second UBA timer	T15	1 min
First RSC response timer	T16	4-5 s
Second RSC response timer	T17	1 min
First CGBA timer	T18	4-15 s
Second CGBA timer	T19	1 min
First CGUA timer	T20	4-15 s
Second CGUA timer	T21	1 min
First GRA timer	T22	4-15 s
Second GRA Timer	T23	1 min
Continuity tone timer	T24	2 s
CCR timing timer	T25	1-10 s
CCR response timer	T26	1-3 min
CCR receive timer	T27	4 min
CQR timer	T28	10 s

TABLE B-5/Q.764

Primitives

Primitive		ISDN-UP message	Interface
SETUP	REQUEST INDICATION RESPONSE CONFIRMATION	IAM ANM, CON	Interface between CC and CPC
RELEASE		REL, RLC	
RESET	INDICATION RESPONSE	RSC, RLC GRS, GRA	
FORWARD TRANSFER	REQUEST INDICATION	FOT	
PROC		ACM (Other)	
ALERT		CPG, ACM (Subscriber free)	
INFO		SAM	
PROG ^{a)}		CPG, ACM (Interworking, Q.931 progress indicator)	
IBI ^{b)}		CPG (In-band information) ACM (In-band information)	
SUSPENDED		SUS	
RESUMED		RES	
BLOCKING		REQUEST INDICATION RESPONSE CONFIRMATION	BLO, BLA CGB, CGBA
UNBLOCKING		UBL, UBA CGU, CGUA	
CCT GROUP QUERY		CQM, CQR	
STOP ^{c)}	REQUEST CONFIRMATION	–	
CONTINUITY RECHECK		CCR	
RESET		GRS, GRA RSC, RLC	

TABLE B-5/Q.764 (cont.)

Primitive		ISDN-UP message	Interface
CALL FAILURE ^{c)}	INDICATION	–	Interface between CC and CPC
REATTEMPT ^{c)}			
CONTINUITY REPORT	REQUEST INDICATION	COT	
MAINTENANCE SYSTEM ^{c)}	INDICATION	–	Interface between CC and CSC
START RESET ^{c)}			CC and CPC

- a) Prog (network): Interworking
Prog (access): Q.931 progress indicator
- b) IBI: In-band information available
- c) Locale primitive

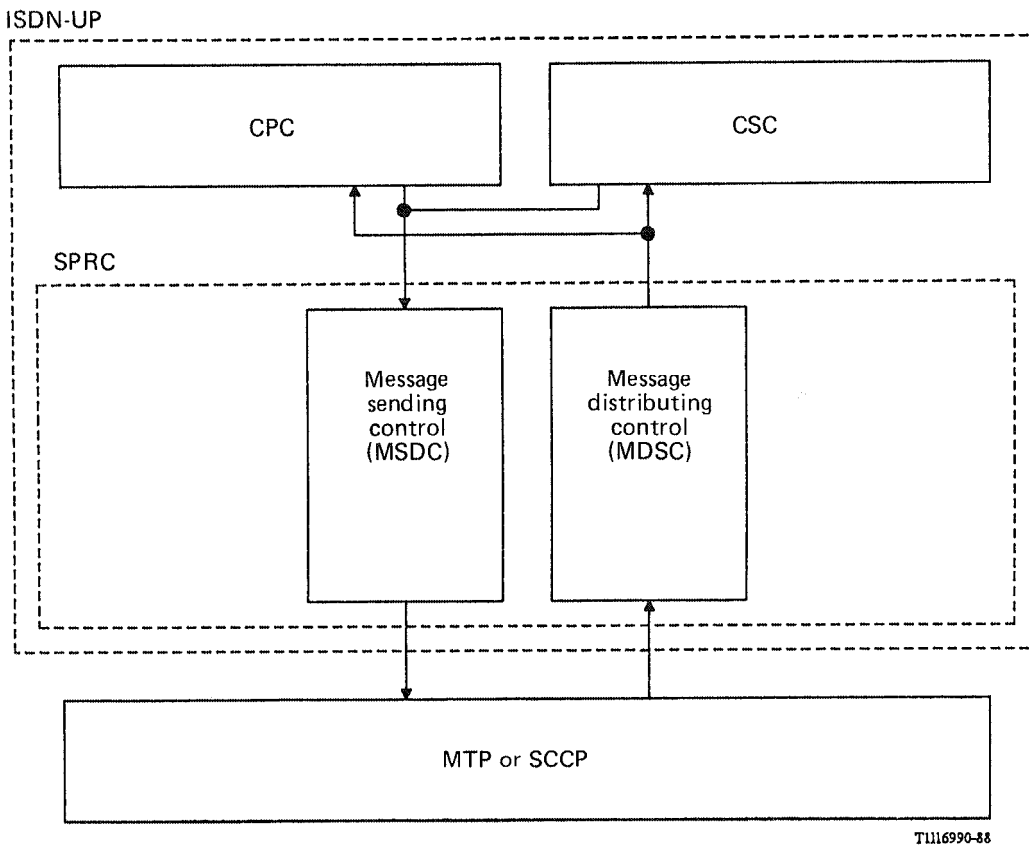

FIGURE B-4/Q.764
Functional block diagram for SPRC

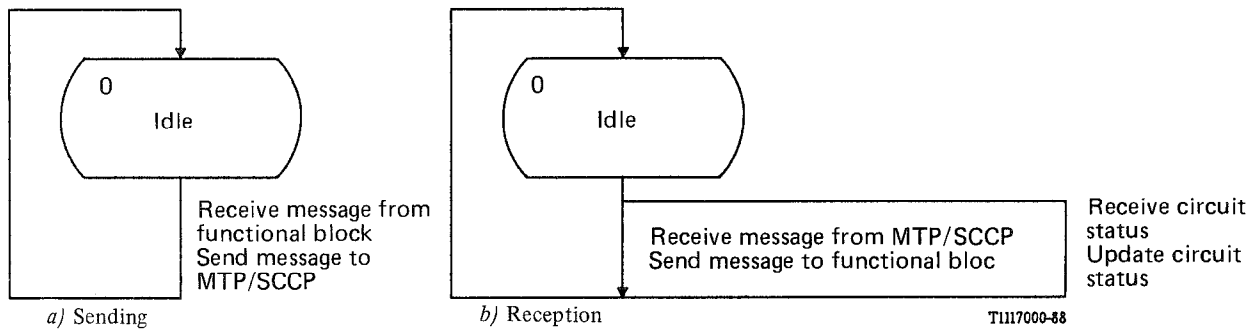

FIGURE B-5/Q.764

State transition diagrams for SPRC

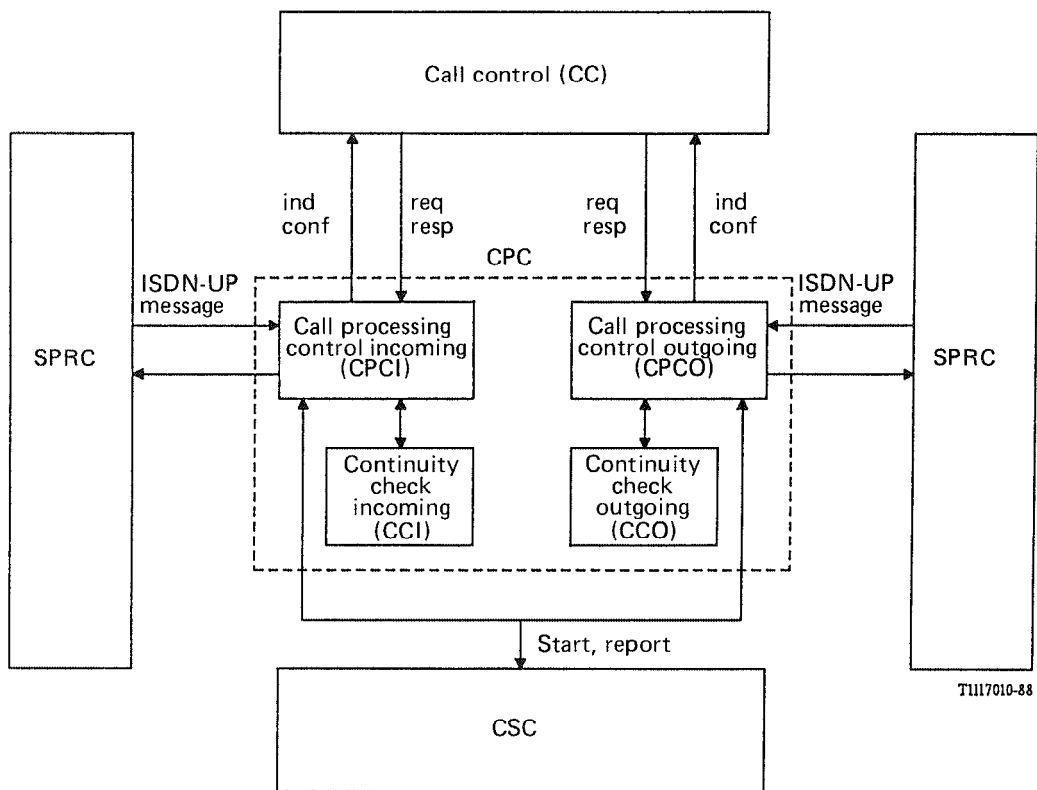

FIGURE B-6/Q.764

Functional block diagram for CPC

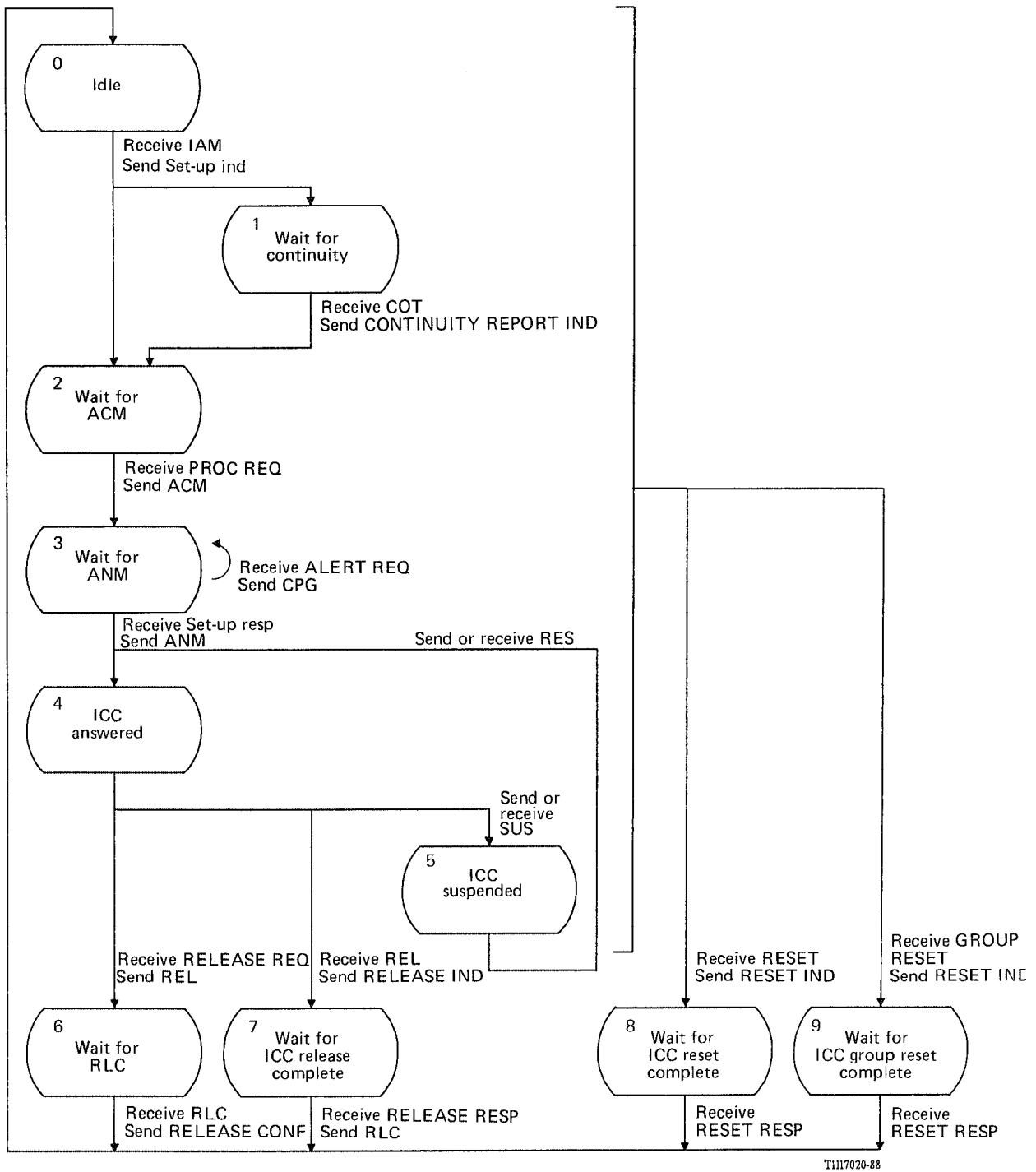
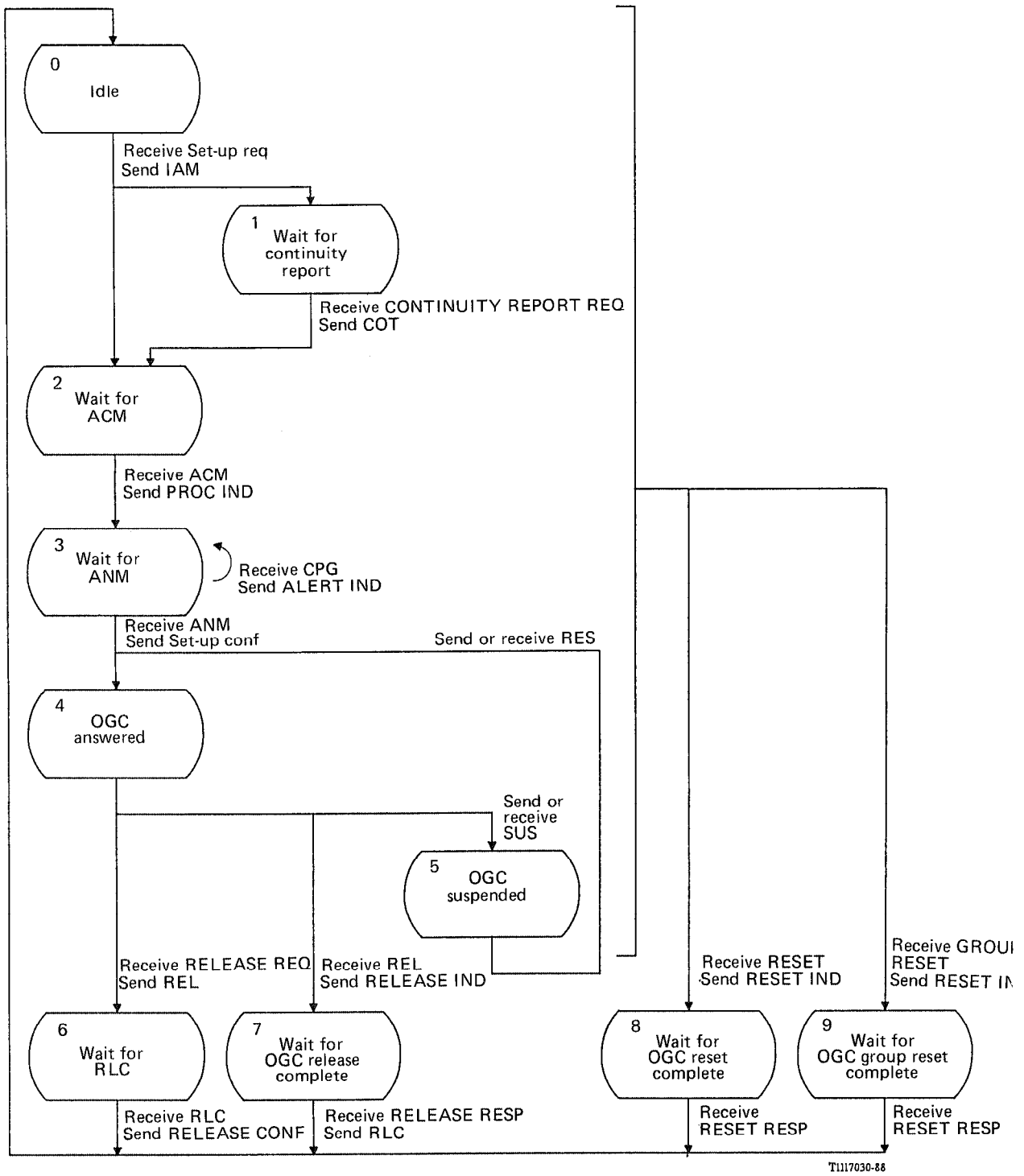
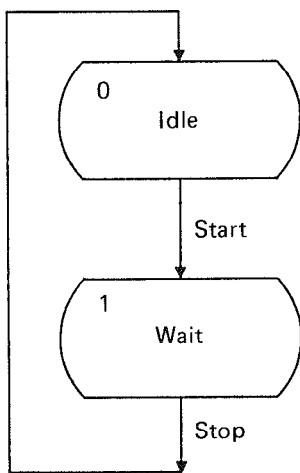

FIGURE B-7/Q.764
State transition diagrams for CPC incoming (CPCI)



T1117030-88

FIGURE B-8/Q.764
 State transition diagrams for CPC outgoing (CPCO)



a) Incoming (CCI)

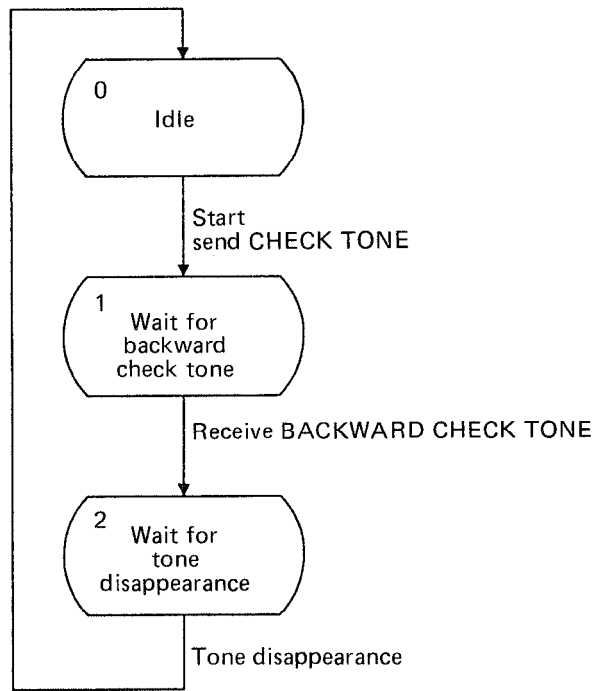

T1117040-88

b) Outgoing (CCO)

FIGURE B-9/Q.764
State transition diagrams for CPC continuity check

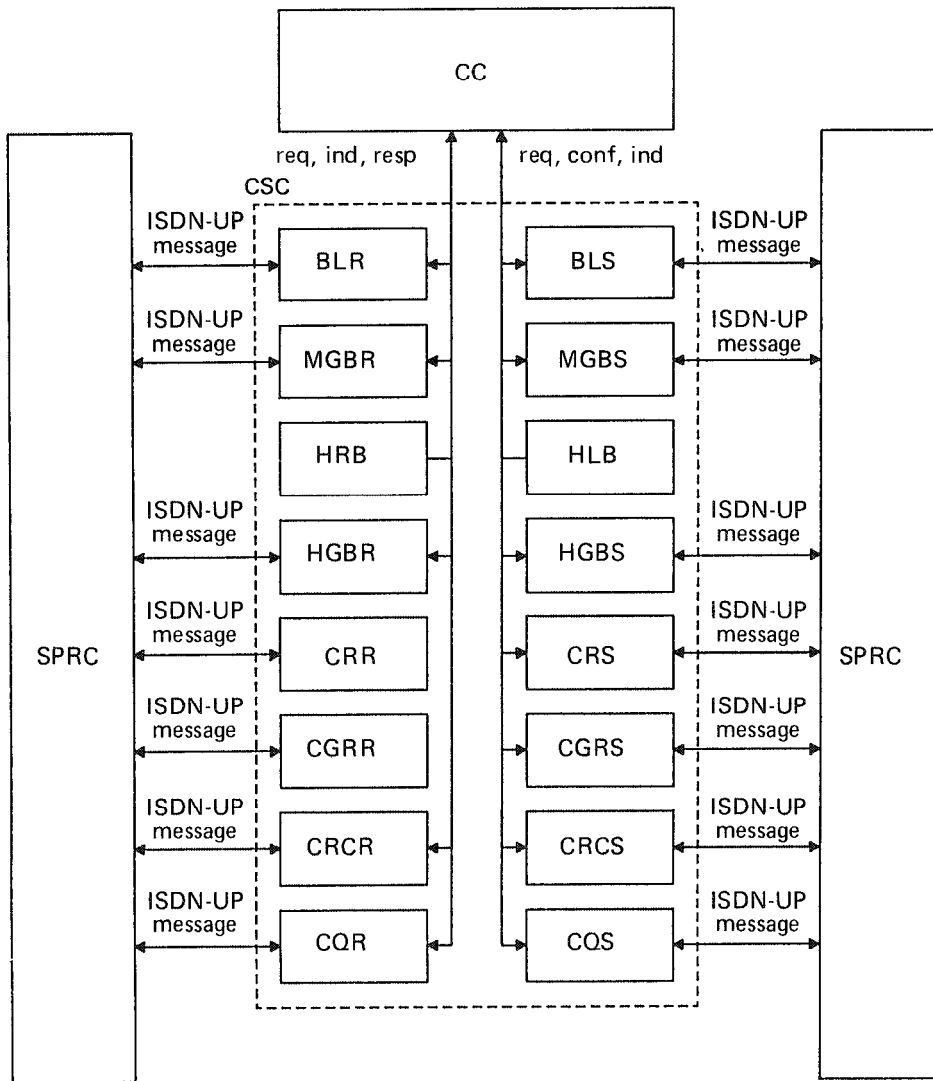

T1117050-88

FIGURE B-10/Q.764
Fonctional block diagram for CSC

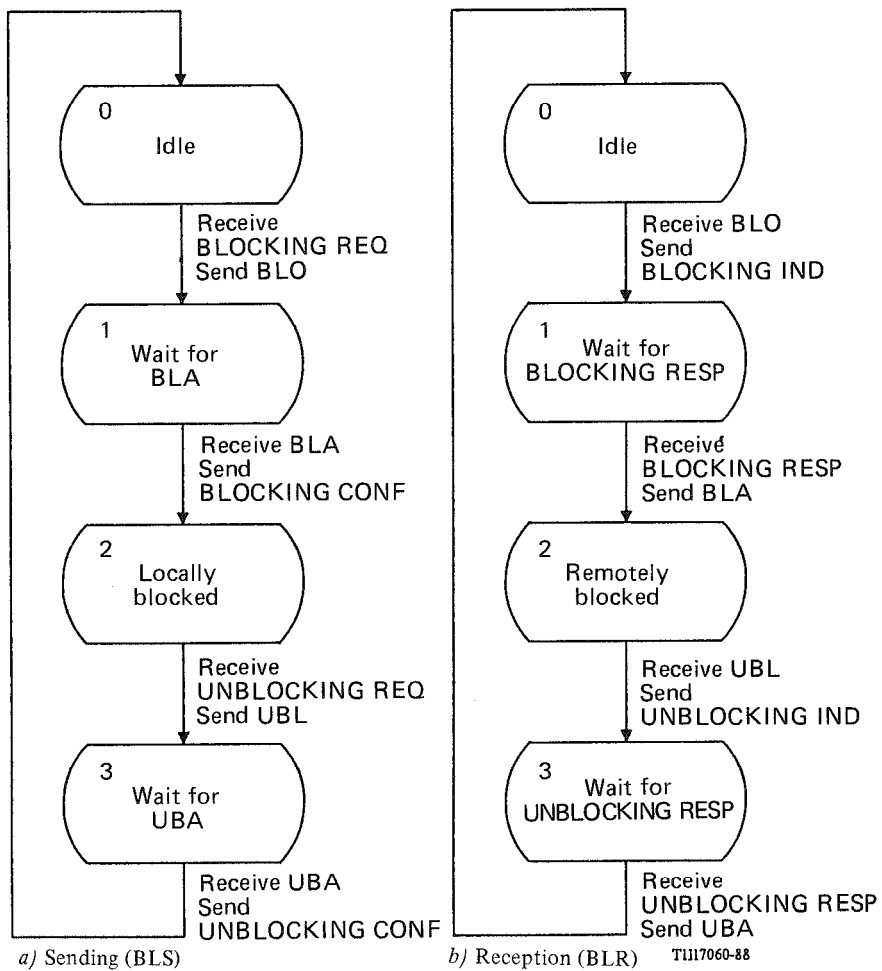

FIGURE B-11/Q.764

State transition diagrams for Blocking / Unblocking

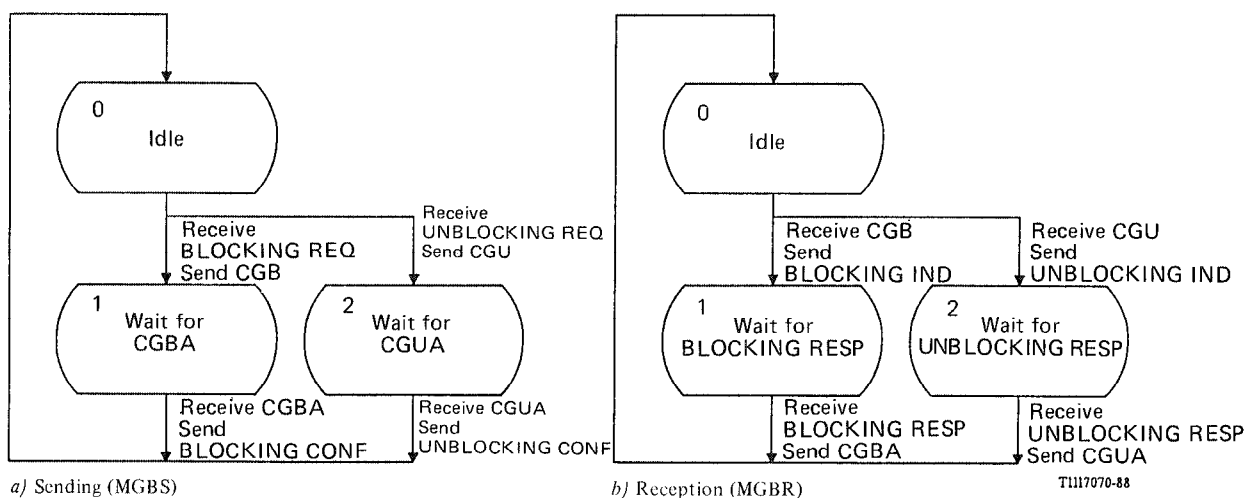

FIGURE B-12/Q.764

State transition diagrams for maintenance group blocking/unblocking

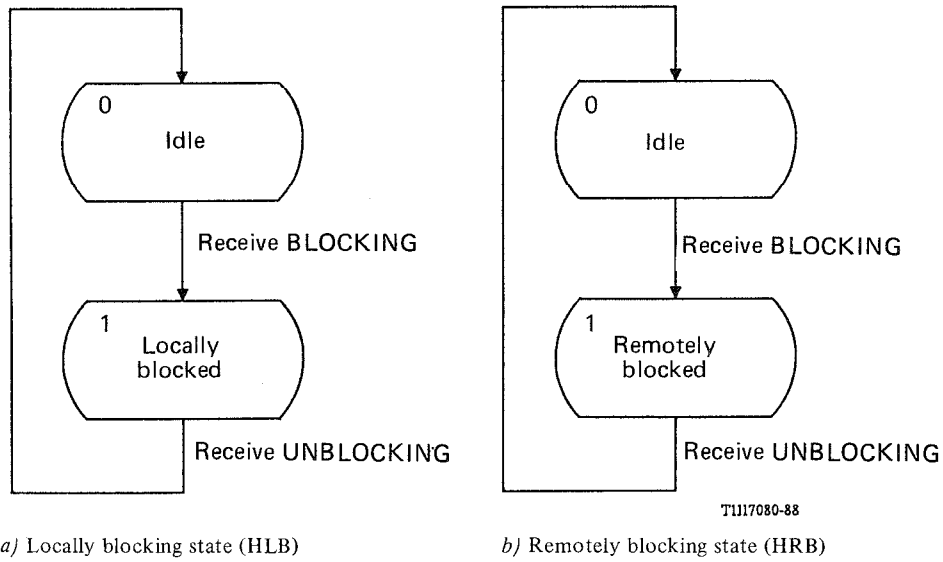

FIGURE B-13/Q.764

State transition diagrams for hardware failure oriented blocking state

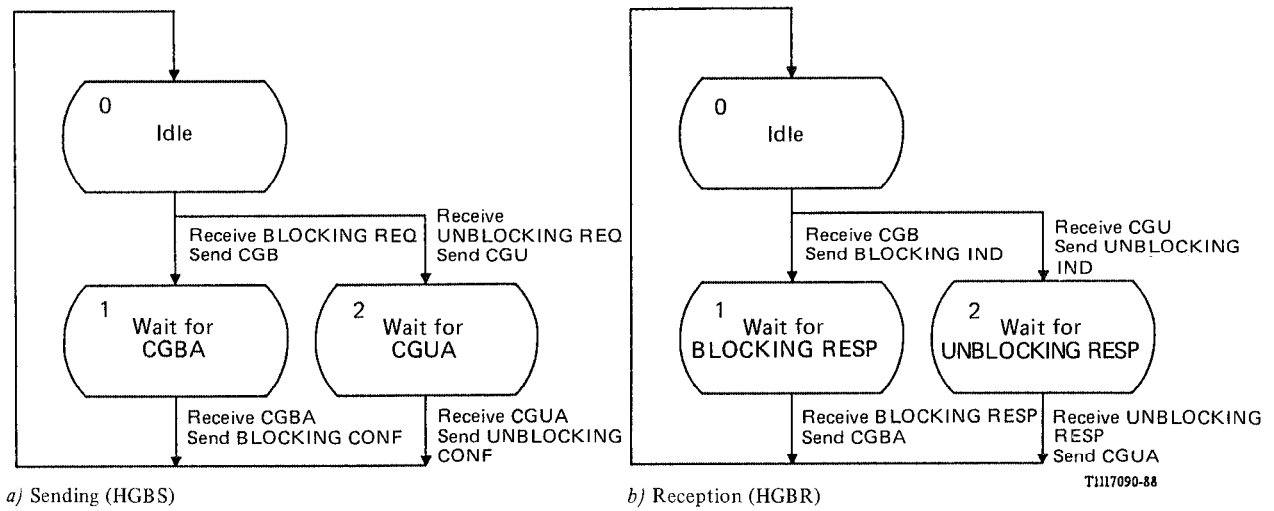

FIGURE B-14/Q.764

State transition diagrams for maintenance group blocking/unblocking

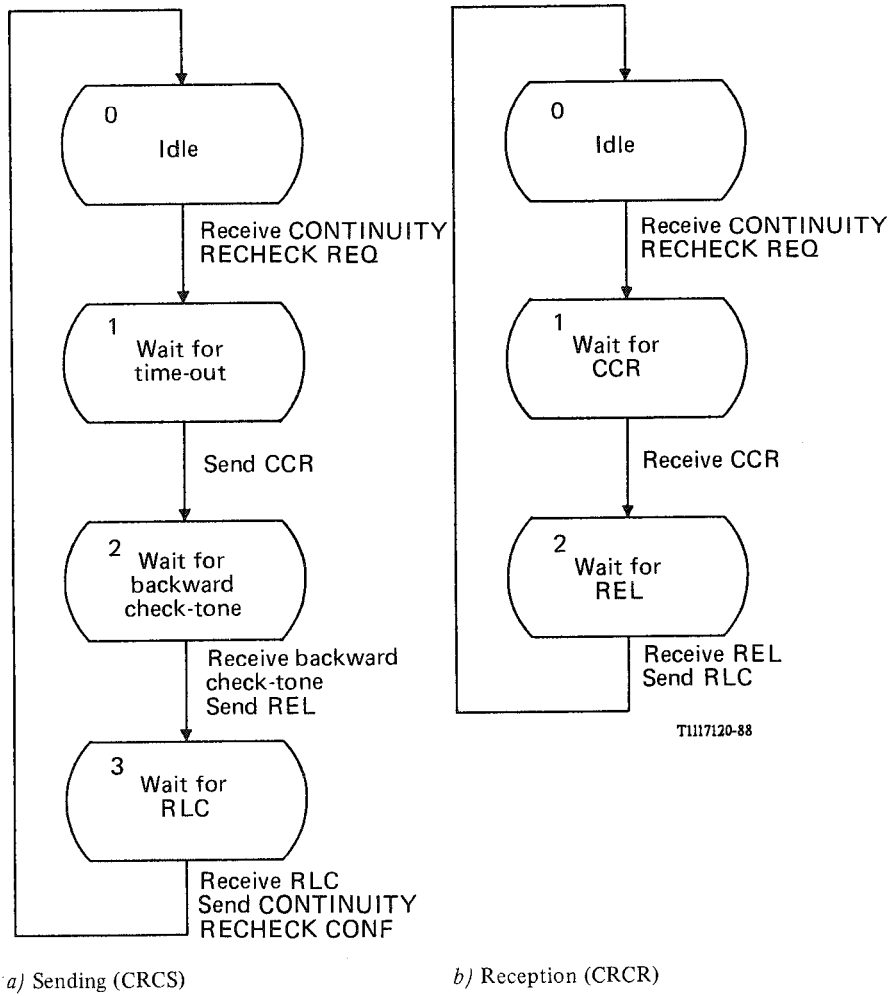

FIGURE B-17/Q.764

State transition diagrams for continuity recheck

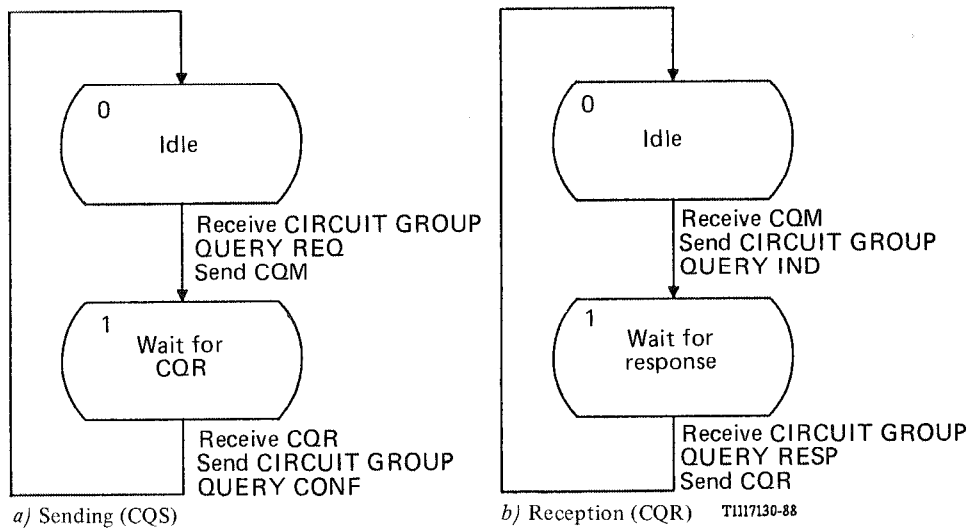
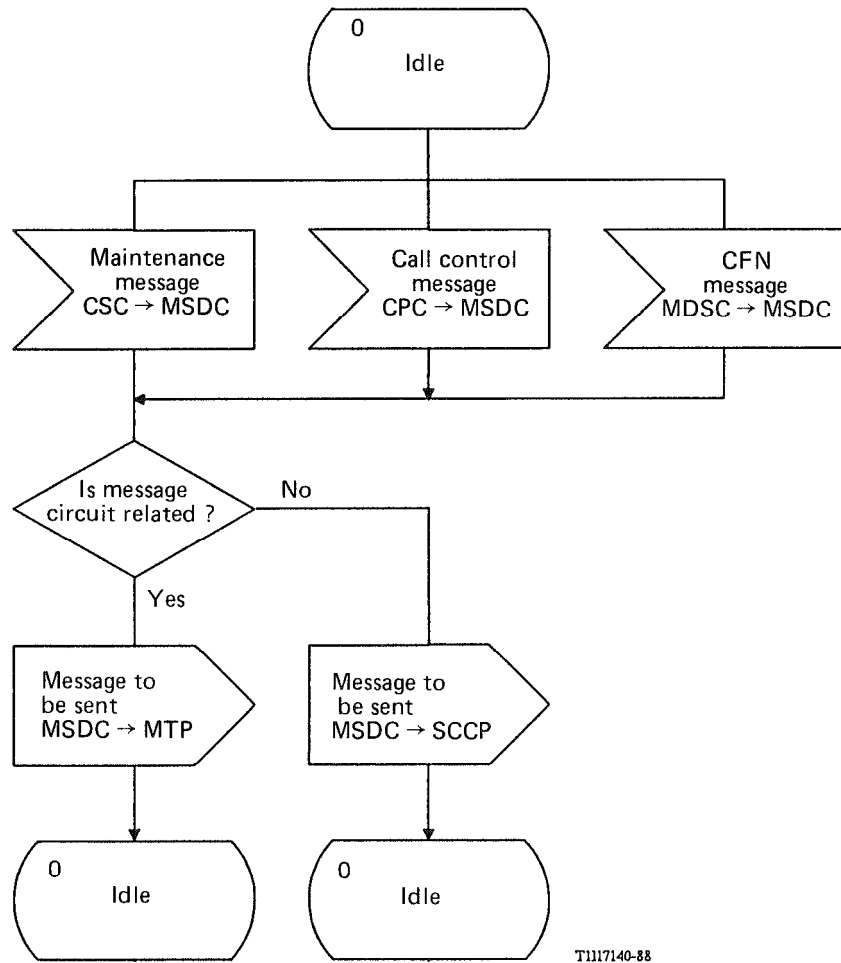

FIGURE B-18/Q.764

State transition diagrams for circuit group query



T1117140-88

FIGURE B-19/Q.764
 Message sending control (MSDC)

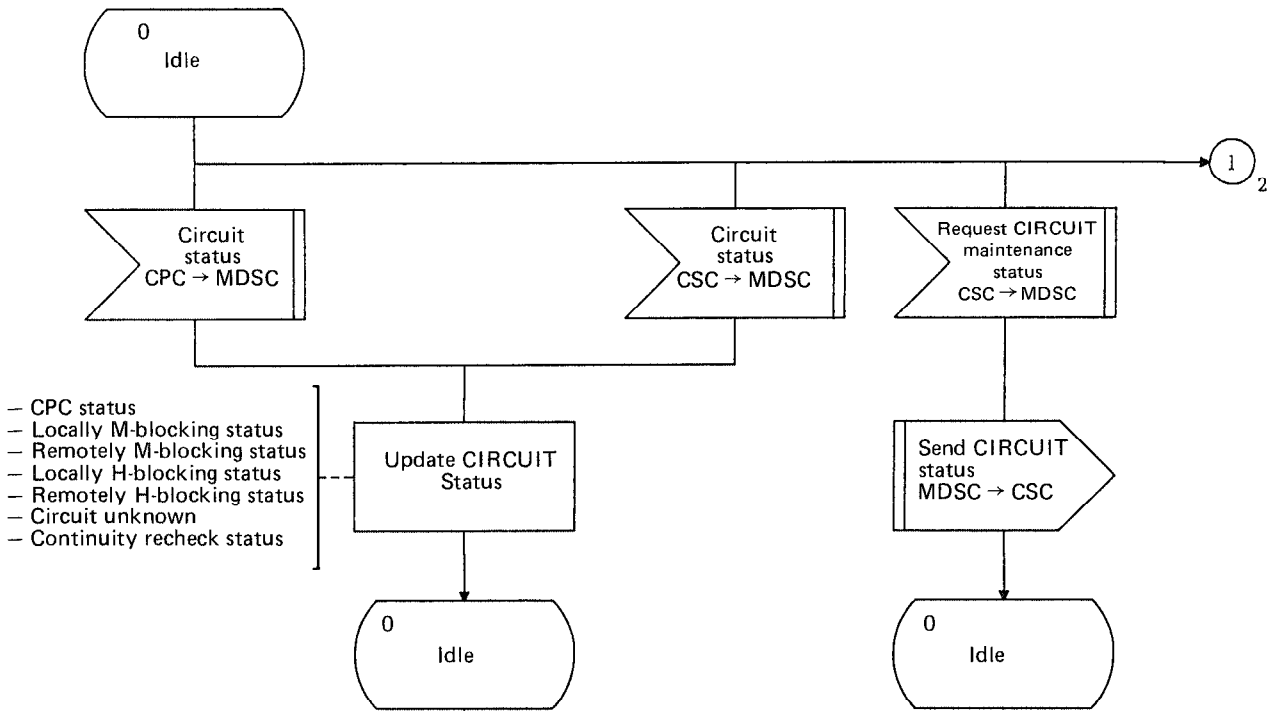

T1117150-88

M-blocking Maintenance oriented blocking (BLS, BLR, MGBS, MGBR)
H-blocking Hardware failure oriented blocking (HLB, HRB, HGBS, HGBR)

FIGURE B-20/Q.764 (Sheet 1 of 2)
Message distributing control (MDSC)

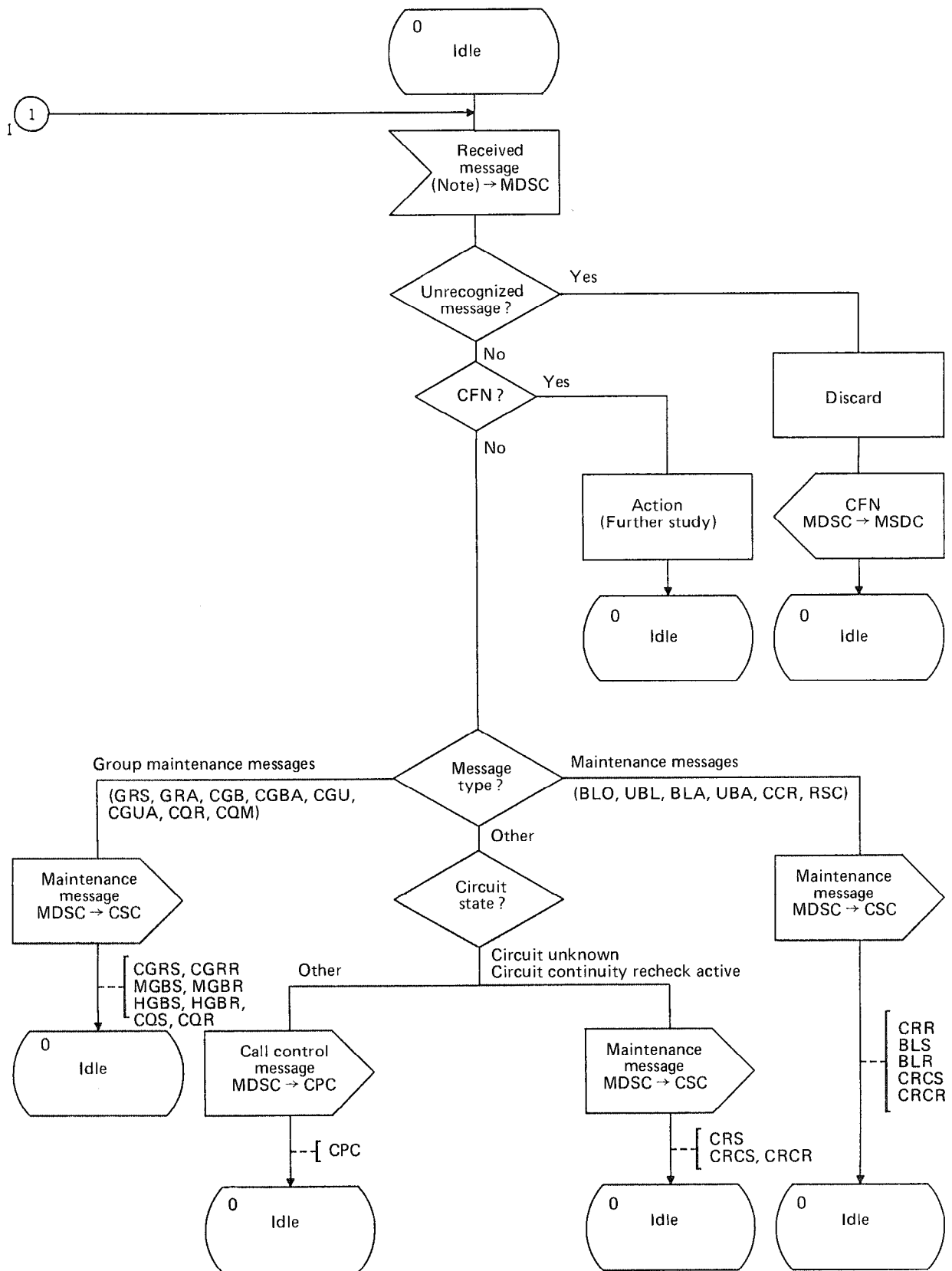

Note – MTP/SCCP

T1117160-88

FIGURE B-20/Q.764 (Sheet 2 of 2)
 Message distributing control (MDSC)

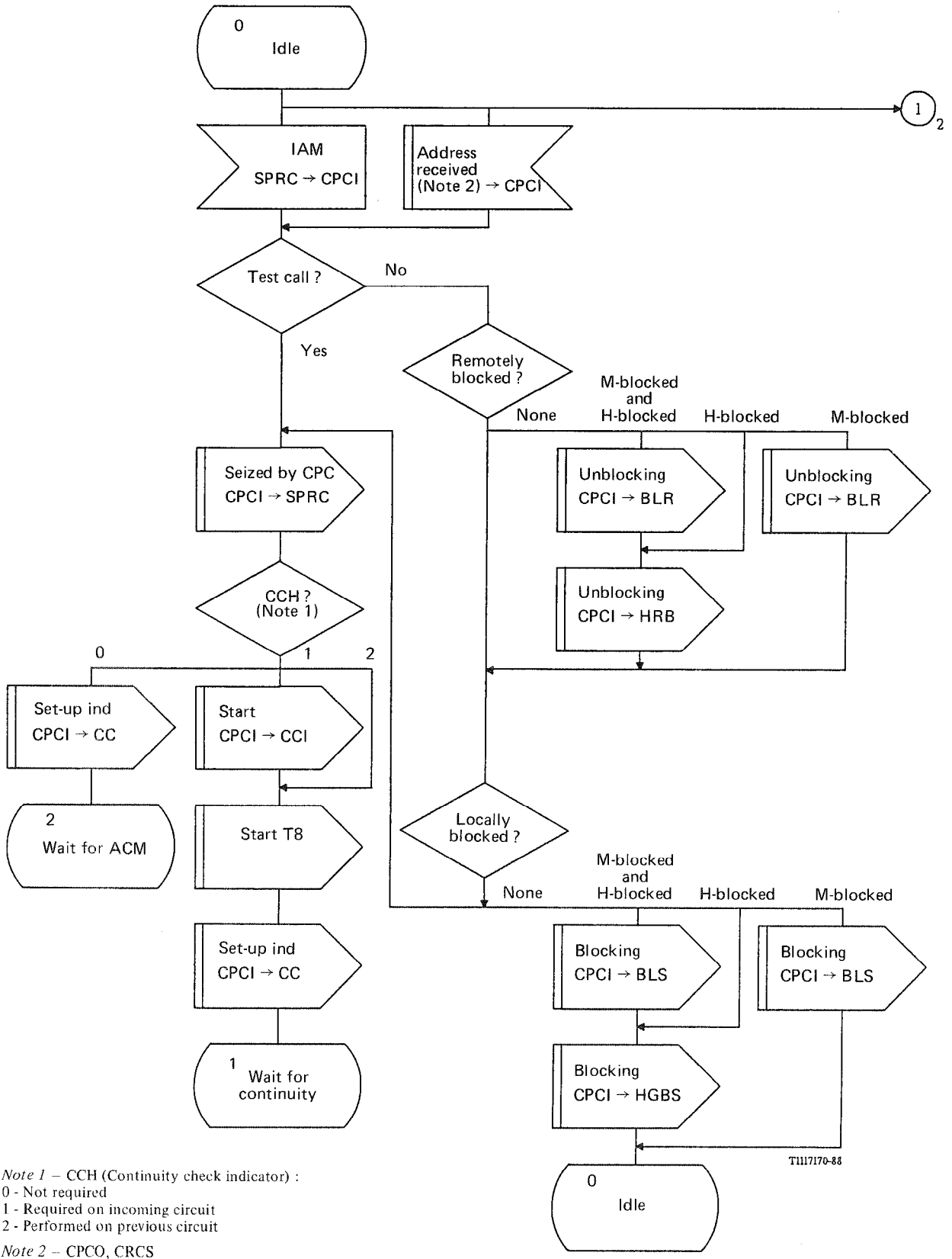

Note 1 – CCH (Continuity check indicator) :
 0 - Not required
 1 - Required on incoming circuit
 2 - Performed on previous circuit
 Note 2 – CPCO, CRCS

FIGURE B-21/Q.764 (sheet 1 of 18)
Call processing control incoming (CPCI)

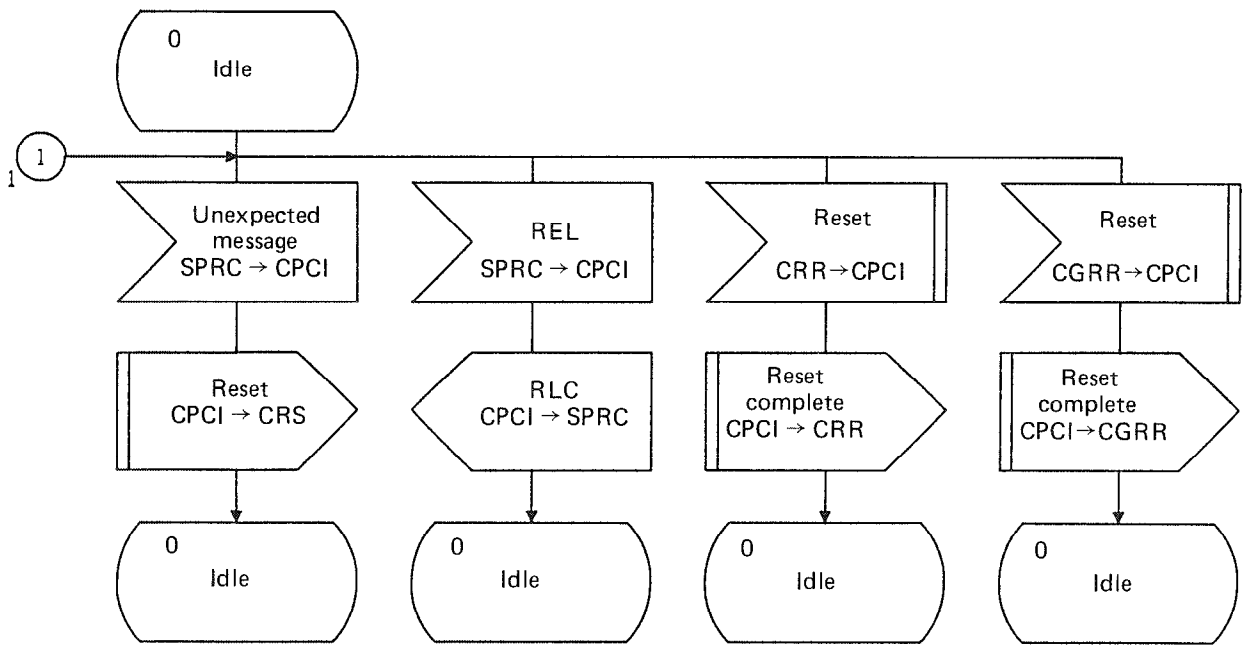

T1117180-88

FIGURE B-21/Q.764 (sheet 2 of 18)
Call processing control incoming (CPCI)

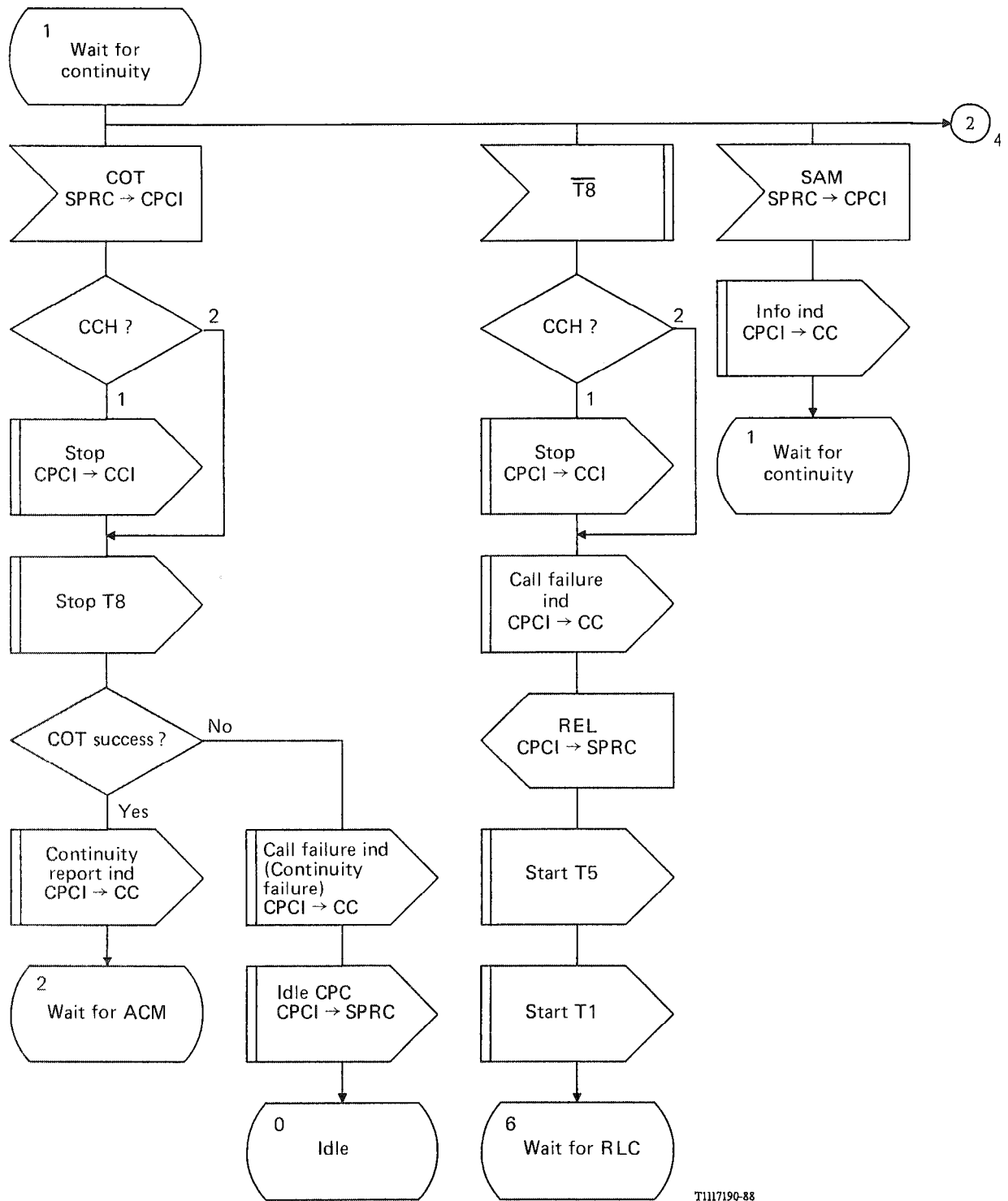

T1117190-88

FIGURE B-21/Q.764 (sheet 3 of 18)
Call processing control incoming (CPCI)

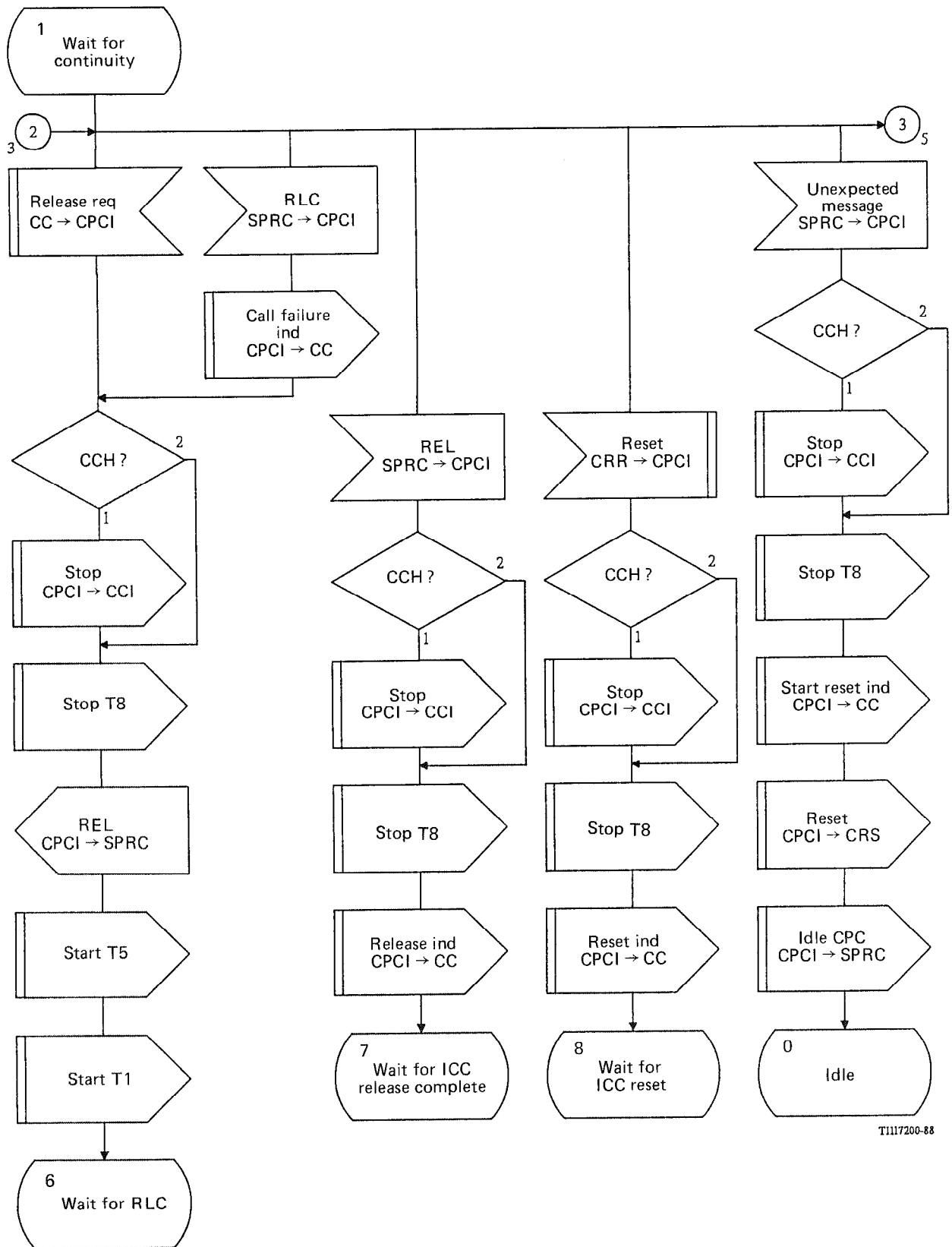

T1117200-88

FIGURE B-21/Q.764 (sheet 4 of 18)
Call processing control incoming (CPCI)

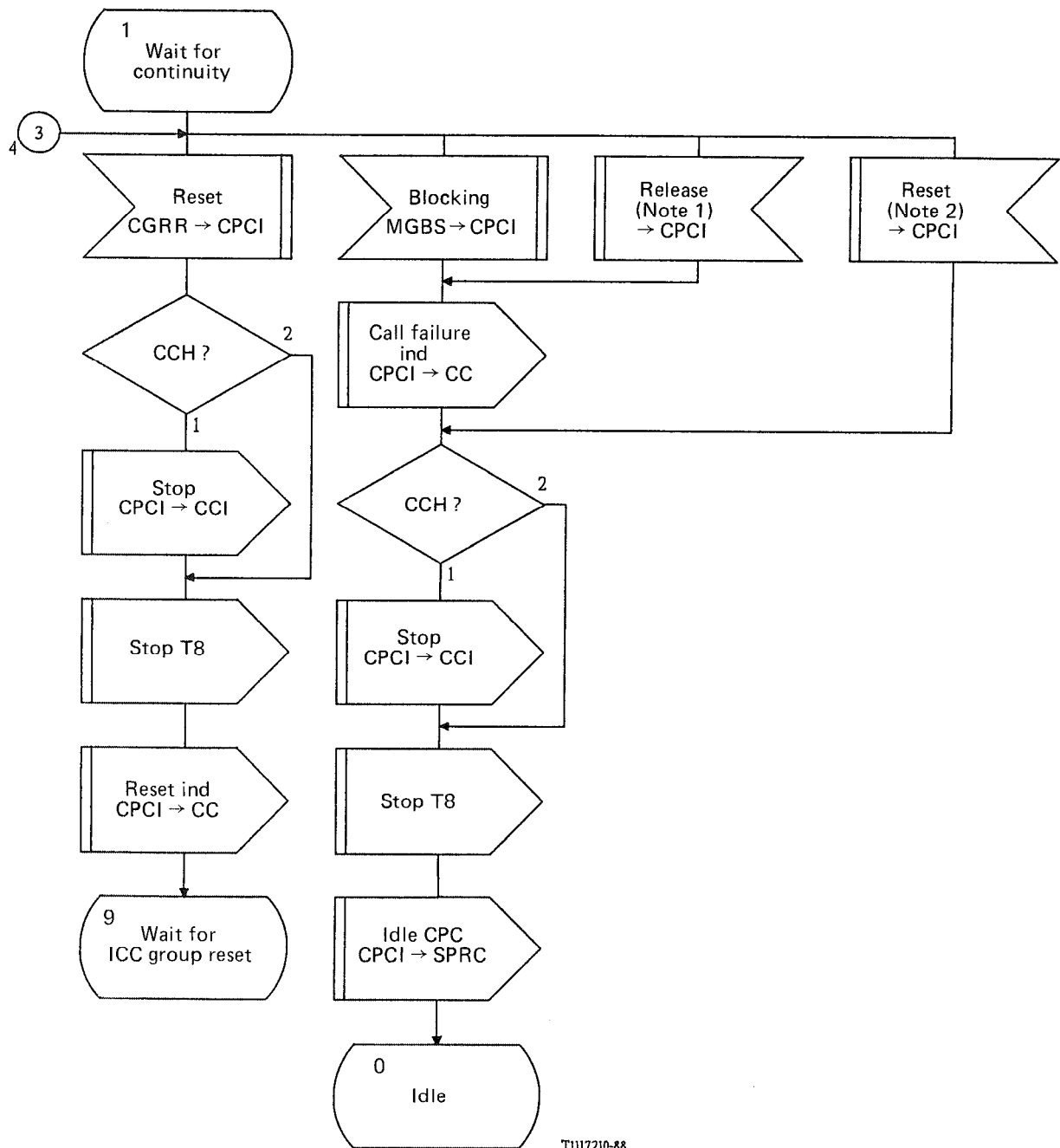

T1117210-88

Note 1 – HGBS, HGBR.
 Note 2 – CRS, CGRS.

FIGURE B-21/Q.764 (sheet 5 of 18)
Call processing control incoming (CPCI)

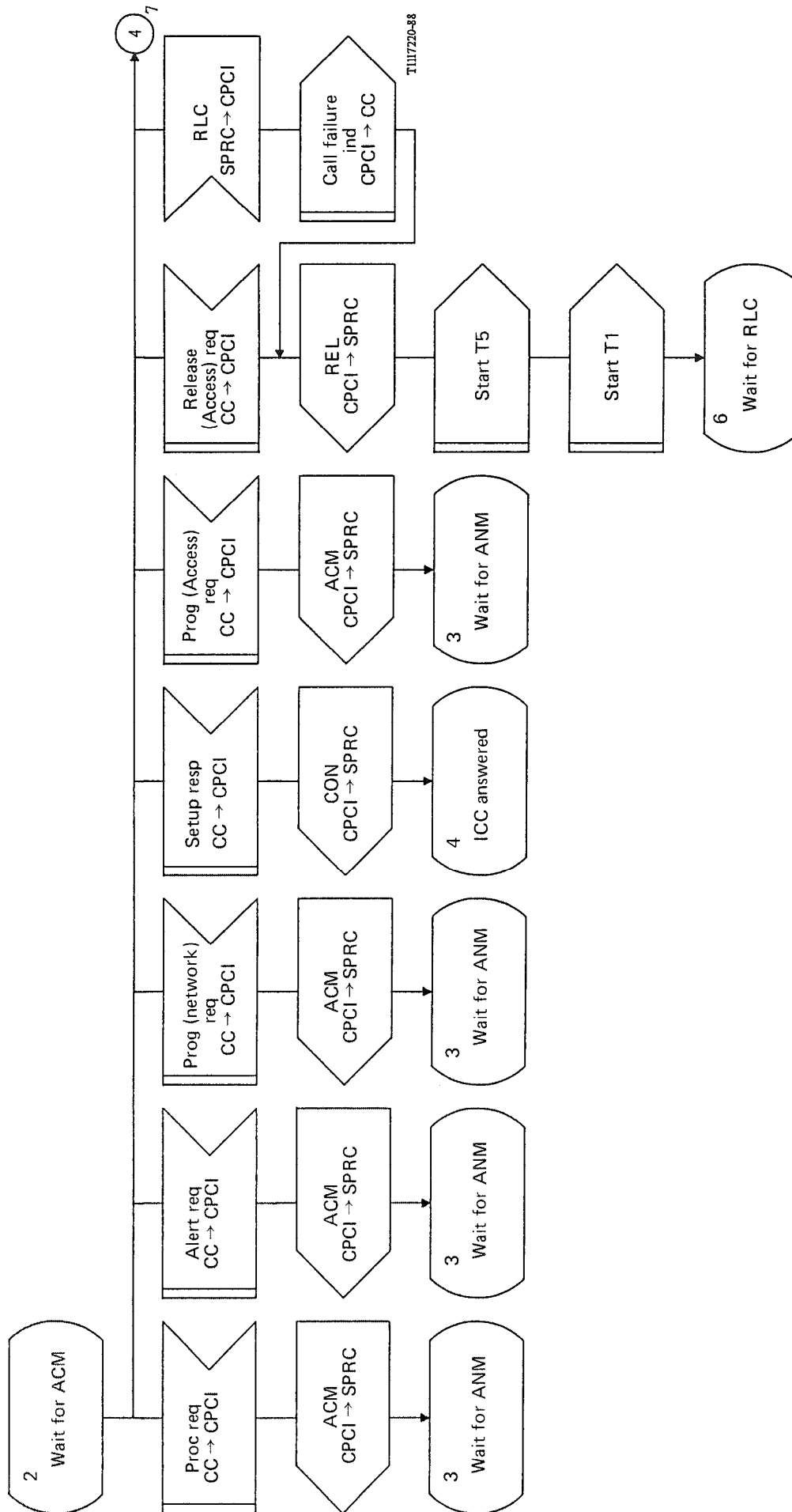
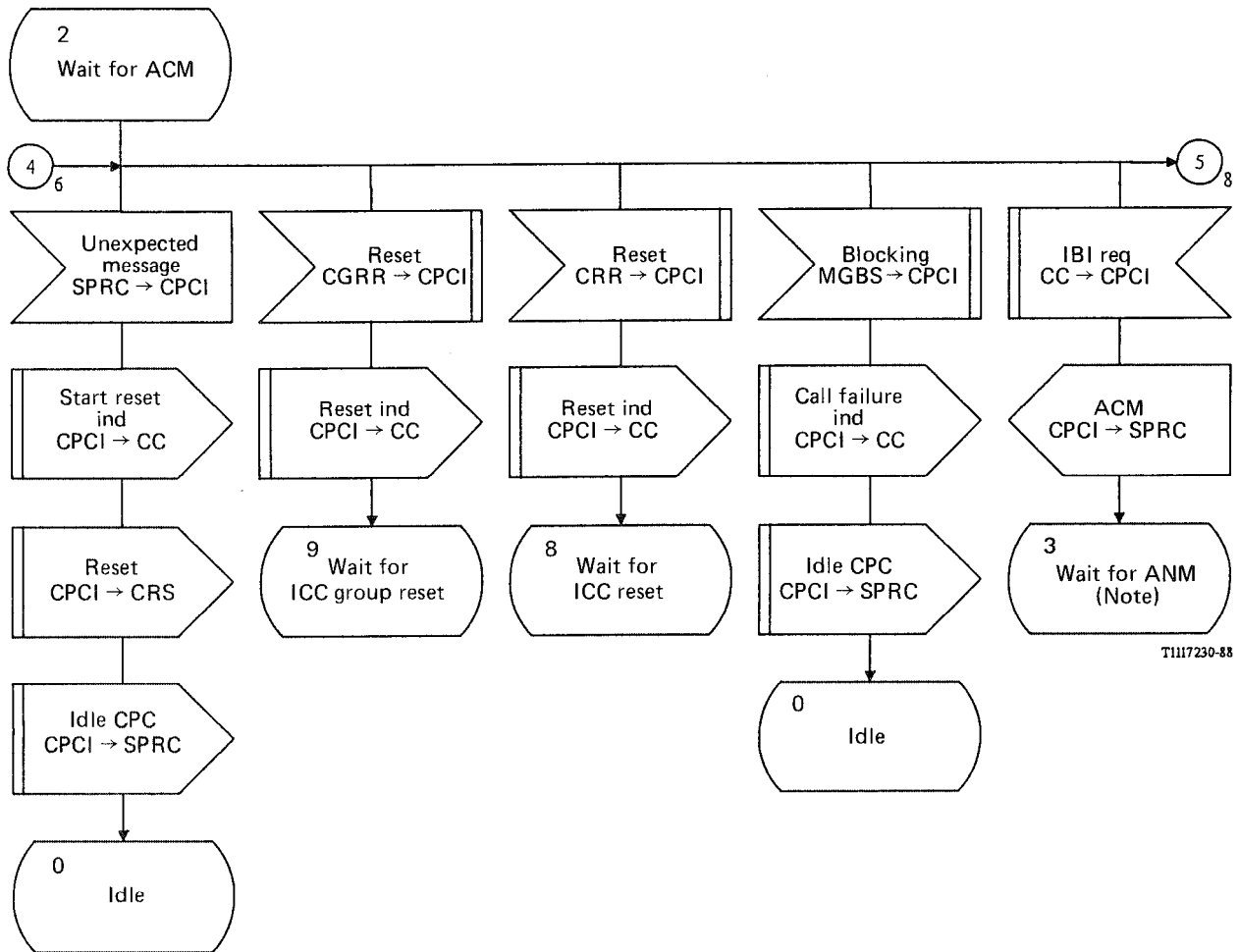
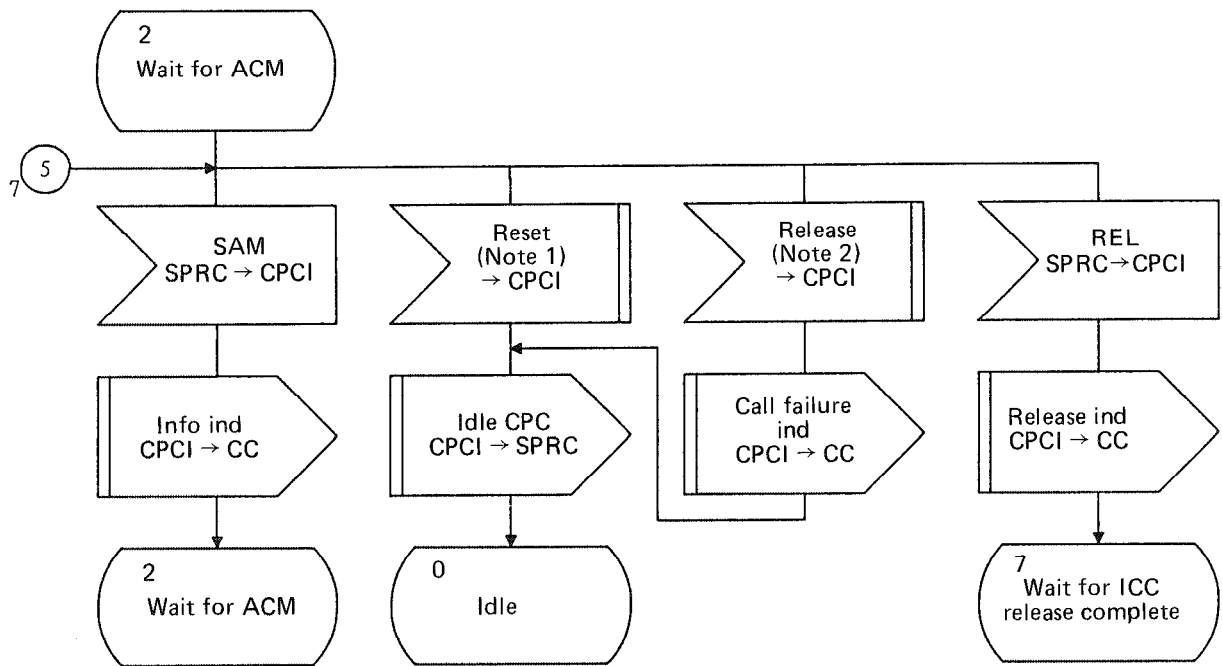

FIGURE B-21/Q.764 (sheet 6 of 18)
Call processing control incoming (CPCI)



Note – Only REL/RLC message is expected. Other messages are discarded.

FIGURE B-21/Q.764 (sheet 7 of 18)
Call processing control incoming (CPCI)



T1117240-88

Note 1 – CRS, CGRS.
 Note 2 – HGBS, HGBR.

FIGURE B-21/Q.764 (sheet 8 of 18)
Call processing control incoming (CPCI)

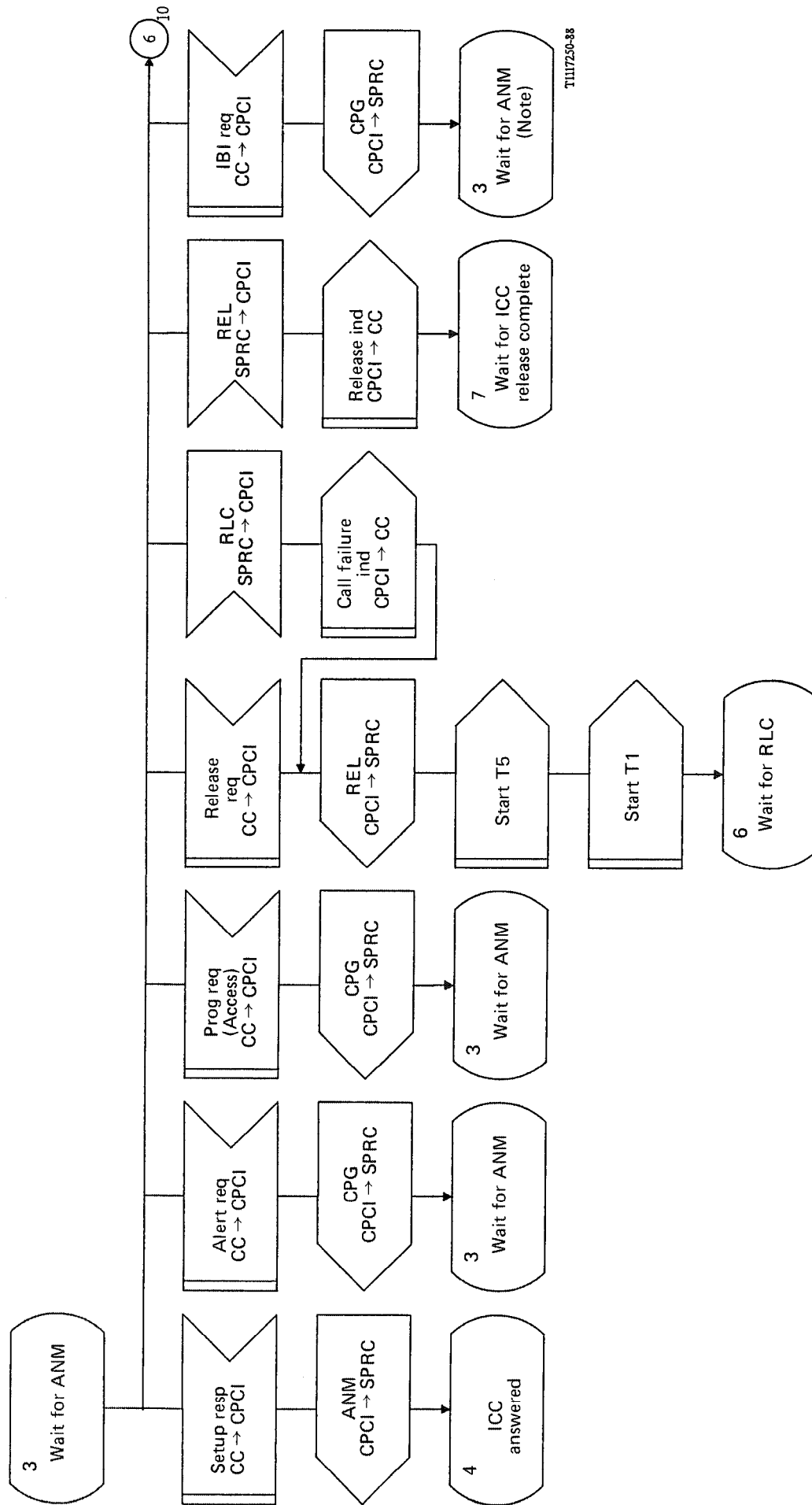

T1117250-88

Note — Only REL/RLC message is expected. Other messages are discarded.

FIGURE B-21/Q.764 (sheet 9 of 18)
Call processing control incoming (CPCI)

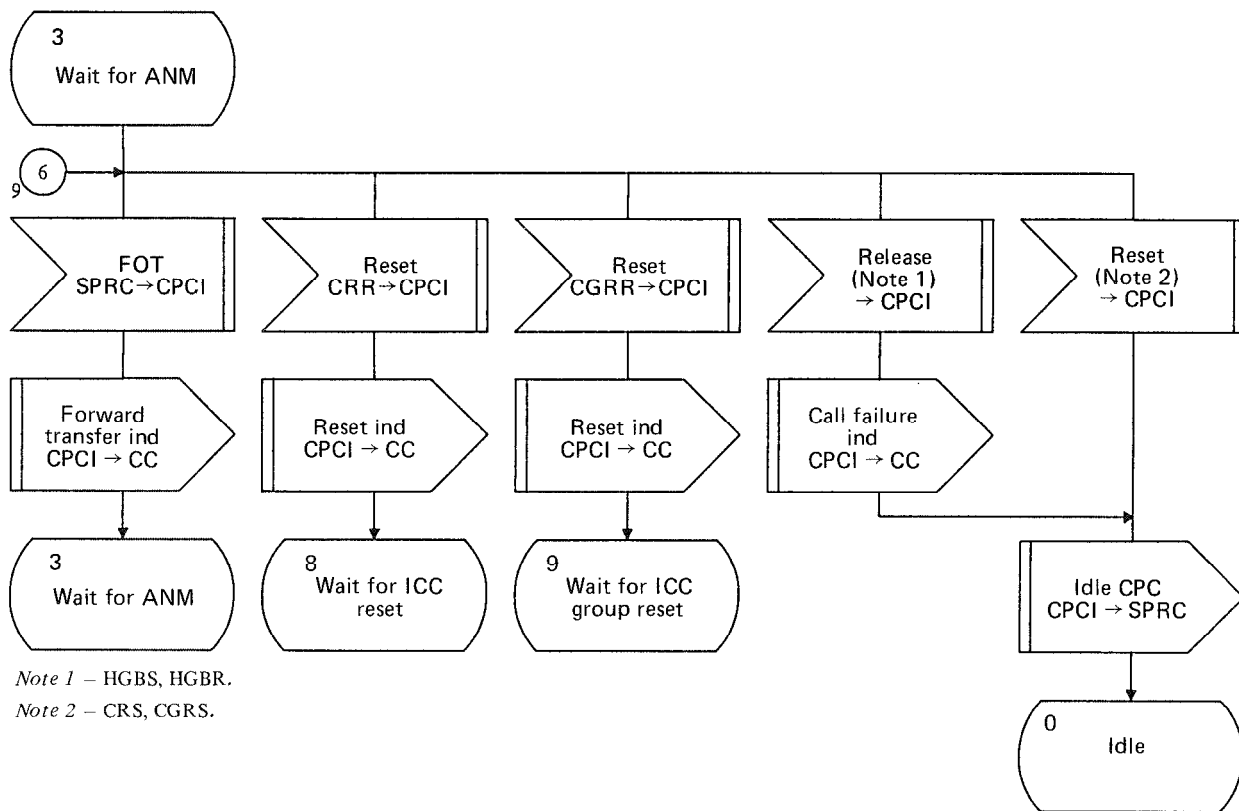

T1117260-88

FIGURE B-21/Q.764 (sheet 10 of 18)
Call processing control incoming (CPCI)

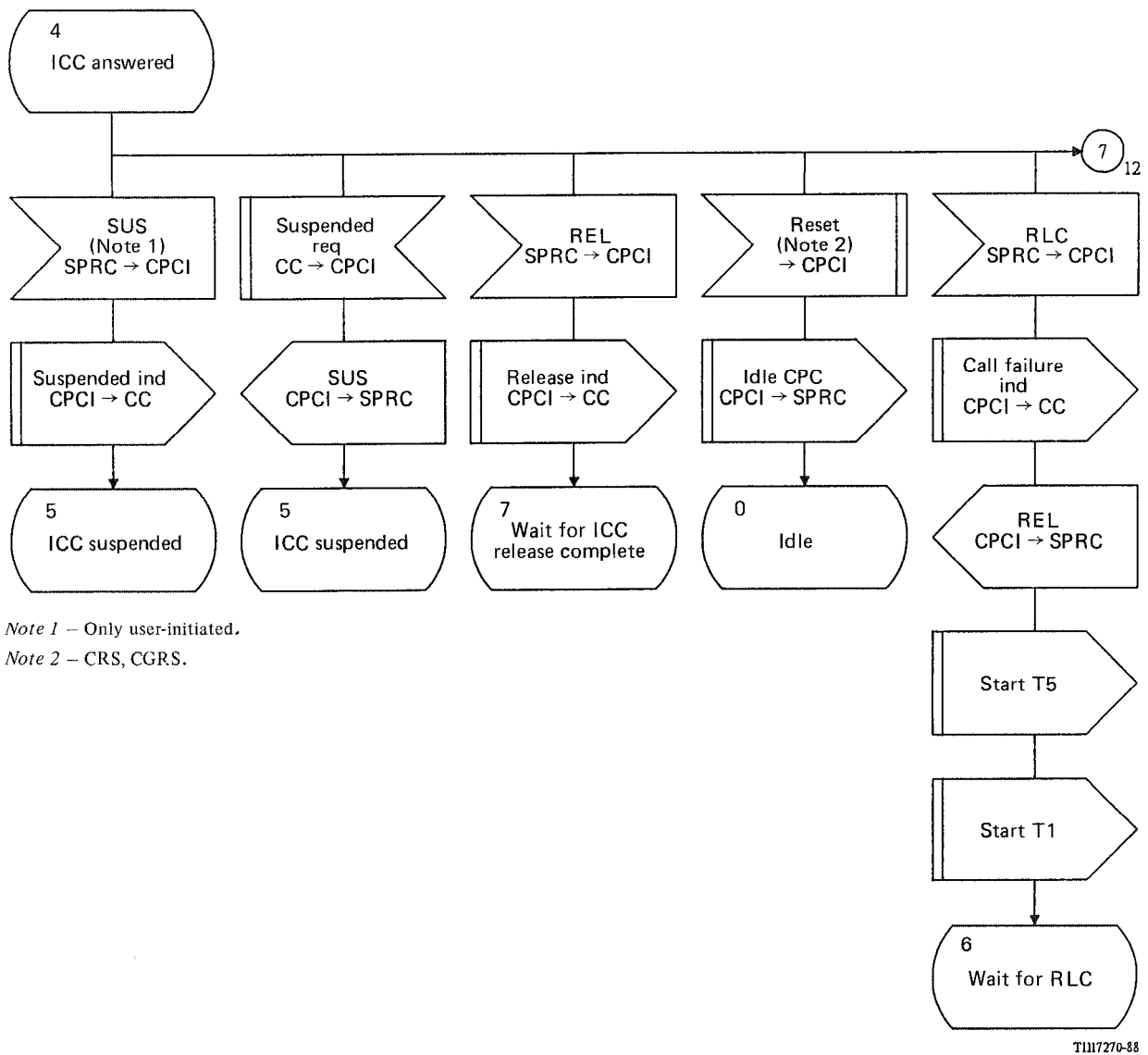

FIGURE B-21/Q.764 (sheet 11 of 18)
Call processing control incoming (CPCI)

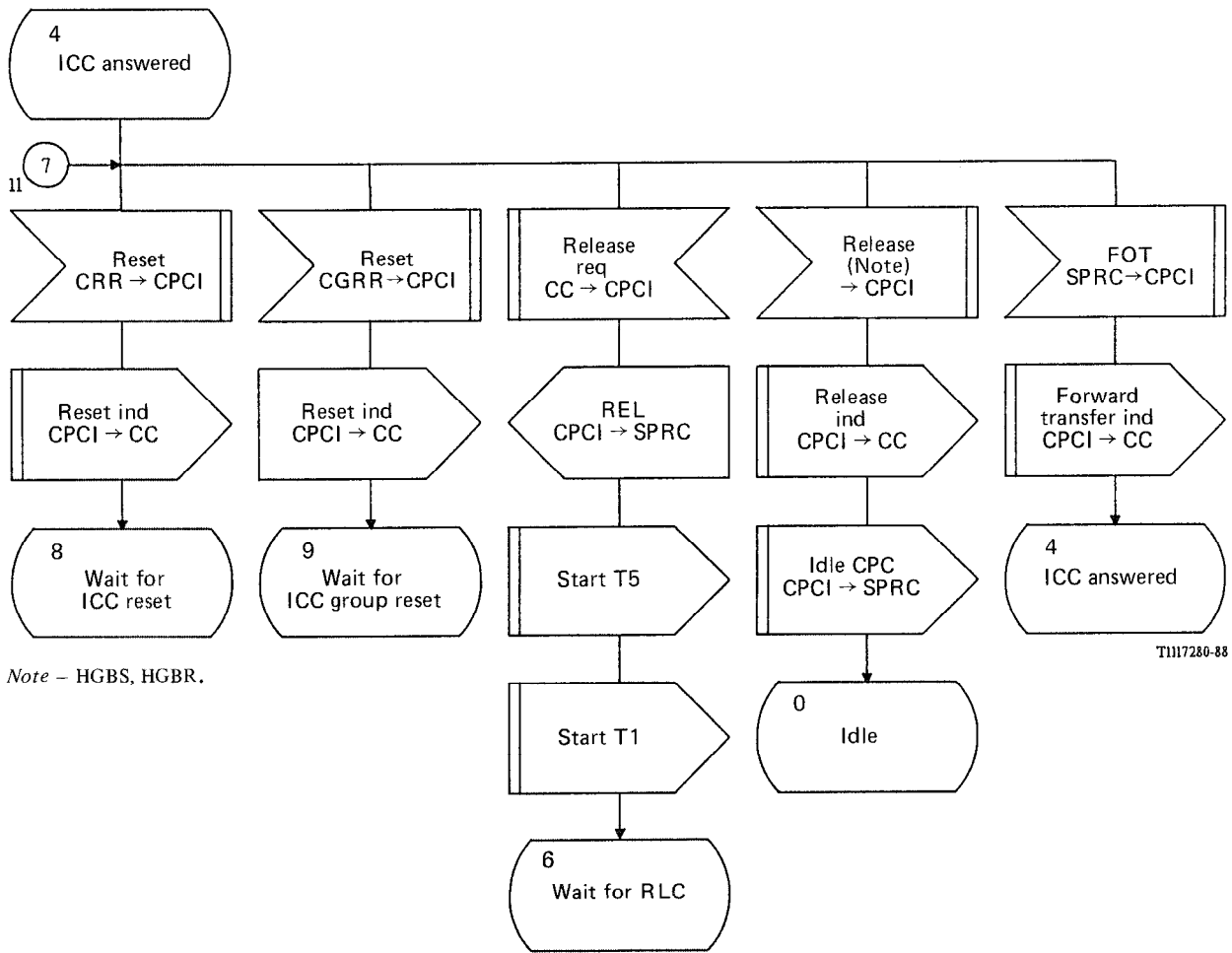
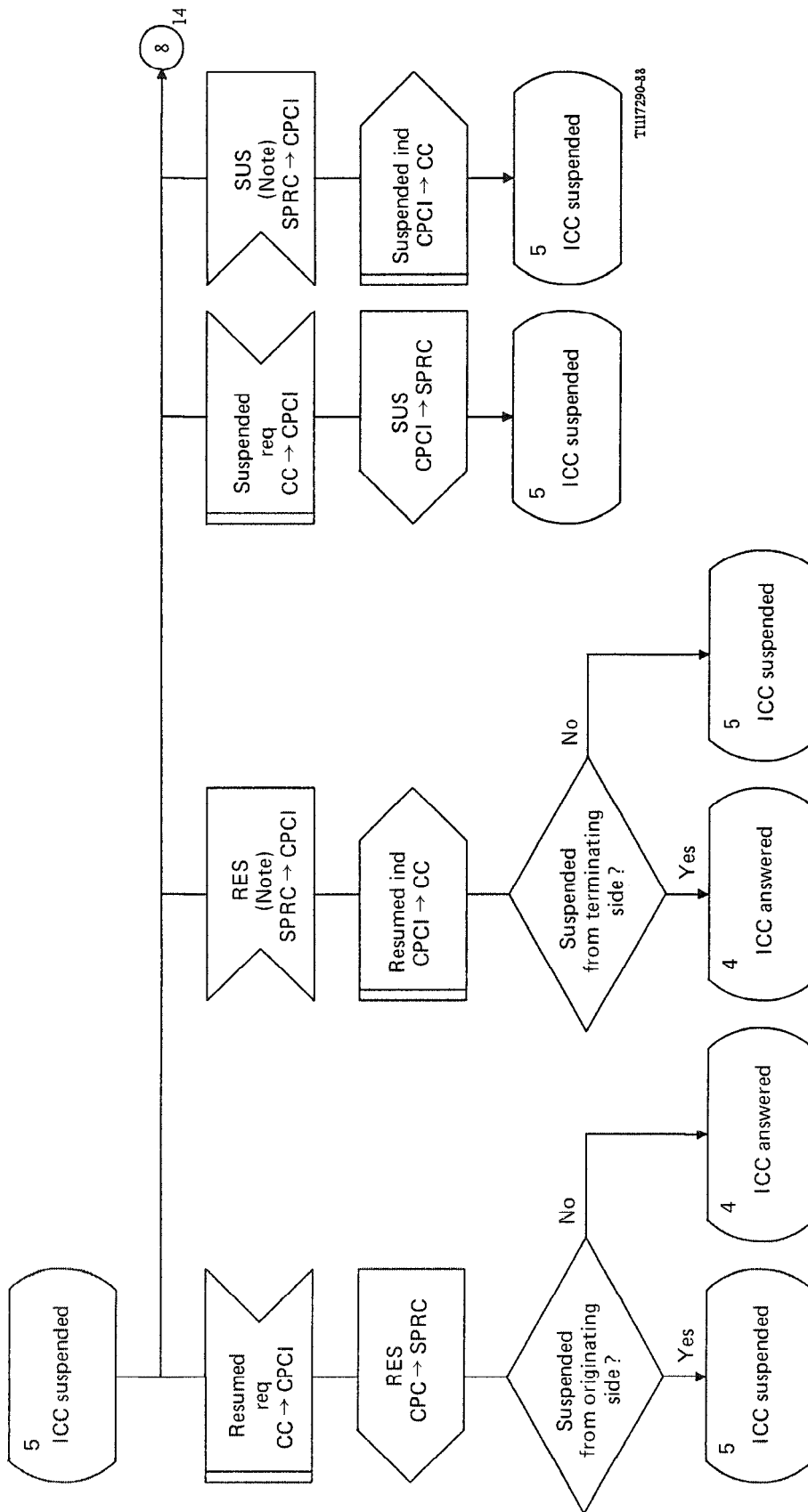

FIGURE B-21/Q.764 (sheet 12 of 18)
Call processing control incoming (CPCI)



T1117290-88

Note - Only user-initiated.

FIGURE B-21/Q.764 (sheet 13 of 18)
Call processing control incoming (CPCI)

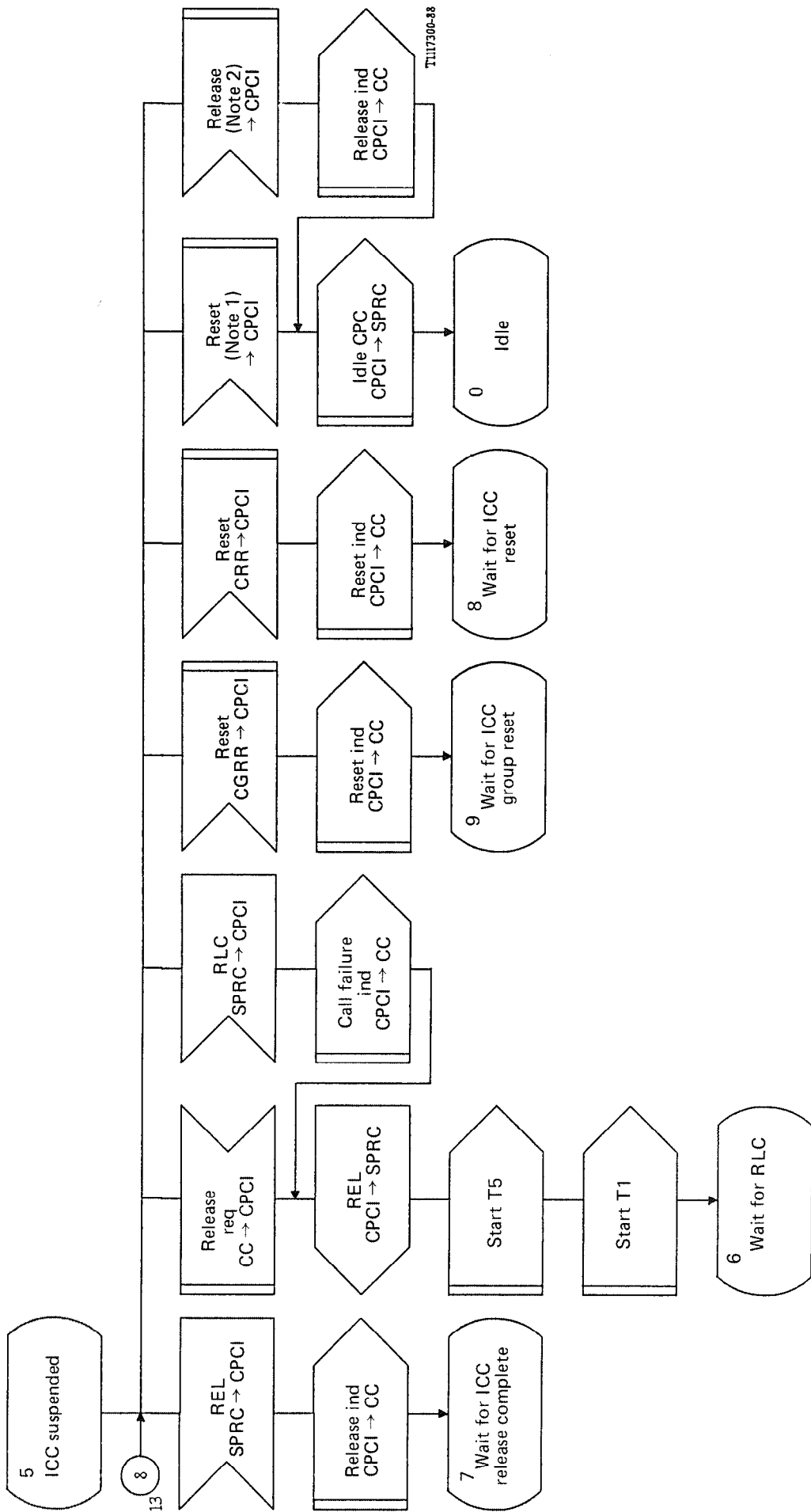

Note 1 – CRS, CGRS.
 Note 2 – HGBS, HGBR.

FIGURE B-21/Q.764 (sheet 14 of 18)
 Call processing control incoming (CPCI)

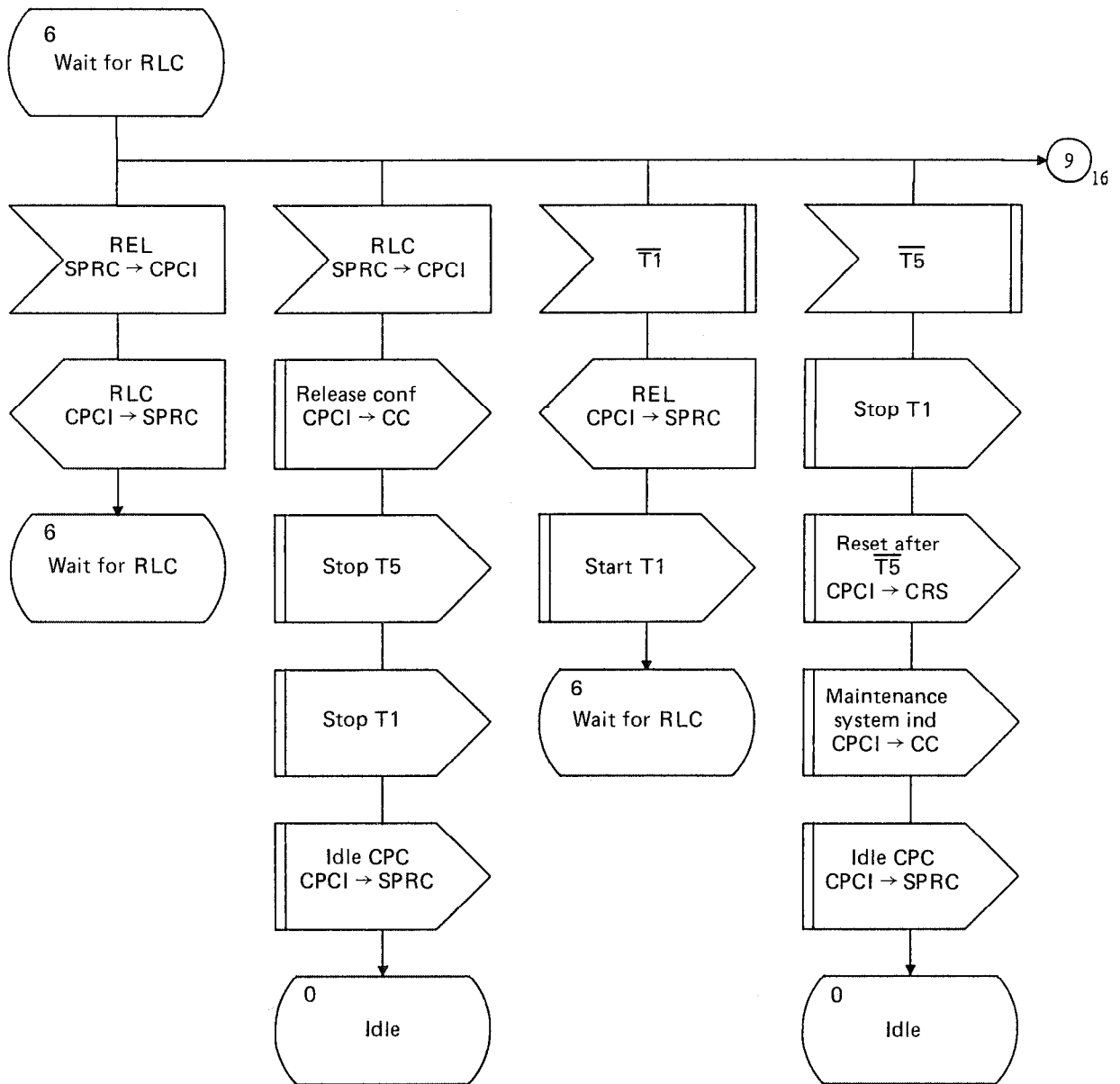

T1117310-88

FIGURE B-21/Q.764 (sheet 15 of 18)
Call processing control incoming (CPCI)

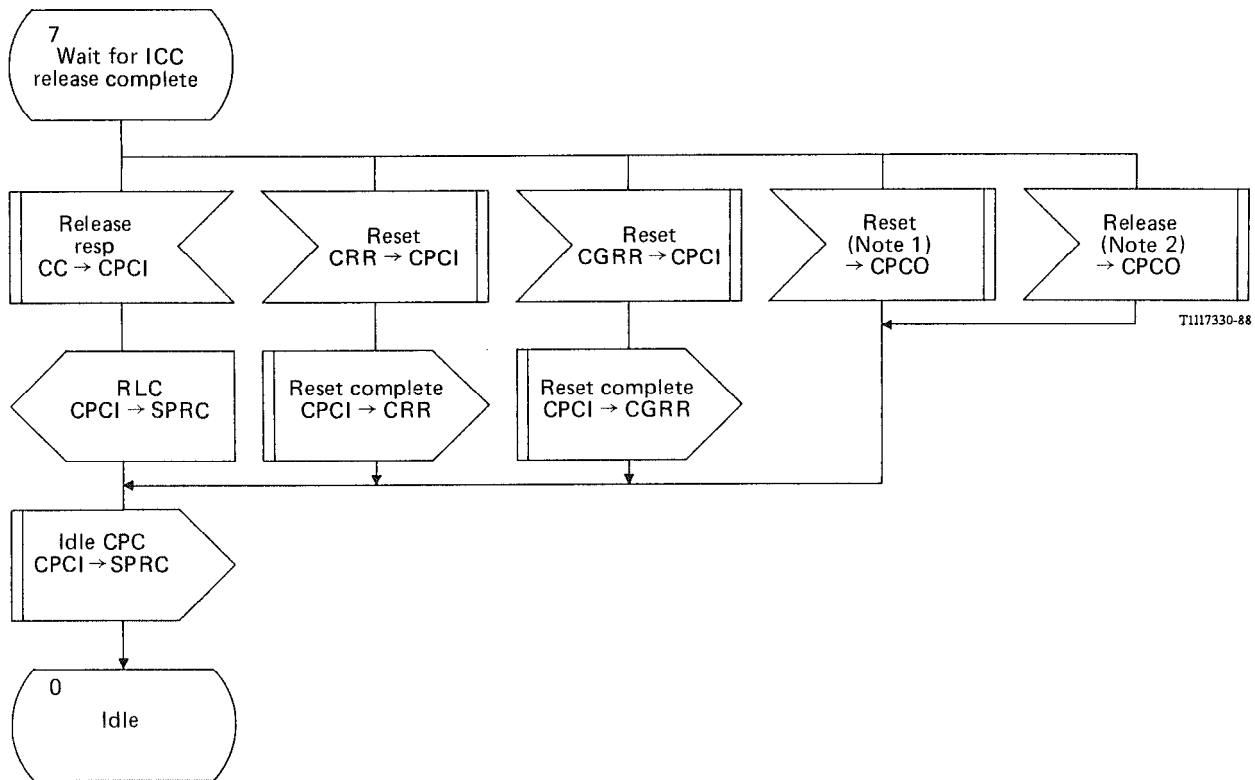

Note 1 – CRS, CGRS.
 Note 2 – HGBS, HGBR.

FIGURE B-21/Q.764 (sheet 17 of 18)
Call processing control incoming (CPCI)

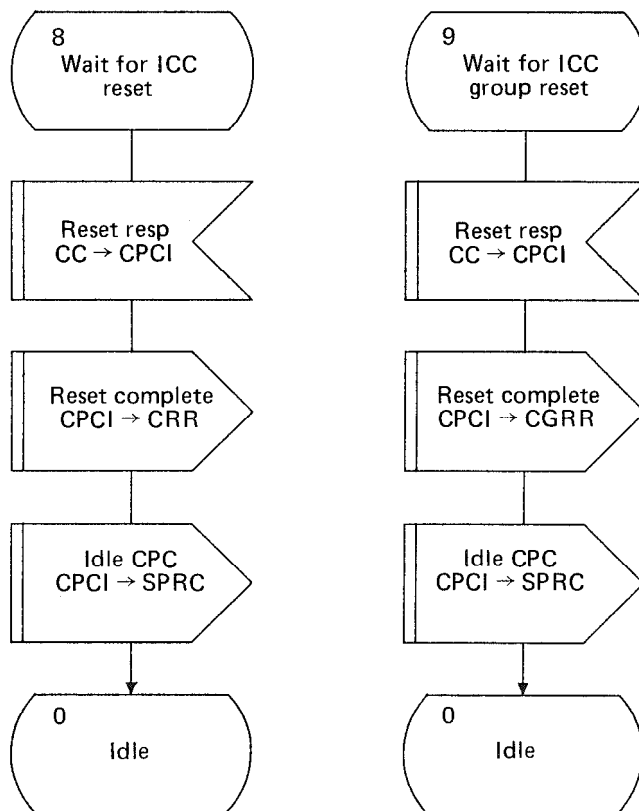

T1117340-88

FIGURE B-21/Q.764 (sheet 18 of 18)
Call processing control incoming (CPCI)

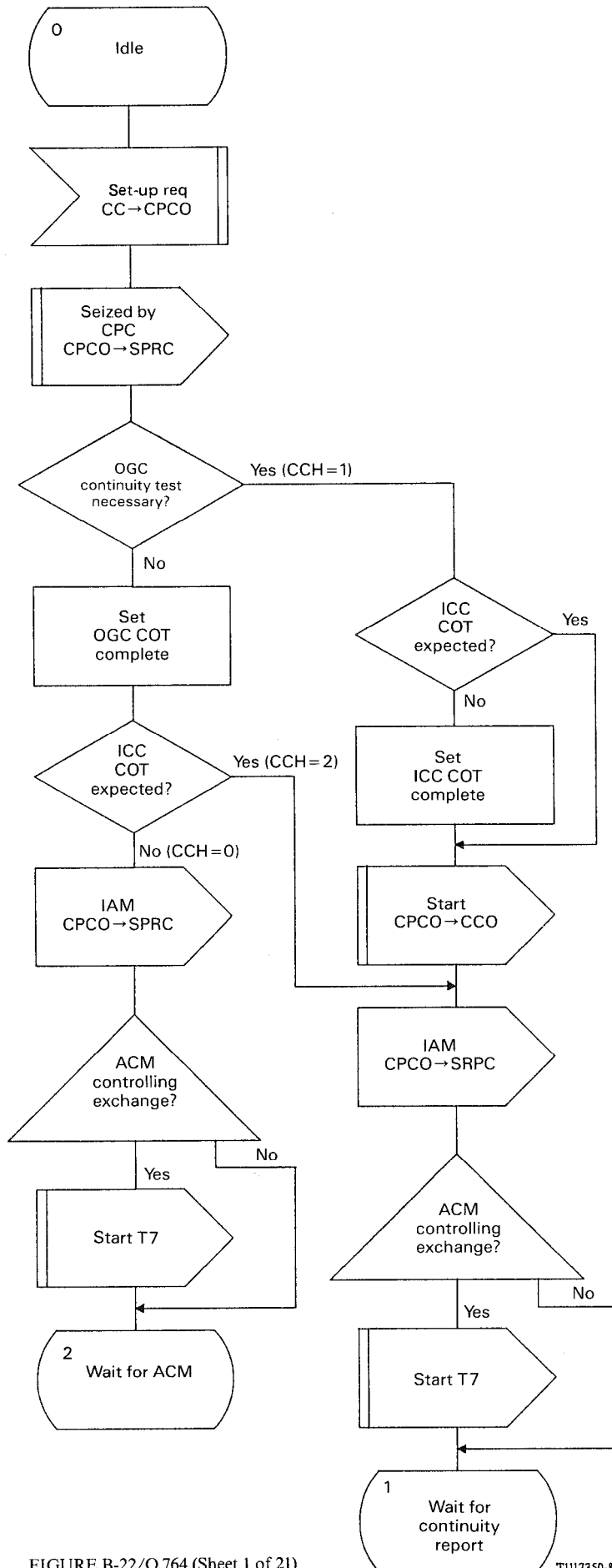
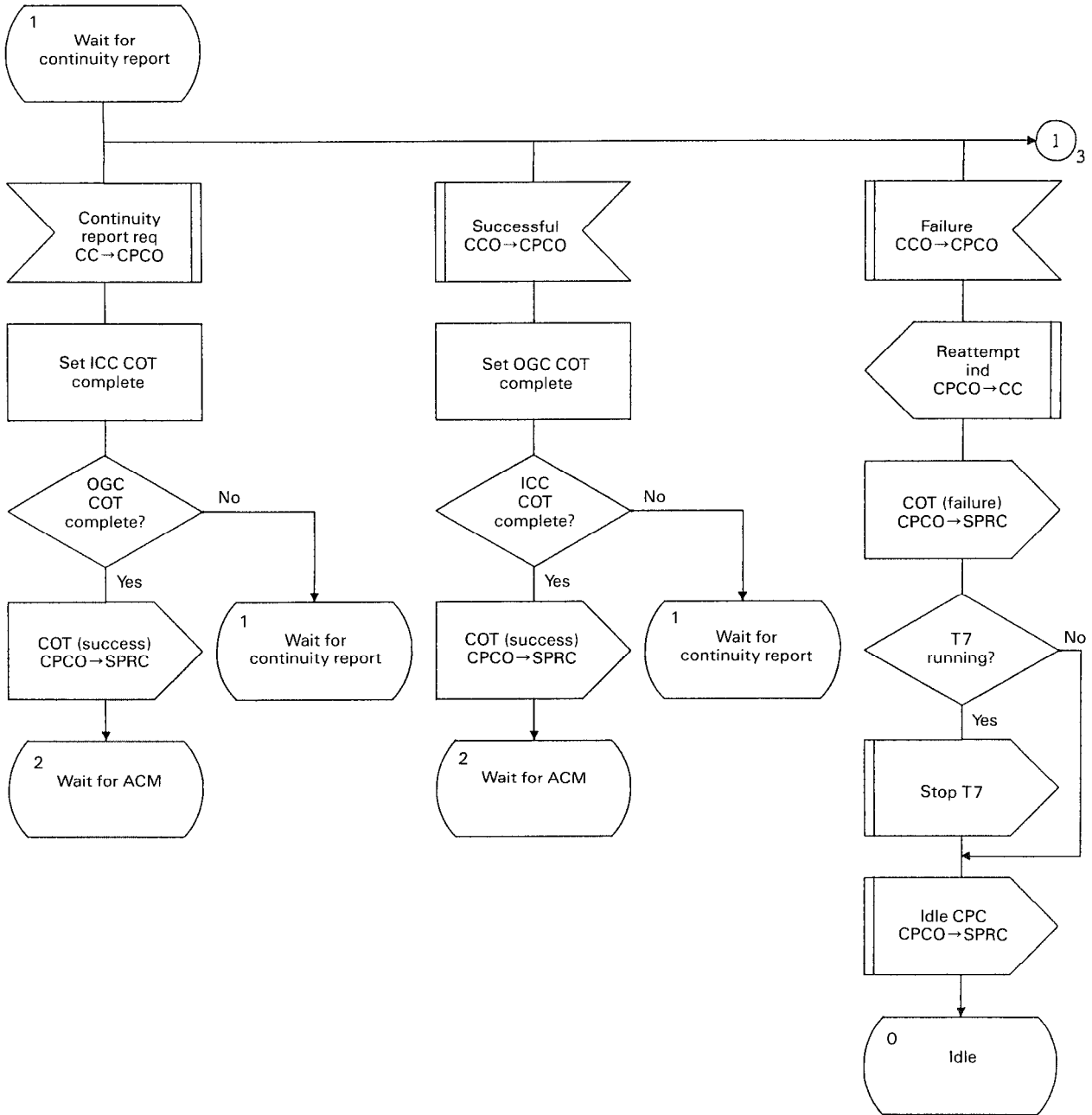

FIGURE B-22/Q.764 (Sheet 1 of 21)

T1117350-88

Call Processing Control Outgoing (CPCO)



T1117360-88

FIGURE B-22/Q.764 (Sheet 2 of 21)
Call Processing Control Outgoing (CPCO)

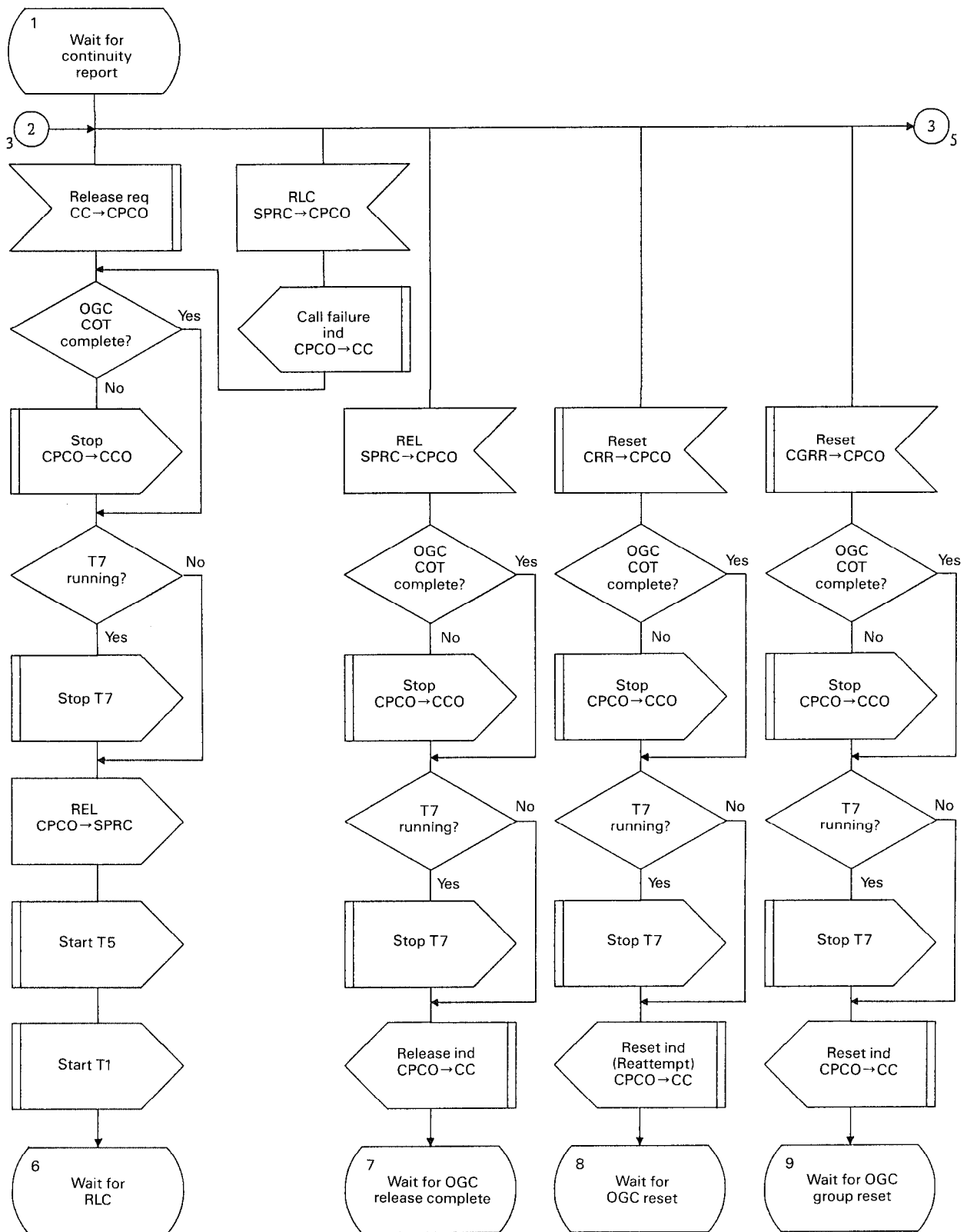

T1117380-88

FIGURE B-22/Q.764 (Sheet 4 of 21)
Call Processing Control Outgoing (CPCO)

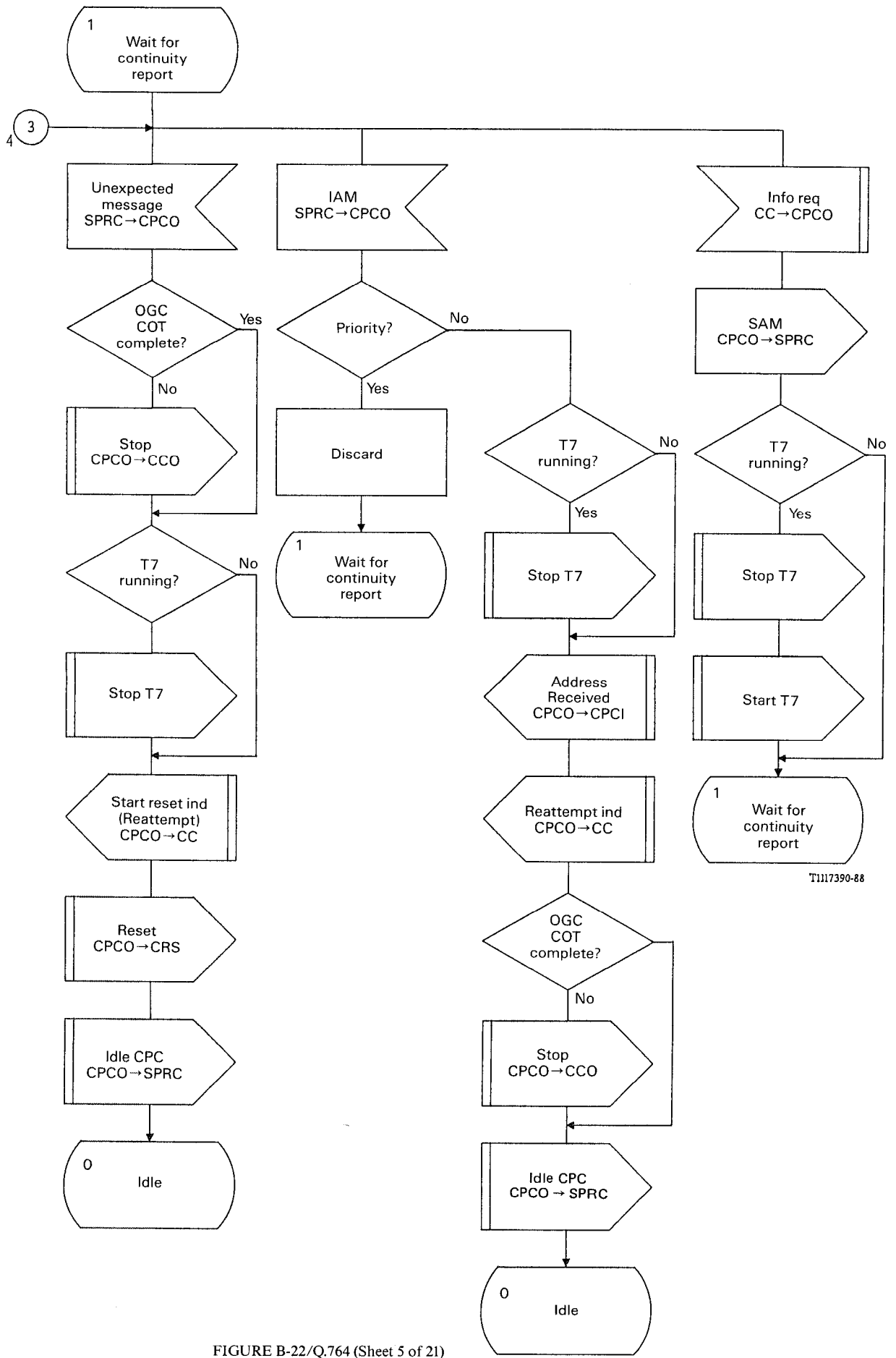

T1117390-88

FIGURE B-22/Q.764 (Sheet 5 of 21)

Call Processing Control Outgoing (CPCO)

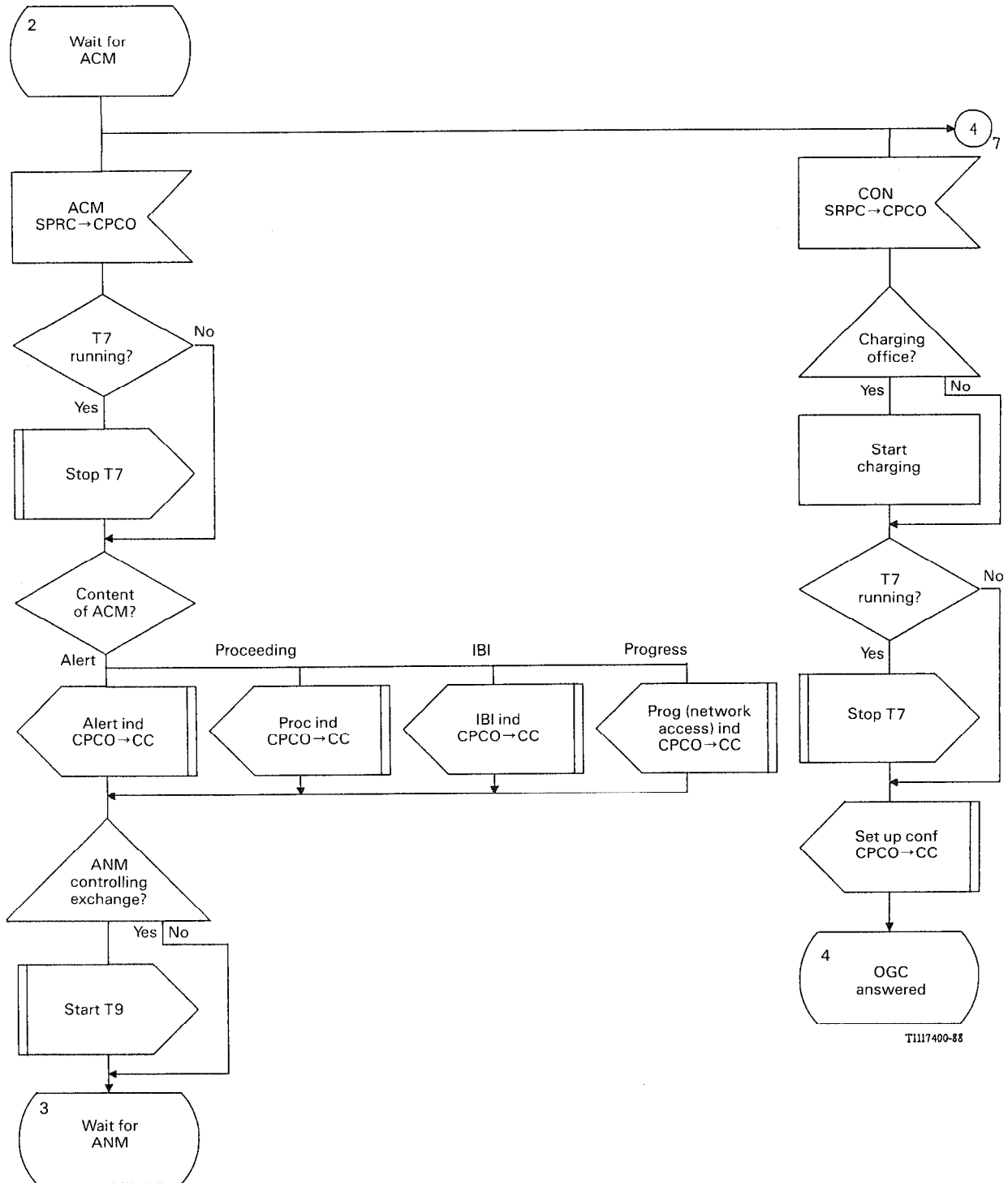

T1117400-88

FIGURE B-22/Q.764 (Sheet 6 of 21)
 Call Processing Control Outgoing (CPCO)

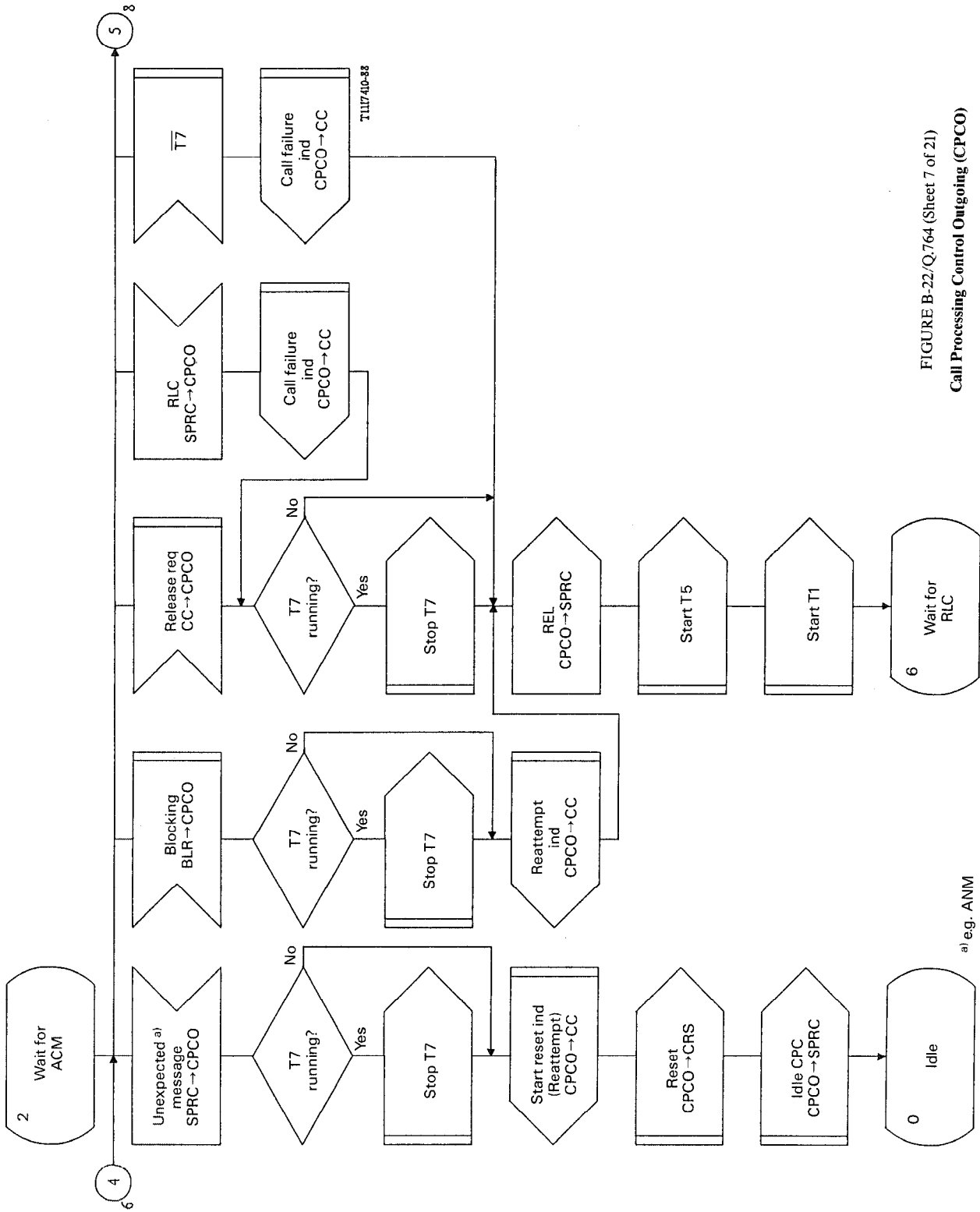

FIGURE B-22/Q.764 (Sheet 7 of 21)
Call Processing Control Outgoing (CPCO)

a) e.g. ANM

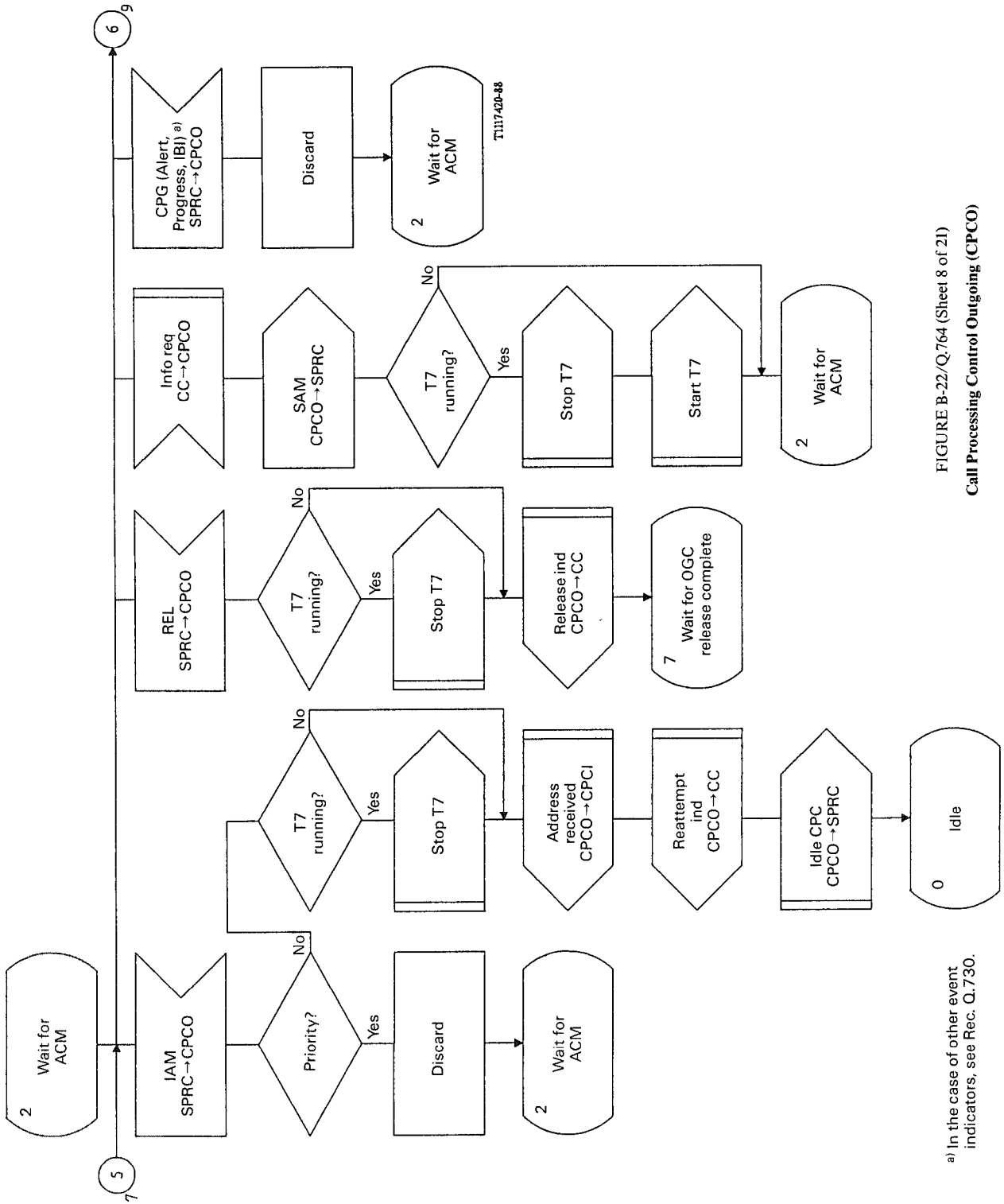
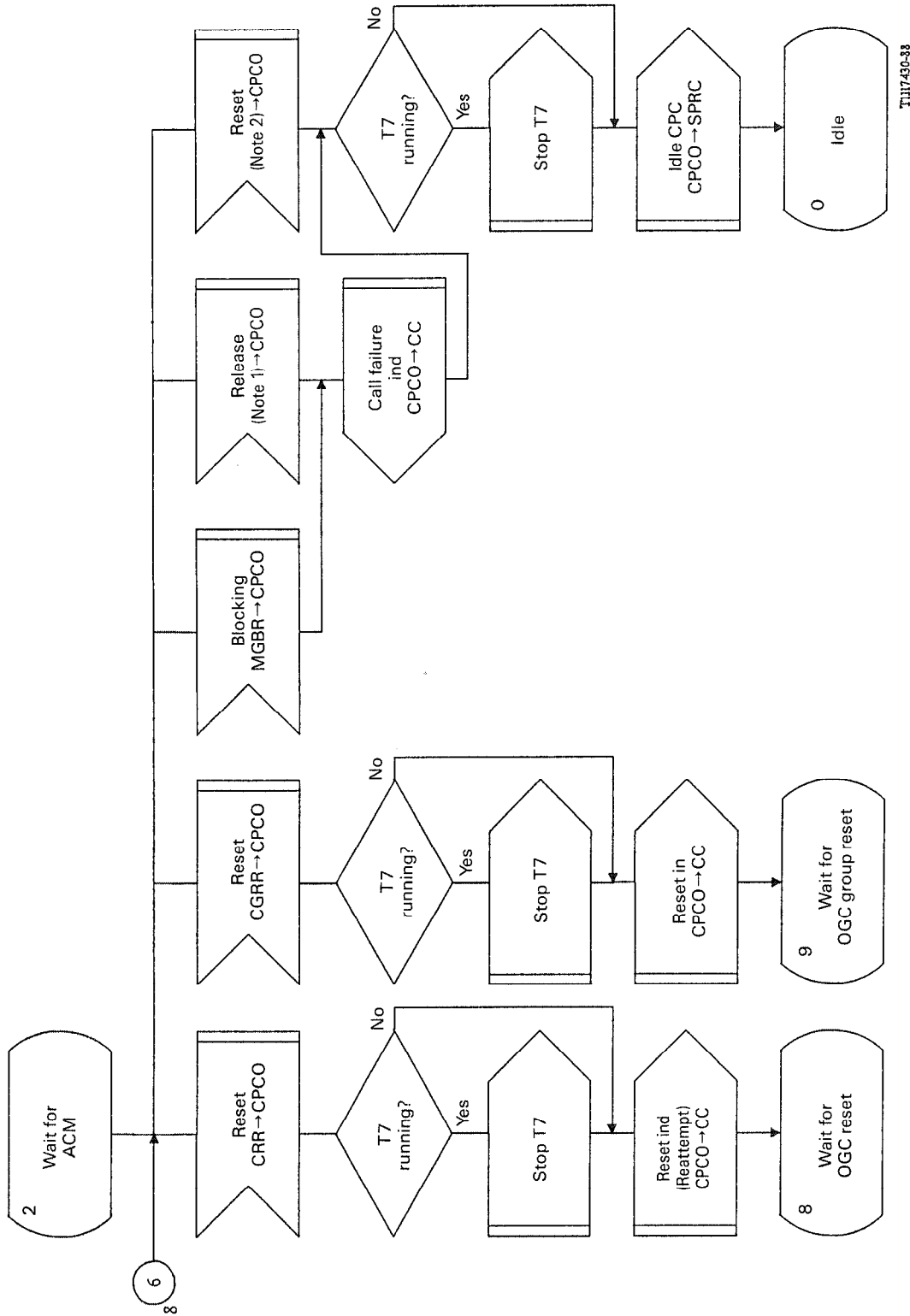

FIGURE B-22/Q.764 (Sheet 8 of 21)
Call Processing Control Outgoing (CPCO)

a) In the case of other event indicators, see Rec. Q.730.



TU17430-33

Note 1 – HGBS, HGBR.
 Note 2 – CRS, CGRS.

FIGURE B-22/Q.764 (Sheet 9 of 21)
 Call Processing Control Outgoing (CPCO)

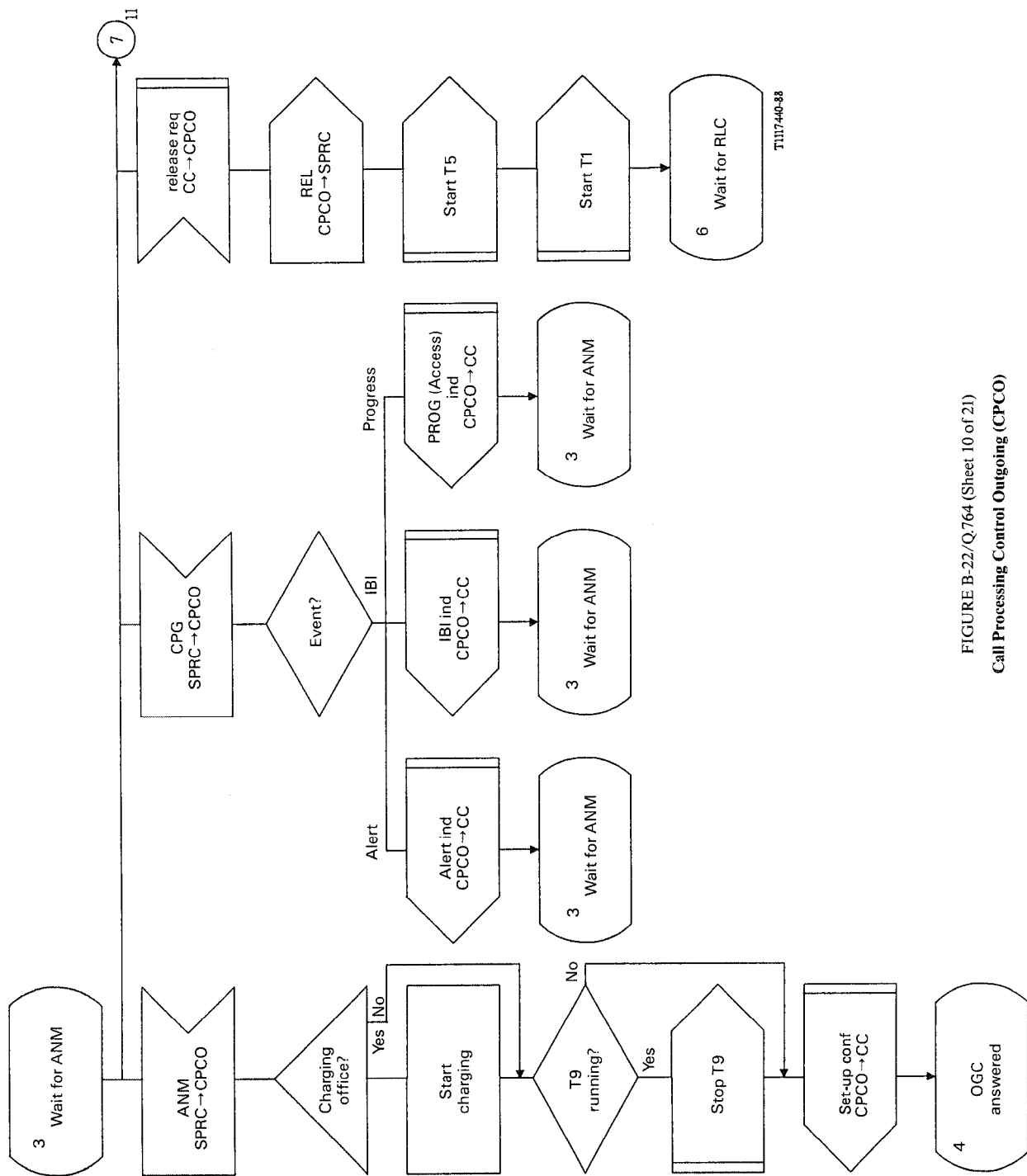
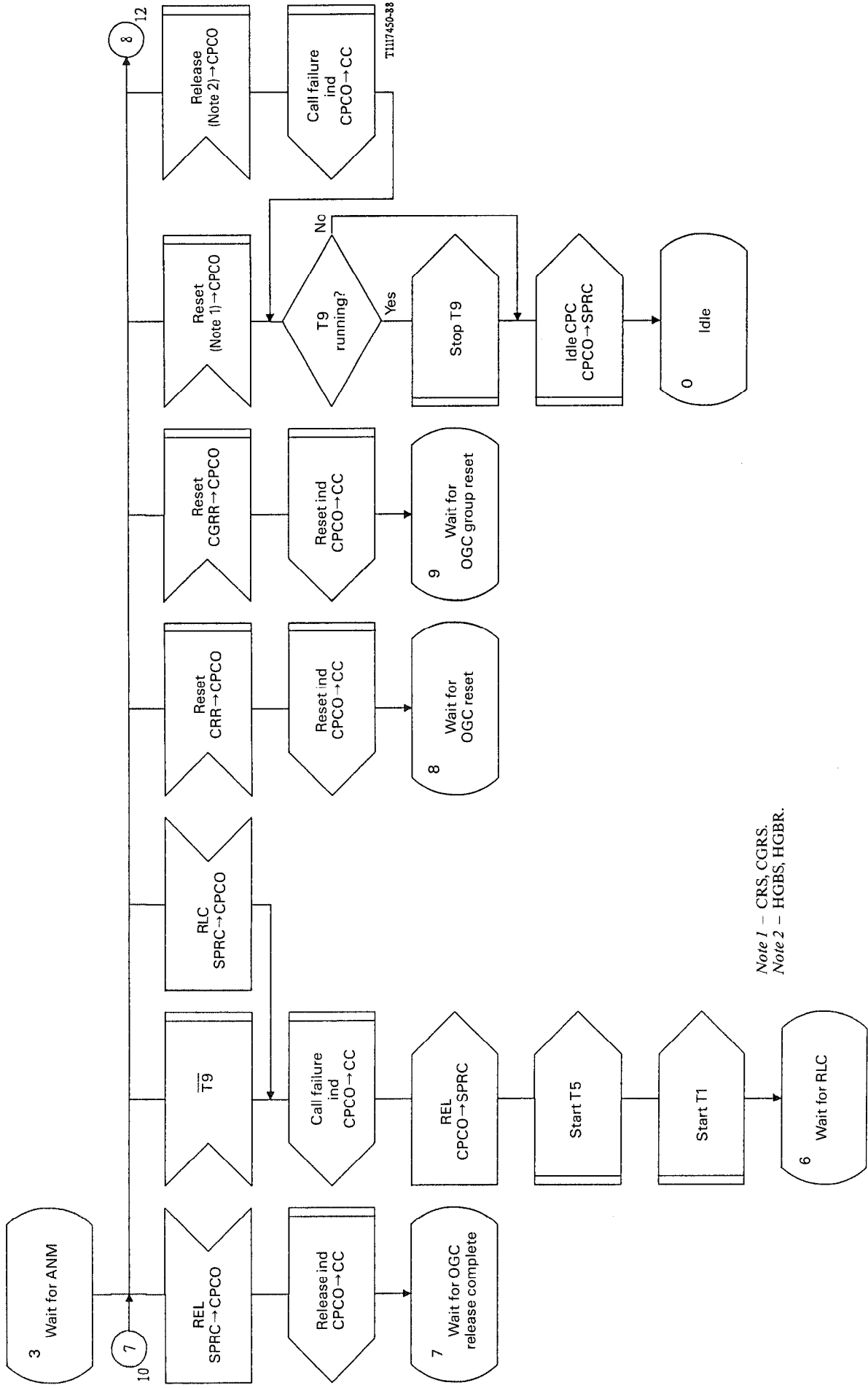

FIGURE B-22/Q.764 (Sheet 10 of 21)
Call Processing Control Outgoing (CPCO)



Note 1 - CRS, CGRS.
 Note 2 - HGBS, HGBR.

FIGURE B-22/Q.764 (Sheet 11 of 21)
 Call Processing Control Outgoing (CPCO)

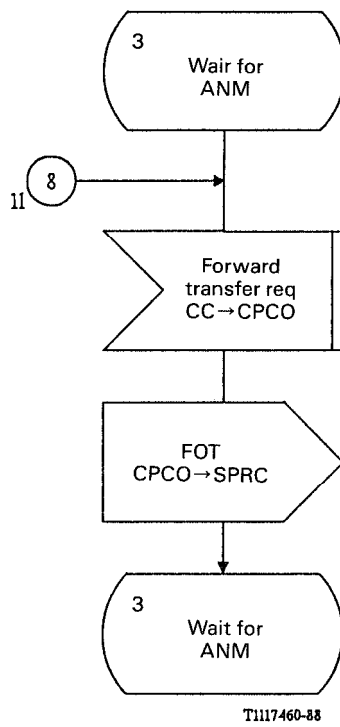

FIGURE B-22/Q.764 (Sheet 12 of 21)
Call Processing Control Outgoing (CPCO)

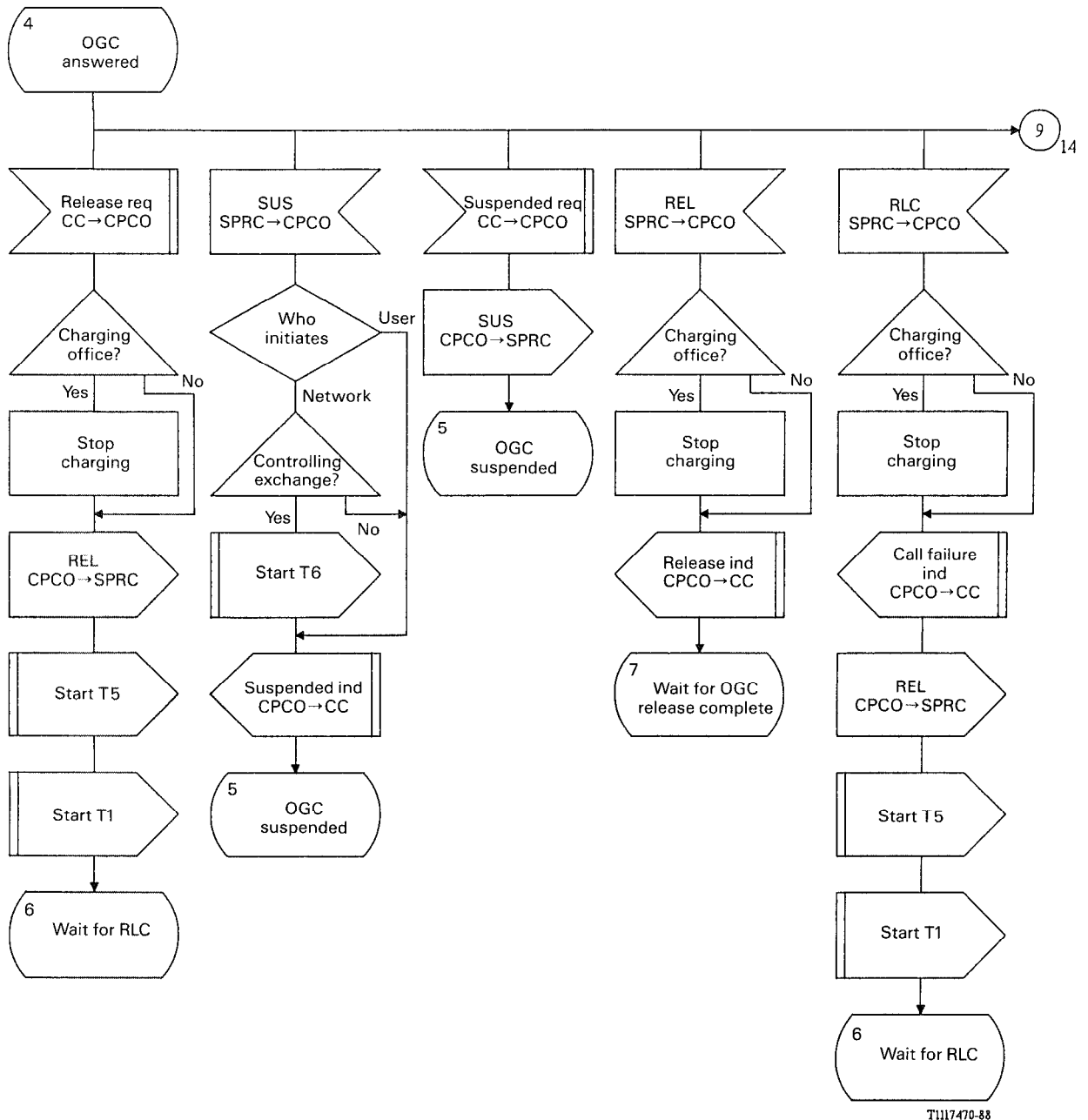
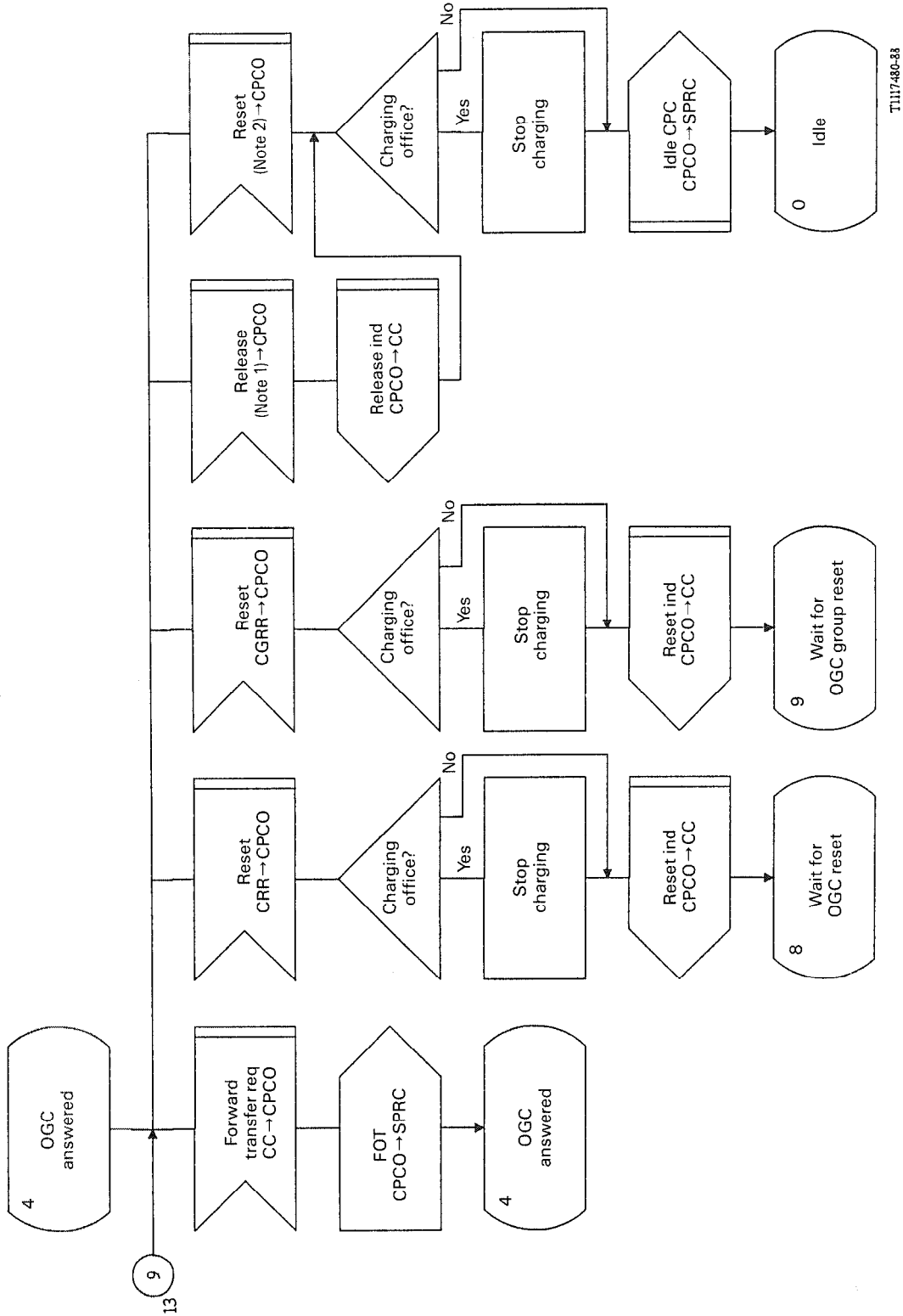

FIGURE B-22/Q.764 (Sheet 13 of 21)
Call Processing Control Outgoing (CPCO)



Note 1 – HGBS, HGBR.
 Note 2 – CRS, CGRS.

FIGURE B-22/Q.764 (Sheet 14 of 21)
 Call Processing Control Outgoing (CPCO)

T1117480-33

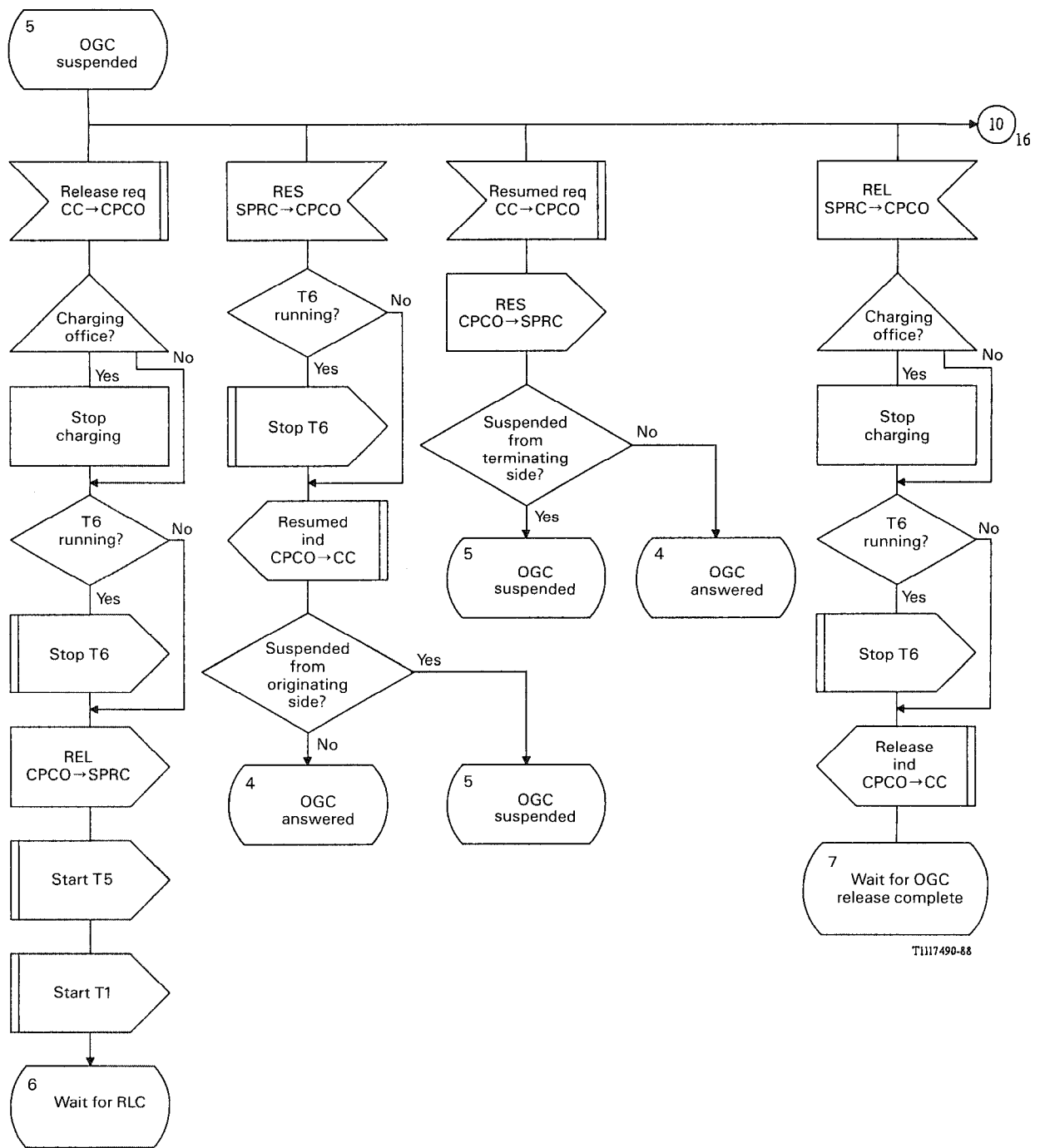
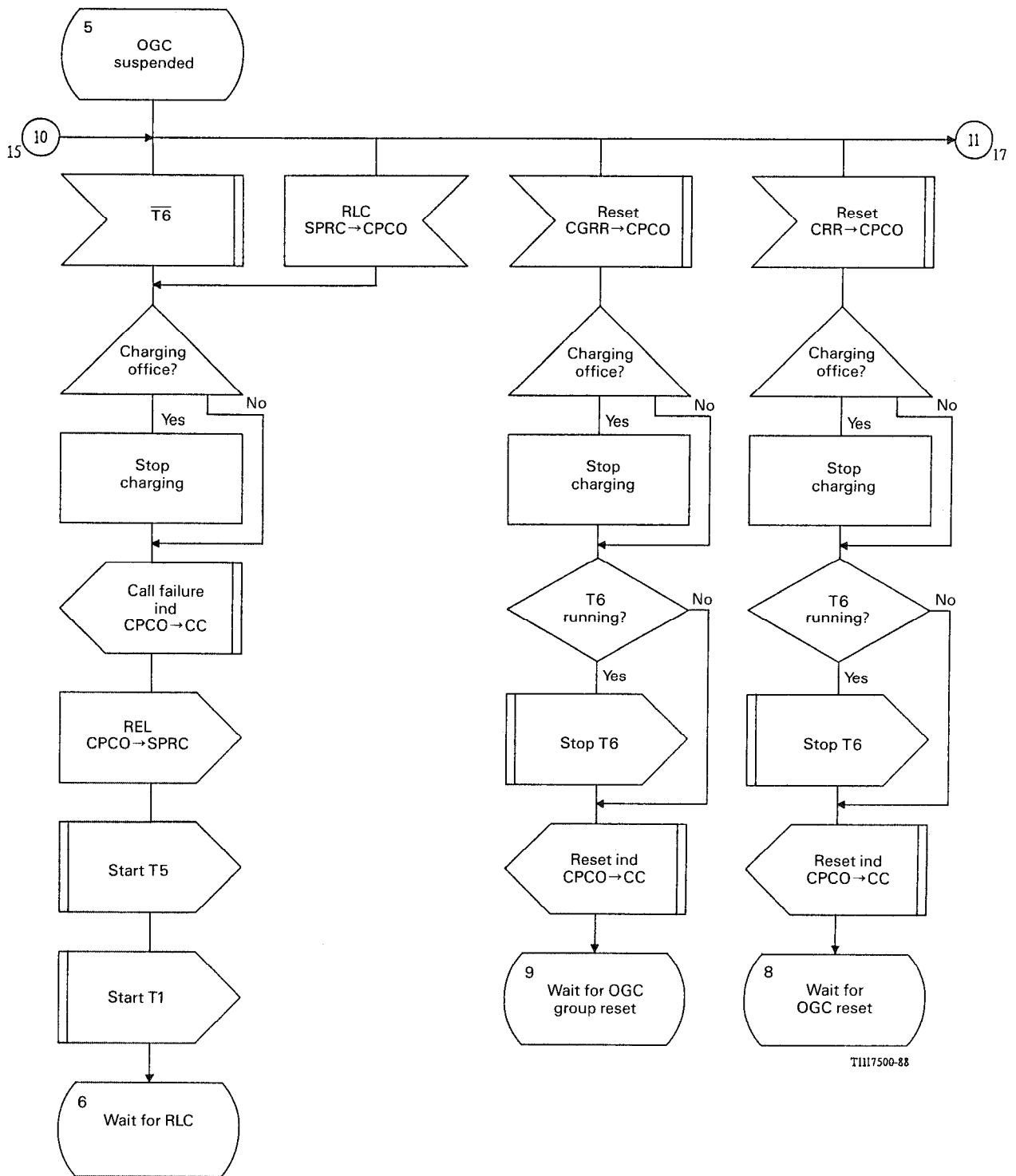

FIGURE B-22/Q.764 (Sheet 15 of 21)
Call Processing Control Outgoing (CPCO)



T1117500-88

FIGURE B-22/Q.764 (Sheet 16 of 21)
Call Processing Control Outgoing (CPCO)

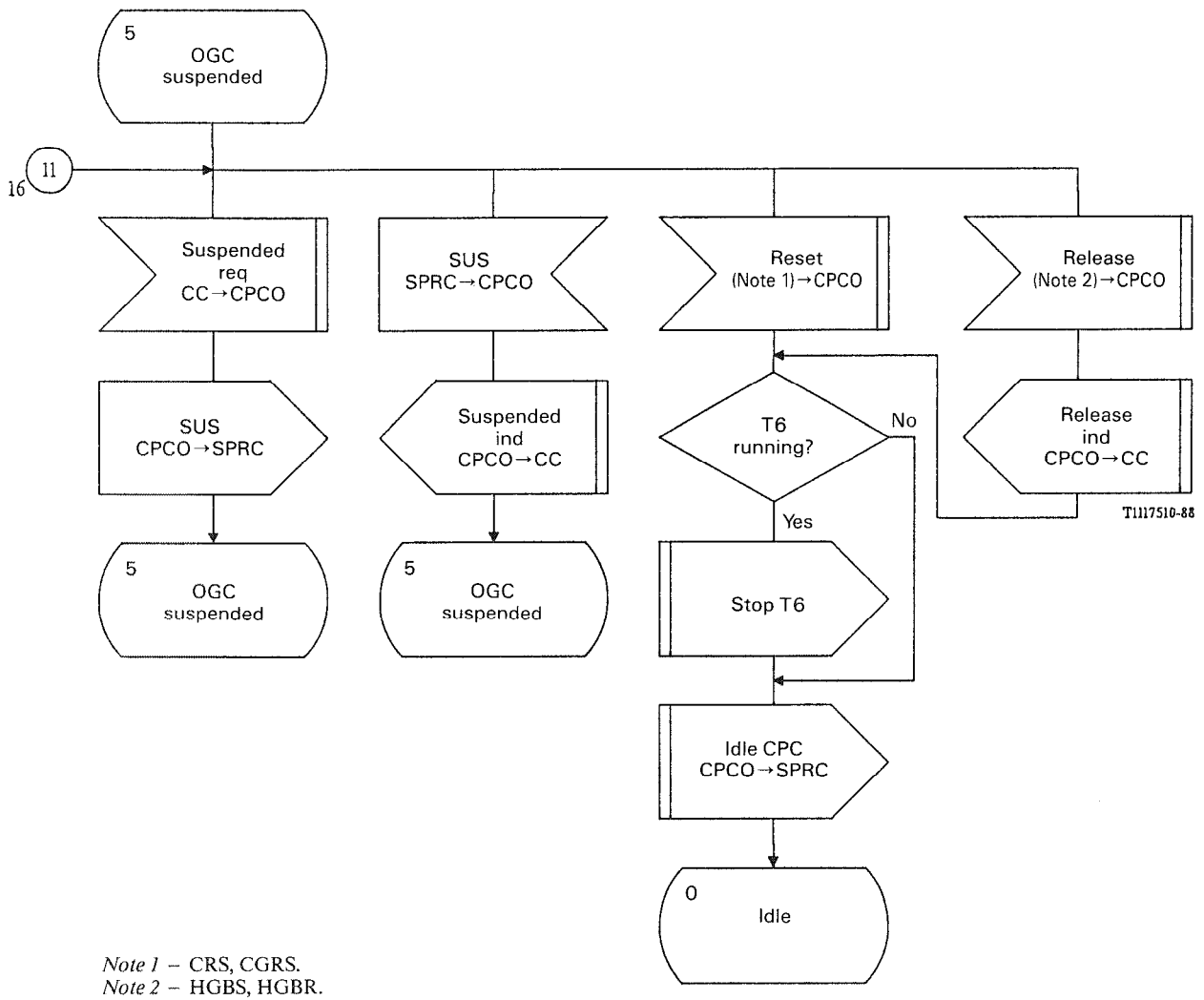
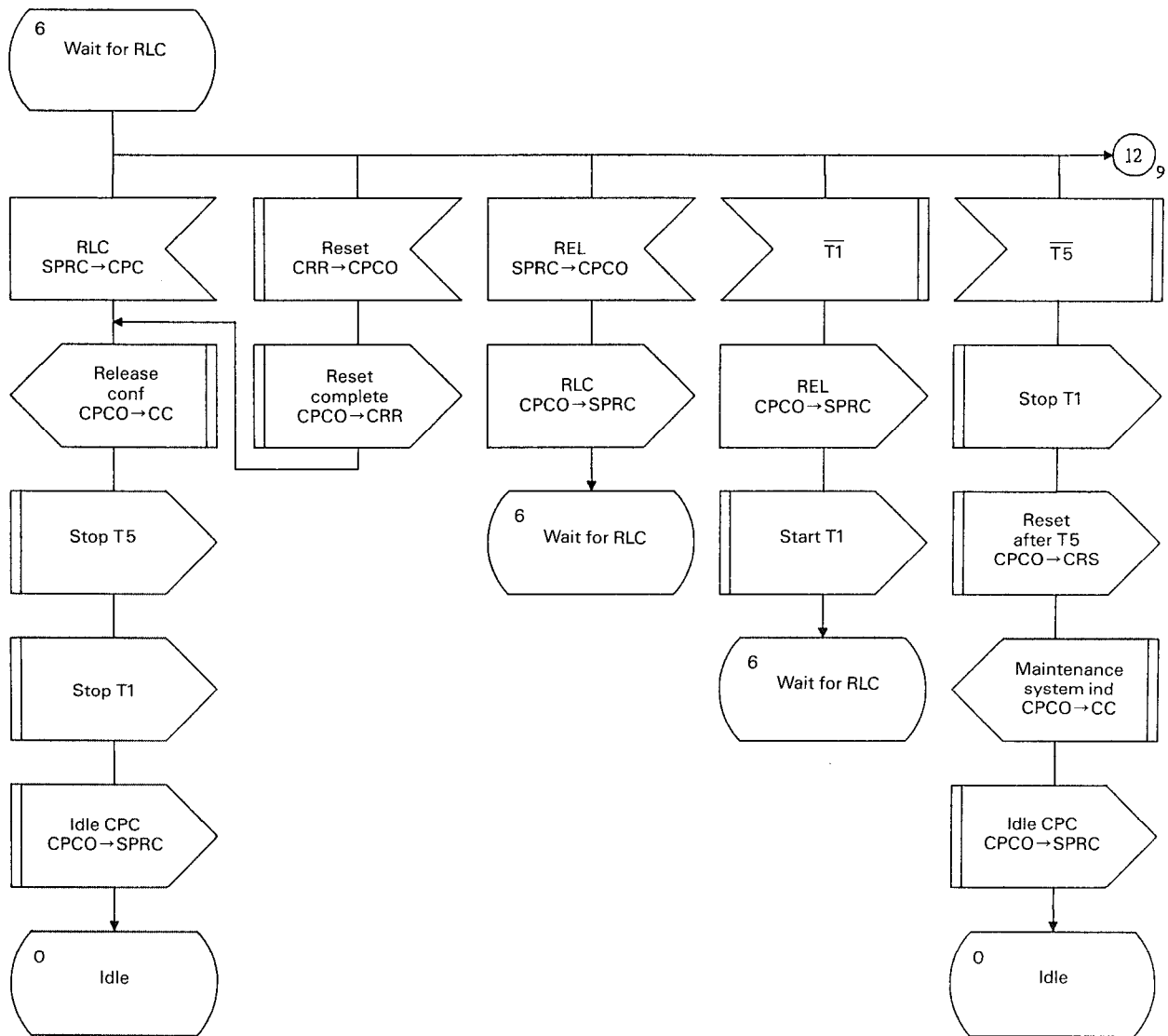
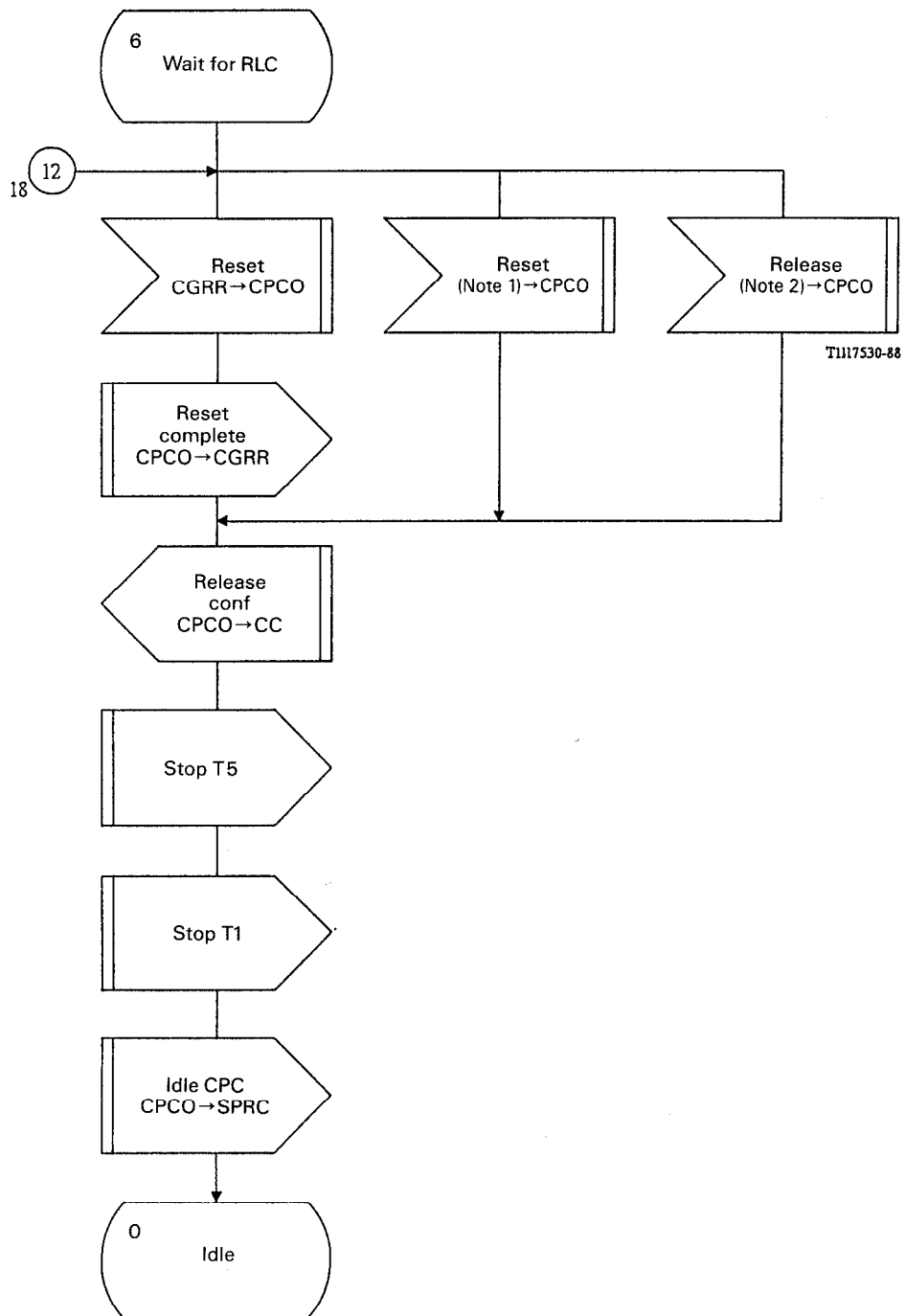

FIGURE B-22/Q.764 (Sheet 17 of 21)
Call Processing Control Outgoing (CPCO)



T1117520-88

FIGURE B-22/Q.764 (Sheet 18 of 21)
Call Processing Control Outgoing (CPCO)



Note 1 - CRS, CGRS.
 Note 2 - HGBS, HGBR.

FIGURE B-22/Q.764 (Sheet 19 of 21)
Call Processing Control Outgoing (CPCO)

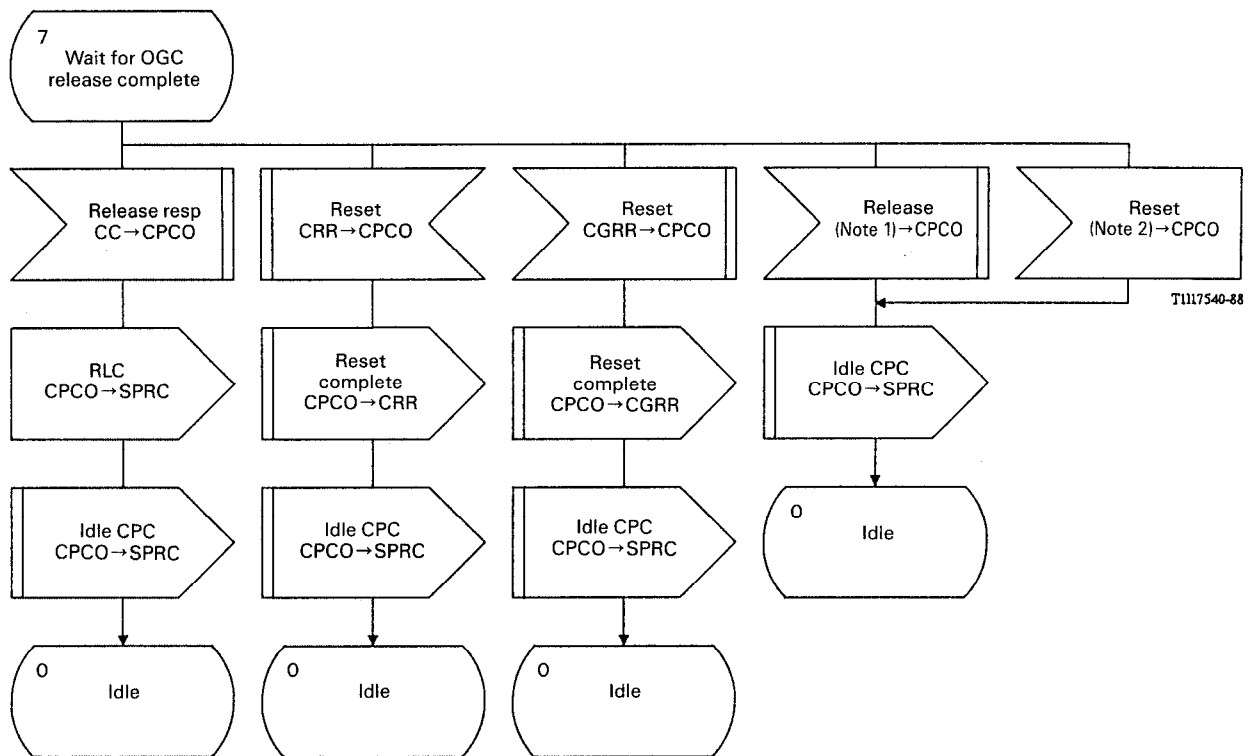

Note 1 - HGBS, HGBR.
 Note 2 - CRS, CGRS.

FIGURE B-22/Q.764 (Sheet 20 of 21)
Call Processing Control Outgoing (CPCO)

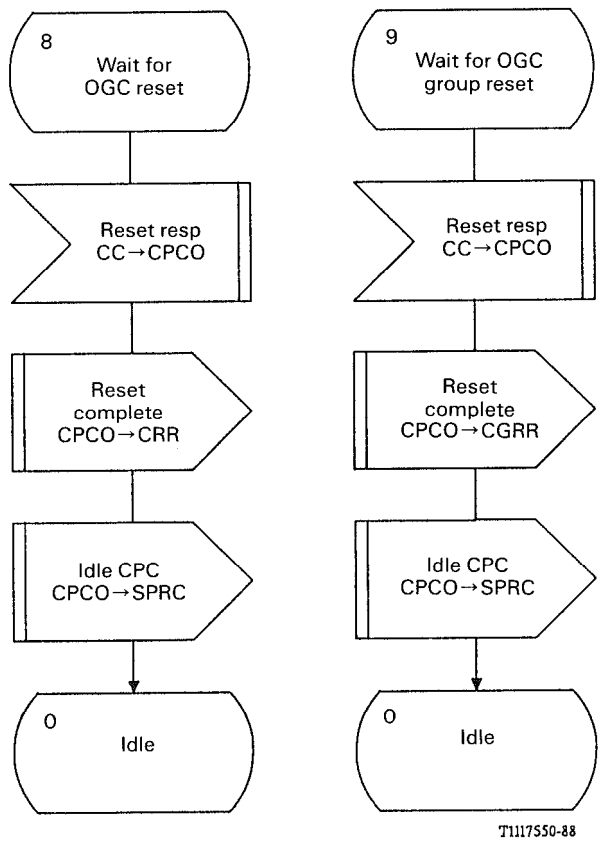
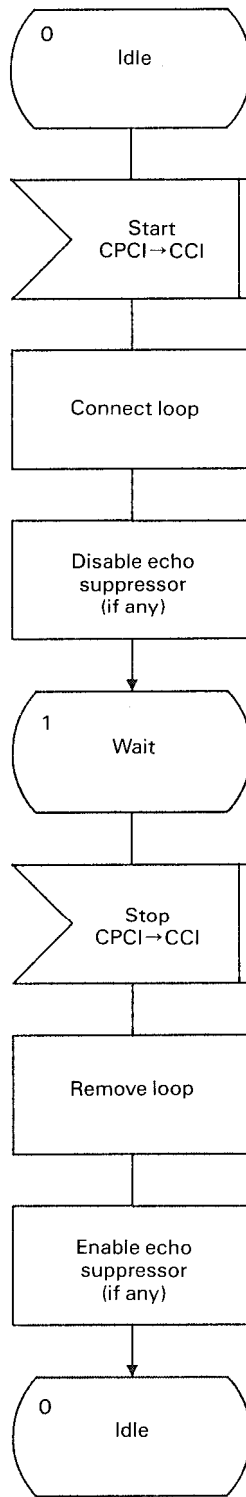
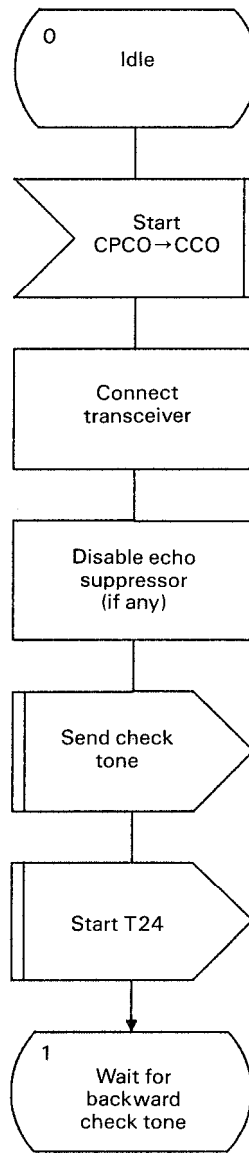

FIGURE B-22/Q.764 (Sheet 21 of 21)
Call Processing Control Outgoing (CPCO)



T1117560-88

FIGURE B-23/Q.764
Continuity Check Incoming (CCI)



T1117570-88

FIGURE B-24/Q.764 (Sheet 1 of 2)
Continuity Check Outgoing (CCO)

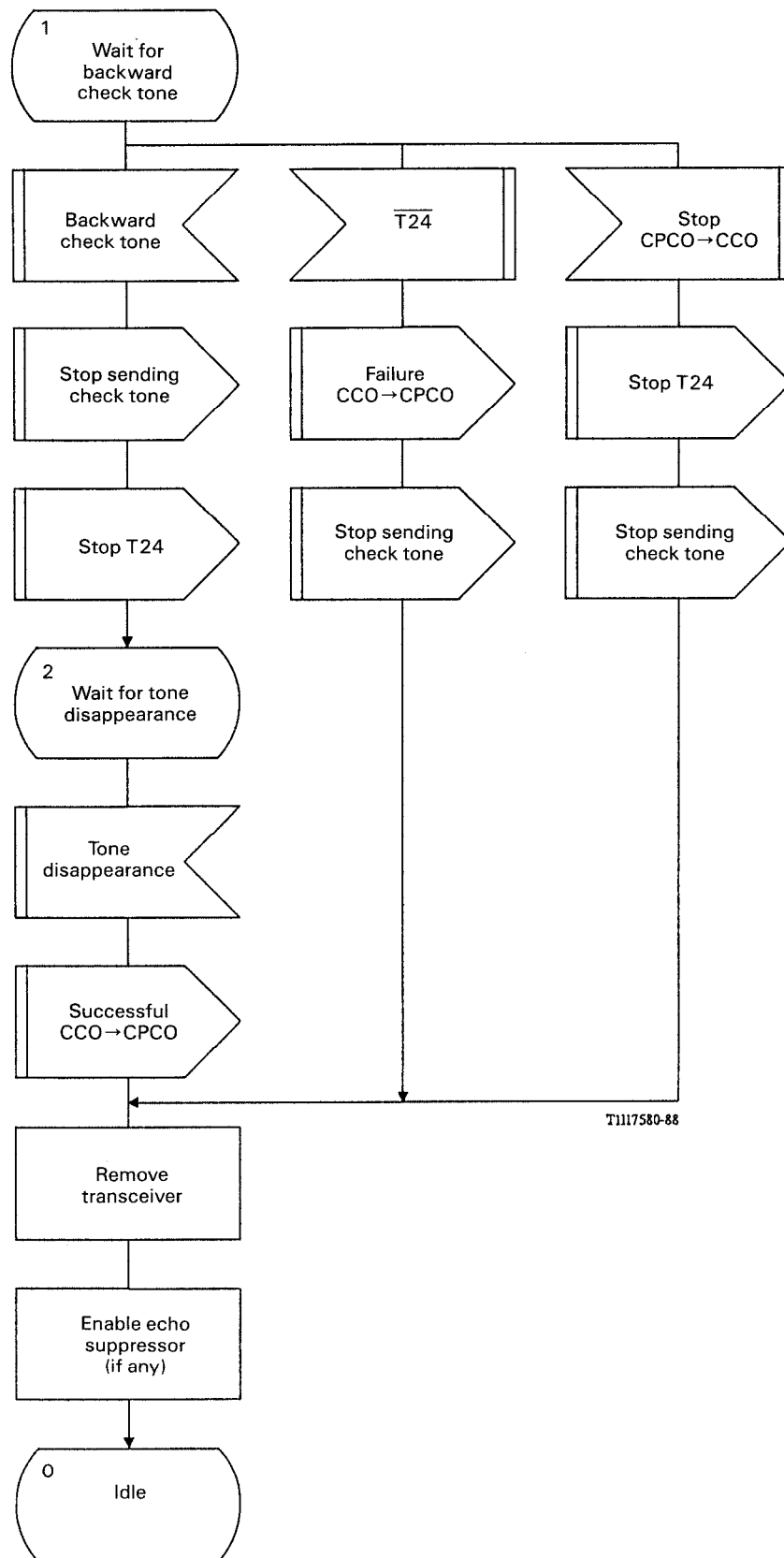

FIGURE B-24/Q.764 (Sheet 2 of 2)
 Continuity Check Outgoing (CCO)

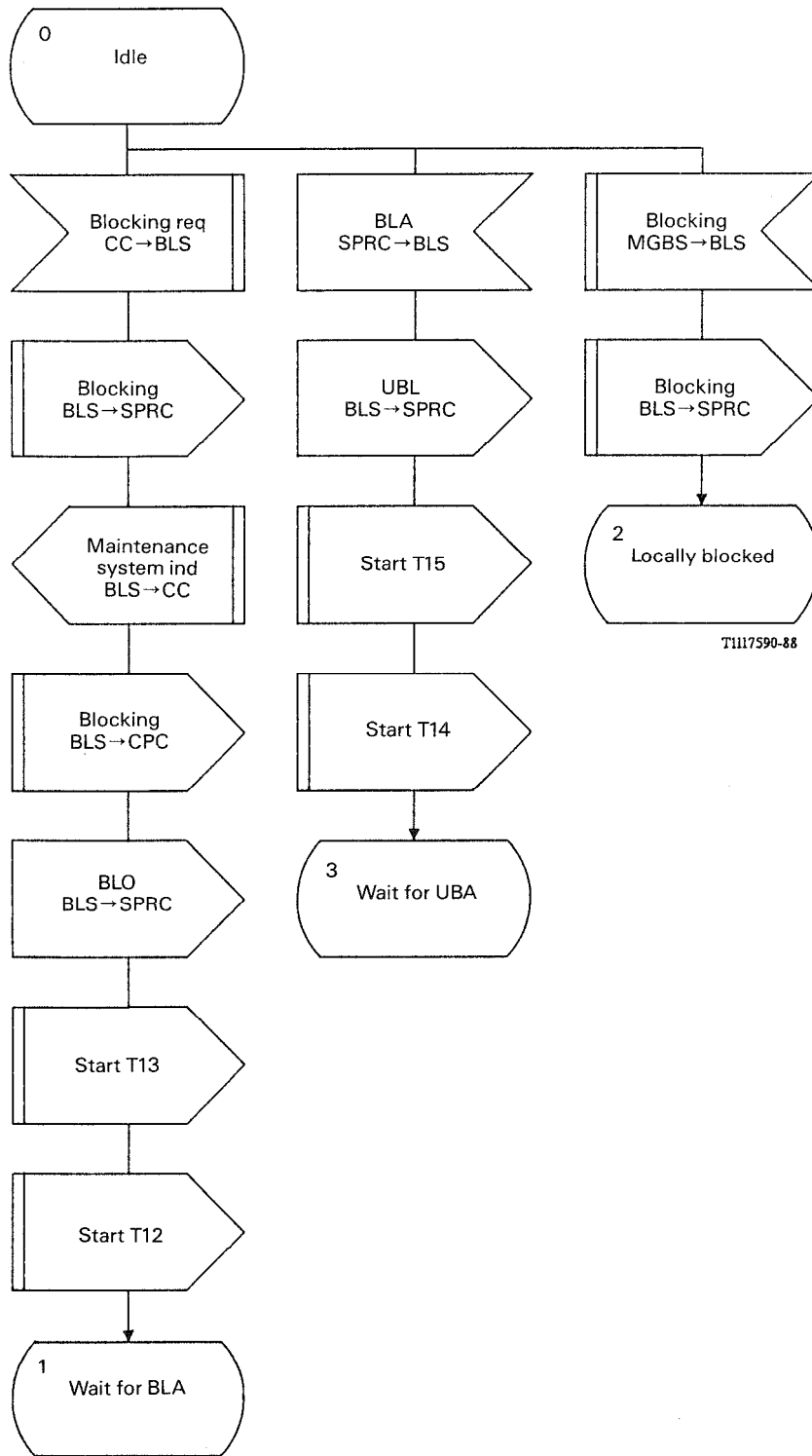

FIGURE B-25/Q.764 (Sheet 1 of 5)

Blocking/Unblocking Message Sending (BLS)

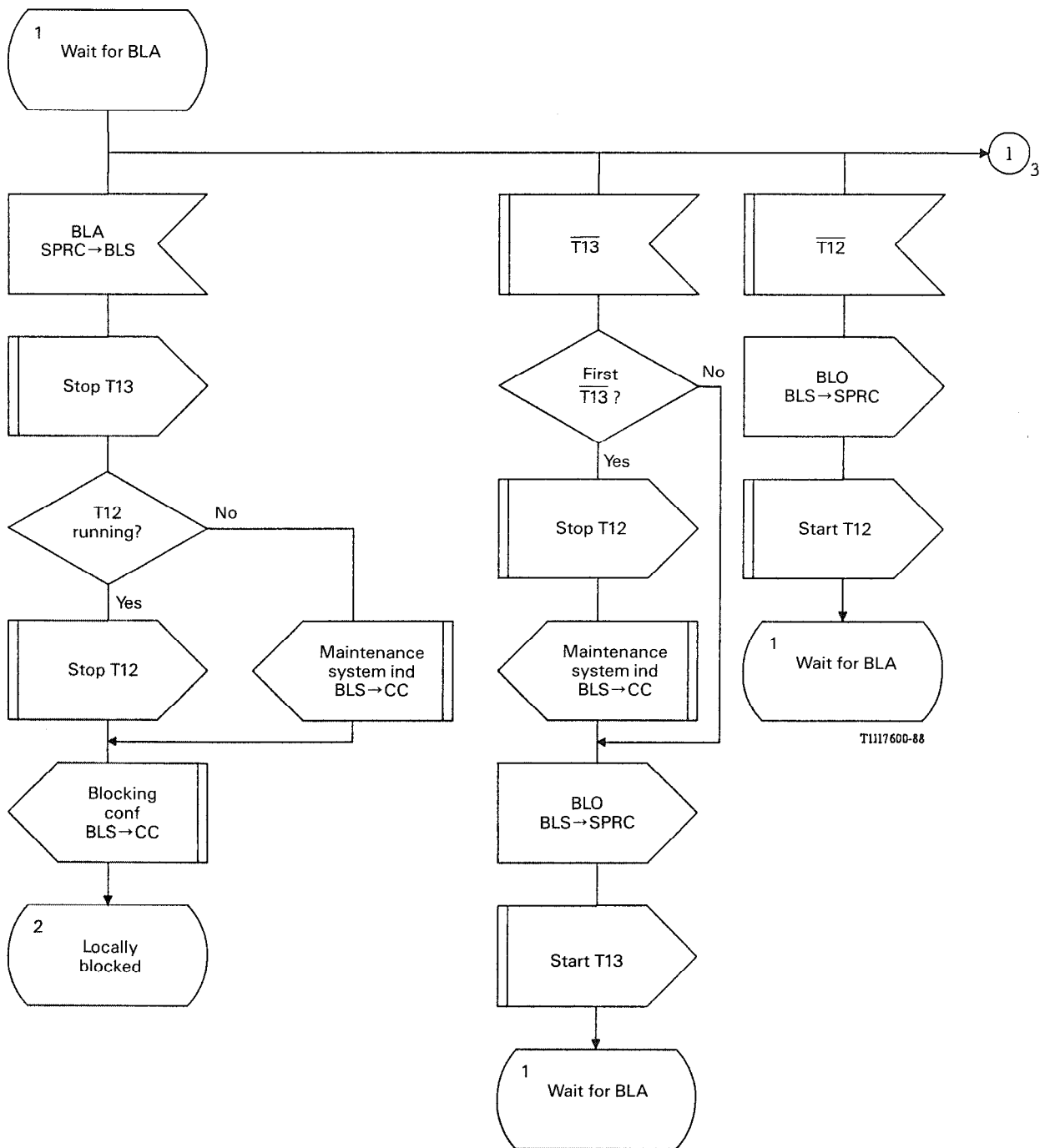
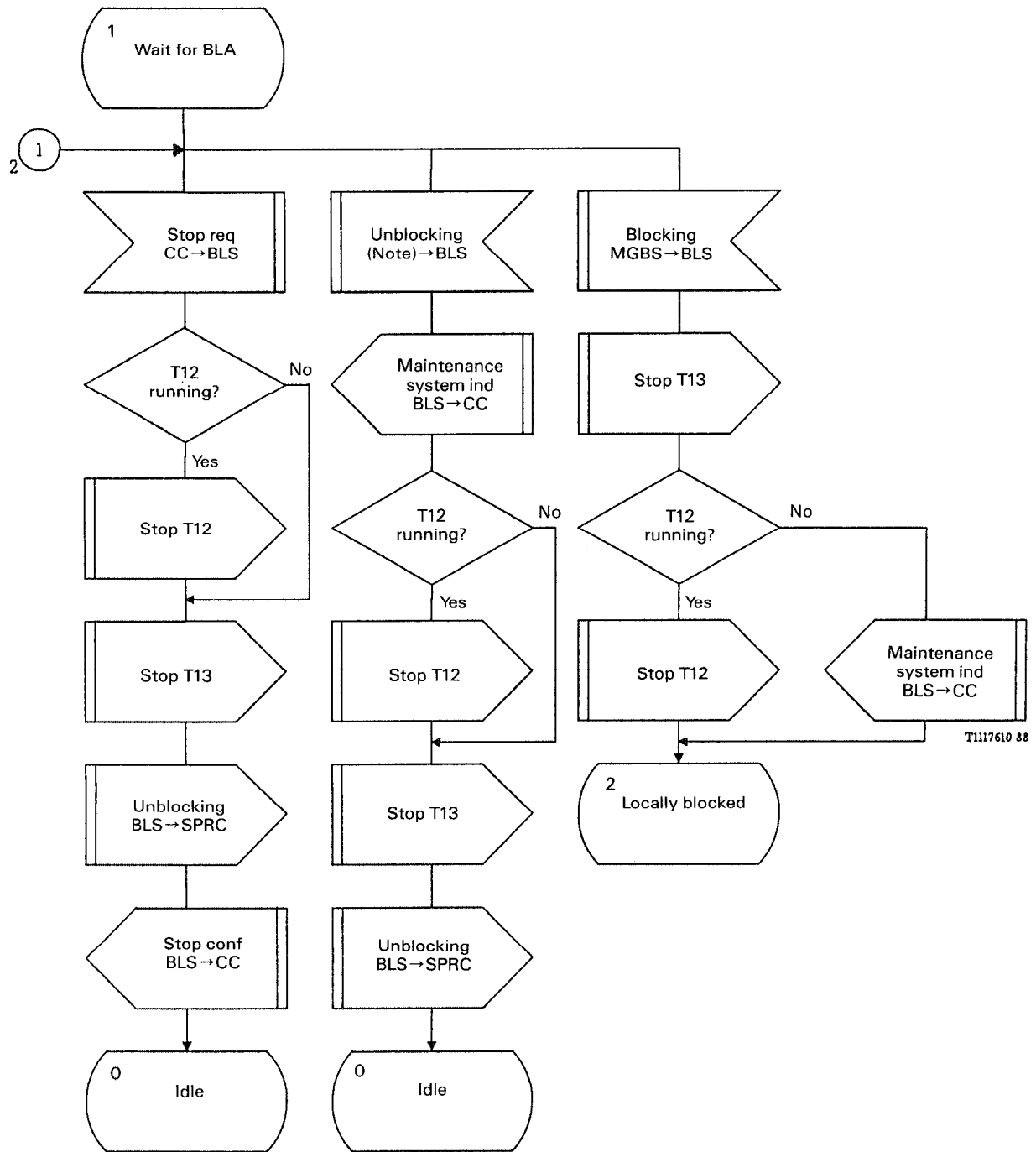
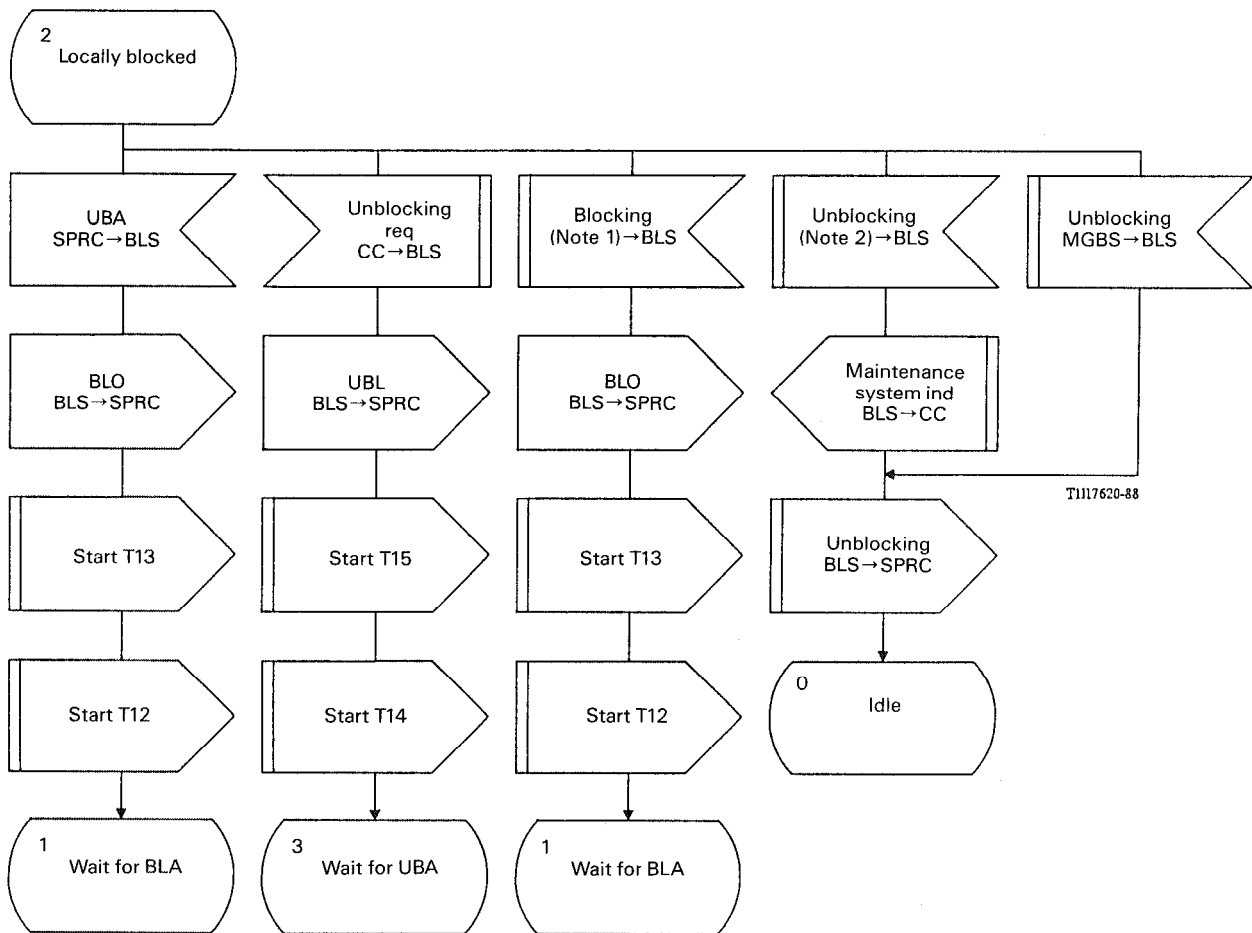

FIGURE B-25/Q.764 (Sheet 2 of 5)
Blocking/Unblocking Message Sending (BLS)



Note - CRS, CGRS.

FIGURE B-25/Q.764 (Sheet 3 of 5)
 Blocking/Unblocking Message Sending (BLS)



Note 1 – CRR, CPC.
 Note 2 – CRS, CGRS.

FIGURE B-25/Q.764 (Sheet 4 of 5)
Blocking/Unblocking Message Sending (BLS)

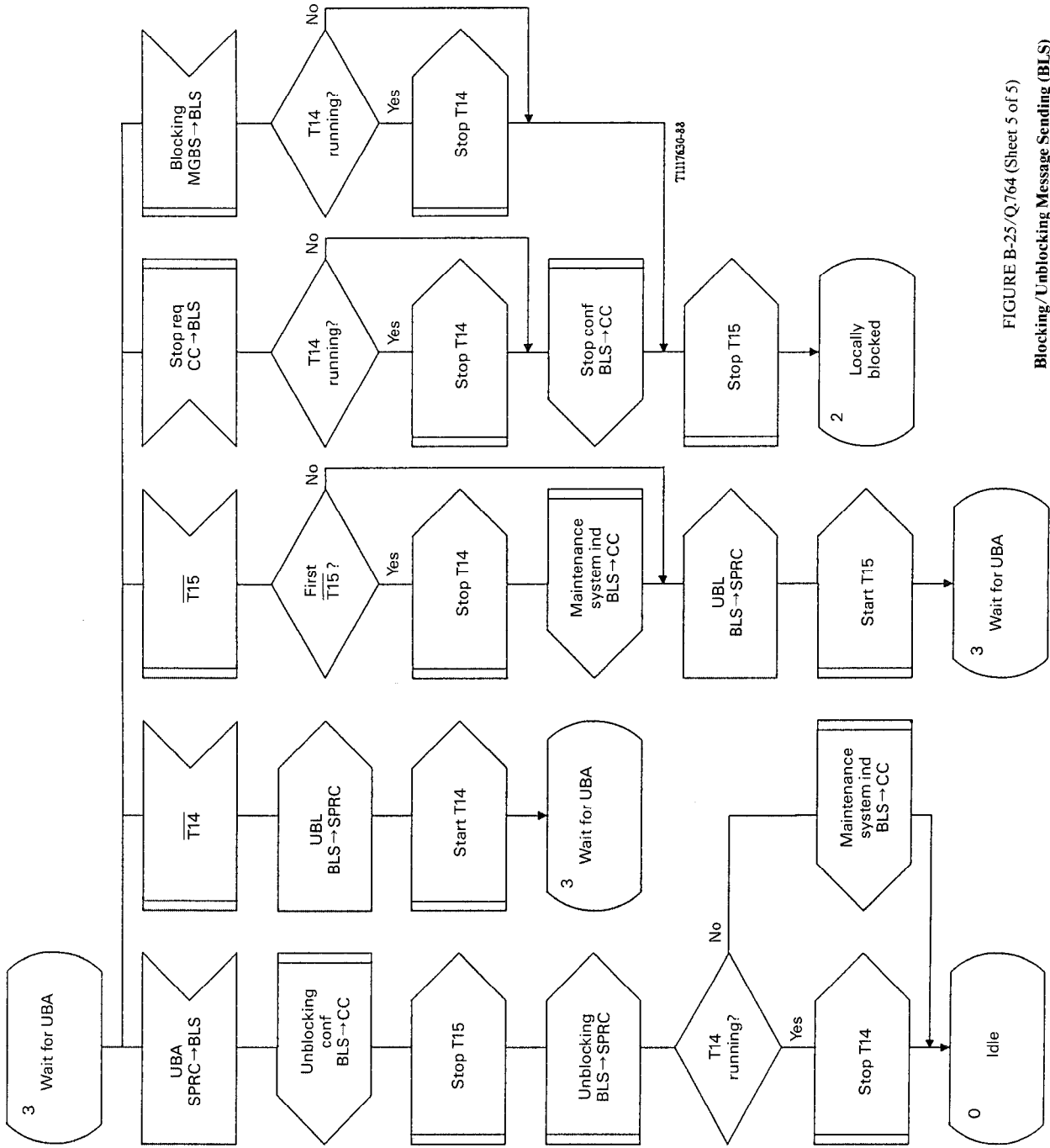

FIGURE B-25/Q.764 (Sheet 5 of 5)

Blocking/Unblocking Message Sending (BLS)

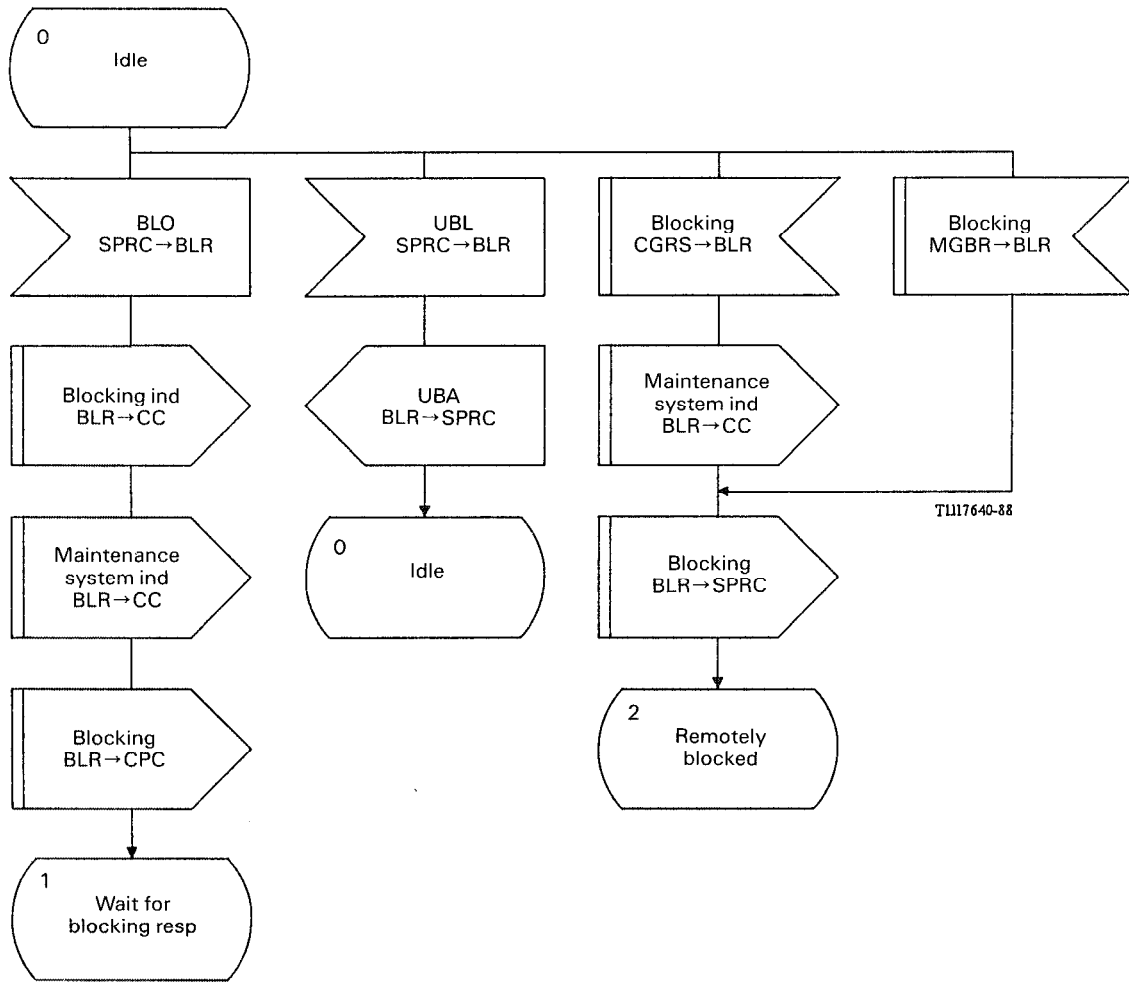
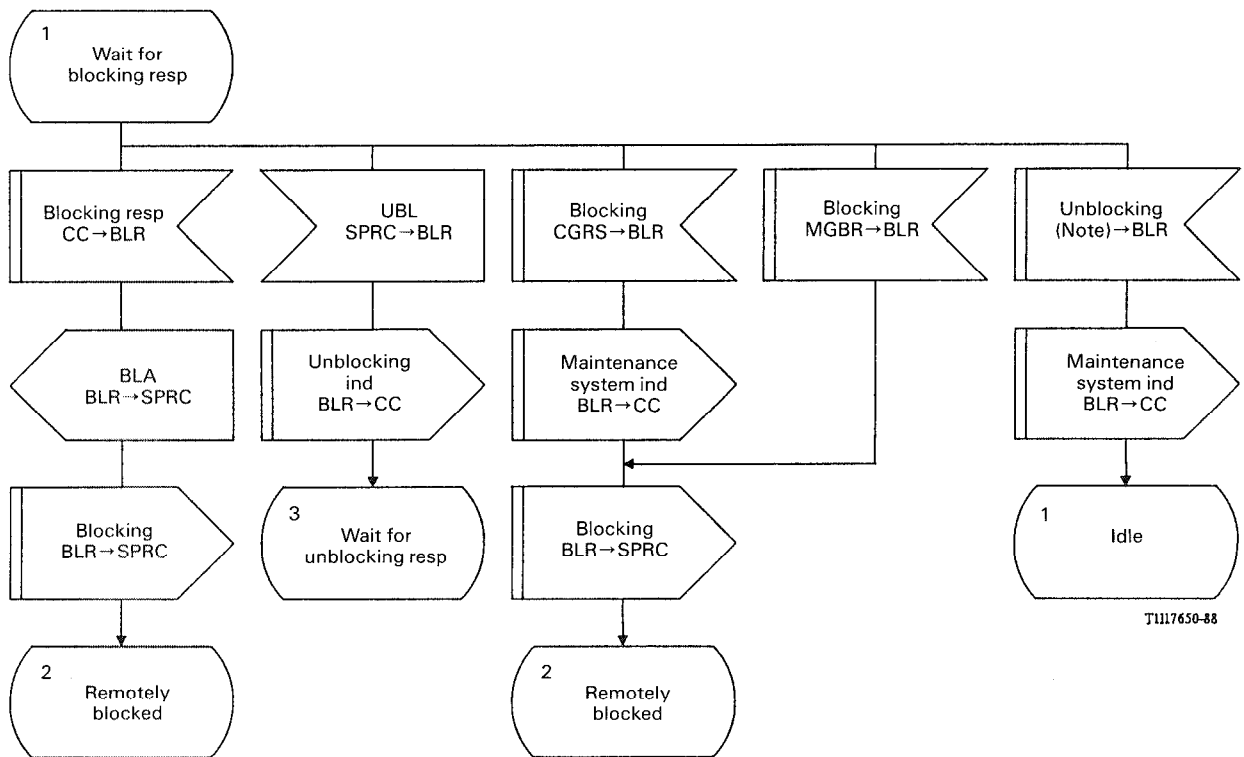
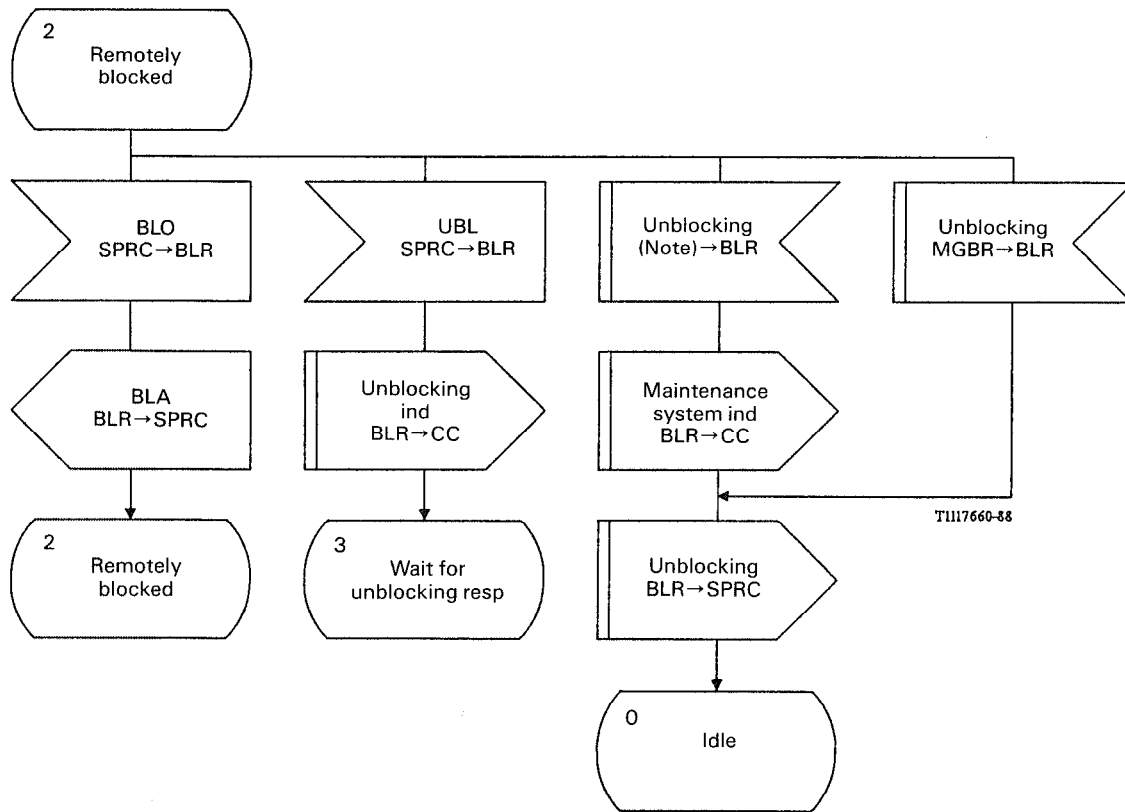

FIGURE B-26/Q.764 (Sheet 1 of 4)
Blocking/Unblocking Message Reception (BLR)



Note – CRR, CRS, CGRR.

FIGURE B-26/Q.764 (Sheet 2 of 4)
Blocking/Unblocking Message Reception (BLR)



Note – CRR, CGRR, CRS, CPCI.

FIGURE B-26/Q.764 (Sheet 3 of 4)
Blocking/Unblocking Message Reception (BLR)

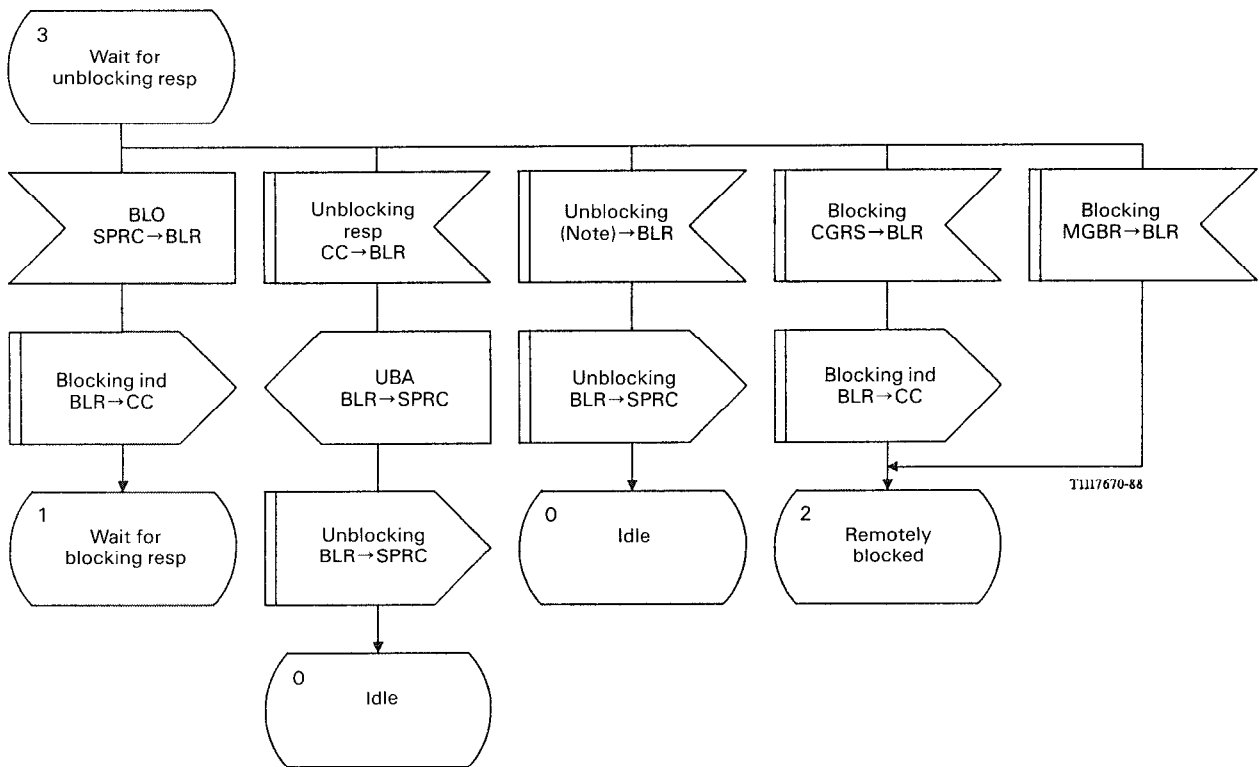

Note – CRR, CGRR, MGBR, CRS.

FIGURE B-26/Q.764 (Sheet 4 of 4)
Blocking/Unblocking Message Reception (BLR)

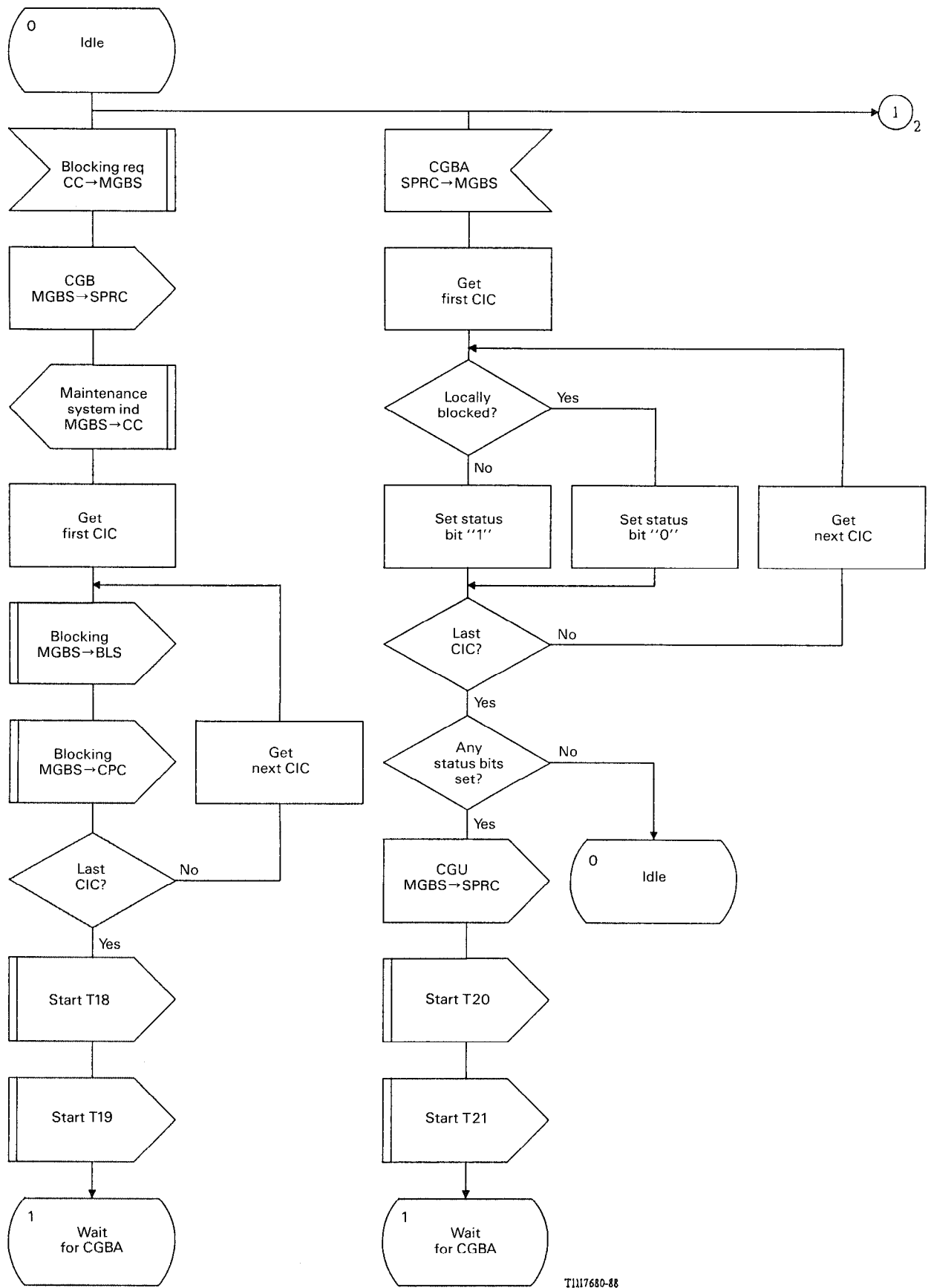

T1117680-88

FIGURE B-27/Q.764 (Sheet 1 of 6)

Maintenance Oriented Circuit Group Blocking and Unblocking Sending (MGBS)

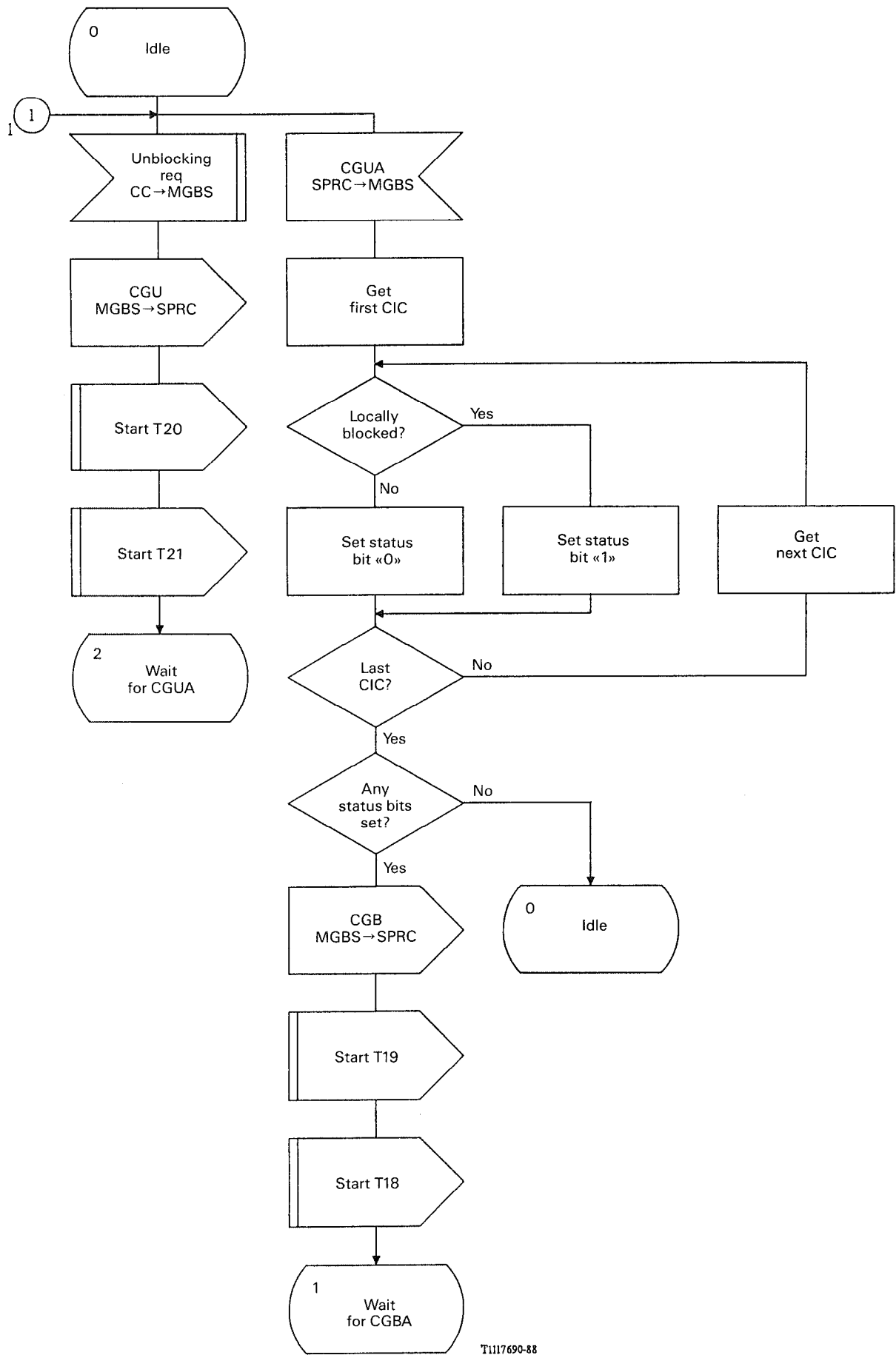

T1117690-88

FIGURE B-27/Q.764 (Sheet 2 of 6)
Maintenance Oriented Circuit Group Blocking and Unblocking Sending (MGBS)

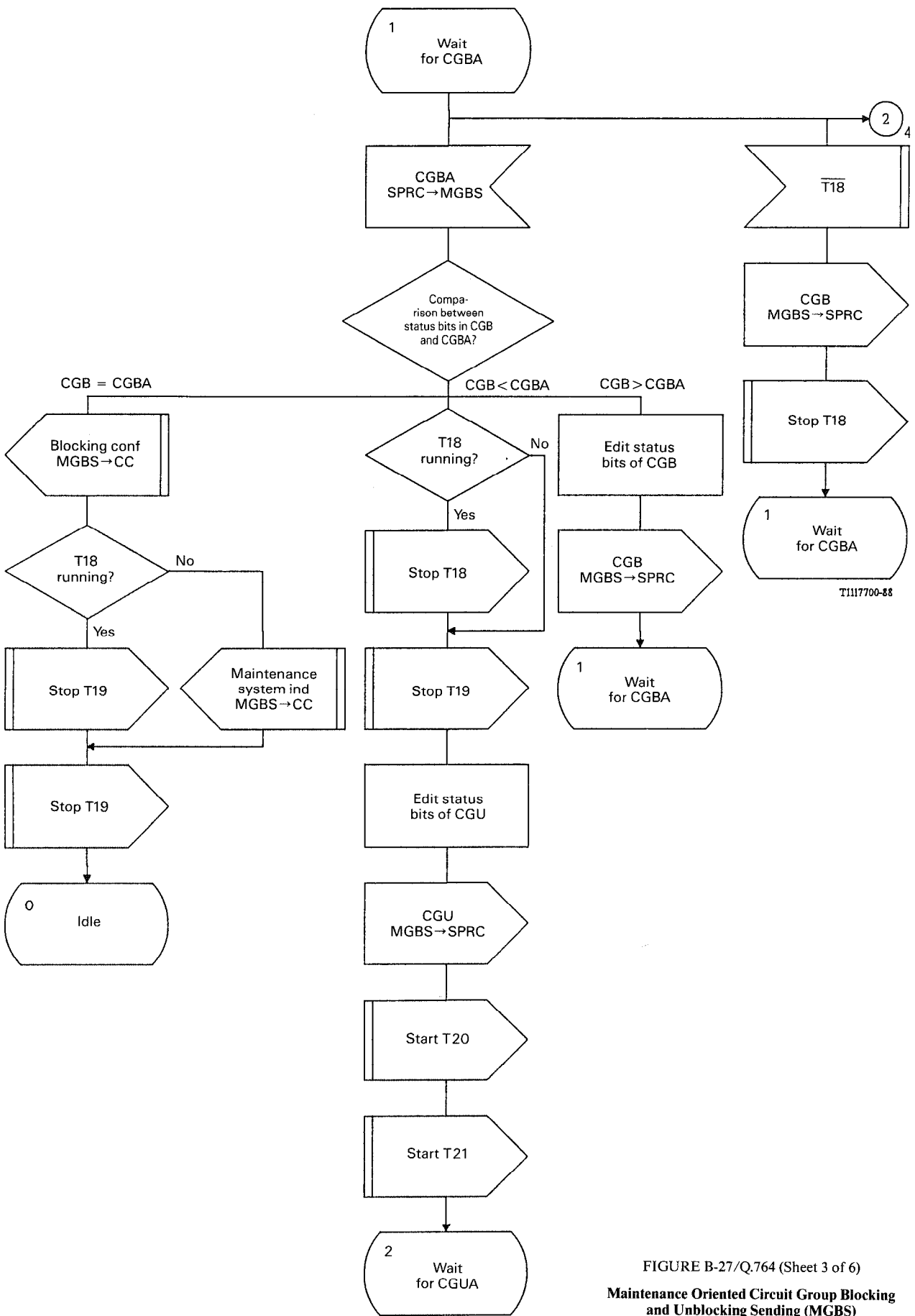
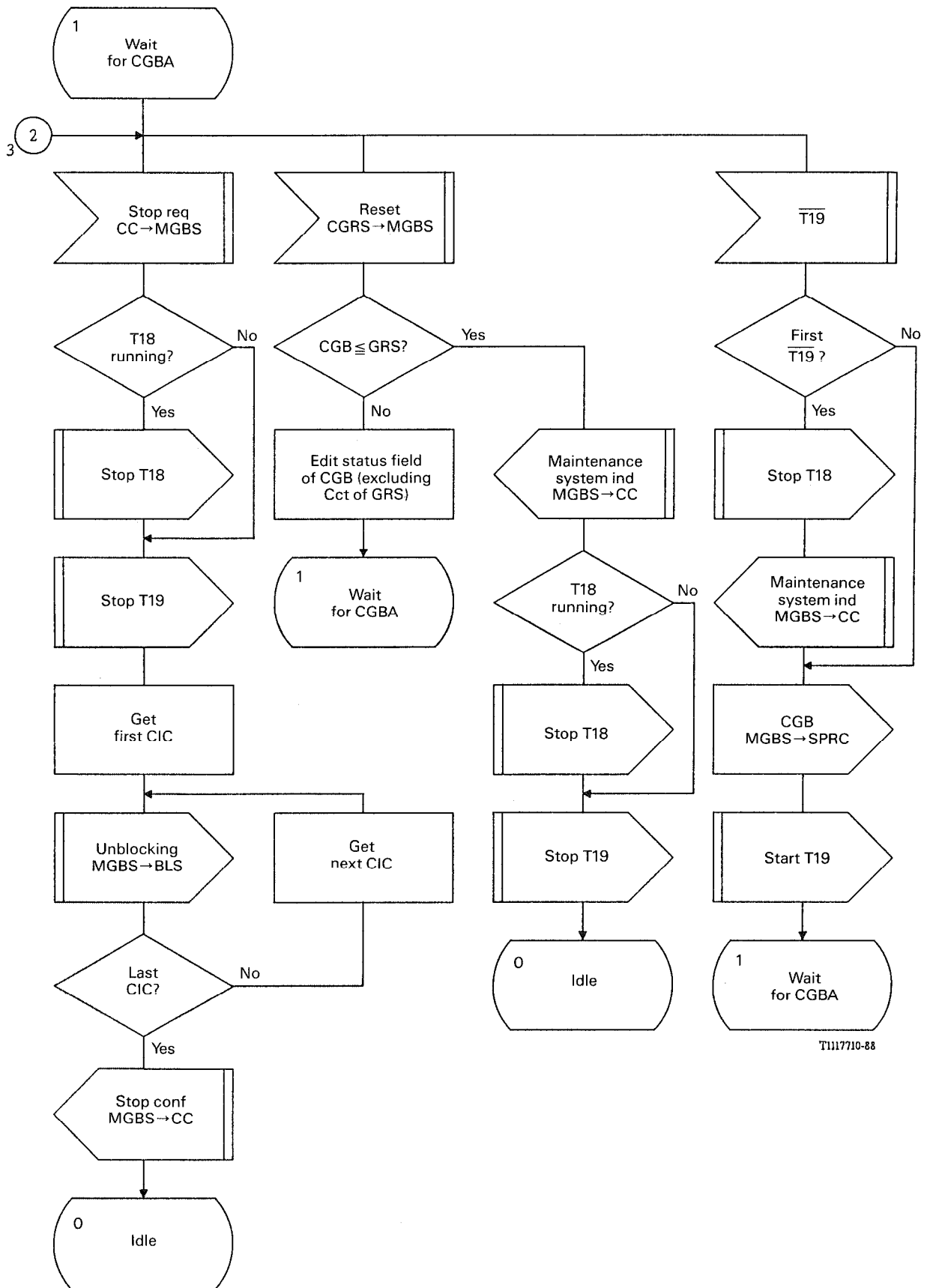

FIGURE B-27/Q.764 (Sheet 3 of 6)
 Maintenance Oriented Circuit Group Blocking and Unblocking Sending (MGBS)



T1117710-88

FIGURE B-27/Q.764 (Sheet 4 of 6)

Maintenance Oriented Circuit Group Blocking and Unblocking Sending (MGBS)

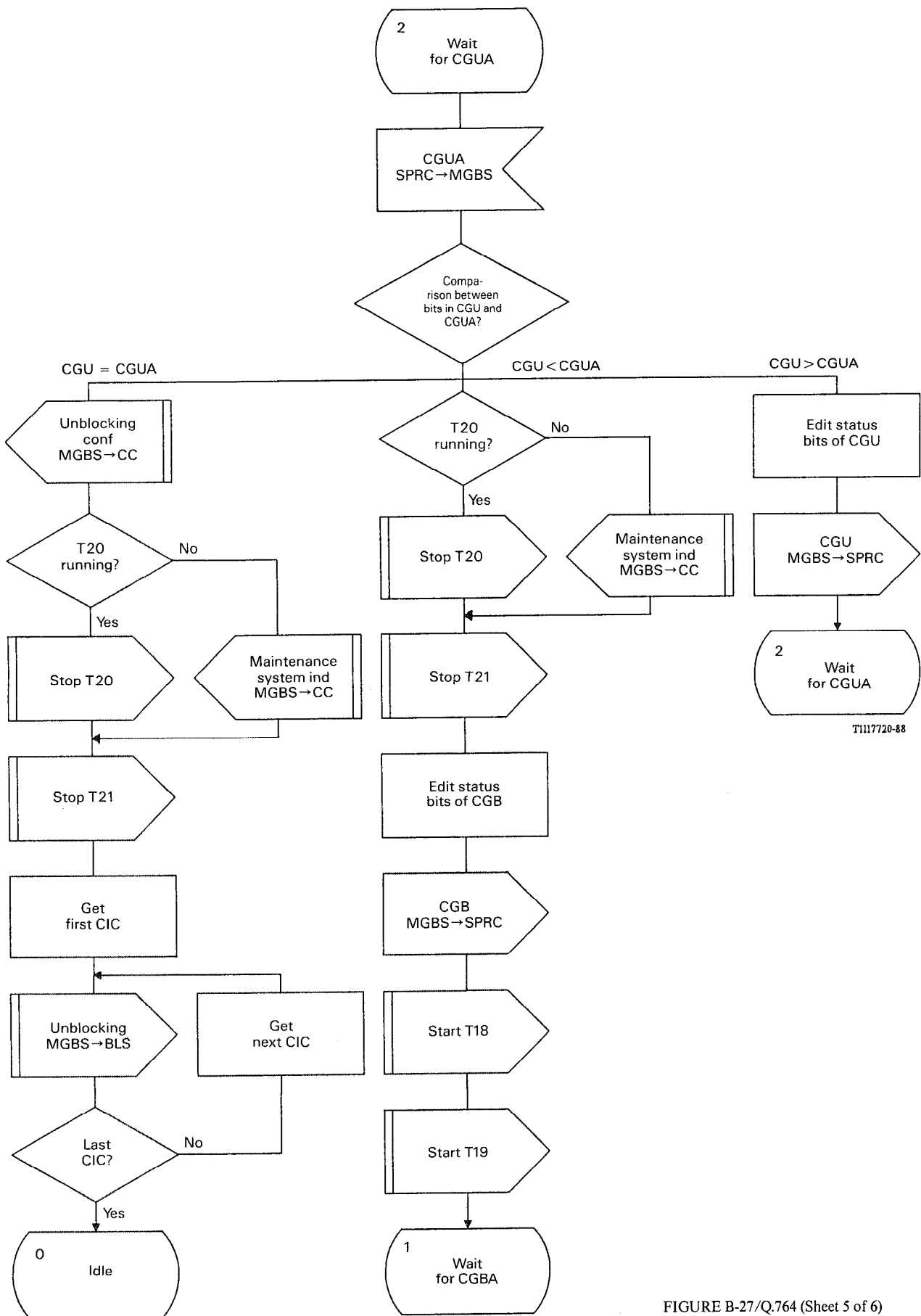

FIGURE B-27/Q.764 (Sheet 5 of 6)

Maintenance Oriented Circuit Group Blocking and Unblocking Sending (MGBS)

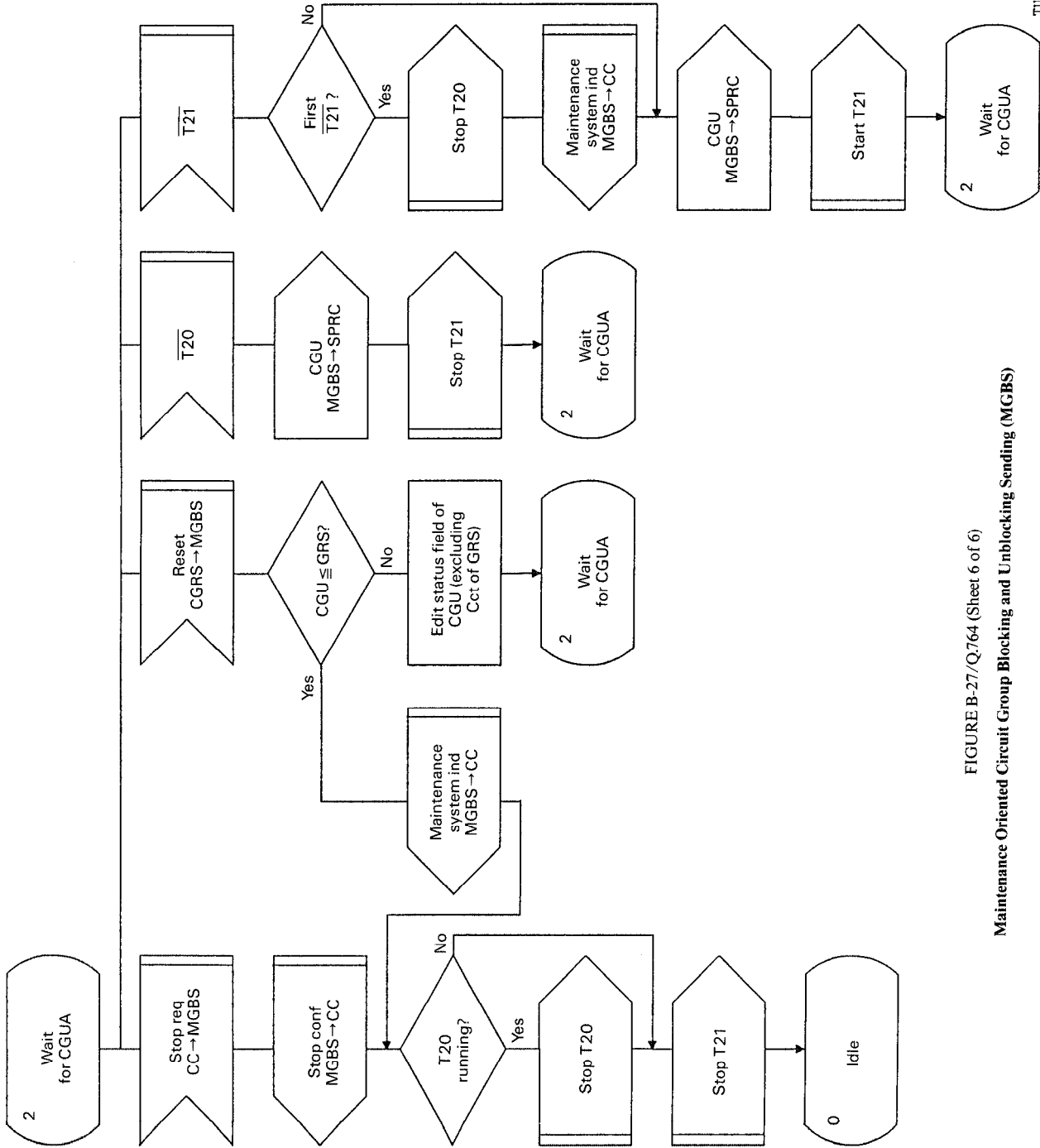

FIGURE B-27/Q.764 (Sheet 6 of 6)
 Maintenance Oriented Circuit Group Blocking and Unblocking Sending (MGBS)

T1117730-88

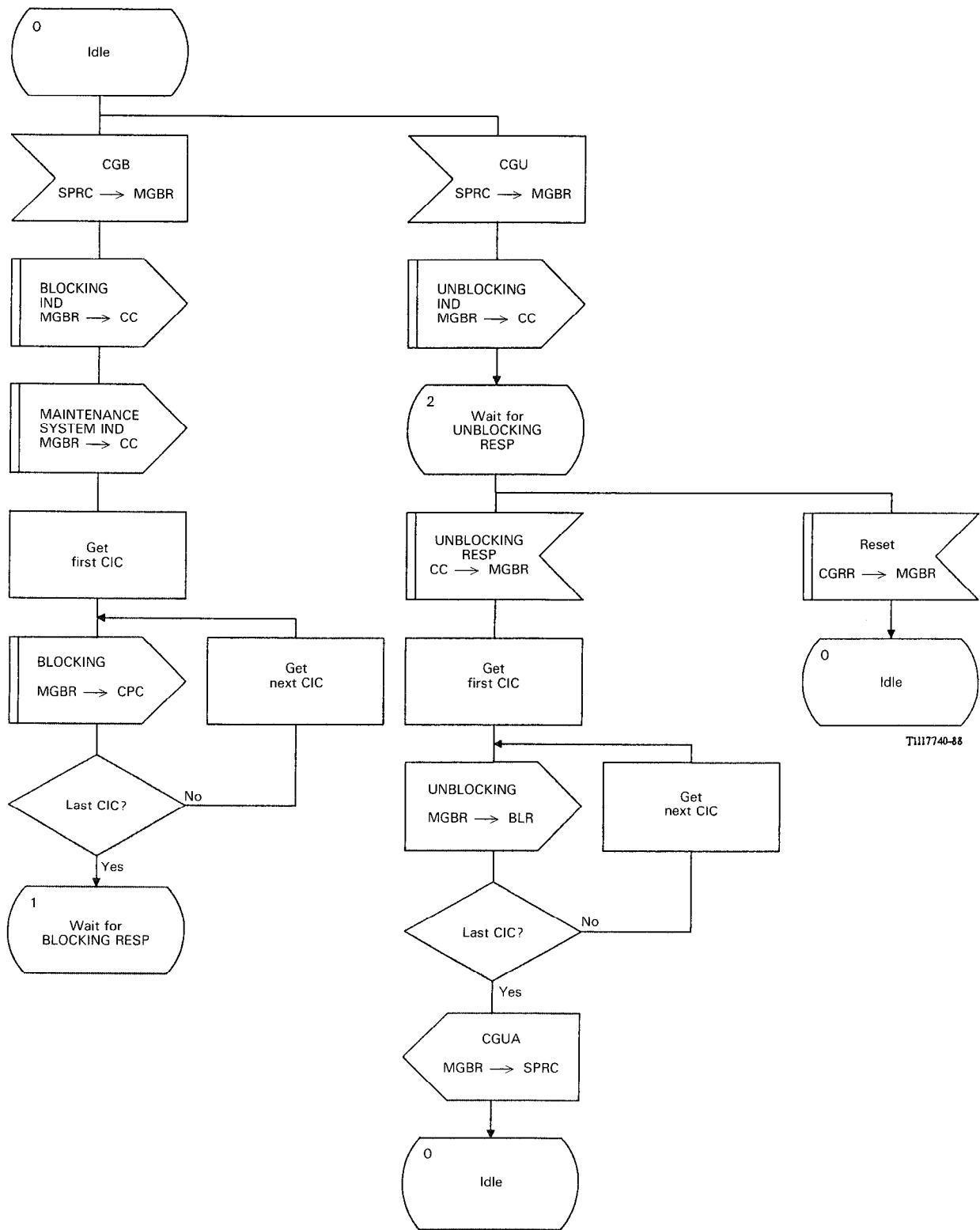
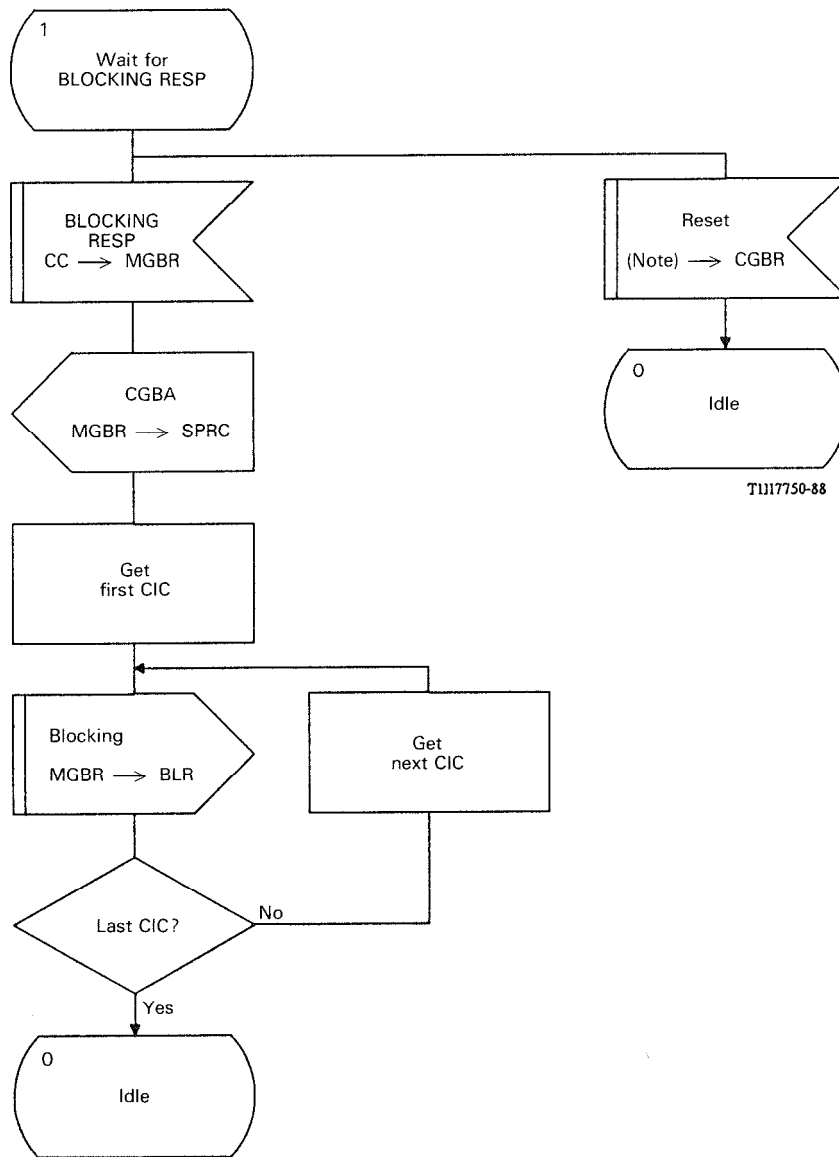

FIGURE B-28/Q.764
(Sheet 1 of 2)

Maintenance Oriented Circuit Group Blocking and Unblocking Reception (MGBR)



T1117750-88

Note - CGRS, CGRR.

FIGURE B-28/Q.764
(Sheet 2 of 2)

Maintenance Oriented Circuit Group Blocking and Unblocking Reception (MGBR)

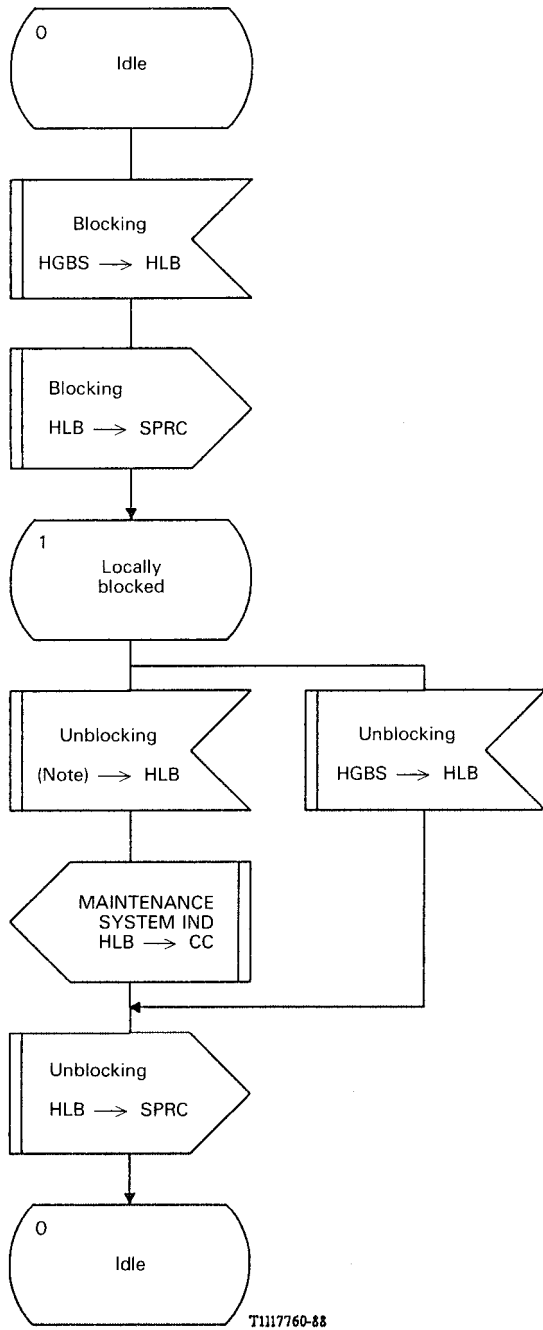

Note - CRS, CGRS.

FIGURE B-29/Q.764
Hardware Failure Oriented Locally Blocking (HLB)

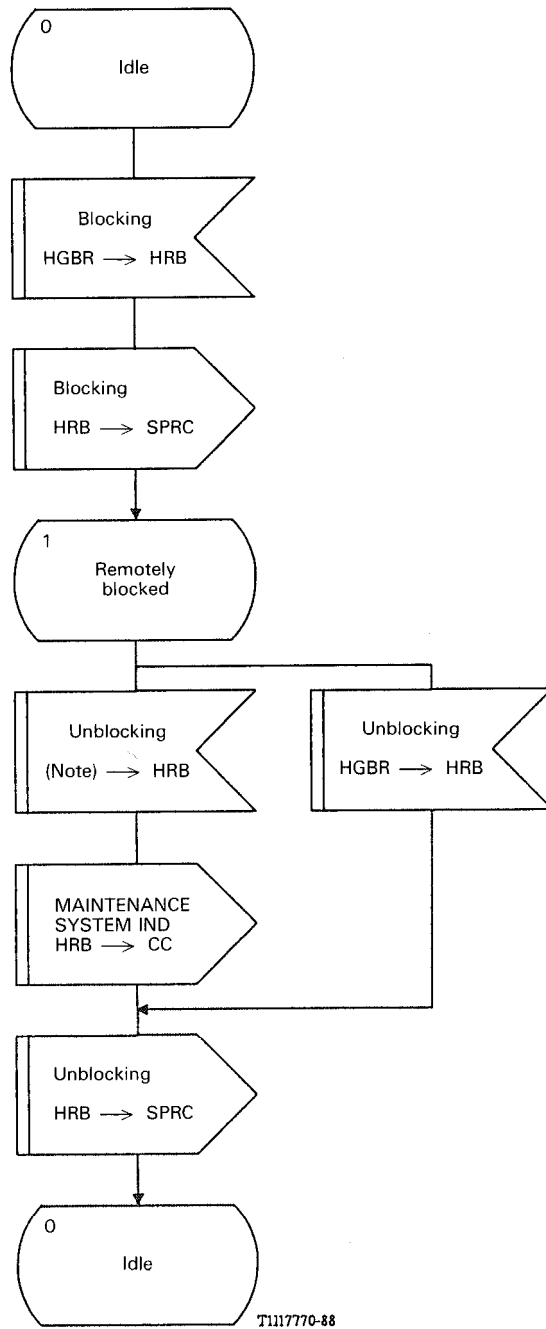

Note - CRS, CRR, CGRS, CGRR.

FIGURE B-30/Q.764
Hardware Failure Oriented Remotely Blocking (HRB)

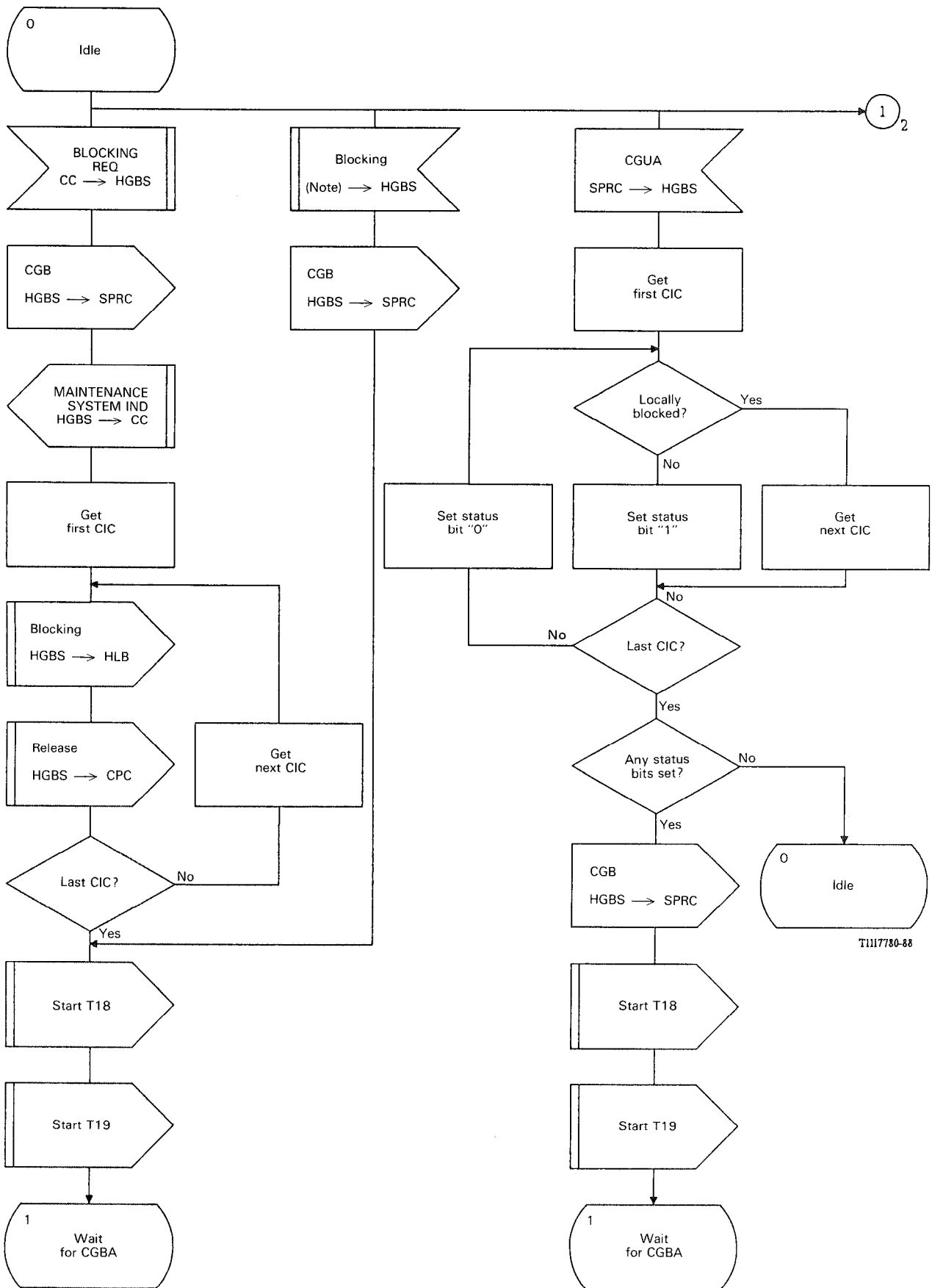

T1117780-88

Note - CRR, CGRR, CPC1.

FIGURE B-31/Q.764
(Sheet 1 of 6)

Hardware Failure Oriented Circuit Group Blocking and Unblocking Sending (HGBS)

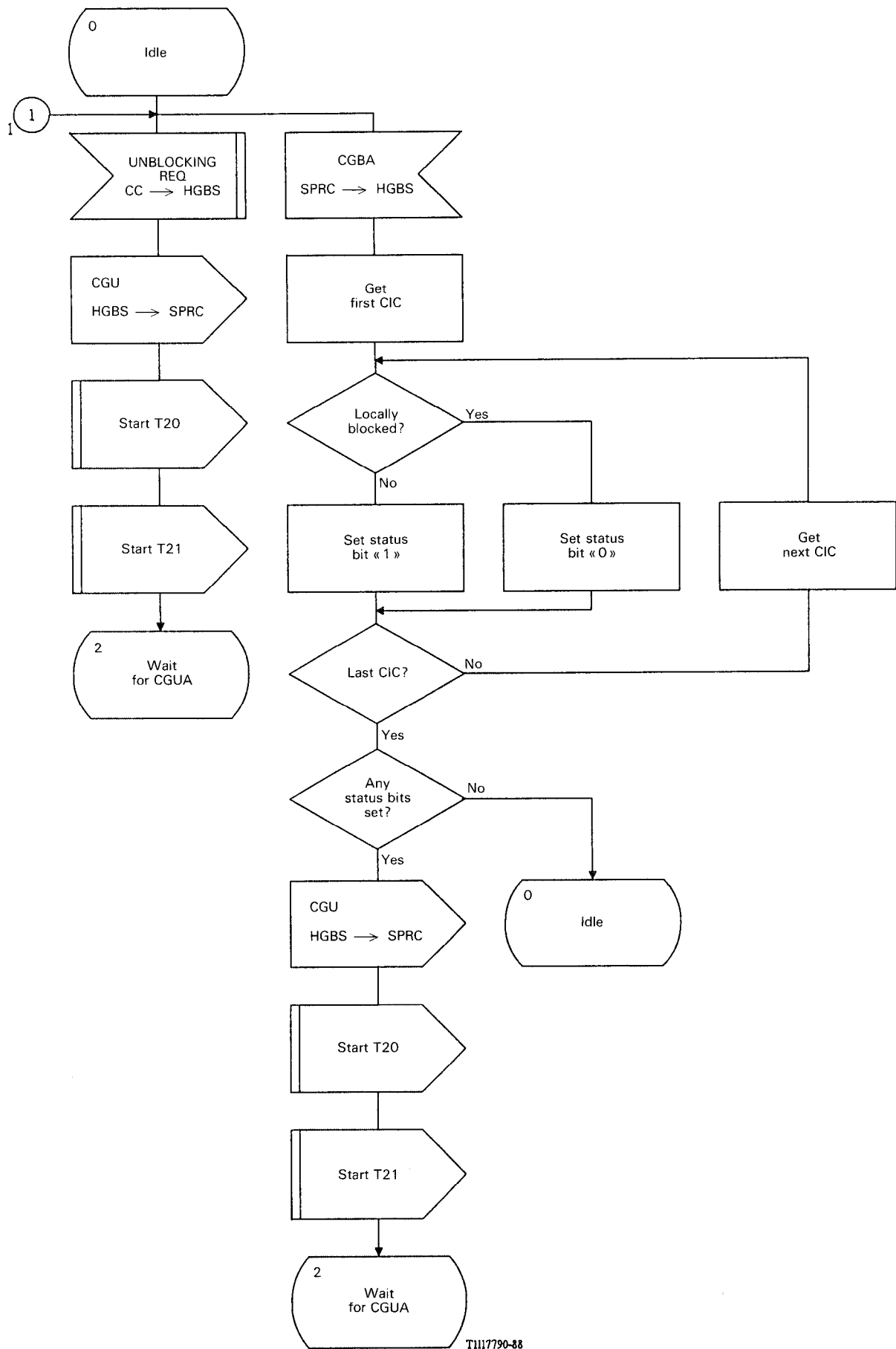

FIGURE B-31/Q.764
(Sheet 2 of 6)

Hardware Failure Oriented Circuit Group Blocking and Unblocking Sending (HGBS)

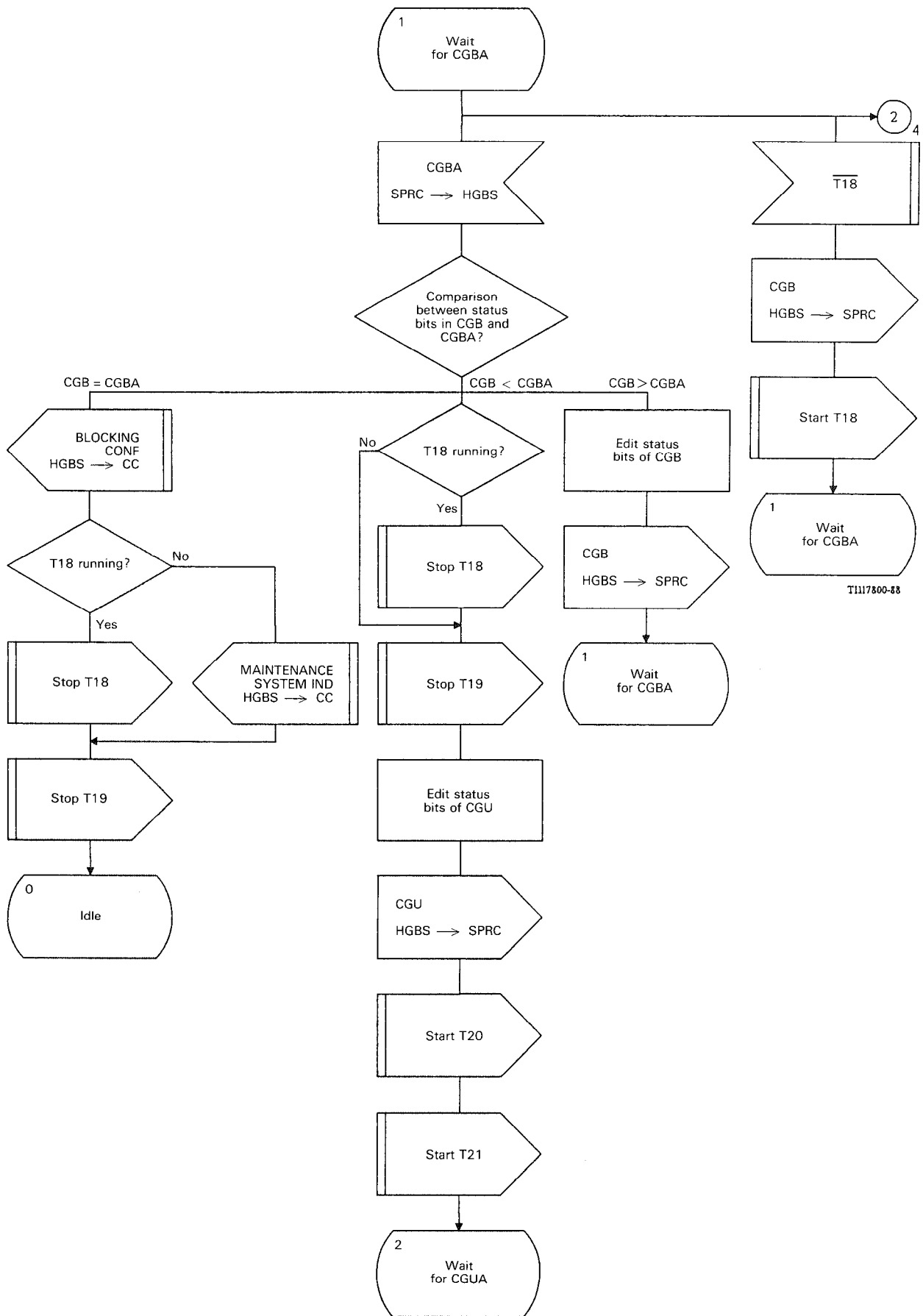
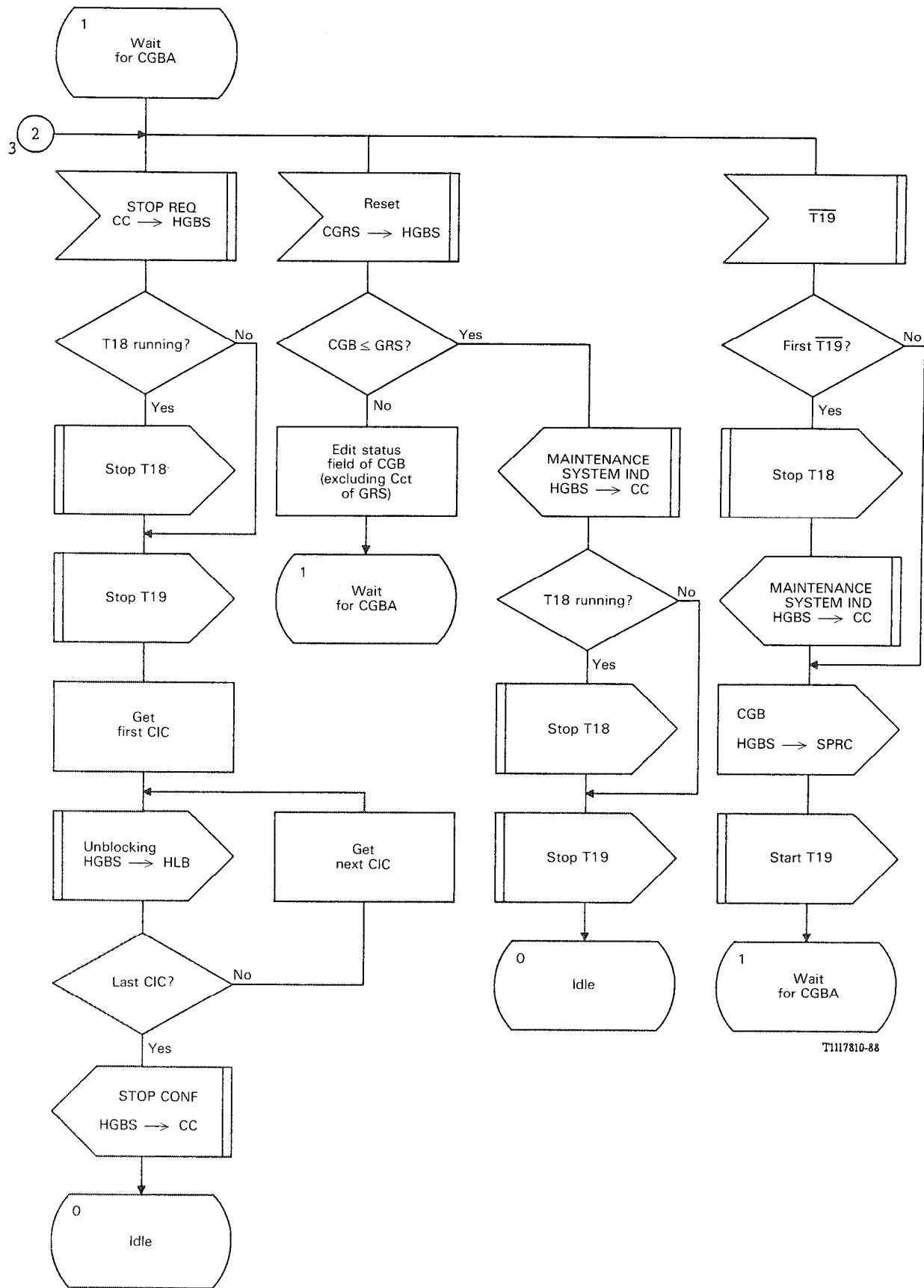

FIGURE B-31/Q.764
(Sheet 3 of 6)

Hardware Failure Oriented Circuit Group Blocking and Unblocking Sending (HGBS)



T1117810-88

FIGURE B-31/Q.764
(Sheet 4 of 6)

Hardware Failure Oriented Circuit Group Blocking and Unblocking Sending (HGBS)

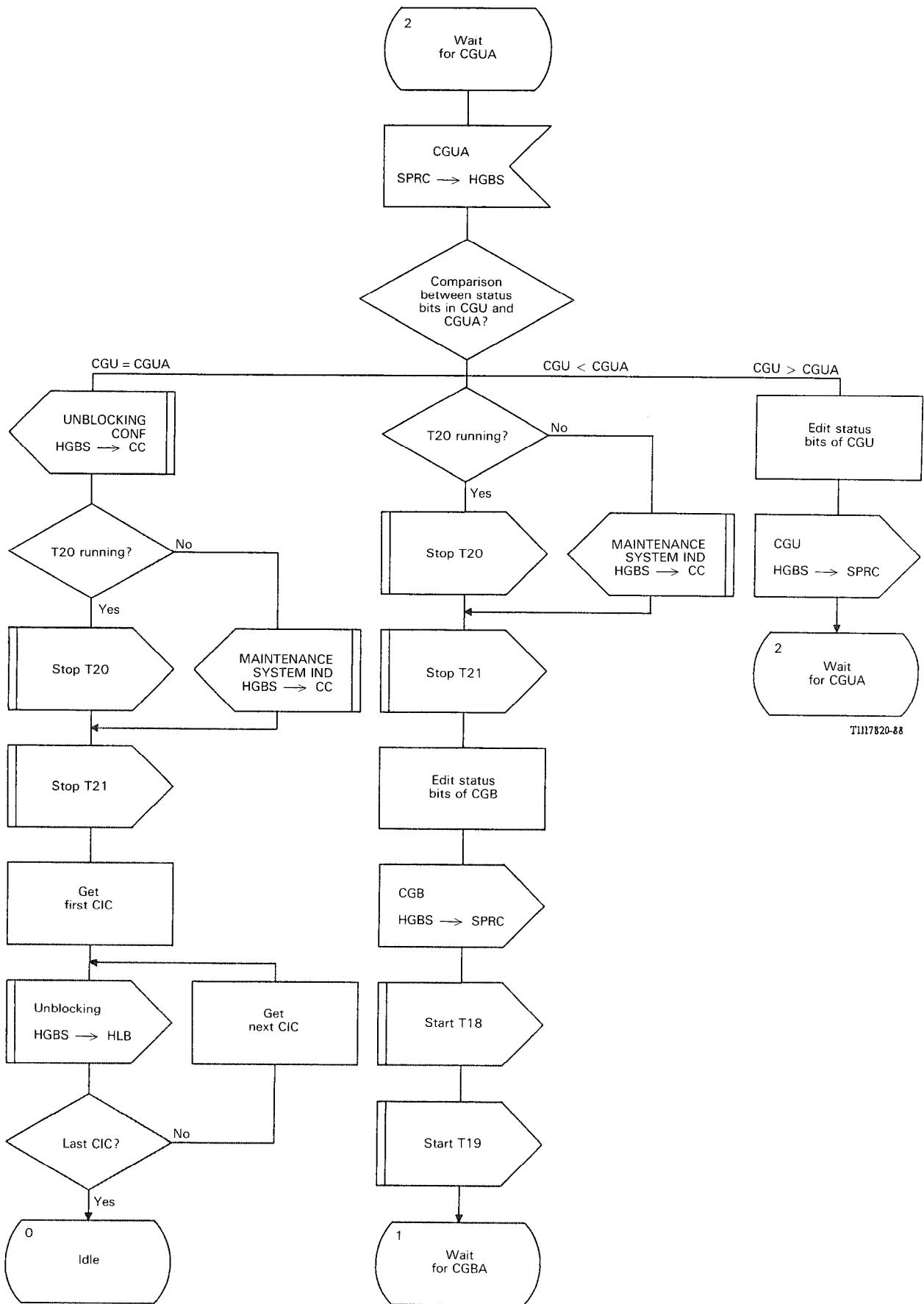

T1117820-88

FIGURE B-31/Q.764
(Sheet 5 of 6)

Hardware Failure Oriented Circuit Group Blocking and Unblocking Sending (HGBS)

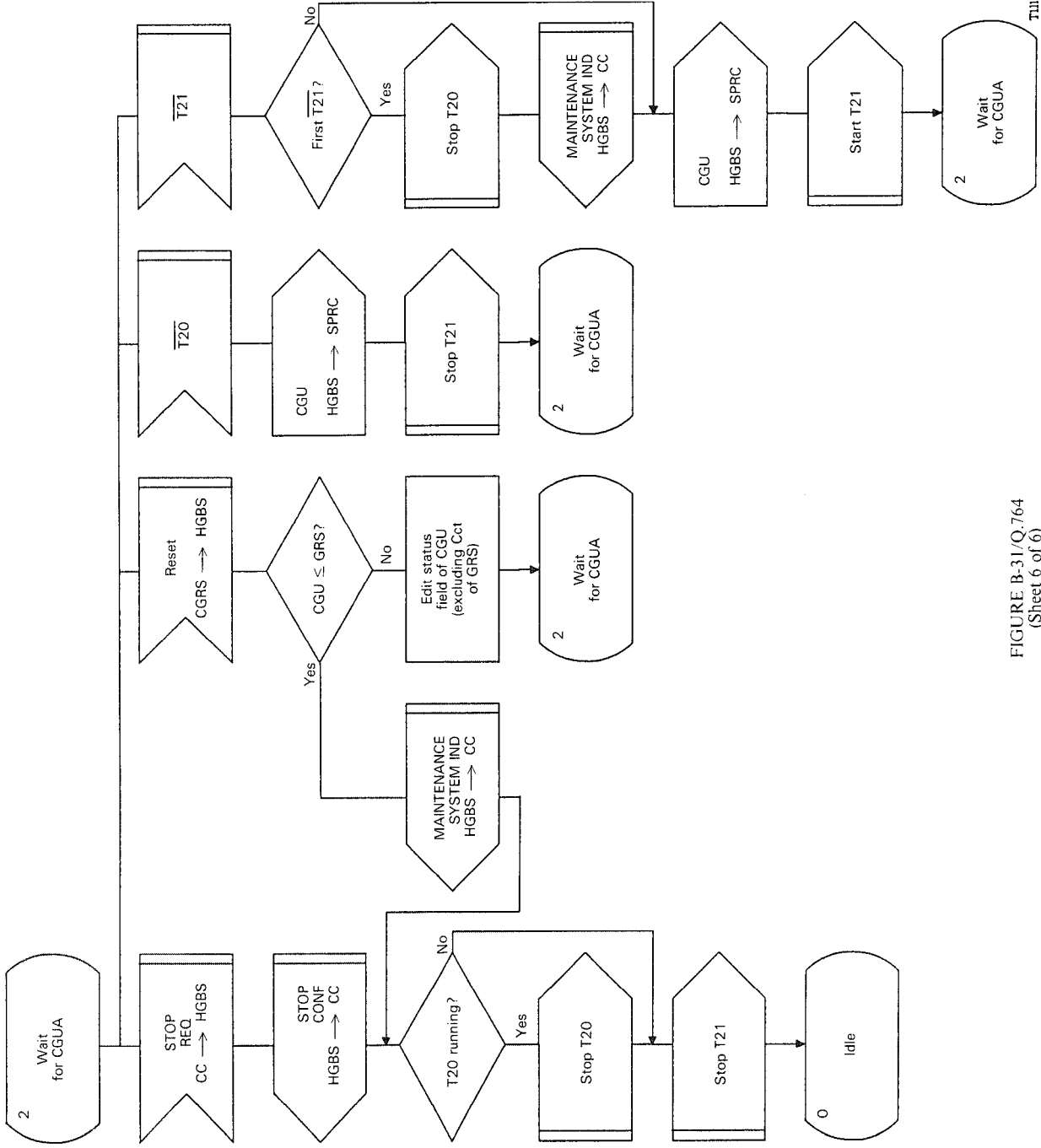
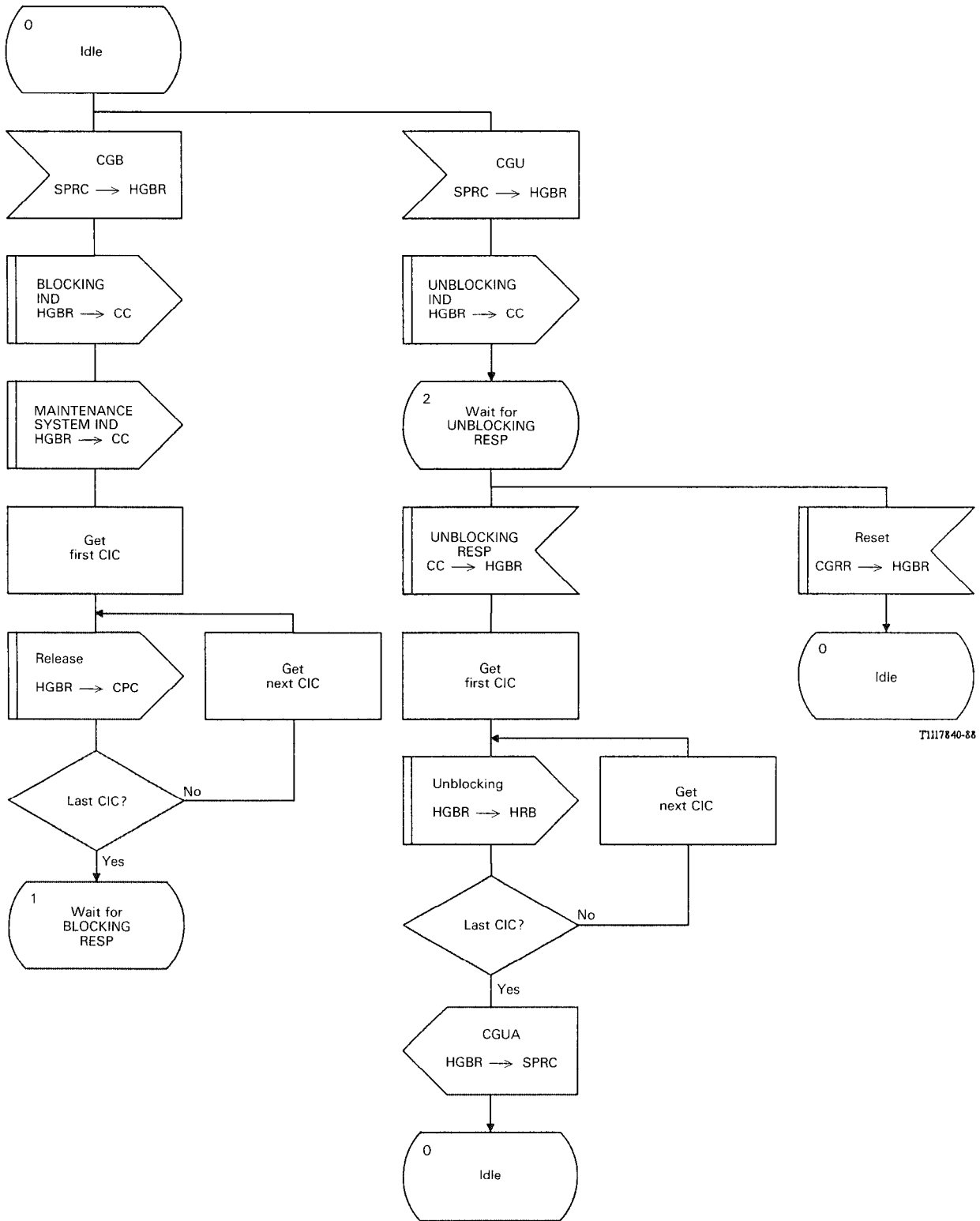

FIGURE B-31/Q.764
(Sheet 6 of 6)

Hardware Failure Oriented Circuit Group Blocking and Unblocking Sending (HGBS)

T1117830-88



TI117840-88

FIGURE B-32/Q.764
(Sheet 1 of 2)

Hardware Failure Oriented Circuit Group Blocking and Unblocking Reception (HGBR)

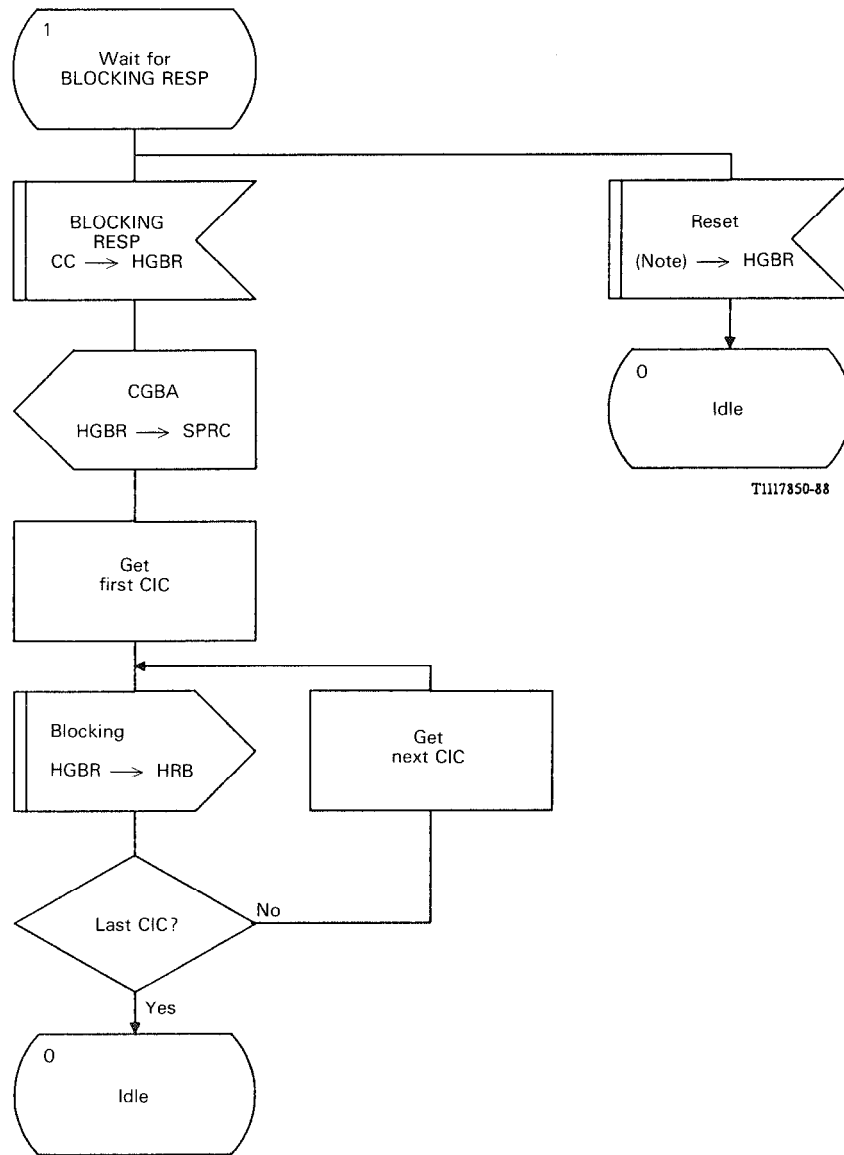

Note - CGRS, CGRR.

FIGURE B-32/Q.764
(Sheet 2 of 2)

Hardware Failure Oriented Circuit Group Blocking and Unblocking Reception (HGBR)

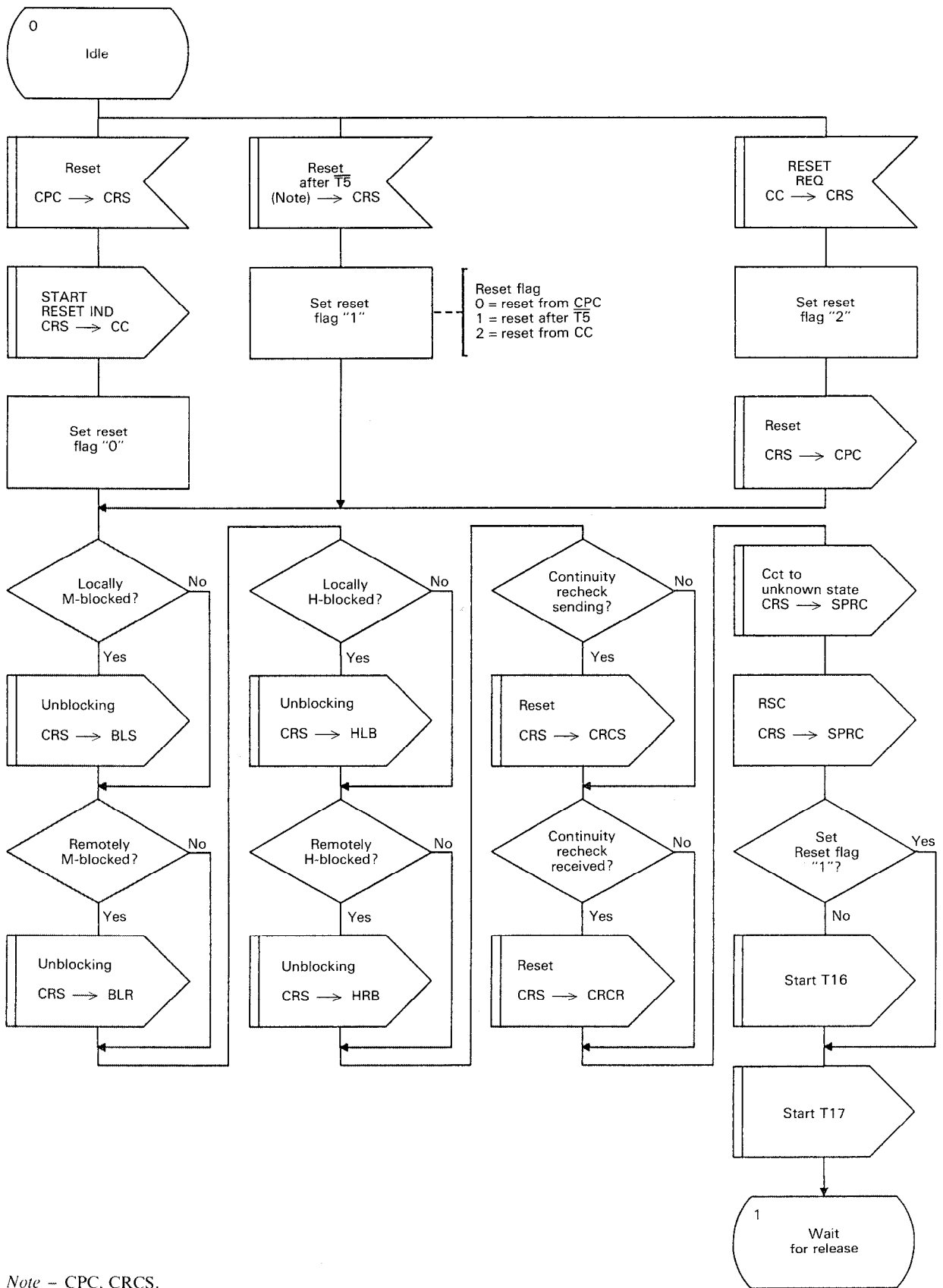

Note - CPC, CRCS.

T1117860-88

FIGURE B-33/Q.764
(Sheet 1 of 3)

Circuit Reset Sending (CRS)

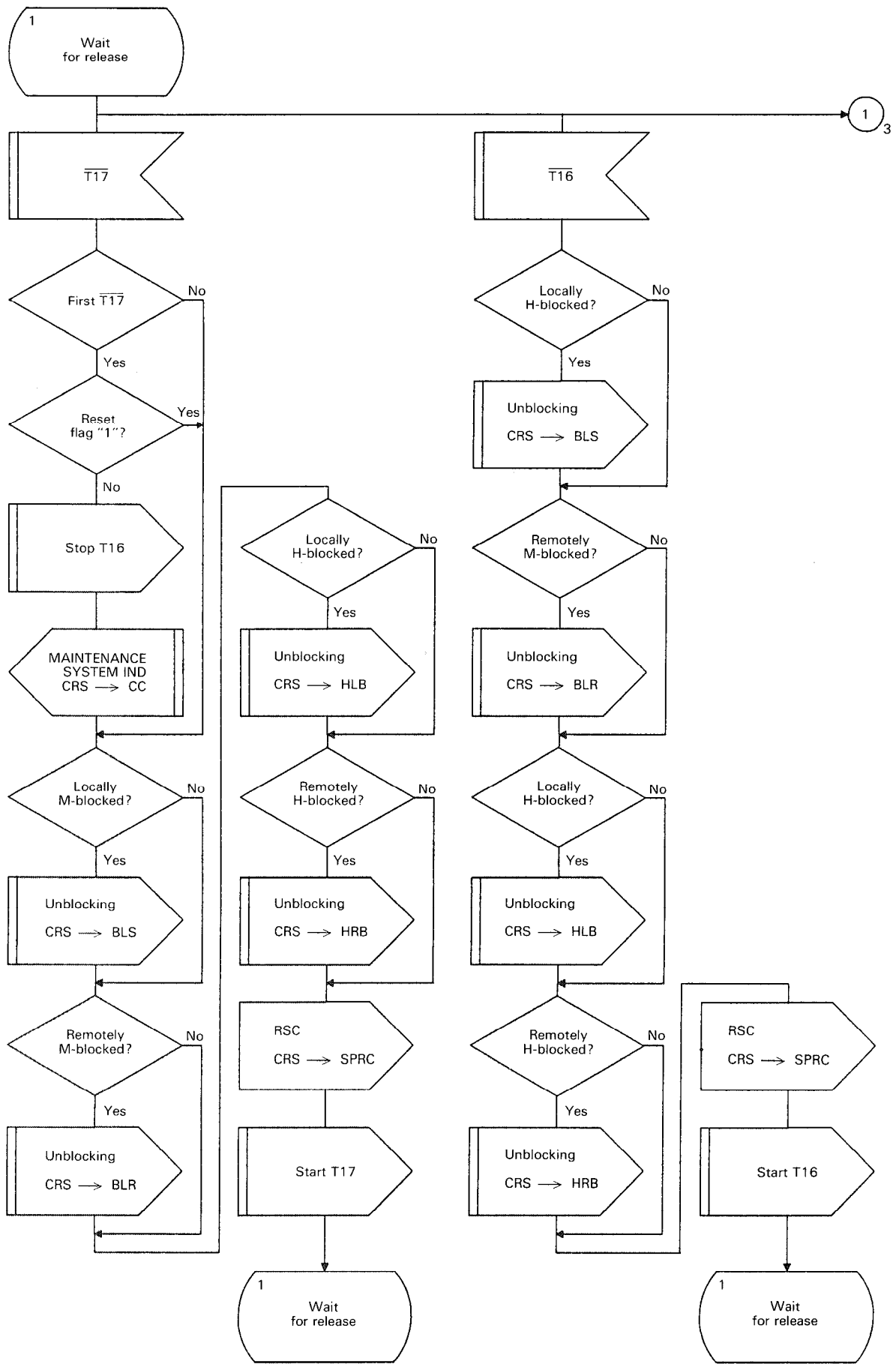

T1117870-88

FIGURE B-33/Q.764
 (Sheet 2 of 3)
Circuit Reset Sending (CRS)

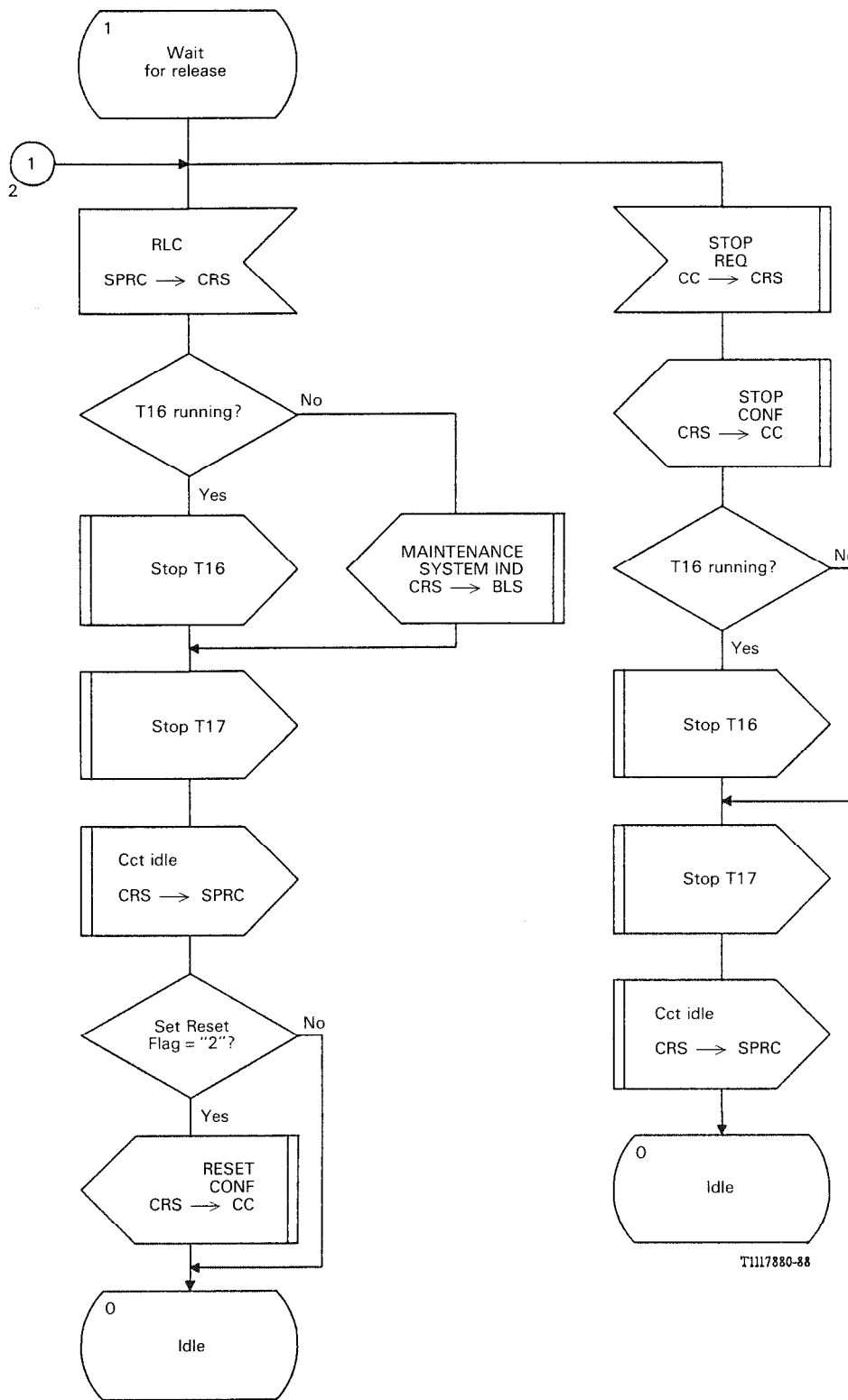
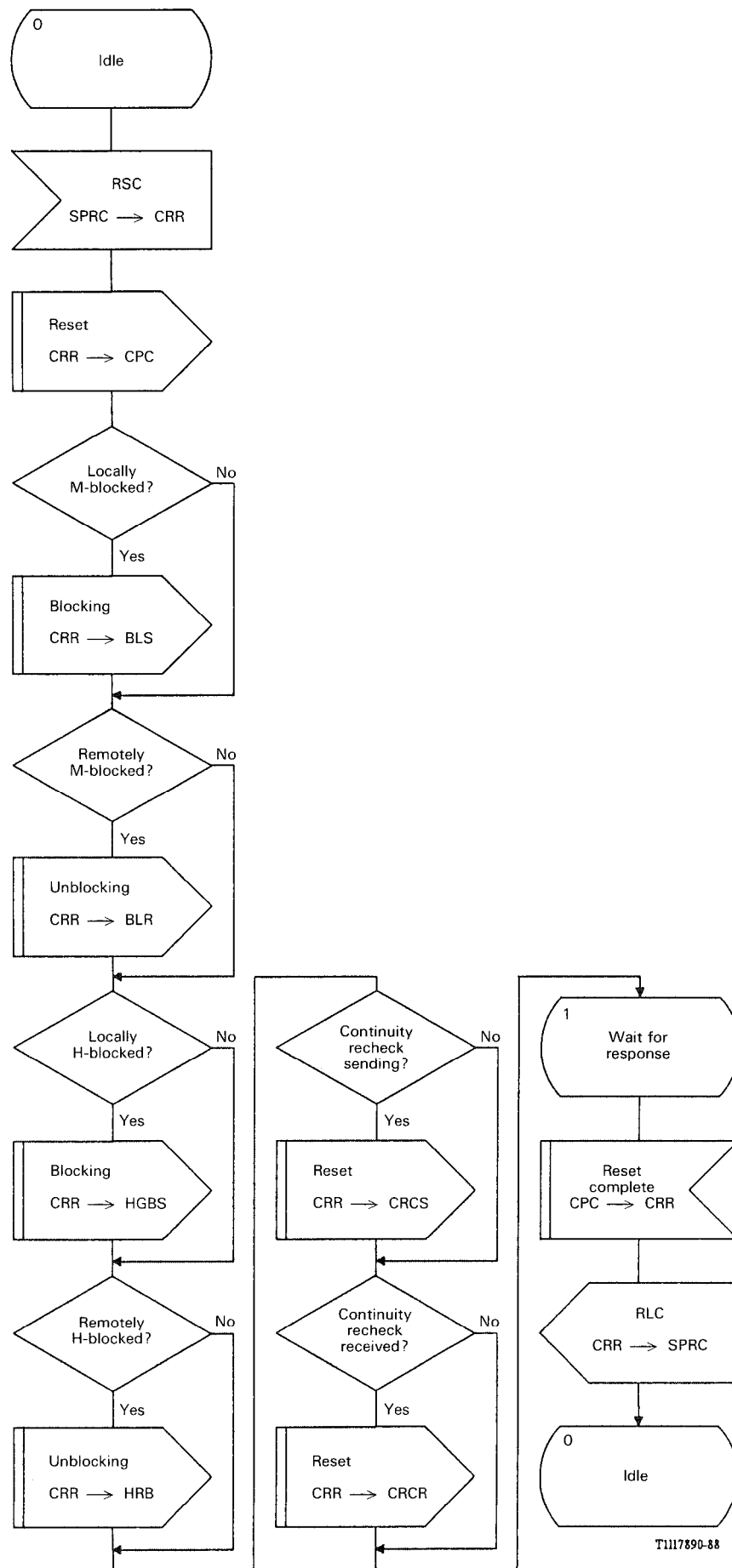

FIGURE B-33/Q.764
(Sheet 3 of 3)

Circuit Reset Sending (CRS)



T1117890-88

FIGURE B-34/Q.764
Circuit Reset Reception (CRR)

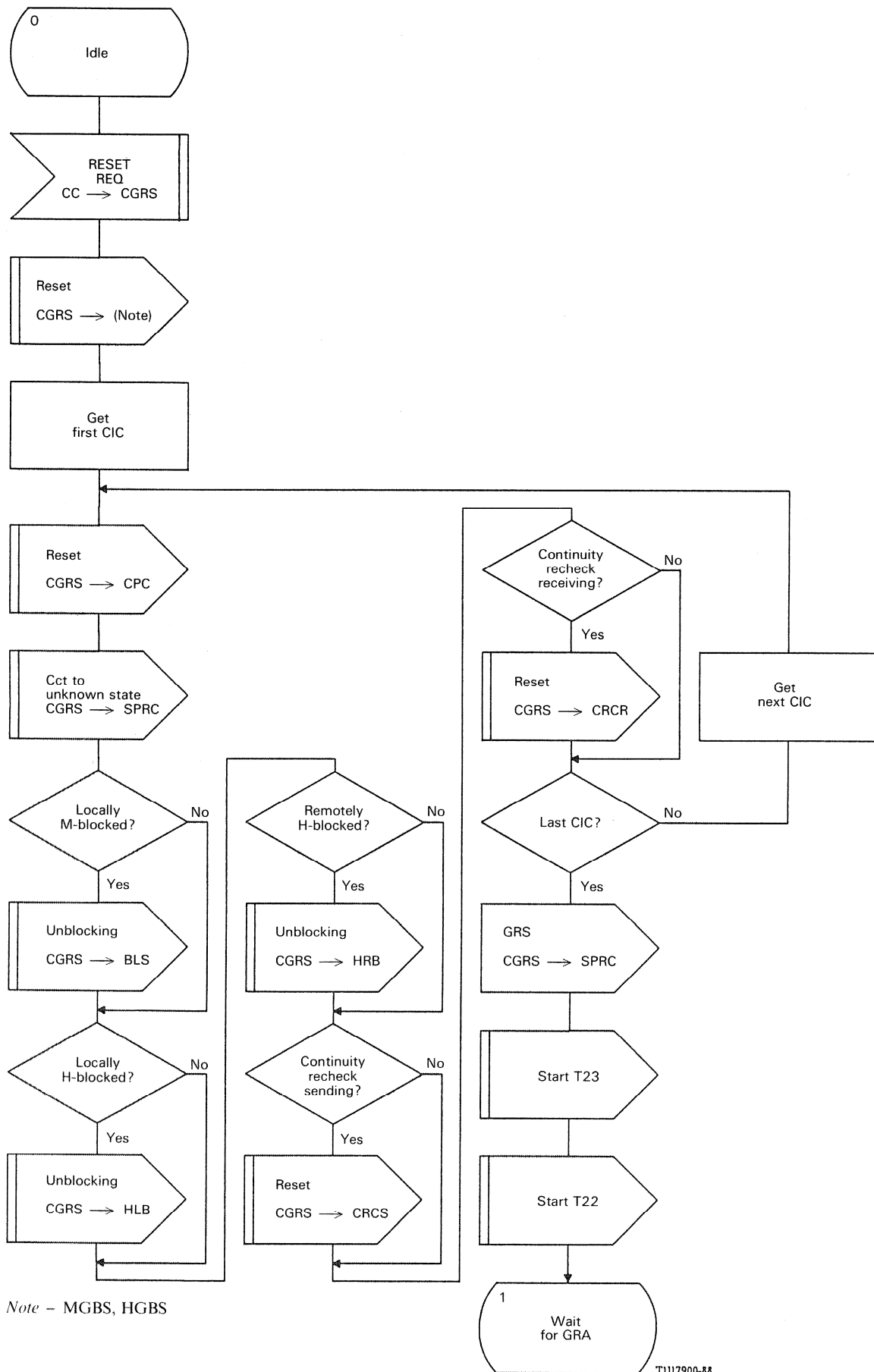

Note - MGBS, HGBS

FIGURE B-35/Q.764
(Sheet 1 of 3)
Circuit Group Reset Sending (CGRS)

T1117900-88

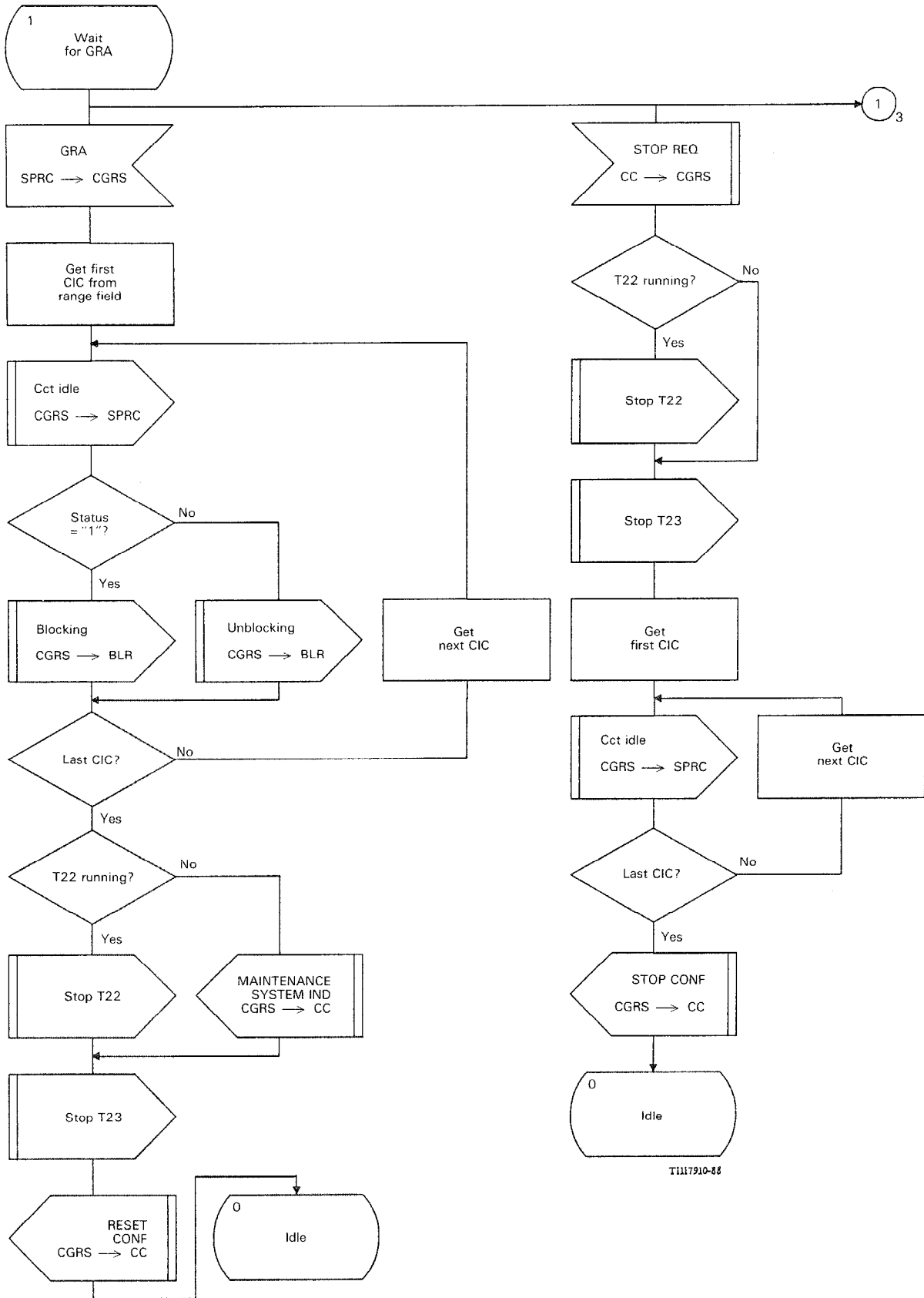

T1117910-88

FIGURE B-35/Q.764
(Sheet 2 of 3)
Circuit Group Reset Sending (CGRS)

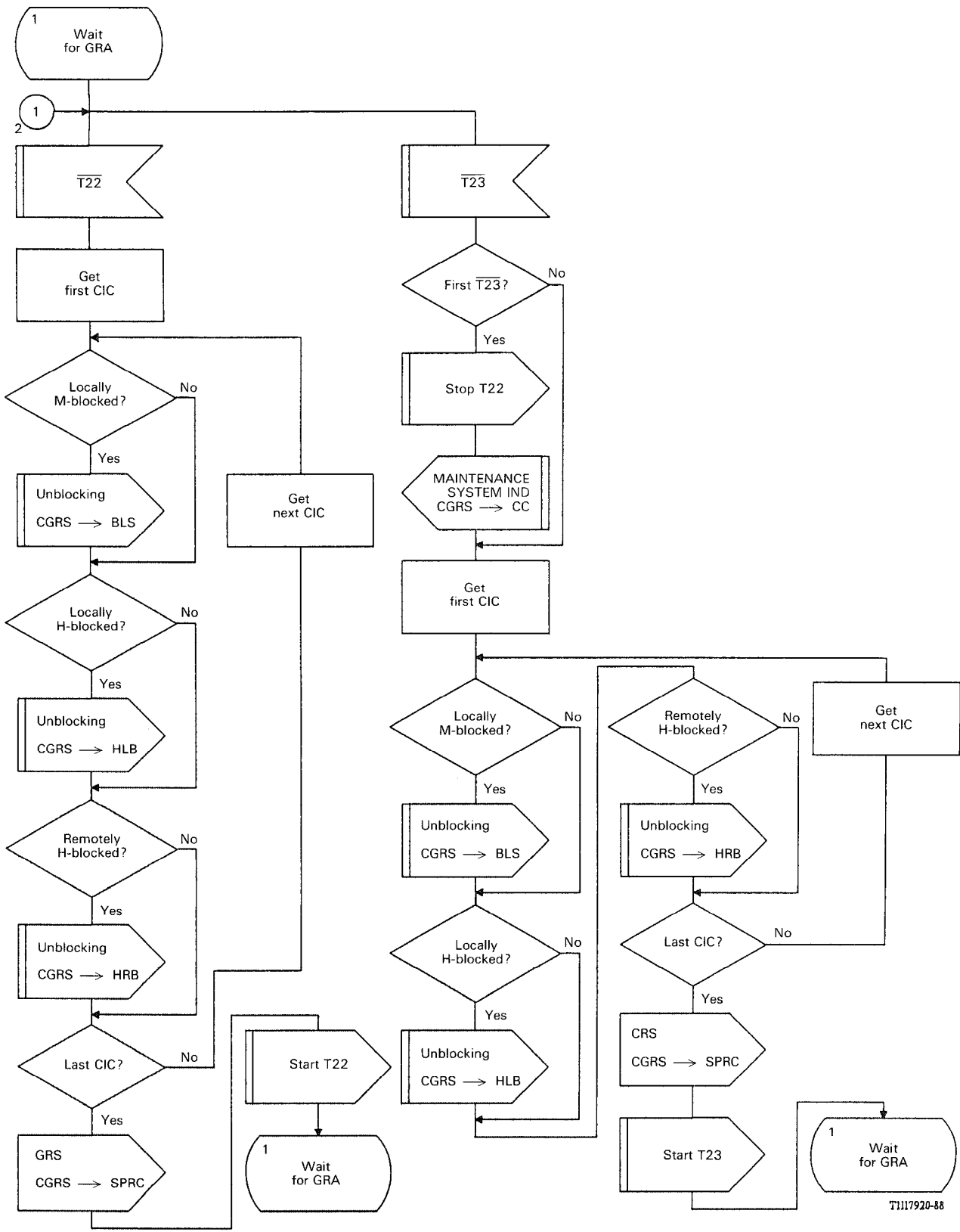

T1117920-88

FIGURE B-35/Q.764
(Sheet 3 of 3)

Circuit Group Reset Sending (CGRS)

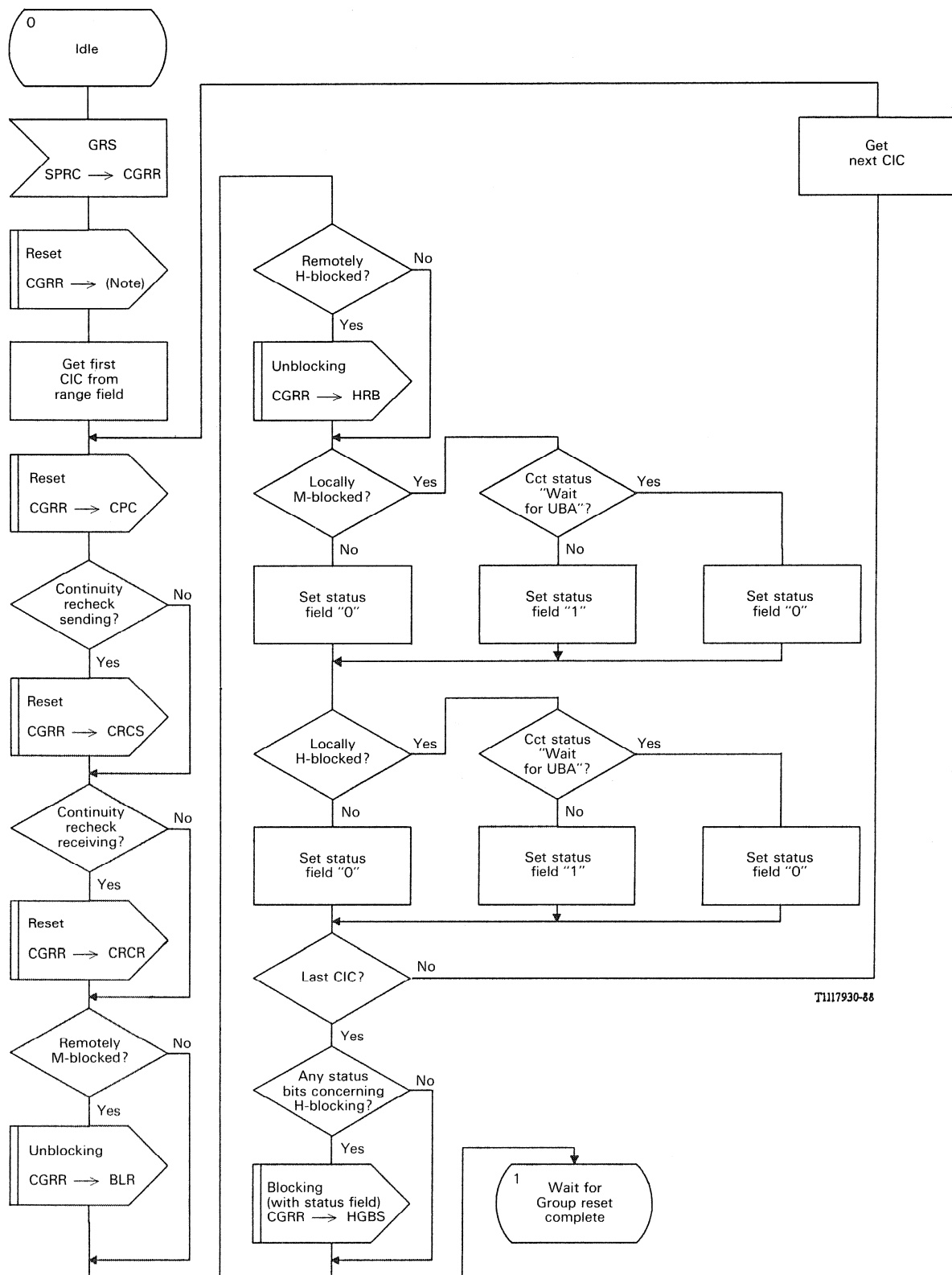

Note - MGBR, HGBR

FIGURE B-36/Q.764
(Sheet 1 of 2)

Circuit Group Reset Reception (CGRR)

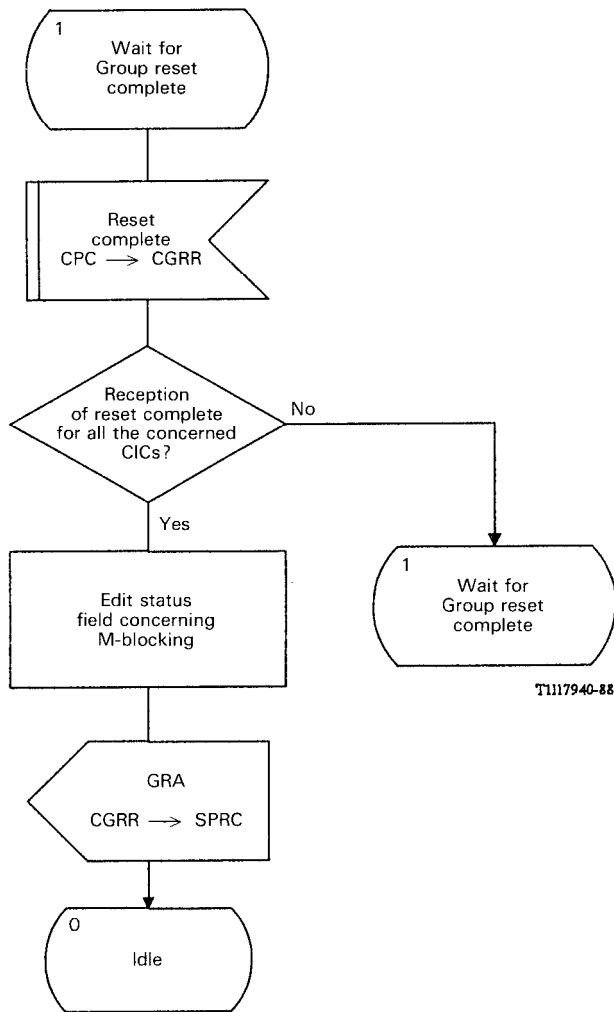
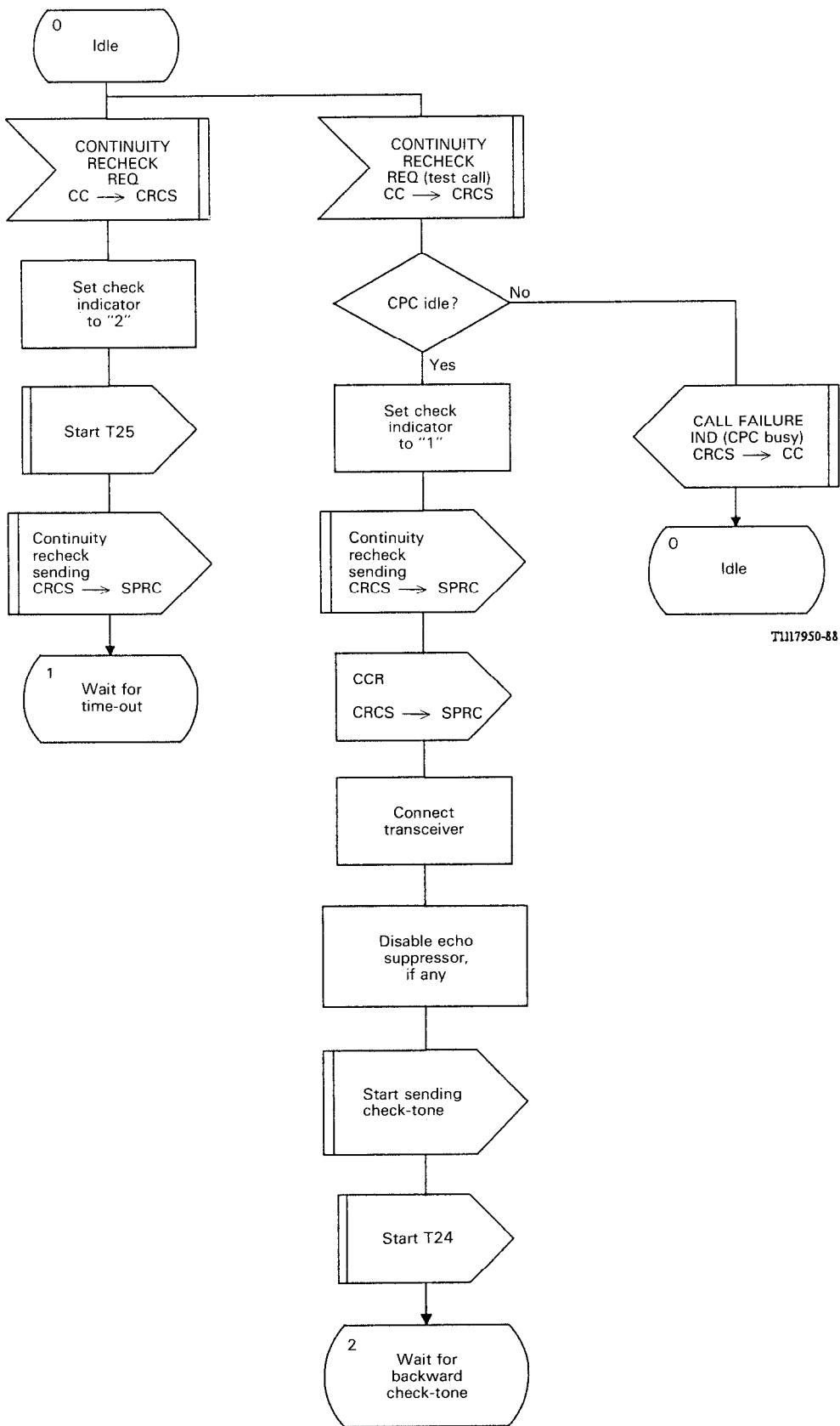

FIGURE B-36/Q.764
(Sheet 2 of 2)

Circuit Group Reset Reception (CGRR)



T1117950-88

FIGURE B-37/Q.764
(Sheet 1 of 6)

Continuity Recheck Sending (CRCS)

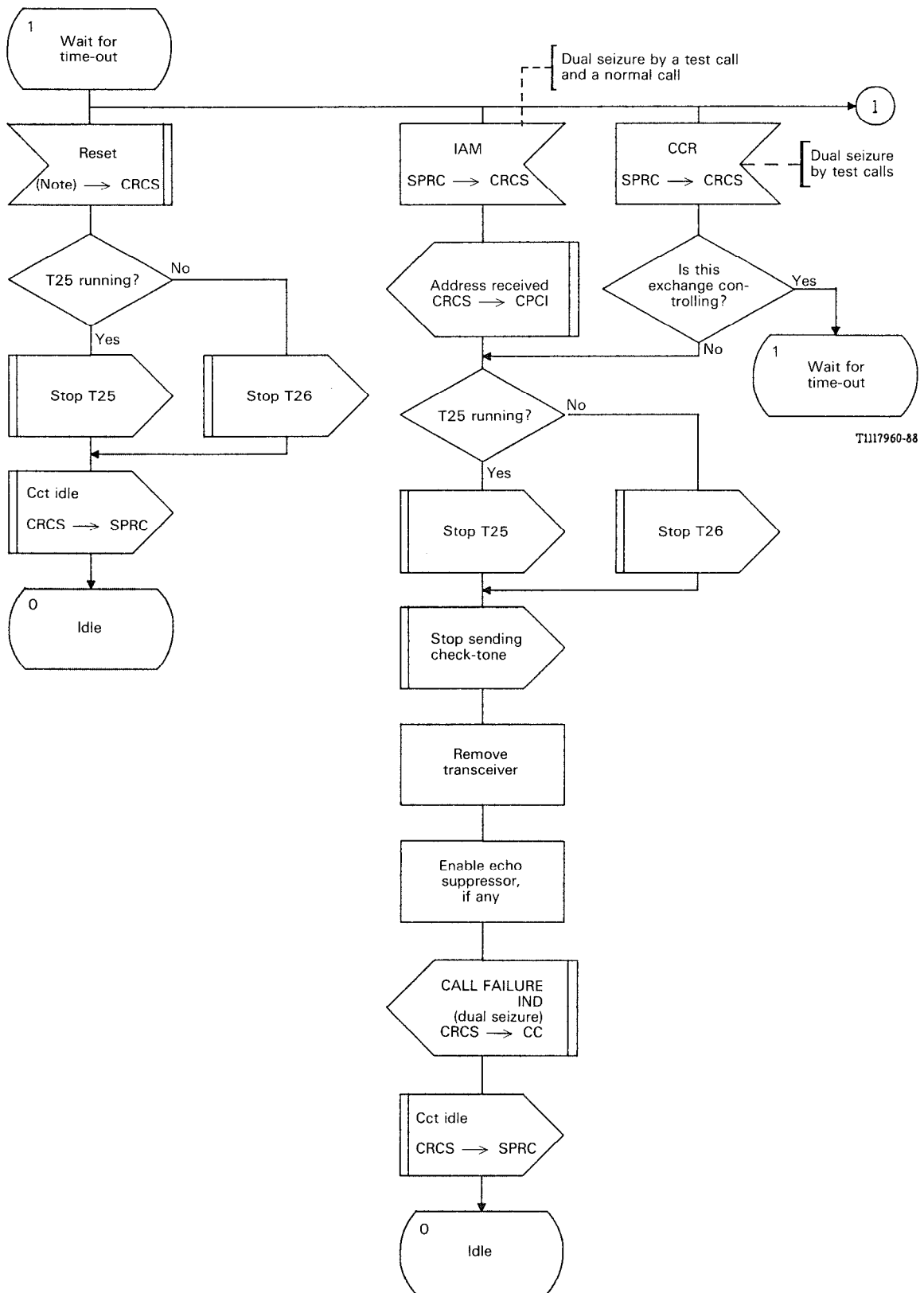

Note - CRS, CRR, CGRS, CGRR.

FIGURE B-37/Q.764
(Sheet 2 of 6)

Continuity Recheck Sending (CRCS)

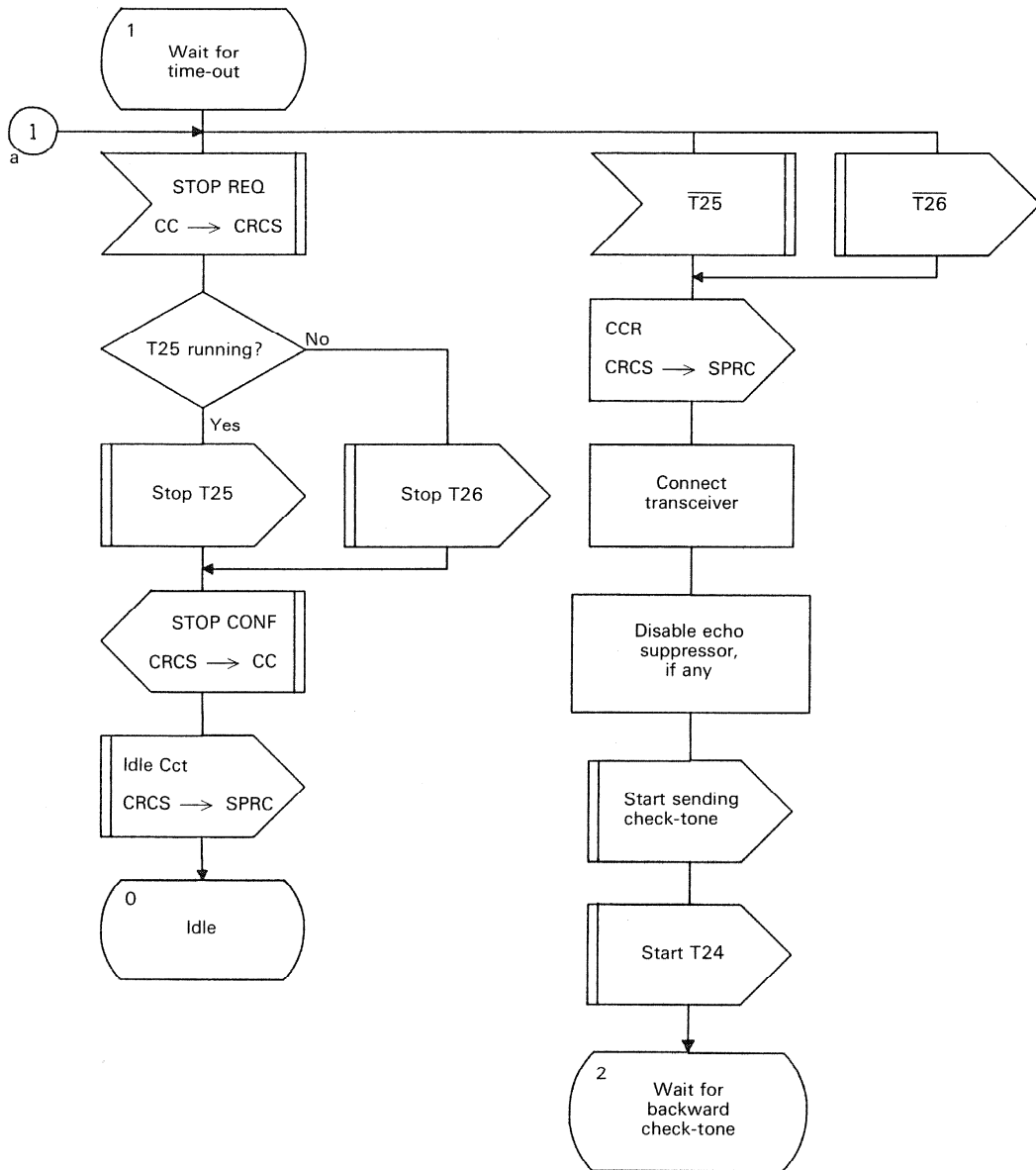

T1117970-88

FIGURE B-37/Q.764
(Sheet 3 of 6)

Continuity Recheck Sending (CRCS)

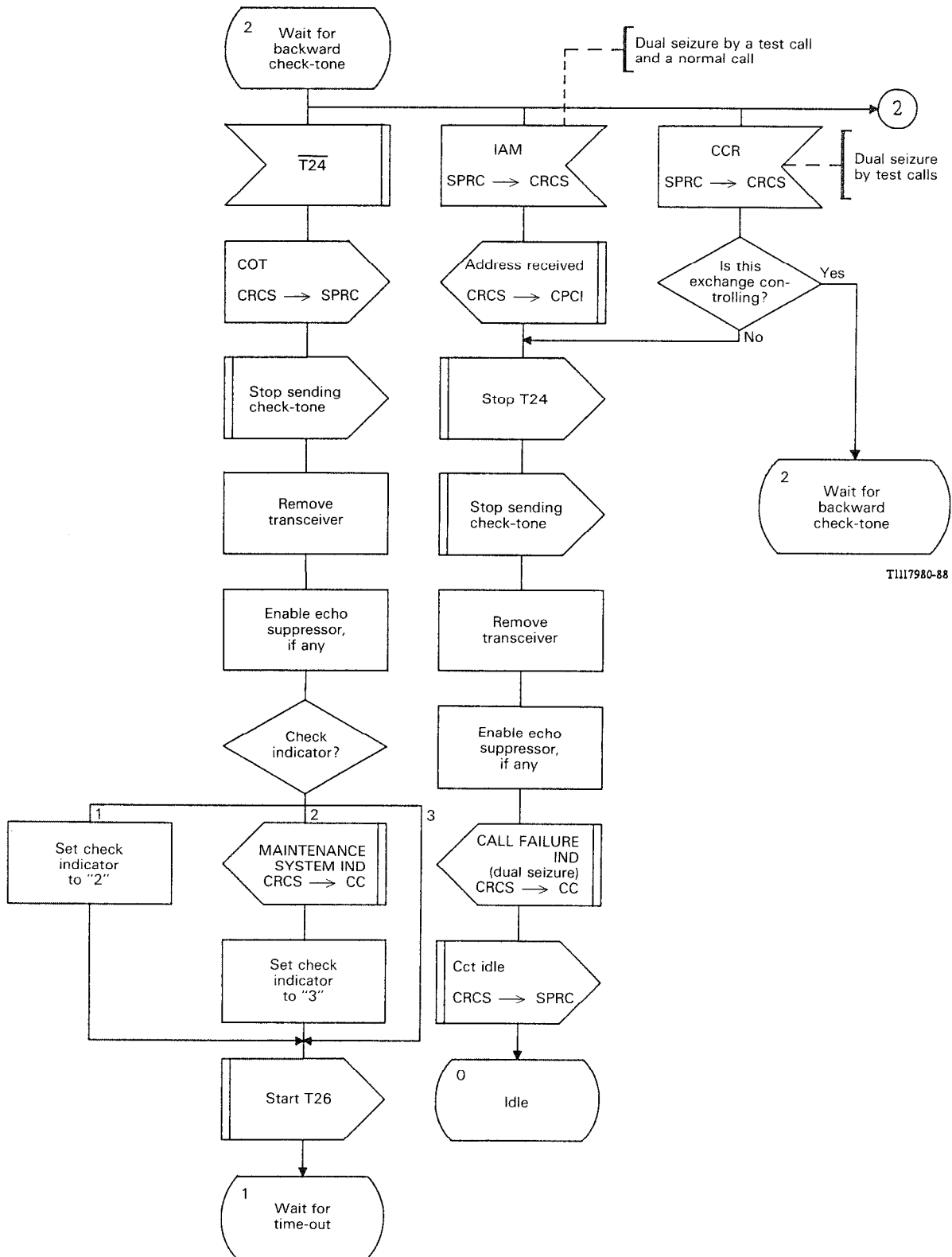

TI117980-88

FIGURE B-37/Q.764
(Sheet 4 of 6)

Continuity Recheck Sending (CRCS)

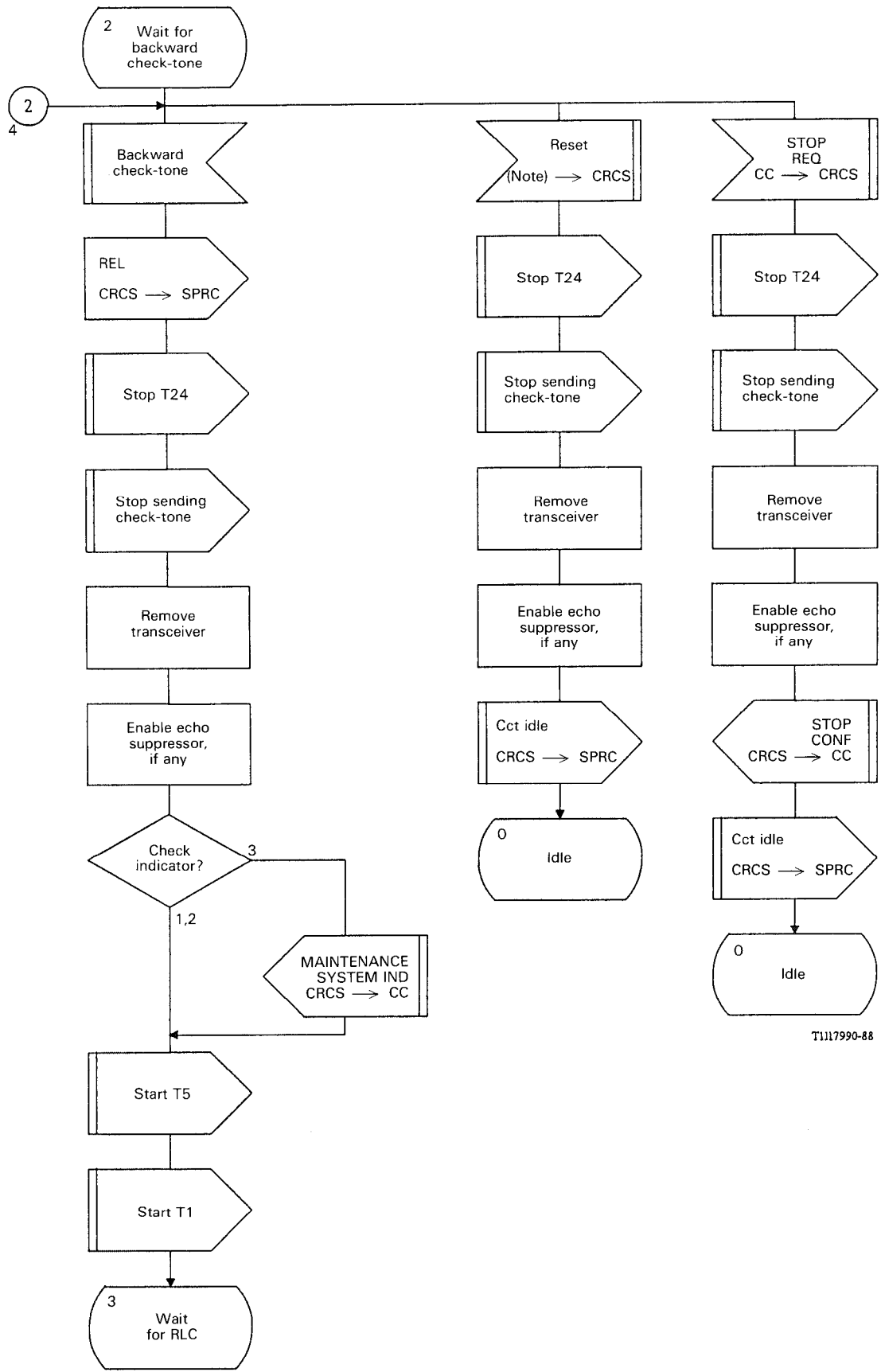

T1117990-88

Note - CRS, CRR, CGRS, CGRR.

FIGURE B-37/Q.764
(Sheet 5 of 6)

Continuity Recheck Sending (CRCS)

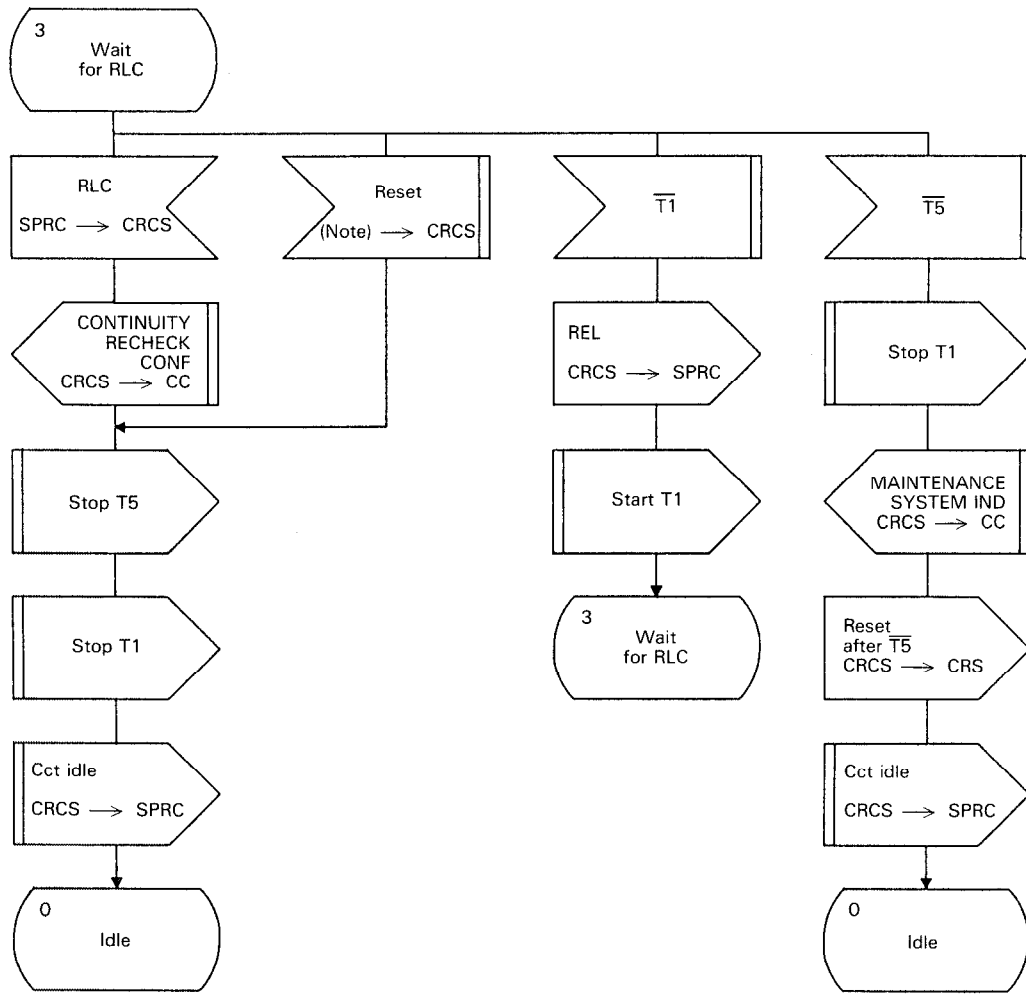

Note - CRS, CRR, CGRS, CGRR.

T1118000-88

FIGURE B-37/Q.764
(Sheet 6 of 6)

Continuity Recheck Sending (CRCS)

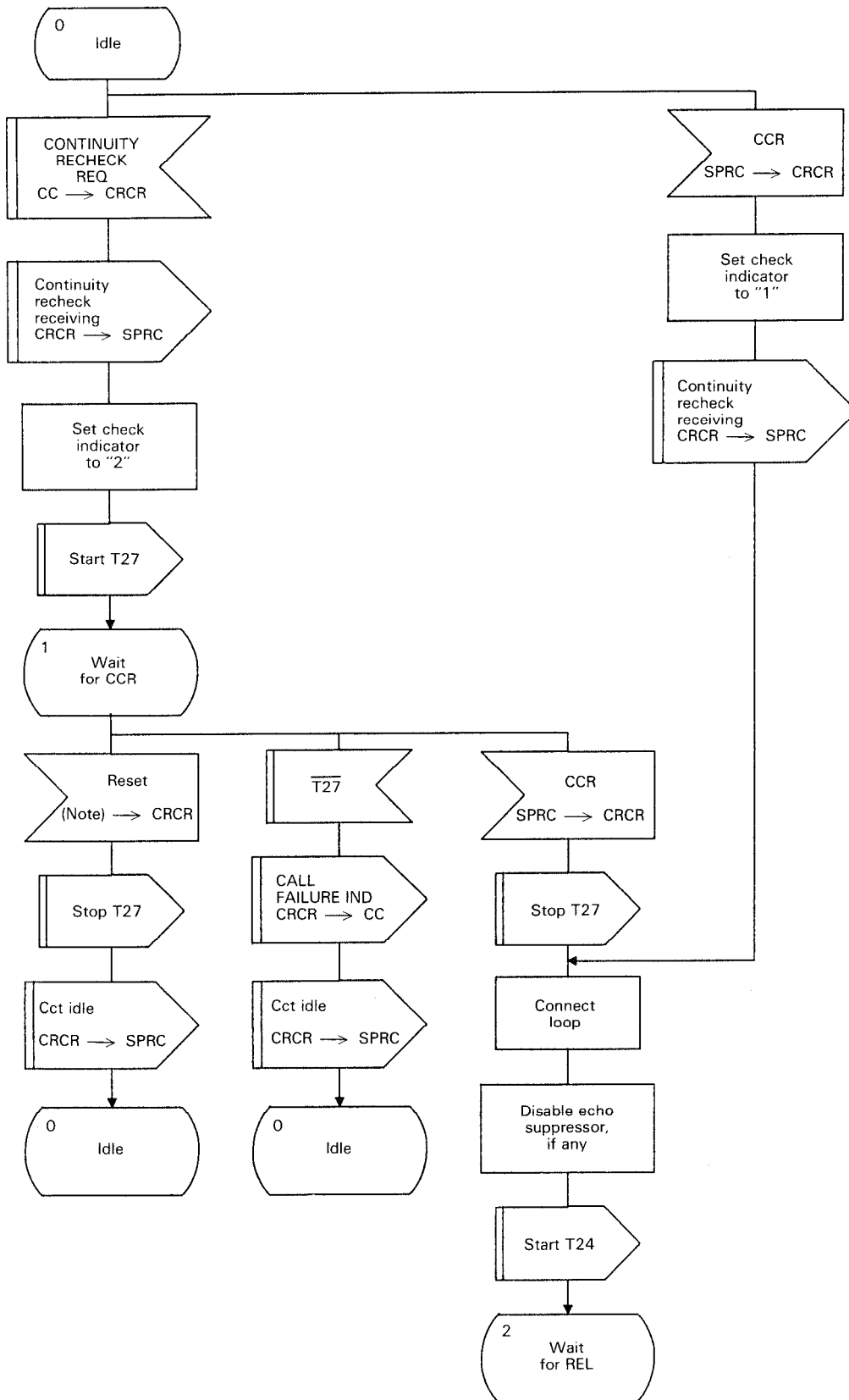

Note - CRS, CRR, CGRS, CCRR.

TJ118010-88

FIGURE B-38/Q.764
(Sheet 1 of 2)

Continuity Recheck Reception (CRCR)

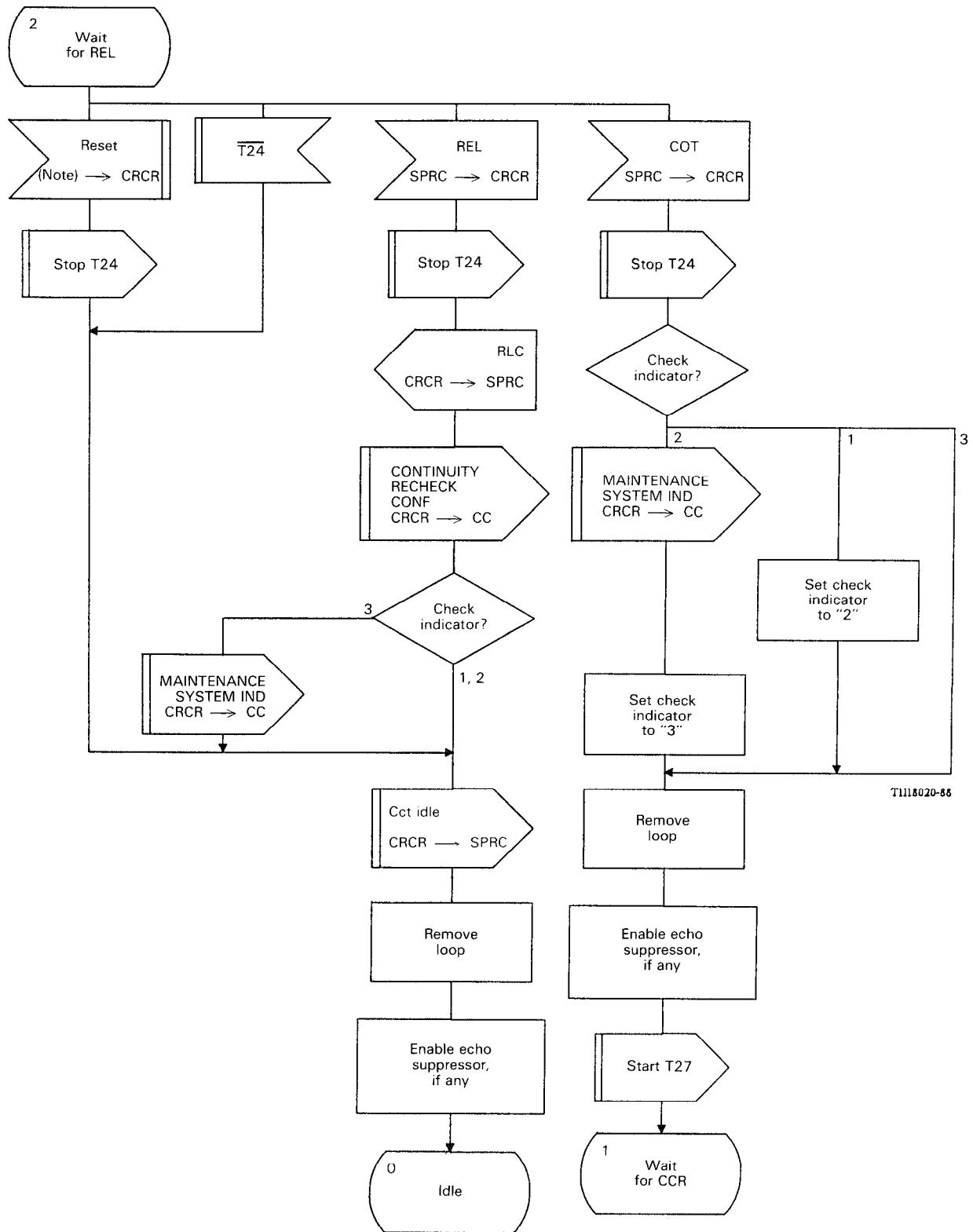

Note – CRS, CRR, CGRS, CGRR.

FIGURE B-38/Q.764
(Sheet 2 of 2)

Continuity Recheck Sending (CRCS)

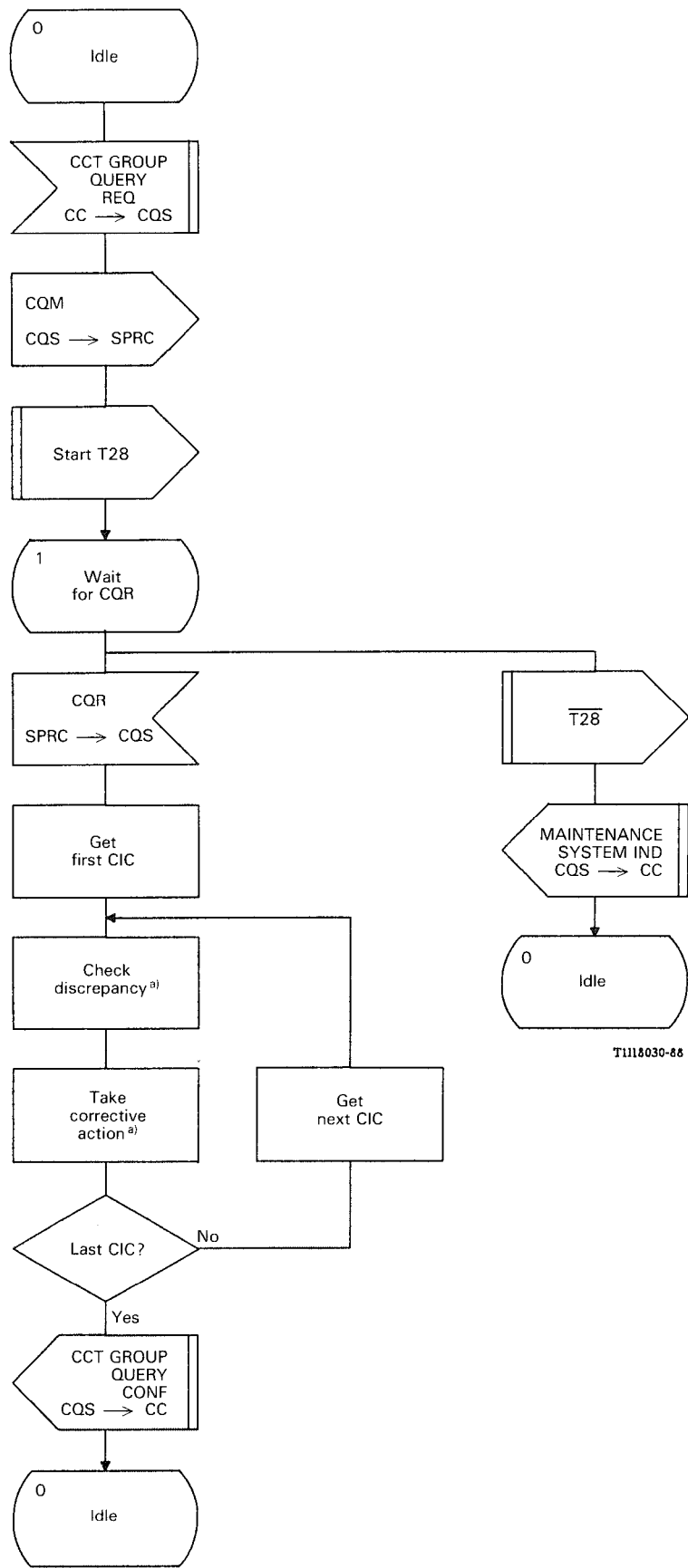

T1118030-88

^{a1} To be specified.

FIGURE B-39/Q.764
Circuit Group Query Sending (CQS)

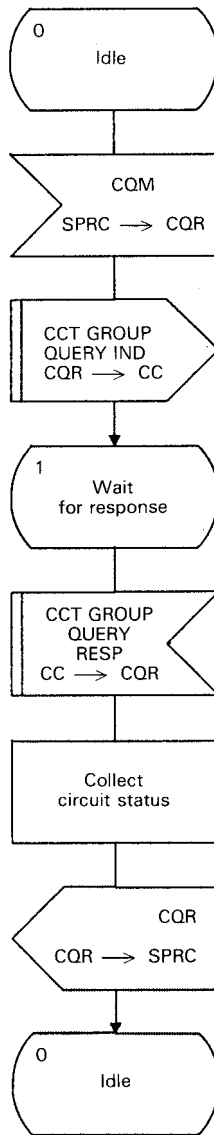

T1118040-88

FIGURE B-40/Q.764
Circuit Group Query Reception (CQR)

APPENDIX I

(to Recommendation Q.764)

Contents of the interface elements between the ISDN user part and the SCCP

These interface elements are defined in SCCP Recommendations (Q.711-Q.716) and are included here for information.

I.1 *Contents of the REQUEST type 1*

The REQUEST type 1 interface element may contain the following parameters:

- connection identification (for further study);
- receipt confirmation selection;
- expedited data selection;
- quality of service parameter set.

I.2 *Contents of the REQUEST type 2*

The REQUEST type 2 interface element may contain the following parameters:

- network indicator (for further study);
- protocol class;
- credit;
- connection identification (for further study);
- source local reference;
- originating signalling point code;
- reply request;
- refusal indicator.

I.3 *Contents of the REPLY*

The REPLY interface element may contain the following parameters:

- source local reference;
- protocol class;
- credit;
- connection identification (for further study).

ITU-T RECOMMENDATIONS SERIES

Series A	Organization of the work of the ITU-T
Series B	Means of expression: definitions, symbols, classification
Series C	General telecommunication statistics
Series D	General tariff principles
Series E	Overall network operation, telephone service, service operation and human factors
Series F	Non-telephone telecommunication services
Series G	Transmission systems and media, digital systems and networks
Series H	Audiovisual and multimedia systems
Series I	Integrated services digital network
Series J	Transmission of television, sound programme and other multimedia signals
Series K	Protection against interference
Series L	Construction, installation and protection of cables and other elements of outside plant
Series M	TMN and network maintenance: international transmission systems, telephone circuits, telegraphy, facsimile and leased circuits
Series N	Maintenance: international sound programme and television transmission circuits
Series O	Specifications of meafing equipment
Series P	Telephone transmission quality, telephone installations, local line networks
Series Q	Switching and signalling
Series R	Telegraph transmission
Series S	Telegraph services terminal equipment
Series T	Terminals for telematic services
Series U	Telegraph switching
Series V	Data communication over the telephone network
Series X	Data networks and open system communications
Series Y	Global information infrastructure and Internet protocol aspects
Series Z	Languages and general software aspects for telecommunication systems