



INTERNATIONAL TELECOMMUNICATION UNION

CCITT

Q.767

THE INTERNATIONAL
TELEGRAPH AND TELEPHONE
CONSULTATIVE COMMITTEE

**SPECIFICATIONS
OF SIGNALLING SYSTEM No. 7**

**APPLICATION OF THE ISDN USER PART
OF CCITT SIGNALLING SYSTEM No. 7 FOR
INTERNATIONAL ISDN INTERCONNECTIONS**

Recommendation Q.767



Geneva, 1991

FOREWORD

The CCITT (the International Telegraph and Telephone Consultative Committee) is a permanent organ of the International Telecommunication Union (ITU). CCITT is responsible for studying technical, operating and tariff questions and issuing Recommendations on them with a view to standardizing telecommunications on a worldwide basis.

The Plenary Assembly of CCITT which meets every four years, establishes the topics for study and approves Recommendations prepared by its Study Groups. The approval of Recommendations by the members of CCITT between Plenary Assemblies is covered by the procedure laid down in CCITT Resolution No. 2 (Melbourne, 1988).

Recommendation Q.767 was prepared by Study Group XI and was approved under the Resolution No. 2 procedure on the 15th of February 1991.

CCITT NOTE

In this Recommendation, the expression "Administration" is used for conciseness to indicate both a telecommunication Administration and a recognized private operating agency.

© ITU 1991

All rights reserved. No part of this publication may be reproduced or utilized in any form or by any means, electronic or mechanical, including photocopying and microfilm, without permission in writing from the ITU.

Recommendation Q.767

APPLICATION OF THE ISDN USER PART OF CCITT SIGNALLING SYSTEM No. 7 FOR INTERNATIONAL ISDN INTERCONNECTIONS

1 Introduction

ISDN international interconnections have to be realized between non homogeneous ISDNs that differ in terms of services supported, national network signalling system and national access protocol.

In order to perform such international ISDN interconnections, it is required to specify unambiguously and without options:

- the service capabilities of the international signalling system;
- the international signalling interface, i.e., the signalling information elements and messages sent and received on the international signalling section and the related procedures;
- all additional information, which is not specifically signalling system related, but which is needed to absorb the potential differences between the national networks.

Section 2 of this Recommendation describes the list of services supported by the ISUP international interface.

Section 3 contains the definition of the international ISUP signalling specification, in terms of exceptions/clarifications to the existing Blue Book ISUP text.

Section 4 contains additional information to ease international ISDN interconnections. This “Guidelines” section should be understood as a “user's guide” for international ISDN interconnection. One of the objectives is to highlight possible areas of difficulty and propose standard solutions, that should be applied as far as possible by international operators.

The Annexes A to E contain the complete revised Blue Book text. Sections 1 to 4 have precedence over the content of Annexes A to E.

Blue Book SDLs have not been revised and are therefore not applicable to Recommendation Q.767.

2 Services supported

The following services are supported by the first version of the ISUP international interface, specified in Recommendation Q.767. The services supported by the international interface have not to be fully supported in a national network.

The relevant CCITT Recommendations are indicated per service, with the possible modifications/simplifications applied for international operation of the service.

2.1 Bearer services

The following bearer services are supported by the international interface:

- 64 kbits/s unrestricted (Recommendation I.231.1);
- Speech (Recommendation I.231.2);
- 3.1 kHz audio (Recommendation I.231.3).

Semi permanent switched connections are considered as non ISUP controlled, and are, therefore, outside the scope of this document.

2.2 Teleservices

The following teleservices are supported:

- Telephony (Recommendation I.241.1);
- Teletex (Recommendation I.241.2);
- Telefax Gr 4 (Recommendation I.241.3);
- Mixed mode (Recommendation I.241.4);
- Videotex (Recommendation I.241.5);
- Telefax Gr 2/3.

2.3 Supplementary services

The following supplementary services are supported:

- CLIP/CLIR as described in Recommendation I.251.3/4;
- COLP/COLR as described in Recommendation I.251.5/6;
- CUG as described in Recommendation I.255.1;
- UUS 1 implicit as described in Recommendation I.257.1.

Direct Dialling In and Multiple Subscriber Number are without significance to the international interface.

Subaddressing and terminal portability are implicitly supported, as part of the basic Q.767 procedures.

2.4 *Interworking between ISDN and PSTN/IDN*

Interworking between ISDN and PSTN/IDN is supported for the following services:

- telephony;
- voice band data;
- digital connectivity.

3 Exceptions and clarification to the Blue Book ISUP Recommendations

3.1 *General*

The objective of this section is to specify the exceptions to CCITT Recommendations:

- Q.761 (Functional description of the ISDN User Part of CCITT Signalling System No. 7);
- Q.762 (General functions of CCITT Signalling System No. 7 ISDN User Part Messages and parameters);
- Q.763 (Formats and codes of CCITT Signalling System No. 7 ISDN User Part Messages and parameters);
- Q.764 (Signalling procedures for CCITT Signalling System No. 7 ISDN User Part);
- Q.730 (ISDN supplementary services),

with deletions, clarifications etc., for international application. The following information is presented as an exceptions document which should be read in conjunction with Recommendations Q.761 to Q.764 and Q.730. Annexes A to E contain the complete revised text.

Those parts of the CCITT Recommendation which have not been listed as exceptions and are not relevant to international interconnection should only be used as additional information to aid understanding. Although this Recommendation applies only to the international signalling section, the specification of functions, formats and codes of messages and signals, and actions performed at originating and destination local exchanges is retained.

An international gateway mainly performs functions like a normal transit exchange in all cases where the national ISDN User Part implementation is the same as the implementation of the ISDN User Part for the international signalling section. In the case where a national signalling system behaves differently, the international gateway exchange has to support both the concerned national and the international network and the services and equipments supported by both the concerned national and the international network.

3.2 *Exceptions and clarifications to Recommendation Q.761*

Table 1/Q.767 contains three columns as follows:

- the first column marked “Section” identifies the relevant section of Recommendation Q.761;
- the second column marked “Title” identifies the relevant subject of Recommendation Q.761;
- the third column marked “Remarks” identifies the deviations from Recommendation Q.761 as appropriate for the international signalling section.

No remark is made against national options. It is assumed that they will not occur on an international relation.

All subsections are the same as in Recommendation Q.761 unless indicated otherwise in Table 1/Q.767 below.

TABLE 1/Q.767

Q.761 Section	Title	Remarks
1	General	4th paragraph: SCCP is not used
2	Services supported by the ISDN User Part	The list of services and supplementary services is contained in Rec. Q.767, § 2.
3.2.4	Status	a) Delete in the 1st paragraph, 1st sentence: "or the ISDN User part at the destination is unavailable" b) The note to Table 1/Q.761 reads: "The cause parameter can assume one value: — signalling network congested."
4	End-to-end signalling	Not applicable

3.3 *Exceptions and clarifications to Recommendation Q.762*

Table 2/Q.767 contains three columns as follows:

- the first column marked “Section” identifies the relevant section of Q.762;

- the second column marked “Title” identifies the relevant subject of Q.762;

- the third column marked “Remarks” identifies the deviations from Q.762 as appropriate for the international signalling section.

All subsections are the same as in Recommendation Q.762 unless indicated otherwise in Table 2/Q.767 below.

The remark “Not used” in the table means that a message, parameter or indicator should not be generated at an outgoing or incoming gateway exchange towards the international signalling network and if such a message, parameter or indicator is received by an international exchange the procedures defined in Recommendation Q.764, § 2.10.5 in combination with the remarks listed in the § 3.5 of Recommendation Q.767 against § 2.10.5 of Recommendation Q.764 are invoked.

The remark “Default value is used” in the table means that an indicator is seen on the international interface, but only one value is allowed to be sent.

The remark “Default coding is used” in the table means that a parameter is seen on the international interface, but only one coding is allowed to be sent.

No remark is made against messages and parameters marked “For national use”. It is assumed that they will not appear on an international relation.

Paragraph 3.3.1 contains definitions for additional messages, parameters and indicators.

TABLE 2/Q.767 (sheet 1 of 4)

Q.762 section	Title	Remarks
1.5	Call modification completed message (CMC)	Not used
1.6	Call modification reject message (CMRJ)	Not used
1.7	Call modification request message (CMR)	Not used
1.16	Circuit group query message (CQM)	Not used
1.17	Circuit group query response message (CQR)	Not used
1.18	Confusion message (CFN)	Not used
1.23	Facility accepted message (FAA)	Not used
1.24	Facility rejected message (FRJ)	Not used
1.25	Facility request message (FAR)	Not used
1.27	Information message (INF)	Not used
1.28	Information request message (INR)	Not used
1.32	Pass-along message (PAM)	Not used
1.33	Release message (REL)	Delete last sentence "In case the call..."
1.42	User to user information message (USR)	Not used
2.2	Address presentation restricted indicator	Last sentence changed It is also used to indicate the non-availability of the address
2.5	Call forwarding may occur indicator	Default value is used
2.6	Call identity	Not used
2.7	Call reference	Not used

TABLE 2/Q.767 (sheet 2 of 4)

Q.762 section	Title	Remarks
2.12	Calling party address request indicator	Not used
2.13	Calling party address response indicator	Not used
2.14	Calling party number incomplete indicator	Default value is used
2.16	Calling party's category request indicator	Not used
2.17	Calling party's category response indicator	Not used
2.18	Cause value	
item a)	Normal class	Cause 2 not used Cause 22: delete 2nd and 3rd sentences
item b)	Resource unavailable class	Additional definition for cause 44 (see § 3.3.1 of Rec. Q.767)
item c)	Service or option not available class	Cause 50 not used
item d)	Service or option not implemented class	Causes 69 and 70 not used.
item e)	Invalid message (e.g. Parameter out of range) class	Cause 87 redefined (see § 3.3.1 of Rec. Q.767); cause 91 not used
item f)	Protocol error (e.g. unknown message) class	Cause 102 is added (see § 3.3.1 of Rec. Q.767); Causes 97, 99, 103 not used.
2.24	Circuit state indicator	Not used
2.27	Coding standard	Default value is used
2.29	Connection request	Not used
2.32	Credit	Not used
2.33	Diagnostic	Not used
2.35	End-to-end information indicator	Default value is used
2.36	End-to-end method indicator	Default value is used
2.38	Event presentation restriction indicator	Default value is used

TABLE 2/Q.767 (sheet 3 of 4)

Q.762 section	Title	Remarks
2.40	Facility indicator	Not used
2.49	Local reference	Not used
2.52	Modification indicator	Not used
2.55	Numbering plan indicator	Default value is used
2.57	Original called number	Not used
2.58	Original redirection reason	Not used
2.59	Point code	Not used
2.60	Protocol class	Not used
2.61	Protocol control indicator	Whether a bit or a bit combination contained in the PCI has history or control characteristic is specified in the definitions of the individual bits or bit combinations.
2.63	Recommendation indicator	Not used
2.64	Redirecting indicator	Not used
2.65	Redirecting number	Not used
2.66	Redirecting reason	Not used
2.67	Redirecting counter	Not used
2.68	Redirection number	Not used
2.71	SCCP method indicator	Default value is used
2.74	Solicited information indicator	Not used
2.81	User to user indicators	Default value is used
2.AA	Connected line identity request indicator	See § 3.3.1 of Rec. Q.767
2.BB	Network discard indicator	See § 3.3.1 of Rec. Q.767

TABLE 2/Q.767 (sheet 4 of 4)

Q.762 section	Title	Remarks
Table 1/Q.762		<p>Table 1/Q.762 is replaced by the following Table 3/Q.767. The following remarks apply:</p> <ul style="list-style-type: none"> – Messages and parameters not used are not included. – Subfields included in used parameters and optional parameters included in used messages that are marked as "default value is used" are marked with bold type characters. – Subfields included in used parameters and optional parameters included in used messages that are marked as "default coding is used" are marked with underlined bold type characters.

TABLE 3/Q.767 (Sheet 1 of 5)

Mandatory or optional parameters in the ISDN user part messages

Message		Group	Forward set-up		Gen sup.	Backward set-up			Call supervision			Circuit supervision					Circuit grp. supervision		
Parameter field	Subfield	Type Q.763 §	IAM	SAM	COT	ACM	CON	CPG	ANM	FOT	REL	RLC	CCR RSC	BLO UBL	BLA UBA	SUS RES	CGB CGU	CGB A-C GUA	GRS GRA
Message type		2.1	M	M	M	M	M	M	M	M	M	M	M	M	M	M	M	M	M
Access transport		3.2	O			O	O	O	O										
Automatic congestion level		3.3									O								
Backward call indicators	Charge indicator Called party's status indic. Called party's category ind. End to end method ind. Interworking ind. End to end information ind. ISDN user part ind. Holding indicator ISDN access indicator Echo control device ind. SCCP method ind.	3.4				M	M	O	O										
Called party number	Odd/even indicator Nature of address Internal network number ind. Numbering plan ind. Address signals	3.7	M																

Bold characters means "default value is used".

M = Mandatory

O = Optional

TABLE 3/Q.767 (Sheet 2 of 5)

Mandatory or optional parameters in the ISDN user part messages

Message		Group	Forward set-up		Gen sup.	Backward set-up			Call supervision			Circuit supervision					Circuit grp. supervision		
Parameter field	Subfield	Type Q.763 §	IAM	SAM	COT	ACM	CON	CPG	ANM	FOT	REL	RLC	CCR RSC	BLO UBL	BLA UBA	SUS RES	CGB CGU	CGB A-C GUA	GRS GRA
Called party number	Odd/even indicator Nature of address Number incomplete ind. Numbering plan ind. Address pres. restricted ind. Screening ind. Address signals	3.8	O																
Calling party's category		3.9	M																
Cause indicators	Coding standard Location Cause value	3.10				O					M								
Circuit group supervision message type ind.	Type indicator	3.11															M	M	
CUG interlock code	Network identity Binary code	3.13	O																
Connected number	Odd/even indicator Nature of address Numbering plan ind. Address pres. restricted ind. Screening ind. Address signals	3.14					O		O										

Bold characters means "default value is used".

TABLE 3/Q.767 (Sheet 3 of 5)

Mandatory or optional parameters in the ISDN user part messages

Message		Group	Forward set-up		Gen sup.	Backward set-up			Call supervision			Circuit supervision					Circuit grp. supervision			
Parameter field	Subfield		Type Q.763 §	IAM		SAM	COT	ACM	CON	CPG	ANM	FOT	REL	RLC	CCR RSC	BLO UBL	BLA UBA	SUS RES	CGB CGU	CGB A-C GUA
Continuity indicators	Continuity indicators	3.16			M															
Even indicators	Event indicator Event pres. restricted ind.	3.18						M												
Forward call ind.	National/international ind. End to end method ind. Interworking ind. End to end information ind. ISDN user part ind. ISDN user part preference ind. ISDN access ind. SCCP method ind.	3.20	M																	
Nature of connection ind.	Satellite ind. Continuity check ind. Echo control device ind.	3.23	M																	
Optional backward call ind.	In-band information ind. Call forwarding may occur ind.	3.24				O		O			M									
Optional forward call ind.	CUG call ind. Connected line id. reg. ind.	3.25	O																	

Bold characters means "default value is used".

TABLE 3/Q.767 (Sheet 4 of 5)

Mandatory or optional parameters in the ISDN user part messages

Message		Group	Forward set-up		Gen sup.	Backward set-up			Call supervision			Circuit supervision					Circuit grp. supervision		
Parameter field	Subfield	Type Q.763 §	IAM	SAM	COT	ACM	CON	CPG	ANM	FOT	REL	RLC	CCR RSC	BLO UBL	BLA UBA	SUS RES	CGB CGU	CGB A-C GUA	GRS GRA
Range and status	Range Status	3.27															M	M	M
Subsequent number	Odd/even ind. Address signals	3.32		M															
Suspend/resume ind.		3.33														M			
Transmission medium requirement		3.35	M																
User service information	Coding standard Information transfer capabil. Transfer mode Information transfer rate Structure Configuration Establishment Symmetry User information protocols	3.36	O																
<u>User-to-user indicators</u>	Type Service 1 Service 2 Service 3 Network discard indicator	3.37				O	O												
User-to-user information		3.38	O			O	O	O	O		O								

Underlined, bold characters means "default coding is used".

Abbreviations relatives to Tables 3/Q.767 (Sheet 5 of 5)

ACM Address complete message
ANM Answer message
BLA Blocking acknowledgement message
BLO Blocking message
CCR Continuity check request message
CGB Circuit group blocking message
CGBA Circuit group blocking acknowledgement message
CGU Circuit group unblocking message
CGUA Circuit group unblocking acknowledgement message
CON Connect message
COT Continuity message
CPG Call progress message

FOT Forward transfer message
GRA Circuit group reset acknowledgement message
GRS Circuit group reset message
IAM Initial address message
REL Release message
RES Resume message
RLC Release complete message
RSC Reset circuit message
SAM Subsequent address message
SUS Suspend message
UBA Unblocking acknowledgement message
UBL Unblocking message

3.3.1 *Additional definitions*

3.3.1.1 **connected line identity request indicator**

Information sent in the forward direction indicating a request for the connected party number to be returned.

3.3.1.2 **network discard indicator**

This indicator indicates that user to user information included in the call control message has been discarded by the network.

3.3.1.3 **cause 44 “Requested circuit/channel not available”**

This cause is returned when the circuit or channel indicated by the requesting entity cannot be provided by the other side of the interface.

3.3.1.4 **cause 87 “Called user not member of CUG”**

This cause indicates that the called user for the incoming CUG call is not member of the specified CUG or that the calling user is an ordinary subscriber calling a CUG subscriber, respectively.

3.3.1.5 **cause 102 “Recovery on timer expiry”**

This cause indicates that a procedure has been initiated by the expiry of a timer in association with error handling procedures.

3.4 *Exceptions and clarifications to Recommendation Q.763*

Table 4/Q.767 contains three columns as follows:

- the first column marked “Section” identifies the relevant section of Recommendation Q.763;

- the second column marked “Title” identifies the relevant subject of Recommendation Q.763;

- the third column marked “Remarks” identifies the deviations from Recommendation Q.763 as appropriate for the international signalling section.

All subsections are the same as in Recommendation Q.763 unless indicated otherwise in Table 4/Q.767 below.

The remark “Not used” in the table means that a message, parameter or indicator should not be generated at an outgoing or incoming gateway exchange towards the international signalling network and if such a message, parameter or indicator is received by an international exchange the procedures defined in Recommendation Q.764 § 2.10.5 in combination with the remarks listed in § 3.5 of Recommendation Q.767 against § 2.10.5 of Recommendation Q.764 are invoked.

All spare bits are reserved and not used. All code values marked “Reserved” or “Spare” are reserved and not used. All codings allocated by CCITT to messages, parameters and indicators which are marked as “Not used” in the table below may only be reintroduced for the CCITT specified purpose.

No remark is made against messages, parameters and parameter values marked “For national use”. It is assumed that they will not appear on an international relation.

TABLE 4/Q.767 (sheet 1 of 6)

Q.763 Section	Title	Remarks
1	General	The Note is not applicable
1.2	Circuit identification code	See § 4.1.11 of Rec. Q.767
1.4	Formatting principles	Additional sentence: Between parameters there should be no unused (i.e. dummy) octets.
1.6	Mandatory variable part	<p>2nd paragraph, 3rd sentence is replaced by :</p> <p>If the message type indicates that an optional part is possible (reflected by the presence of an "end of optional parameter octet" in Tables 5/Q.767 through 28/Q.767), but there is no optional part included in this particular message than a pointer field containing all zeros will be used.</p> <p>Add the following paragraph at the end of § 1.6:</p> <p>If there are no mandatory variable parameters, but optional parameters are possible, the start of optional parameters pointer (coded all '0's if no optional parameter is present and coded '0000001' if any optional parameter is present) will be included.</p>
1.8	End of optional parameters octet	Additional sentence : If no optional parameter is present an "end of optional parameter" octet is not transmitted.
1.11	National message types and parameters	Not used
2.1	Message type codes Table 3/Q.763	<p>The following message types are not used:</p> <ul style="list-style-type: none"> - Call modification completed - Call modification reject - Call modification request - Circuit group query - Circuit group query response - Confusion - Facility accepted - Facility request - Facility reject - Information - Information request - Pass along - User-to-user information

TABLE 4/Q.767 (sheet 2 of 6)

Q.763 Section	Title	Remarks
3.1	Parameter names Table 4/Q.763	The following parameters are not used: – Call modification indicators – Call reference – Circuit state indicator – Connection request – Facility indicator – Information indicators – Information request indicators – Original called number – Redirecting number – Redirection information – Redirection number
3.2	Access transport	For the contents and the length of the Access Transport Parameter, see § 4.3.2 of Rec. Q.767.
3.4	Backward call indicators	BA: is used <i>Note</i> – The interpretation of these bits depends only on the originating exchange. DC = 10: not used HG = 00: is used only J = 1: is not used L = 1: is not used PO = 00: is used only
3.5	Call modification indicators	Not used
3.6	Call reference	Not used
3.7 item b)	Nature of address indicator	Only 000 0011 and 000 0100 are used
3.7 item d)	Numbering plan indicator	001 is used only
3.8	Figure 10/Q.763	Delete note
3.8 item b)	Nature of address indicator	000 0100 is used only Delete note
3.8 item c)	Calling party number incomplete indicator (NI)	1 is not used
3.8 item d)	Numbering plan indicator	001 is used only
3.8 item e)	Address presentation restricted indicator	10 is not used for calling party number delete note

TABLE 4/Q.767 (sheet 3 of 6)

Q.763 Section	Title	Remarks
3.8 item f)	Screening indicator	Only 01 and 11 are used Delete note
3.9	Calling party's category	00000000 not used
3.10	Cause indicators	Only octets 1 and 2 will be supported Coding standard: only 00 is used; delete note Location: 0001 and 0010 are not used Recommendation: not used Cause value: 2, 5, 50, 69, 70, 91, 97, 99, 103 are not used Diagnostic: not used Cause 87 is redefined Cause 102 "Recovery on timer expiry" is used in addition
3.12	Circuit state indicator	not used
3.13	Closed user group interlock code	Add sentence: "Only international interlock codes shall be used"
3.14 item b) item c) item e)	Connected number Nature of address indicator Numbering plan indicator Screening indicator	Only 0000000 and 0000100 are used Only 000 and 001 are used 00 and 10 not used
3.15	Connection request	Not used
3.18	Event information	0000100-0000110 not used Event presentation restricted indicator is always set to 0
3.19	Facility indicator	Not used
3.20	Forward call indicators	CB = 00: is used only E = 1: is not used KJ = 00: is used only
3.21	Information indicators	Not used
3.22	Information request indicators	Not used
3.24	Optional backward call indicators	B = 0: is used only

TABLE 4/Q.767 (sheet 4 of 6)

Q.763 Section	Title	Remarks
3.25	Optional forward call indicators Additional indicator: Connected line identity request indicator	Bit H: H = 0: not requested H = 1: requested
3.26	Original called number	Not used
3.27	Range and status	a) Range: Range code 0: is not used b) Status: The minimum number of status bits in the status subfield is 2 Query messages are not used
3.28	Redirecting number	Not used
3.29	Redirection information	Not used
3.30	Redirection number	Not used
3.35	Transmission medium requirements	0000 0000, 0000 0010, 0000 0011 are used only
3.36	User service information	for further information see § 4.3 of Rec. Q.767
3.37	User-to-user indicators Additional indicator: Network discard indicator	A = 1: is used only CB = 00, ED = 00, GF = 00 are used only Bit H: H = 0: no information H = 1: UUI discarded by the network H = 1 is used only
Table 5	Message type : Address complete	a) The following parameters are not used: – Call reference – Connected number b) length of cause indicators is 4 c) length of User to User information is 3-131; delete reference and note a)

TABLE 4/Q.767 (sheet 5 of 6)

Q.763 Section	Title	Remarks
Table 6	Message type : Answer	a) The following parameters are not used: – Optional backward call indicator – Call reference – User to User indicators b) length of User to User information is 3-131; delete reference and note a)
Table 7	Message type: Call progress	a) The following parameters are not used: – Call reference – Cause indicators – Redirection number – User to user indicators b) length of User to User information is 3-131; delete reference and note a)
Table 8	Message type: Circuit group query response	Not used
Table 10	Message type: Confusion	Not used
Table 11	Message type: Connect	a) The following parameters are not used: – Optional backward call indicator – Call reference b) length of User to User information is 3-131; delete reference and note a)
Table 13	Message type: Facility reject	Not used
Table 14	Message type: Information	Not used
Table 15	Message type: Information request	Not used
Table 16	Message type: Initial address	a) The following parameters are not used: – Call reference – Connection request – Original called number – Redirecting number – Redirection information – User to User indicators b) Note c) is not applicable c) length of User to User information is 3-131; delete reference and note b)

TABLE 4/Q.767 (sheet 6 of 6)

Q.763 Section	Title	Remarks
Table 17	Message type: Release	a) The following parameters are not used: – Access transport – Redirection information – Redirection number b) length of User to User information is 3-131; delete reference and note b) c) length of cause indicators is 3
Table 18	Message type: Release complete	cause indicators: not used
Table 20	Message type : User to user information	Not used
Table 21	Message type : Forward transfer	Call reference is not used
Table 22	Message type : Suspend Resume	Call reference is not used
Table 24	Message type : Call modification completed Call modification request Call modification reject	Not used
Table 26	Message type : Circuit group reset Circuit group query	Circuit group query: not used
Table 27	Message type : Facility accepted Facility request	Not used
Table 28	Message type : Pass-along	Not used
Annex A		For action on spare codes refer to § 4.1.1 of Rec. Q.767.

3.4.1 *Additional formats and codes*

3.4.1.1 *Connected line identity request indicator*

See § 3.25 in Table 4/Q.767.

3.4.1.2 *Network discard indicator*

See § 3.37 in Table 4/Q.767.

3.4.1.3 *Cause 102 “Recovery on timer expiry”*

See § 3.10 in Table 4/Q.767.

3.5 *Exceptions and clarifications to Recommendation Q.764*

Table 5/Q.767 contains three columns as follows:

- the first column marked “Section” identifies the relevant section of Recommendation Q.764;
- the second column marked “Title” identifies the relevant subject of Recommendation Q.764;
- the third column marked “Remarks” identifies the deviations from Recommendation Q.764 as appropriate for the international signalling section.

All subsections are the same as in Recommendation Q.764 unless indicated otherwise in Table 5/Q.767 below.

The remark “Not applicable” in the table means that a procedure described in Recommendation Q.764 is not available in the international signalling network and is therefore not used on the international signalling links.

No remark is made against procedures marked “For national use”. It is assumed that they will not be invoked on an international relation.

TABLE 5/Q.767 (sheet 1 of 7)

Q.764 Section	Title	Remarks
1.3	Address signalling	<i>Note</i> – The use of en-bloc or overlap signalling is based on bi-lateral agreements.
1.5	Signalling methods	1st paragraph, replace first sentence with: "One signalling method is used in this Recommendation" Delete 2nd hyphenated item 2nd paragraph, delete last sentence
1.6	Layout of Recommendation. Q.764	Delete 2nd and last sentence
2.1.1.1	Actions required at the originating exchange	
item a)	Circuit selection	a) $n * 64$ kbit/s connections are not supported b) Connection types "alternate speech/64 kbit/s unrestricted" and "alternate 64 kbit/s unrestricted/speech" are not supported c) The sentence "the first value of bearer information received will be used to set the initial mode of the connection." is not applicable
item c)	Initial address message	a) 3rd paragraph item i) reads: " The only type of end to end method..." and delete "§ 3" b) Delete at the end of the paragraph starting with "The ISDN UP preference indicator..." the last sentence starting with "In addition...". c) At the end of the section items (i) and (iii) are not applicable
item d)	Transfer of information not included in the initial address message	Not applicable

TABLE 5/Q.767 (sheet 2 of 7)

Q.764 Section	Title	Remarks
2.1.1.2	Actions required at an intermediate exchange	
item a)	Circuit selection	1st paragraph, delete sentences starting with: "Within a network..." to "...connection type"
item b)	Parameters in the initial address message	a) Delete in 2nd sentence: "end to end method indicator" b) Delete 3rd sentence: " A change..."
2.1.1.3	Actions required at the destination exchange	2nd paragraph is not applicable
2.1.2.1	Actions required at the originating exchange	
item a)	Circuit selection	a) $n \neq 64$ kbit/s connections are not supported b) Connection types "alternate speech/64 kbit/s unrestricted" and "alternate 64 kbit/s unrestricted/speech" are not supported c) The sentence "the first value of bearer information received will be used to set the initial mode of the connection." is not applicable
item c)	Content of initial and subsequent address Messages	2nd sentence in the 1st paragraph reads "The contents of the initial address message is the same as described in § 2.1.1.1 c) taking into account the remarks against § 2.1.1.1 c) given in this recommendation."
item d)	Transfer of information not included in the Initial Address Message	Not applicable
2.1.2.2	Actions required at an intermediate exchange	
item a)	Circuit selection	Delete 2nd paragraph
item b)	Parameters in the initial address message	a) Delete in 2nd sentence: "end to end method indicator" b) Delete 3rd sentence: " A change..."

TABLE 5/Q.767 (sheet 3 of 7)

Q.764 Section	Title	Remarks
2.1.2.3	Actions required at the destination exchange	2nd paragraph is not applicable
2.1.3	Calling party number	The only method is to send this information within the IAM
2.1.4.9	Return of subaddress information in ACM, CON or CPG	Not applicable for ACM and CPG; subaddress information can only be returned in ANM or CON; for the detailed procedure see Recommendation Q.767, § 4.
2.1.5	Call progress	CPG can only be sent after ACM
2.1.6	Information messages	Not applicable
2.1.7	Answer message	See Rec. Q.767, § 4 for the handling of subaddress
2.1.8	Continuity-check	<p>a) Add the following text after the third paragraph: "When an initial address message is received with a request for continuity check (either on this circuit or on a previous circuit), timer T8 is started. On receipt of a continuity message, timer T8 is stopped.</p> <p>If timer T8 expires, the connection is cleared.</p> <p>If an indication of continuity check failure is received in a continuity message, timer T27 is started awaiting a continuity recheck request. Also, the connection to the succeeding exchange is cleared, if any. Timer T27 is stopped when the continuity check request message is received and timer T36 is started awaiting a continuity or release message.</p> <p>If either timer T27 or T36 expires, a reset circuit message is sent to the preceding exchange. On reception of the release complete message, the circuit is set to idle.</p> <p>b) "inherent fault indication" is replaced by "fault indication according to Recommendation Q.33" in the second line of the fifth paragraph (after the Note).</p> <p>c) Replace item i) with the following: "when initial address messages with a continuity check request indication are received".</p>

TABLE 5/Q.767 (sheet 5 of 7)

Q.764 Section	Title	Remarks
2.5.1.1 item a)	Suspend initiated by a calling party Actions at originating exchange	The suspend request controlling exchange is within the network of the suspend initiating user add "or notification" after "suspend request"
2.5.1.2	Suspend initiated by a called party	The suspend request controlling exchange is within the network of the suspend initiating user
2.5.3	Expiration of timer T2 or timer T6	Cause value # 102 is used in the release message
2.7	In-call modification	Not applicable
2.8.3.1	Echo control procedure Actions at the destination exchange	a) Remove "or call progress" from the second hyphenated item b) Replace "nature of connection indicators field not being set" with "backward call indicators parameter field" in the last paragraph
2.8.3.2	Echo control procedure Actions at an intermediate exchange	a) Remove "or call progress" from the first sentence
2.9.2.3	Abnormal blocking and circuit group blocking procedures	a) In item iv) replace the end of the 1st sentence with: "...group blocking message, then the maintenance system should be notified for the circuits concerned." b) In item v) and vii) replace "a circuit group unblocking message will be sent" with "the maintenance system should be notified". c) Editorial, renumber 2nd item iv) with vi) d) In item vi) and viii) replace "a circuit group blocking message will be sent" with "the maintenance system should be notified". e) In item ix) replace "may" with "shall" in the last line f) In item xii) replace "an unblocking message will be sent" with "the maintenance system should be notified". g) In item xiii) replace "a blocking message will be sent" with "the maintenance system should be notified".

TABLE 5/Q.767 (sheet 6 of 7)

Q.764 Section	Title	Remarks
2.9.3	Circuit group query	Not applicable
2.10.1.4	Actions to be taken on detection of dual seizure	Last sentence is not applicable
2.10.3.1	Reset circuit message	a) The 4-15 s timer is T16 b) The 1 min timer is T17 c) Replace in item f) 2nd sentence with: The circuit shall be made available for service after receipt of the appropriate acknowledgement message
2.10.3.2	Circuit group reset message	a) The 4-15 s timer is T22 b) The 1 min timer is T23
2.10.4	Failure in the blocking/unblocking sequence	a) The 4-15 s timer is T12 for blocking message, T14 for unblocking message, T18 for circuit group blocking message, T20 for circuit group unblocking message. b) The 1 min timer is T13 for blocking message, T15 for unblocking message, T19 for circuit group blocking message, T21 for circuit group unblocking message
2.10.5.1	Handling of unexpected messages	a) In item c) the last sentence is not applicable b) Item e) is not applicable
2.10.5.2	General requirements on receipt of unrecognized signalling information messages and parameters	Not applicable For further information, see Rec. Q.767, § 4.1.1
Table 1	Minimum messages recognized and parameters	Not applicable For further information, see Rec. Q.767, § 4.1.1
2.10.5.3	Procedures for handling of the unrecognized messages or parameters	Not applicable For further information, see Rec. Q.767, § 4.1.1
2.10.6	Failure to receive a "release complete" message	Replace "retransmitting" with "transmitting" in the 1st sentence of 2nd paragraph.
2.10.7	Failure to receive a response to an INR	Not applicable

TABLE 5/Q.767 (sheet 7 of 7)

Q.764 Section	Title	Remarks
2.10.8.2	Call-failure	Replace 1st sentence with: The call failure indication (cause #31) is sent in a release message whenever a call attempt fails and other specific cause value do not apply
2.10.8.3	Abnormal release conditions	a) Replace "T6" by "T9" b) Add the following item to b) and c): "- on failure to receive an address message before 15-20 seconds (T35) after receipt of the latest address message and before the minimum or fixed number of digits have been received."
2.10.8.4	Message loss during end-to-end transfer	Not applicable
2.10.8.5	SCCP supervision timer	Not applicable
2.10.10	Temporary trunk blocking before release of call	Not applicable
2.12	Automatic congestion control	a) The parameter should be recognized. b) If this procedure is not implemented the ACC parameter is not acted upon and discarded as normal
3	End-to-end signalling	Neither the pass-along method nor the SCCP method is applicable, only the link-by-link method is supported
Table A	Timers in Recommendation Q.764	See the following Table 6/Q.767

TABLE 6/Q.767 (sheet 1 of 6)

Timers in Recommendation Q.764

Symbol	Time-out value	Significance	Cause for initiation	Normal termination	At expiry	Section
T1	4-15 seconds	Local	When release message is sent	At the receipt of release complete message	Re-transmit release message and start timer T1	2.2 - 2.3.1 2.10.6
T2	3 min	Dual	When suspend request controlling exchange receives suspend (user) message	At the receipt of resume (user) message at controlling exchange	Initiate release procedure	2.5.1.1 2.5.2.1 2.5.3
T3			Not used on the international interface			2.6
T4			Not used on the international interface			2.7.1 2.7.2
T5	1 min	Local	When initial release message is sent	At receipt of release complete message	Send reset circuit message, alert maintenance personnel and remove the circuit from service, stop T1 start T17; Procedure continues until maintenance intervention occurs.	2.2 2.3.1 2.10.6
T6	Covered in Rec. Q.118	Dual	When controlling exchange receives suspend (network)	At the receipt of resume (network) message	Initiate release procedure	2.5.1.3 2.5.2.3 - 2.5.3

TABLE 6/Q.767 (sheet 2 of 6)

Timers in Recommendation Q.764

Symbol	Time-out value	Significance	Cause for initiation	Normal termination	At expiry	Section
T7	20-30 s	Dual	When the latest address message is sent	When the condition for normal release of address and routing information is met (receipt of ACM, CON messages)	Release all equipment and connection (send release message)	2.1.1.1 2.1.2.1 f) 2.1.4.4 2.1.4.8 2.10.8.3
T8	10-15 s	Local	When transit or incoming international exchange receives initial address message requiring continuity check on this circuit, or indicates that continuity check has been performed on a previous circuit	At receipt of continuity message	Release all equipment and connection into national network (send release message)	2.1.8 2.10.8.3
T9	Interval specified in Rec. Q.118	Dual	When national controlling or outgoing international exchange receives ACM	At the receipt of answer	Release connection and send back release message	2.1.4.4 2.1.7.2 2.1.7.3 2.10.8.3
T10	4-6 s	Dual	When last digit is received in interworking situations	At the receipt of fresh information	Send address complete message	2.1.2.1 e) 2.1.4.8
T11	15-20 s	Dual	When latest address message is received in interworking situations	When ACM is sent	Send address complete message	2.1.4.8
T12	4-15 s	Local	When blocking message is sent	At receipt of blocking acknowledgement	Re-transmit blocking message and start T12	2.10.4

TABLE 6/Q.767 (sheet 3 of 6)

Timers in Recommendation Q.764

Symbol	Time-out value	Significance	Cause for initiation	Normal termination	At expiry	Section
T13	1 min	Local	When initial blocking message is sent	At receipt of blocking acknowledgement	Transmit blocking message, alert maintenance personnel and start T13; stop T12. Procedure continues until maintenance intervention occurs.	2.10.4
T14	4-15 s	Local	When unblocking message is sent	At receipt of unblocking acknowledgement	Re-transmit unblocking message and start T14	2.10.4
T15	1 min	Local	When initial unblocking message is sent	At receipt of unblocking acknowledgement	Re-transmit unblocking message and alert maintenance personnel, start T15 and stop T14. Procedure continues until maintenance intervention occurs.	2.10.4
T16	4-15 s	Local	When reset circuit message is sent not due to the expiry of Timer T5	At the receipt of the acknowledgement (RLC message)	Re-transmit reset circuit message start T16	2.10.3.1
T17	1 min	Local	When initial reset circuit message is sent	At the receipt of the acknowledgement	Alert maintenance personnel, re-transmit reset circuit message, start T17 and stop T16. Procedure continues until maintenance intervention occurs.	2.10.3.1
T18	4-15 s	Local	When group blocking message is sent	At receipt of group blocking acknowledgement	Re-transmit group blocking message and start T18	2.10.4

TABLE 6/Q.767 (sheet 4 of 6)

Timers in Recommendation Q.764

Symbol	Time-out value	Significance	Cause for initiation	Normal termination	At expiry	Section
T19	1 min	Local	When initial group blocking message is sent	At receipt of group blocking acknowledgement	Re-transmit group blocking message, alert maintenance personnel, start T19 and stop T18. Procedure continues until maintenance intervention occurs.	2.10.4
T20	4-15 s	Local	When group unblocking message is sent	At receipt of group unblocking acknowledgement	Re-transmit group unblocking message and start T20	2.10.4
T21	1 min	Local	When initial group unblocking message is sent	At the receipt of group unblocking acknowledgement	Re-transmit group unblocking message, alert maintenance personnel, start T21 and stop T20. Procedure continues until maintenance intervention occurs.	2.10.4
T22	4-15 s	Local	When circuit group reset message is sent	At the receipt of the acknowledgement	Re-transmit circuit group reset message, start T22	2.10.3.2
T23	1 min	Local	When initial circuit group reset message is sent	At receipt of the acknowledgement	Alert maintenance personnel and start T23, re-transmit circuit group reset message, stop T22. Procedure continues until maintenance intervention occurs.	2.10.3.2

TABLE 6/Q.767 (sheet 5 of 6)

Timers in Recommendation Q.764

Symbol	Time-out value	Significance	Cause for initiation	Normal termination	At expiry	Section
T24	< 2 s	Local	When check tone is sent	At the receipt of backward check tone	Send continuity message with failure indication and: a) start T25 if continuity check was asked in an IAM b) start T26 if continuity check was asked in a CCR	Rec. Q.724 § 7.4.1
T25	1-10 s	Local	When initial continuity check failure is detected		Send CCR message and repeat continuity check	Rec. Q.724 § 7.3
T26	1-3 min	Local	When second or subsequent continuity check failure is detected		Send CCR message and repeat continuity check	Rec. Q.724 § 7.3
T27	4 min	Local	When continuity check failure indication is received	At receipt of continuity check request message	Send reset circuit message; start T16 and T17	2.1.8
T28			Not used on the international interface			2.9.3.2
T29	300-600 ms	Local	Congestion indication received when T29 not running		New congestion indication will be taken into account	2.11.2
T30	5-10 s	Local	Congestion indication received when T29 not running		Restore traffic by one step if not yet at full load and start T30	2.11.2

TABLE 6/Q.767 (sheet 6 of 6)

Timers in Recommendation Q.764

Symbol	Time-out value	Significance	Cause for initiation	Normal termination	At expiry	Section
T31			Not used on the international interface			3.7.2 3.7.3 3.7.4
T32			Not used on the international interface			3.7.5
T33			Not used on the international interface			2.1.6.2 2.10.7
T34			Not used on the international interface			2.9.3.2
T35	15-20 s	Dual	At receipt of the latest digit (< >ST) and before the minimum or fixed number of digits have been received	At receipt of ST or when the minimum or fixed number of digits have been received	Send release message (cause 28)	2.2.5 2.10.8.3
T36	10-15 s	Local	When transit or incoming international exchange receives continuity check request message	At receipt of continuity or release message	Release all equipment, sent reset circuit message, start T16 and T17	2.1.8

3.6 *Exceptions and clarifications to Recommendation Q.730*

Supplementary services relevant to this Recommendation are listed below:

- User to User Signalling (Q.730, § 2);
- Closed User Group (Q.730, § 3);
- Calling Line Identification Presentation/Restriction (Q.730, § 4);
- Direct Dialling In (Q.730, § 5);
- Connected Line Identification Presentation/Restriction (not in Q.730);

- Subaddressing (not in Q.730);
- Multiple Subscriber Number (not in Q.730);
- Terminal Portability (not in Q.730).

Direct Dialling In and Multiple Subscriber Number are supported but are without relevance to the international interface.

Subaddressing and Terminal Portability are implicitly supported, as part of the basic Q.764 procedures (see Recommendations Q.767, §§ 4.1.9 and 4.1.8).

This section contains the following subsections:

- exceptions and clarifications for ISDN supplementary services in Recommendation Q.730;
- ISDN supplementary services not in Recommendation Q.730.

3.6.1 *Exceptions and clarifications for ISDN supplementary services in Recommendation Q.730*

Table 7/Q.767 contains three columns as follows:

- the first column marked “Section” identifies the relevant section of Q.730;
- the second column marked “Title” identifies the relevant subject of Q.730;
- the third column marked “Remarks” identifies the deviations from Q.730 as appropriate for the international signalling section.

All subsections are the same as in Recommendation Q.730 unless indicated otherwise in Table 7/Q.767 below.

The remark “Not applicable” in the table means that a procedure described in Q.730 is not available in the international signalling network and is therefore not used on the international signalling links.

TABLE 7/Q.767 (sheet 1 of 6)

Q.730 section	Title	Remarks
Sec. 1	General	
1.1	(untitled)	References to TCAP, SCCP, and TC are not applicable.
1.2	Information request/ response	Not applicable
1.4	Layout of Rec. Q.730	"Close" should be "closed". Call forwarding, DDI, the time-out table, and the note are not applicable
Sec. 2	User-to-User Signalling service	
2.1	General description ISUP, SCCP	SCCP is not used
2.1.1	Services Maximum length of UUI	Only Implicit Service 1 is supported In the last paragraph, the sentence "The 128 octets" reads: "The 128 octets do not include the parameter name, the length octet and the protocol discriminator."
2.1.2	Service request	Service 1 is requested implicitly in an IAM.
2.1.3	Service response	The paragraph replaced by: The discard of user-to-user information by the network except in the case of PSTN interworking or terminating access non ISDN is explicitly notified by the user-to-user indicator parameter in the appropriate backward message. Bit H is coded "UUI discarded by the network" and bits CB are coded "no information". No notification is given if the called user does not understand the service or cannot support the service.

TABLE 7/Q.767 (sheet 2 of 6)

Q.730 section	Title	Remarks
2.1.4	Flow control	Not applicable
2.2	Procedures for user to user signalling associated with circuit switched call	Delete last sentence
2.2.1	UUS Service 1	
2.2.1.1	UUS # 1 General characteristics	Replace the last sentence with "If for any reason the combination of the basic plus supplementary services information causes the overall maximum length of the messages to be exceeded or if 128 octets of user-to-user information cannot be supported in the IAM, then the user-to-user information parameter is discarded
		and a user-to-user indicator parameter is sent in the first appropriate backward message (e.g., ACM or CON). No truncation of user-to-user information is performed".
2.2.1.2	User to user in the call set-up phase	Delete in the last paragraph 1st sentence the words "or network" Add a 5th paragraph reading; "If no UUS information is sent in the IAM, the incoming (outgoing) national network should prevent the transmission of UUS in the backward (forward) direction.
2.2.1.3	Interworking	Delete last sentence
2.2.1.4	Rejection of implicit service request	Networks that cannot provide the requested service will return a reject indication in the user-to-user indicator parameter in the first appropriate backward message. Bit H is coded "UUI discarded by the network" and bits CB are coded "no information".
2.2.2.1	Call forwarding services	Not applicable
2.2.2.2	Call waiting service	Not applicable

TABLE 7/Q.767 (sheet 3 of 6)

Q.730 section	Title	Remarks
Sec. 3	Closed user group (CUG)	
3.1	General	The administration of CUG data is considered as a national matter. The last two paragraphs are deleted
3.2	Call set-up procedure with decentralized administration of CUG data	The title is expanded to read: "Call set-up procedure with decentralized or centralized administration of CUG data".
3.2.2	Transit exchange	The first eight words of the first paragraph are deleted. The last sentence of the second paragraph terminates with the words: "...at the gateway exchange". The remainder of that sentence is deleted. The first sentence of the third paragraph, the word "incoming" precedes the words "gateway exchange". In the last sentence replace cause "88" by "87".
3.2.3	Destination exchange	Delete "called" in the definition of cause "87". Delete reference to "cause # 88".
3.3	Call set-up procedure with centralized administration of CUG data	Not applicable.
Table 1	Action at the gateway with a network without CUG capability	The title is expanded to read: "Action at the incoming gateway with a network without CUG capability". Replace "cause # 88" with "cause # 87"
Table 2	Handling of a CUG call at destination exchange	Replace "cause # 88" with "cause # 87"
3.4	ASE for CUG	Not used in the international network.
Figures 3, 4 and 5	Flows for a CUG call with centralized administration of CUG data	Not applicable.

TABLE 7/Q.767 (sheet 4 of 6)

Q.730 section	Title	Remarks
Tables 3 and 4	Validation check of CUG call concerning the calling/called user	Not applicable
3.5	Interactions with other supplementary services	Add the following new paragraph There are no known interactions with supplementary services applicable at the international interface
Sec. 4	General description of the CLIP and CLIR services	In the first and second paragraphs the words "possibly with additional address information (i.e. sub-address)" are replaced by "with additional address information (e.g. calling party subaddress) if any". The first sentence of third paragraph : replace "I.254" with "I.251".
4.1	Description of the CLIP service	Second paragraph is replaced by: "The Calling Line Identity is the ISDN number of the calling party (with additional address information, e.g. calling party subaddress, if any) which may be provided by the network or partly by the calling party". Third paragraph is not applicable. Fourth paragraph is replaced by: "In the case where a calling party is an ISPBX the network sends the ISDN number including the DDI digits of the extension as the CLI if the latter is provided by the calling party, or the network provided default number if the extension number is not provided.
4.1.1	Call set-up procedure	Systematic inclusion in the IAM is the only method used when the CLI is available.

TABLE 7/Q.767 (sheet 5 of 6)

Q.730 section	Title	Remarks
4.1.1.1	The CLI is included in the IAM	<p>The second paragraph including items a) and b) is not applicable.</p> <p>Concerning item b) the release of restricted CLIs across international boundaries is decided by bilateral agreement. If any agreement requires restricted CLIs not to be passed then the originating gateway shall ensure that no such CLIs are sent (<i>Note</i> – this bilateral agreement may depend on the application of override categories in the destination network, see §§ 4.2.2.1 and 4.2.2.2 of Recommendation Q.730).</p> <p>The last three paragraphs are replaced by: "If no address signals are to be sent, then the Calling Party Number parameter shall not be sent". When interworking with signalling systems which do not support calling line identity (e.g. No. 5) or from which calling line identity is not immediately available (e.g. TUP), the Calling Party Number parameter is not sent. Only complete calling party numbers are sent."</p>
4.1.1.2	The CLI is not included in the IAM	The entire section is replaced by: "If no Calling Party Number parameter is received in the Initial Address Message, then it is a function of the user-network interface not to present the calling party subaddress, if received, to the user."
Figures 6, 7 and 8	CLIP/R message flows	Figures 6-8 are replaced by Figures 1/Q.767-3/Q.767.
4.2	Description of CLIR service	In the second paragraph, the words "possibly with additional address information" are replaced by "with additional address information (e.g. calling party subaddress) if present."
4.2.1	Normal case	Information message is not applicable
4.2.2.3	Interworking with non-ISDN or via non-ISDN	Second paragraph is replaced by "If CLIR is applicable and the restriction indicator cannot be conveyed on the next signalling section the interworking exchange will not send the CLI and any additional address information provided by the calling party (e.g. calling party subaddress)."

TABLE 7/Q.767 (sheet 6 of 6)

Q.730 section	Title	Remarks
4.2.2.4	Restriction of additional address information	Replace "i.e. subaddress" by "e.g. calling party subaddress".
4.4.2	Call Forwarding	Not applicable.
4.4.3	Call Waiting	Not applicable.
4.4.5	Direct Dialling In	Not applicable
4.4.7	Other services	Add the following section: "There are no known interactions with supplementary services applicable to the international interface other than those listed"
4.5.2	Call Forwarding	Not applicable.
4.5.3	Call Waiting	Not applicable.
4.5.4	CUG	Replace text with: "No interaction".
4.5.5	Direct Dialling In	Not applicable
4.5.7	Other services	Add the following paragraph: "There are no known interactions with supplementary services applicable to the international interface other than those listed"
Figures 9-13	Nodal signalling functions for CLIP/R	Figures 10 and 11 are replaced by Figures 4/Q.767 and 5/Q.767. Figures 9, 12, and 13 are not applicable.
5	Direct Dialling In (DDI)	Not relevant (no impact on the international interface)
6	Call forwarding	Not applicable
7	Time-out table	Not applicable
Annex A	Signalling procedures for the explicit invocation of user to user signalling services 1, 2 and 3.	Not applicable

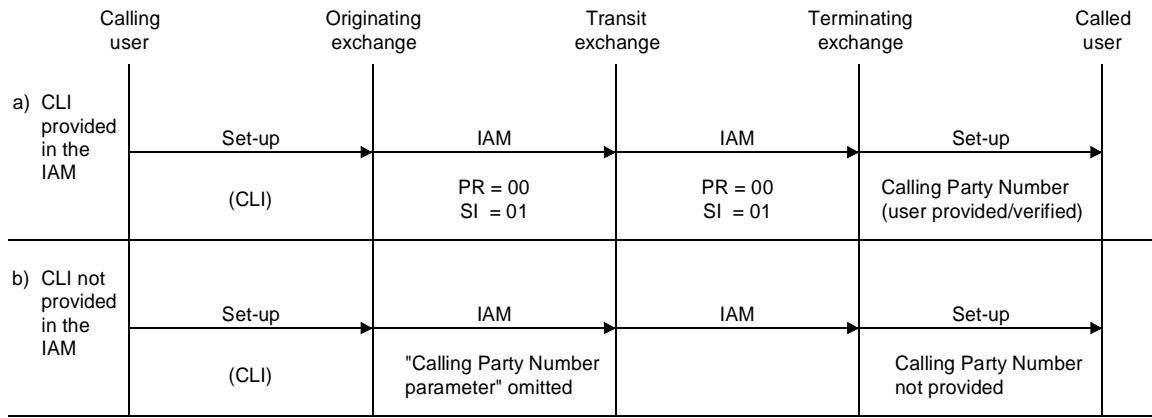

T1148080-92/d01

PR Presentation restricted
SI Screening indicator

FIGURE 1/Q.767
Calling Line Identification Presentation
Presentation allowed – CLI provided by the calling user

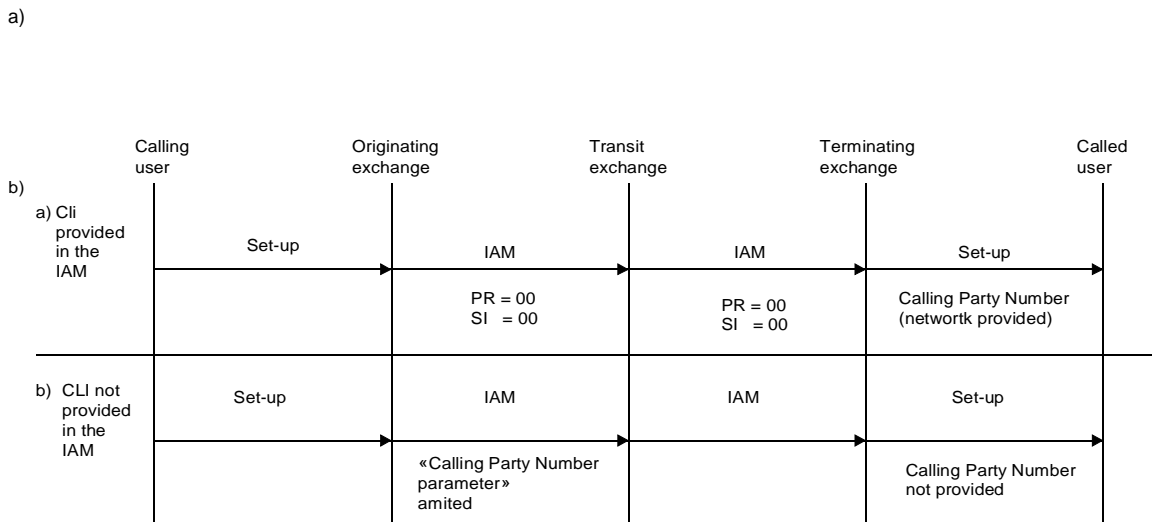

T1148090-92/d02

PR Presentation restricted
SI Screening indicator

FIGURE 2/Q.767
Calling Line Identification Presentation
Presentation allowed – CLI provided by the originating node

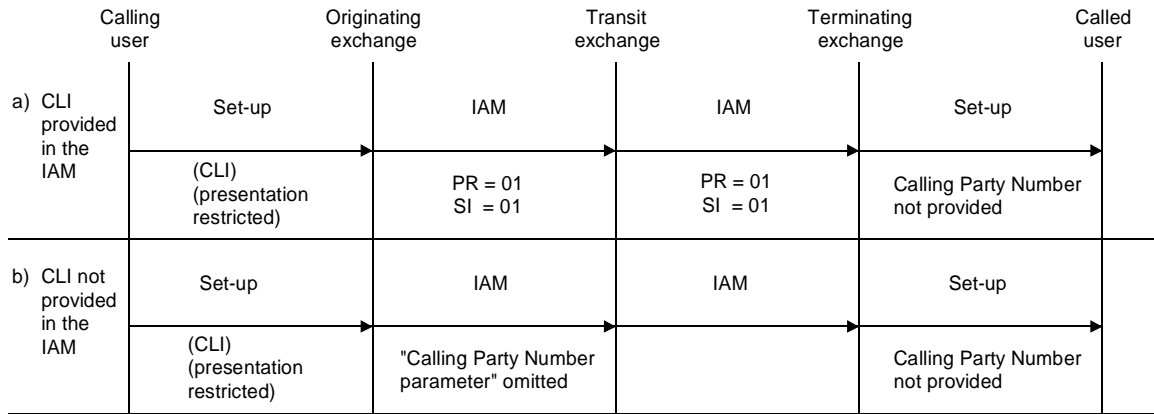

T1148100-92/d03

PR Presentation restricted
SI Screening indicator

FIGURE 3/Q.767
Calling Line Identification Restriction
Presentation allowed – CLI provided by the calling user

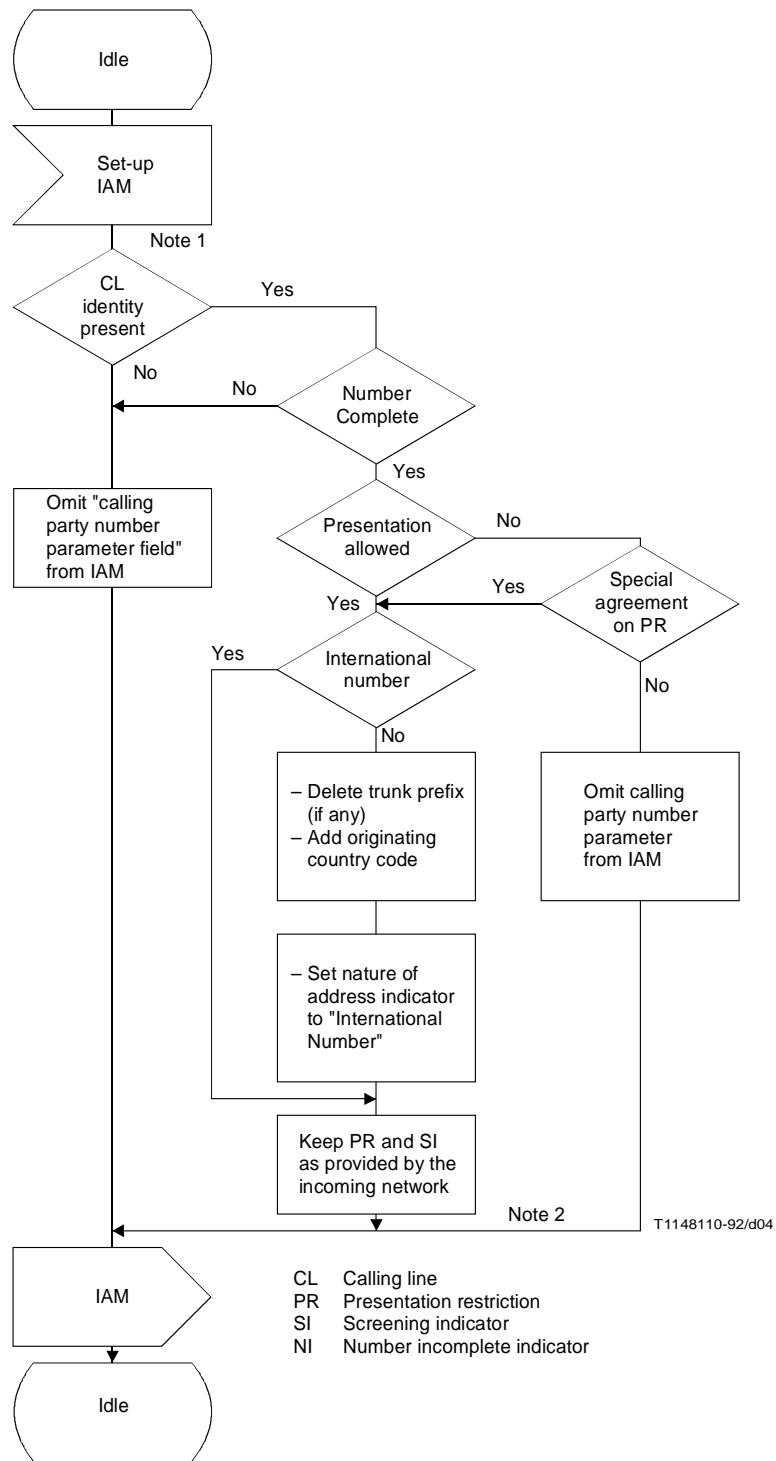

Note 1 – This flow assumes that there is no restriction on passing non-restricted CLI's across the international boundary. If no such agreement exists then any CLI in the incoming IAM will be removed.

Note 2 – Allowed values for the international section are
PR = 00 or 01
SI = 01 or 11
NI = 0

FIGURE 4/Q.767
**Nodal signalling functions for CLIP and CLIR
Outgoing international gateway**

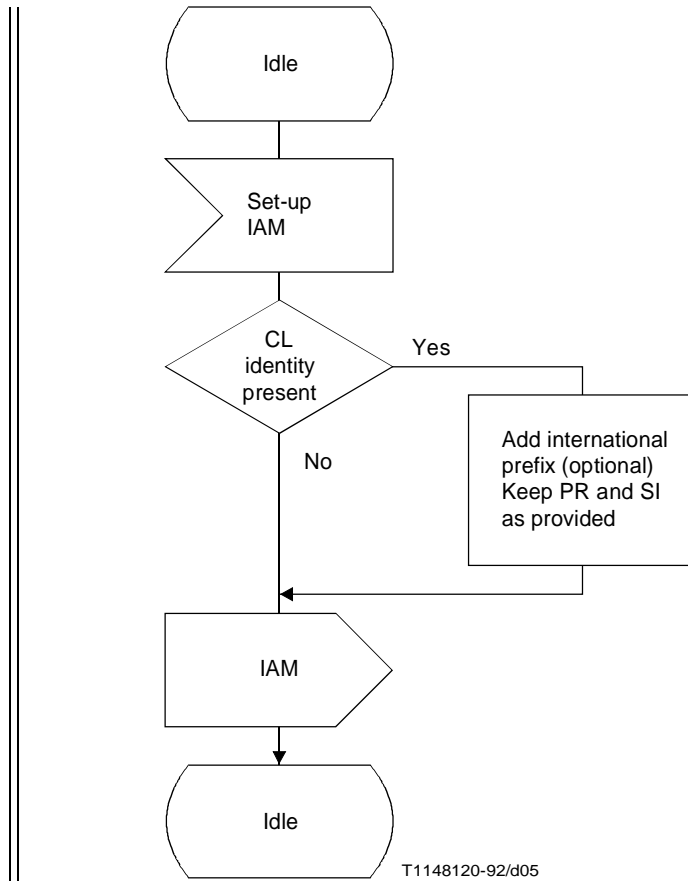

CL Calling line
 PR Presentation restriction
 SI Screening indicator

FIGURE 5/Q.767
**Nodal signalling function for CLIP and CLIR
 Destination international gateway exchange**

3.6.2 *ISDN supplementary services not in Recommendation Q.730*

3.6.2.1 *General Description of the Connected Line Identification Presentation and Restriction Service*

Connected Line Identification Presentation (COLP) is a supplementary service offered to the calling party which provides the connected party's ISDN number, with additional address information (e.g. connected party sub-address) if any, to the calling party at the call establishment phase.

Connected Line Identification Restriction (COLR) is a supplementary service offered to the connected party to restrict presentation of the connected party's ISDN-number, with additional address information (e.g. connected party sub-address) if any, to the calling party.

The Stage 1 CCITT definitions for the COLP and COLR services are given in Recommendations I.251.5 and I.251.6 respectively. The Stage 2 CCITT descriptions are contained in Recommendations Q.81, § 5 and Q.81, § 6 respectively. This stage 3 description of COLP and COLR uses the ISDN User Part protocol as defined in the Recommendations Q.761-Q.764 and Q.766.

3.6.2.1.1 *Description of the Connected Line Identification Presentation (COLP) Service*

Connected Line Identity Presentation (COLP) is a user facility that enables a user to be informed, on outgoing calls, of the address of the connected party. When provided the facility applies to all outgoing calls except for when the connected party has the Connected Line Identity Restriction (COLR) facility active [see § 3.6.1.2 below].

The Connected Line Identity (COL) is the ISDN number of the connected party (with additional address information, e.g. connected party sub-address, if any) which may be provided by the network or by the connected party or partially by the network with the rest provided by the connected party.

Only full international number, including the country code, should be passed across the international boundary.

Moreover, the information on the COL may include address information generated by the connected user and transparently transported by the network. The sub-address is subject to a maximum of 20 octets (the length of the subaddress is not checked at international gateways). The network is not responsible for the content of this additional address information.

The destination exchange shall deliver the COL only if it was requested at call set-up. However, if it is received in the Answer of Connect message when it has not been requested it should not be considered as a protocol error and the call should be allowed to continue.

In the case where a connected party is a DDI ISPBX extension, the network sends the ISDN number and the DDI number of the extension as the COL if the extension digits are provided by the connected party. If the extension digits are not provided the network sends the ISDN default number. The default number is stored within the network but the value is agreed between the Administration and the customer concerned.

When the COL is provided by the user or ISPBX it is verified or screened for validity by the network i.e. the COL provided by the user is within the known number range for that user.

- i) If the user provided COL is valid the Connected Number parameter field contains the COL in the address signals with the screening indicator set to “user provided verified and passed”.
- ii) If the user provided COL is not valid or screened the destination exchange inserts the default number for the address signals with the screening indicator set to “network provided”.

When the COL is provided by the network the terminating exchange includes the stored COL set against the connected party and sets the screening indicator to “network provided”.

Information indicating that a subscriber has the user access to the COLP facility is available in the exchange to which the subscriber is connected.

The destination gateway can remove the COL digits and indicate that connected line identity is not available.

3.6.2.1.1.1 *Call set-up procedure*

The call control procedure and the information included in call control messages vary depending on whether the calling party has indicated, in the optional forward call indicator in the IAM, a request to use the COLP facility for this call.

3.6.2.1.1.2 *The request of COLP facility is included in the initial address message*

When the calling party user has subscribed to the COLP facility the originating exchange, if the Connected Line Identification is supported by the network, must include in the IAM an indication to request the COLP facility.

The Connected Line Identification is determined by the destination exchange. If the connected party number is received from the connected user, the information is verified and passed to the originating exchange. If no information is received from the connected user, the destination exchange shall generate the connected party number.

The information is conveyed by the network in the Connected Number parameter field of the Answer (ANM) or Connect (CON) message. The service has no impact on the signalling procedures.

Optionally a Connected party Sub-address may be included, if received from the called party user, in the Connected Sub-address information element which is added to the ATP (Access Transport parameter) of these messages.

Both parameters, ATP and Connected Number are sent to the originating exchange.

If the COL cannot be transferred (because its presentation is restricted or because the national network cannot provide the number) then the Connected Number parameter should be included in the ANM or CON messages with the indication "Presentation restricted" or "Address not available" set as appropriate in the Address Presentation Restriction Indicator.

In the case of Connected Number Presentation Restriction, the COL with the presentation restriction indication will be forwarded to the originating exchange but not presented to the calling party (unless the national option of the override category is invoked).

In the case of interworking between ISDNs the destination network can restrict the presentation of the COL. If this option is invoked the COL shall be marked as not available.

No particular actions are required at intermediate exchanges.

At the international boundary, the destination gateway can remove the Connected Number digits if it cannot be released to the originating network and a COL not available indication will be passed to the originating network (Address presentation restricted indicator set to address not available).

At the originating exchange, when a Connected Party Number is received in the answer or connect message, the originating exchange determines if the information may be presented to the user.

Note – If no Connected Party Number parameter or a restricted connected number is received in the answer or connect message, then it is a function of the user-network interface not to present the connected party subaddress, if received, to the user.

3.6.2.1.1.3 *COLP Facility not requested by the calling party user*

When the calling party user has not subscribed to the COLP facility no particular actions are required. When a request for the COL is not included in the IAM the Connected Number Parameter should not be included in either the answer or connect message. However, if it is included under these circumstances it should not be considered as a protocol error and the call should continue.

Figure 6/Q.767 describes the message flows for COLP.

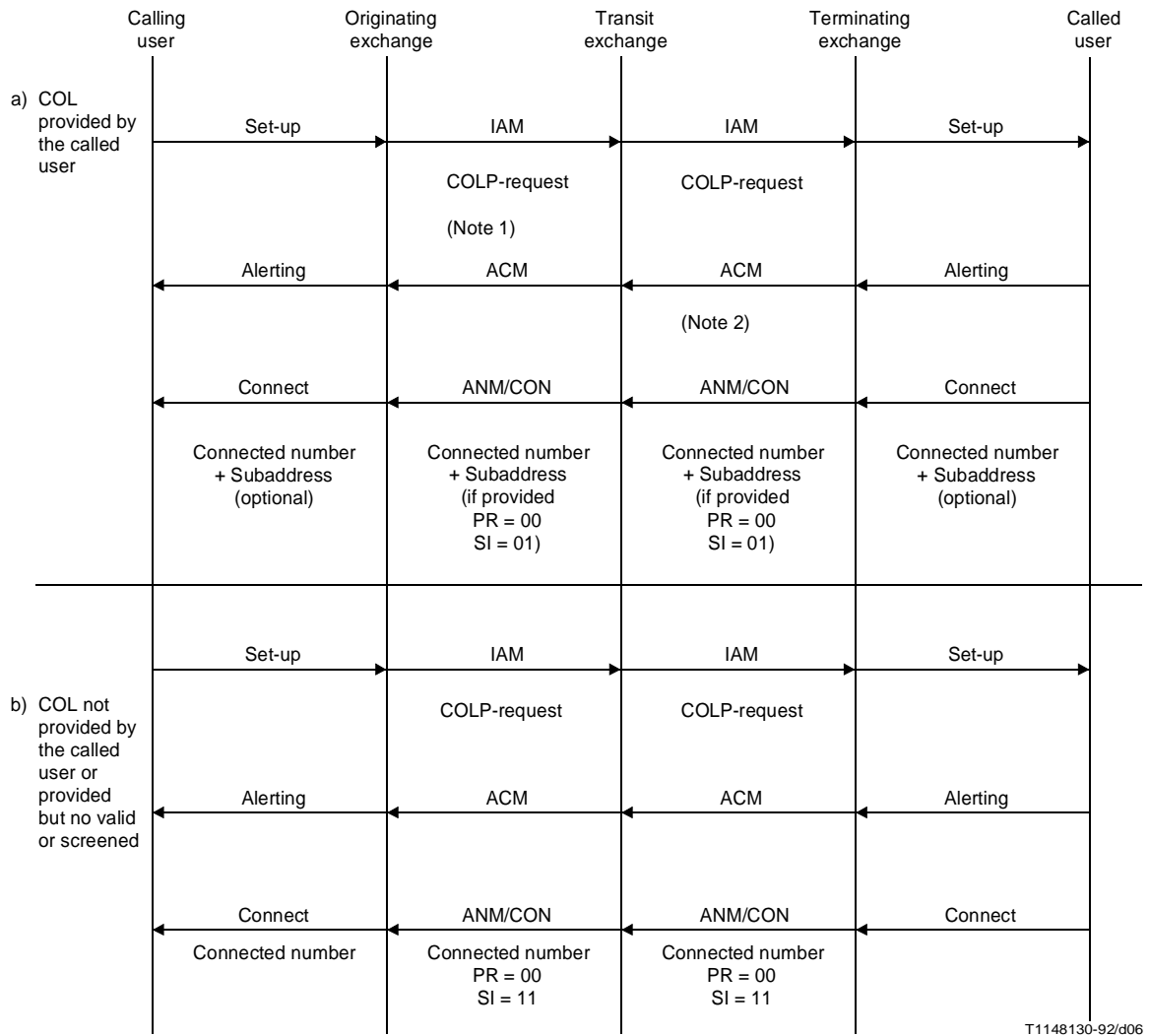

Note 1 – This service is subscribed by the calling user and the request is included by the originating exchange.

Note 2 – The connect message is appropriate only if the answer condition is detected prior to the return of the address complete message.

FIGURE 6/Q.767
Connected line identification presentation

3.6.2.1.2 *Description of the Connected Line Identity Restriction (COLR Service)*

Connected Line Identification Restriction (COLR) is a user facility offered to restrict the presentation of the COL to the calling party. The information that the called subscriber has the COLR facility is available at the call terminating exchange.

When COLR is applicable and activated the destination exchange provides the originating node with a notification that the connected user's ISDN number and any sub-address information is not allowed to be presented to the calling user. In this case no connected party number is included in the call connected information sent to the calling user.

The presentation restriction function does not influence the forwarding of the connected number within the network as part of the basic service procedure.

The passing of restricted Connected Number parameters across international boundaries is decided by bilateral agreements. If any agreement requires restricted Connected Number parameters not to be passed, then the terminating gateway shall ensure that no such Connected Number parameters are sent.

Note – This bilateral agreement may depend on the application of override categories in the originating network (see § 3.6.2.1.2.2).

The restriction service is applied universally for all services for a particular customer.

3.6.2.1.2.1 *Call set up procedure*

When the calling party user has subscribed to the COLP facility the originating exchange includes in the IAM an indication to request the COL. If the called party user has subscribed to the COLR facility, the destination exchange will send the Connected Line Identity to the originating exchange, with an indication that the presentation is restricted (address presentation restricted indicator set to presentation restricted).

This information is conveyed by the network in the Connected Number parameter field of the ANM or CON messages. The service has no impact on the signalling procedures.

No particular actions are required at intermediate exchanges.

At the international boundary, the destination gateway can remove the COL if it cannot be released to the originating network and change the address presentation restricted indicator, set to presentation restricted, into address not available.

At the originating exchange, when a Connected Party Number is received in the ANM or CON message with the indication that the presentation is restricted, the originating exchange must not present the COL to the user.

3.6.2.1.2.2 *Override category*

i) *Override category within an ISDN*

As a national option the originating exchange can override the Presentation Restriction Indication and the COL is then presented to the calling subscriber for specific calling party's categories (e.g. Police).

ii) *Override category between ISDNs*

When a call originates in one ISDN network and terminates in another ISDN network and COLR is applicable, the rules and regulations of the originating (host) network should apply.

For example, if an override category is not available in the destination network but is available in the originating network. The originating network can still override the presentation restriction whenever COL is available at this network.

As a national option the destination network can restrict the COL to the originating network if COLR is applicable.

3.6.2.1.2.3 *Interworking with non-ISDN or via non-ISDN*

On calls from or via non-ISDN networks, it cannot be guaranteed that the COLR indication will be carried to the originating network.

If COLR is applicable and the restriction indicator cannot be conveyed on the preceding signalling section the interworking exchange will not send the COL.

If the originating network receives a Connected Line Identity without any indication of presentation allowed or restricted, the originating network will act according to its rules and regulations.

3.6.2.1.2.4 *Restriction of additional address information*

Any additional address information provided by the connected party, e.g. connected party sub-address, will also be subject to the COLR supplementary service as indicated in the Address Presentation Restriction Indicator in the Connected Number parameter.

3.6.2.1.2.5 *Message sequence diagrams for COLR*

Figure 7/Q.767 describes the message flow for COLR.

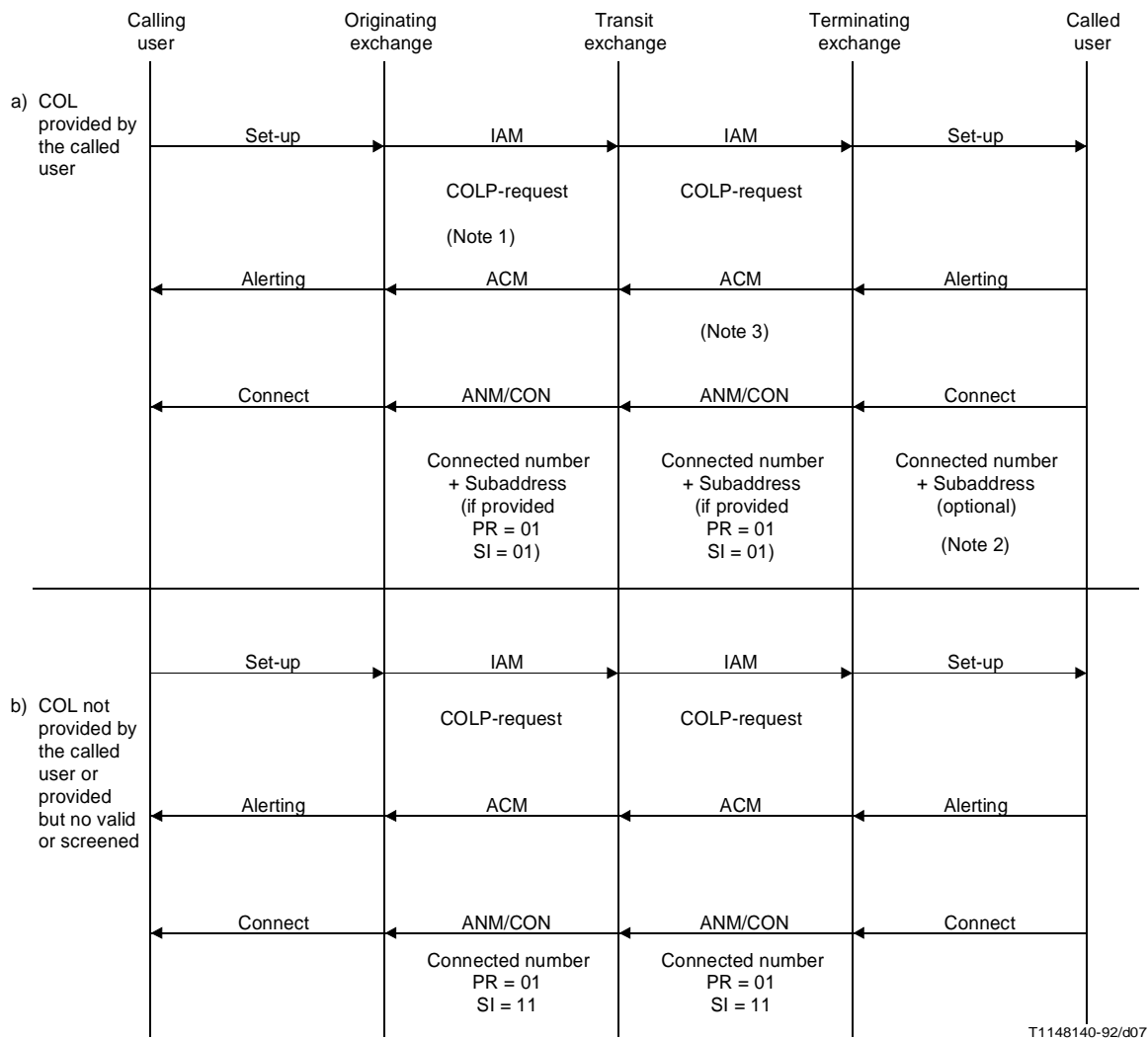

Note 1 – This service is subscribed by the calling user and the request is included by the originating exchange.
Note 3 – This service is subscribed by the called user and stored at the destination exchange.
Note 2 – The connect message is appropriate only if the answer condition is detected prior to the return of the address complete message.

FIGURE 7/Q.767
Connected line identification restriction

3.6.2.1.3 *Nodal signalling function SDLs for COLP and COLR*

Nodal signalling function procedures for COLP and COLR are described in Figures 8/Q.767 to 11/Q.767.

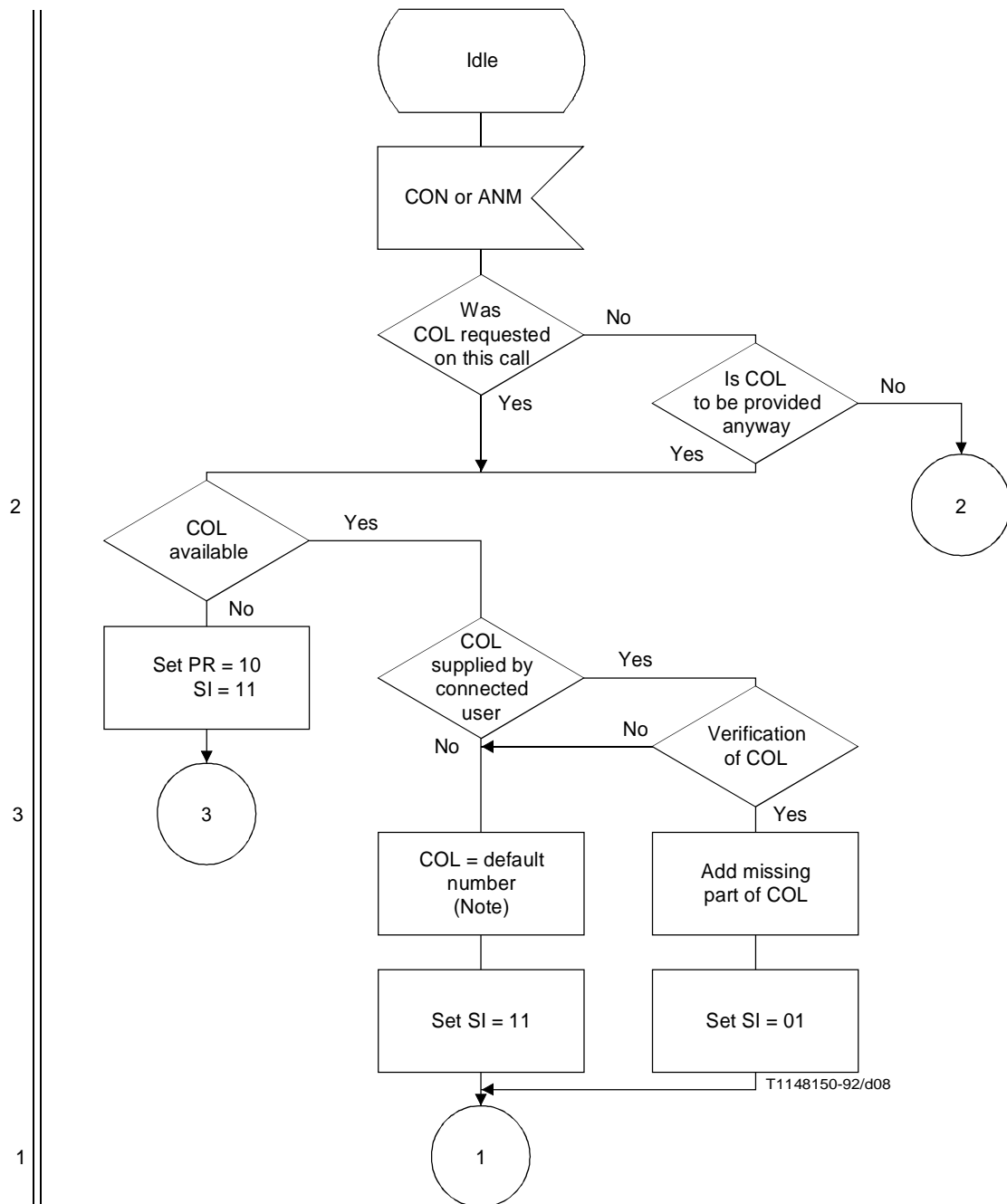

COL Connected line identity
 PR Presentation restriction
 SI Screening indicator

Note – The default number is a network supplied default number.

FIGURE 8/Q.767 (sheet 1 of 2)

Nodal signalling functions for COLP and COLR terminating local exchange
 (This figure is not applicable for the international interface and provided for information only)

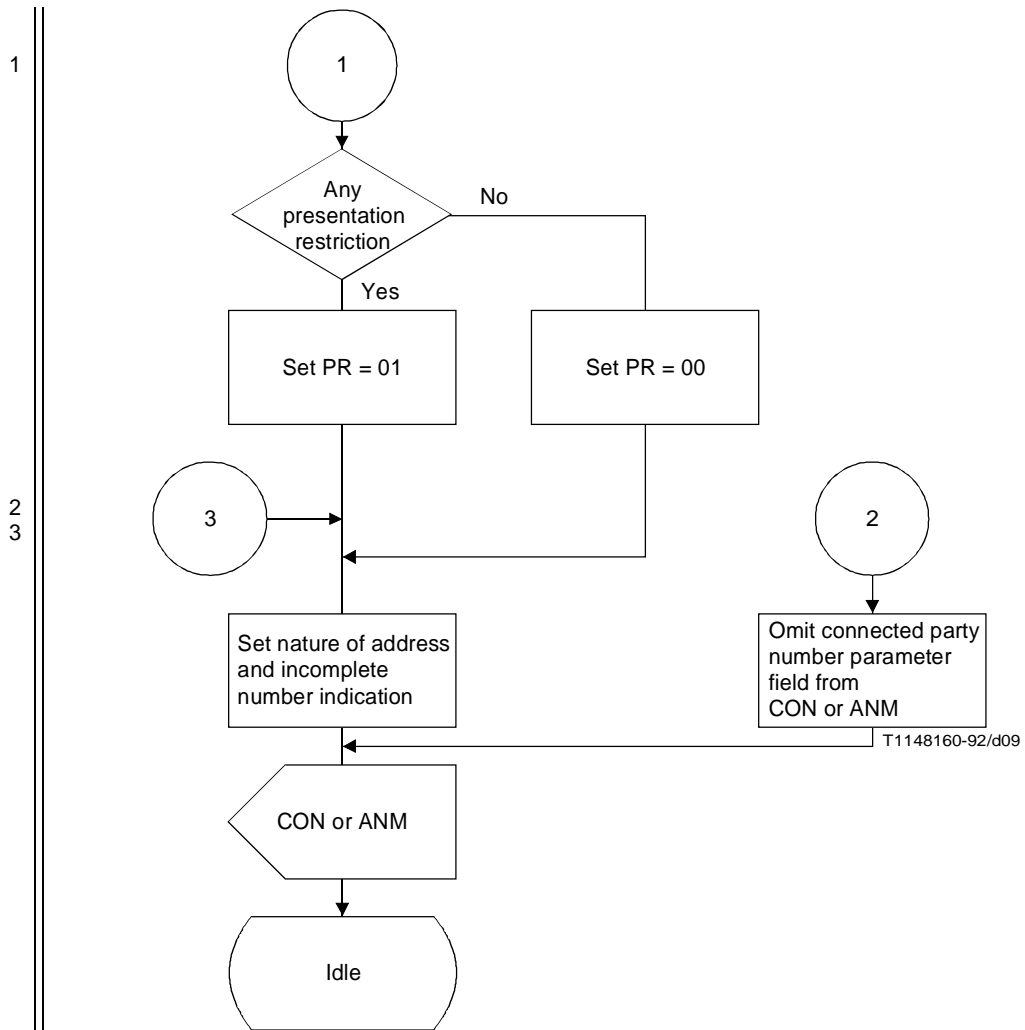

COL Connected line identity
 PR Presentation restriction
 SI Screening indicator

FIGURE 8/Q.767 (sheet 2 of 2)

Nodal signalling functions for COLP and COLR terminating local exchange

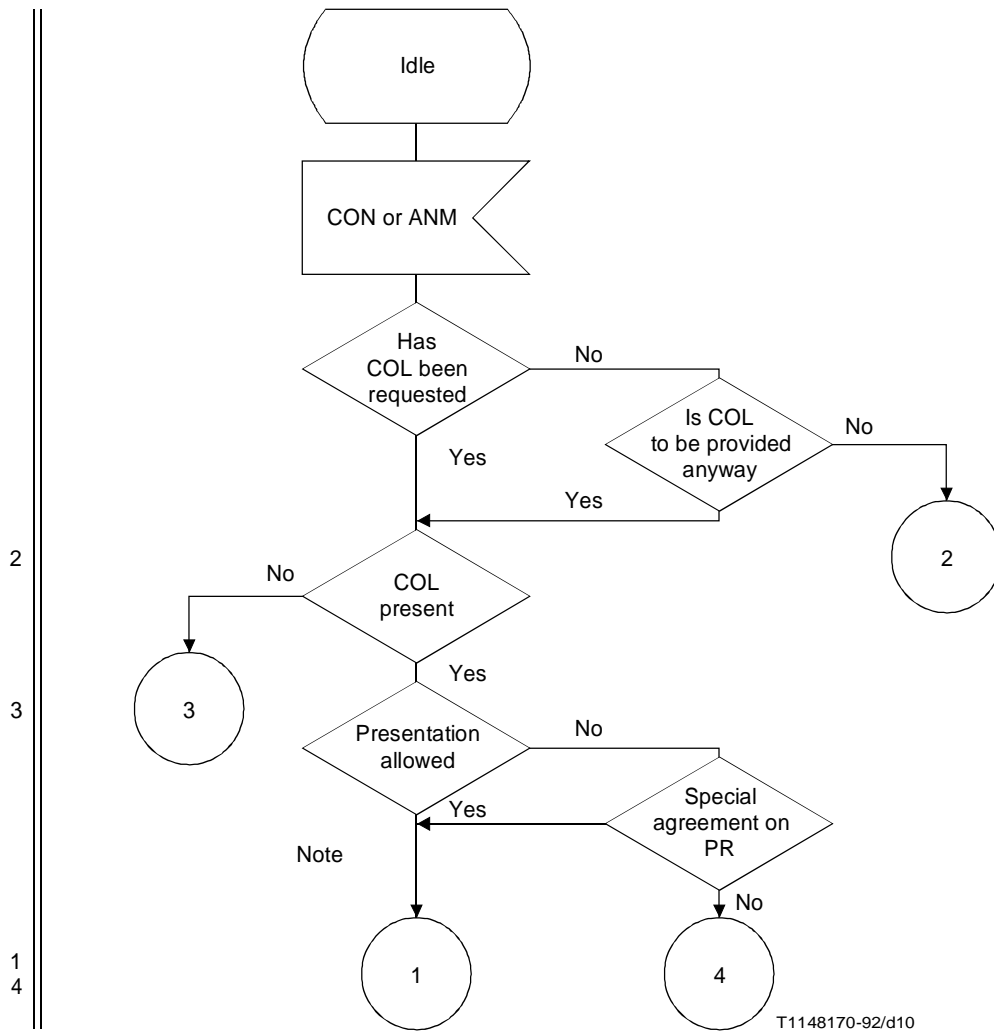

T1148170-92/d10

COL Connected line identity
 PR Presentation restriction
 SI Screening indicator

Note – This flow assumes that there is no restriction on passing non-restricted COL's across the international boundary if no such agreement exists then any COL in the incoming CON or ANM will be removed and the PR indicator set to 10. "COL not available".

FIGURE 9/Q.767 (sheet 1 of 2)

Nodal signalling function for COLP and COLR incoming international gateway

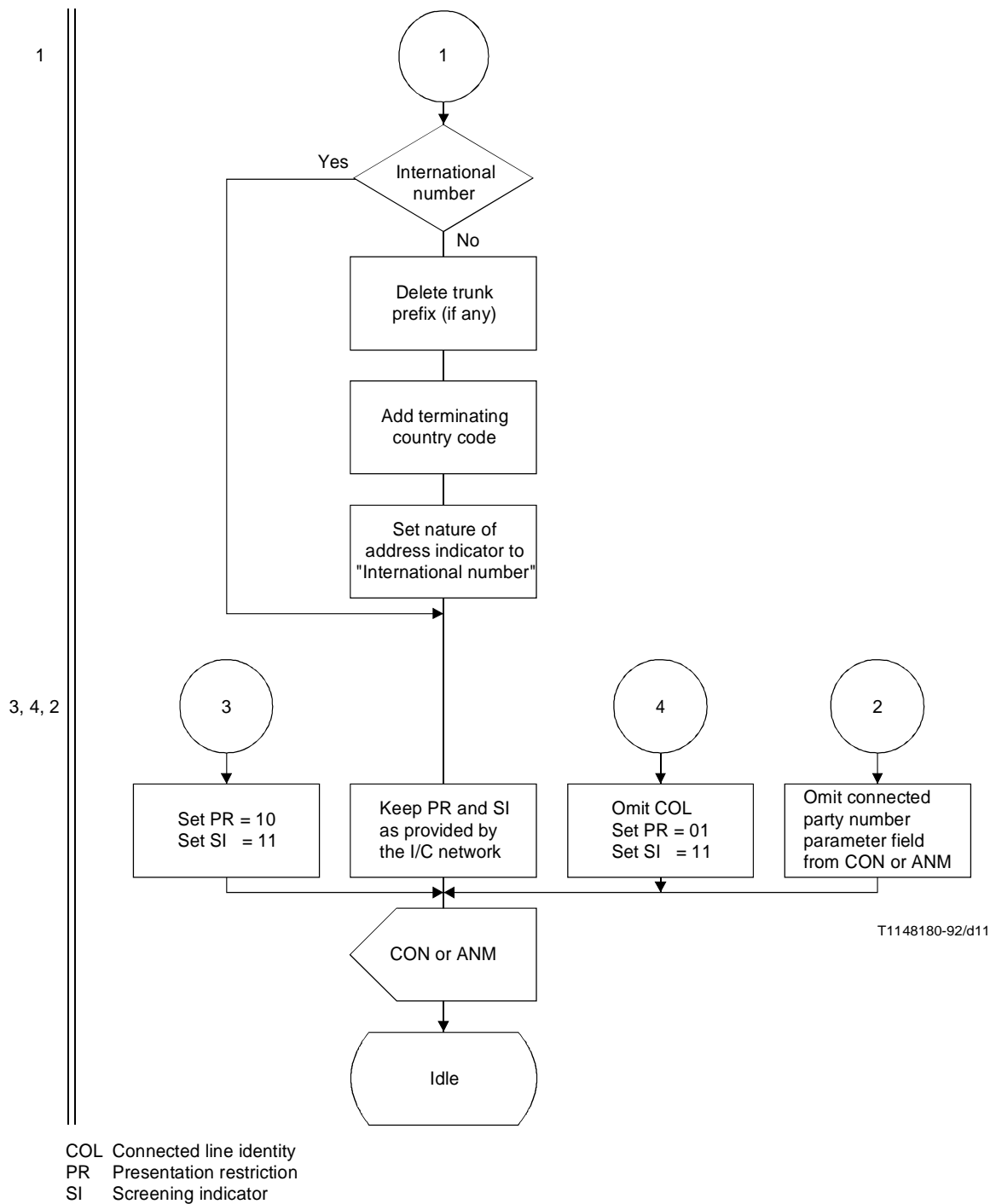
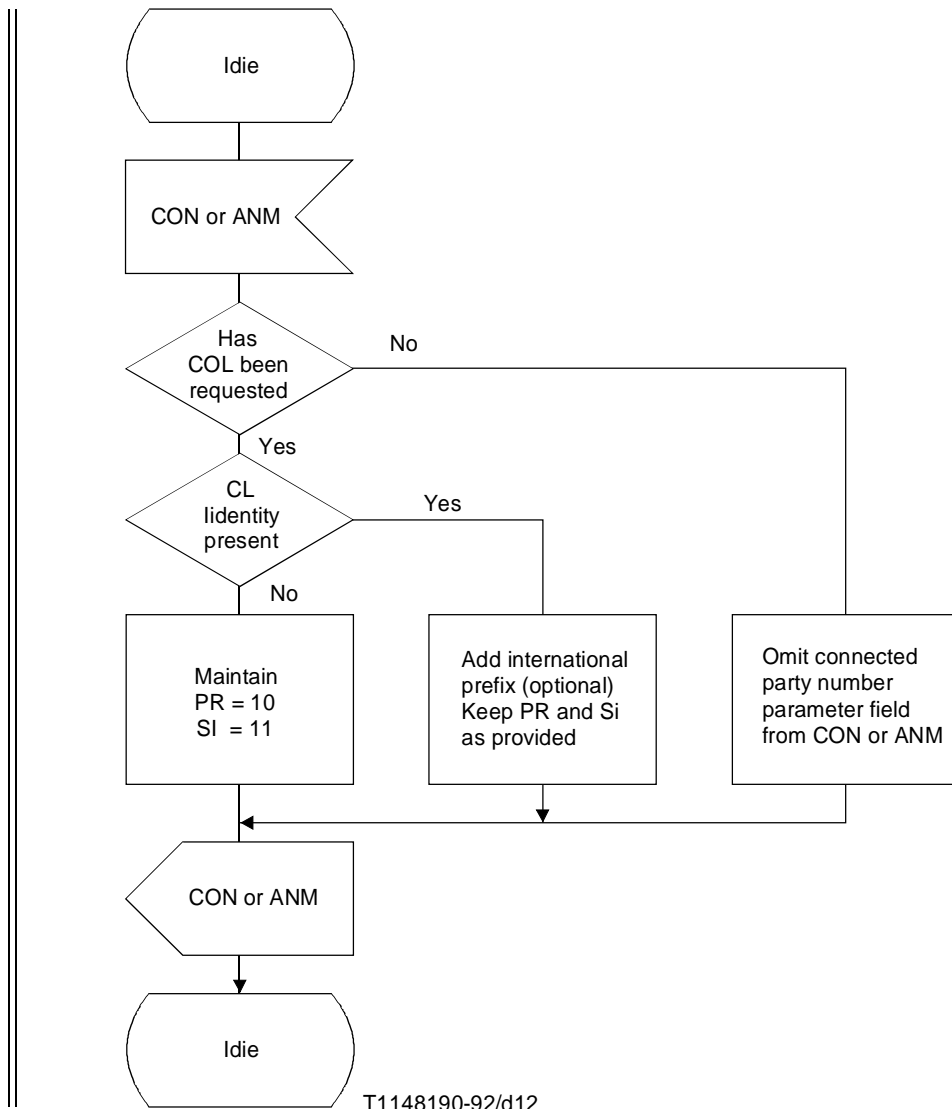

FIGURE 9/Q.767 (sheet 2 of 2)

Nodal signalling function for COLP and COLR incoming international gateway



COL Connectd line identity
 PR Presentation restriction
 Si Screening indicator

FIGURE 10/Q.767

Nodal signalling functions for COLP and COLR originatiog international gateway exchange

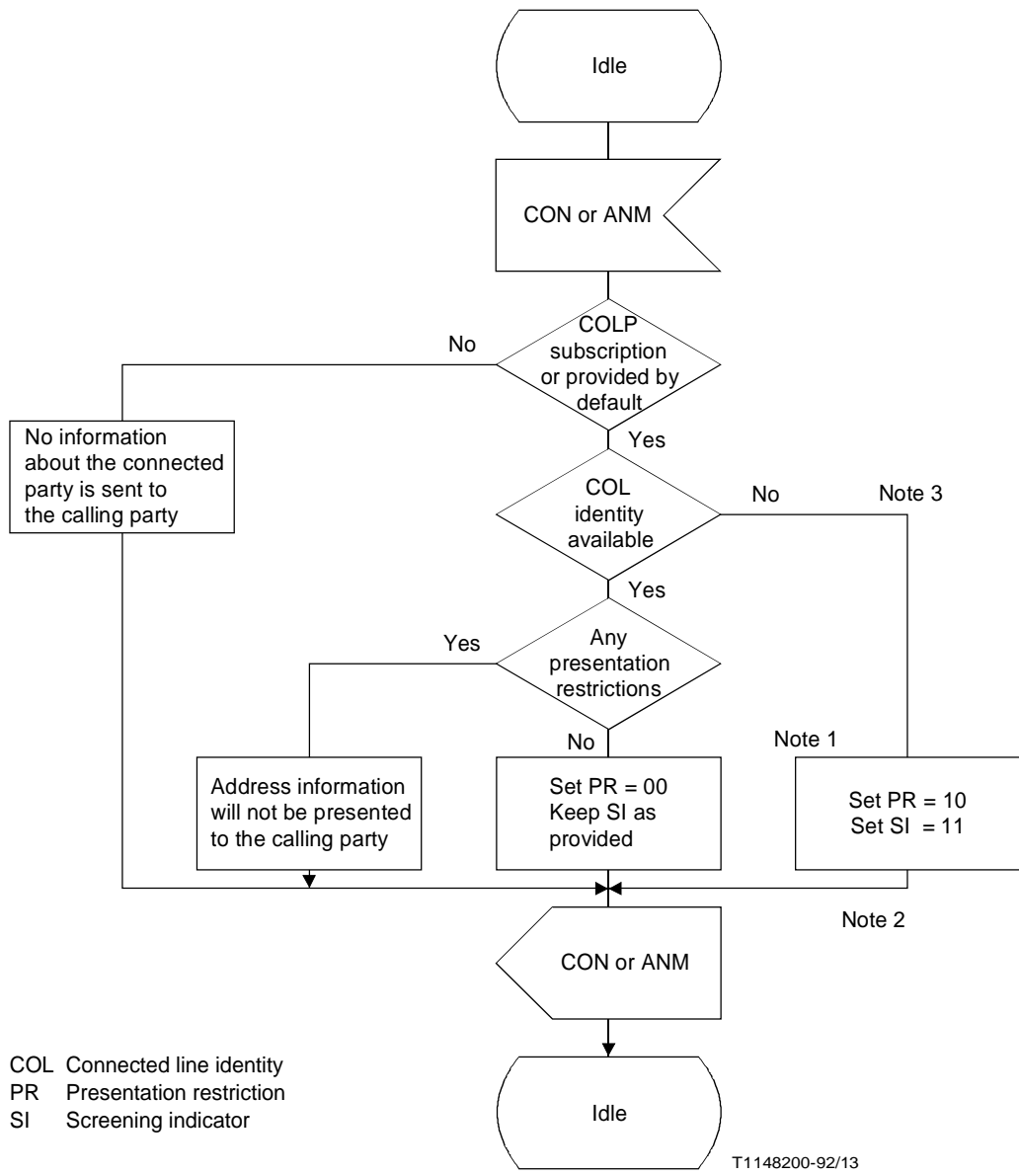

Note 1 – Presentation may be restricted due to national requirements or presentation restriction. Presentation restriction may be overridden due to calling party's category (e.g. Police).
Note 2 – In the case where the address information is indicated as not available due to interworking, etc. Only the indicators are presented to the user.
Note 3 – The "Connected Party Number parameter" is not included in the incoming CON or ANM.

FIGURE 11/Q.767

Nodal signalling functions for COLP and COLR originating local exchange
 (This figure is not applicable for the international interface and provided for information only)

3.6.2.1.4 *Interaction of COLP with other supplementary services*

3.6.2.1.4.1 *Calling Line Identification Presentation*

No interaction.

3.6.2.1.4.2 *Calling Line Identification Restriction*

If a user has Calling Line Identification Restriction (CLIR) activated then COLR will also be activated. Therefore the number of the user will not be available for presentation on both incoming and outgoing calls.

3.6.2.1.4.3 *Connected Line Identification Restriction*

The Connected Line Identification will not be presented if the connected user has an arrangement to inhibit the presentation of his number to the calling party.

3.6.2.1.4.4 *Closed user group*

No interaction.

3.6.2.1.4.5 *User to user information*

No interaction.

3.6.2.1.5 *Interaction of COLR with other supplementary services*

3.6.2.1.5.1 *Calling Line Identification Presentation*

If a user has COLR activated then CLIR will also be activated. Therefore the number of the user will not be available for presentation on both incoming and outgoing calls.

3.6.2.1.5.2 *Calling Line Identification Restriction*

No interaction.

3.6.2.1.5.3 *Connected Line Identification Presentation*

COLR will take precedence over COLP.

The only occasion when a user subscribing to Connected Line Identification Presentation can take precedence over Connected Line Identification Restriction is when the user has override category. This is a national option.

3.6.2.1.5.4 *Closed user group*

No interaction.

3.6.2.1.5.5 *User to user information*

No interaction.

4 Guidelines for ISDN international interconnections

4.1 *Clarifications to ISUP basic call control procedures*

4.1.1 *Handling of unrecognized signalling information*

All signalling information not described in the Blue Book ISUP signalling specifications as amended by the exceptions contained in § 3 of this Recommendation, is considered as unrecognized signalling information. The following section intends to recommend, as far as possible, standard reactions to the receipt of such unrecognized signalling information (unrecognized messages, parameters and parameter values).

4.1.1.1 *In international ISUP transit situations*

Unrecognized messages and parameters should be discarded without disrupting normal call handling. As far as unrecognized signalling information is concerned, the following principles are applied:

- fields/bits marked as not used in § 3 of this Recommendation are passed on unchanged;
- spare values are passed on unchanged;
- spare fields/bits are passed on unchanged or reset to zero;
- fields/bits marked as national use are passed on unchanged or reset to zero.

Unrecognized parameter values should be handled as indicated below:

Default: handle as if the default value was received; the default value is sent.

Ignore: the value is “don't care”; the received value may be passed on unchanged or reset to zero.

No Default: value received passed on unchanged.

TABLE 8/Q.767 (sheet 1 of 4)

Q.763 Section	Title	Action
3.2	Access Transport parameter	No Default (see § 4.3 of Rec Q.767)
3.3	Automatic congestion level	Discard parameter
3.4	Backward call indicators Charge indicators Bits B A Called party status indicators Bits D C Called party category indicator Bits F E End to end method indicator Bits H G End to end information indicator Bit J Holding indicator (national use) Bit L SCCP method indicator Bits P O	No Default No Default No Default No Default No Default Ignore No Default
3.7	Called party number Nature of address indicator Numbering plan indicator Spare Address signals Filler	Release with cause value 28 Release with cause value 28 Ignore Release with cause value 28 (Note) Default: 0000
3.8	Calling party number Nature of address indicator Number incomplete indicator Numbering plan indicator Presentation restricted indicator Screening indicator Address signals Filler	No Default No Default No Default No Default No Default No Default Ignore

TABLE 8/Q.767 (sheet 2 of 4)

Q.763 Section	Title	Action
3.9	Calling party's category	No Default
3.10	Cause indicators Coding standard Spare Location Cause value	No Default Ignore No Default No Default
3.11	Circuit group supervision message type indicator Bits B A Bits C-H: Spare	Discard message Ignore
3.13	CUG interlock code	No Default
3.14	Connected number Nature of address indicator Spare Numbering plan indicator Presentation restricted indicator Screening indicator Address signals Filler	No Default Ignore No Default No Default No Default No Default Ignore
3.16	Continuity indicators Bits B-H: spare	Ignore
3.18	Event information Event indicator Bits GFEDCBA	No Default
3.20	Forward call indicator End to end method indicator Bits C B End to end information indicator Bit E ISUP preference indicator Bits H G SCCP method indicator Bits K J Spare: Bit L Bits M-P (national use)	No Default No Default Release with cause 111 No Default Ignore Ignore

TABLE 8/Q.767 (sheet 3 of 4)

Q.763 Section	Title	Action
3.23	Nature of connection indicators Satellite indicator Bits B A Continuity indicator Bits D C Spare Bits F-H	Default: 10 "two satellites in the connection" Default: 00 "continuity check not required" unless required on the outgoing circuit Ignore
3.24	Optional backward call indicators Bit B: Call forwarding may occur Bits C-D: spare Bit E-H (national use)	No Default Ignore Ignore
3.25	Optional forward call indicator Closed user group call indicator Bits B A Spare Bits C-G	No Default Ignore
3.27	Range and status	See Rec. Q.764, §§ 2.10.3 and 2.9.2
3.32	Subsequent Number Spare Bits 1-7 Address signal Filler	Ignore Release with cause 28 (Note) Default: 0000
3.33	Suspend/Resume indicators Spare Bits B-H	Ignore
3.35	Transmission medium requirement	Release with cause 65

TABLE 8/Q.767 (sheet 4 of 4)

Q.763 Section	Title	Action
3.36	User Service Information	No Default (see § 4.3 of Rec. 767)
3.37	User to User indicators Type Bit A Service 1 Bits C B Service 2 Bits E D Service 3 Bits G F Network discard indicator Bit H	No Default No Default No Default No Default No Default

Note – Evaluated as far as needed for routing.

4.1.1.2 *In incoming/outgoing gateway or in interworking situations*

Unrecognized messages and parameters should be discarded without disrupting normal call handling.

Unrecognized parameter values should be handled as indicated below:

Default: handle as if the default value was received.

Ignore: the value is “don’t care”; the received value may be passed on unchanged or reset to zero.

No Default: value passed on unchanged.

TABLE 9/Q.767 (sheet 1 of 4)

Q.763 Section	Title	Action
3.2	Access Transport parameter	No Default (see § 4.3 of Rec. Q.767)
3.3	Automatic congestion level	Discard parameter
3.4	Backward call indicators Charge indicators Bits B A Called party status indicators Bits D C Called party category indicator Bits F E End to end method indicator Bits H G End to end information indicator Bit J Holding indicator (national use) Bit L SCCP method indicator Bits P O	Default: 10 "charge" Default: 00 "no indication" Default: 00 "no indication" Default: 00 "no end to end method available" Default: 0 "no end to end info available" Ignore Default: 00 "no indication"
3.7	Called party number Nature of address indicator Numbering plan indicator Spare Address signals Filler	Release with cause value 28 Release with cause value 28 Ignore Release with cause value 28 (Note) Default: 0000

TABLE 9/Q.767 (sheet 2 of 4)

Q.763 Section	Title	Action
3.8	Calling party number Nature of address indicator Number incomplete indicator Numbering plan indicator Presentation restricted indicator Screening indicator Address signals Filler	Discard parameter Discard parameter Discard parameter Default: 01 "presentation restricted" Discard parameter No Default Default: 0000
3.9	Calling party's category	Default: 0000 1010 " ordinary subscriber"
3.10	Cause indicators Coding standard Spare Location Cause value	Default: 00 "CCITT" Ignore Default: 0111 "International network" Default: "Unspecified within class XXX"
3.11	Circuit group supervision message type indicator Bits B A Bits C-H: Spare	Discard message Ignore
3.13	CUG interlock code	No Default
3.14	Connected number Nature of address indicator Spare Numbering plan indicator Presentation restricted indicator Screening indicator Address signals Filler	Discard parameter Ignore Discard parameter Default: 01 "presentation restricted" Discard parameter No Default Default: 0000
3.16	Continuity indicators Bits B-H: spare	Ignore

TABLE 9/Q.767 (sheet 3 of 4)

Q.763 Section	Title	Action
3.18	Event information Event indicator Bits G F E D C B A	No Default
3.20	Forward call indicator End to end method indicator Bits C B End to end information indicator Bit E ISUP preference indicator Bits H G SCCP method indicator Bits K J Spare: Bit L Bits M-N (national use)	Default: 00 "no end to end method available" Default: 0 " no end to end info available" Release with cause 111 Default: 00 "no indication" Ignore Ignore
3.23	Nature of connection indicators Satellite indicator Bits B A Continuity indicator Bits D C Spare Bits H-F	Default: 10 "two satellites in the connection" Default: 00 "continuity check not required" Ignore
3.24	Optional backward call indicators Bit B: Call forwarding may occur Spare: Bits C-D Bits E-H (national use)	Default: 0 " no indication" Ignore Ignore

TABLE 9/Q.767 (sheet 4 of 4)

Q.763 Section	Title	Action
3.25	Optional forward call indicators Closed user group call indicator Bits B A Spare Bits C-G	Default: 00 "Non CUG call" Ignore
3.27	Range and status	See Rec. Q.764, §§ 2.10.3 and 2.9.2
3.32	Subsequent number Spare Bits 1-7 Address signal Filler	Ignore Release with cause 28 (Note) Default: 0000
3.33	Suspend/Resume indicators Spare Bits B-H	Ignore
3.35	Transmission medium requirement	Release with cause 65
3.36	User Service Information	No Default (see § 4.3 of Rec. Q.767)
3.37	User to User indicators Type Bit A Service 1 Bits C B Service 2 Bits E D Service 3 Bits G F Bit H	Default: 1 "response" Default: 00 "no information" Default: 00 "no information" Default: 00 "no information" Default: 1 " Network discard"

Note – Evaluated as far as needed for routing.

4.1.1.3 *Format errors*

The following are considered as message format errors:

- The message length is less than the number of octets required for the fixed mandatory part, the mandatory variable pointers and the start of optional parameters pointer.

- A mandatory variable or start of optional parameter's pointer points beyond the message length.

- A mandatory variable or optional parameter's length indicator causes the overall message length to be exceeded.

When a message format error is detected, the message shall be discarded.

Note – A format error can only be detected when the message type is recognized.

For the purpose of format error detection, the message length may be interpreted as either:

- i) the received message length, or

- ii) the maximum message length (SIF = 272 octets).

Interpretation i) is preferred as it will detect errors which may not be found by interpretation ii). However it is not contained in the MTP Recommendation that the received message length is passed to its users by the MTP.

4.1.2 *Cause values*

The list of causes supported and the code values are listed in Q.763 amended by the exceptions (see Table 4/Q.767). This section contains clarification of the usage of cause values, the handling of location indicators, the relation to relevant Q.764/Q.730 procedures. Some guidance to the correspondence with other signalling systems failure signals is also given.

4.1.2.1 Usage of causes

Table 10/Q.767 indicates the usage of cause values for the international interface.

a) *meaning of notes:*

*location: see item b) "handling of location indicators"

b) *used abbreviations:*

U: user

PRN: private network serving the remote user

TN: transit network

INT: international network

RN: public network serving the remote user

Setting causes 18 and 19, and using location "public or private network serving the remote user" or any other cause with location "user or private network serving the remote user" should imply that the call has reached the called party, i.e end to end fields have been transmitted.

National networks should make sure, to avoid public network misuse, that the following locations are not generated on the access:

- public, international, transit network and beyond an interworking point.

The cause value sent is the one of the latest occurred event (e.g. retransmitting of the release message).

TABLE 10/Q.767 (sheet 1 of 3)

Cause	Definition Q.762	Location	Reference	Notes
1	Unallocated number U, PRNQ.931	... no route by digit analysis
 RN	
 TN, INT.....	
3	No route to destination U, PRNQ.931	
4	Send special information tone(Q.931: no proc) see Rec. Q.35 § 7
16	Normal call clearing U, PRNQ.931	
17	User busy U, PRN, RNQ.931	
18	No user responding.....	... RNQ.931	
19	User alerting no answer.....	... RNQ.931	...] expiry of waiting ANM timer (T9)
 INTQ.767 (D.2.1.4.4),	...] (generated by international outgoing
Q.767 (D.2.10.8.3)	...] exchanges)
	
21	Call rejected.....	... U, PRNQ.931	
22	Number changed.....	... U, PRNQ.931	
27	Destination out of order.....	... RNQ.931	
28	Address incomplete U, PRN, RNQ.931	...] the called party number is not in a
 TN,INT.....	...Q.767 (D.2.1.1),.....	...] valid format or is not complete.
Q.767 (D.2.1.2.1),...	...]
Q.767 (D.2.10.8.3)..	...]
Q.767 (D.2.2.5).....	...]
29	Facility rejected RN, U, PRN(Q.931: no proc)	...inability to provide a requested
 TN, INT.....signalling capability.

TABLE 10/Q.767 (sheet 2 of 3)

Cause	Definition Q.762	Location	Reference	Notes
31	Normal, unspecified RNQ.931	...] call failure information indicating ...] the failure of a call due to the lapse ...] of a timeout or a fault not covered ...] by specific causes ...] (examples: expiry of timers Q.764 ...] not covered by specific causes, ...] release of interconnected] circuit, . . .) ...]
 TN, INT.....	...Q.767 (D.2.1.1.1).	
Q.767 (D.2.1.2.1).	
Q.767 (D.2.9.1),...	
Q.767 (D.2.9.2.1).	
Q.767 (D.2.9.2.2).	
Q.767 (D.2.10.3),.	
Q.767 (D.2.10.6),.	
Q.767 (D.2.10.8.2)	
Q.767 (D.2.10.8.3)	
34	No circuit available U, PRN, RNQ.931	...] circuit congestion encountered on ...] an international exchange or in ...] the national destination network.
 TN, INT.....	
	
	
38	Network out of order(Q.931: no proc)	
41	Temporary failure.....	... U, PRN, RNQ.931	
42	Switching equipment congestion RN, TN, INT		
44	Q.931 (requested channel not available) U, PRN.....	...Q.931	
47	Resource unavailable, unspecified.(Q.931: no proc)	
55	Incoming calls barred within CUG.....	... RN.....	...Q.767 (E.3.2.3)	
57	bearer capability not authorized			
58	Bearer capability not presently available			

TABLE 10/Q.767 (sheet 3 of 3)

Cause	Definition Q.762	Location	Reference	Notes
63	Service/option not available, unspecified			
65	Bearer capability not implementedTN, INT inability to provide a requested ... TMR
79	Service/option not implemented, unspecified			
87	User not member of CUGRN, INT Q.767 (E.3.2.3, and ... E 3.2.2)	
88	Incompatible destinationU, PRN.....	... Q.931	
95	Invalid message, unspecified			
102	Recovery on timer expiryRN.....INT..... Q.767 (D.2.5.1.1), Q.767 (D.2.5.1.2), Q.767 (D.2.5.3) Q.767 (D.2.5.1.3), Q.767 (D.2.5.3)] expiry of waiting RES(user) ...] timer ...] ...] expiry of waiting RES ...] (network) timer ...] (not generated by international ...] transit exchanges)
111	Protocol error, unspecifiedRN.....	... Q.931	
127	Interworking, unspecified			

4.1.2.2 *Handling of location indicators*

If the event causing the sending of the cause indicators parameter takes place in the international exchange (i.e. incoming or outgoing gateway or international transit exchange), the location will be set “0111 International network”.

If interworking is encountered in the international exchange and if a message containing the cause indicators parameter is sent because of the receipt of a message of the other signalling system, the location will be set “1010 Beyond an interworking point” (BI).

The location “public network serving the local user” or “private network serving the local user” should not be sent on the international section. The conversion from “public network serving the local user” to “public network serving the remote user” or “private network serving the local user” to “private network serving the remote user” shall take place in the national network generating the cause.

In all other cases the international exchange will pass on the received location.

Using this solution, it is impossible to distinguish a national location “transit network” from a location “transit network beyond the international boundary”.

The real location where the event was generated is lost when interworking: for example CGC and NNC in TUP are coded “34,BI”. In spite of that, the limitations of this solution are accepted, because they are considered as acceptable for this international ISUP version.

4.1.2.3 *Interworking*

In Table 11/Q.767 some guidelines can be found for the handling of cause values in the case of interworking with some other CCITT signalling systems in an international exchange.

TABLE 11/Q.767 (sheet 1 of 3)

TUP

Signal	Cause #
ACB Access barred	88 Incompatible destination
ADI Address incomplete	28 Address incomplete
CGC Circuit group congestion	34 No circuit available
DPN Digital path not provided	65 Bearer capability not implemented
LOS Line out of service	27 Destination out of order
NNC National network congestion	34 No circuit available
RSC Reset circuit CFL Call failure GRS Circuit Group reset	31 Normal unspecified
SEC Switching equipment congestion	42 Switching equipment congestion
SSB Subscriber busy	17 User busy
SST Send special information tone	4 Send special information tone
UNN Unallocated number	1 Unallocated number
CLF Clear forward	16 Normal call clearing
Call failure due to the expiry of timer according to Rec. Q.118, § 4.3.3 at the incoming gateway	102 Recovery on timer expiry
Information indicating the failure of a call due to expiry of timer or a fault not covered elsewhere	127 Interworking unspecified

TABLE 11/Q.767 (sheet 2 of 3)

R2

Signal	Cause #
A4/B4 Congestion in the national network	34 No circuit available
A15 Congestion in an international exchange or at its output	34 No circuit available
A3+B2 Send special information tone	4 Send special information tone
A3+B3 Subscriber's line busy	17 User busy
A3+B5 Unallocated number	1 Unallocated number
A3+B8 Subscriber's line out of order	27 Destination out of order
Clear forward	16 Normal call clearing
Call failure due to the expiry of timer according to Rec. Q.118, § 4.3.3 at the incoming gateway	102 Recovery on timer expiry
Information indicating the failure of a call due to expiry of timer or a fault not covered elsewhere	127 Interworking unspecified (Note)

Note – In case of R2 signals B9-B15, see Recommendations Q.400, Q.441, Q.474 and Q.480.

N 5

Event	Cause #
Clear forward	16 Normal call clearing
Busy flash F2	34 No circuit available
Information indicating the failure of a call due to expiry of timer or a fault not covered elsewhere	127 Interworking unspecified

TABLE 11/Q.767 (sheet 3 of 3)

CCITT No. 6

Signal	Cause #
ADI Address incomplete	28 Address incomplete
CGC Circuit group congestion	34 No circuit available
LOS Line out of service	27 Destination out of order
NNC National network congestion	34 No circuit available
RSC Reset circuit CFL Call failure RSB Reset band	31 Normal unspecified
SEC Switching equipment congestion	42 Switching equipment congestion
SSB Subscriber busy	17 User busy
SST Send special information tone	4 Send special information tone
UNN Unallocated number	1 Unallocated number
CLF Clear forward	16 Normal call clearing
Call failure due to the expiry of timer according to Rec. Q.118, § 4.3.3 at the incoming gateway	102 Recovery on timer expiry
Information indicating the failure of a call due to expiry of timer or a fault not covered elsewhere	127 Interworking unspecified

4.1.3 *Charging*

Charging indicators are basically defined for national use. Therefore, unless bilateral agreement, the decision to charge a call or not, or to start international accounting will not be decided upon reception of these indicators.

4.1.4 *Operator services*

4.1.4.1 *Forward transfer*

The support of the FOT message in the international interface does not impose that the related functions are implemented in each gateway (e.g. language assistance).

4.1.4.2 *Called part number for operator calls*

International gateways should support access to operators equipment as specified in Recommendation Q.101.

The sending sequence of specific forward address information to be sent for calls to operators (incoming, delay or particular delay operator) is shown below. The other informations of the IAM are coded as the ones for an automatic call IAM (nature of connection indicator, TMR, etc.).

4.1.4.2.1 *International transit operator call*

* Called party number: nature of address indicator: "0000100" international number
address: * country code: I₁, I₁I₂, I₁I₂I₃

* extra digit designating the incoming international exchange N₁ (see Note 1)

* access to operator's position: Code 11 or Code 12 or special number (see Note 2)

* number of a particular position: x₁(x₂x₃...)

* sending finished: ST

Note 1 – The extra digit (N₁) designating the incoming international exchange is used in cases where more than one incoming international exchange can be reached in the country of destination. The insertion of the extra digit is not mandatory (see Recommendation Q.107).

Note 2 – The incoming operator or the delay operator may be obtained by using a special number (see Recommendation Q.101).

* Calling party's category:

“00000001” operator, language French

“00000010” operator, language English

“00000011” operator, language German

“00000100” operator, language Russian

“00000101” operator, language Spanish

4.1.4.2.2 *International terminal operator call*

* Called party number: nature of address indicator: “0000011” national (significant) number
address: * extra digit designating the incoming international exchange N_1 (see Note 1, § 4.1.4.2.1)

* access to operator's position: Code 11 or Code 12 or special number (see Note 2, § 4.1.4.2.1)

* number of a particular position: $x_1(x_2x_3\dots)$

* sending finished: ST

* Calling party's category:

“00000001” operator, language French

“00000010” operator, language English

“00000011” operator, language German

“00000100” operator, language Russian

“00000101” operator, language Spanish

4.1.5 *Test Calls*

4.1.5.1 *Called number for calls to testing and measuring devices*

This section only describes the standard sending sequence of forward address information in the case of calls to testing and measuring devices.

* Called party number: nature of address indicator: "0000011" national (significant) number
address: * access code for a particular testing or measuring device: XY (as given in Recommendation Q.107 Blue Book)

* sending finished: ST

* Calling party's category: "00001101" test call

Note – The principles in Recommendation Q.107 (Blue Book) are not always applicable to the international network.

4.1.5.2 *Called number for test calls*

This section only describes the sending sequence of forward address information in the case of test calls based on bilateral agreements.

* Called party number: nature of address indicator: "0000011" national (significant) number
address: * access code $N_1 \dots N_n$ based on bilateral agreements.

* sending finished: ST

* Calling party's category: "00001101" test call

4.1.5.3 *Accounting of test calls*

In international accounts, tests should be deducted according to CCITT Recommendation D.390-R 7.

4.1.6 *Continuity Check*

As a minimum requirement, international gateways should support the continuity check procedure, initiated by the reception of a CCR message or of a continuity check indicator in the IAM, by providing a check loop on 4 wire circuits, on a call by call basis. This procedure is described in Recommendation Q.764, § 2.1.8, and in Recommendation Q.724, § 7 and in § 3.5 of this Recommendation.

International gateways should support the continuity check procedure on previous circuit as described in Recommendation Q.764, (§ 2.1.8 as amended by Table 5/Q.767), and Recommendation Q.724, § 7.

If in an interworking situation with any non No. 7 Signalling System or a national Signalling System No. 7 not performing continuity check, a continuity check has to be performed on one or more of the circuits involved in the connection preceding the interworking point, appropriate measures (e.g. digit dragging) must be taken to prevent alerting of the called party until the continuity of such circuits has been verified.

4.1.7 *Application of Recommendation Q.118 for suspend/resume (network)*

The suspend (network) message in the ISDN UP can be generated by the network in response to a clearback indication from an interworking node or an on-hook condition from an analogue called party.

When an outgoing gateway receives the suspend (network) message, this gateway starts a timer (1-2 minutes) according to Recommendation Q.118, § 4.3.2. If this timer expires, the release procedure is initiated on both sides.

When an incoming gateway sends the suspend (network) message, this gateway starts a timer (2-3 minutes) according to Recommendation Q.118, § 4.3.3, unless this function is already provided in the national network. If this timer expires, the release procedure is initiated on both sides.

4.1.8 *Terminal Portability*

The Terminal Portability supplementary service allows a calling as well as a called user to move a terminal from one socket to another during the established state of a call. It is also possible to replace a terminal by another compatible terminal or to suspend and resume the call without changing the terminal or the socket.

The user initiated suspend and resume procedures as described in Recommendation Q.764, § 2.5, are applied. The suspend/resume indicator in the suspend and resume messages are set to "ISDN subscriber initiated".

If interworking with a network or a signalling system not supporting remote user notification of call suspension/resumption occurs, user initiated suspend/resume messages received will be discarded. If the clearback signal is not needed in the national network, it is recommended that no mapping, e.g. to clearback should be performed.

4.1.9 *Subaddress*

During call set-up, the called party subaddress provided by the calling party is transported from the originating to the destination exchange, in the IAM.

The calling party may also provide its own subaddress to complement the calling line identification, as provided in the CLI service. This subaddress is transported from the originating to destination exchange, in the IAM.

The called party may also provide its own subaddress to complement the connected line identification as provided in the COL service. This subaddress is transported from the destination to originating exchange, in the ANM or CON.

Up to 20 octets of subaddress information can be conveyed. Calling and called party subaddress information is conveyed in the ATP parameter of the IAM. Connected line subaddress information is conveyed in the ATP parameter in the ANM or CON.

No notification of delivery or non delivery of subaddress information is sent to the subaddress sending user.

On interworking with a network or a signalling system which does not support the transfer of the received subaddress (due to a shorter length or no subaddress at all), the whole subaddress information element is discarded. No notification of non delivery is provided.

4.1.10 *MTP pause/resume*

On reception of a MTP pause primitive, ISUP takes the following action:

- If the affected destination is not a destination (SP) known by ISUP (not connected by circuits to the exchange), no action takes place.
- If the affected destination is a destination (SP) known by the ISUP, the circuits connected to the inaccessible SP will be prohibited for new outgoing calls. If no other circuits are available to route these calls, they are released with the appropriate cause (34 – no circuit available).

All other procedures (blocking, unblocking, reset and continuity check) to be started on these circuits, and all procedures and calls already started before the MTP pause reception, are handled as usual. The local and remote ISUP will not receive answers to the messages sent; message repetition, reset procedures or normal call release procedures on time out will be initiated, depending on the duration of the SP inaccessibility.

On reception of a MTP resume primitive, ISUP takes the following action:

- If the affected destination is not a destination (SP) known by ISUP (not connected by circuits to the exchange), no action takes place.
- If the affected destination is a destination (SP) known by the ISUP, the circuits connected to the previously inaccessible SP can be used again for calls to that direction. The pending procedures that were running during the signalling relation unavailability, are completed as messages can be again exchanged between the two SPs. As a result of the time supervision mechanism for responses to the messages sent in each relevant procedure, the circuits affected by the signalling relation unavailability are restored to a normal state when the signalling relation becomes available.

4.1.11 *CIC allocation*

The following rules should apply for the allocation of CIC codes to circuits in the international network:

- the CIC should be coded according to the traffic circuit number between two switching units;
- the basis for the traffic circuit numbering should be the Recommendation M.140, Blue Book (switching unit related traffic circuit numbering);
- the CIC will be the binary code of the traffic circuit number without the letter Z or B.

4.2 *Clarifications to ISUP supplementary services*

The following summarizes the action taken by a national network not supporting a given supplementary service, and provides also consideration for international transit operation.

4.2.1 *Gateway (incoming/outgoing) reactions for supplementary services not supported in the national network*

As national networks may not fully support the basic services and supplementary services supported by this version of the international ISUP signalling system, it is essential to standardize the gateways reaction when receiving signalling information on the international section relevant to a service or supplementary service not provided or partially provided in the national network. Bilateral agreements are necessary before opening between two networks, a service supported by the international signalling system. It may happen however, that no service screening on a route basis is performed/feasible in the outgoing gateway; and therefore a service request for a national supplementary service not supported, may be received in an international gateway.

TABLE 12/Q.767

Supplementary service	Reaction in international gateway	Remarks
UUS 1 implicit	Incoming gateway: Reject UUS information received in IAM using user to user indicator bit H = 1 "Network discard" in ACM or CON Incoming/Outgoing gateway UUS information received in other messages is discarded without notification by the outgoing/incoming gateway	If no UUS information is sent in the IAM, the incoming (outgoing) national network should prevent the transmission of UUS in the backward (forward) direction
CLIP	Incoming gateway: Discard Calling Party Number	No notification is given
CLIR	Incoming gateway: Discard Calling Party Number if unable to handle or convey the restriction indication	No notification is given
CUG	See § 3.6 of Rec. Q.767	
COLP	Outgoing gateway: Discard Connected Number Incoming gateway: Send Connected Number parameter with indication address not available in ANM or CON	Connected number should be received only on request No notification is given
COLR	Outgoing gateway: Discard Connected Number if unable to handle or convey the restriction indication	No notification is given
Subaddressing	Discard subaddress	The national network shall discard the received subaddress No notification is given
Terminal portability	Discard suspend/resume (user initiated) messages	No notification is given

4.2.2 *Transit considerations*

In ISUP international transit working, all basic services and supplementary services defined for this version of the ISUP applicable for international ISDN interconnection should be supported in international transit operation, i.e. all related parameters should be transited unchanged.

If this is not possible, the same reaction as for an incoming/outgoing (or interworking) gateway should apply, as described in § 4.2.1.

4.3 *Handling of access information*

4.3.1 *General*

For a certain period of time, national ISDNs may not guarantee the support of all supplementary services and information elements contained in access protocol standards. It is, however, essential, in order to allow international ISDN communication, that a minimum common profile for the various services supported (see § 2) is defined.

These profiles for bearer capability (BC), high layer compatibility (HLC), low layer compatibility (LLC) are given as typical examples to allow gateways to perform necessary mapping, if needed (e.g. national network does not support the fully transparent transfer or handling of HLC, BC, LLC).

There is no intention however to restrict the sending of any further codings on the international section (but the result is not guaranteed). Checks on the codings sent/received are not mandatory in a gateway.

4.3.2 *Content of Access Transport parameter (ATP)*

No check should be made on the content of ATP, with reference to the table below. The maximum length should only be limited by the message length, as the content of ATP will probably evolve in the future. If maximum message length is exceeded, the user to user information (UUI) should be the first information discarded.

TABLE 13/Q.767

Message	Forward	Backward	Information element
ACM		X	Progress indicator
ANM		X	Progress indicator Connected party subaddress LLC
CPG		X	Progress indicator
CON		X	Progress indicator LLC Connected party subaddress
IAM	X Calling party subaddress		Progress indicator Called party subaddress LLC HLC

Note – Two progress indicators may be sent in a message.

It is not recommended to perform any check in the gateway, unless required, on the presence and validity (coding/ max length) of the information elements received in the ATP, in particular subaddress.

4.3.3 Coding of USI (BC), HLC, LLC

4.3.3.1 General

This section identifies the ISUP parameters and Q.931 information elements (Blue Book) that may be present with various services. It also proposes specific codings for the User Service Information (USI) parameter, high layer compatibility (HLC) information element and low layer compatibility (LLC) information element, which may be present at the international interface. The HLC, LLC information elements are included in the Access Transport parameter.

4.3.3.2 Relationship between services and signalling information

Table 14/Q.767 below identifies the relationship between services and the presence of USI(BC), HLC and LLC signalling information in the ISUP IAM.

TABLE 14/Q.767

O R I G I N A T I O N A L	N E T W O R K	Services		Parameter/info elements		
		Teleservice (Note 1)	Bearer Service	USI	HLC	LLC
I S D N	Note 3	Telephony	64 kbit/s unrestricted	Yes	Yes	Note 2
		Facsimile G2/G3		Yes	Yes	Note 2
		Facsimile G4		Yes	Yes	Note 2
		Mixed mode		Yes	Yes	Note 2
		Teletex		Yes	Yes	Note 2
		Videotex		Yes	Yes	Note 2
		3.1 kHz audio	Yes	No	Note 2	
		Speech	Yes	No	Note 2	
P S T N		Telephony/Voice band data	No	No	No	
		Digital connectivity	No	No	No	

Note 1 – All teleservices operate at 64 kbits/s as specified in Recommendation I.241.

Note 2 – LLC will be included if provided by the user. Guidelines for the application of LLC can be found in Annex L of Recommendation Q.931.

Note 3 – Analogue subscriber connected to an ISDN local exchange are treated as analogue subscribers in the PSTN, i.e. no USI, HLC or LLC, respectively is contained in the ISUP IAM.

Any USI parameter received not conforming to this section might result in the call being failed.

Transport of codings specified should at least be guaranteed across the international interface.

4.3.3.2.1 Teleservices

Key:

- x possibly examined at certain gateway and may be coded 0 or 1
- . it has no significance to the international network (e.g. coded according to network/user specific rules)

a) *Telephony*

User Service Information parameter

1 0 0 0 0 0 0 0	Octet 1	Coding standard and information transfer capability (speech)
1 0 0 1 0 0 0 0	2	Transfer mode and information transfer rate (64 kbit/s)
1 0 1 0 0 0 1 x	3	Layer identification and user information layer 1 (Rec. G.711 A/ μ law)

High layer compatibility information element

0 1 1 1 1 1 0 1	Octet 1	HLC information element identifier
0 0 0 0 0 0 1 0	2	Length (2 octets)
1 0 0 1 0 0 0 1	3	Coding standard, interpretation and presentation method of protocol profile
1 0 0 0 0 0 0 1	4	High layer characteristics identification (telephony)

b) *Facsimile G2/G3*

User Service Information parameter

1 0 0 1 0 0 0 0	Octet 1	Coding standard and information transfer capability (3.1 kHz audio)
1 0 0 1 0 0 0 0	2	Transfer mode and information transfer rate (64 kbit/s)
1 0 1 0 0 0 1 x	3	Layer identification and user information layer 1 (Rec. G.711 A/ μ law)

High layer compatibility information element

0 1 1 1 1 1 0 1	Octet 1	HLC information element identifier
0 0 0 0 0 0 1 0	2	Length (2 octets)
1 0 0 1 0 0 0 1	3	Coding standard interpretation and presentation method of protocol profile
1 0 0 0 0 1 0 0	4	High layer characteristics identification (fax G2/G3)

c) *Facsimile Group 4*

User Service Information parameter

10001000	Octet 1	Coding standard and information transfer capability (64 kbit/s)
10010000	2	Transfer mode and information transfer rate (64 kbit/s)
00100001	3	Layer identification and user information layer 1 protocol (V.110 rate adaptation)
10001111	3a	Synchronous; 56 kbit/s

Note – Octet 3 and 3a are used only when rate adaptation is applied.

High layer compatibility information element

01111101	Octet 1	HLC information element identifier
00000010	2	Length (2 octets)
10010001	3	Coding standard, interpretation and presentation method of protocol profile
10100001	4	High layer characteristics identification (fax group 4)

d) *Mixed mode*

User Service Information parameter

1 0 0 0 1 0 0 0	Octet 1	Coding standard and information transfer capability (64 kbit/s)
1 0 0 1 0 0 0 0	2	Transfer mode and information transfer rate (64 kbit/s)
0 0 1 0 0 0 0 1	3	Layer identification and user information layer 1 protocol (V.110 rate adaptation)
1 0 0 0 1 1 1 1	3a	Synchronous; 56 kbit/s

Note – Octet 3 and 3a are used only when rate adaptation is applied.

High layer compatibility information element

0 1 1 1 1 1 0 1	Octet 1	HLC information element identifier
0 0 0 0 0 0 1 0	2	Length (2 octets)
1 0 0 1 0 0 0 1	3	Coding standard, interpretation and presentation method of protocol profile
1 0 1 0 0 1 0 0	4	High layer characteristics identification (mixed mode)

e) *Teletex*

User Service Information parameter

1 0 0 0 1 0 0 0	Octet 1	Coding standard and information transfer capability (64 kbit/s)
1 0 0 1 0 0 0 0	2	Transfer mode and information transfer rate (64 kbit/s)
0 0 1 0 0 0 0 1	3	Layer identification and user information layer 1 protocol (V.110 rate adaptation)
1 0 0 0 1 1 1 1	3a	Synchronous; 56 kbit/s

Note – Octet 3 and 3a are used only when rate adaptation is applied.

High layer compatibility information element

0 1 1 1 1 1 0 1	Octet 1	HLC information element identifier
0 0 0 0 0 0 1 0	2	Length (2 octets)
1 0 0 1 0 0 0 1	3	Coding standard, interpretation and presentation method of protocol profile
1 0 1 1 0 0 0 1	4	High layer characteristics identification (teletex)

f) *Videotex*

User Service Information parameter

1 0 0 0 1 0 0 0	Octet 1	Coding standard and information transfer capability (64 kbit/s)
1 0 0 1 0 0 0 0	2	Transfer mode and information transfer rate (64 kbit/s)
0 0 1 0 0 0 0 1	3	Layer identification and user information layer 1 protocol (V.110 rate adaptation)
1 0 0 0 1 1 1 1	3a	Synchronous; 56 kbit/s

Note – Octet 3 and 3a are used only when rate adaptation is applied.

High layer compatibility information element

0 1 1 1 1 1 0 1	Octet 1	HLC information element identifier
0 0 0 0 0 0 1 0	2	Length (2 octets)
1 0 0 1 0 0 0 1	3	Coding standard, interpretation and presentation method of protocol profile
1 0 1 1 0 0 1 0	4	High layer characteristics identification (videotex)

4.3.3.2.2 *Bearer services*

a) *64 kbit/s unrestricted*

i) Synchronous 64 kbit/s working

User Service Information parameter

1 0 0 0 1 0 0 0
1 0 0 1 0 0 0 0

Octet 1 Coding standard and information transfer capability
(64 kbit/s)

2 Transfer mode and information transfer rate
(64 kbit/s)

ii) Synchronous 56 kbit/s working with V.110/X.30 rate adaptation and no NIC

User Service Information parameter

1 0 0 0 1 0 0 0
1 0 0 1 0 0 0 0
0 0 1 0 0 0 0 1
1 0 0 0 1 1 1 1

Octet 1 Coding standard and information transfer capability
(64 kbit/s)

2 Transfer mode and information transfer rate
(64 kbit/s)

3 Layer identification and user information layer 1
protocol (V.110 rate adaptation)

3a Synchronous; 56 kbit/s

iii) Synchronous rates less than 56 kbit/s with V.110/X.30 rate adaptation

User Service Information parameter

1 0 0 0 1 0 0 0
1 0 0 1 0 0 0 0

- Octet 1 Coding standard and information transfer capability (64 kbit/s)
- 2 Transfer mode and information transfer rate (64 kbits/s)

Low layer compatibility information element

0 1 1 1 1 1 0 0
0 0 0 0 0 1 0 1
1 0 0 0 1 0 0 0
1 0 0 1 0 0 0 0
0 0 1 0 0 0 0 1
0 0 0 user rate
1 0 0 x x 0 0 0

- Octet 1 LLC information element identifier
- 2 Length (5 octets)
- 3 Coding standard and information transfer capability (64 kbit/s)
- 4 Transfer mode and information transfer rate (64 kbit/s)
- 5 Layer identification and user information layer 1 protocol (V.110 rate adaptation)
 - 5a Synchronous; user rate
 - 5b Intermediate rate, with/without NIC and no flow control on Tx & Rx

iv) Synchronous 64 kbit/s working with X.25 protocol

User Service Information parameter

1 0 0 0 1 0 0 0	Octet 1 Coding standard and information transfer capability (64 kbit/s)
1 0 0 1 0 0 0 0	2 Transfer mode and information transfer rate (64 kbit/s)

Low layer compatibility information element

0 1 1 1 1 1 0 0	Octet 1 LLC information element identifier
0 0 0 0 0 1 0 0	2 Length (4 octets)
1 0 0 0 1 0 0 0	3 Coding standard and information transfer capability (64 kbit/s)
1 0 0 1 0 0 0 0	4 Transfer mode and information transfer rate (64 kbit/s)
1 1 0 0 0 1 1 0	6 Layer 2 identification and user information layer 2 protocol (X.25 link level)
1 1 1 0 0 1 1 0	7 Layer 3 identification and user information layer 3 protocol (CCITT X.25 packet layer)

Note 1 – Octet 5 is omitted when working at 64 kbit/s. The presence of the layer 2 and 3 information in octet 6 and 7 is identified by bits 7 and 6 of those octets being coded "10" and "11" respectively.

Note 2 – Octets 6 and 7 could also be coded as: 11001101 and 11100111, signifying X.75 SLP Layer 2 protocol and ISO 8208 Layer 3 protocol, respectively.

v) Synchronous 56 kbit/s with V.110/X.30 rate adaptation and X.25 protocol

User Service Information parameter

1 0 0 0 1 0 0 0	Octet 1	Coding standard and information transfer capability (64 kbit/s)
1 0 0 1 0 0 0 0	2	Transfer mode and information transfer rate (64 kbit/s)
0 0 1 0 0 0 0 1	3	Layer identification and user information layer 1 protocol (V.110 rate adaptation)
1 0 0 0 1 1 1 1	3a	Synchronous; 56 kbit/s

Low layer compatibility information element

0 1 1 1 1 1 0 0	Octet 1	LLC information element identifier
0 0 0 0 0 1 1 0	2	Length (6 octets)
1 0 0 0 1 0 0 0	3	Coding standard and information transfer capability (64 kbit/s)
1 0 0 1 0 0 0 0	4	Transfer mode and information transfer rate (64 kbit/s)
0 0 1 0 0 0 0 1	5	Layer identification and user information layer 1 protocol (V.110 rate adaptation)
1 0 0 0 1 1 1 1	5a	Synchronous; 56 kbit/s
1 1 0 0 0 1 1 0	6	Layer 2 identification and user information layer 2 protocol (CCITT X.25 link level)
1 1 1 0 0 1 1 0	7	Layer 3 identification and user information layer 3 protocol (X.25 packet layer)

Note – Octets 6 and 7 could also be coded as: 11001101 and 11100111, signifying X.75 SLP Layer 2 protocol and ISO 8208 Layer 3 protocol, respectively.

vi) Synchronous rates less than 56 kbit/s with V.110/X.30 rate adaptation and X.25 protocol

User Service Information parameter

1 0 0 0 1 0 0 0	Octet 1 Coding standard and information transfer capability (64 kbit/s)
1 0 0 1 0 0 0 0	2 Transfer mode and information transfer rate (64 kbit/s)

Low layer compatibility information element

0 1 1 1 1 1 0 0	Octet 1 LLC information element identifier
0 0 0 0 0 1 1 1	2 Length (7 octets)
1 0 0 0 1 0 0 0	3 Coding standard and information transfer capability (64 kbit/s)
1 0 0 1 0 0 0 0	4 Transfer mode and information transfer rate (64 kbit/s)
0 0 1 0 0 0 0 1	5 Layer identification and user information layer 1 protocol (V.110 rate adaptation)
0 0 0 user rate	5a Synchronous; user rate
1 0 0 x x 0 0 0	5b Intermediate rate, with/without NIC and no flow control on Tx & Rx
1 1 0 0 0 1 1 0	6 Layer 2 identification and user information layer 2 protocol (X.25 link level)
1 1 1 0 0 1 1 0	7 Layer 3 identification and user information layer 3 protocol (X.25 packet layer)

Note – Octets 6 and 7 could also be coded as: 11001101 and 11100111, signifying X.75 SLP Layer 2 protocol and ISO 8208 Layer 3 protocol, respectively.

vii) Asynchronous rates with V.110 rate adaptation

User Service Information parameter

1 0 0 0 1 0 0 0	Octet 1 Coding standard and information transfer capability (64 kbit/s)
1 0 0 1 0 0 0 0	2 Transfer mode and information transfer rate (64 kbit/s)

Low layer compatibility information element

0 1 1 1 1 1 0 0	Octet 1 LLC information element identifier
0 0 0 0 0 1 1 1	2 Length (7 octets)
1 0 0 0 1 0 0 0	3 Coding standard and information transfer capability (64 kbit/s)
1 0 0 1 0 0 0 0	4 Transfer mode and information transfer rate (64 kbit/s)
0 0 1 0 0 0 0 1	
0 1 0 user rate	5 Layer identification and user information layer 1 protocol (V.110 rate adaptation)
0 0 0 0 0 x x 0	5a Asynchronous; user rate (user rates up to 19.2 kbit/s possible)
0 x x x x x x x	
1 x	5b Intermediate rate, without NIC and with/without flow control on Tx & Rx
	5c Number of stop bits, number of data bits, parity
	5d Half/Full duplex, modem type

b) 3.1 kHz audio

i) 3.1 kHz audio with A/μ law

User Service Information parameter

1 0 0 1 0 0 0 0	Octet 1	Coding standard and information transfer capability (3.1 kHz audio)
1 0 0 1 0 0 0 0	2	Transfer mode and information transfer rate (64 kbit/s)
1 0 1 0 0 0 1 x	3	Layer identification and user information layer 1 protocol (Rec. G.711 A/μ law)

ii) Voice band data modem

User Service Information parameter

1 0 0 1 0 0 0 0	Octet 1	Coding standard and information transfer capability (3.1 kHz audio)
1 0 0 1 0 0 0 0	2	Transfer mode and information transfer rate (64 kbit/s)
1 0 1 0 0 0 1 x	3	Layer identification and user information layer 1 protocol (Rec. G.711 A/μ law)

Low layer compatibility information element

0 1 1 1 1 1 0 0	Octet 1	LLC information element identifier
0 0 0 0 0 1 1 1	2	Length (7 octets)
1 0 0 1 0 0 0 0	3	Coding standard and information transfer capability (3.1 kHz audio)
1 0 0 1 0 0 0 0	4	Transfer mode and information transfer rate (64 kbit/s)
0 0 1 0 0 0 1 x	5	Layer identification and user information layer 1 protocol (G.711 A/μ)
0 x 0 user rate	5a	Synchronous/asynchronous: user rate
0 0 0 x x x x 0	5b	Intermediate rate, with/without NIC and with/without flow control on Tx & Rx
0 x x x x x x x	5c	Number of stop bits, number of data bits, parity
1 x	5d	Half/full duplex, modem type

c) *Speech*

User Service Information parameter

1 0 0 0 0 0 0 0	Octet 1	Coding standard and information transfer capability (speech)
1 0 0 1 0 0 0 0	2	Transfer mode and information transfer rate (64 kbit/s)
1 0 1 0 0 0 1 x	3	Layer identification and user information layer 1 (Rec. G.711 A/μ law)

4.4 Clarifications for practical interconnections

4.4.1 Start up procedures

The start up procedure for ISUP circuits is a manually controlled procedure. It is initiated by each gateway exchange for its outgoing circuits. Bidirectional circuits are tested by both sides.

During the process of placing circuits into service, unacknowledged circuit supervision messages will most likely be reported to maintenance systems. In order to minimize this impact, it is recommended that coordination take place between exchanges and established procedures for placing circuit into service be followed. Lack of coordination may result in inefficient use of exchange and maintenance resources.

Before the test itself, some exchanges, named exchanges of type A do not require anything before the test call, and only respond to a received GRS (RSC) with a GRA (RLC/BLO) message. Other exchanges, named exchanges of type B, do require a GRS/GRA (or RSC/RLC) cycle before the continuity check or the conversation test is performed.

The start up procedure necessary for exchanges of type B is intended both for unidirectional and bidirectional circuits in accordance with §§ 4.4.1.1 and 4.4.1.2.

Possible relations are:

A -----> A
A -----> B
B -----> A
B -----> B

4.4.1.1 Initial procedure for putting the first circuits into service

- a) exchange A -----> exchange A

No initial procedure required

- b) exchange A -----> exchange B

<-----GRS-----
-----GRA----->

- c) exchange B -----> exchange A

-----GRS----->
<-----GRA-----

- d) exchange B -----> exchange B

-----GRS-----> <-----GRS-----
<-----GRA----- -----GRA----->

or

<-----GRS----- -----GRS----->
-----GRA-----> <-----GRA-----

Note – It is also possible to have individual reset circuit messages. The diagrams do not intend to cover all possible exchange of messages (see Recommendation Q.764).

4.4.1.2 *Initial procedure for putting additional circuits into service*

a) exchange A -----> exchange A

No initial procedure required

b) exchange A -----> exchange B

<-----RSC-----
-----RLC----->

c) exchange B -----> exchange A

-----RSC----->
<-----RLC-----

d) exchange B -----> exchange B

-----RSC-----> <-----RSC-----
<-----RLC----- -----RLC----->

or

<-----RSC----- -----RSC----->
-----RLC-----> <-----RLC-----

4.4.1.3 *Test procedures*

This section describes two different test procedures (named A and B) for the initial testing of circuit. As a minimum, it is required that an international exchange can actively perform one of these test procedure and respond to the other procedure.

Each exchange checks its own circuits. Bidirectional circuits are checked by both ends.

a) *Procedure using a conversation test*

----Test IAM---->

<-----ACM-----

<-----ANM-----

Conversation test

-----REL----->

<-----RLC-----

b) *Procedure using the continuity check procedure*

The continuity check procedure is used for the start up procedure, even if no continuity check is required during normal operation of the circuits.

exchange A or B ----- exchange A or B

test initiating exchange

- 1) ----- CGB ----- >
- <----- CGBA -----
- 2) ----- CCR ----- >

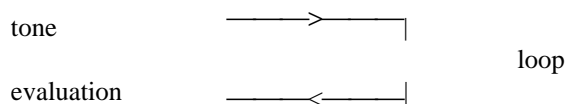

3) *If the test is OK*

----- REL ----- >

<----- RLC -----

- 4) the circuit is in the idle state blocked
- 5) perform the CCR, REL, RLC sequence for all remaining trunks that are to be brought into service.
- 6)

----- CGU ----- >

<----- CGUA -----

7) The trunks are in service

8) *If the test is not OK*

9)

----- COT (F) ----- >

10)

----- CCR ----- >

11)

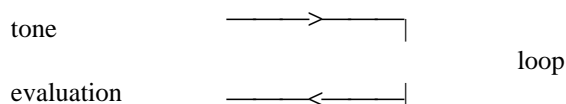

12) If the test is OK, continue as in 3)

13) If the test is not OK, report CIC, do not unblock trunk for outgoing traffic and continue CCR on the trunk then continue in 5).

Note – It is also possible to have individual blocking messages. The diagrams do not intend to cover all possible exchange of messages (see Recommendation Q.764).

4.4.2 *Interconnection test*

4.4.2.1 *Validation tests*

See Recommendations Q.780, Q.784 and Q.785.

4.4.2.2 *Compatibility tests*

See Recommendations Q.780, Q.784 and Q.785.

4.4.2.3 *Terminal to terminal tests (operational test calls)*

The aim of ISDN operational test calls is to verify, before opening ISDN services between countries, that these services are working properly from the user point of view. These calls are to be established as normal calls from real terminals in a country, to called numbers (corresponding to ISDN or non ISDN subscribers) provided by the other country, aiming to verify that:

- calls are correctly set up and compatible called terminals are selected, or calls are correctly rejected if no compatible called terminal exists;
- the data or voice transmission is possible with a normal quality;
- calls can be correctly released by the calling or called user.

4.4.3 *Routing*

See Recommendation E.172.

ANNEXES

(to Recommendation Q.767)

**ISDN User Part of Signalling System No. 7
for international interconnections**

Used conventions

- sections which are not applicable are replaced with:

(this section is not applicable to the international interface)

- paragraphs or sentences in a section which are not applicable are:

~~struck out~~

- added sections, paragraphs or sentences are:

underlined

- changed text is:

IN SMALL ITALIC CAPITALS

Contents

Annex A: Recommendation Q.761

Annex B: Recommendation Q.762

Annex C: Recommendation Q.763

Annex D: Recommendation Q.764

Annex E: Recommendation Q.730

ANNEX A

(to Recommendation Q.767)

Functional description of the ISDN User Part of Signalling System No. 7 for international interconnections

A.1 *General*

The ISDN User Part is the Signalling System No. 7 protocol which provides the signalling functions required to support basic bearer services and supplementary services for voice and non-voice applications in an integrated services digital network.

The ISDN User Part is also suited for application in dedicated telephone and circuit switched data networks and in analogue and mixed analogue/digital networks. In particular the ISDN User Part meets the requirements defined by CCITT for worldwide international semiautomatic and automatic telephone and circuit switched data traffic.

The ISDN User Part is furthermore suitable for national applications. Most signalling procedures, information elements and message types specified for international use are also required in typical national applications. Moreover, coding space has been reserved in order to allow national administrations and recognized private operating agencies to introduce network specific signalling messages and elements of information within the internationally standardized protocol structure.

The ISDN User Part makes use of the services provided by the Message Transfer Part (MTP) ~~and in some cases by the Signalling Connection Control Part (SCCP)~~ for the transfer of information between ISDN User Parts.

THE ISDN USER PART PROTOCOL FOR INTERNATIONAL INTERCONNECTIONS WHICH SUPPORTS THE BASIC BEARER SERVICE IS DESCRIBED IN § 3.2 AND ANNEX A TO § 3.5 AND ANNEX D, AND Q.766. A GENERAL DESCRIPTION OF ISDN USER PART SIGNALS AND MESSAGES IS PROVIDED IN § 3.3 AND ANNEX B. MESSAGE FORMATS AND MESSAGE FIELD CODINGS ARE DEFINED IN § 3.4 AND ANNEX C, WHILE THE SIGNALLING PROCEDURES ARE DESCRIBED IN § 3.5 AND ANNEX D. RECOMMENDATION Q.766 DEALS WITH ISDN USER PART PERFORMANCE OBJECTIVES.

ISDN USER PART PROTOCOL ELEMENTS WHICH SUPPORT SUPPLEMENTARY SERVICES ARE DESCRIBED IN § 3.6 AND ANNEX E.

Note – The message set, message formats and procedures specified in this version of the ISDN User Part protocol are not in complete alignment with those of the 1984 version (Red Book). The two versions of the protocol are therefore not compatible in all aspects.

A.2 *Services supported by the ISDN User Part*

The ISDN User Part protocol supports the basic bearer service, i.e. the establishment, supervision and release of 64 kbit/s circuit switched network connections between subscriber line exchange terminations.

THE ISDN USER PART SUPPORTS THE FOLLOWING SERVICES:

BEARER SERVICES:

- *64 kbit/s UNRESTRICTED*
- *SPEECH*
- *3.1 kHz AUDIO*

TELESERVICES:

- *TELEPHONY*
- *TELETEX*
- *TELEFAX GR 4*
- *MIXED MODE*
- *VIDEOTEX*
- *TELEFAX GR 2/3*

SUPPLEMENTARY SERVICES:

- *CALLING LINE IDENTIFICATION PRESENTATION (CLIP)*
- *CALLING LINE IDENTIFICATION RESTRICTION (CLIR)*
- *CONNECTED LINE IDENTIFICATION PRESENTATION (COLP)*
- *CONNECTED LINE IDENTIFICATION RESTRICTION (COLR)*
- *CLOSED USER GROUP (CUG)*
- *USER TO USER SERVICE 1 IMPLICITLY REQUESTED (UUS1)*
- *DIRECT DIALING IN (DDI)*
- *MULTIPLE SUBSCRIBER NUMBER (MSN)*
- *SUBADDRESSING (SUB)*
- *TERMINAL PORTABILITY (TP)*

A.3 *Services assumed from the Message Transfer Part (MTP)*

A.3.1 *General*

This section describes the functional interface presented by the Message Transfer Part to the ISDN User Part. In accordance with the description techniques defined by the open system interconnection (OSI) model, information is transferred to and from the MTP in the form of parameters carried by primitives.

The general syntax of a primitive is as follows:

X	Generic name	Specific name	Parameter
---	--------------	---------------	-----------

where:

- X designates the function providing the service (the MTP, in this case),
- the generic name describes an action by X,
- the specific name indicates the purpose of the primitive, i.e. whether it conveys a request for service, an indication that service related information has been received, a response to a service request or a confirmation that the requested service has been performed, and
- the parameters contain the elements of supporting information transferred by the primitive.

A.3.2 *Description of primitives*

The following paragraphs describe the primitives used across the ISDN User Part Message Transfer Part functional interface. The primitives together with the parameters carried by each primitive are also shown in Table A-1/Q.767.

A.3.2.1 *Transfer*

The MTP-TRANSFER service primitives are used either by the ISDN User Part to access the signalling message handling function of the Message Transfer Part or by the latter to deliver signalling message information to the ISDN User Part.

A.3.2.2 *Pause*

The MTP-PAUSE primitive is sent by the Message Transfer Part to indicate its inability to transfer messages to the destination specified as a parameter.

A.3.2.3 *Resume*

The MTP-RESUME primitive is sent by the Message Transfer Part to indicate its ability to resume unrestricted transfer of messages to the destination specified as a parameter.

A.3.2.4 Status

The MTP STATUS primitive is sent by the Message Transfer Part to indicate that the signalling route to a specific destination is congested ~~or the ISDN user part at the destination is unavailable~~. The affected destination and the congestion indication are carried as parameters (see Table A-1/Q.767) in the primitive.

TABLE A-1/Q.767

Message Transfer Part service primitives

Primitives		Parameters
Generic name	Specific name	
MTP-TRANSFER	Request Indication	OPC DPC SLS SIO INF
MTP-PAUSE	Indication	Affected DPC
MTP-RESUME	Indication	Affected DPC
MTP-STATUS	Indication	Affected DPC Cause (see Note)

OPC Originating point code
DPC Destination point code
SLS Signalling link selection code
SIO Service information octet

Note – The cause parameter can assume one value:

- ~~--signalling network congested (level). Where level is included only if national options with congestion priorities and multiple signalling states without congestion priorities (see Recommendation Q.704) are implemented.~~
- ~~--emote user unavailable~~

A.4. End-to-end signalling

(This section is not applicable to the international interface.)

A.5 Future enhancements

Requirements for additional protocol capabilities, such as the ability to support new supplementary services, will result from time to time in the need to add to or modify existing protocol elements and thus to create a new protocol version.

In order to ensure adequate service continuity, the insertion of a new protocol version into one part of a network should be transparent to the remainder of the network. Compatible interworking between protocol versions is optimized by adhering to the following guidelines when specifying a new version:

- 1) Existing protocol elements, i.e. procedures, messages, parameters and codes, should not be changed unless a protocol error needs to be corrected or it becomes necessary to change the operation of the service that is being supported by the protocol.
- 2) The semantics of a message, a parameter or of a field within a parameter should not be changed.
- 3) Established rules for the formatting and encoding messages should not be modified.
- 4) The addition of parameters to the mandatory part of an existing message should not be allowed. If needed, a new message should be defined containing the desired set of existing and new mandatory parameters.
- 5) A parameter may be added to an existing message as long as it is allocated to the optional part of the message.
- 6) The addition of new octets to an existing mandatory fixed length parameter should be avoided. If needed, a new optional parameter should be defined containing the desired set of existing and new information fields.
- 7) The sequence of fields in an existing variable length parameter should remain unchanged. New fields may be added at the end of the existing sequence of parameter fields. If a change in the sequence of parameter fields is required, a new parameter should be defined.
- 8) The all zeros code point should be used exclusively to indicate an unallocated (spare) or insignificant value of a parameter field. This avoids an all zeros code, sent by one protocol version as a spare value, to be interpreted as a significant value in another version.

ANNEX B

(to Recommendation Q.767)

General function of messages and signals

THIS RECOMMENDATION DESCRIBES THE ELEMENTS OF SIGNALLING INFORMATION USED BY THE ISDN USER PART PROTOCOL FOR INTERNATIONAL INTERCONNECTIONS AND THEIR FUNCTION. THE ENCODING OF THESE ELEMENTS, THE FORMAT OF THE MESSAGES IN WHICH THEY ARE CONVEYED AND THEIR APPLICATION IN THE ISDN USER PART SIGNALLING PROCEDURES ARE DESCRIBED IN § 3.4 AND ANNEX C, AND § 3.5 AND ANNEX D. TABLE B-1/Q.767 GIVES THE MANDATORY OR OPTIONAL PARAMETERS IN THE ISDN USER PART MESSAGES AND TABLE B-2/Q.767 THE LIST OF ABBREVIATIONS OF THESE MESSAGES.

TABLE B-1/Q.767 (Sheet 1 of 4)

Mandatory or optional parameters in the ISDN user part messages

Message		Group	Forward set-up		Gen sup.	Backward set-up			Call supervision			Circuit supervision					Circuit grp. supervision			
Parameter field	Subfield		Type Q.763 Annex C §	IAM		SAM	COT	ACM	CON	CPG	ANM	FOT	REL	RLC	CCR RSC	BLO UBL	BLA UBA	SUS RES	CGB CGU	CGB A-C GUA
Message type		2.1	M	M	M	M	M	M	M	M	M	M	M	M	M	M	M	M	M	M
Access transport		3.2	O			O	O	O	O											
Automatic congestion level		3.3									O									
Backward call indicators	Charge indicator Called party's status indic. Called party's category ind. End to end method ind. Interworking ind. End to end information ind. ISDN user part ind. Holding indicator ISDN access indicator Echo control device ind. SCCP method ind.	3.4				M	M	O	O											
Called party number	Odd/even indicator Nature of address Internal network number ind. Numbering plan ind. Address signals	3.7	M																	

Bold characters means "default value is used".

M Mandatory

O Optional

TABLE B-1/Q.767 (Sheet 2 of 4)

Mandatory or optional parameters in the ISDN user part messages

Message		Group	Forward set-up		Gen sup.	Backward set-up			Call supervision			Circuit supervision					Circuit grp. supervision			
Parameter field	Subfield		Type Q.763 Annex C §	IAM		SAM	COT	ACM	CON	CPG	ANM	FOT	REL	RLC	CCR RSC	BLO UBL	BLA UBA	SUS RES	CGB CGU	CGB A-C GUA
Calling party number	Odd/even indicator Nature of address Number incomplete ind. Numbering plan ind. Address pres. restricted ind. Screening ind. Address signals	3.8	O																	
Calling party's category		3.9	M																	
Cause indicators	Coding standard Location Cause value	3.10				O					M									
Circuit group supervision message type ind.	Type indicator	3.11															M	M		
CUG interlock code	Network identity Binary code	3.13	O																	
Connected number	Odd/even indicator Nature of address Numbering plan ind. Address pres. restricted ind. Screening ind. Address signals	3.14					O		O											

Bold characters means "default value is used".

TABLE B-1/Q.767 (Sheet 3 of 4)

Mandatory or optional parameters in the ISDN user part messages

Message		Group	Forward set-up		Gen sup.	Backward set-up			Call supervision			Circuit supervision					Circuit grp. supervision			
Parameter field	Subfield		Type Q.763 Annex C §	IAM		SAM	COT	ACM	CON	CPG	ANM	FOT	REL	RLC	CCR RSC	BLO UBL	BLA UBA	SUS RES	CGB CGU	CGB A-C GUA
Continuity indicators	Continuity indicators	3.16			M															
Event indicators	Event indicator Event pres. restricted ind.	3.18						M												
Forward call ind.	National/international ind. End to end method ind. Interworking ind. End to end information ind. ISDN user part ind. ISDN user part preference ind. ISDN access ind. SCCP method ind.	3.20	M																	
Nature of connection ind.	Satellite ind. Continuity check ind. Echo control device ind.	3.23	M																	
Optional backward call ind.	In-band information ind. Call forwarding may occur ind.	3.24				O		O			M									
Optional forward call ind.	CUG call ind. Connected line id. reg. ind.	3.25	O																	

Bold characters means "default value is used".

TABLE B-1/Q.767 (Sheet 4 of 4)

Mandatory or optional parameters in the ISDN user part messages

Message		Group	Forward set-up		Gen sup.	Backward set-up			Call supervision			Circuit supervision					Circuit grp. supervision			
Parameter field	Subfield		Type Q.763 Annex C §	IAM		SAM	COT	ACM	CON	CPG	ANM	FOT	REL	RLC	CCR RSC	BLO UBL	BLA UBA	SUS RES	CGB CGU	CGB A-C GUA
Range and status	Range Status	3.27																M	M	M
Subsequent number	Odd/even ind. Address signals	3.32		M																
Suspend/resume ind.		3.33															M			
Transmission medium requirement		3.35	M																	
User service information	Coding standard Information transfer capabil. Transfer mode Information transfer rate Structure Configuration Establishment Symmetry User information protocols	3.36	O																	
<u>User-to-user indicators</u>	Type Service 1 Service 2 Service 3 Network discard indicator	3.37				O	O													
User-to-user information		3.38	O			O	O	O	O		O									

Underlined, bold characters means "default coding is used".
Bold characters means "default value is used".

TABLE B-2/Q.767

ISDN User Part message acronyms

English	French	Spanish	
ACM	ACO	MDC	Address complete
ANM	REP	RST	Answer
BLA	BLA	AEB	Blocking acknowledgement
BLO	BLO	BLO	Blocking
CCR	CCD	PPC	Continuity check request
CFN	ICQ	CFN	Confusion
CGB	BLG	BGC	Circuit group blocking
CGBA	BGA	ARBG	Circuit group blocking ack.
CGU	DBG	DGC	Circuit group unblocking
CGUA	DGA	ARDG	Circuit group unblocking ack.
CMC	MAE	MLC	Call modification completed
CMR	MAD	PLM	Call modification request
CMRJ	MAR	RFA	Call modification reject
CON	CON	CNX	Connect
COT	CCP	CON	Continuity
CPG	PRG	PRL	Call progress
CRG	TAX	TAS	Charge information
CQM	IGD	IGC	Circuit group query
CQR	IGR	RIG	Circuit group query response
DRS	LID	LID	Delayed release
FAA	SUAC	FAA	Facility accepted
FAR	SUDM	PFA	Facility request
FOT	IOP	INT	Forward transfer
FRJ	SURF	RFA	Facility reject
GRA	RZA	ARRG	Circuit group reset ack.
GRS	RZG	RGC	Circuit group reset
IAM	MIA	MID	Initial address
INF	INF	INF	Information
INR	IND	PIN	Information request
LPA	BOA	AEB	Loop-back acknowledgement
OLM	SUR	SBC	Overload
PAM	FAP	MDP	Pass along
REL	LIB	LIB	Release
RES	RPR	REA	Resume
RLC	LIT	LIC	Release complete
RSC	RZC	RCI	Reset circuit
SAM	MSA	MSD	Subsequent address
SUS	SUS	SUS	Suspend
UBL	DBO	DBL	Unblocking
UBA	DBA	ARD	Unblocking acknowledgement
UCIC	CINE	CICN	Unequipped circuit identifica:
USR	UAU	HUU	User-to-user information

B.1 *Signalling messages*

B.1.1 *Address complete message (ACM)*

A message sent in the backward direction indicating that all the address signals required for routing the call to the called party have been received.

B.1.2 *Answer message (ANM)*

A message sent in the backward direction indicating that the call has been answered. In semiautomatic working this message has a supervisory function. In automatic working this message is used in conjunction with charging information in order to:

- start metering the charge to the calling subscriber (see Recommendation Q.28), and
- start measurement of call duration for international accounting purposes (see Recommendation E.260).

B.1.3 *Blocking message (BLO)*

A message sent only for maintenance purposes to the exchange at the other end of a circuit, to cause an engaged condition of that circuit for subsequent calls outgoing from that exchange. When a circuit is used in the bothway mode of operation an exchange receiving the blocking message must be capable of accepting incoming calls on the concerned circuit unless it has also sent a blocking message. Under certain conditions, a blocking message is also a proper response to a reset circuit message.

B.1.4 *Blocking acknowledgement message (BLA)*

A message sent in response to a blocking message indicating that the circuit has been blocked.

B.1.5 *Call modification completed message (CMC)*

(This section is not applicable to the international interface.)

B.1.6 *Call modification reject message (CMRJ)*

(This section is not applicable to the international interface.)

B.1.7 *Call modification request message (CMR)*

(This section is not applicable to the international interface.)

B.1.8 *Call progress message (CPG)*

A message sent in the backward direction indicating that an event has occurred during call setup which should be relayed to the calling party.

B.1.9 *Charge information message (CRG) (national use)*

(This section is not applicable to the international interface.)

B.1.10 *Circuit group blocking message (CGB)*

A message sent to the exchange at the other end of an identified group of circuits to cause an engaged condition of this group of circuits for subsequent calls outgoing from that exchange. An exchange receiving a circuit group blocking message must be able to accept incoming calls on the group of blocked circuits unless it has also sent a blocking message. Under certain conditions, a circuit group blocking message is also a proper response to a reset circuit message.

B.1.11 *Circuit group blocking acknowledgement message (CGBA)*

A message sent in response to a circuit group blocking message to indicate that the requested group of circuits has been blocked.

B.1.12 *Circuit group reset message (GRS)*

A message sent to release an identified group of circuits when, due to memory mutilation or other causes, it is unknown whether for example, a release or release complete message is appropriate for each of the circuits in the group. If at the receiving end a circuit is remotely blocked, reception of this message should cause that condition to be removed.

B.1.13 *Circuit group reset acknowledgement message (GRA)*

A message sent in response to a circuit group reset message and indicating that the requested group of circuits has been reset. The message also indicates the maintenance blocking state of each circuit.

B.1.14 *Circuit group unblocking message (CGU)*

A message sent to the exchange at the other end of an identified group of circuits to cause cancellation in that group of circuits of an engaged condition invoked earlier by a blocking or circuit group blocking message.

B.1.15 *Circuit group unblocking acknowledgement message (CGUA)*

A message sent in response to a circuit group unblocking message to indicate that the requested group of circuits has been unblocked.

B.1.16 *Circuit group query message (CQM)*

(This section is not applicable to the international interface.)

B.1.17 *Circuit group query response message (CQR)*

(This section is not applicable to the international interface.)

B.1.18 *Confusion message (CFN)*

(This section is not applicable to the international interface.)

B.1.19 *Connect message (CON)*

A message sent in the backward direction indicating that all the address signals required for routing the call to the called party have been received and that the call has been answered.

B.1.20 *Continuity message (COT)*

A message sent in the forward direction indicating whether or not there is continuity on the preceding circuit(s) as well as of the selected circuit to the following exchange, including verification of the communication path across the exchange with the specified degree of reliability.

B.1.21 *Continuity check request message (CCR)*

A message sent by an exchange for a circuit on which a continuity check is to be performed, to the exchange at the other end of the circuit, requesting continuity checking equipment to be attached.

B.1.22 *Delayed release message (DRS) (national use)*

(This section is not applicable to the international interface.)

B.1.23 *Facility accepted message (FAA)*

(This section is not applicable to the international interface.)

B.1.24 *Facility reject message (FRJ)*

(This section is not applicable to the international interface.)

B.1.25 *Facility request message (FAR)*

(This section is not applicable to the international interface.)

B.1.26 *Forward transfer message (FOT)*

A message sent in the forward direction on semiautomatic calls when the outgoing international exchange operator wants the help of an operator at the incoming international exchange. The message will normally serve to bring an assistance operator (see Recommendation Q.101) into the circuit if the call is automatically set up at the exchange. When the call is completed via an operator (incoming or delay operator) at the incoming international exchange, the message should preferably cause this operator to be recalled.

B.1.27 *Information message (INF)*

(This section is not applicable to the international interface.)

B.1.28 *Information request message (INR)*

(This section is not applicable to the international interface.)

B.1.29 *Initial address message (IAM)*

A message sent in the forward direction to initiate seizure of an outgoing circuit and to transmit number and other information relating to the routing and handling of a call.

B.1.30 *Loop back acknowledgement message (LPA) (national use)*

(This section is not applicable to the international interface.)

B.1.31 *Overload message (OLM) (national use)*

(This section is not applicable to the international interface.)

B.1.32 *Pass along message (PAM)*

(This section is not applicable to the international interface.)

B.1.33 *Release message (REL)*

A message sent in either direction to indicate that the circuit is being released due to the reason (cause) supplied and is ready to be put into the idle state on receipt of the release complete message. ~~In case the call was forwarded or is to be rerouted, the appropriate indicator is carried in the message together with the redirection address and the redirecting address.~~

B.1.34 *Release complete message (RLC)*

A message sent in either direction in response to the receipt of a released message, or if appropriate to a reset circuit message, when the circuit concerned has been brought into the idle condition.

B.1.35 *Reset circuit message (RSC)*

A message sent to release a circuit when, due to memory mutilation or other causes, it is unknown whether for example, a release or a release complete message is appropriate. If, at the receiving end, the circuit is remotely blocked, reception of this message should cause that condition to be removed.

B.1.36 *Resume message (RES)*

A message sent in either direction indicating that the calling or called party, after having been suspended, is reconnected.

B.1.37 *Subsequent address message (SAM)*

A message that may be sent in the forward direction following an initial address message, to convey additional called party number information.

B.1.38 *Suspend message (SUS)*

A message sent in either direction indicating that the calling or called party has been temporarily disconnected.

B.1.39 *Unblocking message (UBL)*

A message sent to the exchange at the other end of a circuit to cancel, in that exchange, the engaged condition of the circuit caused by a previously sent blocking or circuit group blocking message.

B.1.40 *Unblocking acknowledgement message (UBA)*

A message sent in response to an unblocking message indicating that the circuit has been unblocked.

B.1.41 *Unequipped circuit identification code message (UCIC) (national use)*

(This section is not applicable to the international interface.)

B.1.42 *User-to-user information message (USR)*

(This section is not applicable to the international interface.)

B.2 *Signalling information*

B.2.1 *Access transport*

Information generated on the access side of a call and transferred transparently in either direction between originating and terminating local exchanges. The information is significant to both users and local exchanges.

B.2.2 *Address presentation restricted indicator*

Information sent in either direction to indicate that the address information is not to be presented to a public network user, but can be passed to another public network. *IT IS ALSO USED TO INDICATE THE NON AVAILABILITY OF THE ADDRESS.*

B.2.3 *Address signal*

An element of information in a network number. The address signal may indicate digit values 0 to 9, code 11 or code 12. One address signal value (ST) is reserved to indicate the end of the called party number.

B.2.4 *Automatic congestion level*

Information sent to the exchange at the other end of a circuit to indicate that a particular level of congestion exists at the sending exchange.

B.2.5 *Call forwarding may occur indicator*

Information sent in the backward direction indicating that call forwarding may occur, depending on the response received (or lack thereof) from the called party.

Only the default value is allowed to be sent on the international interface.

B.2.6 *Call identity*

(This section is not applicable to the international interface.)

B.2.7 *Call reference*

(This section is not applicable to the international interface.)

B.2.8 *Called party number*

Information to identify the called party.

B.2.9 *Called party's category indicator*

Information sent in the backward direction indicating the category of the called party, e.g. ordinary subscriber or payphone.

B.2.10 *Called party's status indicator*

Information sent in the backward direction indicating the status of the called party, e.g. subscriber free.

B.2.11 *Calling party number*

Information sent in the forward direction to identify the calling party.

B.2.12 *Calling party address request indicator*

(This section is not applicable to the international interface.)

B.2.13 *Calling party address response indicator*

(This section is not applicable to the international interface.)

B.2.14 *Calling party number incomplete indicator*

Information sent in the forward direction indicating that the complete calling party number is not included.

Only the default value is allowed to be sent on the international interface.

B.2.15 *Calling party's category*

Information sent in the forward direction indicating the category of the calling party and, in case of semiautomatic calls, the service language to be spoken by the incoming, delay and assistance operators.

B.2.16 *Calling party's category request indicator*

(This section is not applicable to the international interface.)

B.2.17 *Calling party's category response indicator*

(This section is not applicable to the international interface.)

B.2.18 *Cause value*

Information sent in either direction indicating the reason for sending the message (e.g. release message).

Definitions for each cause value are listed below.

a) *Normal class*

Cause 1 – Unallocated (unassigned) number

This cause indicates that the called party cannot be reached because, although the called party number is in a valid format, it is not currently allocated (assigned).

Cause 2 – ~~No route to specified transit network~~

(This cause is not applicable to the international interface.)

Cause 3 – No route to destination

This cause indicates that the called party cannot be reached because the network through which the call has been routed does not serve the destination desired. This cause is supported on a network-dependent basis.

Cause 4 – Send special information tone

This cause indicates that the called party cannot be reached for reasons that are of long-term nature and that the special information tone should be returned to the calling party.

Cause 5 – ~~Misdialled trunk prefix~~

(This cause is not applicable to the international interface.)

Cause 16 – Normal call clearing

This cause indicates that the call is being cleared because one of the users involved in the call has requested that the call be cleared. Under normal situation, the source of this cause is not the network.

Cause 17 – User busy

This cause is used when the called party has indicated the inability to accept another call. It is noted that the user equipment is compatible with the call.

Cause 18 – No user responding

This cause is used when a called party does not respond to a call establishment message with either an alerting or connect indication within the prescribed period of time.

Cause 19 – No answer from user (user alerted)

This cause is used when the called party has been alerted but does not respond with a connect indication within the prescribed period of time.

Cause 21 – Call rejected

This cause indicates that the equipment sending this cause does not wish to accept this call, although it could have accepted the call because the equipment sending this cause is neither busy nor incompatible.

Cause 22 – Number changed

This cause is returned to a calling party when the called number indicated by the calling party is no longer assigned. ~~The new called number may optionally be included in the diagnostic field. If a network does not support this capability, cause number 1 shall be used.~~

Cause 27 – Destination out of order

This cause indicates that the destination requested by the user cannot be reached because the interface to the destination is not functioning correctly. The term “not functioning correctly” indicates that a signalling message was unable to be delivered to the remote party; e.g. a physical layer or data link layer failure at the remote party, user equipment off-line, etc.

Cause 28 – Address incomplete

This cause indicates that the called party cannot be reached because the called party number is not in a valid format or is not complete. This condition may be determined in the incoming international exchange (or in the national destination network):

- immediately after reception of an ST signal, or
- on timeout after the last received digit.

Cause 29 – Facility rejected

This cause is returned when a supplementary service requested by the user cannot be provided by the network.

Cause 31 – Normal, unspecified

This cause is used to report a normal event only when no other cause in the normal class applies.

b) *Resource unavailable class*

Cause 34 – No circuit available

This cause indicates that there is no appropriate circuit presently available to handle the call.

Cause 38 – Network out of order

This cause indicates that the network is not functioning correctly and that the condition is likely to last a relatively long period of time, e.g. immediately re-attempting the call is not likely to be successful.

Cause 41 – Temporary failure

This cause indicates that the network is not functioning correctly and that the condition is not likely to last a long period of time, e.g. the user may wish to try another call attempt almost immediately.

Cause 42 – Switching equipment congestion

This cause indicates that the switching equipment generating this cause is experiencing a period of high traffic.

Cause 44 – Requested circuit / channel not available

This cause is returned when the circuit or channel indicated by the requesting entity cannot be provided by the other side of the interface.

Cause 47 – Resource unavailable, unspecified

This cause is used to report a resource unavailable event only when no other cause in the resource unavailable class applies.

c) *Service or option not available class*

Cause 50 – ~~Requested facility not subscribed~~

(This cause is not applicable to the international interface.)

Cause 55 – Incoming calls barred within CUG

This cause indicates that although the called party is a member of the CUG for the incoming CUG call, incoming calls are not allowed within this CUG.

Cause 57 – Bearer capability not authorized

This cause indicates that the user has requested a bearer capability which is implemented by the equipment which generated this cause but the user is not authorized to use.

Cause 58 – Bearer capability not presently available

This cause indicates that the user has requested a bearer capability which is implemented by the equipment which generated this cause but which is not available at this time.

Cause 63 – Service or option not available, unspecified

This cause is used to report a service or option not available event only when no other cause in the service or option not available class applies.

d) *Service or option not implemented class*

Cause 65 – Bearer capability not implemented

This cause indicates that the equipment sending this cause does not support the bearer capability requested.

Cause 69 – ~~Request facility not implemented~~

(This cause is not applicable to the international interface.)

Cause 70 – ~~Only restricted digital information bearer capability is available~~

(This cause is not applicable to the international interface.)

Cause 79 – Service or option not implemented, unspecified

This cause is used to report a service or option not implemented event only when no other cause in the service or option not implemented class applies.

e) *Invalid message (e.g. parameter out of range) class*

Cause 87 – ~~Called user not member of CUG~~

This cause indicates that the called user for the incoming CUG call is not a member of the specified CUG or that the calling user is an ordinary subscriber calling a CUG subscriber, respectively.

Cause 88 – Incompatible destination

This cause indicates that the equipment sending this cause has received a request to establish a call which has low layer compatibility or high layer compatibility or other compatibility attributes (e.g. data rate) which cannot be accommodated.

Cause 91 – ~~Invalid transit network selection~~

(This cause is not applicable to the international interface.)

Cause 95 – Invalid message, unspecified

This cause is used to report an invalid message event only when no other cause in the invalid message class applies.

f) *Protocol error (e.g. unknown message) class*

Cause 97 – ~~Message type nonexistent or not implemented~~

(This cause is not applicable to the international interface.)

Cause 99 – ~~Parameter not existent or not implemented discarded~~

(This cause is not applicable to the international interface.)

Cause 102 – Recovery on timer expiry

This cause indicates that the procedure has been initiated by the expiry of a timer in association with error handling procedure.

Cause 103 – ~~Parameter nonexistent or not implemented passed on~~

(This cause is not applicable to the international interface.)

Cause 111 – Protocol error, unspecified

This cause is used to report a protocol error event only when no other cause in the protocol error class applies.

g) *Interworking class*

Cause 127 – Interworking, unspecified

This cause indicates that there has been interworking with a network which does not provide causes for actions it takes; thus, the precise cause for a message which is being sent cannot be ascertained.

B.2.19 *Charge indicator*

Information sent in the backward direction indicating whether or not the call is chargeable.

B.2.20 *Charge information request indicator (national use)*

(This section is not applicable to the international interface.)

B.2.21 *Charge information response indicator (national use)*

(This section is not applicable to the international interface.)

B.2.22 *Circuit group supervision message type indicator*

Information sent in a circuit group blocking or unblocking message, indicating whether blocking (unblocking) is maintenance oriented or hardware oriented.

B.2.23 *Circuit identification code*

Information identifying the physical path between a pair of exchanges.

B.2.24 *Circuit state indicator*

(This section is not applicable to the international interface.)

B.2.25 *Closed user group call indicator*

Information indicating whether or not the concerned call can be set up as a closed user group call and, if a closed user group call, whether or not outgoing access is allowed.

B.2.26 *Closed user group interlock code*

Information uniquely identifying a closed user group within a network.

B.2.27 *Coding standard*

Information sent in association with a parameter (e.g. cause indicators) identifying the standard in which the parameter format is described.

Only the default value is allowed to be sent on the international interface.

B.2.28 *Connected number*

Information sent in the backward direction to identify the connected party.

B.2.29 *Connection request*

(This section is not applicable to the international interface.)

B.2.30 *Continuity check indicator*

Information sent in the forward direction indicating whether or not a continuity check will be performed on the circuit(s) concerned or is being (has been) performed on a previous circuit in the connection.

B.2.31 *Continuity indicator*

Information sent in the forward direction indicating whether or not the continuity check on the outgoing circuit was successful. A continuity check successful indication also implies continuity of the preceding circuits and successful verification of the path across the exchange with the specified degree of reliability.

B.2.32 *Credit*

(This section is not applicable to the international interface.)

B.2.33 *Diagnostic*

(This section is not applicable to the international interface.)

B.2.34 *Echo control device indicator*

Information indicating whether or not a half echo control device is included in the connection.

B.2.35 *End-to-end information indicator*

Information sent in either direction indicating whether or not the sending exchange has further call information available for end-to-end transmission. In the forward direction, an indication that end-to-end information is available will imply that the destination exchange may obtain the information before alerting the called party.

Only the default value is allowed to be sent on the international interface.

B.2.36 *End-to-end method indicator*

Information sent in either direction indicating the available methods, if any, for end-to-end transfer of information.

Only the default value is allowed to be sent on the international interface.

B.2.37 *Event indicator*

Information sent in the backward direction indicating the type of event which caused a call progress message to be sent to the originating local exchange.

B.2.38 *Event presentation restricted indicator*

Information sent in the backward direction indicating that the event should not be presented to the calling party.

Only the default value is allowed to be sent on the international interface.

B.2.39 *Extension indicator*

Information indicating whether or not the associated octet has been extended.

B.2.40 *Facility indicator*

(This section is not applicable to the international interface.)

B.2.41 *Holding indicator (national use)*

(This section is not applicable to the international interface.)

B.2.42 *Hold provided indicator (national use)*

(This section is not applicable to the international interface.)

B.2.43 *In band information indicator*

Information sent in the backward direction indicating that inband information or an appropriate pattern is now available.

B.2.44 *Internal network number indicator*

Information sent to the destination exchange indicating whether or not the call is allowed should the called party number prove to be an internal network number (e.g. mobile access point).

B.2.45 *Interworking indicator*

Information sent in either direction indicating whether or not Signalling System No. 7 is used in all parts of the network connection.

B.2.46 *ISDN access indicator*

Information sent in either direction indicating whether or not the access signalling protocol is ISDN.

B.2.47 *ISDN User Part indicator*

Information sent in either direction to indicate that the ISDN User Part is used in all preceding parts of the network connection. When sent in the backward direction, the preceding parts are those towards the called party.

B.2.48 *ISDN user preference indicator*

Information sent in the forward direction indicating whether or not the ISDN User Part is required or preferred in all parts of the network connection.

B.2.49 *Local reference*

(This section is not applicable to the international interface.)

B.2.50 *Location*

Information sent in either direction indicating where an event (e.g. release) was generated.

B.2.51 *Malicious call identification request indicator (national use)*

(This section is not applicable to the international interface.)

B.2.52 *Modification indicator*

(This section is not applicable to the international interface.)

B.2.53 *National/international call indicator*

Information sent in the forward direction indicating in the destination national network whether the call has to be treated as an international call or as a national call.

B.2.54 *Nature of address indicator*

Information sent in association with an address indicating the nature of that address, e.g. ISDN international number, ISDN national significant number, or ISDN subscriber number.

B.2.55 *Numbering plan indicator*

Information sent in association with a number indicating the numbering plan used for that number (e.g. ISDN number, telex number).

Only the default value is allowed to be sent on the international interface.

B.2.56 *Odd/even indicator*

Information sent in association with an address, indicating whether the number of address signals contained in the address is even or odd.

B.2.57 *Original called number*

(This section is not applicable to the international interface.)

B.2.58 *Original redirection reason*

(This section is not applicable to the international interface.)

B.2.59 *Point code*

(This section is not applicable to the international interface.)

B.2.60 *Protocol class*

(This section is not applicable to the international interface.)

B.2.61 *Protocol control indicator*

Information consisting of the end-to-end method indicator, the interworking indicator, the end-to-end information indicator, the SCCP method indicator and the ISDN User Part indicator. The protocol control indicator is contained in both the forward and backward call indicators parameter field and describes the signalling capabilities within the network connection.

Whether a bit or a bit combination contained in the PCI has history or control characteristic, is specified in the definitions of the individual bits or bit combinations.

B.2.62 *Range*

Information sent in a circuit group supervision message (e.g. circuit group blocking) to indicate the range of circuits affected by the action in the message.

B.2.63 *Recommendation indicator*

(This section is not applicable to the international interface.)

B.2.64 *Redirecting indicator*

(This section is not applicable to the international interface.)

B.2.65 *Redirecting number*

(This section is not applicable to the international interface.)

B.2.66 *Redirecting reason*

(This section is not applicable to the international interface.)

B.2.67 *Redirection counter*

(This section is not applicable to the international interface.)

B.2.68 *Redirection number*

(This section is not applicable to the international interface.)

B.2.69 *Routing label*

Information provided to the message transfer part for the purpose of message routing (see Recommendation Q.704, § 2.2).

B.2.70 *Satellite indicator*

Information sent in the forward direction indicating the number of satellite circuits in the connection.

B.2.71 *SCCP method indicator*

Information sent in either direction indicating the available SCCP methods, if any, for end-to-end transfer of information.

Only the default value is allowed to be sent on the international interface.

B.2.72 *Screening indicator*

Information sent in either direction to indicate whether the address was provided by the user or network.

B.2.73 *Signalling point code (national use)*

(This section is not applicable to the international interface.)

B.2.74 *Solicited information indicator*

(This section is not applicable to the international interface.)

B.2.75 *Status*

Information sent in a circuit group supervision message (e.g. circuit group blocking) to indicate the specific circuits, within the range of circuits stated in the message, that are affected by the action specified in the message.

B.2.76 *Suspend/resume indicator*

Information sent in the suspend and resume messages to indicate whether suspend/resume was initiated by an ISDN subscriber or by the network.

B.2.77 *Temporary trunk blocking after release (national use)*

(This section is not applicable to the international interface.)

B.2.78 *Transit network selection (national use)*

(This section is not applicable to the international interface.)

B.2.79 *Transmission medium requirement*

Information sent in the forward direction indicating the type of transmission medium required for the connection (e.g. 64 kbit/s unrestricted, speech).

B.2.80 *User service information*

Information sent in the forward direction indicating the bearer capability requested by the calling party.

B.2.81 *User-to-user indicators*

Information sent in association with a request (or response to a request) for user-to-user signalling supplementary service(s).

Only the default value is allowed to be sent on the international interface.

B.2.82 *User-to-user information*

Information generated by a user and transferred transparently through the interexchange network between the originating and terminating local exchanges.

B.2.AA *Connected line identity request indicator*

Information sent in the forward direction indicating a request for the connected party number to be returned.

B.2.BB *Network discard indicator*

This indicator indicates that user to user information included in the call control message has been discarded by the network.

(to Recommendation Q.767)

Formats and codes

C.1 *General*

ISDN user part messages are carried on the signalling link by means of signal units the format of which is described in Recommendation Q.703, § 2.2.

The format of and the codes used in the service information octet are described in Recommendation Q.704, § 14.2. The service indicator for the ISDN user part is coded 0101.

The signalling information field of each message signal unit containing an ISDN User Part message consists of an integral number of octets and encompasses the following parts (see Figure C-1/Q.767):

- a) routing label;
- b) circuit identification code;
- c) message type code;
- d) the mandatory fixed part;
- e) the mandatory variable part;
- f) the optional part, which may contain fixed length and variable length parameter fields.

Note — ~~The service information octet, the routing label and circuit identification code are not included in the SCCP user data parameter transferred between the ISDN user part and signalling connection control part.~~

A description of the various message parts is given in the following sections.

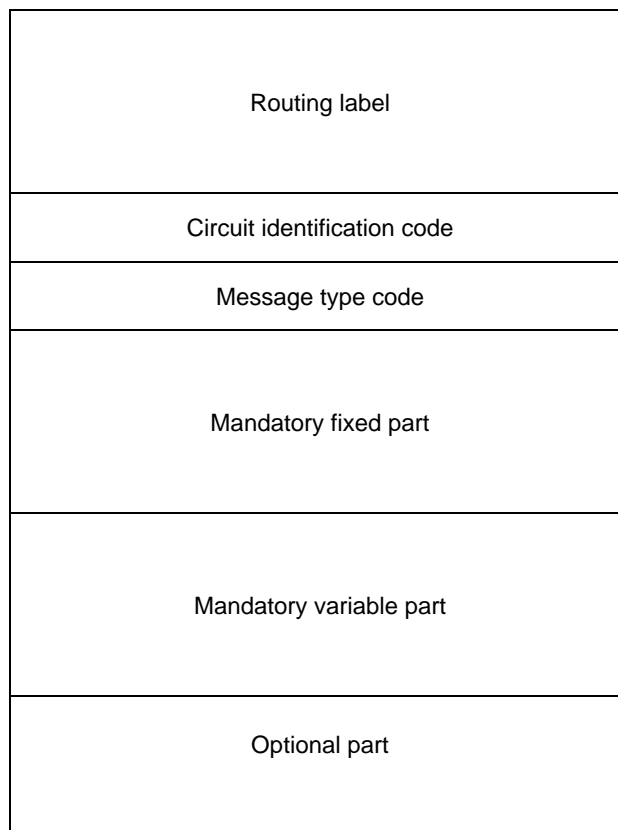

FIGURE C-1/Q.767
ISDN user part message parts

C.1.1 *Routing label*

The format and codes used for the routing label are described in Recommendation Q.704, § 2.2. For each individual circuit connection, the same routing label must be used for each message that is transmitted for that connection.

C.1.2 *Circuit identification code*

The format of the circuit identification code (CIC) is shown in Figure C-2/Q.767.

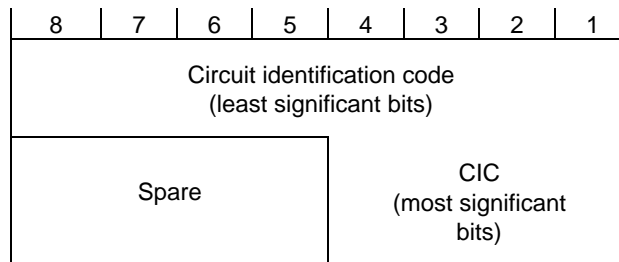

FIGURE C-2/Q.767
Circuit identification field

The allocation of circuit identification codes to individual circuits is determined by bilateral agreement and/or in accordance with applicable predetermined rules.

For international applications, the four spare bits of the circuit identification field are reserved for CIC extension, provided that bilateral agreement is obtained before any increase in size is performed. For national applications, the four spare bits can be used as required.

Allocations for certain applications are defined below :

a) *2048 kbit/s digital path*

For circuits which are derived from a 2048 kbit/s digital path (Recommendations G.732 and G.734) the circuit identification code contains in the 5 least significant bits a binary representation of the actual number of the time slot which is assigned to the communication path.

The remaining bits in the circuit identification code are used, where necessary, to identify these circuits uniquely among all other circuits of other systems interconnecting an originating and destination point.

b) *8448 kbit/s digital path*

For circuits which are derived from a 8448 kbit/s digital path (Recommendations G.744 and G.747) the circuit identification code contains in the 7 least significant bits an identification of the circuit which is assigned to the communication path. The codes in Table C1/Q.767 are used.

The remaining bits in the circuit identification code are used, where necessary, to identify these circuits uniquely among all other circuits of other systems interconnecting an originating and destination point.

TABLE C-1/Q.767

0 0 0 0 0 0 0	Circuit 1
0 0 0 0 0 0 1	Circuit 2
0 0 1 1 1 1 1	Circuit 32
0 1 0 0 0 0 0	Circuit 33
1 1 1 1 1 1 0	Circuit 127
1 1 1 1 1 1 1	Circuit 128

c) *Frequency division multiplex (FDM) systems in networks using the 2048 kbit/s pulse code modulation standard*

For frequency division multiplex systems existing in networks that also use the 2048 kbit/s pulse code modulation standard, the circuit identification code contains in the 6 least significant bits the identification of a circuit within a group of 60 circuits carried by 5 basic frequency division multiplex groups which may or may not be part of the same supergroup. The codes in Table C-2/Q.767 are used.

The remaining bits in the circuit identification code are used, where necessary, to identify these circuits uniquely among all other circuits of other systems interconnecting an originating and destination point.

TABLE C-2/Q.767

0 0 0 0 0 0	Unallocated	
0 0 0 0 0 1 0 0 1 1 0 0	Circuit 1 Circuit 12	1st basic (FDM) group
0 0 1 1 0 1 0 0 1 1 1 0 0 0 1 1 1 1 0 1 0 0 0 0 0 1 0 0 0 1 0 1 1 0 0 1	Circuit 1 Circuit 2 Circuit 3 Unallocated Circuit 4 Circuit 12	2nd basic (FDM) group
0 1 1 0 1 0 0 1 1 1 1 1 1 0 0 0 0 0 1 0 0 0 0 1 1 0 0 1 1 0	Circuit 1 Circuit 6 Unallocated Circuit 7 Circuit 12	3rd basic (FDM) group
1 0 0 1 1 1 1 0 1 1 1 1 1 1 0 0 0 0 1 1 0 0 0 1 1 1 0 0 1 0 1 1 0 0 1 1	Circuit 1 Circuit 9 Unallocated Circuit 10 Circuit 11 Circuit 12	4th basic (FDM) group
1 1 0 1 0 0 1 1 1 1 1 1	Circuit 1 Circuit 12	5th basic (FDM) group

The message type code consists of a one octet field and is mandatory for all messages. The message type code uniquely defines the function and format of each ISDN user part message. The allocation with reference to the appropriate descriptive section of this Recommendation is summarized in Table C-3/Q.767.

C.1.3 *Message type code*

C.1.4 *Formatting principles*

Each message consists of a number of PARAMETERS listed and described in § C.2. Each parameter has a NAME which is coded as a single octet (see Table C-4/Q.767). The length of a parameter may be fixed or variable, and a LENGTH INDICATOR of one octet for each parameter may be included as described below.

The detailed format is uniquely defined for each message type as described in § C.3.

Between parameters there should be no unused (i.e. dummy) octets.

A general format diagram is shown in Figure C-3/Q.767.

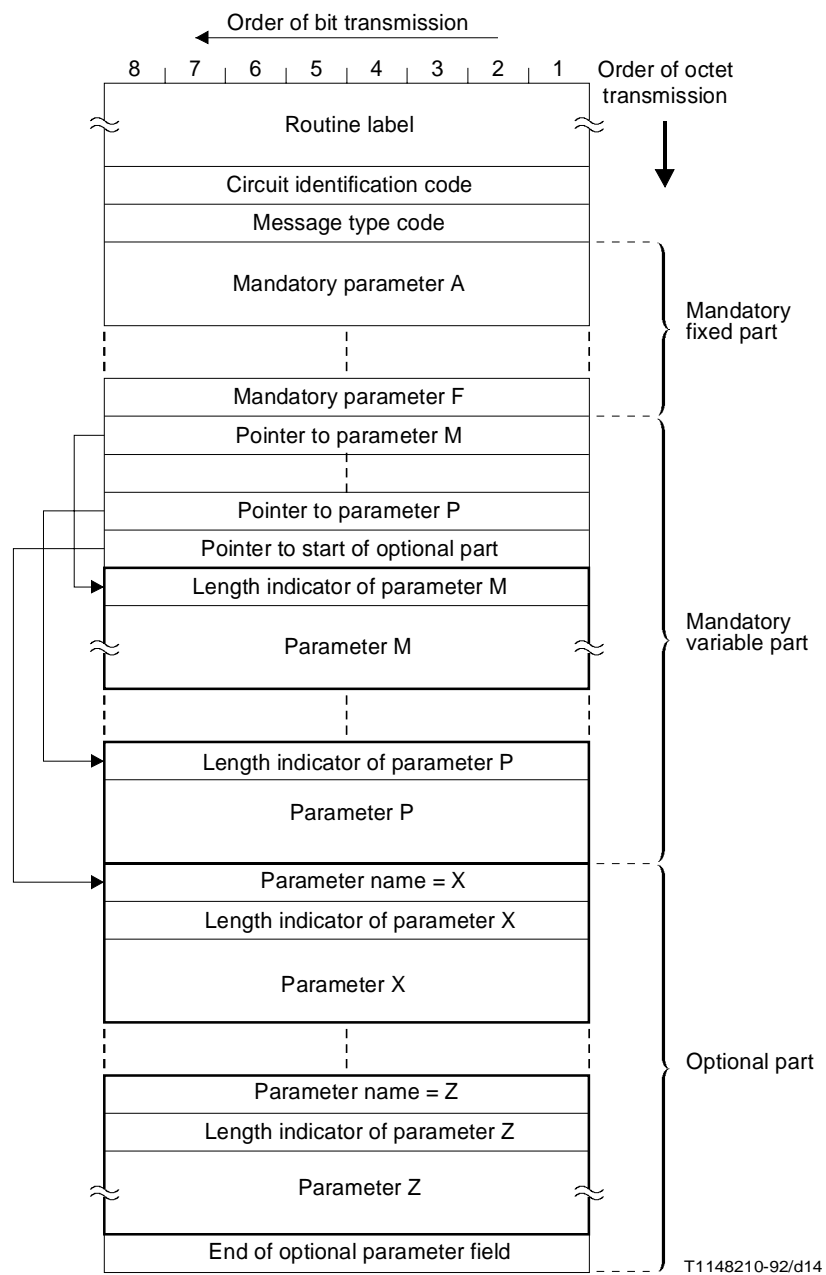

FIGURE C-3/Q.767

C.1.5 *Mandatory fixed part*

Those parameters that are mandatory and of fixed length for a particular message type will be contained in the mandatory fixed part. The position, length and order of the parameters is uniquely defined by the message type, thus the names of the parameters and the length indicators are not included in the message.

C.1.6 *Mandatory variable part*

Mandatory parameters of variable length will be included in the mandatory variable part. Pointers are used to indicate the beginning of each parameter. Each pointer is encoded as a single octet. The name of each parameter and the order in which the pointers are sent is implicit in the message type. Parameter names are, therefore, not included in the message. The details of how pointers are encoded is found in § C.2.3. The number of parameters, and thus the number of pointers is uniquely defined by the message type.

A pointer is also included to indicate the beginning of the optional part. If the message type indicates that no optional part is allowed, then this pointer will not be present. If the message type indicates that an optional part is possible (reflected by the presence of an “end of optional parameter” octet in Tables C-5 through C-28 / Q.767), but there is no optional part included in this particular message than a pointer field containing all zeros will be used. It is recommended that all future message types with a mandatory variable part indicate that an optional part is allowed.

All the pointers are sent consecutively at the beginning of the mandatory variable part. Each parameter contains the parameter length indicator followed by the contents of the parameters.

If there are no mandatory variable parameters, but optional parameters are possible, the start of optional parameters pointer (coded all “0”s if no optional parameter is present and coded “0000001” if any optional parameter is present) will be included.

C.1.7 *Optional part*

The optional part consists of parameters that may or may not occur in any particular message type. Both fixed length and variable length parameters may be included. Optional parameters may be transmitted in any order. Each optional parameter will include the parameter name (one octet) and the length indicator (one octet) followed by the parameter contents.

C.1.8 *End of optional parameters octet*

If optional parameters are present and after all optional parameters have been sent, an “end of optional parameters” octet containing all zeros will be transmitted.

If no optional parameter is present an “end of optional parameter” octet is not transmitted.

C.1.9 *Order of transmission*

Since all the fields consist of an integral number of octets, the formats are represented as a stack of octets. The first octet transmitted is the one shown at the top of the stack and the last is the one at the bottom (see Figure C-3/Q.767).

Unless otherwise indicated, within each octet and subfield the bits are transmitted with the least significant bit first.

C.1.10 *Coding of spare bits*

Spare bits are coded 0 unless indicated otherwise.

C.1.11 *National message types and parameters*

(This section is not applicable to the international interface.)

C.2. *Parameter formats and codes*

C.2.1 *Message type codes*

The encoding of the message type is shown in Table C-3/Q.767.

C.2.2 *Coding of the length indicator*

The length indicator field is binary coded to indicate the number of octets in the parameter content field. The length indicated does not include the parameter name octet or the length indicator octet.

C.2.3 *Coding of the pointers*

The pointer value (in binary) gives the number of octets between the pointer itself (included) and the first octet (not included) of the parameter associated with that pointer.

The pointer value all zeros is used to indicate that, in the case of optional parameters, no optional parameter is present.

C.3 *ISDN user part parameters*

C.3.1 *Parameter names*

The parameter name codes are given in Table C-4/Q.767 together with references to the subsections in which they are described.

TABLE C-3/Q.767

Message type	Reference (table)	Code
Address complete	C-5/Q.767	00000110
Answer	C-6/Q.767	00001001
Blocking	C-23/Q.767	00010011
Blocking acknowledgement	C-23/Q.767	00010101
Call modification completed	C-24/Q.767	00011101
Call modification request	C-24/Q.767	00011100
Call modification reject	C-24/Q.767	00011110
Call progress	C-7/Q.767	00101100
Circuit group blocking	C-25/Q.767	00011000
Circuit group blocking ack.	C-25/Q.767	00011010
Circuit group query	C-26/Q.767	00101010
Circuit group query response	C-8/Q.767	00101011
Circuit group reset	C-26/Q.767	00010111
Circuit group reset ack.	C-9/Q.767	00101001
Circuit group unblocking	C-25/Q.767	00011001
Circuit group unblocking ack.	C-25/Q.767	00011011
Charge information	see/Q.767	00110001
Confusion	C-10/Q.767	00101111
Connect	C-11/Q.767	00000111
Continuity	C-12/Q.767	00000101
Continuity check request	C-23/Q.767	00010001
Delayed release	C-21/Q.767	00100111
Facility accepted	C-27/Q.767	00100000
Facility reject	C-13/Q.767	00100001
Facility request	C-27/Q.767	00011111
Forward transfer	C-21/Q.767	00001000
Information	C-14/Q.767	00000100
Information request	C-15/Q.767	00000011
Initial address	C-16/Q.767	00000001
Loop back acknowledgement	C-23/Q.767	00100100
Overload	C-23/Q.767	00110000
Pass along	C-28/Q.767	00101000
Release	C-17/Q.767	00001100
Release complete	C-18/Q.767	00010000
Reset circuit	C-23/Q.767	00010010
Resume	C-22/Q.767	00001110
Subsequent address	C-19/Q.767	00000010
Suspend	C-22/Q.767	00001101
Unblocking	C-23/Q.767	00010100
Unblocking acknowledgement	C-23/Q.767	00010110
Unequipped CIC	C-23/Q.767	00101110
User-to-user information	C-20/Q.767	00101101
Reserved (used in 1984 version)		00001010 00001011 00001111 00100010 00100011 00100101 00100110

Note — the format of this message is a national matter.

TABLE C-4/Q.767

Parameter name	Reference §	Code
Access transport	C.3.2	00000011
Automatic congestion level	C.3.3	00100111
Backward call indicators	C.3.4	00010001
Call modification indicators	C.3.5	00010111
Call reference	C.3.6	00000001
Called party number	C.3.7	00000100
Calling party number	C.3.8	00001010
Calling party's category	C.3.9	00001001
Cause indicators	C.3.10	00010010
Circuit group supervision message type indicator	C.3.11	00010101
Circuit state indicator	C.3.12	00100110
Closed user interlock code	C.3.13	00011010
Connected number	C.3.14	00100001
Connection request	C.3.15	00001101
Continuity indicators	C.3.16	00010000
End of optional parameters	C.3.17	00000000
Event information	C.3.18	00100100
Facility indicators	C.3.19	00011000
Forward call indicators	C.3.20	00000111
Information indicators	C.3.21	00001111
Information request indicators	C.3.22	00001110
Nature of connection indicators	C.3.23	00000110
Optional backward call indicators	C.3.24	00101001
Optional forward call indicators	C.3.25	00001000
Original called number	C.3.26	00101000
Range and status	C.3.27	00010110
Redirecting number	C.3.28	00001011
Redirection information	C.3.29	00010011
Redirection number	C.3.30	00001100
Signalling point code	C.3.31	00011110
Subsequent number	C.3.32	00000101
Suspend/resume indicators	C.3.33	00100010
Transmit network selection	C.3.34	00100011
Transmission medium requirement	C.3.35	00000010
User service information	C.3.36	00011101
User-to-user indicators	C.3.37	00101010
User-to-user information	C.3.38	00100000
Reserved (used in 1984 version Red book)		00010100 00011001 00011011 00011100 00011111
Reserved for multi slot identifier		00100101

C.3.2 *Access transport*

The format of the access transport parameter field is shown in Figure C-4/Q.767.

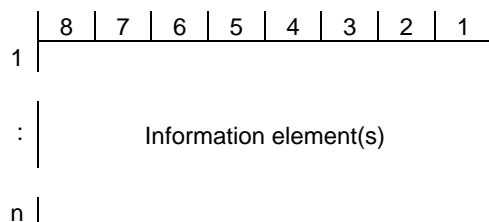

FIGURE C-4/Q.767
Access transport parameter field

The information element is coded as described in Recommendation Q.931, § 4.5. Multiple Q.931 information elements can be included within the access transport parameter. The information elements applicable to a particular usage of the access transport parameter are dependent on, and will be determined by, the relevant procedures.

The maximum length should only be limited by the message length as the content of the ATP will probably evolve in the future.

C.3.3 *Automatic congestion level*

The format of the automatic congestion level parameter field is shown in Figure C-5/Q.763.

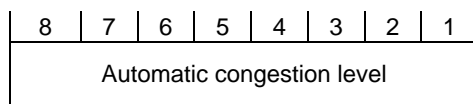

FIGURE C-5/Q.767
Automatic congestion level parameter field

The following codes are used in the automatic congestion level parameter field :

00000000 spare
 00000001 congestion level 1 exceeded
 00000010 congestion level 2 exceeded
 00000011 ,to,11111111} spare

C.3.4 *Backward call indicators*

The format of the backward call indicators parameter field is shown in Figure C-6/Q.767.

	8	7	6	5	4	3	2	1
1	H	G	F	E	D	C	B	A
2	P	O	N	M	L	K	J	I

FIGURE C-6/Q.767

Backward call indicators parameter field

The following codes are used in the backward call indicators parameter field :

bits B A: Charge indicator
 0 0 no indication
 0 1 no charge
 1 0 charge
 1 1 spare

The interpretation of these bits depends only on the originating exchange.

bits D C: Called party's status indicator
 0 0 no indication
 0 1 subscriber free
 1 0 ~~connect when free, not used~~
 1 1 spare

bits F E: Called party's category indicator
 0 0 no indication
 0 1 ordinary subscriber
 1 0 payphone
 1 1 spare

bits H G:	End-to-end method indicator (Note)
0 0	no end-to-end method available (only link-by-link method available)
0 1	pass-along method available, not used
1 0	SCCP method available, not used
1 1	pass-along and SCCP methods available, not used
bit I:	Interworking indicator (Note)
0	no interworking encountered
1	interworking encountered
bit J:	End-to-end information indicator (Note)
0	no end-to-end information available
1	end-to-end information available, not used
bit K:	ISDN User Part indicator (Note)
0	ISDN User Part not used all the way
1	ISDN User Part used all the way
bit L:	Holding indicator (national use)
0	holding not requested
1	holding requested, not used
bit M:	ISDN access indicator
0	terminating access non-ISDN
1	terminating access ISDN
bit N:	Echo control device indicator
0	incoming half echo control device not included
1	incoming half echo control device included
bits P O:	SCCP method indicator
0 0	no indication
0 1	connectionless method available, not used
1 0	connection-oriented method available, not used
1 1	connectionless and connection-oriented methods available, not used

Note — Bits G K and O P constitute the protocol control indicator.

C.3.5 *Call modification indicators*

(This section is not applicable to the international interface.)

C.3.6 *Call reference*

(This section is not applicable to the international interface.)

C.3.7 *Called party number*

The format of the called party number parameter field is shown in Figure C-9/Q.767.

	8	7	6	5	4	3	2	1
1	Odd/ even	Nature of address indicator						
2	INN ind.	Numbering plan			Spare			
3	2nd address signal				1st address signal			
:								
n	Filler (if necessary)				n-th address signal			

FIGURE C-9/Q.767

Called party number parameter field

The following codes are used in the subfields of the called party number parameter field:

a) *Odd/even indicator*

- 0 even number of address signals
- 1 odd number of address signals

b) *Nature of address indicator*

- 000000 spare
- 000001 ~~subscriber number, not used~~
- 000010 ~~spare, reserved for national use, not used~~
- 000011 national (significant) number
- 0000100 international number

- 0000101 } spare
- to }
- 1101111 }

- 1110000 } reserved for national use, not used
- to }
- 1111110 }

- 1111111 spare

c) *Internal network number indicator (INN ind.)*

- 0 routing to internal network number allowed
- 1 routing to internal network number not allowed

d) *Numbering plan indicator*

- 000 spare
- 001 ISDN (Telephony) numbering plan (Recommendation E.164, E.163)
- 010 spare
- 011 ~~Data numbering plan (Recommendation X.121), not used~~
- 100 ~~Telex numbering plan (Recommendation F.69), not used~~
- 101 reserved for national use, not used
- 110 reserved for national use, not used
- 111 spare

e) *Address signal*

- 0000 digit 0
- 0001 digit 1
- 0010 digit 2
- 0011 digit 3
- 0100 digit 4
- 0101 digit 5
- 0110 digit 6
- 0111 digit 7
- 1000 digit 8
- 1001 digit 9
- 1010 spare
- 1011 code 11
- 1100 code 12
- 1101 spare
- 1110 spare
- 1111 ST

The most significant address signal is sent first. Subsequent address signals are sent in successive 4-bit fields.

f) *Filler*

In case of an odd number of address signals, the filler code 0000 is inserted after the last address signal.

C.3.8 *Calling party number*

The format of the calling party number parameter field is shown in Figure C-10/Q.767:

	8	7	6	5	4	3	2	1
1	Odd/ even	Nature of address indicator						
2	NI ind.	Numbering plan			Presentat. Restriction		Screening indicator	
3	2nd address signal				1st address signal			
:								
n	Filler (if necessary)				n-th address signal			

Note — When the address presentation restricted indicator indicates address not available, octets 3 to n are omitted.

FIGURE C-10/Q.767
Calling party number parameter field

The following codes are used in the calling party number parameter field:

a) *Odd/even indicator:*

See § C.3.7 a).

b) *Nature of address indicator*

0000000 spare
0000001 ~~subscriber number, not used~~
0000010 ~~spare, reserved for national use, not used~~
0000011 ~~national (significant) number, not used~~
0000100 international number

0000101 }
to } spare
1101111 }

1110000 }
to } ~~reserved for national use, not used~~
1111110 }

1111111 spare

Note — Other types of nature of address indications (e.g. transit exchange identity) are for further study.

c) *Calling party number incomplete indicator (NI)*

0	complete
1	incomplete , <u>not used</u>

d) *Numbering plan indicator*

See § C.3.7 d).

e) *Address presentation restricted (Pres. Restrict.) indicator*

00	presentation allowed
01	presentation restricted
10	address not available (Note) , <u>not used</u>
11	spare

Note — ~~When the address is unavailable, the subfields in items a), b), c) and d) are coded with 0's.~~

f) *Screening indicator*

00	reserved (Note) , <u>not used</u>
01	user provided, verified and passed
10	reserved (Note) , <u>not used</u>
11	network provided

Note — ~~Code 00 and 10 are reserved for "user provided, not verified" and user provided, verified and failed respectively.~~

g) *Address signal*

0000	digit 0
0001	digit 1
0010	digit 2
0011	digit 3
0100	digit 4
0101	digit 5
0110	digit 6
0111	digit 7
1000	digit 8
1001	digit 9
1010	spare
1111	code 11
1100	code 12

1101	} spare
to	
1111	

h) *Filler*

See § C.3.7 f).

C.3.9 Calling party's category

The format of the calling party's category parameter field is shown in Figure C-11/Q.767.

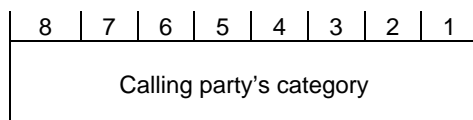

FIGURE C-11/Q.767

Calling party's category parameter field

The following codes are used in the calling party's category parameter field:

00000000	calling party's category unknown at this time <u>not used</u>	
00000001	operator, language French	
00000010	operator, language English	
00000011	operator, language German	
00000100	operator, language Russian	
00000101	operator, language Spanish	
00000110	} available to Administrations for selecting a particular language by mutual agreement	
00000111		
00001000		
00001001	reserved (see Recommendation Q.104) (Note), <u>not used</u>	
00001010	ordinary calling subscriber	
00001011	calling subscriber with priority	
00001100	data call (voice band data)	
00001101	test call	
00001110	spare	
00001111	payphone	
00010000	} spare	
to		
11011111		
11100000	} reserved for national use, <u>not used</u>	
to		
11111110		
11111111	spare	

Note — ~~In national networks code 00001001 may be used to indicate that the calling party is a national operator.~~

C.3.10 Cause indicators

The format of the cause indicators parameter field is shown in Figure C-12/Q.767.

	8	7	6	5	4	3	2	1
1	Ext	Coding standard		Spare	Location			
2	Ext	Cause value						

FIGURE C-12/Q.767
Cause indicator parameter field

The following codes are used in the subfields of the cause indicators parameter field:

a) *Extension indicator (ext)*

- 0 ~~octet continues through the next octet (e.g. octet 1 to 1a), not used~~
- 1 last octet

b) *Coding standard*

- 00 CCITT standard, as described below
- 01 ~~reserved for other international standards (Note), not used~~
- 10 ~~national standard (Note), not used~~
- 11 ~~standard specific to identified location (Note), not used~~

Note — ~~These other coding standards should be used only when the desired cause cannot be represented with the CCITT standard.~~

c) *Location*

- 0000 user
- 0001 ~~private network serving the local user, not used~~
- 0010 ~~public network serving the local user, not used~~
- 0011 transit network
- 0100 public network serving the remote user
- 0101 private network serving the remote user
- 0111 international network
- 1010 beyond an interworking point, all other values are reserved.

Note — Depending on the location of the users, the public network serving the local user may be the same network serving the remote user. Rules for coding the location field are defined in Recommendation Q.931 Annex J.

d) *Recommendation*

(This section is not applicable to the international interface.)

e) *Cause value*

The cause value is divided into two fields, a class (bits 5 through 7) and a value within a class (bits 1 through 4). The decimal equivalent of the cause value is shown in brackets beside the cause value.

Class 000 and 001 — normal event:

0000001	(1)	unallocated (unassigned) number
0000010	(2)	no route to specified transit network (national use), <u>not used</u>
0000011	(3)	no route to destination
0000100	(4)	send special information tone
0000101	(5)	misdialed trunk prefix, <u>not used</u>
0010000	(16)	normal call clearing
0010001	(17)	user busy
0010010	(18)	no user responding
0010011	(19)	no answer from user (user alerted)
0010101	(21)	call rejected
0010110	(22)	number changed
0011011	(27)	destination out of order
0011100	(28)	address incomplete
0011101	(29)	facility rejected
0011111	(31)	normal unspecified

Class 010 — resource unavailable:

0100010	(34)	no circuit available
0100110	(38)	network out of order
0101001	(41)	temporary failure
0101010	(42)	switching equipment congestion
0101100	(44)	requested channel not available
0101111	(47)	resource unavailable — unspecified

Class 011 — service or option not available:

0110010	(50)	requested facility not subscribed, <u>not used</u>
0110111	(55)	incoming calls barred within CUG
0111001	(57)	bearer capability not authorized
0111010	(58)	bearer capability not presently available
0111111	(63)	service/option not available — unspecified

Class 100 — service or option not implemented:

1000001	(65)	bearer capability not implemented
1000101	(69)	requested facility not implemented, <u>not used</u>
1000110	(70)	only restricted digital information bearer capability is available, <u>not used</u>
1001111	(79)	service or option not implemented — unspecified

Class 101 — invalid message (e.g. parameter out of range):

1010111	(87)	called user not member of CUG
1011000	(88)	incompatible destination
1011011	(91)	invalid transit network selection (national use), <u>not used</u>
1011111	(95)	invalid message — unspecified

Class 110 — Protocol error (e.g. unknown message):

1100001	(97)	message type non-existent or not implemented, <u>not used</u>
1100011	(99)	parameter non-existent or not implemented = discarded, <u>not used</u>
<u>1100110</u>	<u>(102)</u>	<u>recovery on timer expiry</u>
1100111	(103)	parameter non-existent or not implemented = passed on, <u>not used</u>
1101111	(111)	protocol error — unspecified

Class 111 — interworking:

1111111	(127)	interworking unspecified
---------	-------	--------------------------

f) *Diagnostic*

8	7	6	5	4	3	2	1
H	G	F	E	D	C	B	A

(This section is not applicable to the international interface.)

FIGURE C-14/Q.767

Circuit group supervision message type parameter field

C.3.11 *Circuit group supervision message type indicator*

The format of the circuit group supervision message type indicator parameter field is shown in Figure C-14/Q.767.

The following codes are used in the circuit group supervision message type indicator parameter field:

bits B A: Type indicator

0 0	maintenance oriented
0 1	hardware failure oriented
1 0	reserved for national use (used in 1984 version), <u>not used</u>
1 1	spare

bits C H: Spare

C.3.12 *Circuit state indicator*

(This section is not applicable to the international interface.)

C.3.13 *Closed user group interlock code*

The format of the closed user group interlock code parameter field is shown in Figure C-16/Q.767.

	8	7	6	5	4	3	2	1
1	1st NI digit				2nd NI digit			
2	3rd NI digit				4 th NI digit			
3	Binary code							
4								

FIGURE C-16/Q.767
Closed user group interlock code

The following codes are used in the subfields of the closed user group interlock code parameter field:

a) *Network identity (NI) (octets 1 and 2)*

Each digit is coded in the binary coded decimal representation from 0 to 9.

If the first digit of this field is coded 0 or 9, the telephony country code (TCC) follows in the second to fourth NI digits (the most significant TCC digit is in the 2nd NI digit). If the TCC is one or two digits long, the excess digit(s) is inserted with the code for RPOA or network identification, if necessary. If octet 2 is not required, it is coded all 0.

Coding of the first digit as 1 or 8 is excluded:

If the first digit is not 0, 9, 1 or 8 this field contains a data network identification code (DNIC) as defined in Recommendation X.121.

b) *Binary code (octets 3 and 4)*

A code allocated to a closed user group administered by a particular ISDN or data network. Bit 8 of octet 3 is the most significant and bit 1 of octet 4 is the least significant.

Only international interlock codes shall be used.

C.3.14 *Connected number*

The format of the connected number parameter field corresponds to the format shown in Figure C-17/Q.767.

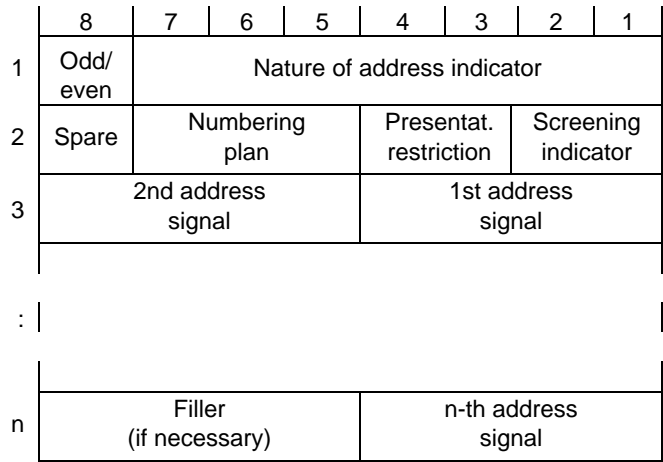

Note — When the address presentation restricted indicator indicates address not available, octets 3 to n are omitted.

FIGURE C-17/Q.767

Connected number parameter field

The following codes are used in the subfields of the connected number parameter field:

a) *Odd/even indicator*

- 0 even number of address signals
- 1 odd number of address signals

b) *Nature of address indicator*

- 0000000 spare
- 0000001 subscriber number, not used
- 0000010 spare, reserved for national use, not used
- 0000011 national (significant) number, not used
- 0000100 international number
- 0000101 } spare
- to }
- 1101111 }
- 1110000 } reserved for national use, not used
- to }
- 1111110 }
- 1111111 spare

c) *Numbering plan indicator*

000	spare
001	ISDN (Telephony) numbering plan (Recommendations E.164 and E.163)
010	spare
011	Data numbering plan (Recommendation X.121), not used
100	Telex numbering plan (Recommendation F.69), not used
101	reserved for national use, not used
110	reserved for national use, not used
111	spare

d) *Address presentation restricted (Pres. Restric.) indicator*

<u>00</u>	<u>presentation allowed</u>
<u>01</u>	<u>presentation restricted</u>
<u>10</u>	<u>address not available (Note)</u>
<u>11</u>	<u>spare</u>

Note — When the address is unavailable, the subfields in items a), b) and c) are coded with 0's.

e) *Screening indicator*: see § C.3.8 f)

f) *Address signal*: see § C.3.8 g)

g) *Filler*: see § C.3.7 h).

C.3.15 *Connection request*

(This section is not applicable to the international interface.)

C.3.16 *Continuity indicators*

The format of the continuity indicators parameter field is shown in Figure C-19/Q.767.

8	7	6	5	4	3	2	1
H	G	F	E	D	C	B	A

FIGURE C-19/Q.767

Continuity indicators parameter field

The following codes are used in the continuity indicators parameter field:

bit A:	Continuity indicator
0	continuity check failed
1	continuity check successful
bits B-H:	Spare

C.3.17 *End of optional parameters indicator*

The last optional parameter field of a message is followed by the end of optional parameters indicator, which occupies a one octet field containing all zeros.

C.3.18 *Event information*

The format of the event information parameter field is shown in Figure C-20/Q.767.

8	7	6	5	4	3	2	1
H	G	F	E	D	C	B	A

FIGURE C-20/Q.767
Event information parameter field

The following codes are used in the forward call indicators parameter field:

bits	G F E D C B A:	Event indicator
	0 0 0 0 0 0 0	spare
	0 0 0 0 0 0 1	ALERTING
	0 0 0 0 0 1 0	PROGRESS
	0 0 0 0 0 1 1	in-band information or an appropriate pattern is now available
	0 0 0 0 1 0 0	call forwarded on busy, not used
	0 0 0 0 1 0 1	call forwarded on no reply, not used
	0 0 0 0 1 1 0	call forwarded unconditional, not used
	0 0 0 0 1 1 1	} spare
	to	
	1 1 1 1 1 1 1	
bit	H:	Event presentation restricted indicator
	0	no indication
	1	presentation restricted, not used

C.3.19 *Facility indicator*

(This section is not applicable to the international interface.)

C.3.20 *Forward call indicators*

The format of the forward call indicators parameter field is shown in Figure C-22/Q.767.

	8	7	6	5	4	3	2	1
1	H	G	F	E	D	C	B	A
2	P	O	N	M	L	K	J	I

FIGURE C-22/Q.767

Forward call indicators parameter field

The following codes are used in the forward call indicators parameter field:

- bit A: National/international call indicator
 - 0 call to be treated as a national call
 - 1 call to be treated as an international call

This bit can be set to any value in the country of origin. In the international network this bit is not checked. In the destination country, calls from the international network will have this bit set to 1.

- bits C B: End-to-end method indicator (Note)
 - 0 0 no end-to-end method available (only link-by-link method available)
 - 0 1 ~~pass along method available, not used~~
 - 1 0 ~~SCCP method available, not used~~
 - 1 1 ~~pass along and SCCP methods available, not used~~

- bit D: Interworking indicator (Note)
 - 0 no interworking encountered (No. 7 signalling all the way)
 - 1 interworking encountered

- bit E: End-to-end information indicator (Note)
 - 0 no end-to-end information available
 - 1 ~~end-to-end information available, not used~~

- bit F: ISDN user part indicator (Note)
 - 0 ISDN user part not used all the way
 - 1 ISDN user part used all the way

- bits H G: ISDN user part preference indicator
 - 0 0 ISDN user part preferred all the way
 - 0 1 ISDN user part not required all the way
 - 1 0 ISDN user part required all the way
 - 1 1 spare

- bit I: ISDN access indicator
 - 0 originating access non-ISDN
 - 1 originating access ISDN
- bits K J : SCCP method indicator
 - 0 0 no indication
 - 0 1 ~~connection method available, not used~~
 - 1 0 ~~connection oriented method available, not used~~
 - 1 1 ~~connectionless and connection oriented methods available, not used~~
- bit L: Spare
- bits M-P: Reserved for national use

Note — Bits B-F and J-K constitute the protocol control indicator.

C.3.21 *Information indicators*

(This section is not applicable to the international interface.)

C.3.22 *Information request indicators*

(This section is not applicable to the international interface.)

C.3.23 *Nature of connection indicators*

The format of the nature of connection indicators parameter field is shown in Figure C-25/Q.767.

8	7	6	5	4	3	2	1
H	G	F	E	D	C	B	A

FIGURE C-25/Q.767

Nature of connection indicators parameter field

The following codes are used in the nature of connection indicators parameter field:

- bits B A: Satellite indicator
 - 0 0 no satellite circuit in the connection
 - 0 1 one satellite circuit in the connection
 - 1 0 two satellite circuits in the connection
 - 1 1 spare
- bits D C: Continuity check indicator
 - 0 0 continuity check not required
 - 0 1 continuity check required on this circuit
 - 1 0 continuity check performed on a previous circuit
 - 1 1 spare

- bit E: Echo control device indicator
 - 0 outgoing half echo control device not included
 - 1 outgoing half echo control device included
- bits F-H: Spare

C.3.24 *Optional backward call indicators*

The format of the optional backward call indicators parameter field is shown in Figure C-26/Q.767.

8	7	6	5	4	3	2	1
H	G	F	E	D	C	B	A

FIGURE C-26/Q.767

Optional backward call indicators parameter field

The following codes are used in the optional backward call indicators parameter field:

- bit A: In-band information indicator
 - 0 no indication
 - 1 in-band information or an appropriate pattern is now available
- bit B: Call forwarding may occur indicator
 - 0 no indication
 - 1 ~~call forwarding may occur~~, not used
- bits C-D: Spare
- bits E-H: ~~Reserved for national use~~, not used

C.3.25 *Optional forward call indicators*

The format of the optional forward call indicators parameter field is shown in Figure C-27/Q.767.

8	7	6	5	4	3	2	1
H	G	F	E	D	C	B	A

FIGURE C-27/Q.767

Optional forward call indicators parameter field

The following codes are used in the optional forward call indicators parameter field:

bits B A: Closed user group call indicator
 0 0 non-CUG call
 0 1 spare
 1 0 closed user group call, outgoing access allowed
 1 1 closed user group call, outgoing access not allowed

bit C-G: Spare

bit H: Connected line identity request indicator
0 not requested
1 requested

C.3.26 *Original called number*

(This section is not applicable to the international interface.)

C.3.27 *Range and status*

The format of the range and status parameter field is shown in Figure C-29/Q.767.

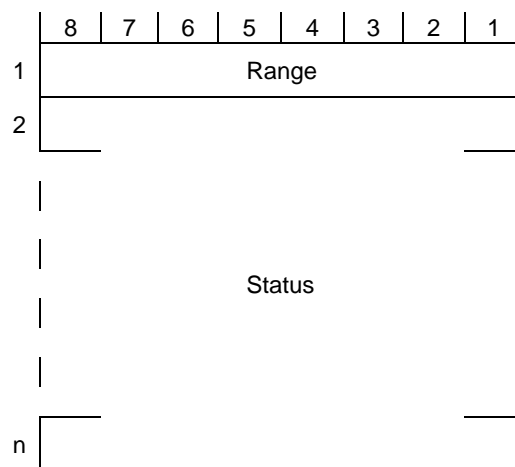

FIGURE C-29/Q.767

Range and status parameter field

The following codes are used in the subfields of the range and status parameter field:

a) *Range*

A number in pure binary representation ranging from 1 to 255. ~~Range code 0 indicates absence of the status field.~~ The number represented by the range code +1 indicates the range of circuits affected by the message.

b) *Status*

THE STATUS SUBFIELD CONTAINS FROM 2 TO 256 STATUS BITS NUMBERED FROM 0 TO 255. Status bit 0 is located in bit position 1 of the first status subfield octet. Other status bits follow in numerical order. The number of relevant status bits in a given status subfield is equal to range +1.

Each status bit is associated with a circuit identification code such that status bit n is associated with circuit identification code $m+n$, where m is the circuit identification code contained in the message.

The status bits are coded as follows :

— in circuit group blocking messages

0 no indication
1 blocking

— in circuit group blocking acknowledgement messages

0 no indication
1 blocking acknowledgement

— in circuit group unblocking messages

0 no indication
1 unblocking

— in circuit group unblocking acknowledgement messages

0 no indication
1 unblocking acknowledgement

— in circuit group reset acknowledgement messages

0 not blocked for maintenance reasons
1 blocked for maintenance reasons

The number of circuits affected by a group supervision message is limited to 32 or less. For the group reset ~~and query messages~~ this requires that the range value be 31 or less. For the group blocking and unblocking messages the range value may be up to 255, but the number of status bits set to 1 must be 32 or less.

~~For the group blocking, unblocking and reset messages, range code 0 is reserved.~~

C.3.28 *Redirecting number*

(This section is not applicable to the international interface.)

C.3.29 *Redirection information*

(This section is not applicable to the international interface.)

C.3.30 *Redirection number*

(This section is not applicable to the international interface.)

C.3.31 *Signalling point code (national use)*

(This section is not applicable to the international interface.)

C.3.32 *Subsequent number*

The format of the subsequent number parameter field is shown in Figure C-32/Q.767.

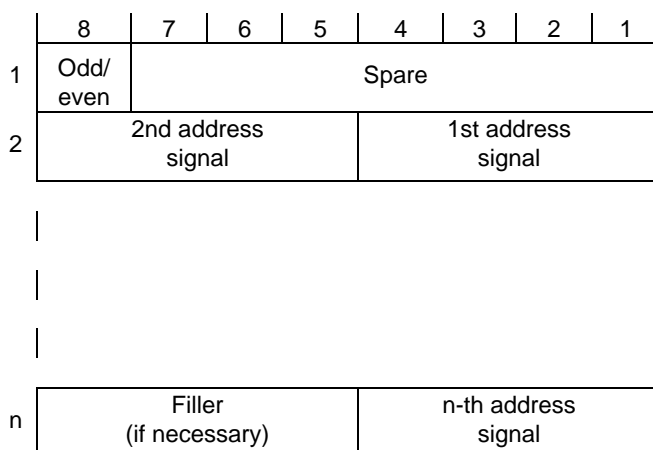

FIGURE C-32/Q.767

Subsequent number parameter field

The following codes are used in the subfields of the subsequent number parameter field:

- a) Odd/even indicator: see § C.3.7 a)
- b) Address signal: see § C.3.7 e)
- c) Filler: see § C.3.7 f).

C.3.33 *Suspend/resume indicators*

The format of the suspend/resume indicators parameter field is shown in Figure C-33/Q.767.

8	7	6	5	4	3	2	1
H	G	F	E	D	C	B	A

FIGURE C-33/Q.767

Suspend/resume indicators parameter field

The following codes are used in the suspend/resume indicators parameter field:

bit A: Suspend/resume indicator
 0 ISDN subscriber initiated
 1 network initiated

bits B-H: Spare

C.3.34 *Transit network selection (national use)*

(This section is not applicable to the international interface.)

C.3.35 *Transmission medium requirement*

The format of the transmission medium requirement parameter field is shown in Figure C-35/Q.767.

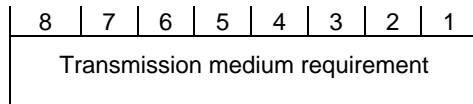

FIGURE C-35/Q.767

Transmission medium requirement parameter field

The following codes are used in the transmission medium requirement parameter field.

00000000	speech	
00000001	spare	
00000010	64 kbit/s unrestricted	
00000011	3.1 kHz audio	
00000100	alternate speech (service 2)/64 kbit/s unrestricted (service 1) (Note 1), <u>not used</u>	
00000101	alternate 64 kbit/s unrestricted (service 1)/speech (service 2) (Note 2), <u>not used</u>	
00000110	spare	
00000111	reserved for 2 × 64 kbit/s unrestricted, <u>not used</u>	
00001000	reserved for 384 kbit/s unrestricted, <u>not used</u>	
00001001	reserved for 1536 kbit/s unrestricted, <u>not used</u>	
00001010	reserved for 1920 kbit/s unrestricted, <u>not used</u>	

00001011 }
to } spare
11111111 }

Note 1 — The initial mode is speech.

Note 2 — The initial mode is 64 kbit/s unrestricted.

C.3.36 *User service information*

The format of the user service information parameter field is shown in Figure C-36/Q.767. This format is the same as the bearer capability information element from Recommendation Q.931 and not all capabilities coded here are supported at this time. More detailed information on the use of the User service Information is given in § 4.3 of Rec. Q.767.

	8	7	6	5	4	3	2	1
1	Ext.	Coding standard		Information transfer capability				
2	Ext.	Transfer mode		Information transfer rate				
2 a	Ext.	Structure			Configuration		Establishment	
2b	Ext.	Symmetry		Information transfer rate (destination to origination)				
3	Ext.	Layer ident.		User information Layer 1 protocol				
4	Ext.	Layer ident.		User information Layer 2 protocol				
5	Ext.	Layer ident.		User information Layer 3 protocol				

Note 1 — Octet 2a is omitted if default values apply to all fields of octets 2a and 2b.

Note 2 — Octet 2b is omitted if default values apply to all fields of octet 2b.

Note 3 — Octets 3, 4, 5 or any combination of these octets may be omitted. Octet 3 may be extended as described in § C.3.36 k).

FIGURE C-36/Q.767

User service information parameter field

The following codes are used in the subfields of the user service information parameter field:

a) *Extension indicator (ext)*

- 0 octet continues through the next octet (e.g. octet 2 to 2a, 2a to 2b, 3 to 3a)
- 1 last octet

b) *Coding standard*

00	CCITT standardized coding as described below
01	reserved for other international standards (Note)
10	national standard (Note)
11	standard defined for the network (either public or private) present on the network_side of the interface (Note)

Note — These other coding standards should only be used when the desired bearer capability cannot be represented with the CCITT standardized coding.

c) *Information transfer capability*

00000	speech
01000	unrestricted digital information
01001	restricted digital information
10000	3.1 kHz audio
10001	7 kHz audio
11000	video

All other values are reserved.

d) *Transfer mode*

00	circuit mode
10	packet mode

All other values are reserved.

e) *Information transfer rate (octets 2 and 2b) (Note 1)*

00000	This code shall be used for packetmode calls
10000	64 kbit/s
10001	2 × 64 kbit/s (Note 2)
10011	384 kbit/s
10101	1536 kbit/s
10111	1920 kbit/s

All other values are reserved.

Note 1 — When octet 2b is omitted, the bearer capability is bidirectional symmetric at the information transfer rate specified in octet 2. When octet 2b is included, the information rate in octet 2 refers to the origination to destination direction.

Note 2 — For this case, the coding of octets 1 and 2a refers to both 64 kbit/s circuits.

f) *Structure*

000	default (Note 1)
001	8 kHz integrity (Note 2)
100	service data unit integrity
111	unstructured

All other values are reserved.

Note 1 — If octet 2a is omitted, or the structure field is coded 000, then the value of the structure attribute is according to the following :

Transfer mode	Transfer capability	Structure
circuit	speech	8 kHz integrity
circuit	unrestricted digital	8 kHz integrity
circuit	restricted digital	8 kHz integrity
circuit	audio	8 kHz integrity
circuit	video	8 kHz integrity
packet	unrestricted digital	service data unit integrity

Note 2 — When the information transfer rate 2×64 kbit/s is used, 8 kHz integrity with restricted differential time delay (RDTD) is offered.

g) *Configuration*

00 point-to-point

All other values are reserved. If omitted, the configuration is assumed to be point-to-point.

h) *Establishment*

00 demand

All other values are reserved. If omitted, the establishment is assumed to be demand.

i) *Symmetry*

00 bidirectional symmetric

All other values are reserved. If omitted, the symmetry is assumed to be bidirectional symmetric.

j) *Layer identification*

00 reserved
01 user information layer 1 protocol
10 user information layer 2 protocol
11 user information layer 3 protocol

Note — Bits 5-1 of the same octet represent the corresponding identification as per points k), l) and m) below. If octet 3, 4 or 5 is omitted, the corresponding user information protocol is assumed to be undefined.

k) *User information layer 1 protocol identification*

00001 CCITT standardized rate adaption V.110/X.30. This implies the presence of octet 3a defined in § C.3.36 k) 1), and optionally octets 3b, 3c and 3d defined in § C.3.36 k) 2) below.

00010 Recommendation G.711 μ law

00011 Recommendation G.711 A law

00100 Recommendation G.721 32 kbit/s ADPCM and Recommendation I.460

00101 Recommendations G.722 and G.724 for 7 kHz audio

00110 Recommendation G.735 for 384 kbit/s video

00111 non-CCITT standardized rate adaption. This implies the presence of octet 3a, and optionally 3b, 3c and 3d. The use of this codepoint indicates that the user rate specified in octet 3a is defined in accordance with the non-CCITT standardized rate adaption scheme. Additionally, octets 3b, 3c and 3d, if present, are defined consistent with the specified rate adaption.

01000 CCITT standardized rate adaption V.120. This implies the presence of octet 3a defined in § C.3.36 k) 1), octet 3b defined in § C.3.36 k) 3), and optionally octets 3c and 3d defined in § C.3.36 k) 2) below.

01001 CCITT standardized rate adaption X.31 HDLC flag stuffing.

All other values are reserved.

Note — Octet 3 shall be omitted if the transfer mode is "circuit mode", the information transfer capability is "unrestricted digital information" or "restricted digital information" and the user information layer 1 protocol is not to be identified to the network; octet 3 may be omitted if the transfer mode is "packetmode"; otherwise octet 3 shall be present.

1) *Octet 3a for layer 1 rate adaption* (see Figure C-37/Q.767)

	8	7	6	5	4	3	2	1
3a	Ext.	Synch/ asynch	Negot.	User rate				

FIGURE C-37/Q.767

Basic layer 1 rate adaption fields

— The synchronous/asynchronous indicator is coded:

0 synchronous
1 asynchronous

Octets 3b to 3d may be omitted in case of synchronous user rates.

— The negotiation indicator is coded:

0 in-band negotiation not possible
1 in-band negotiation possible

Note — See Recommendations V.110 and X.30

— The user rate is coded:

00000	rate indicated by E-bits	Rec. I.460
00001	0.6 kbit/s	Recs. V.6 and X.1
00010	1.2 kbit/s	Rec. V.6
00011	2.4 kbit/s	Recs. V.6 and X.1
00100	3.6 kbit/s	Rec. V.6
00101	4.8 kbit/s	Recs. V.6 and X.1
00110	7.2 kbit/s	Rec. V.6
00111	8.0 kbit/s	Rec. I.460
01000	9.6 kbit/s	Recs. V.6 and X.1
01001	14.4 kbit/s	Rec. V.6
01010	16.0 kbit/s	Rec. I.460
01011	19.2 kbit/s	Rec. V.6
01100	32.0 kbit/s	Rec. I.460
01110	48.0 kbit/s	Recs. V.6 and X.1
01111	56.0 kbit/s	Rec. V.6
10101	0.1345 kbit/s	Rec. X.1
10110	0.100 kbit/s	Rec. X.1
10111	0.075/1.2 kbit/s	Recs. V.6 and X.1 (Note)
11000	1.2/0.075 kbit/s	Recs. V.6 and X.1 (Note)
11001	0.050 kbit/s	Recs. V.6 and X.1
11010	0.075 kbit/s	Recs. V.6 and X.1
11011	0.110 kbit/s	Recs. V.6 and X.1
11100	0.150 kbit/s	Recs. V.6 and X.1
11101	0.200 kbit/s	Recs. V.6 and X.1
11110	0.300 kbit/s	Recs. V.6 and X.1
11111	12 kbit/s	Recs. V.6 and X.1

All other values are reserved.

Note — The first rate is the transmit rate in the forward direction of the call. The second rate is the transmit rate in the backward direction of the call.

2) Octets 3b, 3c and 3d for Recommendations V.110/X.30 rate adaption (see Figure C-38/Q.767)

	8	7	6	5	4	3	2	1
3b	Ext.	Intermediate rate		NIC on Tx	NIC on Rx	Flow cont. on Tx	Flow cont. on Rx	Spare
3c	Ext.	Number of stop bits		Number of data bits		Parity		
3d	Ext.	Duplex mode	Modem type					

Note — Octets 3c and 3d may be omitted.

FIGURE C-38/Q.767

Recommendation V.110/X.30 rate adaption extension fields

— Intermediate rate indicator is coded:

00 not used
 01 8 kbit/s
 10 16 kbit/s
 11 32 kbit/s

— Network independent clock (NIC) on transmission (TX) indicator is coded:

0 not required to send data with NIC
 1 required to send data with NIC

Note — Refers to transmission in the forward direction of the call, see Recommendations V.110 and X.30.

— Network independent clock (NIC) on reception (Rx) indicator is coded :

0 cannot accept data with NIC (i.e. sender does not support this optional procedure)
 1 can accept data with NIC (i.e. sender does support this optional procedure)

Note — Refers to transmission in the backward direction of the call, see Recommendations V.110 and X.30.

— Flow control on transmission (Tx) indicator is coded:

- 0 not required to send data with flow control mechanism
- 1 required to send data with flow control mechanism

Note — Refers to transmission in the forward direction of the call, see Recommendations V.110 and X.30.

— Flow control on reception (Rx) indicator is coded:

- 0 cannot accept data with flow control mechanism (i.e. sender does not support this optional procedure)
- 1 can accept data with flow control mechanism (i.e. sender does support this optional procedure)

Note — See Recommendations V.110 and X.30.

— Number of stop bits indicator is coded:

- 00 not used
- 01 1 bit
- 10 1.5 bits
- 11 2 bits

— Number of data bits indicator, including parity bit if present, is coded :

- 00 not used
- 01 5 bits
- 10 7 bits
- 11 8 bits

— Parity indicator is coded:

- 000 odd
- 010 even
- 011 none
- 100 forced to 0
- 101 forced to 1

All other values are reserved.

— Duplex mode indicator is coded:

- 0 half duplex
- 1 full duplex

— modem type indicator is coded according to network specific rules.

3) Octet 3b for Recommendation V.120 rate adaption (see Figure C-39/Q.767)

	8	7	6	5	4	3	2	1
3b	Ext.	Hdr/ Hdr no hdr	Multi. frame supp.	Mode	LLI. Neg.	Assigner/ Assignee	Inband/ Outband	Spare

Note— Octets 3c and 3d in Figure C-38/Q.767 may also be present.

FIGURE C-39/Q.767

Recommendation V.120 rate adaption extension fields

- Rate adaption header/no header indicator is coded:
 - 0 rate adaption header not included
 - 1 rate adaption header included
 - Multiple frame establishment support in data link indicator is coded :
 - 0 multiple frame establishment not supported, only UI frames allowed
 - 1 multiple frame establishment supported
 - Mode of operation indicator is coded:
 - 0 bit transparent mode of operation
 - 1 protocol sensitive mode of operation
 - Logical link identifier (LLI) negotiation indicator is coded:
 - 0 default, LLI = 256 only
 - 1 full protocol negotiation (Note)
- Note — A connection over which protocol negotiation will be executed is indicated in bit 2 of octet 3b.
- Assignor/assignee indicator is coded:
 - 0 message originator is "default" assignee"
 - 1 message originator is assignor only
 - In-band/out-of-band negotiation indicator is coded:
 - 0 negotiation is done with USER INFORMATION messages on a temporary signalling connection
 - 1 negotiation is done inband using logical link zero

l) *User information layer 2 protocol identification*

00010 Recommendation Q.921 (I.441)
 00110 Recommendation X.25, link level

All other values are reserved. If the transfer mode is packet mode, this octet shall be present. In other cases, the octet is present only if the protocol is to be identified to the network.

m) *User information layer 3 protocol identification*

00010 Recommendation Q.931 (I.451)
 00110 Recommendation X.25, packet level

All other values are reserved. The octet is present only if the protocol is to be identified to the network.

C.3.37 *User-to-user indicators*

The format of the user-to-user indicators parameter field is shown in Figure C-40/Q.767.

8	7	6	5	4	3	2	1
H	G	F	E	D	C	B	A

FIGURE C-40/Q.767

User-to-user indicators parameter field

The following codes are used in the user-to-user indicators parameter field:

bit A	Type
0	<u>request, not used</u>
1	response

If bit A equals 0 (request):

bits C B:	Service I
0 0	no information
0 1	spare
1 0	request, not essential
1 1	request, essential

bits E D:	Service 2
0 0	no information
0 1	spare
1 0	request, not essential
1 1	request, essential

bits G F:	Service 3
0 0	no information
0 1	spare
1 0	request, not essential
1 1	request, essential

bit H	Spare
------------------	------------------

If bit A equals 1 (response):

bits C B:	Service 1
0 0	no information
0 1	not provided, not used
1 0	provided, not used
1 1	spare, not used

bits E D:	Service 2
0 0	no information
0 1	not provided, not used
1 0	provided, not used
1 1	spare, not used

bits G F:	Service 3
0 0	no information
0 1	not provided, not used
1 0	provided, not used
1 1	spare, not used

<u>bit H</u>	<u>Network discard indicator</u>
<u>0</u>	<u>no information, not used</u>
<u>1</u>	<u>UUI discarded by the network</u>

C.3.38 *User-to-user information*

The format of the user-to-user information parameter is shown in Figure C-41/Q.767.

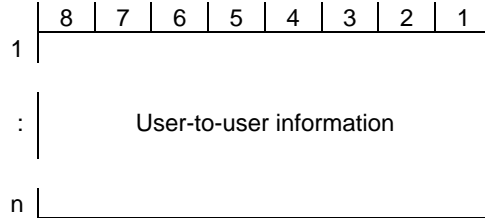

FIGURE C-41/Q.767

User-to-user information parameter field

The format of the user-to-user information parameter field is coded identically to the protocol discriminator plus user information field described in Recommendation Q.931, § 4.5.29.

C.4 *ISDN User Part messages and codes*

In the following tables the format and coding of ISDN User Part messages is specified. For each message, a list of the relevant parameters is given and for each parameter :

- a reference to the section where the formatting and coding of the parameter content is specified;
- the type of the parameter. The following types are used in the tables :
 - F = Mandatory Fixed Length parameter;
 - V = Mandatory Variable Length parameter;
 - O = Optional parameter of fixed or variable length;
- the length of the parameter. The value in the table includes:
 - for type F parameters the length, in octets, of the parameter content;
 - for type V parameters the length, in octets, of the length indicator and of the parameter content. The minimum and the maximum length are indicated;
 - for type O parameters the length, in octets, of the parameter name, length indicator and parameter content. For variable length parameters the minimum and maximum length is indicated.

For each message type, type F parameters and the pointers for the type V parameters must be sent in the order specified in the tables.

The routing label and circuit identification code fields, which are transmitted ahead of the message type field if required are not shown. Parameter names, pointers to mandatory variable fields and the optional part, and length indicators appear in the message in accordance with Figure C-3/Q.767 and are not shown explicitly in Tables C-5/Q.767 to C-28/Q.767.

TABLE C-5/Q.767

Message type: Address complete

Parameter	Reference	Type	Length (octets)
Message type	2.1	F	1
Backward call indicators	3.4	F	2
Optional backward call indicators	3.24	O	3
Cause indicators	3.10	O	4
Connected number	3.14	Θ	4-12
Call reference	3.6	Θ	7
User-to-user indicators	3.37	O	3
User-to-user information	3.38	O	3-131 ^{a)}
Access transport	3.2	O	3-?
End of optional parameters	3.17	O	1

^{a)} Some networks may only support up to 35 octets.

TABLE C-6/Q.767

Message type: Answer

Parameter	Reference	Type	Length (octets)
Message type	2.1	F	1
Backward call indicators	3.4	O	4
Optional backward call indicators	3.24	Θ	3
Call reference	3.6	Θ	7
User-to-user indicators	3.37	Θ	3
User-to-user information	3.38	O	3-131 ^{a)}
Connected number	3.14	O	4-12
Access transport	3.2	O	3-?
End of optional parameters	3.17	O	1

^{a)} Some networks may only support up to 35 octets.

TABLE C-7/Q.767

Message type: Call progress

Parameter	Reference	Type	Length (octets)
Message type	2.1	F	1
Event information	3.18	F	1
Cause indicators	3.10	Θ	4
Call reference	3.6	Θ	7
Backward call indicators	3.4	O	4
Optional backward call indicators	3.24	O	3
Access transport	3.2	O	3-?
User-to-user indicators	3.37	Θ	3
User-to-user information	3.38	O	3-131 ^{a)}
Redirection number	3.30	Θ	5-12
End of optional parameters	3.17	O	1

^{a)} Some networks may only support up to 35 octets.

TABLE C-8/Q.767

Message type: ~~Circuit group query response~~, not used

TABLE C-9/Q.767

Message type: **Circuit group reset acknowledgement**

Parameter	Reference	Type	Length (octets)
Message type	2.1	F	1
Range and status	3.27	V	3-34

TABLE C-10/Q.767

Message type: ~~Confusion~~, not used

TABLE C-11/Q.767

Message type: **Connect**

Parameter	Reference	Type	Length (octets)
Message type	2.1	F	1
Backward call indicators	3.4	F	2
Optional backward call indicators	3.24	Θ	3
Connected number	3.14	O	4-12
Call reference	3.6	Θ	7
User-to-user indicators	3.37	O	3
User-to-user information	3.38	O	3-131 ^{a)}
Access transport	3.2	O	3-?
End of optional parameters	3.17	O	1

^{a)} Some networks may only support up to 35 octets.

TABLE C-12/Q.767

Message type: **Continuity**

Parameter	Reference	Type	Length (octets)
Message type	2.1	F	1
Continuity indicators	3.16	F	1

TABLE C-13/Q.767

Message type: ~~Facility reject~~, **not used**

TABLE C-14/Q.767

Message type: ~~Information~~, **not used**

TABLE C-15/Q.767

Message type: ~~Information request~~, **not used**

TABLE C-16/Q.767

Message type: Initial address

Parameter	Reference	Type	Length (octets)
Message type	2.1	F	1
Nature of connection indicators	3.23	F	1
Forward call indicators	3.20	F	2
Calling party's category	3.9	F	1
Transmission medium requirement	3.35	F	1
Called party number	3.7	V	4-11
Transit network selection ^{a)}	3.34	Θ	4-?
Call reference	3.6	Θ	7
Calling party number	3.8	O	4-12
Optional forward call indicators	3.25	O	3
Redirecting number	3.28	Θ	4-12
Redirection information	3.29	Θ	3-4
Closed user group interlock code	3.13	O	6
Connection request	3.15	Θ	7-9
Original called number	3.26	Θ	4-12
User-to-user information ^{b)}	3.38	O	3-131
Access transport	3.2	O	3-?
User service information ^{c)}	3.36	O	4-13
User to user indicators	3.37	Θ	3
End of optional parameters	3.17	O	1

^{a)} For national use only

^{b)} Some networks may only support up to 35 octets.

^{c)} This parameter can be repeated in case of an alternate bearer service, in which case the initial parameter represents the initial establishment mode.

TABLE C-17/Q.767

Message type: Release

Parameter	Reference	Type	Length (octets)
Message type	2.1	F	1
Cause indicators	3.10	V	3
Redirection information	3.29	Θ	3-4
Redirection number	3.30	Θ	5-12
Signalling point code a)	3.31	Θ	4
Access transport	3.2	Θ	3-?
User-to-user information b)	3.38	O	3-131
Automatic congestion level	3.3	O	3
End of optional parameters	3.17	O	1

a) For national use only

b) Some networks may only support up to 35 octets.

TABLE C-18/Q.767

Message type: Release complete

Parameter	Reference	Type	Length (octets)
Message type	2.1	F	1
Cause indicators	3.10	Θ	4
End of optional parameters	3.17	O	1

TABLE C-19/Q.767

Message type: Subsequent address

Parameter	Reference	Type	Length (octets)
Message type	2.1	F	1
Subsequent number	3.32	V	3-10
End of optional parameters	3.17	O	1

TABLE C-20/Q.767

Message type: ~~User-to-user information~~, not used

TABLE C-21/Q.767

Message type: ~~Delayed release (national use)~~
Forward transfer

Parameter	Reference	Type	Length (octets)
Message type	2.1	F	1
Call reference	3.6	Θ	7
End of optional parameters	3.17	O	1

TABLE C-22/Q.767

Message type: Suspend
Resume

Parameter	Reference	Type	Length (octets)
Message type	2.1	F	1
Suspend/Resume indicators	3.33	F	1
Call reference	3.6	Θ	7
End of optional parameters	3.17	O	1

TABLE C-23/Q.767

Message type: **Blocking**
Blocking acknowledgement
Continuity check request
~~Loop back acknowledgment (national use), not used~~
~~Overload, not used~~
Reset circuit
Unblocking
Unblocking acknowledgement
~~Unequipped circuit identification code (national use), not used~~

Parameter	Reference	Type	Length (octets)
Message type	2.1	F	1

TABLE C-24/Q.767

Message type: ~~Call modification complete, not used~~
~~Call modification request, not used~~
~~Call modification reject, not used~~

TABLE C-25/Q.767

Message type: **Circuit group blocking**
Circuit group blocking acknowledgement
Circuit group unblocking
Circuit group unblocking acknowledgement

Parameter	Reference	Type	Length (octets)
Message type	2.1	F	1
Circuit group supervision message type indications	3.11	F	1
Range and status	3.27	V	3-34

TABLE C-26/Q.767

Message type: **Circuit group reset**
~~**Circuit group query, not used**~~

Parameter	Reference	Type	Length (octets)
Message type	2.1	F	1
Range and status a)	3.27	V	2

a) The status subfield is not present.

TABLE C-27/Q.767

Message type: ~~**Facility accepted, not used**~~
~~**Facility request, not used**~~

Message type: ~~Pass-along~~, not used

ANNEX C.A

(to Annex C of Recommendation Q.767)

Interpretation of spare codes

See § 4.1.1.

ANNEX D

(to Recommendation Q.767)

Signalling procedures

D.1 *General*

D.1.1 *Relationship with other Recommendations*

This Recommendation describes the signalling procedures for the set-up and clear-down of ~~national and~~ international ISDN connections. *THE MESSAGES AND SIGNALS ARE DEFINED IN § 3.3 AND ANNEX B AND THEIR FORMAT AND CONTENT ARE GIVEN IN § 3.4 AND ANNEX C, § 3.6 AND ANNEX E CONTAINS THE PROCEDURES FOR SUPPLEMENTARY SERVICES.*

D.1.2 *Numbering* (see Recommendations E.163, E.164)

The procedures described assume that the ISDN uses the international numbering plan defined for the ISDN and thus provides a basic circuit switched service between ISDN terminals or between ISDN terminals and terminals being connected to the existing international telephony network.

D.1.3 *Address signalling*

In general, the call set-up procedure described is standard for both speech and non-speech connections using en-bloc address signalling for calls between ISDN terminals. Overlap address signalling is also specified.

Note — The use of en-bloc or overlap signalling is based on bilateral agreements.

D.1.4 *Basic procedures*

The basic call control procedure is divided into three phases: call set-up, the data/conversation phase and call clear-down. Messages on the signalling link are used to establish and terminate the different phases of a call. Standard inband supervisory tones and/or recorded announcements are returned to the caller on speech and 3.1 kHz connections to provide information on call progress. Calls originating from ISDN terminals may be supplied with more detailed call progress information by means of additional messages in the access protocol supported by a range of messages in the network.

D.1.5 *Signalling methods*

ONE SIGNALLING METHOD IS USED IN THIS RECOMMENDATION:

- link-by-link;
- == ~~end-to-end~~.

This method is primarily used for messages that need to be examined at each exchange (see § D.2). ~~The end-to-end methods are used for messages of end-point significance (see Annex E), and may be used for messages of end-point significance.~~ (However, the messages may be affected by processing delays.)

D.1.6 *Layout of Annex D*

THE PROCEDURES SPECIFIED IN § D.2 OF THIS RECOMMENDATION RELATE TO BASIC CALLS (I.E. CALLS NOT INVOLVING SUPPLEMENTARY SERVICES). Section D.3 of this Recommendation specifies the procedures relating to end-to-end signalling connections. THE ADDITIONAL REQUIREMENTS TO BE MET IN THE CASE OF CALLS INVOLVING SUPPLEMENTARY SERVICES AND NETWORK UTILITIES ARE SPECIFIED IN ANNEX E. THE TIMERS USED IN THIS RECOMMENDATION ARE SUMMARIZED IN ANNEX D.A. The SDLs for the ISDN-UP are presented in Annex D.B.

D.1.7 *Interworking with other signalling systems or user parts*

Only some examples are included in this Recommendation and these should not be used as a definitive interworking guide.

D.2 *Basic call control and signalling procedures*

FIGURES D-1/Q.767 TO D-10/Q.767 AT THE END OF THIS SECTION SHOW THE ISDN CALL SET-UP SEQUENCES WHICH ARE DESCRIBED BELOW.

D.2.1 *Successful call set-up*

D.2.1.1 *Forward address signalling — en bloc operation*

D.2.1.1.1 *Actions required at originating exchange*

a) *Circuit selection*

When the originating exchange has received the complete selection information from the calling party, and has determined that the call is to be routed to another exchange, selection of a suitable, free, inter-exchange circuit takes place and an initial address message is sent to the succeeding exchange.

Appropriate routing information is either stored at the originating exchange or at a remote database to which a request may be made.

The selection of the route will depend on the called party number, connection type required and the network signalling capability required. This selection process may be performed at the exchange or with the assistance of the remote database.

In addition, in the case of a subscriber with digital access, the set-up message contains bearer capability information which is analyzed by the originating exchange to determine the correct connection type and network signalling capability. The bearer capability information will be mapped into the user service information parameter of the initial address message. The information received from the access interface is used to set the value of the transmission medium requirement parameter. ~~The first value of bearer information received will be used to set the initial mode of the connection.~~

The connection types allowed are:

- speech;
- 3.1 kHz audio;
- 64 kbit/s unrestricted;
- ~~— alternate speech/64 kbit/s unrestricted;~~
- ~~— alternate 64 kbit/s unrestricted/speech.~~

The network signalling capabilities allowed are:

- ISDN-UP preferred;
- ISDN-UP required;
- ISDN-UP not required (any signalling system).

The information used to determine the routing of the call by the originating exchange will be included in the initial address message (as transmission medium requirement and forward call indicators), to enable correct routing at intermediate exchanges. The initial address message conveys implicitly the meaning that the indicated circuit has been seized.

~~In the case where $N \times 64$ kbit/s ($N > 2$) connections are required, the procedures for a single 64 kbit/s connection may be used if the $N \times 64$ kbit/s are contiguous 64 kbit/s channels and are pre-assigned for $N \times 64$ kbit/s use.~~

If subaddress information is received from the calling access, this information is passed unchanged to the destination exchange in the access transport parameter of the initial address message.

b) *Address information sending sequence*

The sending sequence of address information on international calls will be the country code (not sent to an incoming international exchange) followed by the national (significant) number. ~~On national connections, the address information may be the local number or the national (significant) number as required by the Administration concerned.~~ For calls to international operator positions (Code 11 and Code 12), refer to Recommendation Q.107.

The end-of-pulsing (ST) signal will be used whenever the originating exchange or the outgoing exchange is in a position to know by digit analysis that the final digit has been sent.

c) *Initial address message*

The initial address message (IAM) in principle contains all the information that is required to route the call to the destination exchange and connect the call to the called party.

All initial address messages will include a protocol control indicator (in the forward call indicator parameter) and a transmission medium requirement parameter.

The originating exchange will set the parameters in the protocol control indicator and in the ISDN-UP preference indicator to indicate:

- i) the only type of end-to-end method that can be accommodated (~~§ D.3~~);
- ii) the availability of Signalling System No. 7 signalling;
- iii) the use of the ISDN-UP;
- iv) whether further information is available (to be requested before the called party is alerted);
- v) network signalling capability required, e.g. ISDN-UP required all the way.

The ISDN-UP preference indicator is set according to the bearer service, teleservice and supplementary service(s) requested. The exact setting depends on the service demand conditions and may be different depending on individual cases. In principle, if the service demand requires ISDN-UP to be essential, then the indicator is set to "required"; if the service required is optional but preferred, it is set to "preferred", otherwise it is set to "not required". The indicator is set to either "required" or "preferred", or "not required", according to the most stringent condition required by one or more of the parameters in the initial address message. ~~In addition, if end-to-end signalling method is essential to provide the requested service, the indicator should always be set to "required" (see Recommendation E.172).~~

The transmission medium requirement parameter contains the connection type required information, e.g. 3.1 kHz audio.

The originating exchange may also include in the initial address message:

- i) ~~a call reference (including the point code of the originating exchange) to enable the destination exchange to establish an end-to-end connection (§ 3);~~
- ii) the calling party number if this is to be passed forward without being requested. The calling party number could contain Code 11 or 12 if the call is from an international operator;
- iii) ~~an SCCP connection request parameter; and~~
- iv) other information related to supplementary services and network utilities.

The initial address message can contain an access transport parameter.

d) *Transfer of information not included in the initial address message*

This section is not applicable to the international interface.

e) *Completion of transmission path*

Through-connection of the transmission path will be completed in the backward direction (the transmission path is completed in the forward direction on receipt of a connect or answer message) at the originating exchange immediately after the sending of the initial address message, except in those cases where conditions on the outgoing circuit prevent it (see § D.2.1.9).

It is also acceptable that on speech or 3.1 kHz audio calls, through-connection of the transmission path will be completed in both directions immediately after the initial address message has been sent, except in those cases where conditions on the outgoing circuit prevent it (see § D.2.1.9).

f) *Network protection timer*

When the originating exchange or the controlling exchange has sent the initial address message the awaiting address complete timer (T7) is started. If timer (T7) expires, the connection is released and an indication is returned to the calling subscriber.

D.2.1.1.2 *Actions required at an intermediate exchange*

a) *Circuit selection*

An intermediate exchange, on receipt of an initial address message, will analyze the called party number and the other routing information [(see D.2.1.1.1 a)] to determine the routing of the call. If the intermediate exchange can route the call using the connection type specified in the transmission medium requirement parameter, a free inter-exchange circuit is seized and an initial address message is sent to the succeeding exchange. ~~Within a network, if the intermediate exchange does not route the call using just the connection type specified in the transmission medium requirement parameter, the exchange may also examine the user service information containing the bearer capability information (if available) to determine if a suitable route can be selected. In this case, if a new connection type is provided, the transmission medium requirement parameter is modified to the new connection type.~~

For calls between networks, the gateway exchange (e.g. outgoing ISC) must ensure that the transmission medium requirement parameter is set according to the service requested by the customer (see Recommendation E.172). More specifically, this parameter is carried unchanged within the international network.

When no echo suppressor or nature-of-circuit indication is received from a preceding exchange using a signalling system with fewer facilities, the indicators will be considered as received "no" unless positive knowledge is available.

b) *Parameters in the initial address message*

An intermediate exchange may modify signalling information received from the preceding exchange according to the capabilities used on the outgoing route. Signalling information that may be changed is nature of connection indicator, ~~end-to-end method indicator~~; the most significant digits in the called party number may be amended or omitted [see § D.2.1.1.1 b)]. ~~A change of the end-to-end method used may also alter parameters (see § D.3).~~ Other signalling information is passed on transparently, e.g. the access transport parameter, user service information, etc.

c) *Completion of transmission path*

Through-connection of the transmission path in both directions will be completed at an intermediate exchange immediately after the initial address message has been sent, except in those cases where conditions on the outgoing circuit prevent it (see § D.2.1.9).

D.2.1.1.3 *Actions required at the destination exchange*

a) *Selection of called party*

Upon receipt of an initial address message, the destination exchange will analyze the called party number to determine to which party the call should be connected. It will also check the called party's line condition and perform various checks to verify whether or not the connection is allowed. These checks will include correspondence of compatibility checks, e.g. checks associated with supplementary services.

~~At this point, certain call set-up information may need to be obtained from an originating or controlling exchange (see § D.2.1.6). Examination of the protocol control indicator will show whether end-to-end information is necessary to be obtained before further processing of the call, in this case the SCCP, pass along or information request and information messages can be used.~~

In this case where the connection is allowed, the destination exchange will set up a connection to the called party. If a continuity check has to be performed on one or more of the circuits involved in a connection, setting up of the connection to the called party must be prevented until the continuity of such circuits has been verified.

D.2.1.2 *Forward address signalling — Overlap operation*

D.2.1.2.1 *Actions required at originating exchange*

a) *Circuit selection*

When the originating exchange has received sufficient information [see § D.2.1.2.1 c)] from the calling party to determine that the call is to be routed to another exchange, selection of a suitable, free, inter-exchange circuit takes place and an initial address message is sent to the succeeding exchange.

Appropriate routing information is either stored at the originating exchange or at a remote database to which a request may be made.

The selection of the route will depend on the called party number, connection type required and the network signalling capability required. This selection process may be performed at the exchange or with the assistance of a remote database.

In addition, in the case of a subscriber with digital access, the set-up message contains bearer capability information which is analyzed by the originating exchange to determine the correct connection type and network signalling capability. The bearer capability information will be mapped into the user service information parameter of the initial address message. The information received from the access interface is used to set the value of the transmission medium requirement parameter. ~~The first value of bearer information received will be used to set the initial mode of the connection.~~

The connection types allowed are:

- speech;
- 3.1 kHz audio;
- 64 kbit/s unrestricted;
- ~~= alternate speech/64 kbit/s unrestricted;~~
- ~~= alternate 64 kbit/s unrestricted/speech.~~

The network signalling capabilities allowed are:

- ISDN-UP preferred;
- ISDN-UP required;
- ISDN-UP not required (any signalling system).

The information used to determine the routing of the call by the originating exchange will be included in the IAM (as transmission medium requirement and forward call indicators), to enable correct routing at intermediate exchanges. The IAM conveys implicitly the meaning that the indicated circuit has been seized.

~~In the case where $N \times 64$ kbit/s ($N \geq 2$) connections are required, the procedures for a single 64 kbit/s connection may be used if the $N \times 64$ kbit/s are contiguous 64 kbit/s channels and are pre-assigned for $N \times 64$ kbit/s use.~~

If subaddress information is received from the calling access, this information is passed unchanged to the destination exchange in the access transport parameter of the initial address message only.

b) *Address information sending sequence*

The sending sequence of address information on international calls will be the country code (not sent to an incoming international exchange) followed by the national (significant) number. ~~On national connections, the address information may be the local number or the national (significant) number as required by the Administration concerned.~~ For calls to international operator positions (Code 11 and Code 12), refer to Recommendation Q.107.

The end-of-pulsing (ST) signal will be used whenever the originating exchange or the outgoing exchange is in a position to know by digit analysis that the final digit has been sent.

c) *Content of initial and subsequent address messages*

The initial and subsequent address messages in principle contain all of the information that is required to route the call to the destination exchange and connect the call to the called party. The contents of the initial address message is the same as described in § D.2.1.1.1 c). The only purpose of the subsequent address message is to carry further digits.

All digits required for routing the call through the international network will be sent in the IAM. On calls with a country code in the number (except in the case of calls to special operators), the IAM will contain a minimum of 4 digits and should contain as many digits as are available. ~~Within national networks the address information contained within the IAM may vary depending on the routing requirement within the network.~~

The remaining digits of the number may be sent in subsequent address messages containing one or several digits as they are received. Efficiency can be gained by grouping together as many digits as possible. However, to prevent an increase in postsending delay in those cases where overlap operation with subscribers' dialling is used, it may be desirable to send the last few digits individually.

The end-of-pulsing (ST) signal is always sent in the following situations:

- i) semi-automatic calls;
- ii) test calls; and
- iii) when the end-of-pulsing (ST) signal is received.

In automatic working, the end-of-pulsing (ST) signal will be sent whenever the originating or outgoing exchange is in a position to know, by digit analysis, that the final digit has been sent. Digit analysis may consist of an examination of the country code and counting the maximum (or fixed) number of digits of the national number. In other cases, the end-of-pulsing signal is not sent and the end-of-address information is determined by the receipt of the address complete message or connect message from the incoming exchange.

d) *Transfer of information not included in the initial address message*

This section is not applicable to the international interface.

e) *Completion of transmission path*

Through-connection of the transmission path in the backward direction (the transmission path is completed in the forward direction on receipt of connect or answer message) at the originating exchange will be completed except in the cases where conditions on the outgoing circuit prevent it (see § D.2.1.9):

- i) immediately after the sending of the initial address message; or
- ii) when digit analysis or timer (T10), or receipt of the address complete message indicates that all digits have been received.

It is also acceptable that on speech or 3.1 kHz audio calls, through-connection of the transmission path will be completed in both directions immediately after the initial address message has been sent, except in the cases where conditions on the outgoing circuit prevent it (see § D.2.1.9).

f) *Network protection timer*

Each time when the originating exchange has sent an address message, the awaiting address complete timer (T7) is started. If timer (T7) expires, the connection is released and an indication is sent to the calling subscriber.

D.2.1.2.2 *Actions required at an intermediate exchange*

a) *Circuit selection*

An intermediate exchange, on receipt of an IAM, will analyze the digits available and the other routing information [see § D.2.1.2.1 a)] to determine the routing of the call. If the intermediate exchange can route the call using the connection type specified in the transmission medium requirement parameter, a suitable free inter-exchange circuit is seized and an IAM is sent to the succeeding exchange. If the number of digits in the called party number are not sufficient to route the call, the routing will be carried out when the intermediate exchange has received additional digits in subsequent address message(s). Any address digits received in subsequent address messages during the circuit selection process may be included in this IAM. Any subsequent address messages received after the IAM has been sent are forwarded to the succeeding exchange as subsequent address message(s).

~~Within the network, if the intermediate exchange does not route the call just using the connection type specified in the transmission medium requirement parameter, the exchange may also examine the user service information containing the bearer capability information (if available) to determine if a suitable route can be selected. In this case the transmission medium requirement parameter is modified to the new connection type.~~

For calls between networks, the gateway exchange (e.g. outgoing ISC) must ensure that the transmission medium requirement parameter is set according to the service requested by the customer (see Recommendation E.172). More specifically, this parameter is carried unchanged within the international network.

When no echo suppressor or nature-of-circuit indication is received from a preceding exchange using a signalling system with fewer facilities, the indicators will be considered as received "no" unless positive knowledge is available.

Selection of the outgoing national circuit normally can start at an incoming international exchange on receipt of the IAM and signalling can proceed on the first national link.

b) *Parameters in the initial address message*

An intermediate exchange may modify signalling information received from the preceding exchange according to the capabilities used on the outgoing route. Signalling information that may be changed is nature of connection indicator, ~~end-to-end method indicator~~; the most significant digits in the called party number may be amended or omitted [see § D.2.1.1.1 b)]. ~~A change of the end-to-end method used may also alter parameters (see § D.3).~~ Other signalling information is passed on transparently, e.g. the access transport parameter, user service information, etc.

c) *Completion of transmission path*

Through-connection of the transmission path in both directions will be completed at an intermediate exchange immediately after the initial address message has been sent, except in those cases where conditions on the outgoing circuit prevent it (see § D.2.1.9).

D.2.1.2.3 *Actions required at the destination exchange*

a) *Selection of called party*

Upon the receipt of the sufficient called party number information, the destination exchange will analyze the called party number to determine to which party the call should be connected. It will also check the called party's line condition and perform various checks, to verify whether or not the connection is allowed. These checks will include correspondence of compatibility checks, e.g. checks associated with supplementary services.

~~At this point, certain call set-up information may need to be obtained from an originating or controlling exchange (see § D.2.1.6). Examination of the protocol control indicator will show whether end-to-end information is necessary to be obtained before further processing of the call, in this case the SCCP, pass-along or information request and information messages can be used.~~

In the case where the connection is allowed, the destination exchange will set up a connection to the called party. If a continuity check has to be performed on one or more of the circuits involved in a connection, setting up of the connection to the called party must be prevented until the continuity of such circuits has been verified.

D.2.1.3 *Calling party number*

THE CALLING PARTY NUMBER CAN ONLY BE INCLUDED IN THE INITIAL ADDRESS MESSAGE [SEE §§ D.2.1.1.1 c) AND D.2.1.2.1 c)].

D.2.1.4 *Address complete message, connect message and call progress message*

D.2.1.4.1 *Return of address complete message from destination exchange*

An address complete message will be sent from the destination exchange as soon as it has been determined that the complete called party number has been received, or an indication received from the called party that an inband tone is being connected (for this case see §§ D.2.1.5 and D.2.2.4). However, there is no direct mapping from alerting, received from the access signalling system, to address complete in the network. In the case that the continuity check is performed, the destination exchange will withhold sending the address complete message until a successful continuity indication has been received (see § D.2.1.9).

Address complete is sent from the destination exchange in the following conditions:

- 1) In the case where the terminating access is non ISDN, the following action takes place at the destination exchange:
 - a) In all cases an address complete message is sent as soon as it has been determined that the complete called party number has been received, and the destination exchange established that the subscriber is free. Indicators in the address complete message will be set to indicate:
 - call line status: "Subscriber free";
 - ISDN access indicator: "Non ISDN".
 - b) In the case of a PBX, an address complete message is sent as soon as it has been determined that the called party number has been received. Indicators in the address complete message will be set to indicate:
 - called line status: "No indication";
 - ISDN access indicator: "Non ISDN".
- 2) In the case where the terminating access is ISDN, the following conditions can apply:
 - a) If an indication that the address is complete or no status indication has been received from the ISDN access prior to the destination exchange determining that the complete called party number has been received, the indicators in the address complete message will be set as follows:
 - called line status: "No indication";
 - ISDN access indicator: "ISDN".

Note In case a) the indication that the destination user is being alerted is transferred in a call progress message (see § D.2.1.5).
 - b) The destination exchange concludes from the receipt of an indication from the ISDN access that the complete called party number has been received. In this case the indicators in the address complete message will be set as follows:
 - called line status: "Subscriber free";
 - ISDN access indicator: "ISDN".

D.2.1.4.2 *Return of connect message from the destination exchange*

If a connect indication is received from the ISDN access under the following conditions:

- no alerting indication received from the ISDN access; and
- an address complete message has not yet been sent by the destination exchange,

a connect message is sent by the destination exchange. This connect message signifies both address complete and answer conditions.

Indicators in the connect message will indicate:

- called line status: "Subscriber free";
- ISDN access indicator: "ISDN".

The destination exchange will through-connect before the connect message is sent.

D.2.1.4.3 *Receipt of address complete message or connect message at an intermediate exchange*

Upon receipt of an address complete message, an intermediate exchange will send the corresponding address complete message to the preceding exchange. If a connect message is received at an intermediate exchange instead of an address complete message, a connect message will be sent to the preceding exchange.

D.2.1.4.4 *Receipt of address complete message or the connect message at the originating exchange*

- a) When the originating exchange receives an address complete message, the appropriate exchange functions take place.
- b) On receipt of an address complete message with the called line status indicator set to "subscriber free", an alerting indication is passed to the calling party if possible.
- c) On receipt of the address complete message, the awaiting address complete timer (T7) is stopped and the awaiting answer timer (T9) is started. If timer (T9) expires, the connection is released and an indication is sent to the calling subscriber.
- d) If the connect message is received, then the appropriate exchange functions take place. The awaiting address complete timer (T7) is stopped (see § D.2.1.7.2).

D.2.1.4.5 *Through-connection and awaiting answer indication at the destination exchange*

The sending of the awaiting answer indication (e.g. ring tone) at the destination exchange depends on the type of call. On speech and 3.1 kHz calls and call to an analogue called party, the awaiting answer indication is applied to the transmission path to the calling party from the destination exchange on receipt of an alerting indication from the called party or from information contained within the destination exchange that the called party will not or is prohibited from providing inband tone.

Regardless of whether tones are to be provided or not, the destination exchange will through-connect after the reception of the connection indication from the called party and before sending the answer/connect message to the preceding exchange.

If the destination exchange does not send the awaiting answer indication because the destination user provides for the sending of tones, then the destination exchange will through-connect the transmission path in the backward direction on receipt of the progress indication.

The complete through-connection of the transmission path at answer is covered in § D.2.1.7.

D.2.1.4.6 *Address complete message with charging information*

The address complete message carries a charge indicator.

D.2.1.4.7 *Address complete message with other information*

Additional information can be included in the address complete messages (e.g. related to supplementary services, see Annex E).

D.2.1.4.8 *Return of address complete message in interworking situations*

An address complete message will not be sent until the cross-office check is made, if applicable (see § D.2.1.10).

If the succeeding network does not provide electrical called-party's-line-condition indications, the last Signalling System No. 7 exchange shall originate and send an address complete message when the end of address signalling has been determined:

- a) by receipt of an end-of-pulsing (ST) signal; or
- b) by receipt of the maximum number of digits used in the national numbering plan; or
- c) by analysis of the national (significant) number to indicate that a sufficient number of digits has been received to route the call to the called party; or
- d) by receipt of an end-of-selection signal from the succeeding network (e.g. number received signal in Signalling System No. 5); or
- e) exceptionally, in the succeeding network uses overlap signalling and number analysis is not possible, by observing that timer (T10) has elapsed since the last digit was received, and that no fresh information has been received; in such circumstances, transmission to the national network of the last digit received must be prevented until the end of the waiting period which causes an address complete message to be sent backward. In this way, it is ensured that no national answer signal can arrive before an address complete message has been sent.

If in normal operation, a delay in the receipt of an address complete signal from the succeeding network is expected, the last common channel signalling exchange will originate and send an address complete message 15 to 20 seconds [(timer (T11))] after receiving the latest address message. The time-out condition is an upper limit considering the clauses of § D.2.9.10.3 (20 to 30 seconds waiting for address complete message timer (T7) for outgoing international exchanges in abnormal release conditions).

D.2.1.4.9 *Return of sub-address information in address complete message, connect message or call progress message*

IF SUB-ADDRESS INFORMATION IS RECEIVED FROM THE CALLED ACCESS, THIS INFORMATION IS PASSED UNCHANGED TO THE ORIGINATING EXCHANGE IN THE ACCESS TRANSPORT PARAMETER OF THE ANSWER MESSAGE, OR CONNECT MESSAGE.

D.2.1.5 *Call progress*

The call progress message is sent (*ONLY AFTER THE ADDRESS COMPLETE MESSAGE*) from an exchange in the backward direction indicating that an event has occurred during call set-up which should be relayed to the calling party.

D.2.1.5.1 *Return of call progress message from the destination exchange*

The call progress message is sent from the destination exchange if the address complete message has been sent and subsequently:

- an indication is received that the called party is being alerted,
the call progress message contains an event indicator that is set to "alerting";
- a progress indication is received from the called party,
the call progress message contains an event indicator that is set to "progress".

If the indication received from the called party contains a "progress indication", this is carried by the call progress message in the access transport parameter (transported unchanged across the public network).

The destination exchange may, on receipt of the indication from the called party that contains an appropriate progress indicator, through-connect the speech path (see § D.2.1.4.5).

In the case of call failure and the connection of a tone or announcement being returned before the address complete message has been returned, see (§ D.2.2.4).

D.2.1.5.2 *Action at an intermediate exchange*

On receipt of a call progress message an intermediate exchange will send the corresponding call progress message to the preceding exchange.

D.2.1.5.3 *Actions at the originating exchange*

On receipt of a call progress message at the originating exchange, no state change occurs (i.e. ~~the awaiting address complete~~ or the awaiting answer timer *IS* not stopped), and the appropriate indication is sent to the calling user. If the call progress message contained information carried in the access transport parameter, it is transferred unaltered into the indication returned to the calling user.

D.2.1.6 *Information messages*

This section is not applicable to the international interface.

D.2.1.7 *Answer message*

The called party may also provide its own subaddress to complement the connected line identification as provided in the COL service. This subaddress is transported from the destination to the originating exchange, in the ANM or CON. Connected line subaddress information is conveyed in the ATP parameter in the ANM or CON.

D.2.1.7.1 *Return of answer message from destination exchange*

When the called party answers, the destination exchange connects through the transmission path and the ringing tone is removed if applicable. An answer message to the preceding exchange is sent. If the destination exchange is the exchange controlling charging, then charging may begin.

D.2.1.7.2 *Receipt of answer message at intermediate exchange*

Upon receipt of an answer message, an intermediate exchange sends the corresponding answer message to the preceding exchange and, if this is the exchange controlling charging, charging may begin, and timer (T9) is stopped.

D.2.1.7.3 *Receipt of answer message at originating exchange*

When the originating exchange receives an answer message indicating the required connection has been completed, the transmission path is connected-through in the forward direction, if not already connected. The awaiting answer timer (T9) is stopped. If the originating exchange is the exchange controlling charging, charging may begin if applicable. The calling party is informed.

D.2.1.7.4 *Return of answer from automatic terminals*

When connections are set up to terminals having an automatic answer feature, the alerting indication may not be received from the called party. If a destination exchange receives an answer indication, an answer message is sent provided that an address complete message has been sent, otherwise the connect message is sent.

D.2.1.7.5 *Answer with charging information*

The answer message received from the destination exchange or from a succeeding network carries a charge indicator.

D.2.1.8 *Continuity-check*

Because the signalling in Signalling System No. 7 does not pass over the circuit, facilities should be provided for making a continuity-check of the circuit in the circumstances described below.

The application of the continuity-check depends on the type of the transmission system used for the circuit.

For transmission systems having some inherent fault indication features giving an indication to the switching system in case of fault, a continuity-check is not required. However, a per call continuity-check may be needed on fully digital circuits when circuits or bundles of circuits in primary multiplex groups are dropped and inserted en route between switches, and alarm indications carried on bits of the primary multiplex frame structure are lost in passing through an intermediate transmission facility that does not relay them transparently. Typical, per call continuity-checks may be needed when the transmission link between switches contains a TDMA satellite system, a digital circuit multiplication system or a digital access and cross-connection system, where fault indications are lost (see Recommendation Q.33).

When an initial address message is received with a request for a continuity-check (either on this circuit or on a previous circuit), timer T8 is started. On receipt of a continuity message, timer T8 is stopped.

If timer T8 expires, the connection is cleared.

If an indication of continuity check failure is received in a continuity message, timer T27 is started awaiting a continuity re-check request. Also the connection to the succeeding exchange, if any, is cleared. Timer T27 is stopped when the continuity re-check message is received and timer T36 is started awaiting a continuity or a release message.

If either timer T27 or timer T36 expires, a reset circuit message is sent to the preceding exchange. On reception of the release complete message, the circuit is set to idle.

When an initial address message is received with a request for a continuity-check relating to a digital circuit having inherent fault indication, one of the following actions is taken, either:

- a) the continuity-check request is disregarded; or
- b) a continuity-check loop is connected and the maintenance system is alerted. In this case the call may fail since no continuity signal may be received from the distant end.

Note — The reception of such a request could only be caused by an abnormal condition such as administrative errors or the occurrence of signalling errors.

WHEN THE CIRCUIT TYPE IS UNKNOWN TO AN SS No. 7 EXCHANGE, OR IN AN APPLICATION WHERE BOTH ANALOGUE AND DIGITAL CIRCUITS MAY BE SERVED OR WHEN NO FAULT INDICATION ACCORDING TO RECOMMENDATION Q.33 IS AVAILABLE, A CONTINUITY-CHECK LOOP SHOULD ALWAYS BE CONNECTED IN THE FOLLOWING CASE:

- i) *WHEN INITIAL ADDRESS MESSAGES WITH A CONTINUITY-CHECK REQUEST INDICATION ARE RECEIVED;*
- ii) when continuity-check request messages are received.

Means should be provided in S.S. No. 7 to detect circuit identification code misunderstandings between S.S. No. 7 exchanges.

For exchanges having both analogue and digital circuits served by S.S. No. 7, the continuity-check initiated by a continuity-check request message could be used to test for proper alignment of circuit code identities. On those exchanges, reception of a continuity-check request message should always cause a loop to be attached to the circuit.

Alternative methods for detection of circuit identity misunderstandings in exchanges with all digital circuits may be employed.

The continuity-check is not intended to eliminate the need for routine testing of the transmission path.

The continuity check of the circuit will be done, link-by-link, on a per call basis or by a statistical method prior to the commencement of conversation. Procedures and requirements are specified in Recommendation Q.724, § 7.

~~The actions to be taken when pilot supervision used are describe in Recommendation Q.724, § 9.~~

D.2.1.9 *Special procedures at an interworking point*

D.2.1.9.1 *Completion of transmission path at an interworking exchange*

In general, completion of the transmission path at an interworking point should occur as soon as possible during the call set-up phase. The actual point of switch-through will vary depending on the interworking signalling system, e.g. whether inband or outband signalling is used or whether a continuity-check procedure is applied.

When interworking with other internationally specified signalling systems, the following rules on switch-through should be applied:

S.S. No. 7 → S.S. No. 7	When no continuity-check is to be made on the outgoing circuit, through-connection should occur after sending the initial address message. When continuity-check is to be made on the outgoing circuit, through-connection should occur after residual check tone has propagated through the return path of the circuit (see Recommendation Q.724, § 7.3).
S.S. No. 6 → S.S. No. 7 S.S. No. 5 → S.S. No. 7 R1 → S.S. No. 7 S.S. No. 7 → S.S. No. 6	When no continuity-check is to be made on the outgoing circuit, through-connection can occur after sending the initial address message. When continuity-check is to be made on the outgoing circuit, through-connection can occur after residual check tone has propagated through the return path of the circuit (see Recommendation Q.724, § 7.3).
R2 → S.S. No. 7	Through-connection should occur after receipt of address complete.
S.S. No. 7 → S.S. No. 5 S.S. No. 7 → R1	Through-connection can occur after sending ST (end-of-pulsing) signal and removal of possible check loop.
S.S. No. 7 → R2	Through-connection should occur after sending of address complete.

When a continuity-check is made on the outgoing circuit, and early connection is made, there is a possibility that the calling party has its go and return paths temporarily looped (from the instant of through-connection to the instant of loop removal of the incoming end of the circuit). This problem can be prevented by using the optional single report continuity-check procedure given in Recommendation Q.724, § 7.3.

D.2.1.9.2 *Alerting of called party*

If in an interworking situation a continuity-check has to be performed on one or more of the circuits involved in the connection preceding the interworking point, appropriate measures must be taken to prevent alerting of the called party until the continuity of such circuits has been verified. Interworking situations which could be discriminated are:

- a) S.S. No. 7 → any non No. 7 signalling system;
- b) International S.S. No. 7 → national S.S. No. 7 not performing continuity-check.

For a), the last digit(s) of the national number have to be withheld in any (interworking) transit exchange or terminating exchange in case of DDI (direct dialling in) or the alerting of the called party is postponed in the terminating exchange in case of non DDI.

For b), either the last digit(s) of the national number are withheld in the incoming international transit exchange, a transit exchange in the national network or the terminating exchange in case of DDI (direct dialling in) or the setting up of the connection to the called party is postponed in the terminating exchange in case of non DDI.

D.2.1.10 *Cross-office check*

For digital exchanges, the requirements mentioned in Recommendation Q.543 shall be met. For other exchanges, Administrations shall ensure the reliability of a connection through a switching machine (cross-office check) either on a per call basis or by a statistical method. With either method, the probability of the connection being established with an unacceptable transmission quality should not exceed 0.00001 as the long-term average.

D.2.1.11 *Charging procedures*

D.2.1.11.1 *Basic call charging*

Charging will normally begin when the exchange(s) controlling charging receives the answer or connect message from the network. Optionally, an Administration may wish to begin charging prior to the receipt of the answer or connect message for national and/or international calls.

D.2.1.11.2 *Network charging messages (national option)*

This section is not applicable to the international interface.

D.2.1.12 *Forward transfer message*

The forward transfer message may be sent in telephony semi-automatic working in either of the following two cases:

- a) Following a call switched automatically to a subscriber, or following a call established via a special operator, the controlling operator wishes to call in an assistance operator. On receipt of the forward transfer message at the incoming international exchange, an assistance operator is called in.
- b) Following a call via codes 11 and 12, the controlling operator wishes to recall the incoming international exchange. Receipt of the forward transfer message at the incoming international exchange recalls the incoming operator on calls completed via the operator positions at the exchange.

Note — Procedures are not supported by all network operators.

D.2.1.13 *Transit network selection (national option)*

This section is not applicable to the international interface.

D.2.2 *Unsuccessful call set-up*

If at any time in the call set-up the connection cannot be completed, a release message is returned. This message contains the reason.

D.2.2.1 *Actions at exchange initiating a release message*

The initiating exchange immediately starts the release of the switched path (if established). *THE EXCHANGE SENDS A RELEASE MESSAGE TO THE PRECEDING EXCHANGE AND TIMERS T1 AND T5 ARE STARTED TO ENSURE THAT A RELEASE COMPLETE MESSAGE IS RECEIVED FROM THE PRECEDING EXCHANGE WITHIN TIME T1 (EXPIRATION OF TIMERS T1 AND T5 IS COVERED IN § D.2.10.6).*

D.2.2.2 *Actions at intermediate exchange*

On receipt of a release message from the succeeding exchange, an intermediate exchange:

- i) immediately starts the release of the switched path; when the circuit is reselectable, a release complete message is returned to the succeeding exchange;
- ii) at the same time as the start of the release of the switched path, a release message is sent to the preceding exchange.

TIMERS T1 AND T5 ARE STARTED TO ENSURE THAT A RELEASE COMPLETE MESSAGE IS RECEIVED FROM THE PRECEDING EXCHANGE (EXPIRATION OF TIMERS T1 AND T5 IS COVERED IN § D.2.10.6).

D.2.2.3 *Actions at the controlling exchange (i.e. the exchange controlling the call)*

On receipt of a release message from the succeeding exchange, the controlling exchange starts the release of the switched path.

In addition, the controlling exchange will (if applicable):

- a) return an indication (in-band or out-band) to the calling party (see § D.2.2.4); or
- b) attempt to re-route the call set-up; or
- c) initiate release procedures to the preceding exchange (as described in § D.2.2.4).

In case a) above an indication is carried in the call progress message or address complete message indicating in-band information is available (see § D.2.2.4).

When the controlling exchange is ready for circuit re-selection, a release complete message is sent to the succeeding exchange.

D.2.2.4 *Tones and announcements*

If a call set-up fails and an in-band tone or announcement has to be returned to the calling party from an exchange or called party, the exchange or user concerned connects the in-band tone to the transmission path.

If an address complete message has been returned to the preceding exchange, a call progress message indicating that in-band tone information is available is returned to the preceding exchange (see § D.2.1.5).

If an address complete message has not been returned to the preceding exchange already, an address complete message, with the appropriate cause parameter and the "in-band information" indicator set in the optional backward call indicator, will be returned to the originating exchange.

D.2.2.5 *Address Incomplete*

The determination that proper number of digits has not been received can be made at once if the end-of-pulsing signal is received.

When overlap working is used and the end of pulsing has not been received, the release message with cause 28 (address incomplete) will be sent 15-20 seconds (T35) after receipt of the last digit and before receipt of the minimum or fixed number of digits for forward routing of the call.

D.2.3 Normal call release

The release procedures are based on a two-message (release, release complete) approach whereby the release message initiates release of the circuit switched connection.

The same procedures are used in the network irrespective of whether they are initiated by the calling party, the called party or the network. The normal release procedure can be prevented by the network if this is required on a particular call (see § D.2.6).

To satisfy the need for rapid transfer of release across the network, it is required that the circuit is selectable from the subsequent exchange within the mean cross-office transfer time, T_{cu} , for simple messages as specified in Recommendation Q.766.

D.2.3.1 Release initiated by a calling party

a) Actions at the originating exchange

On receipt of a request to release the call from the calling party, the originating exchange immediately starts the release of the switched path. A *RELEASE MESSAGE TO THE SUCCEEDING EXCHANGE AND TIMERS $T1$ AND $T5$ ARE STARTED TO ENSURE THAT A RELEASE COMPLETE MESSAGE IS RECEIVED FROM THE SUCCEEDING EXCHANGE WITHIN TIME $T1$ (EXPIRATION OF TIMERS $T1$ AND $T5$ IS COVERED IN § D.2.10.6).*

b) Actions at an intermediate exchange

On receipt of a release message from the preceding exchange, an intermediate exchange:

- i) immediately starts the release of the switched path; when the circuit is reselectable, a release complete message is returned to the preceding exchange;
- ii) at the same time as the start of the release of the switched path, sends a release message to the succeeding exchange. *TIMERS $T1$ AND $T5$ ARE STARTED TO ENSURE THAT A RELEASE COMPLETE MESSAGE IS RECEIVED FROM THE SUCCEEDING EXCHANGE (EXPIRATION OF TIMERS $T1$ AND $T5$ IS COVERED IN § D.2.10.6.)*

c) Actions at the destination exchange

On receipt of a release message from the preceding exchange, the destination exchange will start the release of the switched path.

When the circuit is ready for reselection, a release complete message is returned to the preceding exchange.

d) Charging

This section is not applicable to the international interface.

e) Collision of release messages

In the case when two points in the connection both initiate the release of a call, a release message may be received at an exchange from a succeeding or preceding exchange after the release of the switched path is initiated. In this case, the exchange will return a release complete message to the exchange from which the concerned release message was received. The release complete message will be sent when the circuit is ready for re-selection.

D.2.3.2 *Release initiated by a called party*

The procedures in § D.2.3.1 apply, except that the functions at the originating and destination exchanges are transposed.

D.2.3.3 *Release initiated by the network*

The procedures in § D.2.3.1 apply, except that they can be initiated at any exchange (originating, destination or intermediate).

D.2.3.4 *Storage and release of IAM information*

Each exchange of the connection shall store during the call set-up the information contained in the initial address message sent (the originating exchange) or received (intermediate or destination exchange). The information to be stored includes all parameters in the IAM. The contents of the IAM information shall be updated, if the value of parameters change during the call set-up.

The IAM information can be released from memory:

- a) in the originating exchange when the address complete message or connect message has been received and the calling party does not subscribe to a supplementary service which would cause a new call set-up (e.g. call transfer). The release of the information when the calling party does subscribe to a supplementary service is covered in Annex E;
- b) in the intermediate exchange when the address complete message or the connect message has been received;
- c) in the destination exchange when the address complete message or connect message has been sent and the called party does not subscribe to a supplementary service which would cause a new call set-up (e.g. call transfer). The release of the information when the called party does subscribe to a supplementary service is covered in Annex E, and when the call is released earlier and no automatic repeat attempt is to be attempted.

D.2.4 *Transfer of user-to-user information*

D.2.4.1 *Requirements for transfer of user-to-user data*

See Annex E.

D.2.5 *Suspend, resume*

D.2.5.1 *Suspend*

The suspend message indicates a temporary cessation of communication without releasing the call. It can only be accepted during the conversation/data phase. A suspend message can be either generated in response to a suspend request from the calling/called party or generated by the network in response to a clearback indication from an interworking node or an on-hook condition from an analogue called (telephone) party.

D.2.5.1.1 *Suspend initiated by a calling party*

A suspend message is generated in response to a suspend request or notification from a calling party. The suspend request controlling exchange is within the network of the suspend initiating user.

a) *Actions at originating exchange*

On receipt of a suspend request or notification from the calling party, the originating exchange sends a suspend message to the succeeding exchange.

b) *Actions at an intermediate exchange*

On receipt of the suspend message from the preceding exchange, the intermediate exchange sends a suspend message to the succeeding exchange.

c) *Actions at destination exchange*

On receipt of the suspend message from the preceding exchange, the destination exchange informs the called party that a suspend has been requested.

d) *Actions at the suspend request controlling exchange*

On receipt of the suspend request from a user or the suspend message, the controlling exchange starts a timer (T2) to ensure that a resume request or resume message is received within timer (T2). If the timer (T2) expires, the procedures in § D.2.5.3 apply.

D.2.5.1.2 *Suspend initiated by a called party*

The procedures in § D.2.5.1.1 apply, except that the functions at the originating and destination exchanges are transposed.

The suspend request controlling exchange is within the network of the suspend initiating user.

D.2.5.1.3 *Suspend initiated by the network*

A suspend message can be generated by the network in response to a clearback indication from an interworking node or an on-hook condition from an analogue called party.

a) *Action at the terminating exchange (destination) or an interworking exchange*

On receipt of an on-hook condition in the terminating exchange or a clearback signal at the interworking exchange, the exchange may send a suspend (network) message to the preceding exchange.

b) *Action at the intermediate exchange*

On receipt of a suspend message, the exchange will send a suspend message to the preceding exchange.

c) *Action at the controlling exchange*

On receipt of the on-hook condition or clearback indication or suspend message, the controlling exchange starts a timer (T6) to ensure that an off-hook condition, a re-answer indication, a resume (network) message or a release message is received. The value of this timer (T6) is covered in Recommendation Q.118. If the timer (T6) expires, the procedures in § D.2.5.3 apply.

D.2.5.2 *Resume*

A resume message indicates a request to recommence communication. A request to release the call received from the calling or called party will override the suspend/resume sequence and the procedures given in § D.2.3 will be followed.

D.2.5.2.1 *Resume initiated by a calling party*

Having initiated a suspend condition, a calling party may request a reconnection within timer T2. The procedures in § D.2.5.1.1 items a), b) and c) apply, except that the resume message replaces the suspend message. On receipt of the resume message, the controlling exchange cancels the timer (T2).

D.2.5.2.2 *Resume initiated by a called party*

The procedures in § D.2.5.2.1 apply, except that the functions at the originating and destination exchange are transposed.

D.2.5.2.3 *Resume initiated by the network*

A resume message is initiated by the network, if a suspend message had previously been sent, in response to a re-answer indication from an interworking node or an off-hook condition from an analogue called party.

a) *Action at the terminating exchange or interworking exchange*

On receipt of a re-answer indication at the interworking exchange or an off-hook condition in the terminating exchange, the exchange may send a resume (network) message to the preceding exchange if a suspend (network) message had previously been sent.

b) *Actions of the intermediate exchange*

On receipt of a resume message, the exchange will send a resume message to the preceding exchange.

c) *Action of the controlling exchange (i.e. exchange controlling the call)*

On receipt of the off-hook condition, re-answer signal, release message or resume message the controlling exchange stops the timer (T6) [started in § D.2.5.1.3 c)].

D.2.5.3 *Expiration of timer (T2) or timer (T6)*

If a request for reconnection or a resume message is not received within timer (T2) or timer (T6) covered in Recommendation Q.118, then the controlling exchange will initiate the release procedure outlined in § D.2.3.3. Cause value #102 is used in the release message.

D.2.6 *Delayed release (national option)*

This section is not applicable to the international interface.

D.2.7 *In-call modification*

This section is not applicable to the international interface.

D.2.8 *Echo control procedure*

D.2.8.1 *General*

The echo control procedure is used on a per call basis to convey information between exchange nodes about the demand and ability to insert echo control devices.

The procedure is invoked when a call is to be routed on a connection for which echo control is necessary. It could be initiated at the originating exchange or at an intermediate exchange.

D.2.8.2 *Forward direction*

D.2.8.2.1 *Actions at the originating exchange*

If an originating exchange has sufficient information to determine that echo control is necessary for the outgoing circuit, then:

- an outgoing half echo control device is enabled; and
- the echo control device indicator of the nature of connection indicators parameter field in the IAM is set.

D.2.8.2.2 *Actions at an intermediate exchange*

If an intermediate exchange has sufficient information to determine that echo control is required for the outgoing circuit, then one of the following actions can occur:

- a) When the nature of connection indicators parameter field in the IAM indicates that an echo control device is already included:
 - no change to the nature of connection indicators parameter field in the IAM is made;
 - an incoming half echo control device is reserved; and
 - any outgoing half echo control device is disabled.
- b) When the nature of connection indicators parameters in the IAM does not indicate that an echo control device is already included:
 - an outgoing half echo control device is enabled; and
 - the echo control device indicator in the nature of connection indicators parameter field is set.

If the intermediate exchange has sufficient information to determine that echo control is not required for the outgoing circuit, then one of the following actions can occur:

- a) When the nature of connection indicators parameter field in the IAM indicates that an echo control device is already included:
 - no change to the nature of connection indicators parameter field in the IAM is made; and
 - an incoming half echo control device is reserved.
- b) When the nature of connection indicator parameter field in the IAM does not indicate that an echo control device is already included:
 - no additional action is required.

D.2.8.2.3 *Actions at the destination exchange*

See § D.2.8.3.1 below.

D.2.8.3 *Backward direction*

D.2.8.3.1 *Actions at the destination exchange*

Upon the receipt of an IAM with the indication "outgoing half echo control device included" in the nature of connection indicators parameter field, the following action is taken:

- an incoming half echo control device is enabled; and
- the echo control device indicator of the backward call indicators parameter field in the first backward message (i.e. ACM or connect ~~or call progress~~) is set.

If the destination exchange is unable to include an incoming half echo control device, the information is conveyed to the preceding exchange by an echo control device indicator in *THE BACKWARD CALL INDICATORS PARAMETER FIELD* in the first backward message.

D.2.8.3.2 *Actions at an intermediate exchange*

Upon receipt of the first backward message (i.e. ACM or connect ~~or call progress~~) in response to an IAM with echo control indication, then one of the following actions can occur:

- a) When the backward call indicators parameter field indicates that an incoming half echo control device is not already included:
 - the reserved incoming half echo control device is included; and
 - the echo control device indicator in the backward call indicators parameter field is set.
- b) When the backward call indicators parameter field indicates that an incoming half echo control device is already included:
 - the reserved incoming half echo control is released; and
 - no change to the backward call indicators parameter field in the backward message is made.

D.2.8.3.3 *Actions at the originating exchange*

No additional action is required.

D.2.9 *Network features*

D.2.9.1 *Automatic repeat attempt*

Automatic repeat attempt, as defined in Recommendation Q.12, is provided in Signalling System No. 7. An automatic repeat attempt will be made (up to the point when the initial address message information is released, see § D.2.3.4):

- i) on detection of dual seizure (at the non-control exchange) (see § D.2.10.1.4);
- ii) on receipt of the blocking message after sending an address message and before any backward message has been received (see § D.2.9.2);
- iii) on receipt of a reset circuit message after sending an address message and before a backward message has been received [see § D.2.10.3.1 e)];
- iv) on failure of continuity-check, when a continuity check is performed;
- v) on receipt of an unreasonable message during call set up (see § D.2.10.5).

D.2.9.2 *Blocking and unblocking of circuits and circuit groups*

The blocking (unblocking) message and the circuit group blocking (unblocking) message are provided to permit the switching equipment or maintenance system to remove from (and return to) traffic the distant terminal(s) of a circuit or group of circuits because of a fault or to permit testing.

Since the circuits served by the ISDN user part have both-way capability, the blocking message or circuit group blocking message can be originated by either exchange. The receipt of a blocking message or a circuit group blocking message will have the effect of prohibiting non test calls on the relevant circuit(s) outgoing from the exchange until an unblocking message or an appropriate circuit group unblocking message is received, but will not prohibit test calls incoming to that exchange. An acknowledgement sequence is always required for the blocking and unblocking message as well as for the circuit group blocking message and circuit group unblocking messages using the blocking acknowledgement message, the unblocking acknowledgement message, the appropriate circuit group blocking acknowledgement messages and the appropriate circuit group unblocking acknowledgement message respectively. The acknowledgement is not sent until the appropriate action – either blocking or unblocking – has been taken. The release message should not override a blocking message and return circuits to service which might be faulty. The blocked circuit(s) will be returned to service on transmission of the unblocking acknowledgement message or the appropriate circuit group unblocking acknowledgement message at one exchange and on receipt of the unblocking acknowledgement message or the appropriate circuit group unblocking acknowledgement message at the other exchange.

D.2.9.2.1 *Other actions on receipt of a blocking message*

In the event of a blocking message being received, after an initial address message has been sent in the opposite direction on that circuit, and before a backward message relating to that call has been received, an automatic repeat attempt will be made on another circuit. The exchange receiving the blocking message releases the original call attempt in the normal manner after sending the blocking acknowledgement message and will not seize that circuit for subsequent calls.

If the blocking message is received:

- after an initial address message has been sent for that circuit in the opposite direction and after at least one backward message relating to that call has been received; or
- after an initial address message has been received for that circuit beforehand, the exchange will not seize that circuit for subsequent calls.

The fact that the circuit is engaged on a call will not delay transmission of the blocking (unblocking) acknowledgement message.

If a blocking message is sent and subsequently an initial address message is received in the opposite direction, the following action is taken:

- for test calls, the call should be accepted, if possible. In the case where the test call cannot be accepted, the blocking message must be returned;
- for calls other than test calls, the blocking message must be returned and the initial address message discarded.

When a circuit is blocked by use of the blocking message, the maintenance system should be informed at both ends of the circuit.

D.2.9.2.2 *Circuit group blocking and unblocking messages*

The following circuit group blocking (unblocking) messages and their corresponding acknowledgement messages are provided:

- maintenance oriented circuit group blocking (unblocking) message;
- hardware failure oriented circuit group blocking (unblocking) message.

The circuits to be blocked (unblocked) are indicated in the status field.

The maximum number of circuits to be blocked (unblocked) with one circuit group blocking (unblocking) message is limited to 32.

A received circuit group blocking (unblocking) acknowledgement message has to match in the parameter value of the circuit identification code, the circuit group supervision message type indicator, and the range field (see Annex C) with the previously sent group blocking (unblocking) message in order to be considered a valid acknowledgement.

A circuit is controlled by the ISDN user part if it can be used by the ISDN user part as a circuit switched bearer. Hence, time slots in a digital path that are used for synchronisation (e.g. time slot 0 in a 2048 kbit/s digital path) or as signalling channels are not circuits whose control is allocated to the ISDN user part.

Some of the circuit identification code values covered by the range field of a circuit group blocking (unblocking acknowledgement) message may not be allocated to any circuit. Then the corresponding status bits in the status field are set to 0. This is not allowed for the circuit identification code values related to status bits being set to 1. Those circuit identification code values must always be allocated to circuits whose control is allocated to the ISDN user part. In particular, the circuit identification code value indicated in the label of a message must be allocated to a circuit.

The maintenance oriented circuit group blocking (unblocking) procedures set (remove) the same blocking states as the blocking (unblocking) procedures. This means that a blocking state set by a maintenance oriented circuit group blocking message or indicated as blocked for maintenance purposes in the status field of a circuit group reset acknowledgement message can be removed by an unblocking message. Similarly, a blocking state set by a blocking message can be removed by a maintenance oriented circuit group unblocking message.

The maintenance blocked state set by maintenance oriented circuit group blocking message, by a status indicator in a circuit group reset acknowledgement message or a blocking message cannot be removed by a hardware oriented circuit group unblocking message.

The range of circuits to be blocked (unblocked) is indicated in the range field. Those circuits within the range that have to be blocked (unblocked) are indicated in the status field. The same rule applies to the acknowledgements.

For the circuits blocked for maintenance reasons, the same conditions apply and the same actions have to be taken as described in § D.2.9.2.1.

For the circuits seized by ongoing calls or call attempts and blocked for reasons of hardware failure, the following actions will be taken:

- all interconnected circuits have to be released by the appropriate messages;
- the affected circuits are set to the condition "idle hardware blocked" without any exchange of release messages.

The fact that a circuit is engaged on a call will not delay the transmission of the corresponding circuit group blocking (unblocking) acknowledgement message.

The hardware blocked state can only be removed by a hardware failure oriented circuit group unblocking message.

For all instances of circuit group blocking, the maintenance system should be notified at both ends of the circuit(s).

D.2.9.2.3 *Abnormal blocking and circuit group blocking procedures*

The following procedures are designed to cover abnormal cases which may occur in the circuit group blocking/unblocking procedures.

- i) If a circuit group blocking message is received relating to remotely blocked circuits, then blocking acknowledgement indications for those circuits are given in the status field of the corresponding circuit group blocking acknowledgement message which will be sent in response.
- ii) If a circuit group unblocking message is received relating to circuits which are not in the state remotely blocked, then unblocking acknowledgement indications for those circuits are given in the status field of the corresponding circuit group unblocking acknowledgement message which will be sent in response.
- iii) When an exchange upon receipt of a circuit group blocking (unblocking) message is not able to give an appropriate blocking (unblocking) acknowledgement indication for each circuit identification code (e.g. because that/those circuit identification code(s) is(are) not allocated to any circuit at the receiving exchange) for which also a blocking (unblocking) indication is given in the status field of the received group blocking (unblocking) message, then no blocking (unblocking) acknowledgement indication relating to that/those circuit identification code(s) will be given in the status field of the corresponding circuit group blocking (unblocking) acknowledgement message which will be sent in response.
- iv) If a circuit group blocking acknowledgement message in response to a circuit group blocking message is received containing in the status field no blocking acknowledgement indications for the circuits which are to be blocked due to the previously sent circuit group blocking message, *THEN THE MAINTENANCE SYSTEM SHOULD BE NOTIFIED FOR THE CIRCUITS CONCERNED*. The same rule applies to the unblocking procedures.
- v) If a circuit group blocking acknowledgement message in response to a circuit group blocking message is received containing in the status field blocking acknowledgement indications for the circuits which are not to be blocked due to the previously sent circuit group blocking message and are not marked locally blocked, *THEN THE MAINTENANCE SYSTEM SHOULD BE NOTIFIED* for the circuits concerned.

- vi) If a circuit group unblocking acknowledgement message in response to a group unblocking message is received containing in the status field unblocking acknowledgement indications for circuits which are not to be unblocked due to the previously sent circuit group unblocking message and have to remain marked locally blocked, then *THE MAINTENANCE SYSTEM SHOULD BE NOTIFIED* for the circuits concerned.
- vii) If a circuit group blocking acknowledgment message which is not expected as an acknowledgement for any circuit group blocking message is received:
 - relating to circuits which all are in the status locally blocked the received circuit group blocking acknowledgement will be discarded,
 - relating to circuits *PART OR ALL OF WHICH ARE NOT IN THE STATUS LOCALLY BLOCKED, THEN THE MAINTENANCE SYSTEM SHOULD BE NOTIFIED.*
- viii) If a circuit group unblocking acknowledgement message which is not expected as an acknowledgement for any circuit group unblocking message is received:
 - relating to circuits none of which is in the status locally blocked, then the circuit group unblocking acknowledgement message will be discarded,
 - relating to circuits part or all of which are locally blocked, then *THE MAINTENANCE SYSTEM SHOULD BE NOTIFIED FOR THE CIRCUITS CONCERNED.*
- ix) If a circuit group blocking (unblocking) message or a circuit group blocking (unblocking) acknowledgement message refers to status changes for more than 32 circuits, the receiving exchange *SHALL* discard that message.
- x) If a blocking message is received for a blocked circuit, a blocking acknowledgement message will be sent.
- xi) If an unblocking message is received for an unblocked circuit, an unblocking acknowledgement message will be sent.
- xii) If a blocking acknowledgement message, which is not expected as an acknowledgement for a blocking message, is received:
 - relating to a circuit which is locally blocked, the blocking acknowledgement message is discarded,
 - relating to a circuit which is not locally blocked, then *THE MAINTENANCE SYSTEM SHOULD BE NOTIFIED.*
- xiii) If an unblocking acknowledgement message, which is not an expected response to an unblocking message, is received:
 - relating to a circuit which is not locally blocked, the received unblocking acknowledgement message is discarded,
 - relating to a circuit which is locally blocked, then *THE MAINTENANCE SYSTEM SHOULD BE NOTIFIED.*
- xiv) If a non test initial address message is received on a remotely blocked circuit, the remotely blocked state of the circuit is removed and the initial address message is processed normally unless the circuit is also locally blocked in which case the initial address message is discarded. This applies to the blocking state whether maintenance, hardware or both. However, it should not be the preferred method of unblocking a circuit.

D.2.9.3 *Circuit group query*

This section is not applicable to the international interface.

D.2.10 *Abnormal conditions*

D.2.10.1 *Dual seizure*

Because Signalling System No. 7 circuits have the capability of bothway operation, it is possible that the two exchanges will attempt to seize the same circuit at approximately the same time.

D.2.10.1.1 *Unguarded interval*

The exchange must detect dual seizure and take action as defined in § D.2.10.1.4.

D.2.10.1.2 *Detection of dual seizure*

A dual seizure is detected by an exchange from the fact that it receives an initial address message for a circuit for which it has sent an initial address message, but before it receives a valid backwards message.

D.2.10.1.3 *Preventive action*

Different methods for circuit selection can be envisaged to minimise the occurrence of dual seizure. In the following, two methods are described. Further study is required to determine the field of application of each method and to ensure that the two methods do inter-work satisfactorily.

Other methods for circuit selection may also be used provided that they give the same degree of protection against dual seizure also when one of the methods specified is used at the other end.

Method 1

An opposite order of selection is used at each exchange of a bothway circuit group.

Method 2

Each exchange of a bothway circuit group has priority access to the group of circuits which it is controlling (see § D.2.10.1.4). Of this group the circuit which has been released the longest is selected (first-in, first-out). In addition each exchange of a bothway circuit group has non-priority access to the group of circuits which it is non-controlling. Of this group the latest released circuit is selected (last-in, first-out) if all circuits in the group are busy.

For call control purposes a bothway circuit group can be subdivided into subgroups in an exchange.

It is necessary to take preventive action in cases where Signalling System No. 7 uses a signalling data link with long propagation time.

D.2.10.1.4 *Action to be taken on detection of dual seizures*

Each exchange will control one half of the circuits in a bothway circuit group. On detection of a dual seizure, the call being processed by the control exchange for that circuit will be completed and the received initial address message will be disregarded.

Under these conditions, the call being processed by the control exchange will be allowed to mature. The call being processed by the non-control exchange will be backed off and the switch-path released. A release message will not be sent. The non-control exchange will make an automatic repeat attempt on the same or on an alternative route.

For the purpose of resolution of dual seizure on bothway circuits, the exchange with the higher signalling point code will control all even-numbered circuits (circuit identification code) and the other exchange the odd-numbered circuits. ~~The designation of control may also be used for maintenance system purposes.~~

D.2.10.2 *Transmission alarm handling for digital inter-exchange circuits*

When fully digital circuits are provided between two exchanges, which have some inherent fault indication feature giving an indication to the switching system when faults on transmission systems are detected, the switching system should inhibit selection of the circuits concerned for the period the fault conditions persist.

D.2.10.3 *Reset of circuits and circuit groups*

In systems which maintain circuit status in memory, there may be occasions when the memory becomes mutilated. In such a case the circuits must be reset to the idle condition at both exchanges to make them available for new traffic. Since the exchange with the mutilated memory does not know whether the circuits are idle, busy outgoing, busy incoming, blocked, etc., reset circuit messages or a circuit group reset message should be sent as appropriate for the affected circuits.

D.2.10.3.1 *Reset circuit message*

If only a few circuits are concerned, a reset circuit message should be sent for each affected circuit.

On receipt of a reset circuit message, the receiving (unaffected) exchange will:

- a) If it is the incoming or outgoing exchange on a connection in any state of call set-up or during a call, accept the message as a release message and respond by sending a release complete message, after the circuit has been made idle.
- b) If the circuit is in the idle condition, accept the message as a release message and respond by sending a release complete message.
- c) If it has previously sent a blocking message, or if it is unable to release the circuit as described above, respond by the blocking message. If an incoming or outgoing call is in progress, this call should be released and the circuit returned to the "idle, blocked" state. A release complete message is sent following the blocking message. The blocking message should be acknowledged by the affected exchange. If the acknowledgement is not received, the repetition procedure specified in § D.2.10.4 should be followed.
- d) If it has previously received a blocking message, respond by releasing a possible outgoing call or call attempt on the circuit, remove the blocked condition, restore the circuit to the idle state, and respond with a release complete message.
- e) If the message is received after the sending of an initial address message but before receipt of a backward message relating to that call, clear the circuit and make an automatic repeat attempt on another circuit if appropriate.
- f) If the message is received after having sent a reset circuit message, respond by a release complete message. *THE CIRCUIT SHALL BE MADE AVAILABLE FOR SERVICE AFTER RECEIPT OF THE APPROPRIATE ACKNOWLEDGEMENT MESSAGE.*
- g) Clear any interconnected circuits by the appropriate method (e.g. release).

The affected exchange will then reconstruct its memory according to the received response(s) to the reset circuit and respond to the message(s) in the normal way, i.e. blocking acknowledgement message in response to a blocking message.

If no release complete message is received in acknowledgement to the reset circuit message before 4-15 seconds (T16), the reset circuit message should be repeated. If an acknowledgement for the message is not received within 1 minute (T17), after the initial reset circuit message, the maintenance system should be notified. However, the sending of the reset circuit message should continue at 1 minute (T17) intervals until maintenance intervention occurs.

D.2.10.3.2 *Circuit group reset message*

If a considerable number of circuits or all circuits are affected by a memory mutilation, (a) circuit group reset message(s) should be used to make them available for new traffic.

The maximum number of circuits to be reset with a circuit group reset message is limited to 32.

On receipt of a circuit group reset message, the receiving (unaffected) exchange will:

- a) restore the circuits to the idle state;
- b) send the appropriate circuit group blocking message(s) if it had previously sent a hardware failure oriented circuit group blocking message;
- c) respond by a circuit group reset acknowledgement message in which the status indicator bits of the circuits available for service or blocked for reasons of hardware failure are coded 0 and the status indicator bits of all circuits blocked for maintenance reasons are set to 1;
- d) if it had previously received (a) blocking message(s) or (a) circuit group blocking message(s) for one or more of the circuit(s) involved, the blocked condition will be removed and the circuits will be made available for service;
- e) if a circuit group reset message is received concerning circuits for which a circuit group reset message or reset circuit message(s) have been sent, the circuits concerned are made available for service after receipt of the appropriate acknowledgement message;
- f) appropriate messages should be sent on interconnected circuits to release them.

The affected exchange will then reconstruct its memory according to the possibly received circuit group blocking messages and the received circuit group reset acknowledgement message. It will respond to the possibly received circuit group blocking messages in the normal way.

If no acknowledgement to a circuit group reset message is received before 4-15 seconds (T22), the circuit group reset message should be repeated. If an acknowledgement for the circuit group reset message is not received within 1 minute (T23) after sending the initial circuit group reset message, the maintenance system should be notified. However, the sending of the circuit group reset message should continue at 1 minute (T23) intervals until maintenance intervention occurs.

A correct acknowledgement should match the original circuit group reset message in range and circuit identification code indicated in the routing label.

The circuit identification code in the routing label of both circuit group reset messages and circuit group reset acknowledgement messages should belong to a circuit whose control is allocated to the ISDN-UP.

All circuit identification codes in the range of a circuit group reset and circuit group reset acknowledgement message must belong to circuits whose control is allocated to the ISDN-UP.

D.2.10.3.3 *Abnormal circuit group reset message procedures*

- i) If a circuit group reset message is received indicating reset of more circuits than allowed by the receiving exchange, it is discarded.
- ii) If a circuit group reset acknowledgement message is received which is not a correct response to a sent circuit group reset message, it is discarded.
- iii) If a circuit group reset message is received requesting reset of circuits that are not controlled by the ISDN user part, or a circuit group reset acknowledgement message that contains circuit identification codes that are not controlled by the ISDN-UP, the message is discarded.

D.2.10.4 *Failure in the blocking/unblocking sequence*

An exchange will repeat the blocking (unblocking) message or the circuit group blocking (unblocking) message on failure to receive the appropriate acknowledgement in response to one of these messages before 4-15 seconds (T12 for Blocking message, T14 for Unblocking message, T18 for Circuit group blocking message, T20 for Circuit group unblocking message). (see § D.2.9.2).

If the appropriate acknowledgement is not received within a period of one minute (T13 for Blocking message, T15 for Unblocking message, T19 for Circuit group blocking message, T21 for Circuit group unblocking message) after sending the initial blocking (unblocking) message or group blocking (unblocking) message, the maintenance system should be alerted, the repetition of the blocking (unblocking) message or circuit group blocking (unblocking) message should be continued at one-minute intervals until maintenance intervention occurs and the circuit(s) taken out of (returned to) service as appropriate.

D.2.10.5 *Receipt of unreasonable and unrecognized signalling information messages*

The message transfer part of the signalling system will avoid missequencing, or double delivery, of messages with a high reliability (Recommendation Q.706, § 2). However, undetected errors at the signalling link level and exchange malfunctions may produce signalling information messages that are either ambiguous or inappropriate.

The procedures listed below do not include the procedures for the blocking, circuit group blocking and the circuit group reset; these are covered in § D.2.9.2.3 and § D.2.10.3.3 respectively.

D.2.10.5.1 *Handling of unexpected messages*

An unexpected message is one which is recognized and valid but has been received in the wrong phase of the call.

In order to resolve possible ambiguities in the state of a circuit when unexpected messages are received, the following will apply:

- a) if a release message is received relating to an idle circuit, it will be acknowledged with a release complete message;
- b) if a release complete message is received relating to an idle circuit, it will be discarded;
- c) if a release complete message is received relating to a busy circuit for which a release message has not been sent, the circuit will be released and a release message will be sent (~~the possibility of maintaining the connection is for further study~~);
- d) if other unreasonable signalling information is received, the following actions will be undertaken:
 - if the circuit is idle, the reset circuit message is sent;
 - if the circuit has been seized by a call, after receipt of a backward message required for the call set-up, the unreasonable signalling information is discarded;
 - if the circuit has been seized by a call, before receipt of a backward message required for the call set-up, the reset circuit message is sent. If the circuit is seized by an incoming call, the call will be released. If the circuit is seized by an outgoing call, an automatic repeat attempt is provided on another circuit;
- e) ~~if unreasonable signalling information caused by conflicting code point values in the protocol control indicator as specified in Annex C is received in a backwards call set-up message, and if the conflicting conditions can be reconciled by assuming lower network capability in the affected parameter, the call should be allowed to continue if the service requirements for the call can be satisfied.~~

Except in certain cases (see § D.2.10.1), any other unexpected messages received will be discarded. If the discarding of the signalling information prevents a call from being completed, that call will eventually be released by the expiry of a time out.

D.2.10.5.2 *General requirements on receipt of unrecognized signalling information messages and parameters*

SEE RECOMMENDATION Q.767 § 4.1.1.

D.2.10.5.3 *Procedures for the handling of the unrecognized messages or parameters*

SEE RECOMMENDATION Q.767 § 4.1.1.

D.2.10.6 *Failure to receive a "release complete" message — time T1 and T5*

If a release complete message is not received in response to a release message before time (T1), the exchange will retransmit the release message.

On *TRANSMITTING* the initial release message, a one-minute timer (T5) is started. If no release complete message is received on the expiry of this timer (T5), the exchange shall:

- i) send a reset circuit message;
- ii) alert the maintenance system;
- iii) remove the circuit from service;
- iv) continue the sending of the reset circuit message at 1-minute intervals until maintenance action occurs.

D.2.10.7 *Failure to receive a response to an information request message*

This section is not applicable to the international interface.

D.2.10.8 *Other failure conditions*

D.2.10.8.1 *Inability to release in response to a release message*

If an exchange is unable to return the circuit to the idle condition in response to a release message, it should immediately remove the circuit from service, alert the maintenance system and send the blocking message.

Upon receipt of the blocking acknowledgement message, the release complete message is sent in acknowledgement of the release message.

D.2.10.8.2 *Call-failure*

The call-failure indication (cause #31) is sent in a release message (see § D.2.2) whenever a call attempt fails and other specific signals do not apply. Reception of the release message at any Signalling System No. 7 exchange will cause the release message to be sent to preceding exchanges. If the signalling does not permit the release message to be sent, the appropriate signal, tone or announcement is sent to preceding exchanges.

D.2.10.8.3 *Abnormal release conditions*

If the conditions for normal release as covered in § D.2.3 are not fulfilled, release will take place under the following conditions:

- a) *Outgoing international or national controlling exchange*

The exchange shall:

- release all equipment and the connection on failure to meet the conditions for normal release of address and routing information before 20-30 seconds after sending the latest address message;
- release all equipment and release the connection on failure to receive an answer message within time (T9) specified in Recommendation Q.118 after the receipt of the address complete message.

b) *Incoming international exchange*

An incoming international exchange shall release all equipment and the connection into the national network and send back a release message in the following cases:

- on failure to receive a continuity message if applicable before 10-15 seconds (T8) after receipt of the initial address message; or
- on failure to receive a backward signal from a national network (where expected) before 20-30 seconds (T7) after receipt of the latest address message; or
- on receipt of a release message after an address complete message has been generated;
- on failure to receive an address message before 15-20 seconds (T35) after receipt of the latest address message and before the minimum or fixed number of digits have been received.

The procedures for the release message are detailed in § D.2.2.2.

c) *Transit exchange*

The exchange shall release all equipment and the connection and send back the release message in the following cases:

- on failure to receive a continuity message if applicable before 10-15 seconds after receipt of the initial address message; or
- on failure to meet the conditions for normal release as covered in § D.2.3 before 20-30 seconds after sending the latest address message;
- on failure to receive an address message before 15-20 seconds (T35) after receipt of the latest address message and before the minimum or fixed number of digits have been received.

The procedures for the release message are detailed in § D.2.2.2.

~~D.2.10.8.4 If messages are lost during an end-to-end transfer, appropriate actions will be taken according to the type of end-to-end technique being used.~~

~~D.2.10.8.5 For calls involving the SCCP, expiration of the call supervision timer (concerned with call set-up) will result in the SCCP being notified of an error condition.~~

D.2.10.9 *Temporary trunk blocking (TTB) (national use)*

This section is not applicable to the international interface.

D.2.10.10 *Temporary trunk blocking before release of call (use of a discrete overload message)*

This section is not applicable to the international interface.

D.2.11 *ISDN user part signalling congestion control*

D.2.11.1 *General*

On receipt of congestion indication primitives (see also Recommendation Q.704 § 11.2.3), the ISDN user part should reduce traffic load (e.g. call attempts) into the affected direction in several steps.

D.2.11.2 *Procedures*

When the first congestion indication primitive is received by the ISDN user part, the traffic load into the affected direction is reduced by one step. At the same time two timers T29 and T30 are started. During T29 all received congestion indication primitives for the same direction are ignored in order not to reduce traffic too rapidly. Reception of a congestion indication primitive after the expiry of T29, but still during T30, will decrease the traffic load by one more step and restart T29 and T30. This stepwise reduction of the ISDN user part signalling traffic is continued until maximum reduction is obtained by arriving at the last step. If T30 expires (i.e. no congestion indication primitives having been received during the T30 period), traffic will be increased by one step and T30 will be restarted unless full traffic load has been resumed.

Timers T29 and T30 have the following values:

T29 = 300-600 ms,

T30 = 5-10 s.

The number of steps of traffic reduction and the type and/or amount of increase/decrease of traffic load at the various steps are considered to be an implementation matter.

D.2.12 *Automatic congestion control*

Automatic congestion control (ACC) is used when an exchange is in an overload condition (see also Recommendation Q.542). Two levels of congestion are distinguished: a less severe congestion threshold (congestion level 1) and a more severe congestion threshold (congestion level 2).

If either of the two congestion thresholds are reached, an automatic congestion level parameter is added to all release messages generated by the exchange. This parameter indicates the level of congestion (congestion level 1 or 2) to the adjacent exchanges. The adjacent exchanges, when receiving a release message containing an automatic congestion level parameter, should reduce their traffic to the overload affected exchange.

If the overloaded exchange returns to a normal traffic load, it will cease including automatic congestion level parameters in release messages.

The adjacent exchanges then, after a predetermined time, automatically return to their normal status.

D.2.12.1 *Receipt of a release message containing an automatic congestion level parameter*

When an exchange receives a release message containing an automatic congestion level parameter, the ISDN user part should pass the appropriate information to the signalling system independent network management/overload control function within the exchange. This information consists of the received congestion level information and the circuit identification to which the release message applies.

If the ACC procedure is not implemented, the ACC parameter is not acted upon and discarded as normal.

ACC actions are applicable only at exchanges adjacent to the congested exchange. Therefore, an exchange that receives a release message containing an automatic congestion level parameter should discard that parameter after notifying the network management/overload control function.

D.2.12.2 Actions taken during overload

Whenever an exchange is in an overload state (congestion level 1 or 2), the signalling system independent network management/overload control function will direct the ISDN user part to include an automatic congestion level parameter in every release message transmitted by the exchange.

The network management/overload control function will indicate which congestion level (1 or 2) to code in the automatic congestion level parameter.

When the overload condition has ended, the network management/overload control function will direct the ISDN user part to cease including automatic congestion level parameters in the transmitted release messages.

D.2.13 Unequipped circuit identification code message (national option)

This section is not applicable to the international interface.

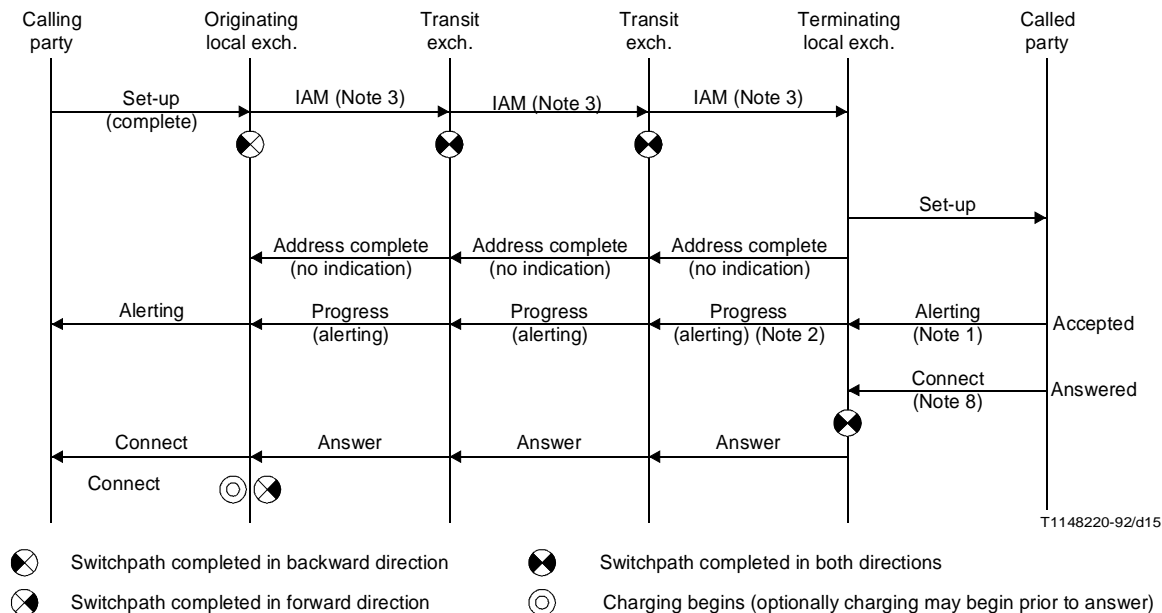

Notes referring to Figures D-1/Q.767 and D-2/Q.767

Note 1 – The alerting message may not be given by a called terminal having automatic answer. Under these circumstances the Connect Message will not be sent as soon as the Connect Message is received and through connection of the speech path has been completed.

Note 2 – For telephone calls within the ISDN, ringing tone will be applied by the terminating exchange as soon as it knows that the subscriber is free. In the case of a PABX connected to the access interface there is the option of an early through connection of the switchpath so that the in-band call arrival indication generated in the PABX is returned to the calling user. For data calls, ringing tone is not applied.

Note 3 – The continuity check may be applicable on an intermediate circuit if analogue circuits are used.

Note 8 – Access protocol example is for point-to-point operation only.

FIGURE D-1/Q.767
Successfull ordinary call (en bloc operation)

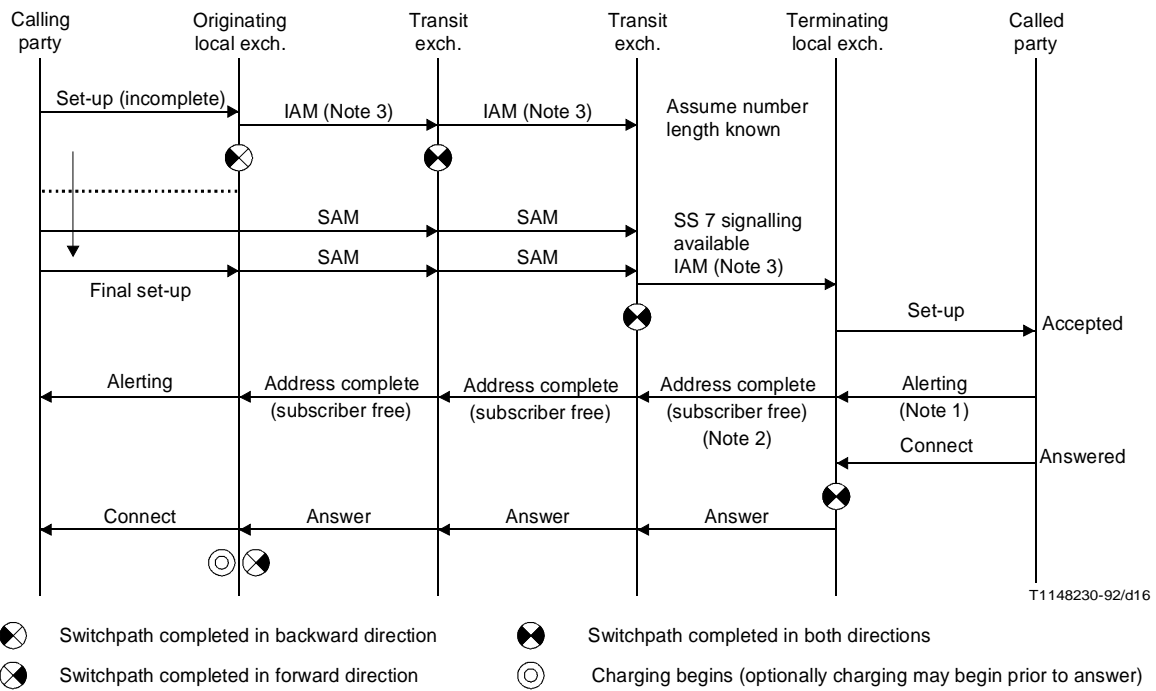

FIGURE D-2/Q.767

Successfull ordinary call (overlap operation)

(This figure is not applicable to the international interface)

FIGURE D-3/Q.767

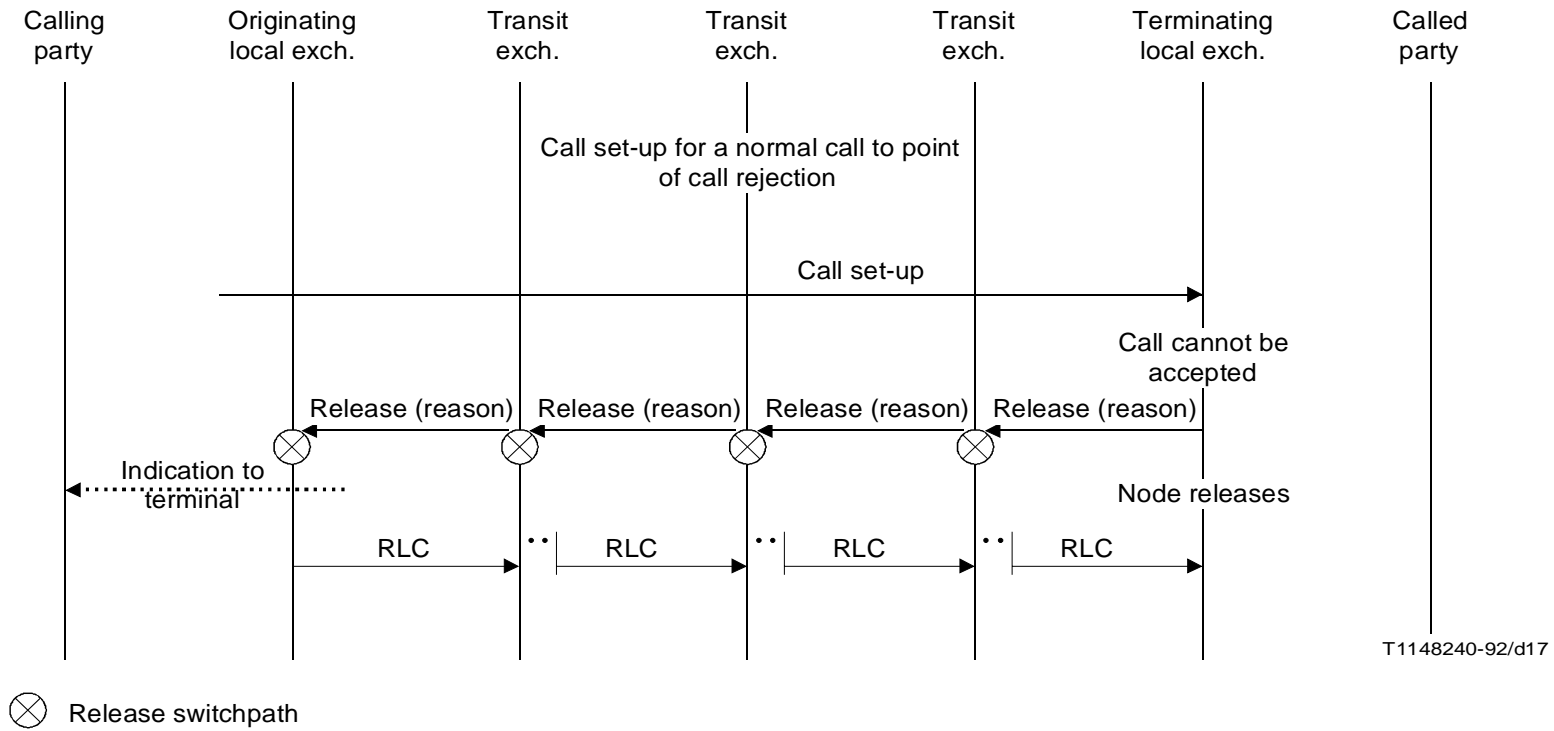

FIGURE D-4/Q.767
Unsuccessful call set-up (no rerouting)

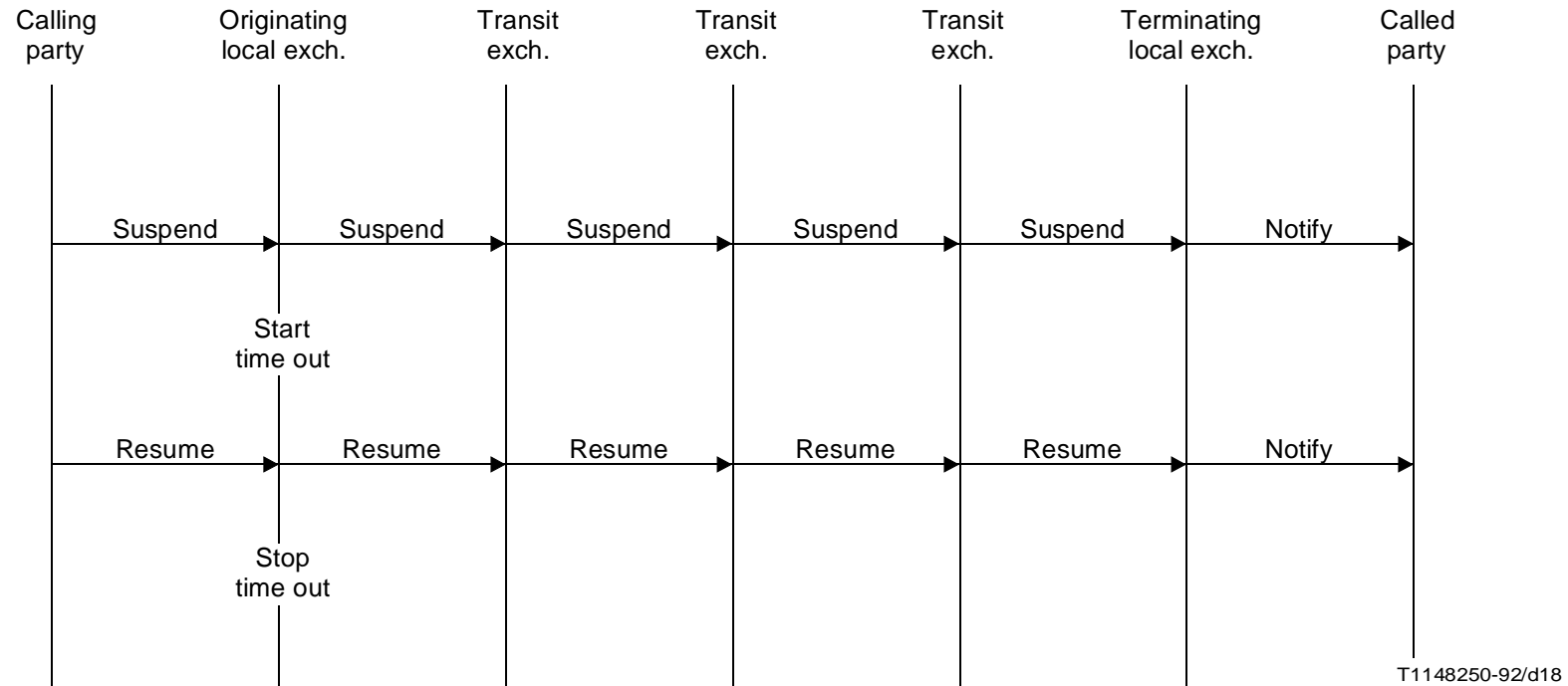
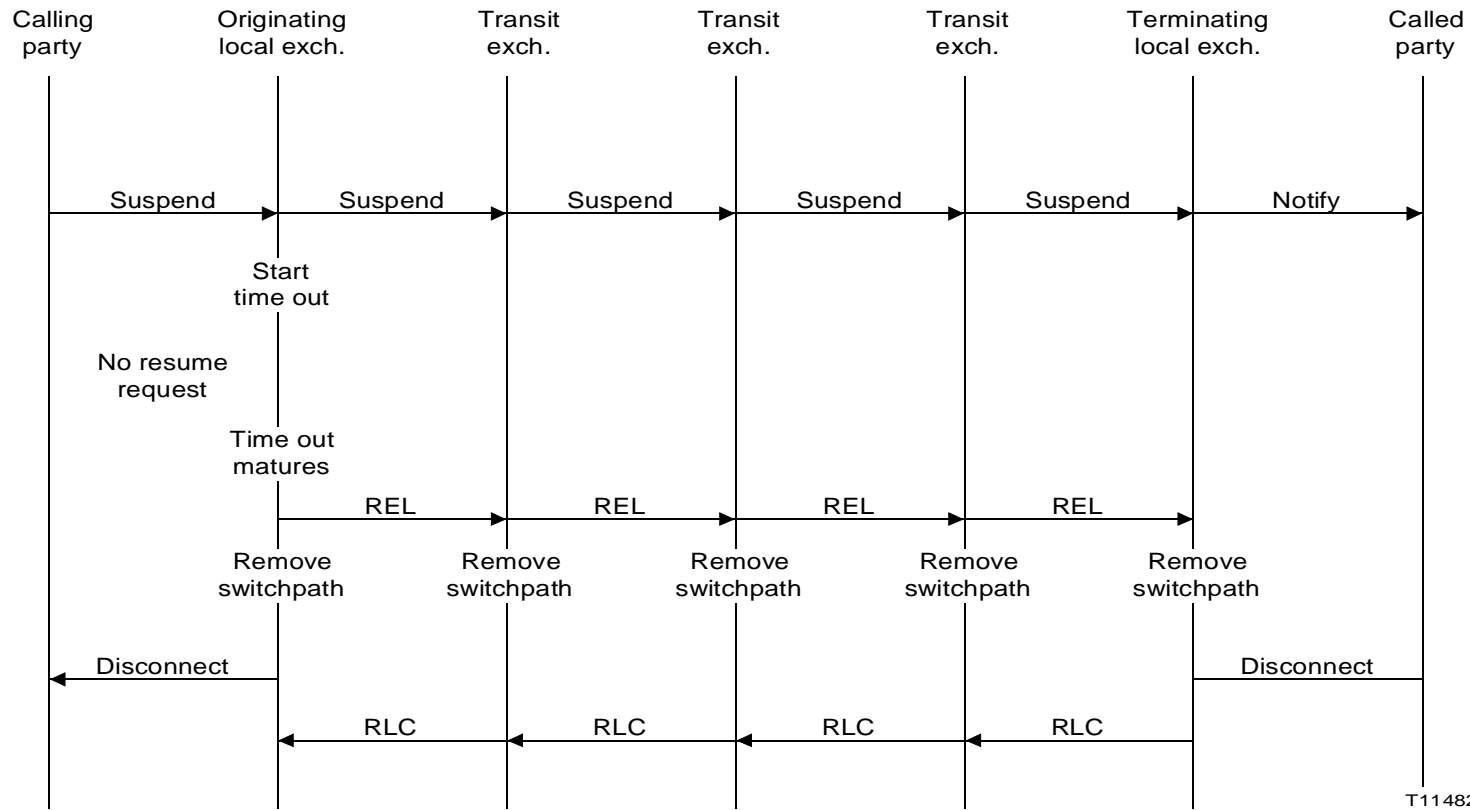

FIGURE D-5/Q.767
Suspend request and resume



T1148260-92/d19

FIGURE D-6/Q.767
Suspend request with no connection

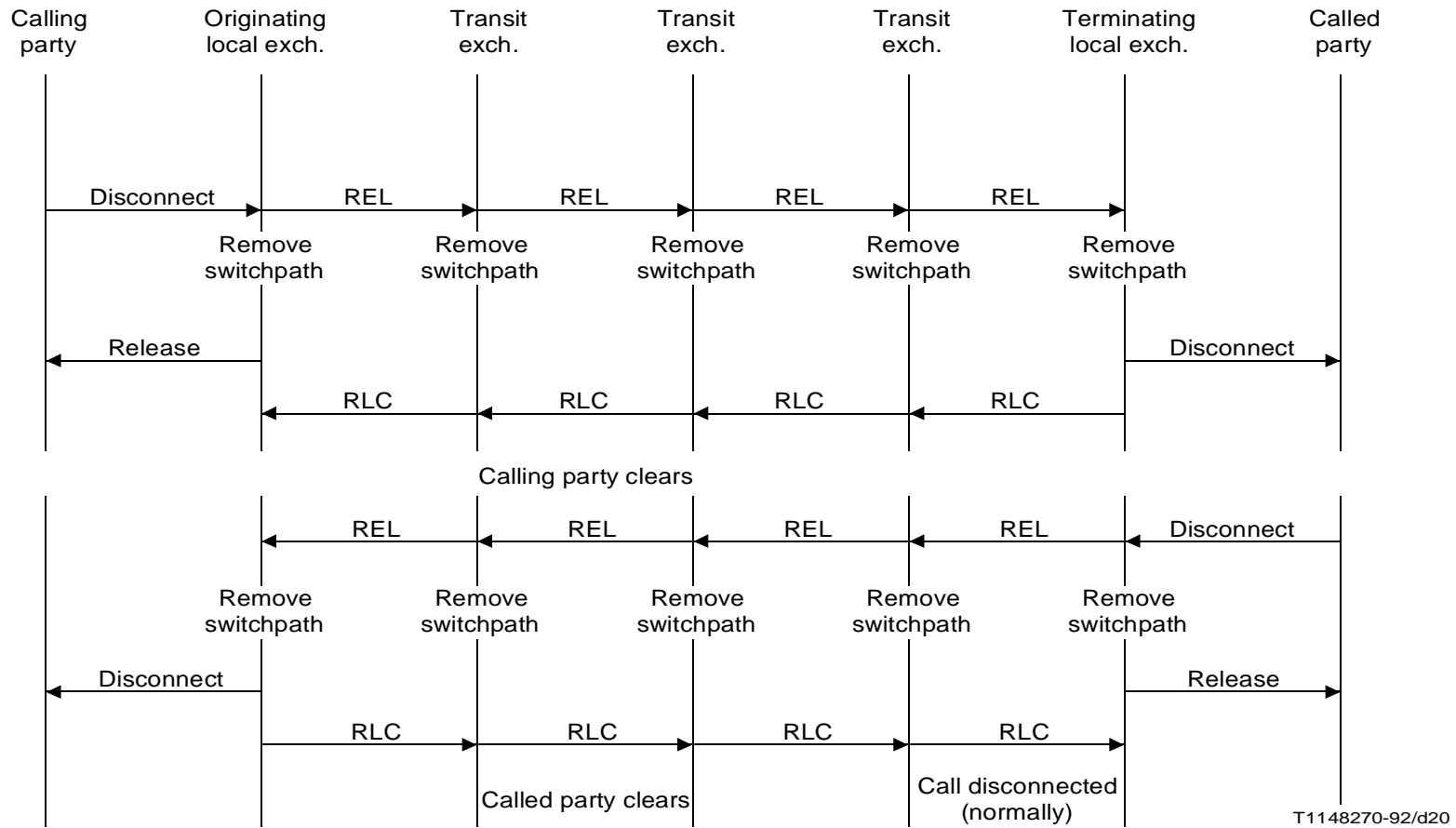

FIGURE D-7/Q.767
Normal call release

TABLE D-1/Q.767 (sheet 1 of 6)

Timers used in Annex D

Symbol	Time-out value	Significance	Cause for initiation	Normal termination	At expiry	Section
T1	4-15 seconds	Local	When release message is sent	At the receipt of release complete message	Re-transmit release message and start timer T1	2.2 — 2.3.1 2.10.6
T2	3 min	Dual	When suspend request controlling exchange receives suspend (user) message	At the receipt of resume (user) message at controlling exchange	Initiate release procedure	2.5.1.1 2.5.2.1 2.5.3
T3			Not used on the international interface			2.6
T4			Not used on the international interface			2.7.1 2.7.2
T5	1 min	Local	When initial release message is sent	At receipt of release complete message	Send reset circuit message, alert maintenance personnel and remove the circuit from service, stop T1 start T17. Procedure continues until maintenance intervention occurs	2.2 2.3.1 2.10.6
T6	Covered in Rec. Q.118	Dual	When controlling exchange receives suspend (network)	At the receipt of resume (network) message	Initiate release procedure	2.5.1.3 2.5.2.3 — 2.5.3

TABLE D-1/Q.767 (sheet 2 of 6)

Timers used in Annex D

Symbol	Time-out value	Significance	Cause for initiation	Normal termination	At expiry	Section
T7	20-30 s	Dual	When the latest address message is sent	When the condition for normal release of address and routing information is met (receipt of ACM, CON messages)	Release all equipment and connection (send release message)	2.1.1.1 2.1.4.4 2.1.4.8 2.1.2.1 f) 2.10.8.3
T8	10-15 s	Local	When transit or incoming international exchange receives initial address message requiring continuity check on this circuit, or indicates that continuity check has been performed on a previous circuit	At receipt of continuity message	Release all equipment and connection into national network (send release message)	2.1.8 2.10.8.3
T9	Interval specified in Rec. Q.118	Dual	When national controlling or outgoing international exchange receives ACM	At the receipt of answer	Release connection and send back release message	2.1.4.4 2.1.7.2 2.1.7.3 2.10.8.3
T10	4-6 s	Dual	When last digit is received in interworking situations	At the receipt of fresh information	Send address complete message	2.1.2.1 e) 2.1.4.8
T11	15-20 s	Dual	When latest address message is received in interworking situations	When ACM is sent	Send address complete message	2.1.4.8

TABLE D-1/Q.767 (sheet 3 of 6)

Timers used in Annex D

Symbol	Time-out value	Significance	Cause for initiation	Normal termination	At expiry	Section
T12	4-15 s	Local	When blocking message is sent	At receipt of blocking acknowledgement	Re-transmit blocking message and start T12	2.10.4
T13	1 min	Local	When initial blocking message is sent	At receipt of blocking acknowledgement	Transmit blocking message, alert maintenance personnel and start T13; stop T12. Procedure continues until maintenance intervention occurs	2.10.4
T14	4-15 s	Local	When unblocking message is sent	At receipt of unblocking acknowledgement	Re-transmit unblocking message and start T14	2.10.4
T15	1 min	Local	When initial unblocking message is sent	At receipt of unblocking acknowledgement	Re-transmit unblocking message and alert maintenance personnel, start T15, and stop T14. Procedure continues until maintenance intervention occurs	2.10.4
T16	4-15 s	Local	When reset circuit message is sent not due to the expiry of Timer T5	At the receipt of the acknowledgement (RLC message)	Re-transmit reset circuit message start T16	2.10.3.1
T17	1 min	Local	When initial reset circuit message is sent	At the receipt of the acknowledgement	Alert maintenance personnel, retransmit reset circuit message, start T17 and stop T16. Procedure continues until maintenance intervention occurs	2.10.3.1

TABLE D-1/Q.767 (sheet 4 of 6)

Timers used in Annex D

Symbol	Time-out value	Significance	Cause for initiation	Normal termination	At expiry	Section
T18	4-15 s	Local	When group blocking message is sent	At receipt of group blocking acknowledgement	Re-transmit group blocking message and start T18	2.10.4
T19	1 min	Local	When initial group blocking message is sent	At receipt of group blocking acknowledgement	Re-transmit group blocking message, alert maintenance personnel, start T19 and stop T18. Procedure continues until maintenance intervention occurs	2.10.4
T20	4-15 s	Local	When group unblocking message is sent	At receipt of group unblocking acknowledgement	Re-transmit group unblocking message and start T20	2.10.4
T21	1 min	Local	When initial group unblocking message is sent	At the receipt of group unblocking acknowledgement	Re-transmit group unblocking message, alert maintenance personnel, start T21 and stop T20. Procedure continues until maintenance intervention occurs	2.10.4
T22	4-15 s	Local	When circuit group reset message is sent	At the receipt of the acknowledgement	Re-transmit circuit group reset message, start T22	2.10.3.2

TABLE D-1/Q.767 (sheet 5 of 6)

Timers used in Annex D

Symbol	Time-out value	Significance	Cause for initiation	Normal termination	At expiry	Section
T23	1 min	Local	When initial circuit group reset message is sent	At receipt of the acknowledgement	Alert maintenance personnel and start T23, re-transmit circuit group reset message, stop T22. Procedure continues until maintenance intervention occurs	2.10.3.2
T24	< 2 s	Local	When check tone is sent	At the receipt of backward check tone	Send continuity message with failure indication and: a) start T25 if continuity check was asked in an IAM and make automatic repeat attempt, or b) start T26 if continuity check was asked in a CCR	Rec. Q.724, § 7.4.1
T25	1-10 s	Local	When initial continuity check failure is detected		Send CCR message and repeat continuity check	Rec. Q.724, § 7.3
T26	1-3 min	Local	When second or subsequent continuity check failure is detected		Send CCR message and repeat continuity check	Rec. Q.724, § 7.3
T27	4 min	Local	When continuity check failure indication is received	At receipt of continuity check request message	Send reset circuit message; start T16 and T17	2.1.8
T28			Not used on the international interface			2.9.3.2

TABLE D-1/Q.767 (sheet 6 of 6)

Timers used in Annex D

Symbol	Time-out value	Significance	Cause for initiation	Normal termination	At expiry	Section
T29	300-600 ms	Local	Congestion indication received when T29 not running		New congestion indication will be taken into account	2.11.2
T30	5-10 s	Local	Congestion indication received when T29 not running		Restore traffic by one step if not yet at full load and start T30	2.11.2
T31			Not used on the international interface			3.7.2 3.7.3 3.7.4
T32			Not used on the international interface			3.7.5
T33			Not used on the international interface			2.1.6.2 2.10.7
T34			Not used on the international interface			2.9.3.2
T35	15-20 s	Dual	At receipt of the latest digit (< > ST) and before the minimum or fixed number of digits have been received	At receipt of ST or when the minimum or fixed number of digits have been received	Send release message (cause 28)	2.2.5 2.10.8.3
T36	10-15 s	Local	When transit or incoming international exchange receives continuity check request message	At receipt of continuity or release message	Release all equipment, sent reset circuit message, start T16 and T17	2.1.8

D.3 *End-to-end signalling*

This section is not applicable to the international interface.

ANNEX E

(to Recommendation Q.767)

ISDN supplementary services

E.1 *General*

E.1.1 *THIS RECOMMENDATION DESCRIBES THE SIGNALLING PROCEDURES FOR SUPPLEMENTARY SERVICES TO BE USED IN CONJUNCTION WITH THE ISDN USER PART DEFINED IN RECOMMENDATIONS Q.761 TO Q.764 AND Q.766 AND ANNEXES A, B, C AND D TO THIS RECOMMENDATION* ~~and the Transaction Capabilities Applications Part (TCAP) defined in Recommendations Q.771-774.~~

Each Supplementary service has been defined in separate sections, each containing the complete procedures for encompassing both the ISDN User Part and the procedures to be used on the top of TCAP where appropriate.

Each section contains a general paragraph giving details of the specific service with references to the Stage I and II descriptions defined in the relevant Recommendations of the I.200 and Q.80-Series. The call set-up procedures and the actions taken at originating exchanges, etc. are defined. Arrow diagrams showing the message flows for both successful and unsuccessful establishment of the service are generally included. The formats and codings aspects are not defined in this Recommendation but references are made to the appropriate ISDN User Part, ~~TC or SCCP~~ Recommendations.

E.1.2 *Information request/response*

This section is not applicable to the international interface.

E.1.3 *Exceeding the maximum message length (e.g. ISDN User Part 272 octets)*

If for any reason the combination of basic plus supplementary service information causes the overall maximum length of the message (e.g. initial address message) to be exceeded, then the user-to-user supplementary service 1, if included, should be rejected (see § E.2 covering interactions).

The combination of other services which may cause the message length to be exceeded will depend on the call state and the requested service.

E.1.4 *Layout of Annex E*

§ E.1 General

§ E.2 User-to-user signalling (Note)

§ E.3 Closed user group

§ E.4 Calling line identification (presentation and restriction)

~~§ E.5 Direct dialling in~~

~~§ E.6 Call forwarding (Note)~~

~~§ E.7 Time-out table for supplementary services (requires further study)~~

§ E.8 Description of the connected Line Identification Presentation and Restriction service

Direct Dialling In and multiple subscriber number are supported, but are without significance to the international interface.

Sub-addressing and terminal portability are implicitly supported as part of the basic Q.767 procedures.

~~Note — The text for the explicit invocation of the user-to-user signalling has been included as Annex A.~~

E.2 *User-to-User Signalling service*

E.2.1 *General description of User-to-User service*

The User-to-User Signalling Supplementary service(s) provide(s) a means of communication between two users by using the ISDN User Part or SCCP *PROTOCOL* defined in Recommendations Q.761 to Q.764 and Q.766 and Annexes A, B, C and D to this Recommendation. In order for the services to be usable, they also have to be provided in the access protocol.

User-to-user signalling is used to exchange I.257 information between two users to provide the user-to-user services described in Recommendation I.257. This section is specific to Signalling System No. 7. The general description for services 1-3 may be found in the last mentioned Recommendation and the functional description in Recommendation Q.87.

E.2.1.1 *User-to-user services*

ONLY IMPLICIT USER SERVICE 1 IS SUPPORTED.

Service 1: user-to-user signalling exchanged during the set-up and clearing phases of a call, within ISDN User Part call set-up and release messages as defined in *ANNEX C*;

~~Service 2: user-to-user signalling exchanged during call set-up between the address complete or call progress messages and the answer or connect messages, within user-to-user information messages; and~~

~~Service 3: user-to-user signalling exchanged while a call is in the active state, within user-to-user information messages.~~

UP TO 128 OCTETS OF USER INFORMATION MAY BE TRANSFERRED IN A MESSAGE. THE 128 OCTETS DO NOT INCLUDE THE PARAMETER NAME, THE LENGTH AND THE PROTOCOL DISCRIMINATOR.

E.2.1.2 *Service request*

Service 1 *is* requested implicitly by the presence of the user-to-user information parameter in the initial address message. An implicit request is "non-essential" by default.

~~Explicit requests of Service 1 and 2 must be in the Initial Address Message. Service 3 may be explicitly requested in the Initial Address Message during call set-up. When there is an explicit request, a single user-to-user indicators parameter will be used with one of the following indications for each of the three services:~~

- ~~— no information;~~
- ~~— requested, non-essential;~~
- ~~— requested, essential.~~

E.2.1.3 *Response (Confirmation)*

THE DISCARD OF USER-TO-USER INFORMATION BY THE NETWORK, EXCEPT IN THE CASE OF PSTN INTERWORKING OR TERMINATING ACCESS NON-ISDN, IS EXPLICITLY NOTIFIED BY THE USER-TO-USER INDICATOR PARAMETER IN THE APPROPRIATE BACKWARD MESSAGE. BIT H IS CODED "UUI DISCARDED BY THE NETWORK" AND BITS CB ARE CODED "NO INFORMATION". NO INFORMATION IS GIVEN IF THE CALLED USER DOES NOT UNDERSTAND THE SERVICE OR CANNOT SUPPORT THE SERVICE.

E.2.1.4 *Flow control*

This section is not applicable to the international interface.

E.2.2 *Procedures for user-to-user signalling associated with circuit-switched call*

The following sections only specify the signalling procedure used to implicitly invoke the service 1. ~~Signalling procedures defined to support the other services are specified in Annex A.~~

E.2.2.1 *User-to-User Signalling, service 1*

E.2.2.1.1 *General characteristics*

Service 1 allows users to communicate with User-to-User Signalling by transferring user-to-user information within ISDN User Part messages during the call set-up and clearing phases. The user-to-user signalling service provided is not a guaranteed service. If for any reason the combination of the basic plus supplementary service information causes the overall maximum length of the messages to be exceeded *OR IF 128 OCTETS OF USER-TO-USER INFORMATION CANNOT BE SUPPORTED IN THE IAM, THEN THE USER-TO-USER INFORMATION PARAMETER IS DISCARDED AND A USER-TO-USER INDICATOR PARAMETER IS SENT IN THE FIRST APPROPRIATE BACKWARD MESSAGE (E.G ACM OR CON). NO TRUNCATION OF USER-TO-USER INFORMATION IS PERFORMED.*

E.2.2.1.2 *User-to-User Signalling in the call set-up phase — implicit service request*

Procedures for call set-up are as described in § D.2, with the following changes:

Service 1 may be invoked by sending the user-to-user information parameter of variable length that is specified in § C.3.34 in an initial address message that is requested in a call set-up request from call control. This information parameter is transported across the network and delivered unchanged to the terminating call control for the called user. The user-to-user indicators parameter will not be sent.

The reception of a user-to-user information parameter in a call set-up or release request from the terminating call control is an implicit indication of the acceptance of service 1.

The user ~~or network~~ may not be able to interpret incoming user-to-user information. In such situations, the user should discard this information without disrupting normal call handling. No specific signalling is provided by the network to accommodate this situation.

If no UUS information is sent in the IAM, the incoming (outgoing) national network should prevent the transmission of UUS in the backward (forward) direction.

E.2.2.1.3 *Interworking*

In the case of interworking with a non-ISDN network, the "interworking" protocol control information will be returned to the originating exchange in the first appropriate message, e.g. an address complete message. ~~Two ISDN networks that interwork may have to retain knowledge of the service request until it is clear whether both can support the service.~~

E.2.2.1.4 *Rejection of implicit service requests*

NETWORKS THAT CANNOT PROVIDE THE REQUESTED SERVICE WILL RETURN A REJECT INDICATION IN THE USER-TO-USER INDICATOR PARAMETER IN THE FIRST APPROPRIATE BACKWARD MESSAGE. BIT H IS CODED "UUI DISCARDED BY THE NETWORK" AND BITS CB ARE CODED "NO INFORMATION".

E.2.2.1.5 *User-to-user signalling in the call clearing phase*

A user-to-user information parameter may be included in the release message. The user-to-user information parameter received at the distant exchange in the release message is passed to the call control for the remote user. In the case of simultaneous clearing of the call, the release message may not reach the distant local exchange and the user-to-user information will be lost.

E.2.2.1.6 *Message flow diagrams*

The message flow diagrams are shown in Figure E-1/Q.767 as well as the use of user-to-user signalling service 1 when implicitly requested in a point-to-point configuration.

The messages shown with dashed lines are not part of the ISDN User Part protocol and are for information only. For detailed information on the access protocol user-to-user procedures, the ISDN access protocol Recommendation should be examined.

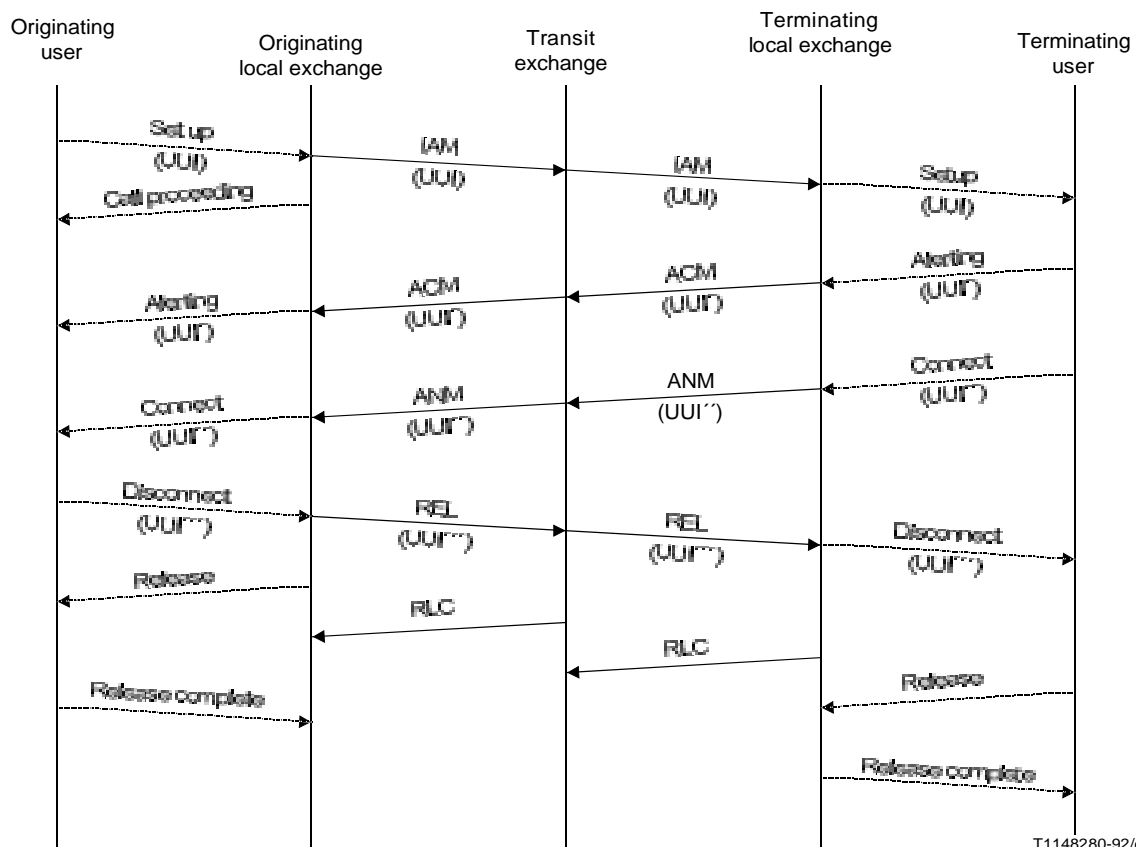

T1148280-92/d21

- UII User-to-user signalling
- ACM Address complete message
- ANM Answer message
- IAM Initial address message
- REL Release
- RLC Release complete

Note 1 – In the case where an ALERTING indication is carried by a call progress message, the user-to-user information parameter may also be transported in the call progress message.

Note 2 – In the case where the called user is an automatic answering terminal, the user-to-user information parameter may be transported in a CONnect message.

FIGURE E-1/Q.767

UUS service 1 (implicit request, called user is point-to-point)

E.2.2.2 *Interaction with other supplementary services*

E.2.2.2.1 Call forwarding services

This section is not applicable to the international interface.

E.2.2.2.2 *Call Waiting service*

This section is not applicable to the international interface.

E.2.2.2.3 *Other services*

There are no known interactions with services other than those listed.

E.2.2.2.4 *State transition diagrams*

The state transition diagrams may be found in stage 2 descriptions of the user-to-user service.

E.3 *Closed User Group (CUG)*

E.3.1 *General*

The Closed User Group (CUG) supplementary service enables a group of users to intercommunicate only among themselves or, as required, one or more users may be provided with incoming/outgoing access to users outside the group.

The stage 1 definition of the CUG service is given in Recommendation I.255, and its stage 2 service definition including network functions are given in Recommendation Q.85.

The realization of the CUG facilities is done by the provision of interlock codes and is based on various validation checks as defined in Q.85 at call set-up, determining whether or not a requested call to or from a user having a CUG facility is allowed. In particular, a validation check is performed by verifying that both the calling and called parties belong to the CUG indicated by the interlock code.

The data for each CUG that a user belongs to can either be stored at the local exchange to which the user is connected (decentralized administration of CUG data), or at dedicated point(s) in the network (centralized administration of CUG data).

~~In § E.3.2, the call set-up procedure based on decentralized administration of CUG data is specified, making use of the ISDN User Part as defined in Recommendations Q.761 to Q.764 and Q.766 and Annexes A, B, C and D to this Recommendation.~~

~~In § E.3.3, the call set-up procedure based on centralized administration of CUG data is specified, making use of the ISDN User Part as defined in Recommendations Q.761-764 and Q.766 and the Transaction Capabilities Application Part (TCAP) as defined in Recommendations Q.771-775.~~

~~Section E.3.4 specifies the application service element (ASE), situated above the Transaction Capabilities Application Part (TCAP), and used for CUG validation check with centralized administration of CUG data.~~

The administration of CUG data is considered as a national matter.

E.3.2 *Call set-up procedure with decentralized or centralized administration of CUG data*

E.3.2.1 *Originating exchange*

The actions at the originating exchange at call set-up from a user belonging to a CUG depend on the result of the validation checks performed there, based on whether the user belongs to one or more CUGs and on the combination of CUG facilities that applies.

a) *CUG call without outgoing access*

If the result of the validation check indicates that the call should be dealt with as a CUG call, the interlock code of the selected CUG is obtained. The initial address message forwarded to the next exchange then includes the interlock code together with an indication that the call is a CUG call without outgoing access. The ISUP preference indicator of the forward call indicators parameter in the IAM is set to "ISUP required all the way".

b) *CUG call with outgoing access*

If the result of the validation check indicates that the call should be dealt with as a CUG call with outgoing access, the interlock code of the selected CUG together with an outgoing access indication is obtained. The initial address message forwarded to the next exchange then includes the interlock code together with an indication that the call is a CUG call for which outgoing access is allowed. The ISUP preference indicator of the forward call indicators parameter in the IAM is set to "ISUP preferred all the way", unless another service requires a more stringent setting.

c) *Non-CUG call*

If the result of the validation check indicates that the call should be dealt with as a non-CUG call, the initial address message forwarded to the next exchange then does not include an interlock code nor a CUG call indication.

d) *Call rejected*

If the result of the validation check indicates that the call is to be rejected, the call set-up is not initiated.

E.3.2.2 *Transit exchange*

~~With the possible exception of some gateway exchanges,~~ Each transit exchange sets up a CUG call as an ordinary call. The information related to the CUG facilities received from the preceding exchange, i.e. an interlock code, a CUG call indication — possibly with an indication that outgoing access is allowed — is forwarded to the succeeding exchange.

In the case of an international CUG call, no special functions are required at the gateway exchange provided that the international interlock code assigned to the international CUG concerned is used in the national network. However, in the case where a national interlock code other than the applicable international interlock code is used within a national network, interlock code conversion is required at the gateway ~~(or corresponding)~~ exchange.

In case of interworking with a network which does not support the CUG facility, the incoming gateway exchange may release the call, depending on the contents of the CUG call indicator in the received IAM. The action at the gateway exchange, in this case, is indicated in Table E-1/Q.767. *IN CASES WHERE A CALL IS REJECTED AS THE RESULT OF THE INTERWORKING, A RELEASE MESSAGE INCLUDING THE CAUSE PARAMETER INDICATING # 87 IS SENT TOWARDS THE ORIGINATING EXCHANGE.*

TABLE E-1/Q.767

Action at the incoming gateway with a network without CUG capability

CUG call indicator in IAM	Action at the gateway exchange
CUG without outgoing access	Release the call with cause # 87
CUG with outgoing access	Treat the call as an ordinary call ^{a)}
Non-CUG	Treat the call as an ordinary call

^{a)} Discard the interlock code parameter and change the CUG call indicator of the optional forward call indicator to indicate non-CUG call or discard the whole parameter if appropriate.

E.3.2.3 Destination exchange

At the destination exchange, a validation check of the acceptability of a call is made according to the rule specified in Recommendation Q.85, where either the calling party (as indicated by a CUG call indication in the initial address message received) or the called party belongs to a CUG. The call set-up is continued only in cases where the information received checks with the information stored at the destination exchange. Table E-2/Q.767 indicates the action to be taken by the destination exchange as the result of the validation check.

TABLE E-2/Q.767

Handling of a CUG call at the destination exchange

CUG call indicator in IAM	CUG match check	Class of called user				
		CUG		CUG + IA		No CUG
		No ICB	ICB	No ICB	ICB	
CUG with OA not allowed	Match	CUG call	Release cause # 55	CUG call	Release cause # 55	Release the call with cause # 87
	No match	Release the call with cause # 87		Release the call with cause # 87		
CUG with OA allowed	Match	CUG call	Release cause # 55	CUG + OA call	Non-CUG call	Non-CUG call
	No match	Release the call with cause # 87		Non-CUG call		
Non-CUG	–	Release the call with cause # 87		Non-CUG call		Non-CUG call

- IA Incoming access
- OA Outgoing access
- ICB Incoming calls barred
- Match The interlock code in the received IAM matches one of the CUGs to which the called user belongs.
- No match The interlock code does not match any of the CUGs to which called user belongs.

Note — As OA attribute of the called user is of no concern at the destination exchange, the CUG + OA class is equivalent to CUG, and CUG/IA class is equivalent to CUG + IA in this table. Subscription of preferential CUG by the called user is also of no concern in this table.

In cases where a call is rejected as the result of the validation check because of incompatible CUG information, a release message including the cause parameter indicating one of the following values is sent towards the originating exchange:

- # 55 Incoming calls barred within CUG
- # 87 ~~Called~~ user not member of CUG
- # 88 ~~Incompatible destination~~

Figure E-2/Q.767 illustrates example message flows for CUG calls with decentralized administration of CUG data.

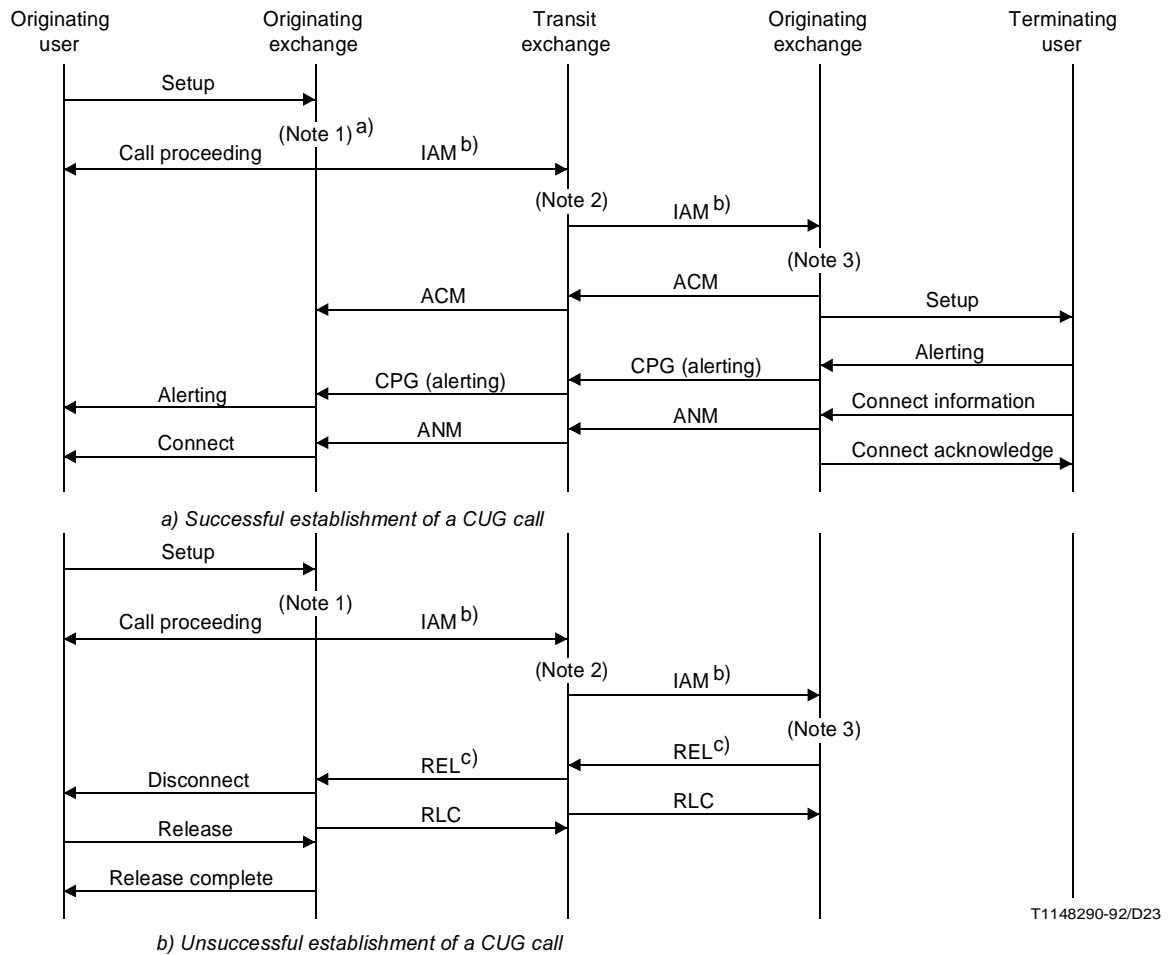

T1148290-92/D23

OE	Originating exchange	IAM	Initial address message
TE	Transit exchange	CPG	Call progress
DE	Destination exchange	ANM	Answer message
		ACM	Address complete message

- a) () indicates exchange functions. These are described below in Figure E-3/Q.767.
- b) IAM contains the interlock code and CUG call indication, possible with outgoing access.
- c) REL contains the cause parameter to indicate why the call is being released.

Note 1 – Validation check on whether the request call is allowed to the calling user, based on the data stored at the originating exchange.
Note 2 – In the case of an international gateway exchange, interlock code conversion if the national network is not using international interlock codes.
Note 3 – Validation check on whether the requested call is allowed to the called user, based on the data stored at the destination exchange.

FIGURE E-2/Q.767
Example message flow for a CUG call with decentralized administration

E.3.3 *Call set-up procedure with centralized administration of CUG data*

This section is not applicable to the international interface.

E.3.4 *ASE for CUG service with centralized administration of CUG data*

This section is not applicable to the international interface.

E.3.5 Interactives with other supplementary services

There are no known interactions with supplementary services applicable at the international interface.

E.4 *General description of the Calling Line Identity Presentation and Restriction service*

Calling Line Identification Presentation (CLIP) is a supplementary service offered to the called party which provides the calling party's ISDN number, ~~possibly~~ with additional address information (E.G. CALLING PARTY SUB-ADDRESS), if any, to the called party.

Calling Line Identification Restriction (CLIR) is a supplementary service offered to the calling party to restrict presentation of the calling party's ISDN number, ~~possibly~~ with additional address information (E.G. CALLING PARTY SUB-ADDRESS), if any, to the called party.

THE STAGE 1 DEFINITIONS FOR THE CLIP AND CLIR SERVICES ARE GIVEN IN RECOMMENDATION I.251 AND THE STAGE 2 SERVICE DEFINITIONS INCLUDING NETWORK FUNCTIONS, ARE GIVEN IN RECOMMENDATION Q.84. THIS STAGE 3 DESCRIPTION OF CLIP AND CLIR USE THE ISDN USER PART PROTOCOL AS DEFINED IN RECOMMENDATIONS Q.761 TO Q.764 AND Q.766 AND ANNEXES A, B, C AND D TO THIS RECOMMENDATION.

E.4.1 *Description of the Calling Line Identity Presentation (CLIP) service*

Calling Line Identity Presentation (CLIP) is a user facility that enables a user to be informed on incoming calls, of the address of the calling party. When provided, the facility applies to all incoming calls except for when the calling party has the Calling Line Identity Restriction (CLIR) facility active (see § E.4.2 below) or the complete number of the calling party is not available at the destination exchange.

THE CALLING LINE IDENTITY (CLI) IS THE ISDN NUMBER OF THE CALLING PARTY (WITH ADDITIONAL ADDRESS INFORMATION, E.G. CALLING PARTY SUB-ADDRESS, IF ANY) WHICH MAY BE PROVIDED BY THE NETWORK OR PARTLY BY THE CALLING PARTY.

~~In the case where a national network does not always provide the CLIP facility, the included CLI may be the known part of the ISDN number at the interworking point (e.g. Trunk Code).~~

IN THE CASE WHERE A CALLING PARTY IS AN ISPBX, THE NETWORK SENDS THE ISDN NUMBER INCLUDING THE DDI DIGITS OF THE EXTENSION AS THE CLI IF THE LATTER IS PROVIDED BY THE CALLING PARTY, OR THE NETWORK PROVIDED DEFAULT NUMBER IF THE EXTENSION NUMBER IS NOT PROVIDED.

When the CLI is provided by the user or ISPBX, it is verified or screened for validity by the network, i.e. the CLI provided by the user is within the known number range for that user.

- i) If the user provided CLI is valid, the Calling Party Number parameter field contains the CLI in the address signals with the screening indicator set to "user provided verified and passed".

- ii) If the user provided CLI is not valid or screened, the originating exchange defaults to the network provided CLI for the address signals of the Calling Party Number parameter field with the screening indicator set to "network provided".

When the CLI is provided by the network, the originating exchange includes the stored CLI set against the calling party and sets the screening indicator to "network provided".

The CLI sent to the called user should contain all the necessary digits to enable a call to be established in the reverse direction.

Note — This may not always be possible if, for example, the DDI extension of an ISPBX is not provided by the calling party.

Information indicating that a subscriber has the user access to the CLIP facility is available in the exchange to which the subscriber is connected.

E.4.1.1 *Call set-up procedure*

SYSTEMATIC INCLUSION IN THE IAM IS THE ONLY METHOD USED WHEN THE CLI IS AVAILABLE.

E.4.1.1.1 *The Calling Line Identity is include in the initial address message*

When the CLI is available for insertion in the IAM, the systematic inclusion of this parameter, in the IAM, is recommended. However, it is realized that under certain interworking conditions, the CLI may only be available subsequent to the transmission of the IAM.

The release of restricted CLIs across international boundaries is decided by bilateral agreement. If any agreements requires restricted CLIs not to be passed, then the originating gateway shall ensure that no such CLIs are sent. [Note — This bilateral agreement may depend on the application of override categories in the destination network (see § E.4.2.2.1 and § E.4.2.2.2).]

~~In this situation, to avoid unnecessary unsuccessful requests for the CLI, the following procedures are recommended:~~

- ~~a) If the CLI cannot be included in the IAM (for any reason) but is available and may be requested with a good chance of receiving it, then the optional field "calling party number parameter" should not be included in the IAM.~~
- ~~b) If the CLI cannot be transferred (because it is not allowed to be passed or because the national network cannot provide the number), then the optional field "calling party number parameter" should be included in the IAM with the indication "presentation restricted" or "address not available" set as appropriate in the Address Presentation Restricted indicator.~~

The CLI is sent to the called party in accordance with the user-network interface protocol.

IF NO ADDRESS SIGNALS ARE TO BE SENT, THEN THE CALLING PARTY NUMBER PARAMETER SHALL NOT BE SENT. WHEN INTERWORKING WITH SIGNALLING SYSTEMS WHICH DO NOT SUPPORT CALLING LINE IDENTITY (E.G. N5) OR FROM WHICH CALLING LINE IDENTITY IS NOT IMMEDIATELY AVAILABLE (E.G. TUP), THE CALLING PARTY NUMBER PARAMETER IS NOT SENT.

ONLY COMPLETE CALLING PARTY NUMBERS ARE SENT.

E.4.1.1.2 The Calling Line Identity is not included in the initial address message

IF NO CALLING PARTY NUMBER PARAMETER IS RECEIVED IN THE INITIAL ADDRESS MESSAGE, THEN IT IS A FUNCTION OF THE USER-NETWORK INTERFACE NOT TO PRESENT THE CALLING PARTY SUB-ADDRESS, IF RECEIVED, TO THE USER.

E.4.1.1.3 Message sequence diagrams for CLIP

Figures E-6/Q.767 and E-7/Q.767 describe the message flows for CLIP.

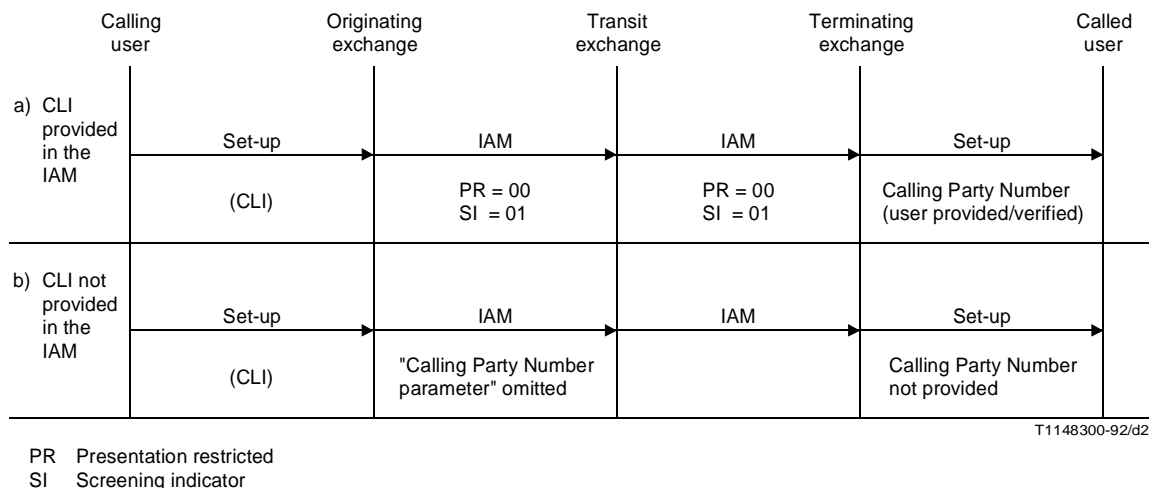

FIGURE E-6/Q.767
Calling Line Identification Presentation
Presentation allowed – CLI provided by the calling user

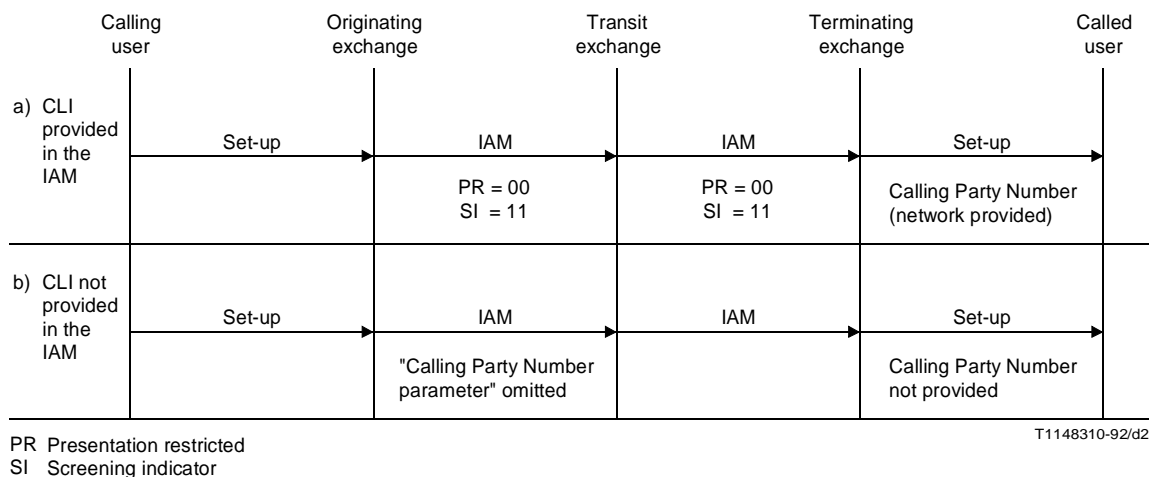

FIGURE E-7/Q.767
Calling Line Identification Presentation
Presentation allowed – CLI provided by the originating node

E.4.2 *Description of the Calling Line Identity Restriction (CLIR) service*

Calling Line Identification Restriction (CLIR) is a user facility offered to restrict the presentation of the Calling Line Identity to the Called Party.

THE CALLING LINE IDENTITY (CLI) IS THE ISDN NUMBER OF THE CALLING PARTY WITH ADDITIONAL ADDRESS INFORMATION (E.G. CALLING PARTY SUB-ADDRESS) IF PRESENT.

Information that a subscriber has the Calling Line Identity Restriction facility is available at the exchange to which the subscriber is connected.

E.4.2.1 *Normal case*

When CLIR is applicable, the originating exchange will provide the destination node with a notification that the Calling Line Identity is not allowed to be presented at the called party. In this case, the Calling Line Identity will be marked as presentation restricted, in the Address Presentation Restricted Indicator, when it is passed across the network, in either an initial address message or Information Message. In the case of CLIR, the Calling Line Identity will not be included in the call offering to the called party's installation.

E.4.2.2 *Abnormal case*

E.4.2.2.1 *Override category within an ISDN*

As a national option, the terminating exchange can override the presentation restriction indication and the CLI presented at the called subscriber for specific called party's categories (e.g. Police).

E.4.2.2.2 *Override category between ISDNs*

When a call originates in one ISDN network and terminates in another ISDN network and CLIR is applicable, the rules and regulations of the destination (host) network should apply.

For example, if an override category is not available in the originating network but is available in the destination network. The destination network can still override the presentation restriction whenever CLI is available at this network.

As a national option the originating network can restrict the CLI to the destination network if the CLIR is applicable.

E.4.2.2.3 *Interworking with non-ISDN or via non-ISDN*

On calls to or via non-ISDN networks, it cannot be guaranteed that the CLIR indication will be carried to the destination network.

IF CLIR IS APPLICABLE AND THE RESTRICTION INDICATOR CANNOT BE CONVEYED ON THE NEXT SIGNALLING SECTION, THE INTERWORKING EXCHANGE WILL NOT SEND THE CLI AND ANY ADDITIONAL ADDRESS INFORMATION PROVIDED BY THE CALLING PARTY (E.G. CALLING PARTY SUB-ADDRESS).

If the destination network receives a Calling Line Identity without any indication of presentation allowed or restricted, the destination network will act according to its rules and regulations.

E.4.2.2.4 *Restriction of additional address information*

Any additional address information provided by the calling party, *E.G. CALLING PARTY SUB-ADDRESS*, will also be subject to the CLIR supplementary service as indicated in the presentation restriction indicator in the Calling Party Number parameter field.

E.4.2.2.5 *Message Sequence diagrams for CLIR*

Figure E-8/Q.767 describes the message flow for CLIR.

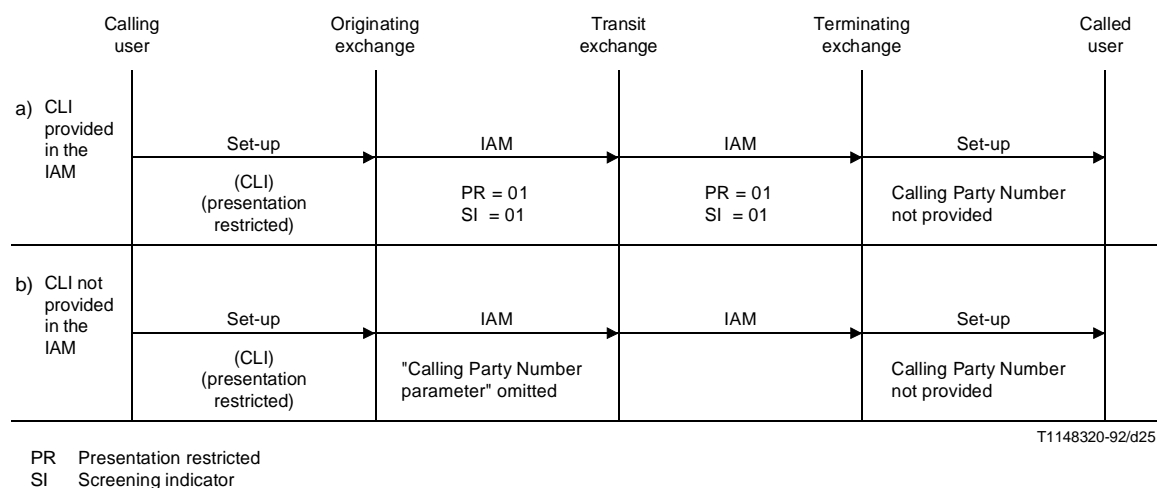
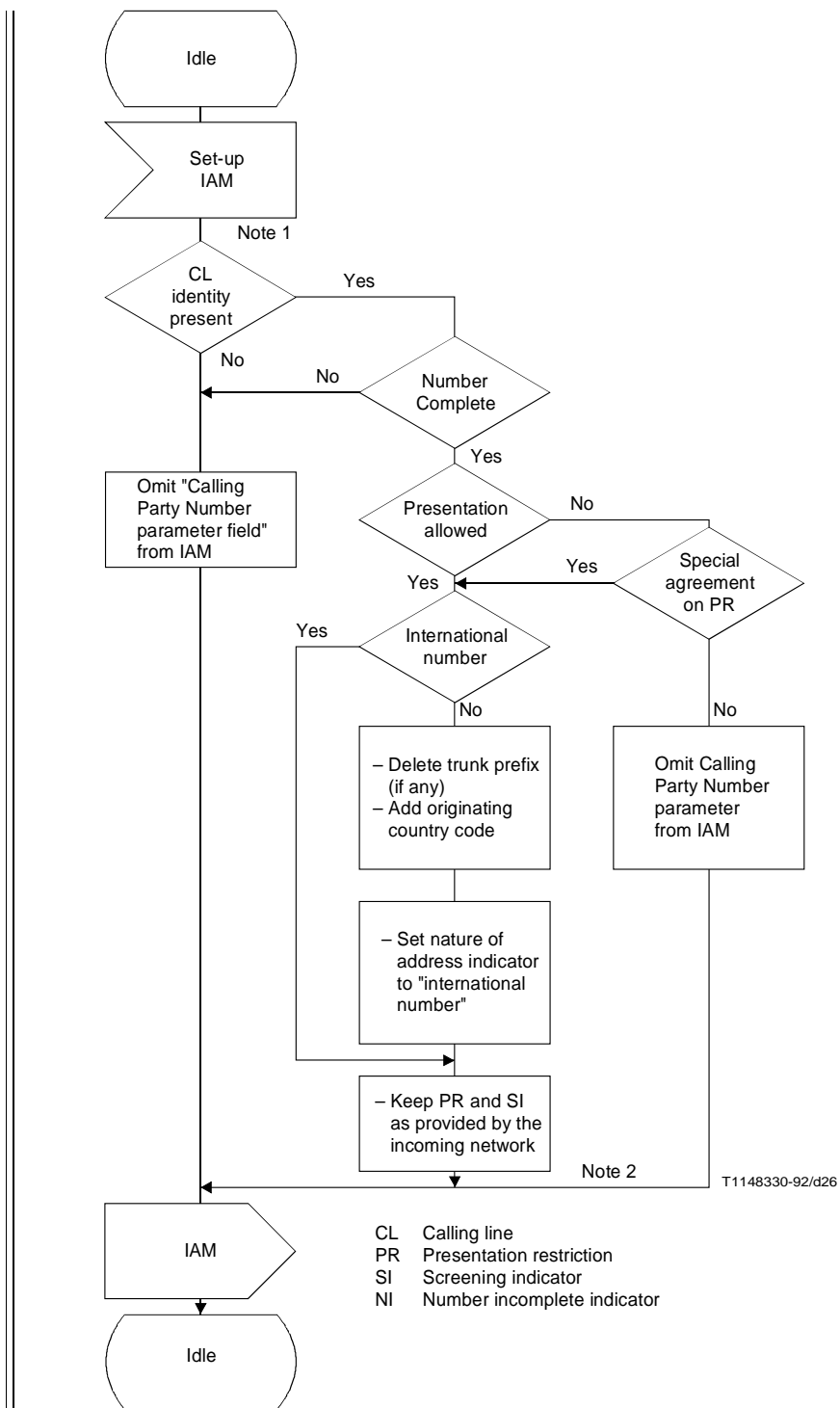

FIGURE E-8/Q.767
Calling Line Identification Restriction
 Presentation not allowed – CLI provided by the calling user

E.4.3 *Nodal signalling function SDLs for CLIP and CLIR*

Nodal signalling function procedures for CLIP and CLIR are described in Figures E-10/Q.767 and E-11/Q.767.



Note 1 – This flow assumes that there is no restriction on passing non-restricted CLI's across the International boundary. If no such agreement exists then any CLI in the incoming IAM will be removed.

Note 2 – Allowed values for the international section are:
PR = 00 or 01
SI = 01 or 11
NI = 0

FIGURE E-10/Q.767
Nodal signalling functions for CLIP and CLIR
Outgoing International Gateway

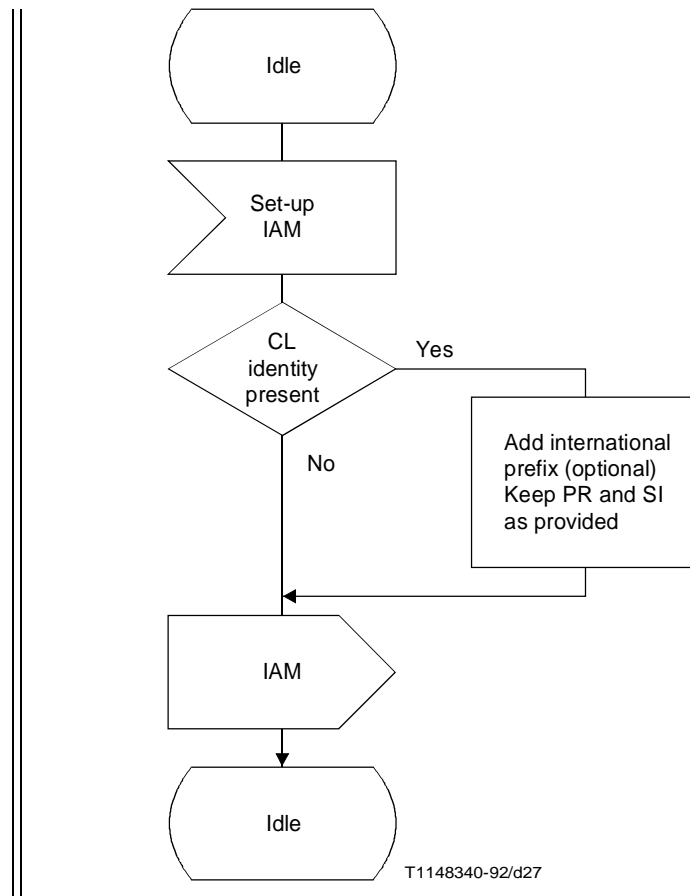

CL Calling line
 PR Presentation restriction
 SI Screening indicator

FIGURE E-11/Q.767
**Nodal signalling function for CLIP and CLIR
 destination international gateway exchange**

E.4.4 *Interaction of CLIP with other supplementary services*

E.4.4.1 *Calling Line Identification Restriction*

The calling line identification will not be present if the calling user has an arrangement to inhibit the presentation of his number to the called party.

E.4.4.2 *Call Forwarding*

This section is not applicable to the international interface.

E.4.4.3 *Call Waiting*

This section is not applicable to the international interface.

E.4.4.4 *Closed User Group*

No interaction.

E.4.4.5 *Direct Dialling In*

This section is not applicable to the international interface.

E.4.4.6 *User-to-User Information*

No interaction.

E.4.4.7 *Other services*

There are no known interactions with supplementary services applicable at the international interface other than those listed.

E.4.5 *Interaction of CLIR with other supplementary services*

E.4.5.1 *Calling Line Identification Presentation*

Calling Line Identification Restriction will take precedence over Calling Line Identification Presentation.

The only occasion when a user subscribing to Calling Line Identification Presentation can take precedence over Calling Line Identification Restriction is when the user has override category. This is a national option.

E.4.5.2 *Call Forwarding*

This section is not applicable to the international interface.

E.4.5.3 *Call Waiting*

This section is not applicable to the international interface.

E.4.5.4 *Closed User Group*

NO INTERACTION

E.4.5.5 *Direct Dialling In*

This section is not applicable to the international interface.

E.4.5.6 *User-to-User Information*

No interaction.

E.4.5.7 *Other services*

There are no known interactions with supplementary services applicable at the international interface other than those listed.

E.5 *Direct Dialling In (DDI)*

This section is not applicable to the international interface.

E.6 *Call Forwarding services*

This section is not applicable to the international interface.

E.7 *Time-out table*

This section is not applicable to the international interface.

ANNEX E-A: Signalling procedures for the explicit invocation of User-to-User Signalling services 1, 2 and 3

This section is not applicable to the international interface.

E.8 *Description of the connected Line Identification Presentation and Restriction service*

Connected Line Identification Presentation (COLP) is a supplementary service offered to the calling party which provides the connected party's ISDN number, with additional address information (e.g. connected party sub-address) if any, to the calling party at the call establishment phase.

Connected Line Identification Restriction (COLR) is a supplementary service offered to the connected party to restrict presentation of the connected party's ISDN-number, with additional address information (e.g. connected party sub-address) if any, to the calling party.

The Stage 1 CCITT definitions for the COLP and COLR services are given in Recommendations I.251.5 and I.251.6 respectively. The stage 2 CCITT descriptions are contained in Recommendations Q.81, § 5 and Q.81, § 6 respectively. This stage 3 description of COLP and COLR uses the ISDN User Part protocol as defined in the CCITT Recommendations Q.761 to Q.764 and Q.766 and Annexes A, B, C and D to this Recommendation.

E.8.1 Description of the Connected Line Identification Presentation (COLP) service

Connected Line Identity Presentation (COLP) is a user facility that enables a user to be informed, on outgoing calls, of the address of the connected party. When provided, the facility applies to all outgoing calls except for when the connected party has the Connected Line Identity Restriction (COLR) facility active (see § E.8.2 below).

The Connected Line Identity (COL) is the ISDN number of the connected party (with additional address information, e.g. connected party sub-address, if any) which may be provided by the network or by the connected party or partially by the network with the rest provided by the connected party.

Only full international number, including the country code, should be passed across the international boundary.

Moreover, the information on the COL may include address information generated by the connected user and transparently transported by the network. The sub-address is subject to a maximum of 20 octets. (The length of the sub-address is not checked at international gateways.) The network is not responsible for the content of this additional address information.

The destination exchange shall deliver the COL only if it was requested at call set-up. However, if it is received in the answer of connect message when it has not been requested, it should not be considered as a protocol error and the call should be allowed to continue.

In the case where a connected party is a DDI ISPBX extension, the network sends the ISDN number and the DDI number of the extension as the COL if the extension digits are provided by the connected party. If the extension digits are not provided, the network sends the ISDN default number. The default number is stored within the network but the value is agreed between the Administration and the customer concerned.

When the COL is provided by the user or ISPBX, it is verified or screened for validity by the network, i.e. the COL provided by the user is within the known number range for that user.

- i) If the user provided COL is valid, the Connected Number parameter field contains the COL in the address signals with the screening indicator set to "user provided verified and passed".
- ii) If the user provided COL is not valid or screened, the destination exchange inserts the default number for the Address Signals with the screening indicator set to "network provided".

When the COL is provided by the network, the terminating exchange includes the stored COL set against the Connected party and sets the screening indicator to "network provided".

Information indicating that a subscriber has the user access to the COLP facility is available in the exchange to which the subscriber is connected.

The destination gateway can remove the COL digits and indicate that connected line identity is not available.

E.8.1.1 Call set-up procedure

The call control procedure and the information included in call control messages vary, depending on whether the calling party has indicated, in the optional forward call indicator in the IAM, a request to use the COLP facility for this call.

E.8.1.1.1 The Request of COLP facility is included in the initial address message

When the calling party user has subscribed to the COLP facility, the originating exchange, if the Connected Line Identification is supported by the network, must include in the IAM an indication to request the COLP facility.

The Connected Line Identification is determined by the destination exchange. If the connected party number is received from the connected user, the information is verified and passed to the originating exchange. If no information is received from the connected user, the destination exchange shall generate the connected party number.

The information is conveyed by the network in the Connected Number parameter field of the answer (ANM) or connect (CON) message. The service has no impact on the signalling procedures.

Optionally, a connected party sub-address may be included, if received from the called party user, in the connected sub-address information element which is added to the ATP (Access Transport parameter) of these messages.

Both parameters, ATP and Connected Number are sent to the originating exchange.

If the COL cannot be transferred (because its presentation is restricted or because the national network cannot provide the number), then the Connected Number parameter should be included in the ANM or CON messages with the indication "Presentation restricted" or "Address not available" set as appropriate in the Address Presentation Restriction Indicator.

In the case of Connected Number Presentation Restriction, the COL with the presentation restriction indication will be forwarded to the originating exchange but not presented to the calling party (unless the national option of the override category is invoked).

In the case of interworking between ISDNs, the destination network can restrict the presentation of the COL. If this option is invoked, the COL shall be marked as not available.

No particular actions are required at intermediate exchanges.

At the international boundary, the destination gateway can remove the Connected Number digits if it cannot be released to the originating network and a COL not available indication will be passed to the originating network (address presentation restricted indicator set to address not available).

At the originating exchange, when a Connected Party Number is received in the Answer or Connect message, the originating exchange determines if the information may be presented to the user.

Note — If no Connected Party Number Parameter or a restricted connected number is received in the Answer or Connect Message, then it is a function of the user-network interface not to present the connected party sub-address, if received, to the user.

E.8.1.1.2 COLP Facility not requested by the Calling Party User

When the calling party user has not subscribed to the COLP facility, no particular actions are required. When a request for the COL is not included in the IAM, the Connected Number parameter should not be included in either the answer or connect message. However, if it is included under these circumstances, it should not be considered as a protocol error and the call should continue.

E.8.1.1.3 Message sequence diagrams for COLP

Figure E-14/Q.767 describes the message flows for COLP.

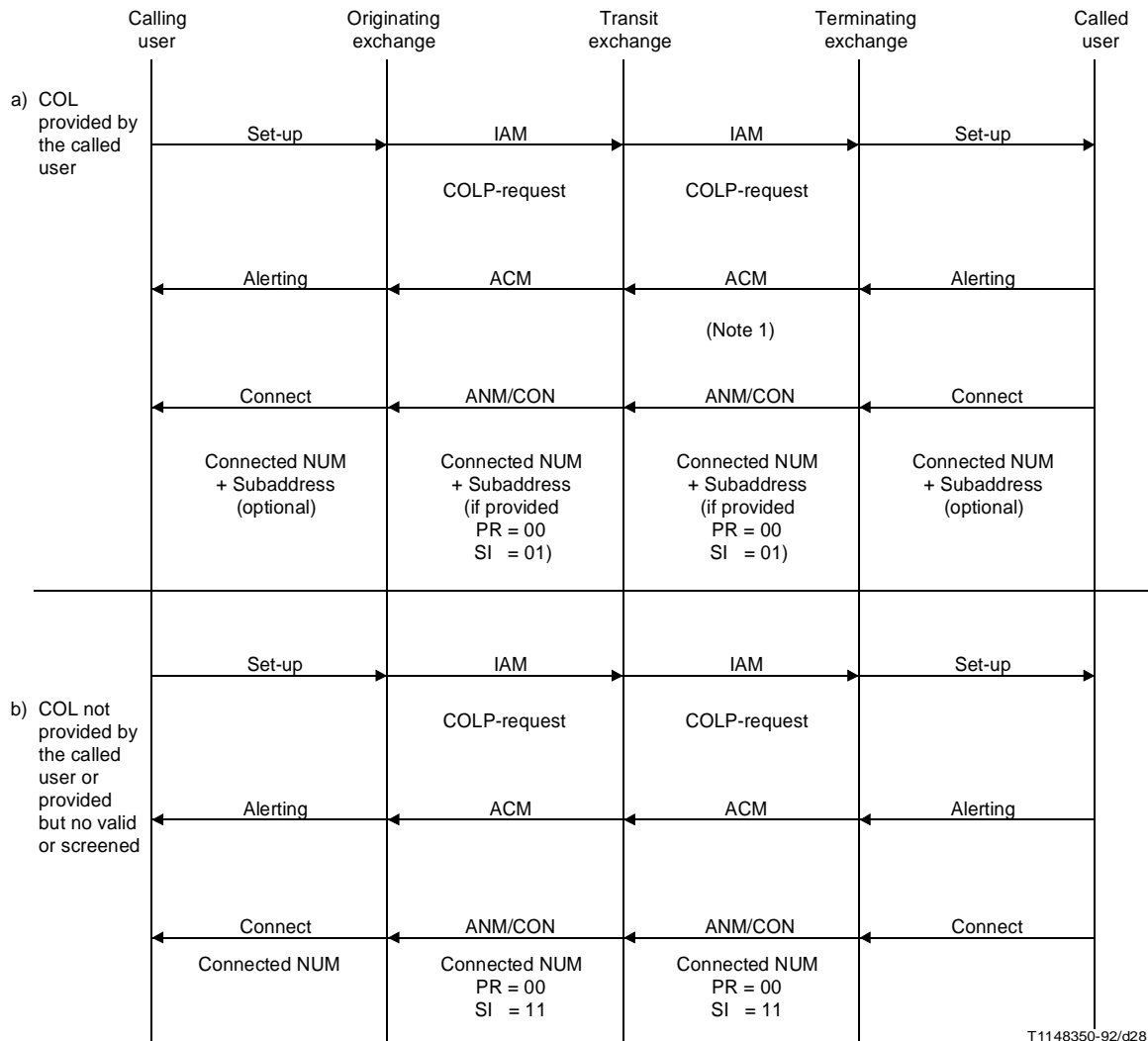

Note 1 – The connect message is appropriate only if the answer condition is detected prior to the return of the address complete message.
Note 2 – This service is subscribed by the calling user and the request is included by the originating exchange.

FIGURE E-14/Q.767
Connected Line Identification Presentation

E.8.2 Description of the Connected Line Identity Restriction (COLR Service)

Connected Line Identification Restriction (COLR) is a user facility offered to restrict the presentation of the COL to the calling party. The information that the called subscriber has the COLR facility is available at the call terminating exchange.

When COLR is applicable and activated, the destination exchange provides the originating node with a notification that the connected user's ISDN number and any Sub-address information is not allowed to be presented to the calling user. In this case no connected party number is included in the call connected information sent to the calling user.

The presentation restriction function does not influence the forwarding of the connected number within the network as part of the basic service procedure.

The passing of restricted Connected Number parameters across international boundaries is decided by bilateral agreements. If any agreement requires restricted Connected Number parameters not to be passed, then the terminating gateway shall ensure that no such Connected Number parameters are sent.

Note — This bilateral agreement may depend on the application of override categories in the originating network (see § 8.2.2).

The restriction service is applied universally for all services for a particular customer.

E.8.2.1 Call set-up procedure

When the calling party user has subscribed to the COLP facility, the originating exchange includes in the IAM an indication to request the COL. If the called party user has subscribed to the COLR facility, the destination exchange will send the Connected Line Identity to the originating exchange, with an indication that the presentation is restricted (Address presentation restricted indicator set to presentation restricted).

This information is conveyed by the network in the Connected Number parameter field of the ANM or CON messages. The service has no impact on the signalling procedures.

No particular actions are required at intermediate exchanges.

At the international boundary, the destination gateway can remove the COL if it cannot be released to the originating network and change the Address presentation restricted indicator, set to presentation restricted, into address not available.

At the originating exchange, when a Connected party Number is received in the ANM or CON message with the indication that the presentation is restricted, the originating exchange must not present the COL to the user.

E.8.2.2 *Override category*

E.8.2.2.1 *Override category within an ISDN*

As a national option, the originating exchange can override the Presentation Restriction Indication and the COL is then presented to the calling subscriber for specific calling party's categories (e.g. Police).

When a call originates in one ISDN network and terminates in another ISDN network and COLR is applicable, the rules and regulations of the originating (host) network should apply.

E.8.2.2.2 *Override category between ISDNs*

For example, if an override category is not available in the destination network but is available in the originating network, the originating network can still override the presentation restriction whenever COL is available at this network.

As a national option, the destination network can restrict the COL to the originating network if COLR is applicable.

E.8.2.3 *Interworking with non-ISDN or via non-ISDN*

On calls from or via non-ISDN networks, it cannot be guaranteed that the COLR indication will be carried to the originating network.

If COLR is applicable and the restriction indicator cannot be conveyed on the preceding signalling section, the interworking exchange will not send the COL.

If the originating network receives a Connected Line Identity without any indication of presentation allowed or restricted, the originating network will act according to its rules and regulations.

E.8.2.4 *Restriction of additional address information*

Any additional address information provided by the Connected party, e.g. connected party sub-address, will also be subject to the COLR supplementary service as indicated in the address presentation restriction indicator in the Connected Number parameter.

E.8.2.5 *Message sequence diagrams for COLR*

Figure E-15/Q.767 describes the message flow for COLR.

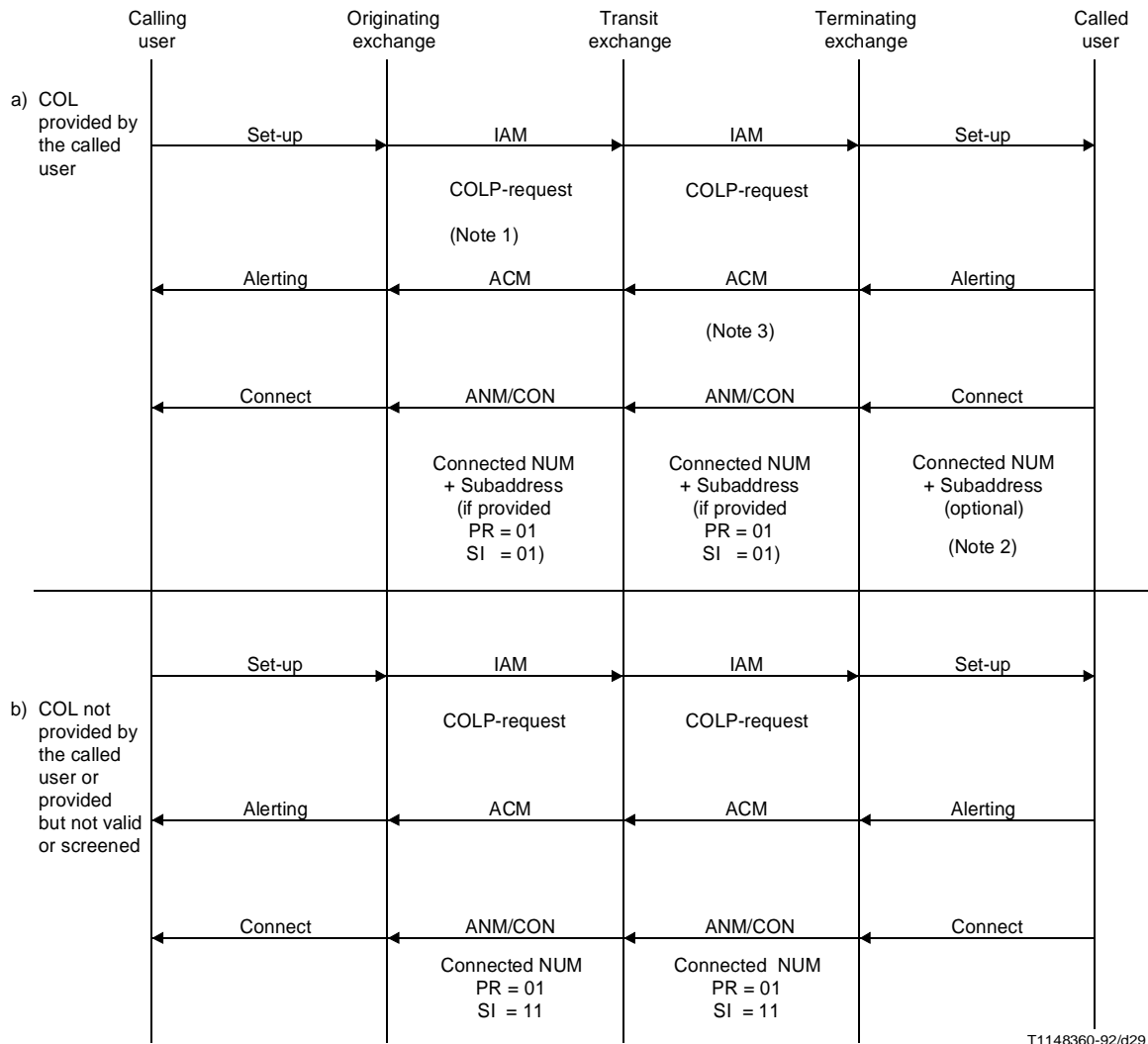

Note 1 – This service is subscribed by the calling user and the request is included by the originating exchange.
Note 2 – This service is subscribed by the called user and stored at the destination exchange.
Note 3 – The connect message is appropriate only if the answer condition is detected prior to the return of the address complete message.

FIGURE E-15/Q.767
Connected Line Identification Restriction

E.8.3 Nodal Signalling Function SDLs for COLP and COLR

Nodal signalling function procedures for COLP and COLR are described in Figures E-16/Q.767 to E-19/Q.767.

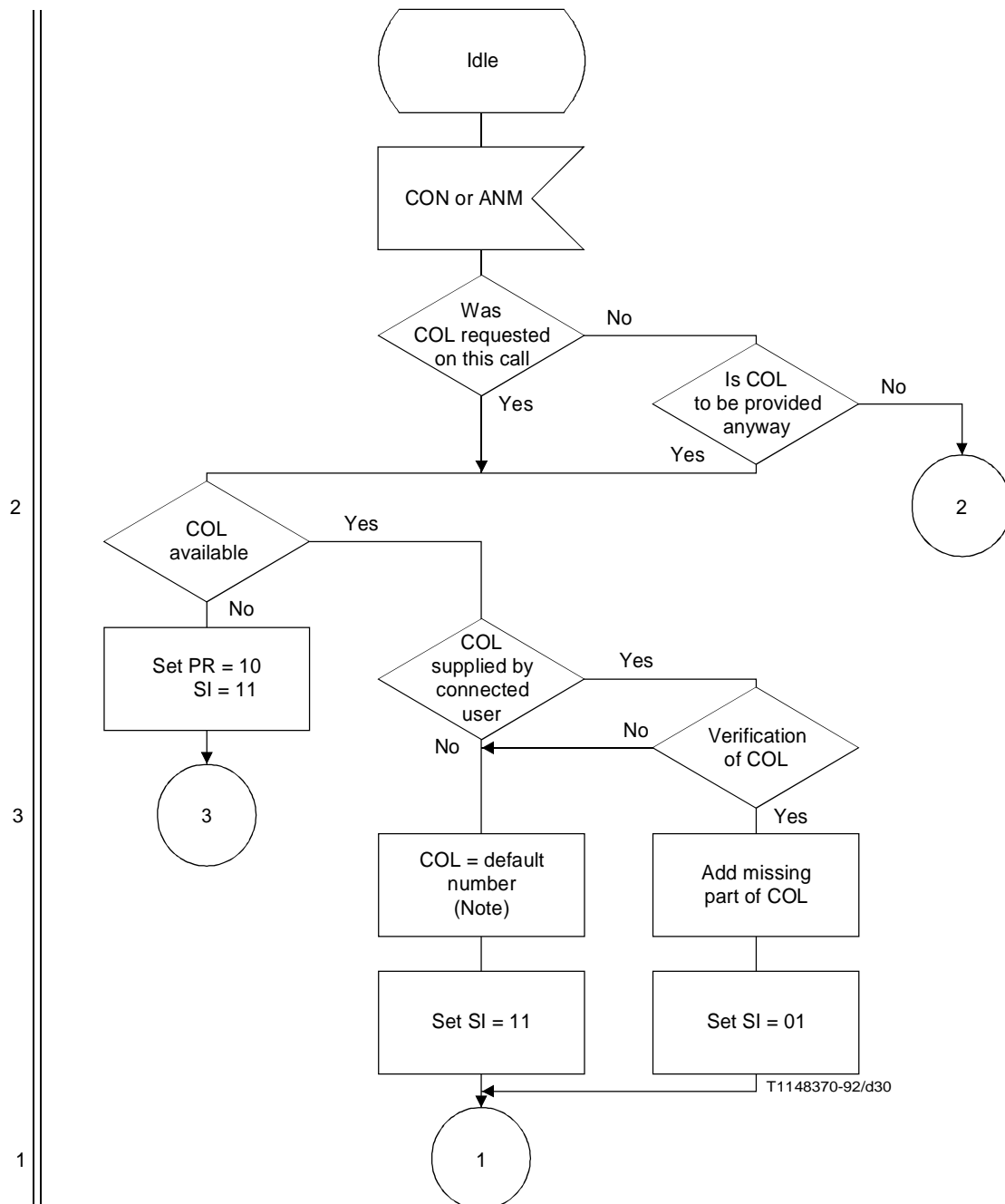

COL Connected line identity
 PR Presentation restriction
 SI Screening indicator

Note – The default number is a network supplied default number.

FIGURE E-16/Q.767 (sheet 1 of 2)

Nodal signalling functions for COLP and COLR terminating local exchange

(This figure is not applicable for the international interface and provided for information only)

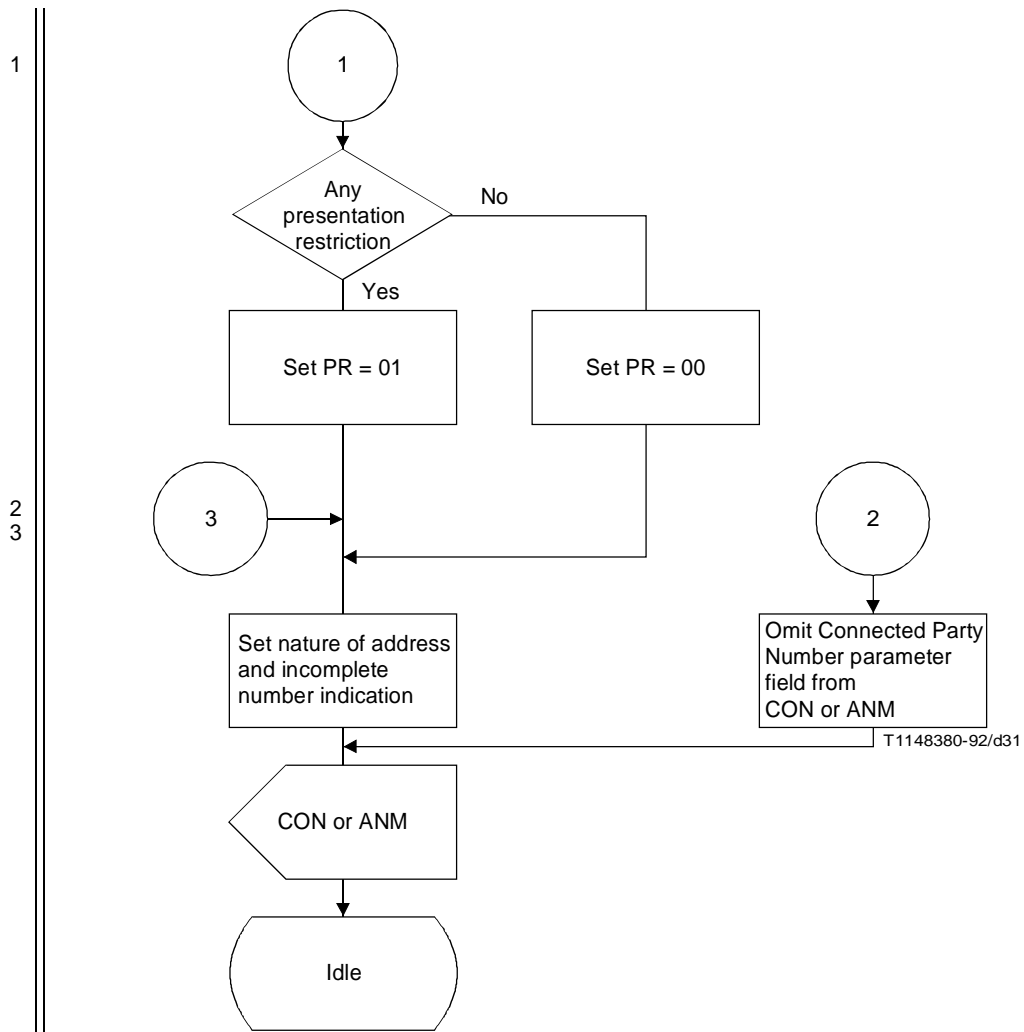

COL Connected line identity
 PR Presentation restriction
 SI Screening indicator

FIGURE E-16/Q.767 (sheet 2 of 2)

Nodal signalling functions for COLP and COLR terminating local exchange

(This figure is not applicable for the international interface and provided for information only)

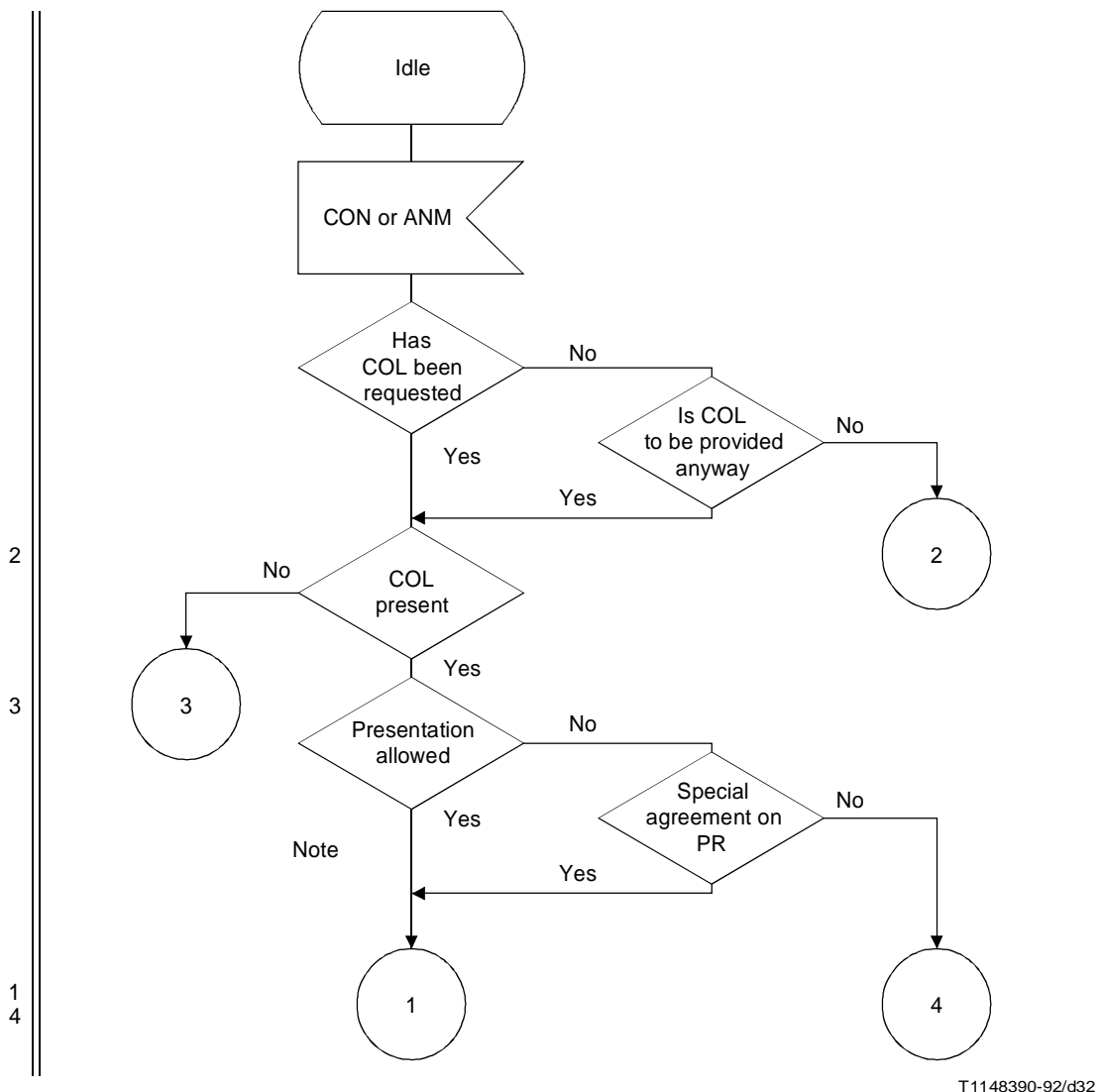

COL Connected line identity
 PR Presentation restriction
 SI Screening indicator

Note – This flow assumes that there is no restriction on passing non-restricted COL's across the international boundary if no such agreement exists then any COL in the incoming CON or ANM will be removed and the PR indicator set to 10."COL not available".

FIGURE E-17/Q.767 (sheet 1 of 2)

Nodal signalling function for COLP and COLR incoming international gateway

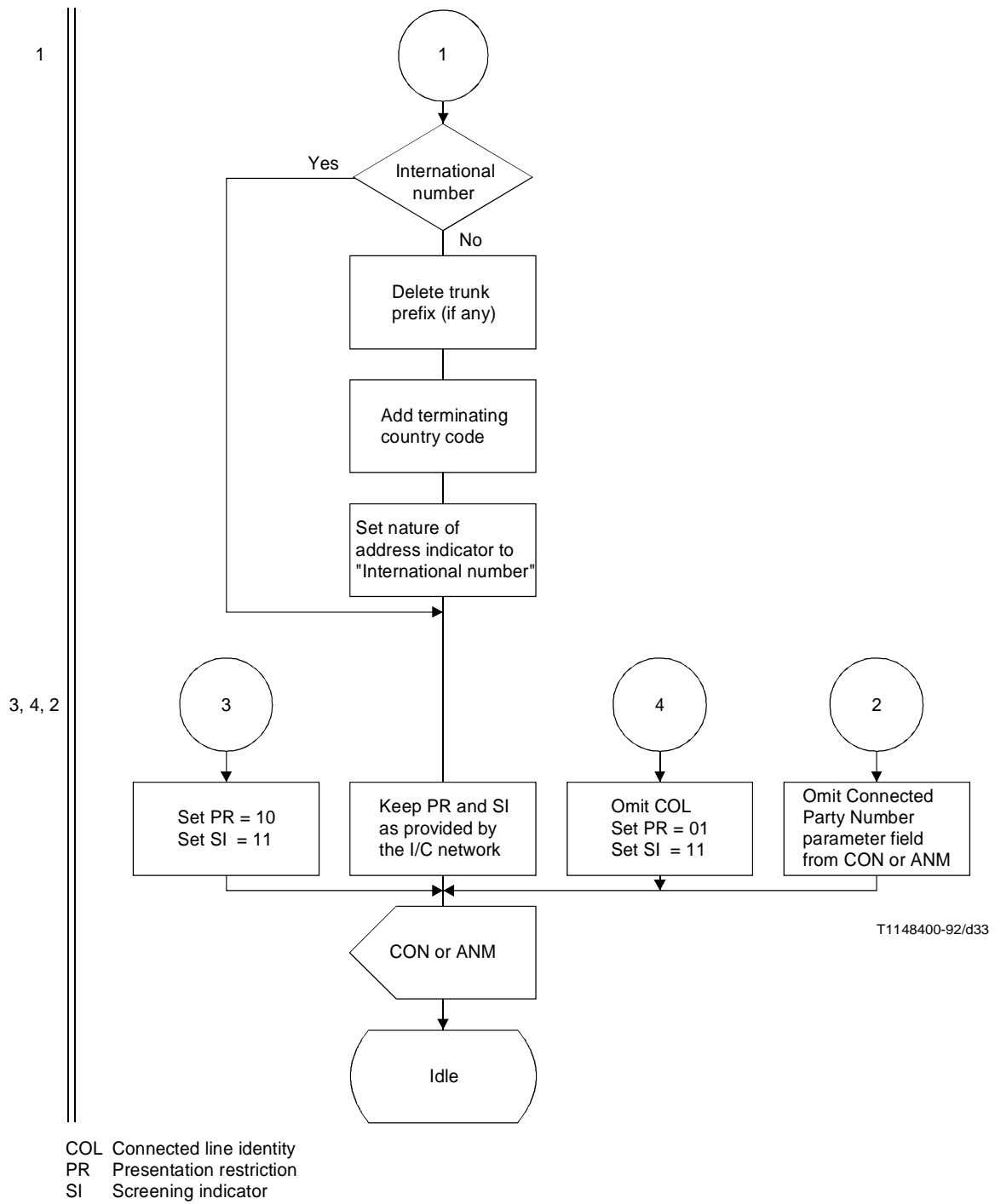
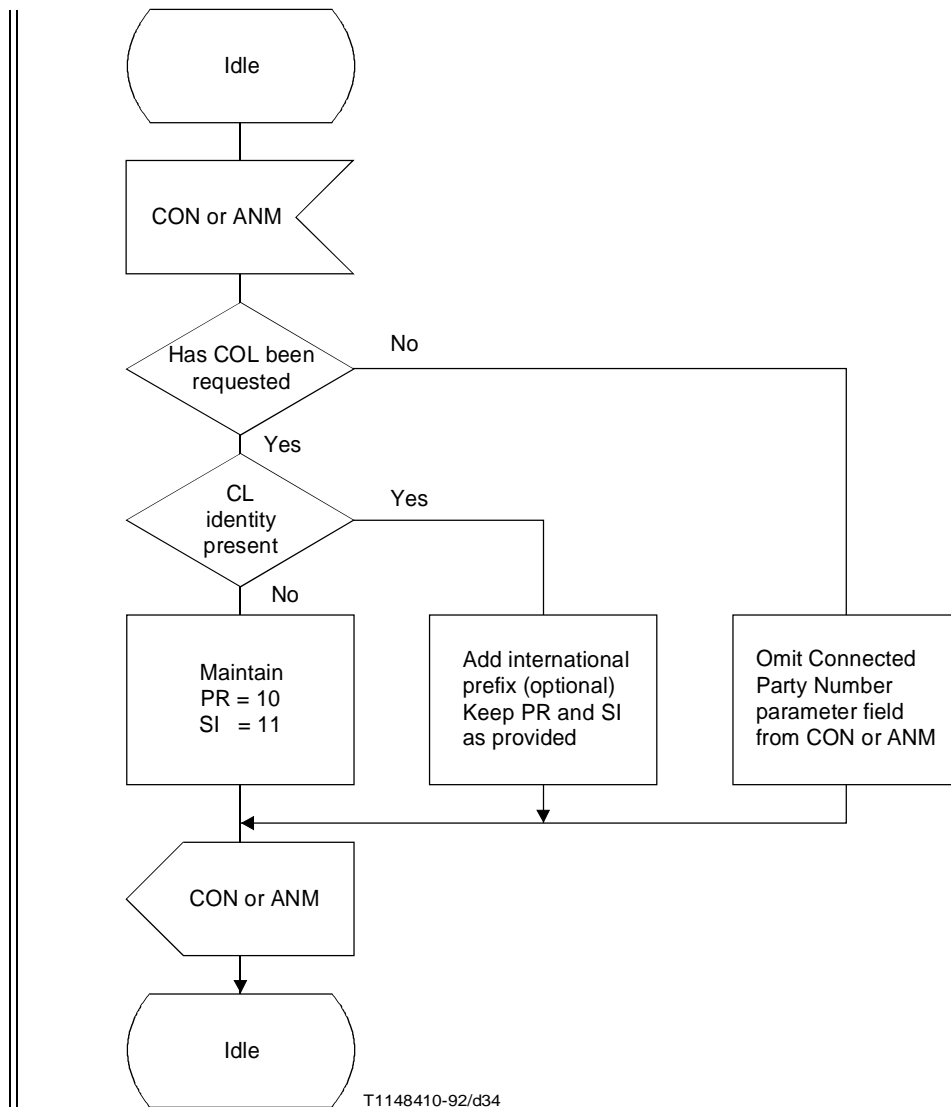

FIGURE E-17/Q.767 (sheet 2 of 2)

Nodal signalling function for COLP and COLR incoming international gateway



COL Connected line identity
 PR Presentation restriction
 SI Screening indicator

FIGURE E-18/Q.767

Nodal signalling function for COLP and COLR originating international gateway exchange

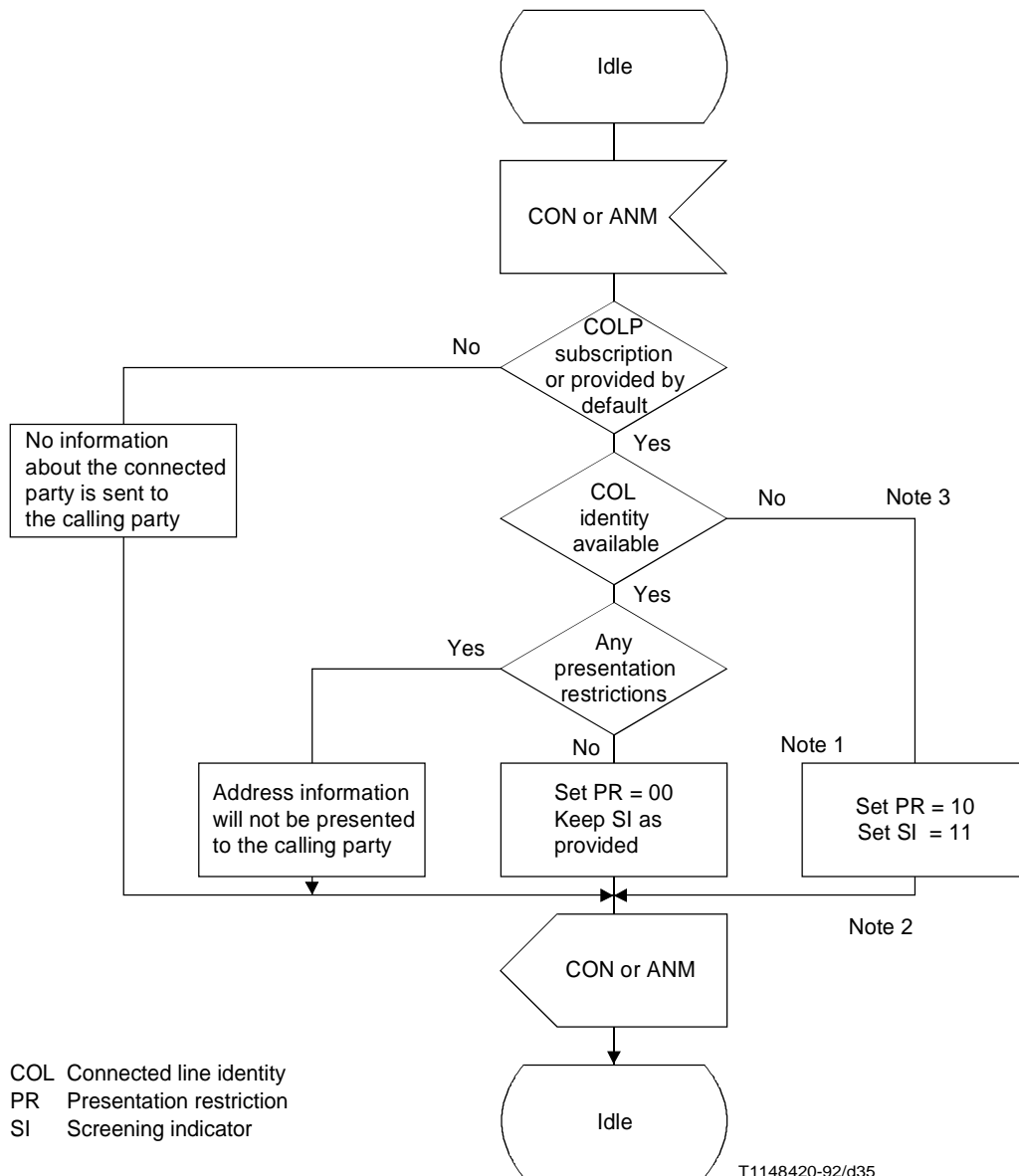

Note 1 – Presentation may be restricted due to national requirements or presentation restriction. Presentation restriction may be overridden due to calling party's category (e.g. Police).
Note 2 – In the case where the address information is indicated as not available due to interworking, etc. Only the indicators are presented to the user.
Note 3 – The "Connected Party Number parameter" is not included in the incoming CON or ANM.

FIGURE E-19/Q.767
Nodal signalling functions for COLP and COLR originating local exchange
 (This figure is not applicable for the international interface and provided for information only)

E.8.4 *Interaction of COLP with other supplementary services*

E.8.4.1 *Calling Line Identification Presentation*

No interaction.

E.8.4.2 *Calling Line Identification Restriction*

If a user has Calling Line Identification Restriction (CLIR) activated, then COLR will also be activated. Therefore, the number of the user will not be available for presentation on both incoming and outgoing calls.

E.8.4.3 *Connected Line Identification Restriction*

The Connected Line Identification will not be presented if the connected user has an arrangement to inhibit the presentation of his number to the calling party.

E.8.4.4 *Closed User Group*

No interaction.

E.8.4.5 *User-to-User Information*

No interaction.

E.8.5 *Interaction of COLR with other supplementary services*

E.8.5.1 *Calling Line Identification Presentation*

If a user has COLR activated, then CLIR will also be activated. Therefore, the number of the user will not be available for presentation on both incoming and outgoing calls.

E.8.5.2 *Calling Line Identification Restriction*

No interaction.

E.8.5.3 *Connected Line Identification Presentation*

COLR will take precedence over COLP.

The only occasion when a user subscribing to Connected Line Identification Presentation can take precedence over Connected Line Identification Restriction is when the user has override category. This is a national option.

E.8.5.4 *Closed User Group*

No interaction.

E.8.5.5 *User-to-User Information*

No interaction.