



INTERNATIONAL TELECOMMUNICATION UNION

CCITT

THE INTERNATIONAL
TELEGRAPH AND TELEPHONE
CONSULTATIVE COMMITTEE

Q.81.3

(11/1988)

SERIES Q: SWITCHING AND SIGNALLING

functions and information flows for services in the ISDN –
Supplementary services

**NUMBER IDENTIFICATION SUPPLEMENTARY
SERVICES – CALLING LINE IDENTIFICATION
PRESENTATION (CLIP)**

Reedition of CCITT Recommendation Q.81.3 published in
the Blue Book, Fascicle VI.1 (1988)

NOTES

1 CCITT Recommendation Q.81.3 was published in Fascicle VI.1 of the *Blue Book*. This file is an extract from the *Blue Book*. While the presentation and layout of the text might be slightly different from the *Blue Book* version, the contents of the file are identical to the *Blue Book* version and copyright conditions remain unchanged (see below).

2 In this Recommendation, the expression “Administration” is used for conciseness to indicate both a telecommunication administration and a recognized operating agency.

Recommendation Q.81.3

NUMBER IDENTIFICATION SUPPLEMENTARY SERVICES

3 Calling Line Identification Presentation (CLIP)

3.1 General

calling line identification presentation (CLIP) is a supplementary service offered to the called party which provides the calling party's ISDN number, possibly with sub-address information, to the called party.

3.2 Description

3.2.1 General description

When CLIP is applicable and activated, the network provides the called party with the number of the calling party at call setup on all incoming calls.

The calling party number may be accompanied by a sub-address.

The network should be capable of transmitting at least 15 digits (maximum length of an ISDN number). In addition, if provided by the calling party, the network should be capable of transmitting a sub-address. The length of the sub-address is defined in the relevant Recommendation.

The network to which the calling party belongs should attempt to ensure that enough digits are transmitted to enable the called party to return the call, based on the calling number presented.

3.2.2 Specific terminology

None identified.

3.2.3 Qualifications on the applicability to telecommunication services

This supplementary service is applicable to all telecommunication services.

It is to be noted that in the Telematic services, an exchange of terminal identification (TID) occurs at a higher layer subsequent to a successful call establishment.

For Telematic services this supplementary service shall consist only of the access number of the calling party and this shall be provided by the network. For other non-voice services this supplementary service is for further study. The presentation of the CLI by Telematic terminals and by other non-voice terminals is for further study.

3.3 Derivation of a functional model

This part of the description is common with the service calling line identification restriction since this service has some impact on calling line identification presentation.

The model used for illustrating the calling line identification services procedures is given below:

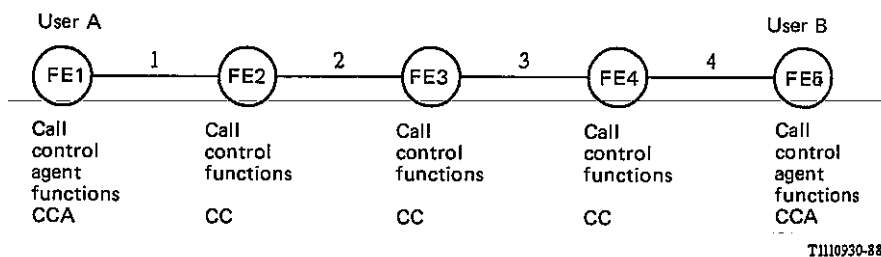

3.4 Information flow diagrams

The calling line identity information needed to provide the calling line identification services is normally carried in the messages used to establish the call.

The calling line identity will be delivered to the called party by his local exchange and/or ISPBX during the call establishment if the calling line identity is available and presentation is allowed.

If calling line identity is not available in the destination local or transit exchange at call request, the exchange may optionally request the calling line identity from the originating local exchange.

The specifications of functions for Calling Line Identification include adaptations for private network implementations (in a full private network environment) and mobile network implementations. Private Network/Public ISDN interworking situations are for further study.

The calling line identity is made up of a number of information units:

- the subscriber's national (ISDN) number, or
- private network (ISDN) number, or
- international ISDN number and possibly other indications only for international calls, or
- partial number (optional) (Note 1);
- optionally, sub-address information, if explicitly provided by the calling user;
- numbering plan identification;
- type of address.

In addition to the calling identity the subscriber may be given the following information:

- Presentation indicator (PI) showing:
 - a) presentation allowed, or
 - b) presentation restricted, or
 - c) number not available due to interworking (Note 2)
- Screening indicator (SI) showing:
 - a) user provided, verified and passed, or
 - b) network provided

Note 1 – For international calls the partial number may be the international prefix and the country code. For national calls the partial number may be the trunk prefix and the area code.

Note 2 – The technical solutions for the various interworking arrangements with dedicated networks have not been detailed in this document.

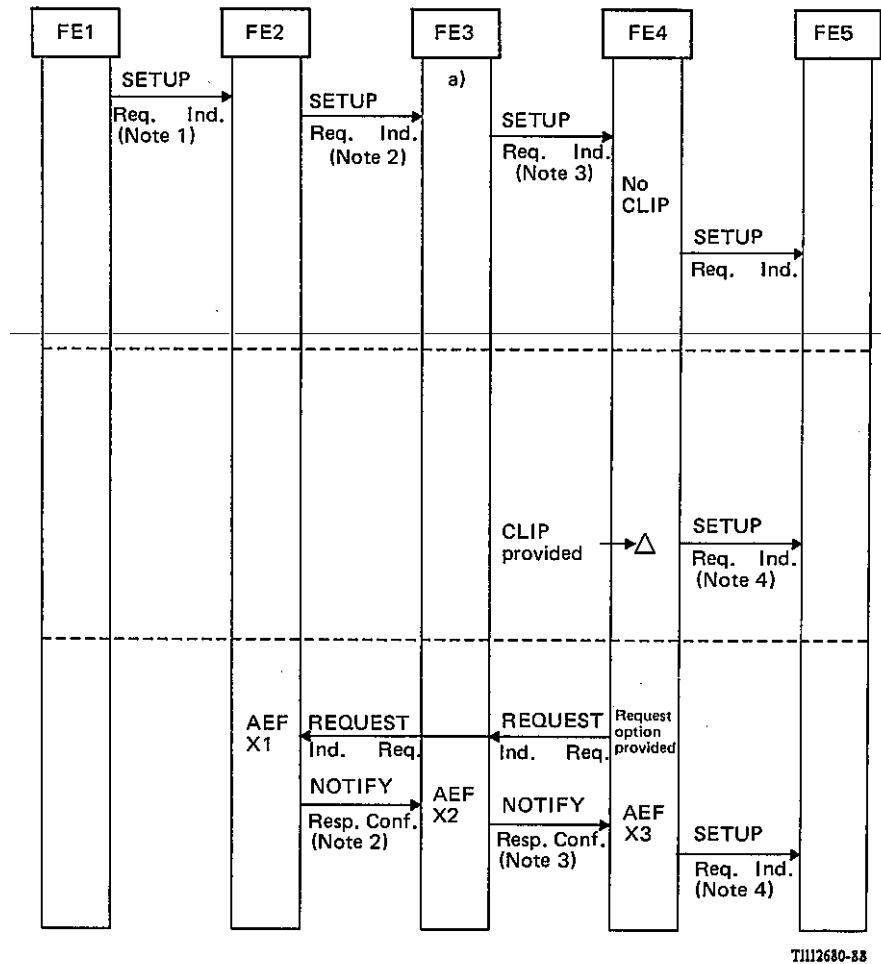

a) In case of a national call this setup is sent to a national trunk exchange or LE-B; FE3 is not needed.

FIGURE 3-1/Q.81

**Calling line identification presentation (CLIP) – Stage 2
Information flows for combined public and private configurations**

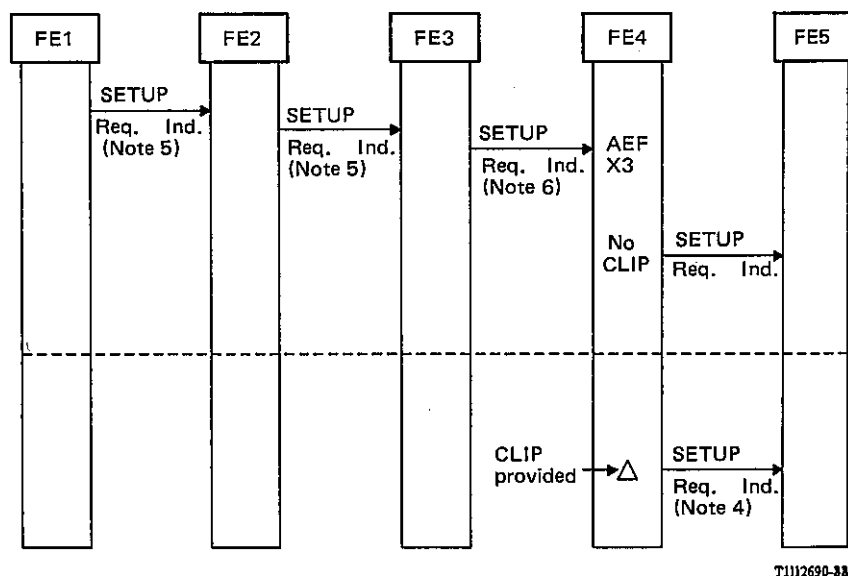

FIGURE 3-2/Q.81

**Calling line identification presentation (CLIP) – Stage 2
Private network**

Notes to Figures 3-1/Q.8 and 3-2/Q.81

Note 1 – The information flow contains:

- no information (should not be permitted for DDI-ISPBX in some networks);
- part of the subscriber number (extension number, selection on a passive bus);
- subscriber number;
- national number indicators;
- international number (for mobile application);
- numbering plan identification;
- type of address;
- presentation indicator (optional). Optional: sub-address.

Note 2 – The information flow contains:

- national number;
- if present: sub-address;
- international number;
- presentation indicator (allowed/restricted/not available due to interworking);
- screening indicator (network provided/subscriber provided, verified and passed);
- type of address;
- numbering plan identification.

Note 3 – The information flow contains:

- international number;
- no information (e.g. presentation restriction)
- if present: sub-address;
- presentation indicator (allowed/restricted/not available due to interworking);
- screening indicator (network provided/subscriber provided, verified and passed);
- type of address;
- numbering plan identification.

Note 4 – The information flow contains:

- no information;
- national number (for national calls);
- international number (for international calls);
- if present: sub-address;
- presentation indicator (allowed/restricted/not available due to interworking);
- screening indicator (network provided/subscriber provided, verified and passed);
- type of address;
- numbering plan identification.

Note 5 – The information flow contains:

- no information;
- part of the extension number (e.g. selection on a passive bus);
- extension number or private network number;
- optional: sub-address;
- type of address;
- numbering plan identification.

Note 6 – The information flow contains:

- extension number or private network number;
- if present: sub-address;
- presentation indicator (allowed/restricted/not available due to interworking);
- screening indicator (network provided/subscriber provided, verified and passed);
- type of address;
- numbering plan identification.

3.5 *SDL diagrams for functional entities*

FE2 – Determination of the calling line identity – originating side

The ability of an ISDN component to determine the calling line identity and if present, the sub-address. In public network the calling line identity is the national ISDN number, in private network the private network number and in mobile network the international ISDN number.

FE3 – Determination of the international calling line identity

The ability of an ISDN component to determine the international calling line identity and if present, the sub-address.

FE4 – Determination of the calling line identity – destination side

The ability of an ISDN component to determine the calling line identity and if present, the sub-address. In some networks the calling line identity given to an extension user connected to an ISPBX shall include outgoing prefix if the call is originated or passed through the public network.

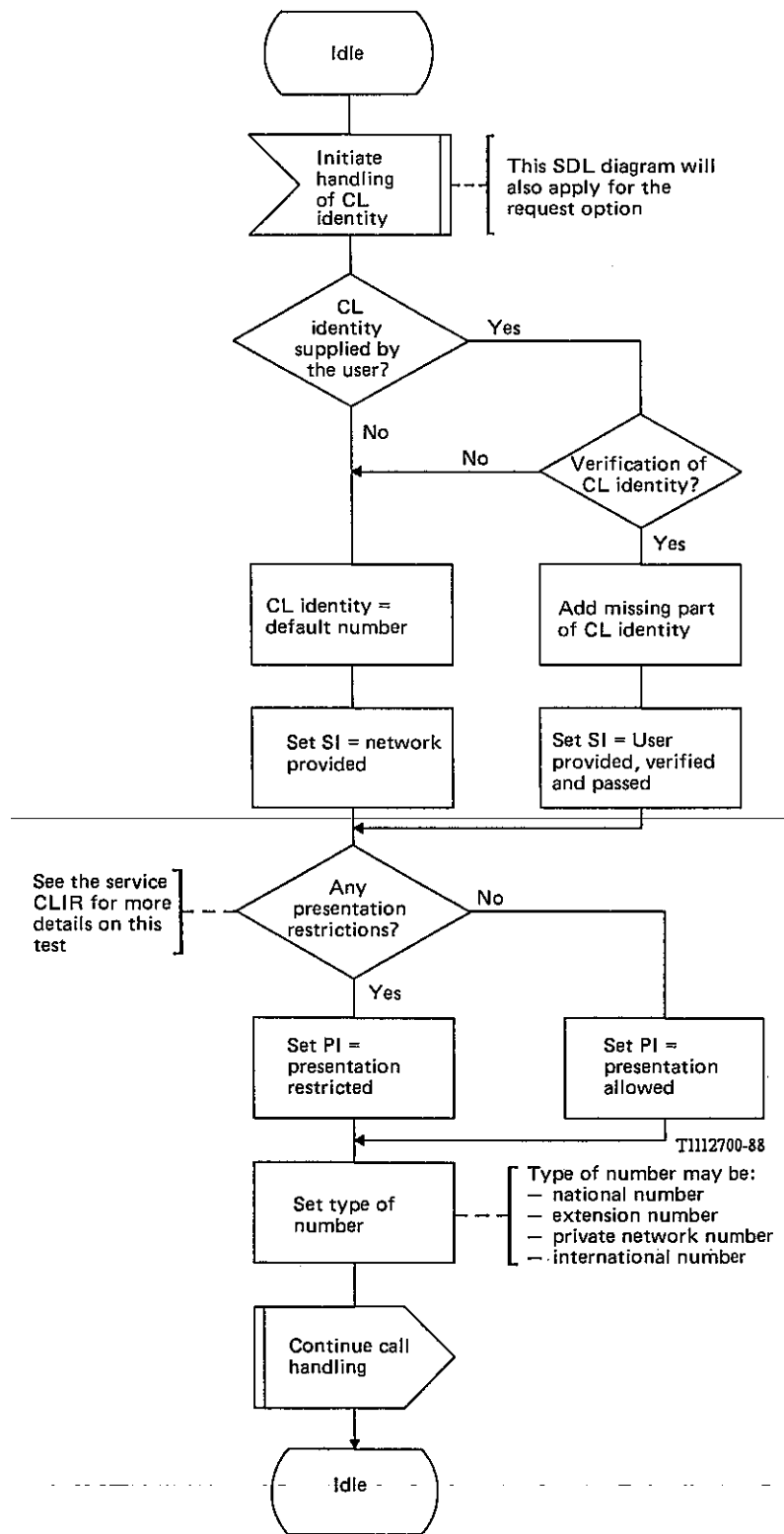

CL Calling line
 PI Presentation indicator
 SI Screening indicator

FIGURE 3-3/Q.81

FE2

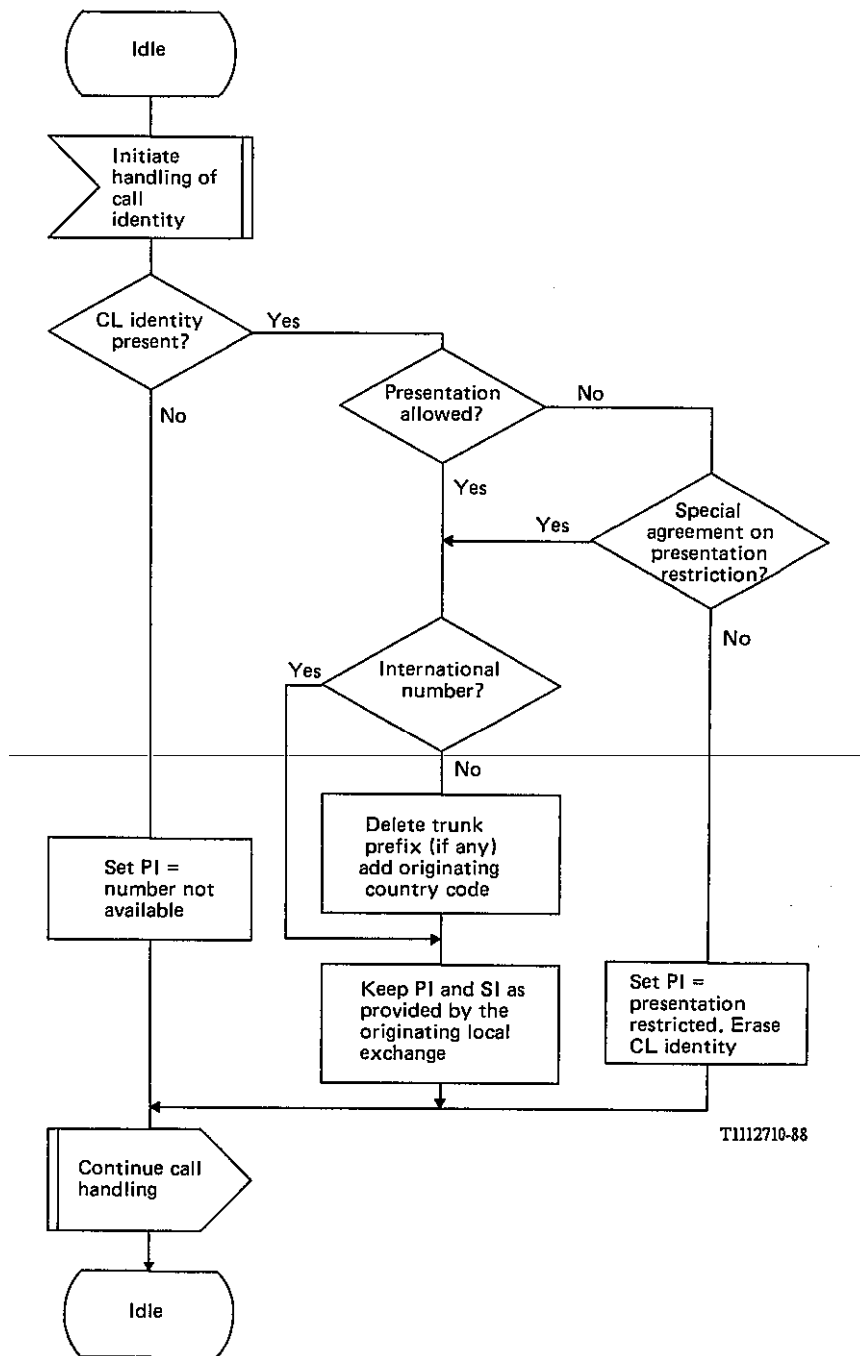

T1112710-38

CL Calling line
 PI Presentation indicator
 SI Screening indicator

FIGURE 3-4/Q.81 (Sheet 1 of 2)

FE3

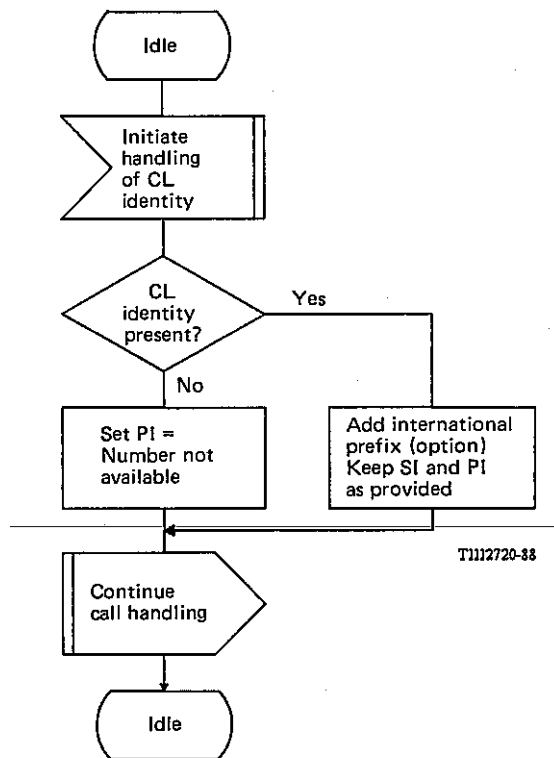

CL Calling line
 PI Presentation indicator
 SI Screening indicator

FIGURE 3-4/Q.81 (Sheet 2 of 2)

FE3

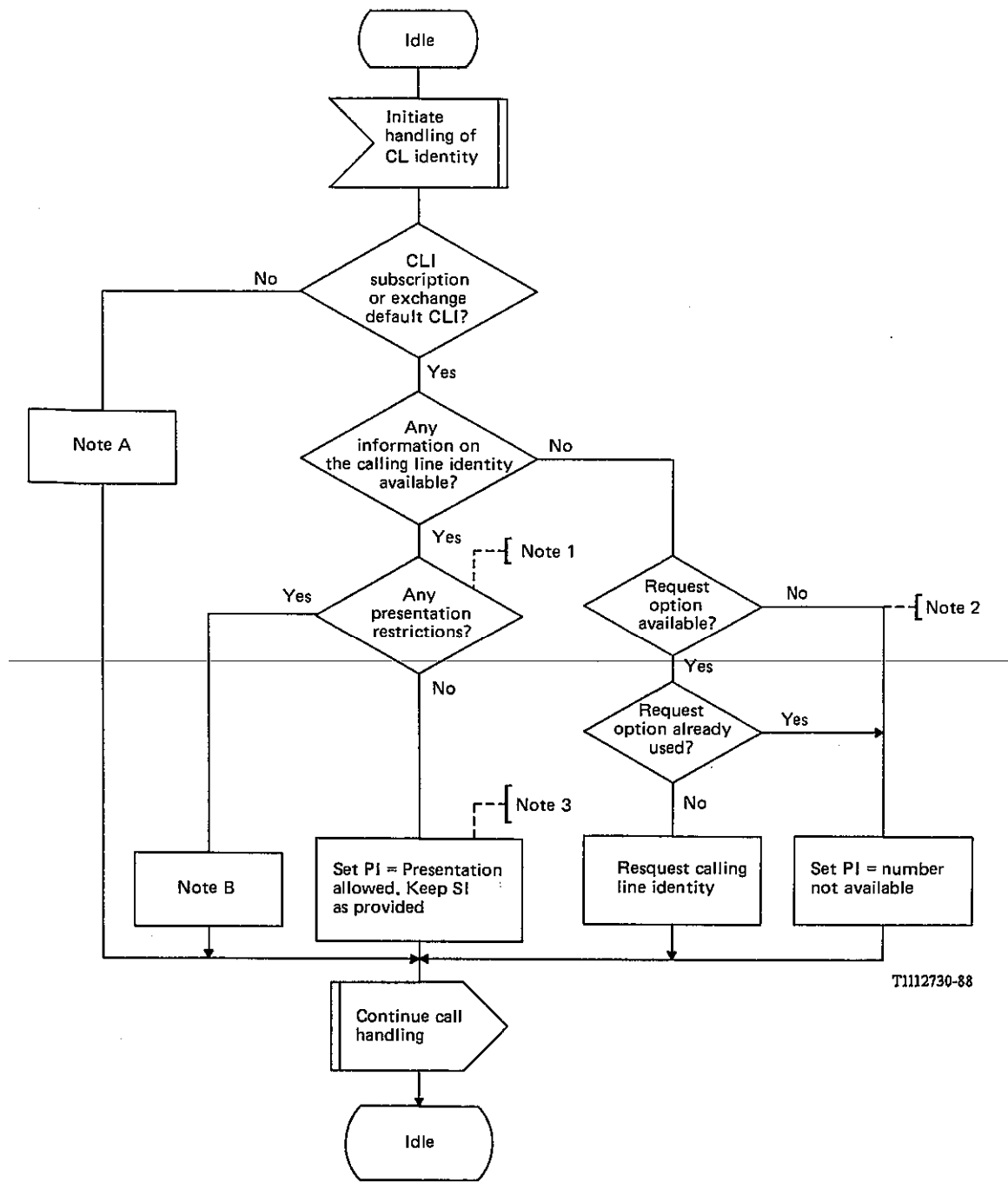

T1112730-88

CL Calling line
 PI Presentation indicator
 SI Screening indicator

FIGURE 3-5/Q.81

FE4

Notes to Figure 3-5/Q.81

Note A – No information about the identity of the calling party is sent to the called party.

Note B – Set PI – Presentation restricted, address information will not be presented to the called party.

Note 1 – Presentation may be restricted due to national regulations or presentation restriction.

Presentation restriction may be overridden due to the called party's category (e.g. police).

Note 2 – The request option is not supported by private networks (CL identity is always included). The request option is not defined by Study Group XVIII.

Note 3 – In the case where the address information is not available due to interworking, only the indicators are presented to the user.

3.6 Functional entity actions

3.6.1 Functional entity actions for FE2

- Check if calling line identity is provided from the user;
- verify (and complete) calling line identity;
- set PI and SI;
- set type of number.

3.6.2 Functional entity actions for FE3

- check if calling line identity may be passed between Administrations;
- at the originating side: provide international number;
- at the destination side: add international prefix.

3.6.3 Functional entity actions for FE4

- check CLIP subscription;
- check if calling line identity is provided from FE3;
- request the calling line identity (optional);
- check for CLIR and if presentation is allowed pass CLI to FE5.

3.7 Allocation of functional entities to physical location

Functional entity Scenario	FE1	FE2	FE3	FE4	FE5
National call	TE	LE		LE	TE
International call	TE	LE	TR	LE	TE
Call between NT2s	NT2	LE	(TR)	LE	NT2
Call between NT2-TE	NT2	LE	(TR)	LE	TE
National private network	TE	NT2		NT2	TE
International private network	TE	NT2	TR/NT2	NT2	TE

Note – (TR) means that this functional entity is included in the case of international calls.

ITU-T RECOMMENDATIONS SERIES

Series A	Organization of the work of the ITU-T
Series B	Means of expression: definitions, symbols, classification
Series C	General telecommunication statistics
Series D	General tariff principles
Series E	Overall network operation, telephone service, service operation and human factors
Series F	Non-telephone telecommunication services
Series G	Transmission systems and media, digital systems and networks
Series H	Audiovisual and multimedia systems
Series I	Integrated services digital network
Series J	Transmission of television, sound programme and other multimedia signals
Series K	Protection against interference
Series L	Construction, installation and protection of cables and other elements of outside plant
Series M	TMN and network maintenance: international transmission systems, telephone circuits, telegraphy, facsimile and leased circuits
Series N	Maintenance: international sound programme and television transmission circuits
Series O	Specifications of measuring equipment
Series P	Telephone transmission quality, telephone installations, local line networks
Series Q	Switching and signalling
Series R	Telegraph transmission
Series S	Telegraph services terminal equipment
Series T	Terminals for telematic services
Series U	Telegraph switching
Series V	Data communication over the telephone network
Series X	Data networks and open system communications
Series Y	Global information infrastructure and Internet protocol aspects
Series Z	Languages and general software aspects for telecommunication systems