



INTERNATIONAL TELECOMMUNICATION UNION

ITU-T

TELECOMMUNICATION
STANDARDIZATION SECTOR
OF ITU

Q.84

(03/93)

**GENERAL RECOMMENDATIONS ON TELEPHONE
SWITCHING AND SIGNALLING**

**FUNCTIONS AND INFORMATION FLOWS FOR
SERVICES IN THE ISDN**

**STAGE 2 DESCRIPTION FOR MULTIPARTY
SUPPLEMENTARY SERVICES**

CLAUSE 1 – CONFERENCE CALLING (CONF)

ITU-T Recommendation Q.84

(Previously "CCITT Recommendation")

FOREWORD

The ITU Telecommunication Standardization Sector (ITU-T) is a permanent organ of the International Telecommunication Union. The ITU-T is responsible for studying technical, operating and tariff questions and issuing Recommendations on them with a view to standardizing telecommunications on a worldwide basis.

The World Telecommunication Standardization Conference (WTSC), which meets every four years, established the topics for study by the ITU-T Study Groups which, in their turn, produce Recommendations on these topics.

ITU-T Recommendation Q.84, clause 1, was prepared by the ITU-T Study Group XI (1988-1993) and was approved by the WTSC (Helsinki, March 1-12, 1993).

NOTES

1 As a consequence of a reform process within the International Telecommunication Union (ITU), the CCITT ceased to exist as of 28 February 1993. In its place, the ITU Telecommunication Standardization Sector (ITU-T) was created as of 1 March 1993. Similarly, in this reform process, the CCIR and the IFRB have been replaced by the Radiocommunication Sector.

In order not to delay publication of this Recommendation, no change has been made in the text to references containing the acronyms "CCITT, CCIR or IFRB" or their associated entities such as Plenary Assembly, Secretariat, etc. Future editions of this Recommendation will contain the proper terminology related to the new ITU structure.

2 In this Recommendation, the expression "Administration" is used for conciseness to indicate both a telecommunication administration and a recognized operating agency.

CONTENTS

	<i>Page</i>
1 Conference calling (CONF)	1
1.1 Scope	1
1.2 References.....	1
1.3 Definitions	2
1.4 Symbols and abbreviations	2
1.5 Description.....	2
1.6 Derivation of a functional model	3
1.7 Information flows	4
1.8 SDL diagrams for functional entities.....	17
1.9 Functional Entity Actions (FEAs)	41
1.10 Allocation of functions to physical entities	43

SUMMARY

This Recommendation describes the stage 2 of the Conference calling supplementary service supported by an ISDN.

The stage 2 descriptions are comprised of the switching functions and signalling information flows.

The Conference calling supplementary service provides a user with the ability to have a multi-connection between more than two parties.

**STAGE 2 DESCRIPTION FOR MULTIPARTY SUPPLEMENTARY SERVICES
CLAUSE 1 – CONFERENCE CALLING (CONF)**

(Helsinki, 1993)

1 Conference calling (CONF)

1.1 Scope

This Recommendation defines the stage 2 of the Integrated Services Digital Network (ISDN) as provided by telecommunications operators for the Conference calling (CONF) supplementary service. Stage 2 identifies the functional capabilities and the information flows needed to support the service as described in stage 1. The stage 2 description also identifies user operations not directly associated with a call (see Recommendation I.130 [1]).

This Recommendation is specified according to the methodology specified in Recommendation Q.65 [2].

This Recommendation does not formally describe the relationship between this supplementary service and the basic call [4] but where possible the information is included for guidance.

In addition, this Recommendation does not specify the requirements where the service is provided to the user via a private ISDN. This Recommendation does not specify the requirements for the allocation of defined functional entities within a private ISDN; it does however specify which functional entities may be allocated to a private ISDN.

This Recommendation does not specify the additional requirements where the service is provided to the user via a telecommunications network that is not an ISDN.

The Conference calling supplementary service provides a user with the ability to have a multi-connection call, i.e. a simultaneous communication between more than two parties.

The Conference calling supplementary service is defined for all telecommunication services carrying speech.

This Recommendation is applicable to the stage 3 Recommendations for the Integrated Services Digital Network Conference calling supplementary service. The term stage 3 is also defined in Recommendation I.130. Where the text indicates the status of a requirement, i.e. as strict command or prohibition, as authorization leaving freedom, as a capability or possibility, this shall be reflected in the text of the relevant stage 2 and 3 Recommendations.

Furthermore, conformance to this Recommendation is met by conforming to the stage 3 Recommendation with the field of application appropriate to the equipment being implemented. Therefore, no method of testing is provided for this Recommendation.

1.2 References

These references are cited at the appropriate places in the text and the publications are listed hereafter. For dated references subsequent amendments to, or revisions of, any of these publications apply to this Recommendation only when incorporated in it by amendment or revision. For undated references, the latest edition of the publication referred to applies.

[1] CCITT Recommendation I.130 *Method for the characterization of telecommunication services supported by an ISDN and network capabilities of an ISDN*, 1988.

[2] CCITT Recommendation Q.65 *Stage 2 of the method for the characterization of services supported by and ISDN*, 1988.

- [3] CCITT Recommendation I.112 *Vocabulary of terms for ISDNs*, 1988.
- [4] CCITT Recommendation Q.71 *ISDN 64 kbit/s circuit mode switched bearer service*, 1992.
- [5] CCITT Recommendation I.254.1 *Integrated Services Digital Network (ISDN); Conference calling (CONF) supplementary service; service description*.
- [6] CCITT Recommendation Z.100 *SDL Specification Description Language*, 1988.

1.3 Definitions

For the purpose of this Recommendation, the following definitions apply:

conference controller: The served user controlling the conference.

conferee: A conference participant not being the conference controller.

multi connection call control: A CC entity with the ability to control one connection directly and several others via OCCC entities.

one connection call control: A CC entity with the ability to control a single connection for a MCCC entity.

party: Either a conferee or the conference controller.

forward connection: The connection between a CC located with the Service Providing Entity and a conferee's CCA.

backward connection: The connection between the served user's CCA and a CC located with the Service Providing Entity.

1.4 Symbols and abbreviations

CId	Conference Identifier
CONF	Conference calling
FEA	Functional Entity Action
ISDN	Integrated Services Digital Network
LE	Local Exchange
MCCC	Multi Connection Call Control
OCCC	One Connection Call Control
PIId	Party Identifier
PNX	Private Network Exchange
SDL	Specification and Description Language
TE	Terminal Equipment

1.5 Description

Conference calling supplementary service can be invoked either from the idle state or as a network option from an existing active call.

When conference calling supplementary service is invoked, conference resources (e.g. a "bridge") are allocated to the served user. In the case of invocation from an active call, this will be automatically connected by the network to the conference resources.

Once a conference is active, parties may be added, dropped, isolated (i.e. prevented from communicating with the conference), reattached or split (i.e. removed from the conference but remain connected to the conference controller).

1.6 Derivation of a functional model

1.6.1 Functional model description

The model has been based on the concept that the served user maintains by means of FE1 a single relation to the centre of the conference FE2. FE2 has the ability to have simultaneous relations with all the conferees.

This concept has been depicted in Figure 1-1.

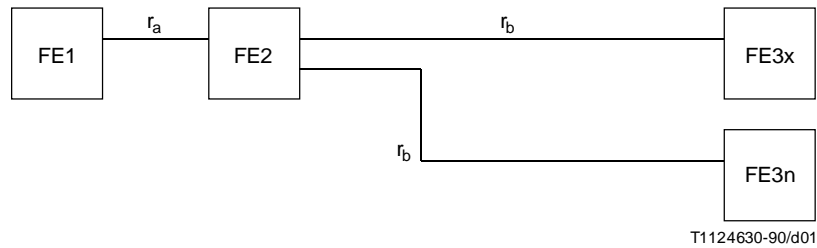

FIGURE 1-1/Q.84

NOTE – FE3x is the functional entity which belongs to that party which is explicitly identified by the conference controller (e.g. DROP party-X). FE3n are the functional entities which belong to the parties not identified by the conference controller (e.g. all parties except party-X).

1.6.2 Description of functional entities

FE1 Originating service agent

FE2 Service providing entity

FE3 Destination service agent

1.6.3 Relation with a basic service

The relationship with a basic service is shown in Figure 1-2.

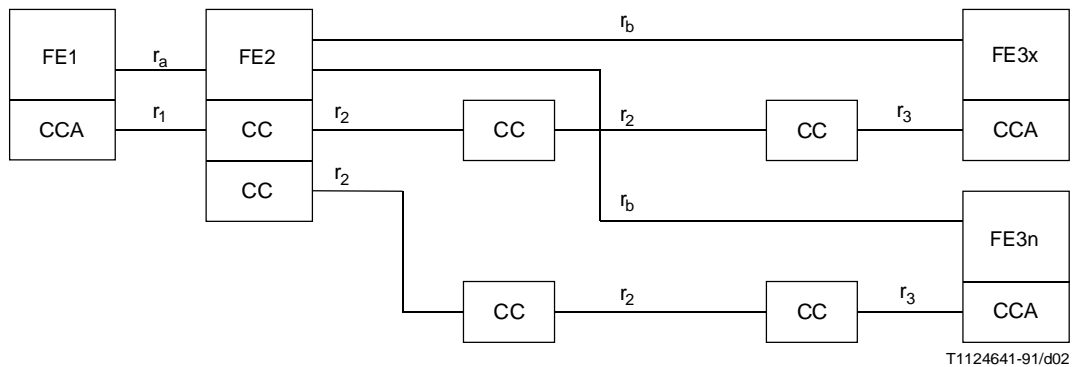

FIGURE 1-2/Q.84

1.7 Information flows

1.7.1 Information flows diagrams

The following information flow diagrams are identified:

- Figure 1-3 Requesting a new conference call;
- Figure 1-4 Change normal call into a conference call;
- Figure 1-5 Adding a new conferee;
- Figure 1-6 Isolating a conferee;
- Figure 1-7 Reattaching a conferee;
- Figure 1-8 Dropping a conferee from the conference;
- Figure 1-9 Splitting a conferee from the conference;
- Figure 1-10 Call clearing by conferee;
- Figure 1-11 Disconnect when floating is not allowed;
- Figure 1-12 Disconnect when floating is allowed;
- Figure 1-13 Terminate conference;
- Figure 1-14 Disconnect controller.

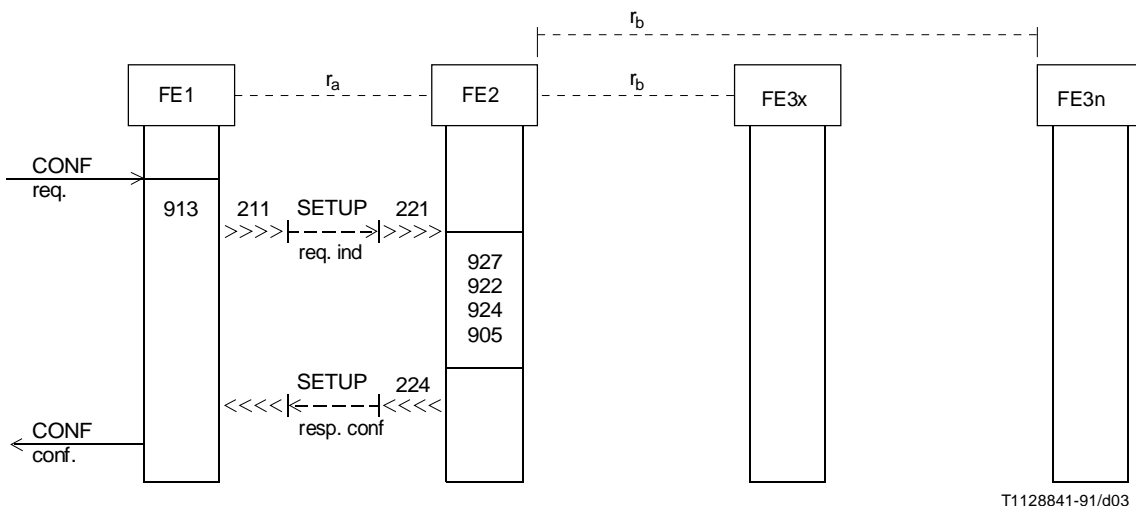
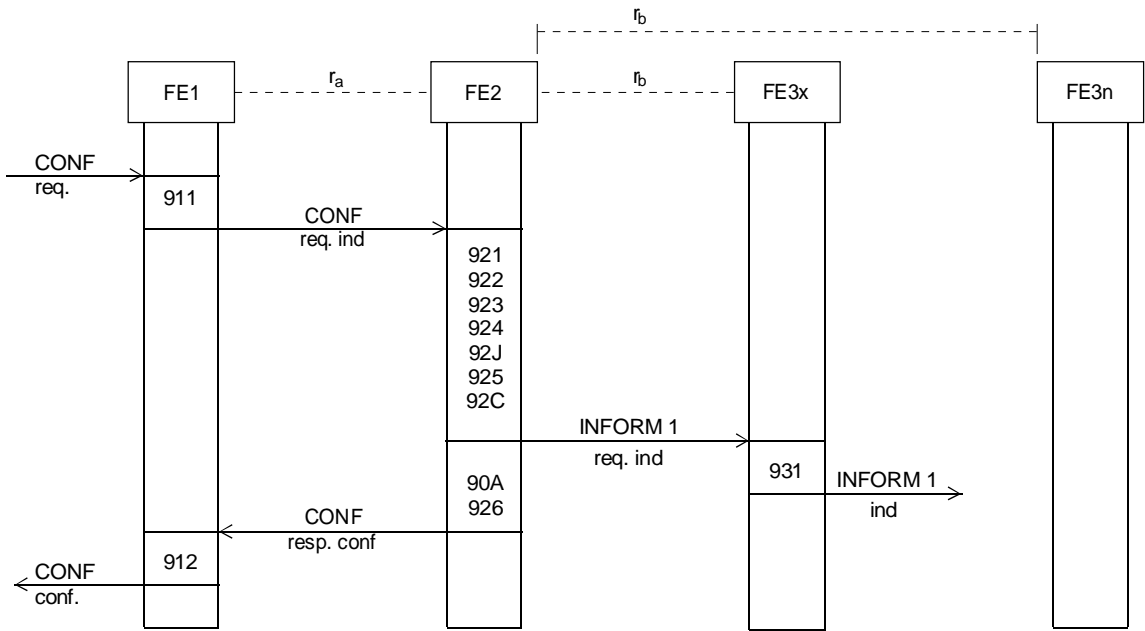

FIGURE 1-3/Q.84
Requesting a new conference call

1.7.2 Definition of individual information flows

1.7.2.1 Modification to relationship r_1 associated with r_a

The CONF supplementary service defines the following modifications to the r_1 relationship.



T1128851-91/d04

FIGURE 1-4/Q.84
Change normal call into a conference call

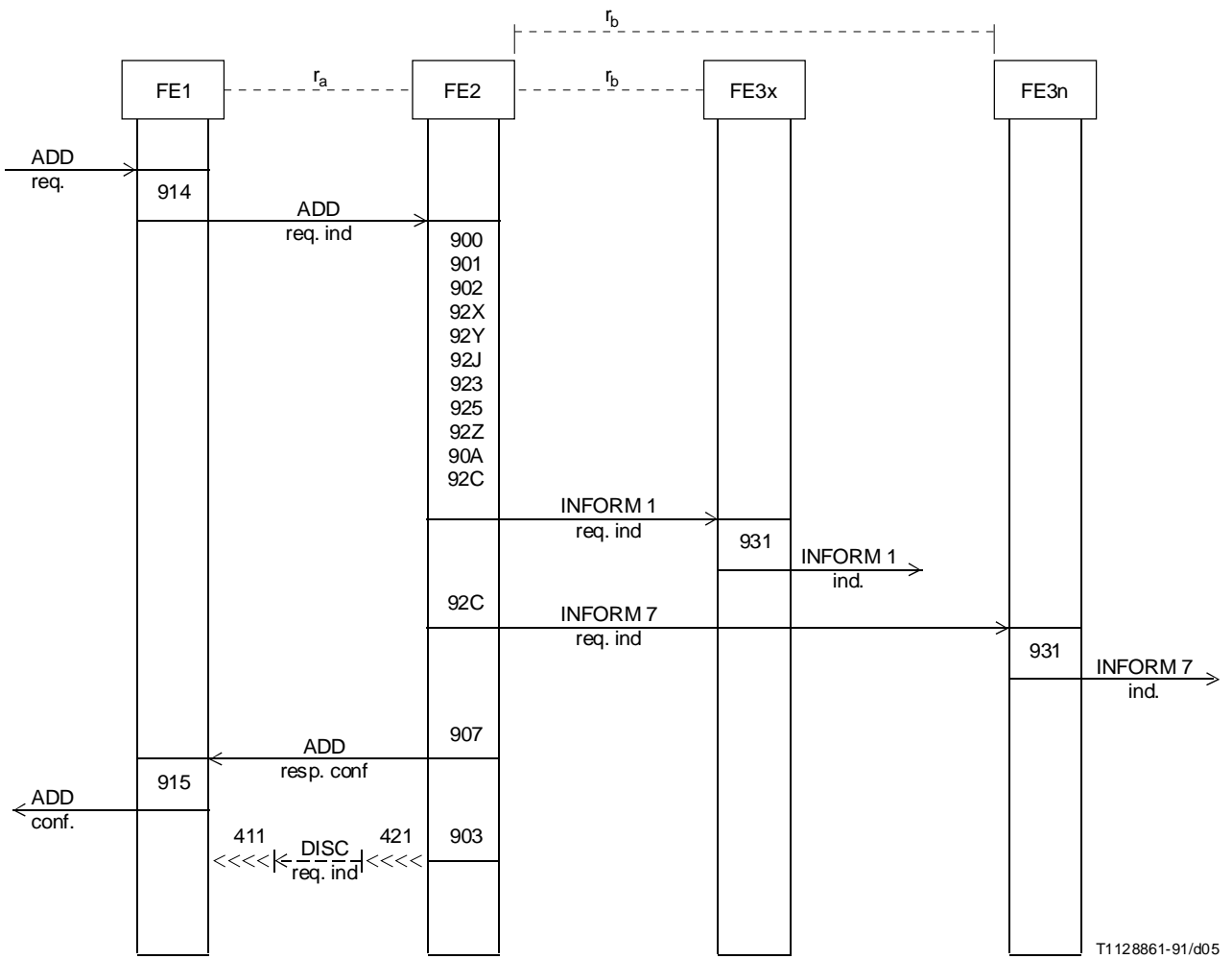

FIGURE 1-5/Q.84
Adding a new conferee

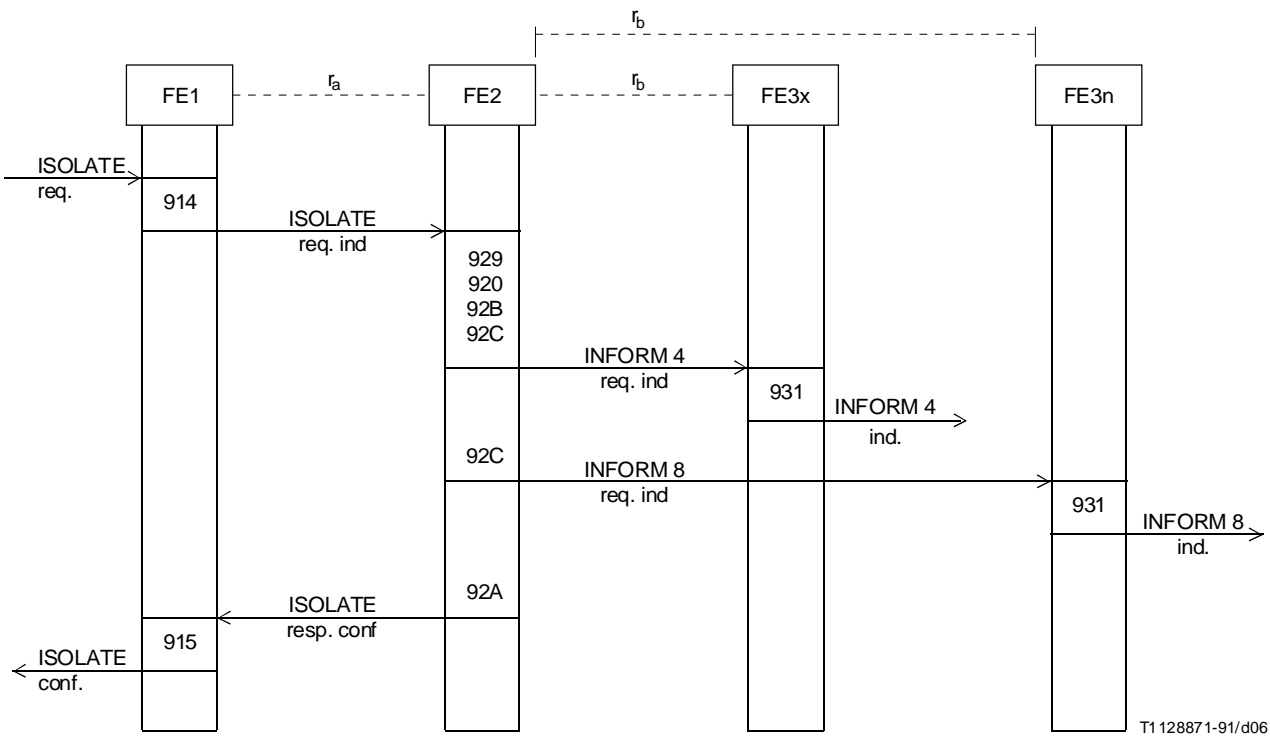

FIGURE 1-6/Q.84
Isolating a conferee

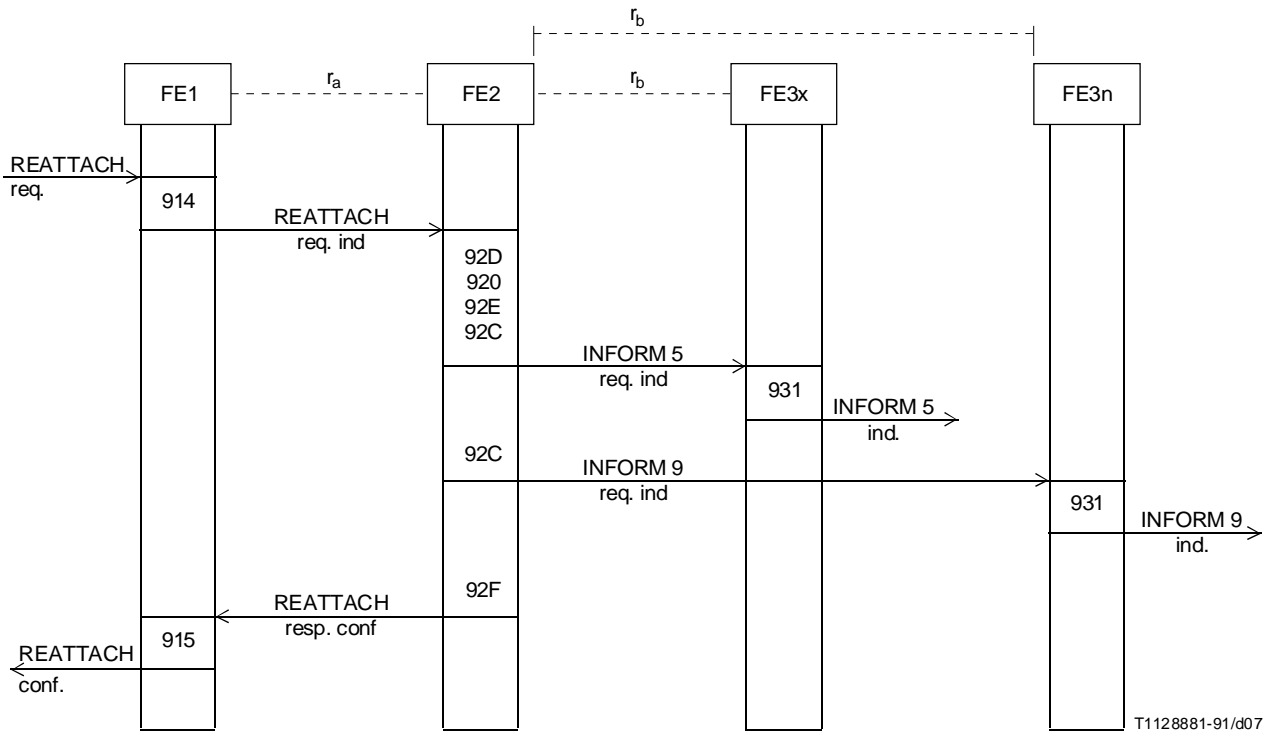
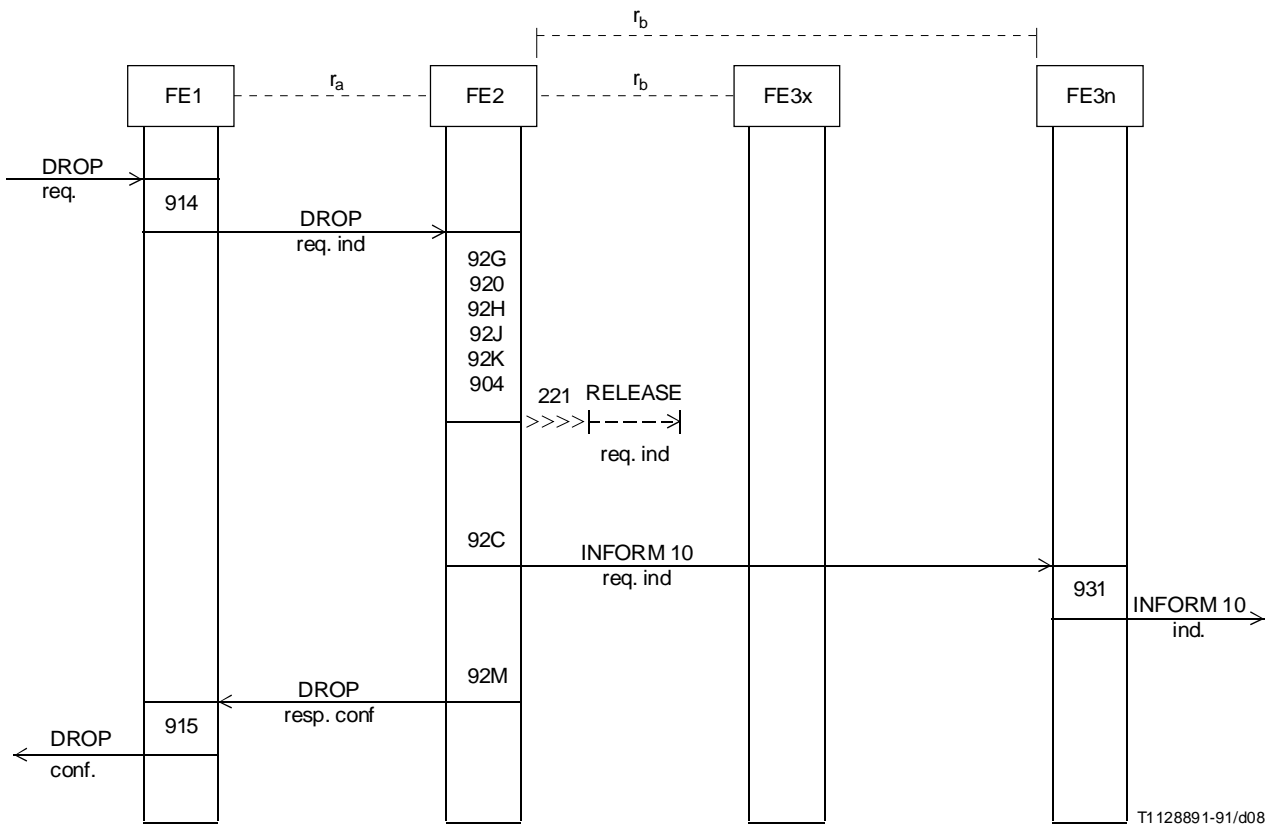
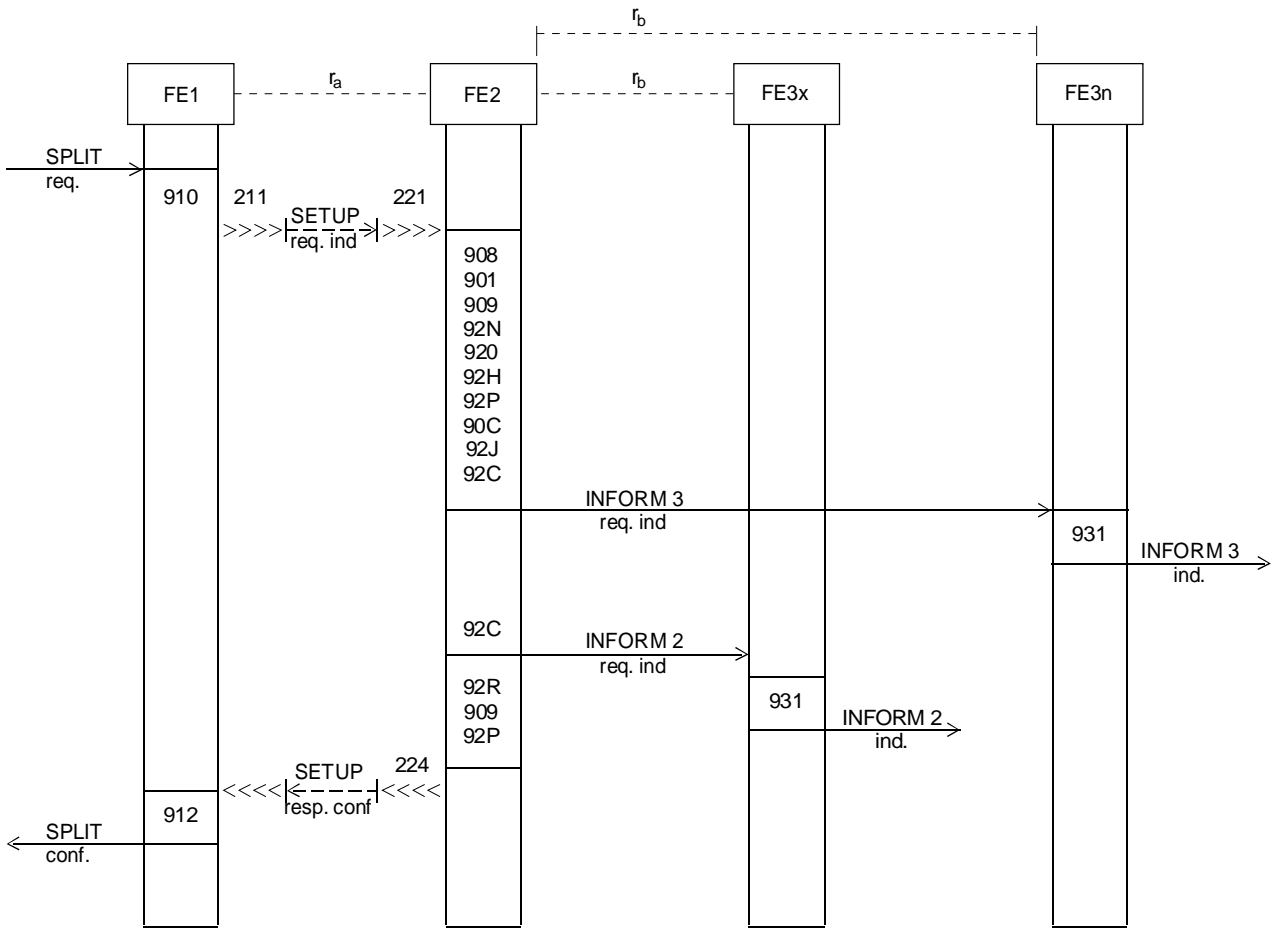

FIGURE 1-7/Q.84
Reattaching a conferee



T1128891-91/d08

FIGURE 1-8/Q.84
Dropping a conferee



T1128901-91/d09

FIGURE 1-9/Q.84
Splitting a conferee

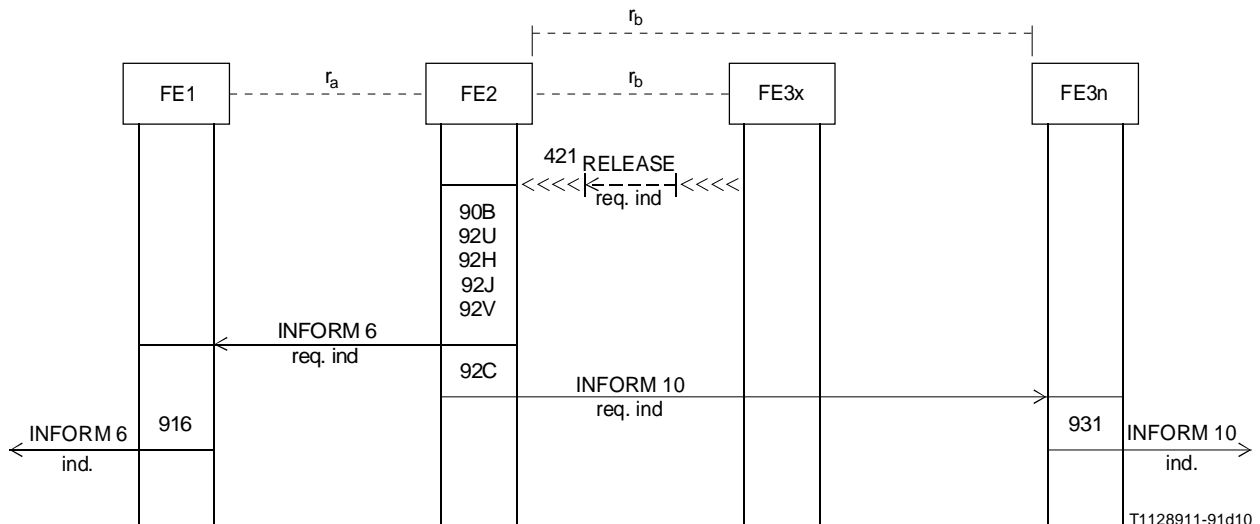

T1128911-91d10

FIGURE 1-10/Q.84
Call clearing by conferee

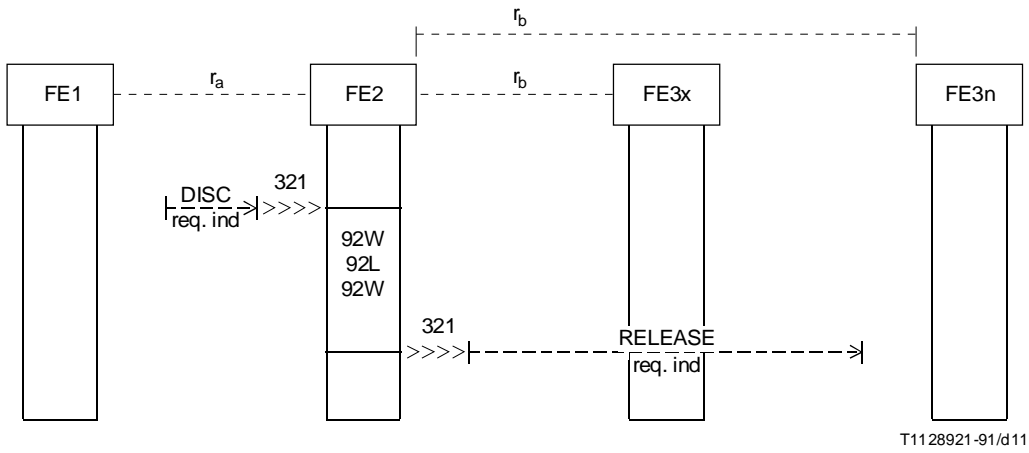

T1128921-91/d11

FIGURE 1-11/Q.84
Disconnect when floating is not allowed

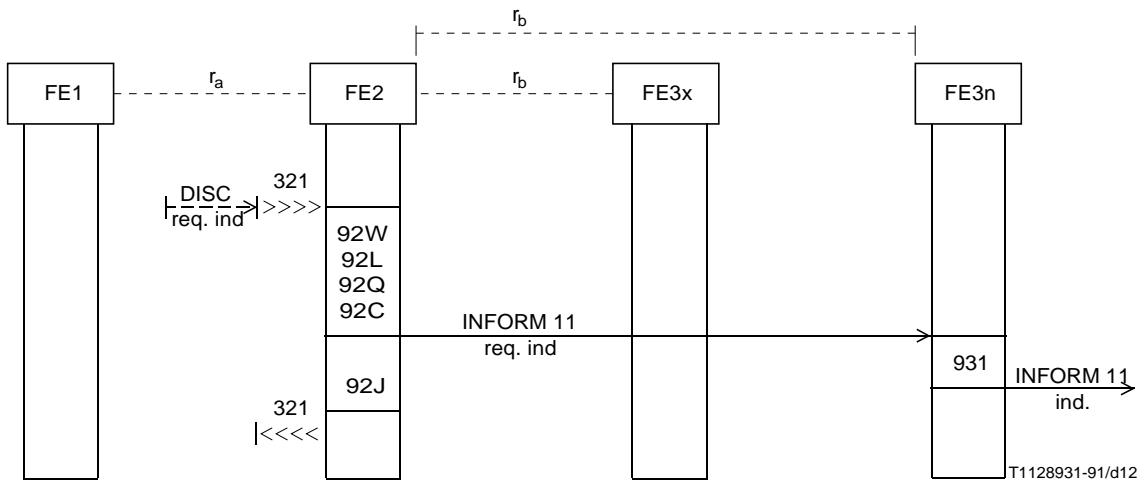

T1128931-91/d12

FIGURE 1-12/Q.84
Disconnect when floating is allowed

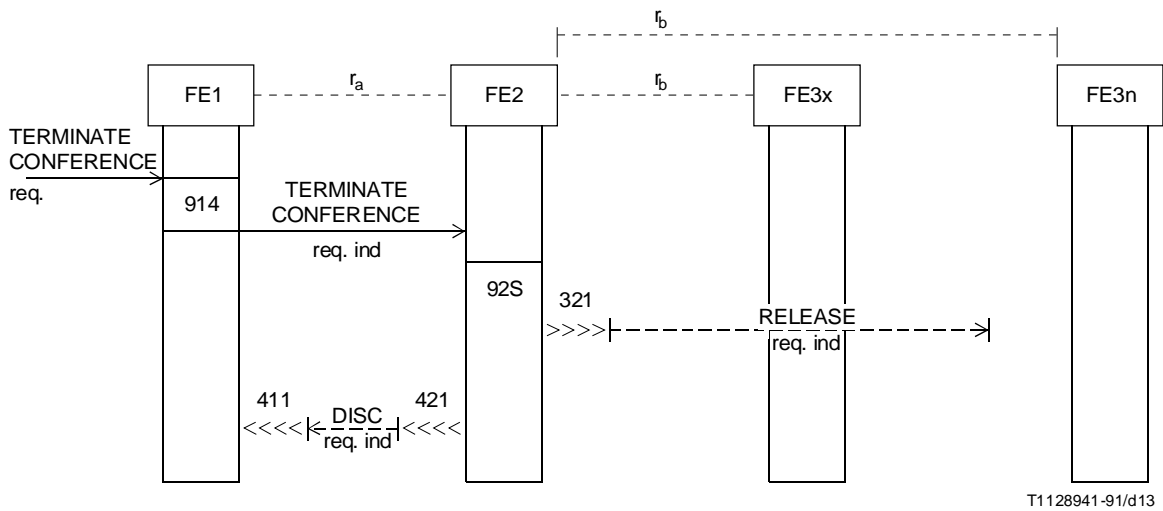

T1128941-91/d13

FIGURE 1-13/Q.84
Terminate conference

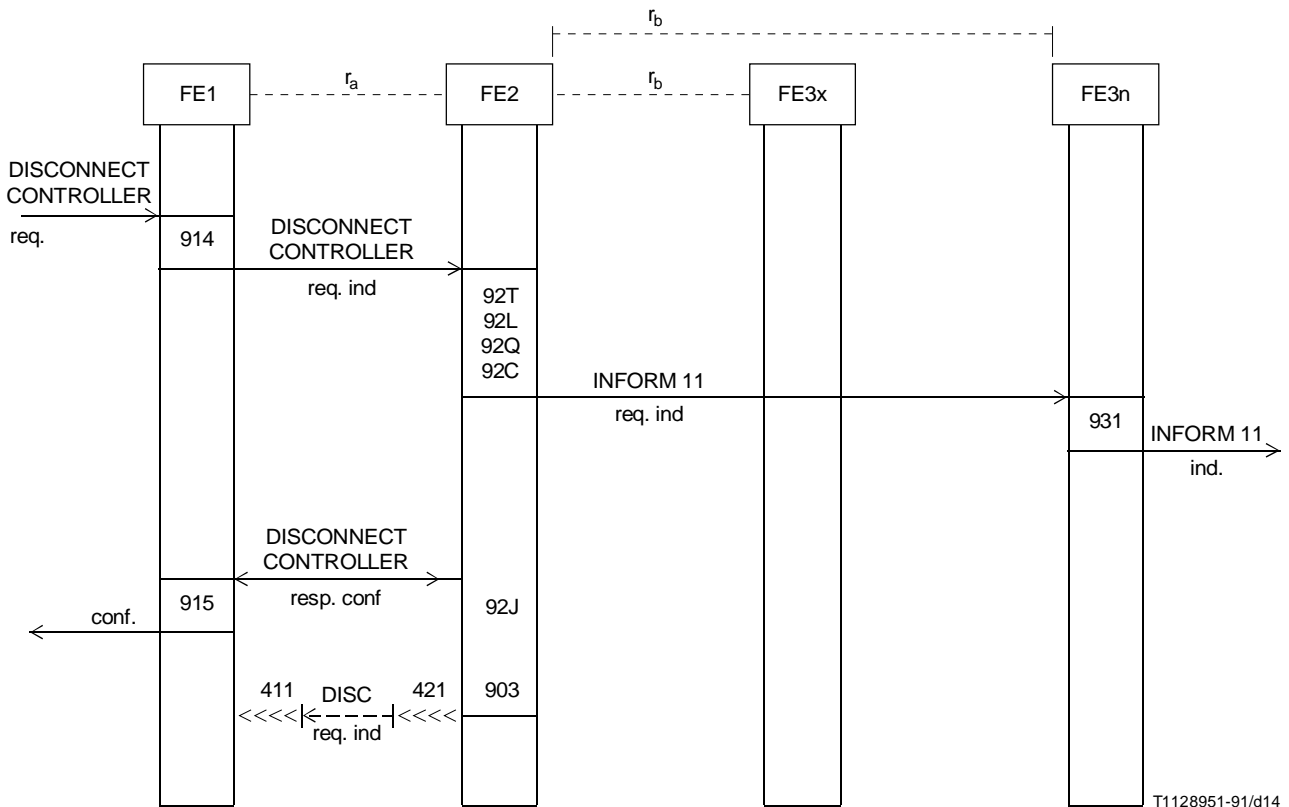

T1128951-91/d14

FIGURE 1-14/Q.84
Disconnect controller

1.7.2.1.1 Contents of SETUP

The additional contents of SETUP are shown in Table 1-1.

TABLE 1-1/Q.84

SETUP		Allowed values	req.ind	resp.conf
Conference indicator	(Note 1)		Optional	Optional
Split indicator	(Note 2)		Optional	
Conference size	(Note 3)	Integer	Optional	
Conference identity	(Note 1)	Integer		
Conference identity	(Note 2)	Integer	Optional	
Party identity	(Note 2)	Integer	Optional	
NOTES				
1 This information element is mandatory when a conference call is requested.				
2 This information element is mandatory when a two party call to a conference is requested.				
3 This information element shall only be used if a conference call is requested.				

1.7.2.2 Relationship r_a

1.7.2.2.1 Contents of CONF

The contents of CONF are shown in Table 1-2.

This confirmed information flow is used to request the Conference calling service from an existing call.

TABLE 1-2/Q.84

CONF	Allowed values	req.ind	resp.conf
Conference size	Integer	Optional	
Party identity	Integer		Mandatory

1.7.2.2.2 Contents of CONF REJECT

The contents of CONF REJECT are shown in Table 1-3.

TABLE 1-3/Q.84

CONF REJET	Allowed values	req.ind
Cause	No bridge	Mandatory

1.7.2.2.3 Contents of ADD

The contents of ADD are shown in Table 1-4.

This confirmed information flow appears from FE1 to FE2 and is used to request to add a call to the indicated conference.

TABLE 1-4/Q.84

ADD	Allowed values	req.ind	resp.conf
Conference identity	Integer	Mandatory	
Party identity	Integer		Mandatory

1.7.2.2.4 Contents of ADD REJECT

The contents of ADD REJECT are shown in Table 1-5.

TABLE 1-5/Q.84

ADD REJET	Allowed values	req.ind
Cause	No more parties allowed, invalid CId	Mandatory

1.7.2.2.5 Contents of ISOLATE

The contents of ISOLATE are shown in Table 1-6.

This confirmed information flow appears between FE1 and FE2 and is used to request the indicated conferee to be isolated from the conference.

TABLE 1-6/Q.84

ISOLATE	Allowed values	req.ind	resp.conf
Party identity	Integer	Mandatory	

1.7.2.2.6 Contents of ISOLATE REJECT

The contents of ISOLATE REJECT are shown in Table 1-7.

TABLE 1-7/Q.84

ISOLATE REJECT	Allowed values	req.ind
Cause	Invalid PId	Mandatory

1.7.2.2.7 Contents of REATTACH

The contents of REATTACH are shown in Table 1-8.

This confirmed information flow appears between FE1 and FE2 and is used to request the indicated conferee to be reattached to the conference bridge.

TABLE 1-8/Q.84

REATTACH	Allowed values	req.ind	resp.conf
Party identity	Integer	Mandatory	

1.7.2.2.8 Contents of REATTACH REJECT

The contents of REATTACH REJECT are shown in Table 1-9.

TABLE 1-9/Q.84

REATTACH REJECT	Allowed values	req.ind
Cause	Invalid PId	Mandatory

1.7.2.2.9 Contents of DROP

The contents of DROP are shown in Table 1-10.

This confirmed information flow appears between FE1 and FE2 and is used to request the call to the indicated conferee to be released.

TABLE 1-10/Q.84

DROP	Allowed values	req.ind	resp.conf
Party identity	Integer	Mandatory	

1.7.2.2.10 Contents of DROP REJECT

The contents of DROP REJECT are shown in Table 1-11.

TABLE 1-11/Q.84

DROP REJECT	Allowed values	req.ind
Cause	Invalid PId	Mandatory

1.7.2.2.11 Contents of INFORM 6

The contents of INFORM 6 are shown in Table 1-12.

The unconfirmed information flow appears between FE2 and FE1 and is used to indicate that a party has terminated his connection.

TABLE 1-12/Q.84

INFORM 6	Allowed values	req.ind
Party identity	Integer	Mandatory

1.7.2.2.12 Contents of DISCONNECT CONTROLLER

The contents of DISCONNECT CONTROLLER are shown in Table 1-13.

This confirmed information flow appears between FE1 and FE2 and is used to request the conference controller to be disconnected.

TABLE 1-13/Q.84

DISCONNECT CONTROLLER	Allowed values	req.ind	resp.conf
-----------------------	----------------	---------	-----------

1.7.2.2.13 Contents of DISCONNECT CONTROLLER REJECT

The contents of DISCONNECT CONTROLLER REJECT are shown in Table 1-14.

TABLE 1-14/Q.84

DISCONNECT CONTROLLER REJECT	Allowed values	req.ind
Cause	Floating not allowed	Mandatory

1.7.2.2.14 Contents of TERMINATE CONFERENCE

The contents of TERMINATE CONFERENCE are shown in Table 1-15.

This confirmed information flow appears between FE1 and FE2 and is used to request termination of the CONF supplementary service.

TABLE 1-15/Q.84

TERMINATE CONFERENCE	Allowed values	req.ind
----------------------	----------------	---------

1.7.2.3 Relationship r_b

There are no parameters included in INFORM 1 “ADDED TO CONFERENCE”, INFORM 2 “PRIVATE COMMUNICATION”, INFORM 3 “OTHER PARTY IN PRIVATE COMMUNICATION”, INFORM 4 “ISOLATED”, INFORM 5 “REATTACHED”, INFORM 7 “OTHER PARTY ADDED TO CONFERENCE”, INFORM 8 “OTHER PARTY ISOLATED” and INFORM 9 “OTHER PARTY REATTACHED”, INFORM 10 “OTHER PARTY DROPPED” and INFORM 11 “CONFERENCE FLOATING”.

1.8 SDL diagrams for functional entities

All SDL diagrams for functional entities are described according to Recommendation Z.100 [6].

1.8.1 SDL diagrams for FE1

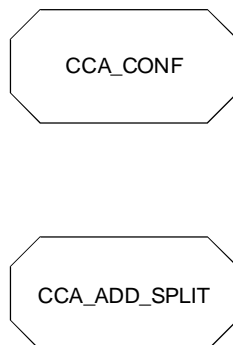

T1128960-91/d15

FIGURE 1-15/Q.84
Block diagram for FE1

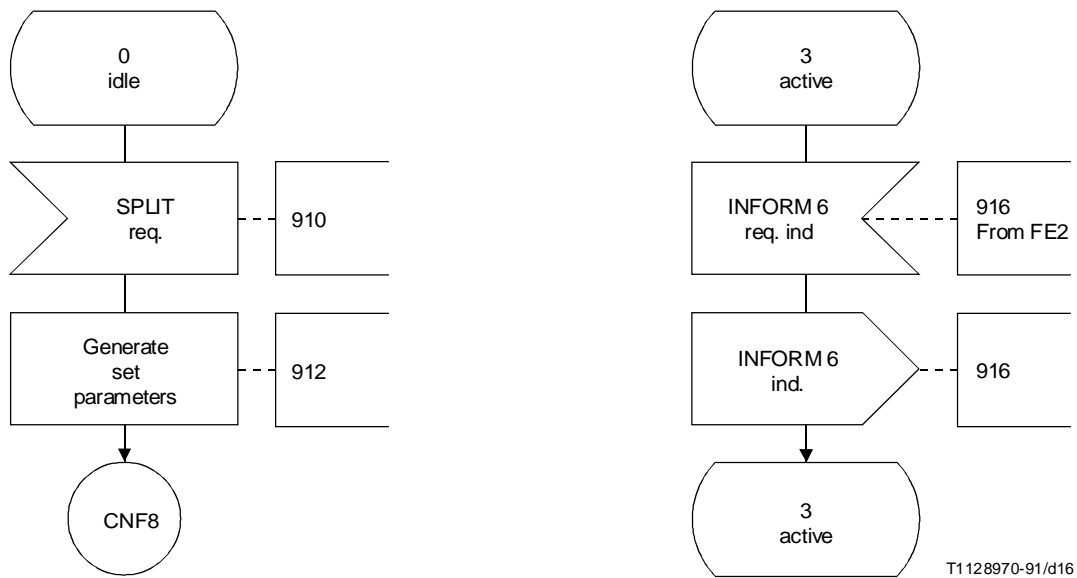

NOTES

- 1 CNF8 breaks basic call at connector S1/2, see Recommendation Q.71 [4].
- 2 Before establishing the new call the user may place another call on hold to obtain a B-channel.

FIGURE 1-16/Q.84
FE1 process CCA_ADD_SPLIT

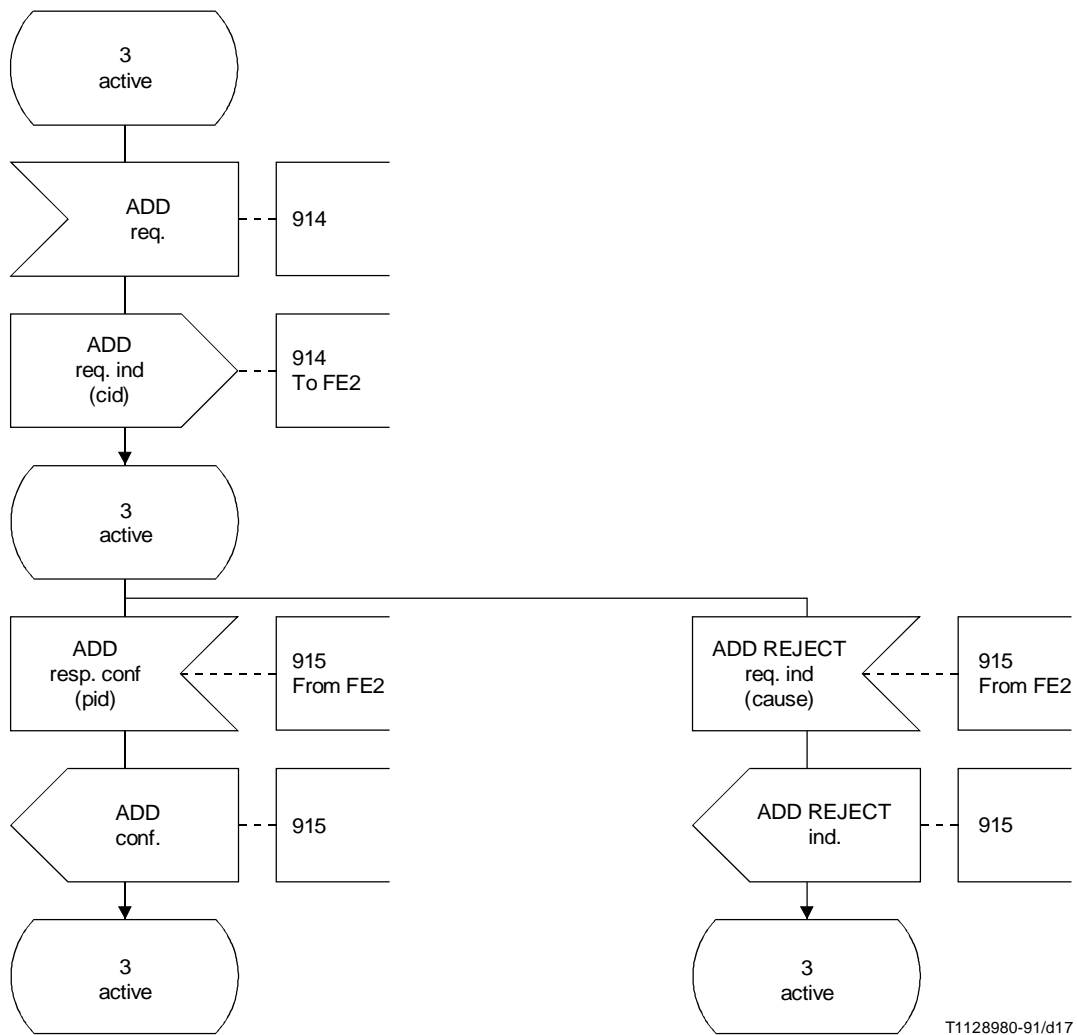

T1128980-91/d17

FIGURE 1-17/Q.84
 FE1 process CCA_ADD_SPLIT

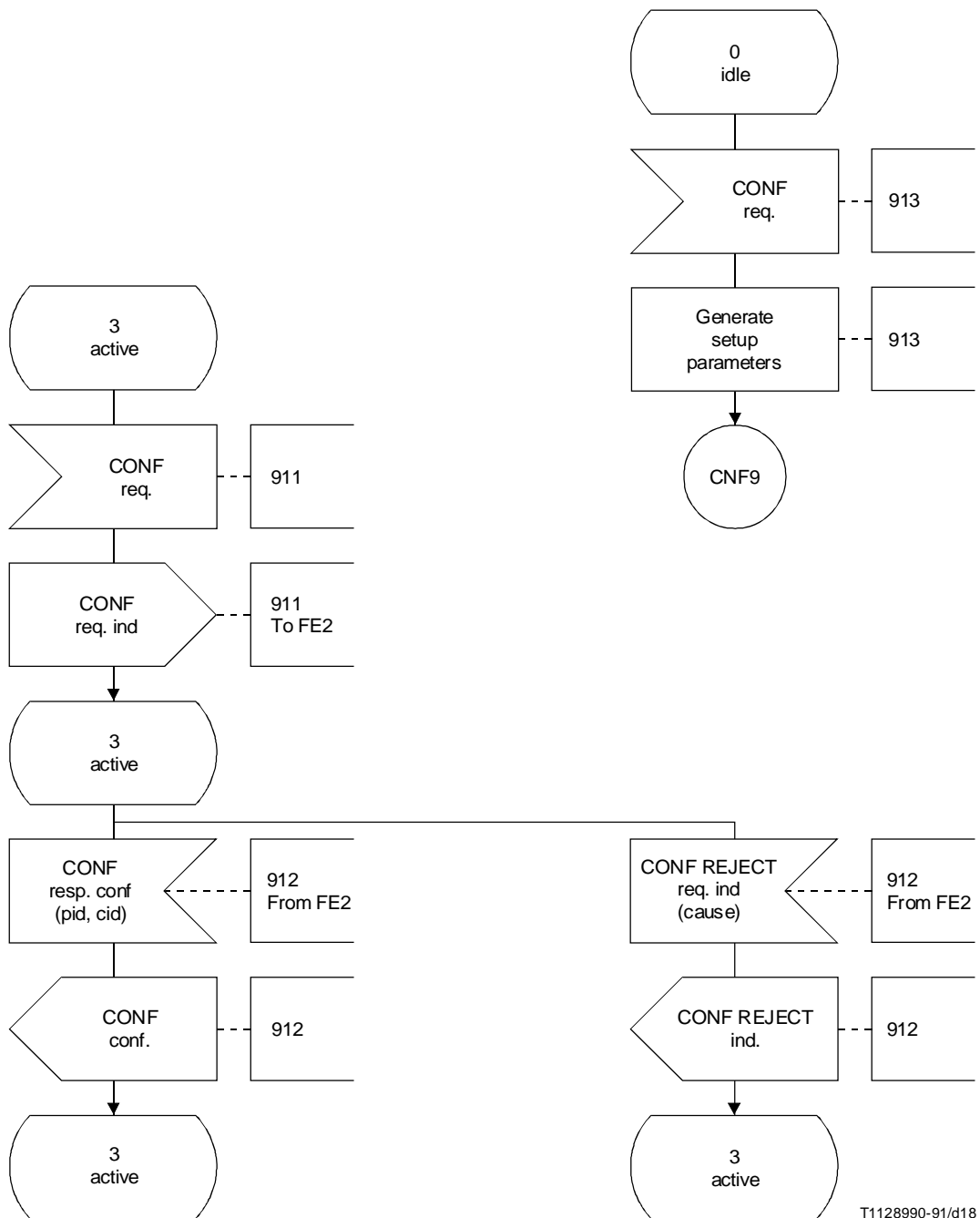

NOTE – CNF9 breaks basic call at connector S1/2, see Recommendation Q.71 [4].

FIGURE 1-18/Q.84 (sheet 1 of 6)
FE1 process CCA_CONF

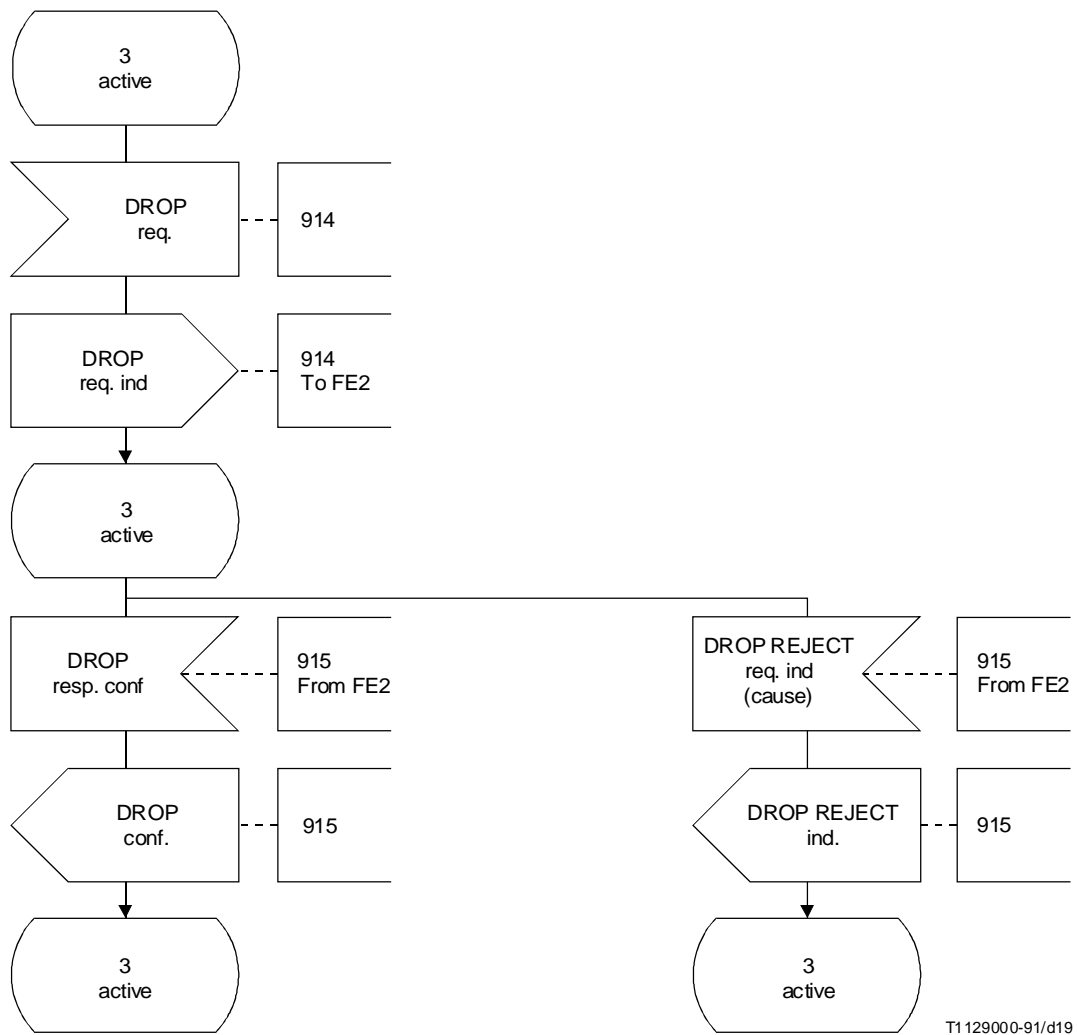
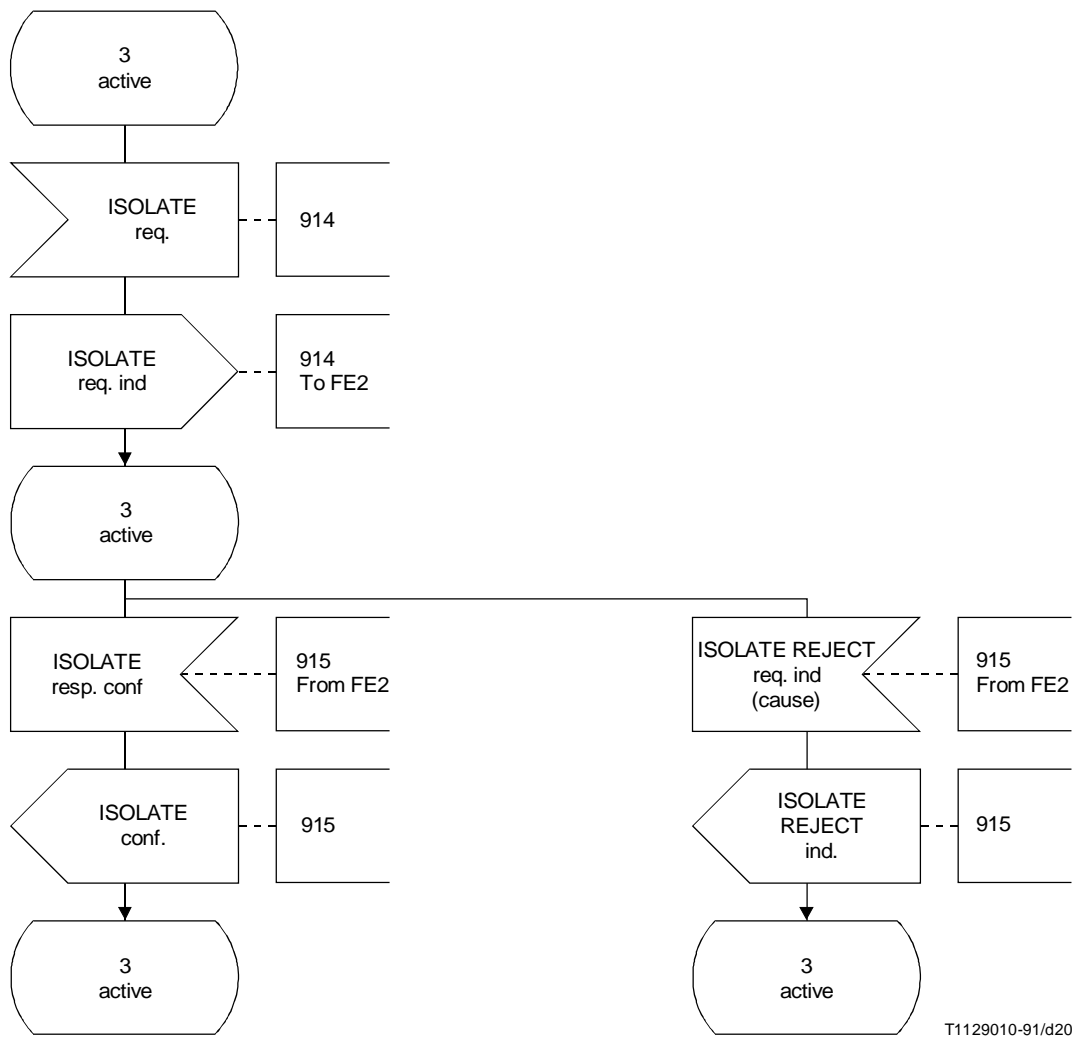
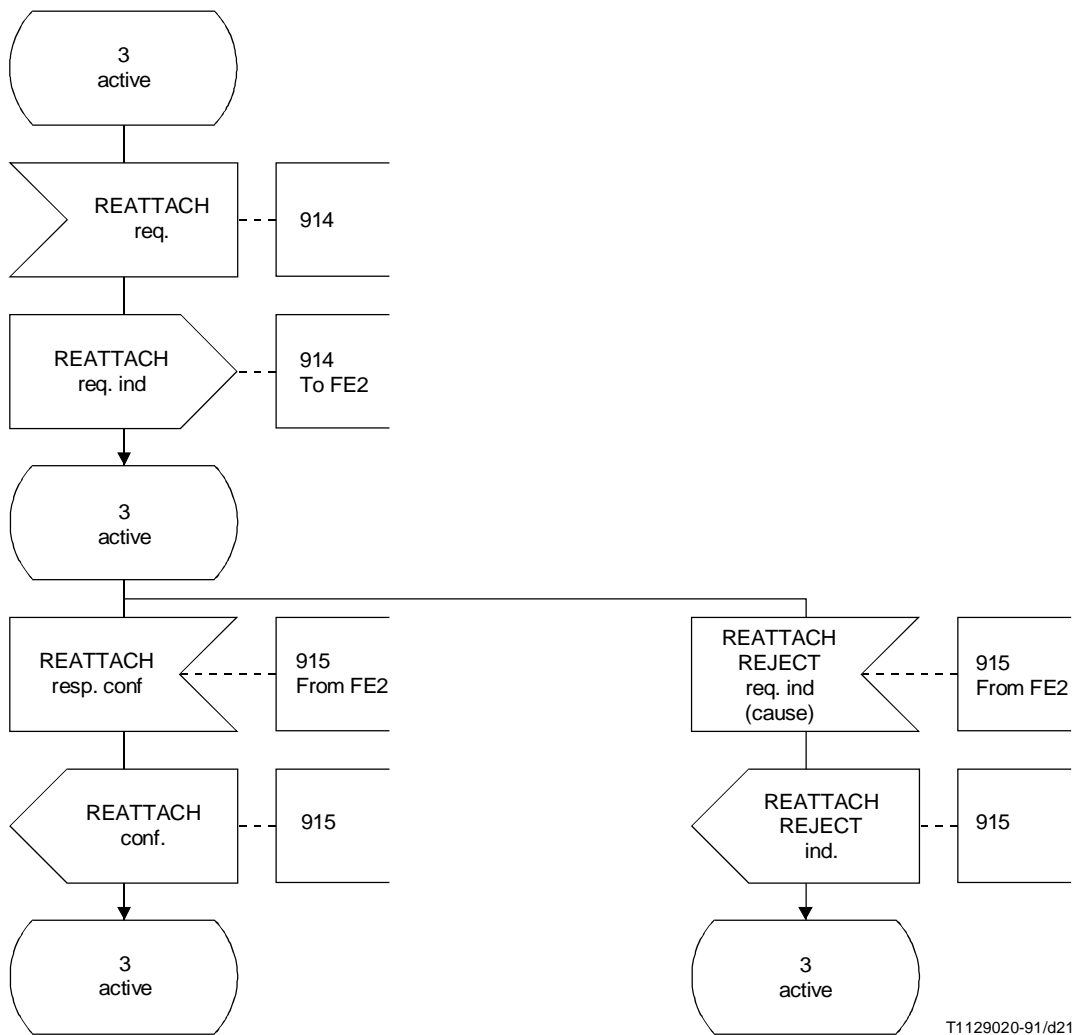

FIGURE 1-18/Q.84 (sheet 2 of 6)
FE1 process CCA_CONF



T1129010-91/d20

FIGURE 1-18/Q.84 (sheet 3 of 6)
FE1 process CCA_CONF



T1129020-91/d21

FIGURE 1-18/Q.84 (sheet 4 of 6)
FE1 process CCA_CONF

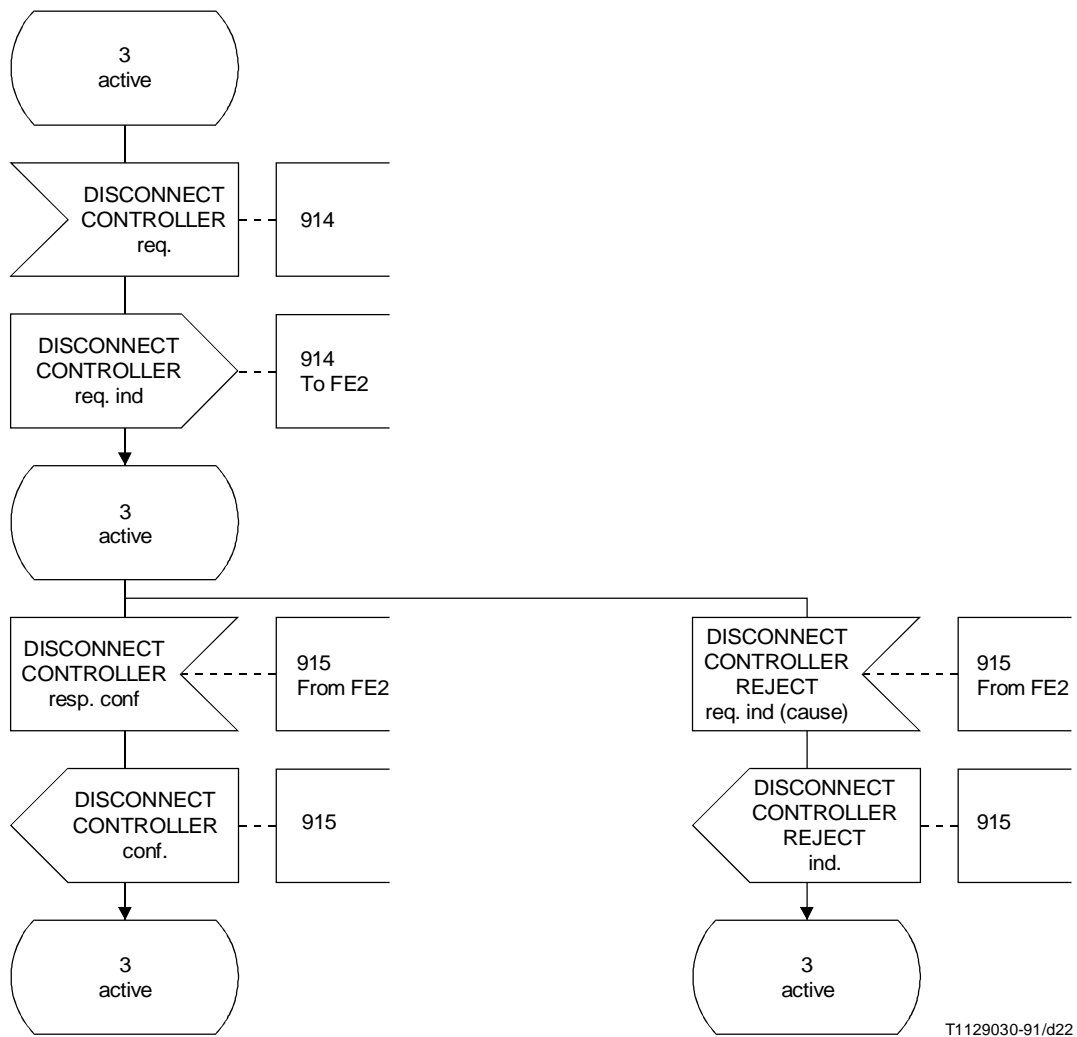

T1129030-91/d22

FIGURE 1-18/Q.84 (sheet 5 of 6)
FE1 process CCA_CONF

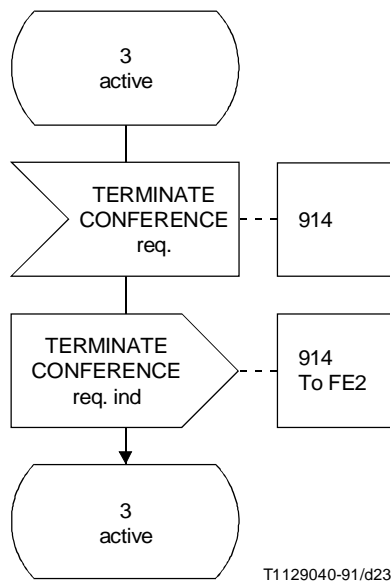

FIGURE 1-18/Q.84 (sheet 6 of 6)
FE1 process CCA_CONF

1.8.2 SDL diagrams for FE2

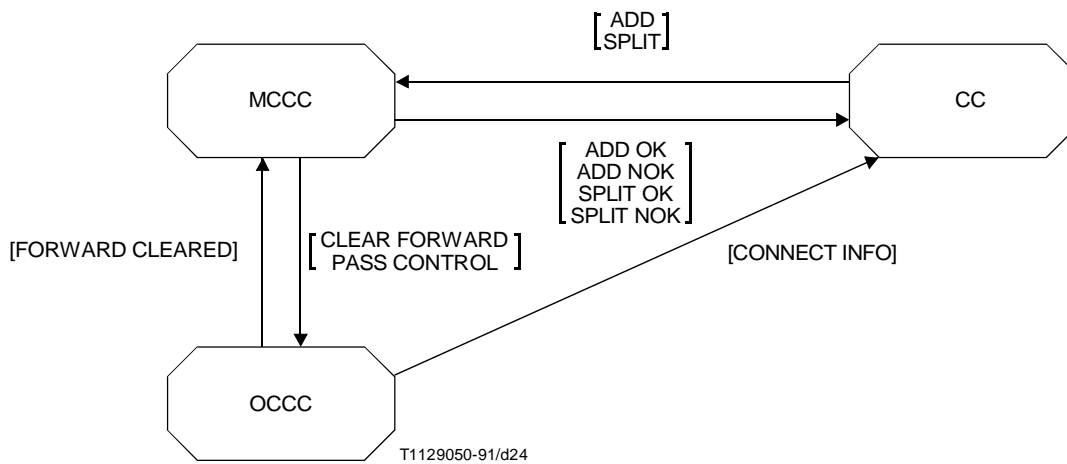
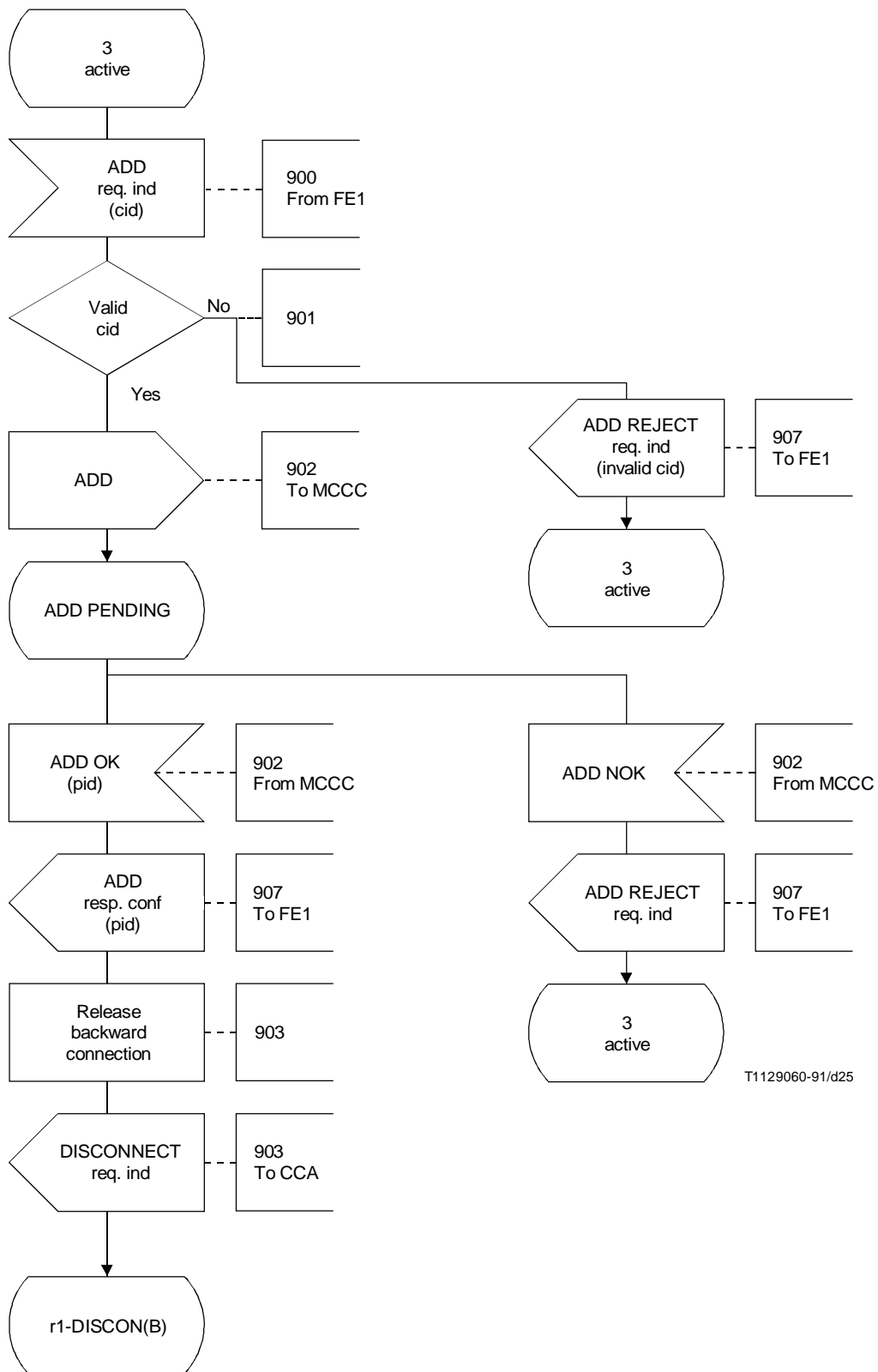

FIGURE 1-19/Q.84
Block diagram for FE2



T1129060-91/d25

FIGURE 1-20/Q.84 (sheet 1 of 2)

FE2 process CC

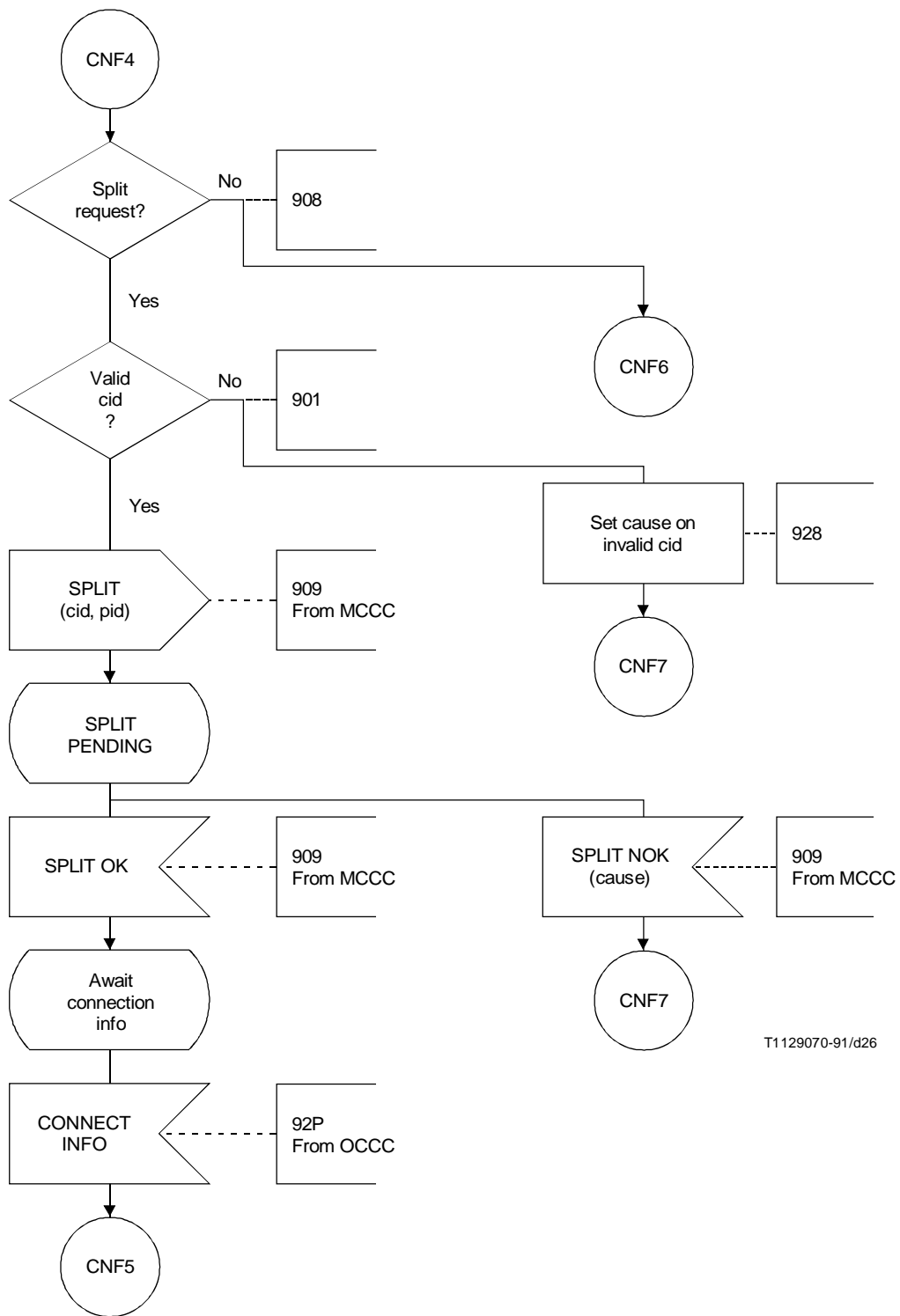

T1129070-91/d26

NOTES

- 1 CNF4 and CNF6 break basic call between connectors S2/9 and S2/10, see Recommendation Q.71 [4].
- 2 CNF7 continues basic call at connector S2/6, see Recommendation Q.71 [4].
- 3 CNF5 continues basic call at connector S2/16, see Recommendation Q.71 [4].

FIGURE 1-20/Q.84 (sheet 2 of 2)

FE2 process CC

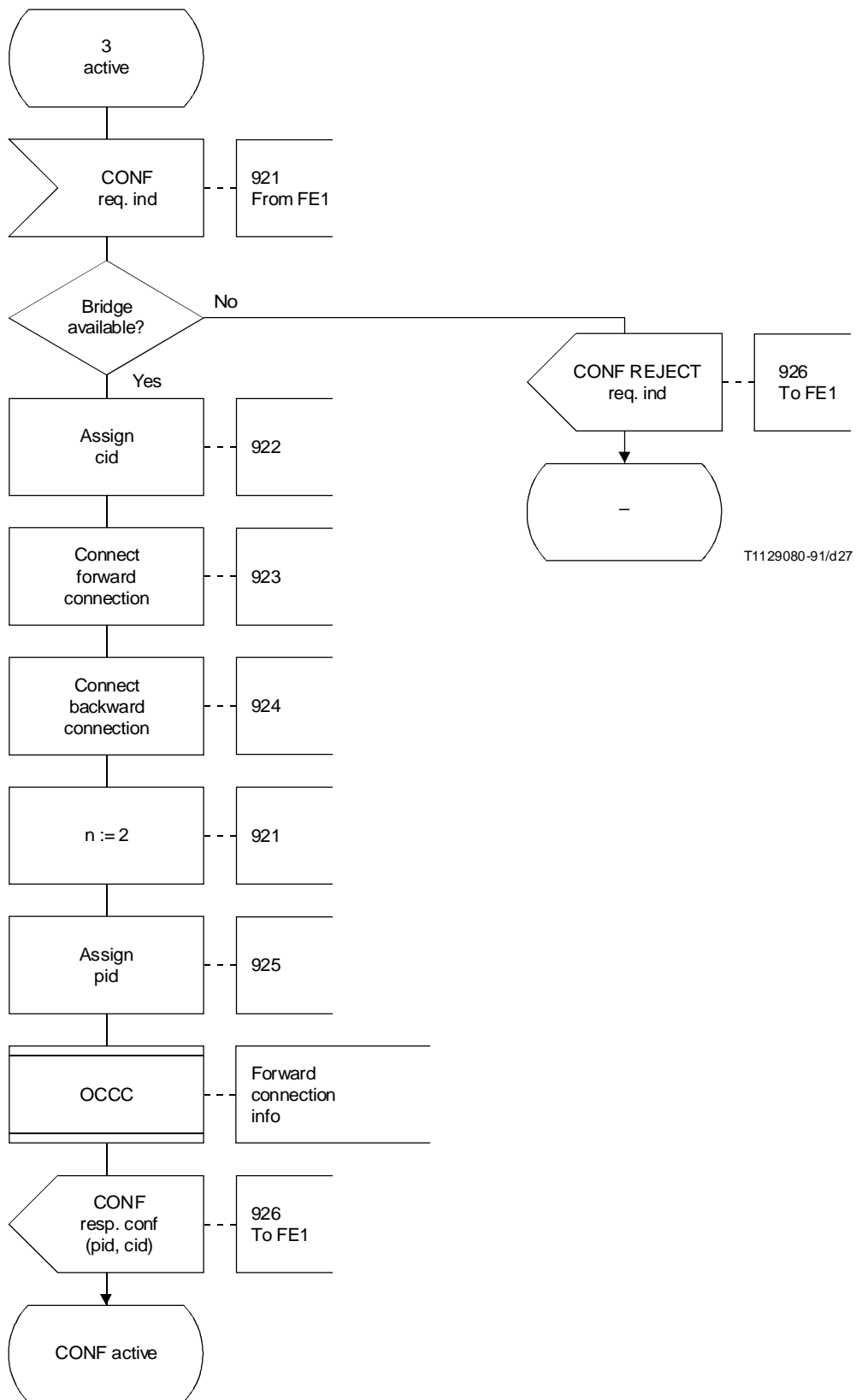
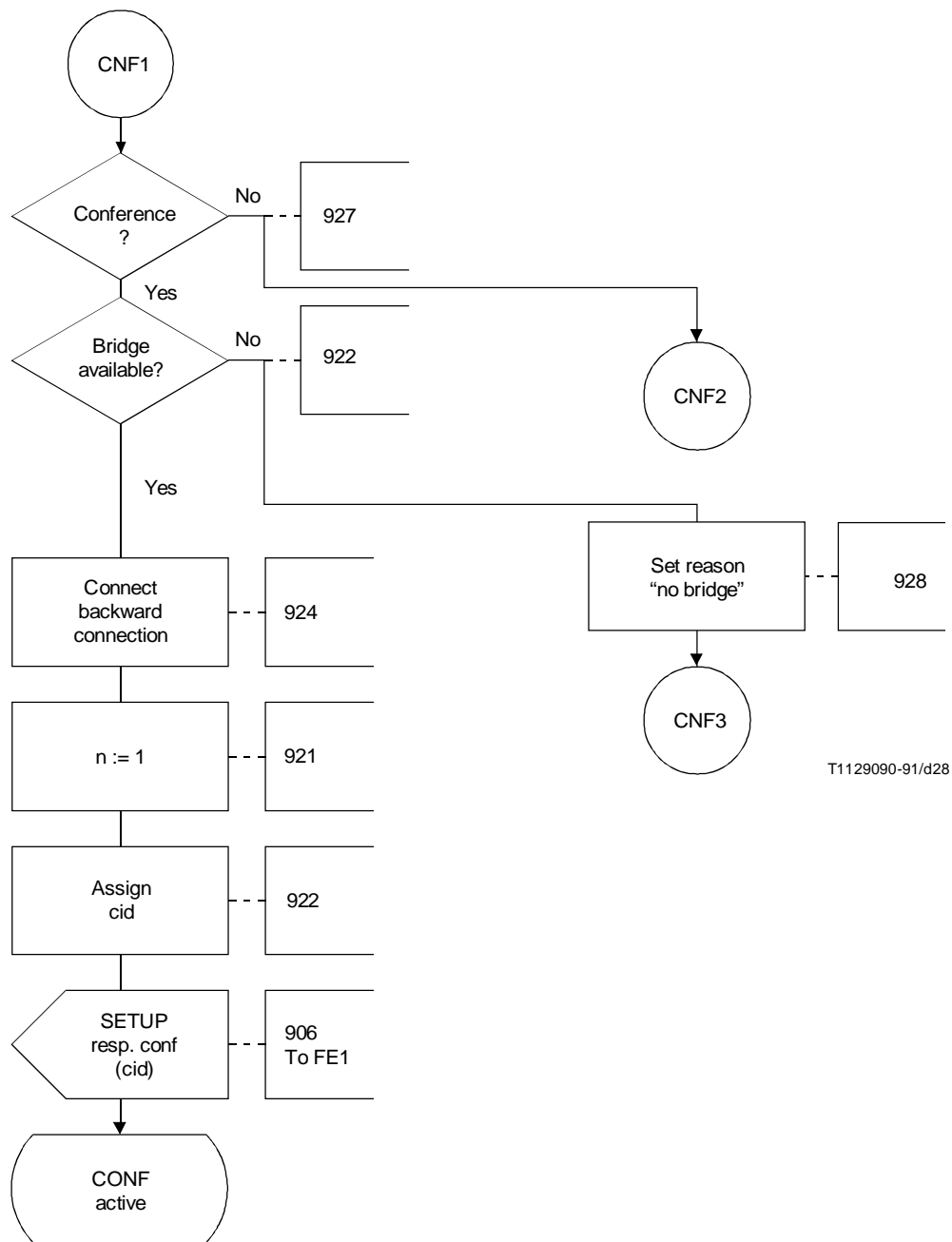

FIGURE 1-21/Q.84 (sheet 1 of 12)

FE2 process MCCC



NOTES

- 1 CNF1 and CNF2 break basic call between connectors S2/9 and S2/10, see Recommendation Q.71 [4].
- 2 CNF3 continues basic call at connector S2/6 see Recommendation Q.71 [4].

FIGURE 1-21/Q.84 (sheet 2 of 12)
FE2 process MCCC

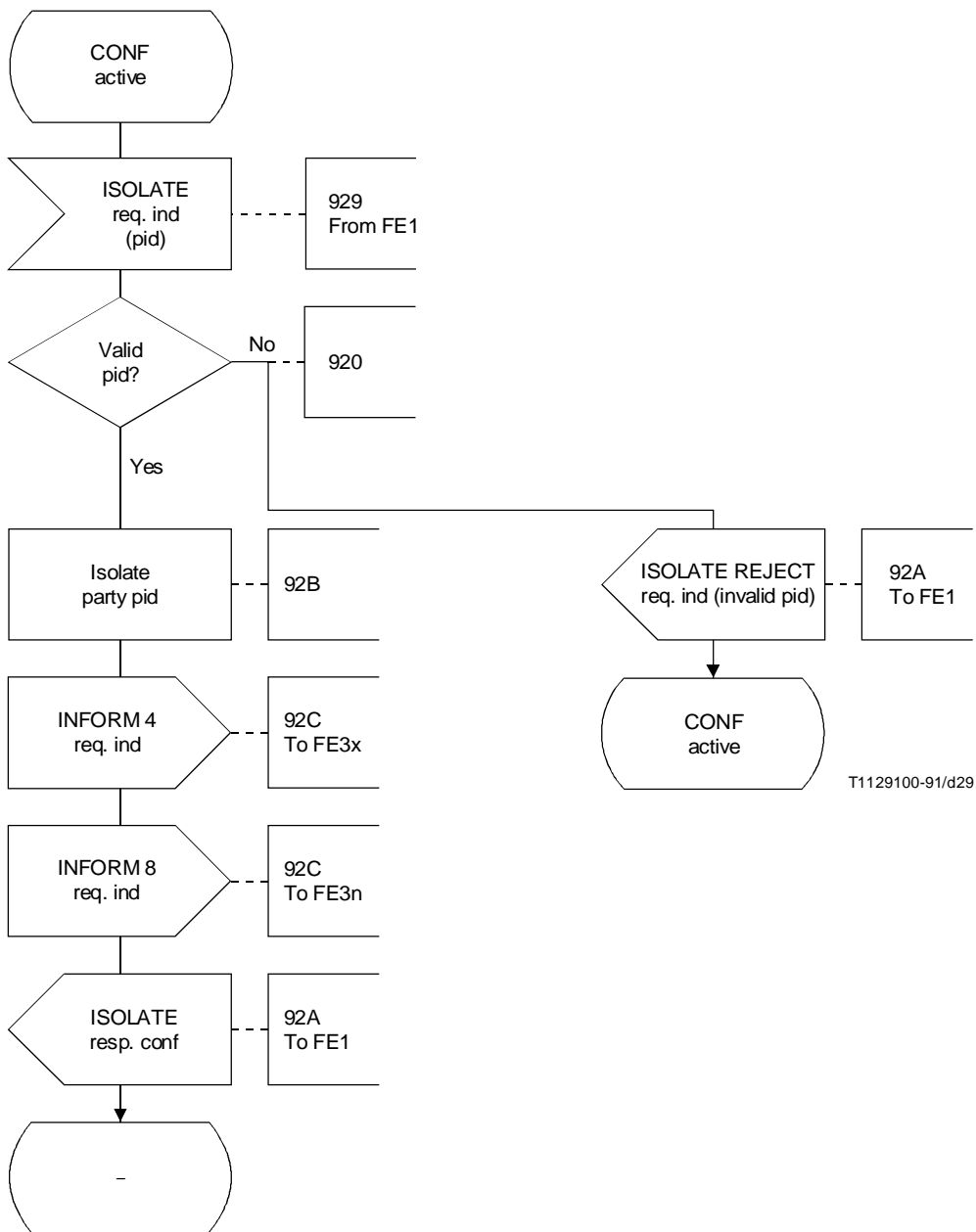

T1129100-91/d29

FIGURE 1-21/Q.84 (sheet 3 of 12)

FE2 process MCCC

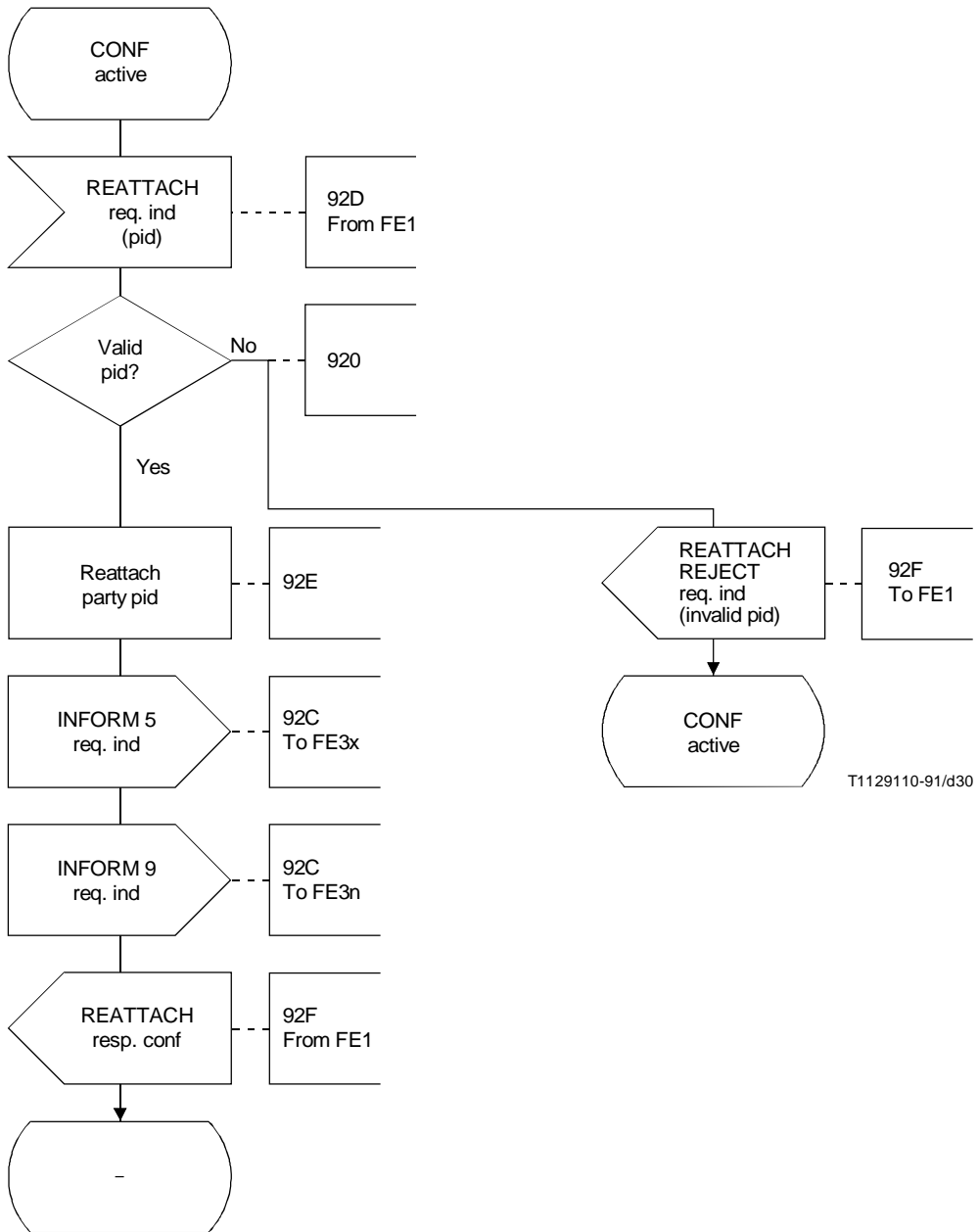
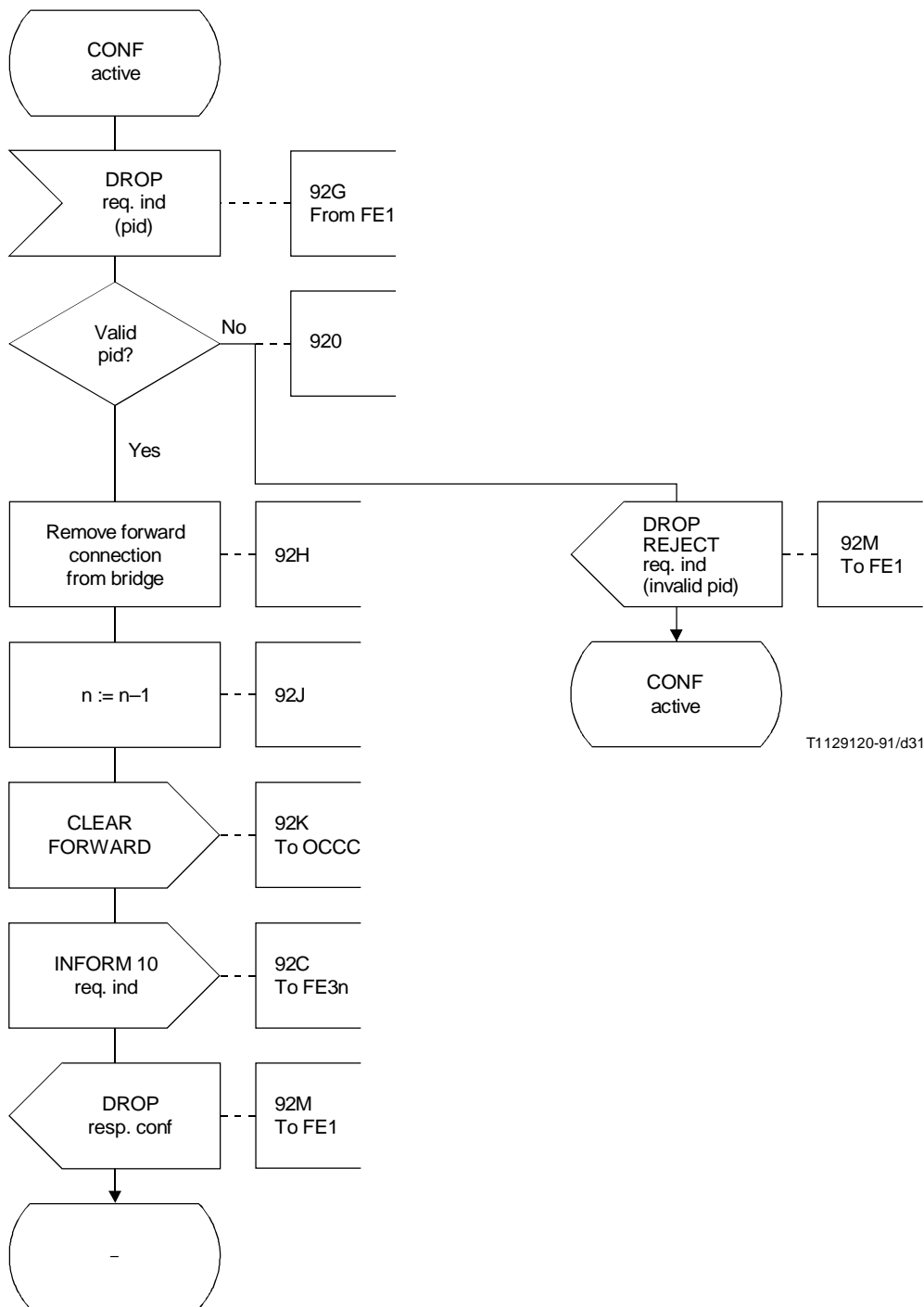

FIGURE 1-21/Q.84 (sheet 4 of 12)

FE2 process MCCC



T1129120-91/d31

FIGURE 1-21/Q.84 (sheet 5 of 12)
FE2 process MCCC

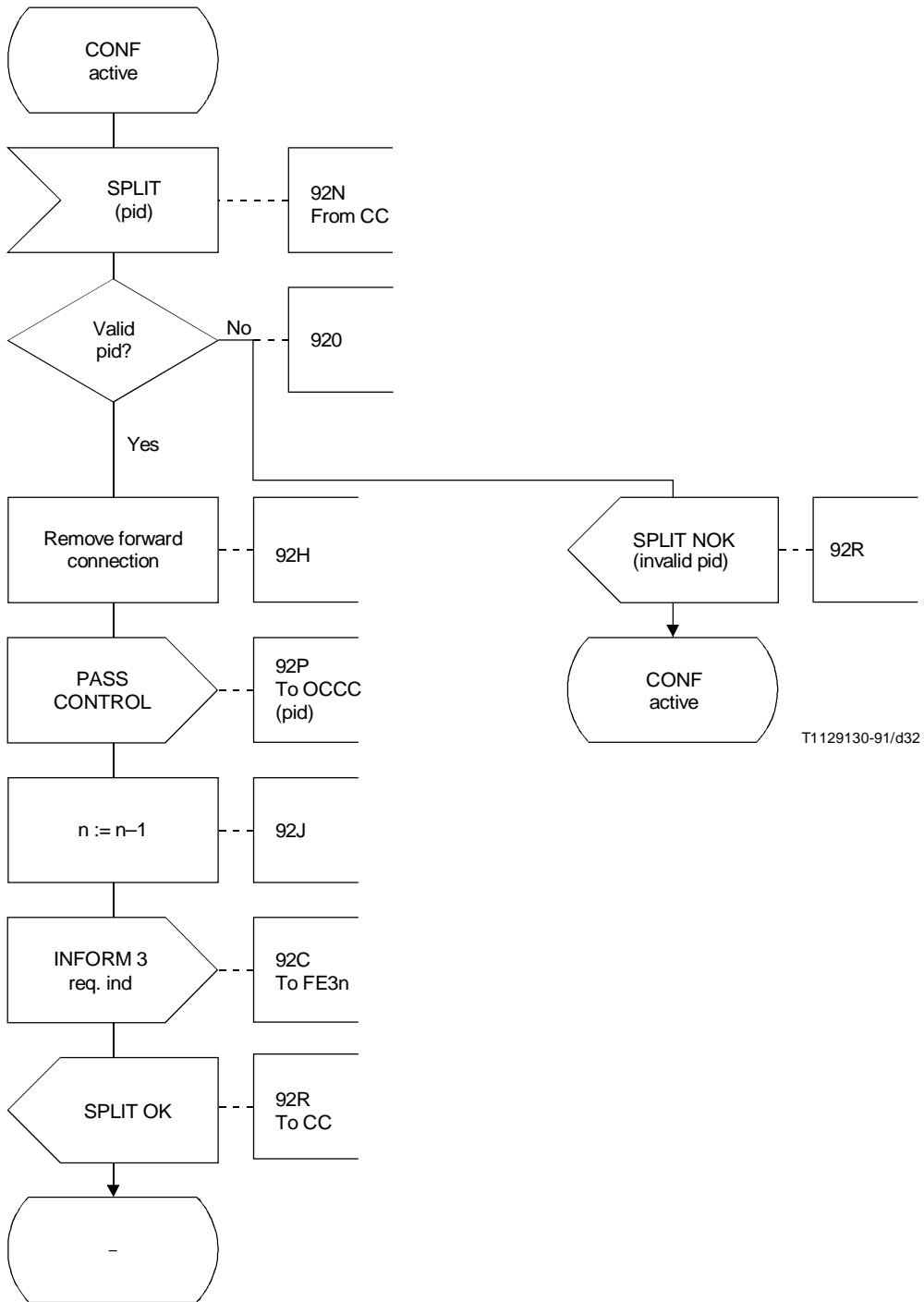

T1 129130-91/d32

FIGURE 1-21/Q.84 (sheet 6 of 12)
FE2 process MCCC

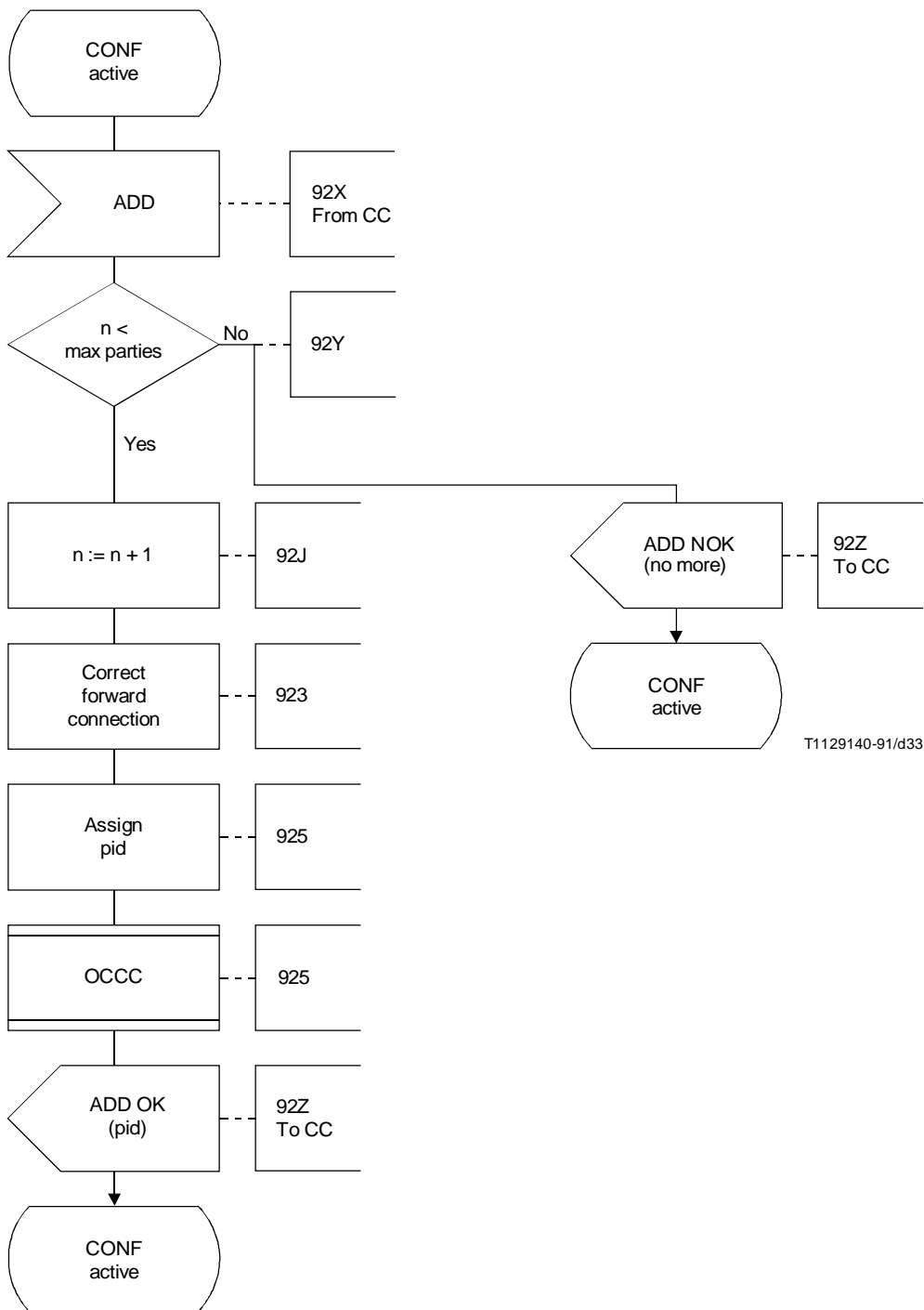

FIGURE 1-21/Q.84 (sheet 7 of 12)
FE2 process MCCC

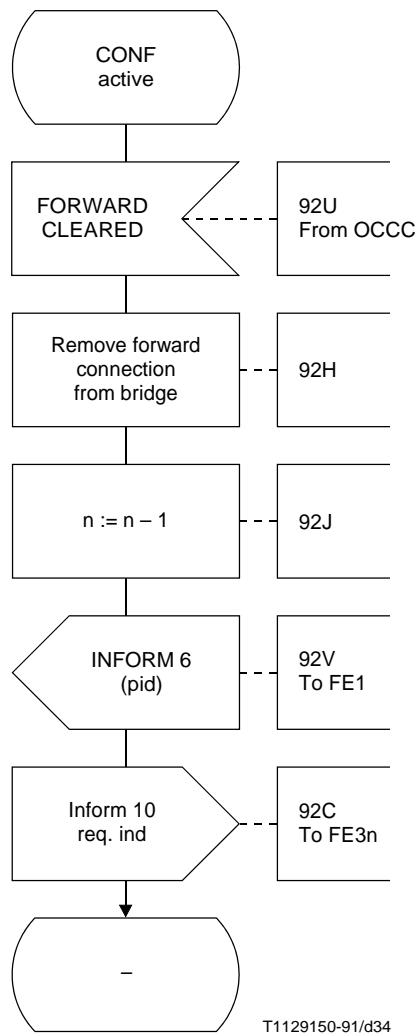

FIGURE 1-21/Q.84 (sheet 8 of 12)
FE2 process MCCC

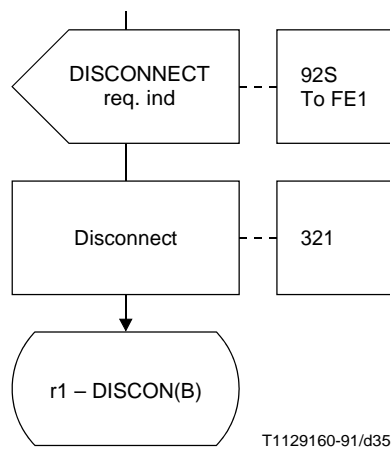
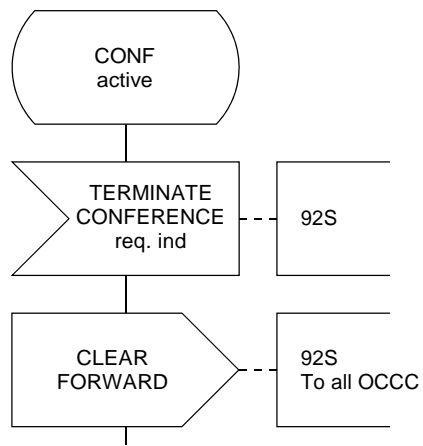
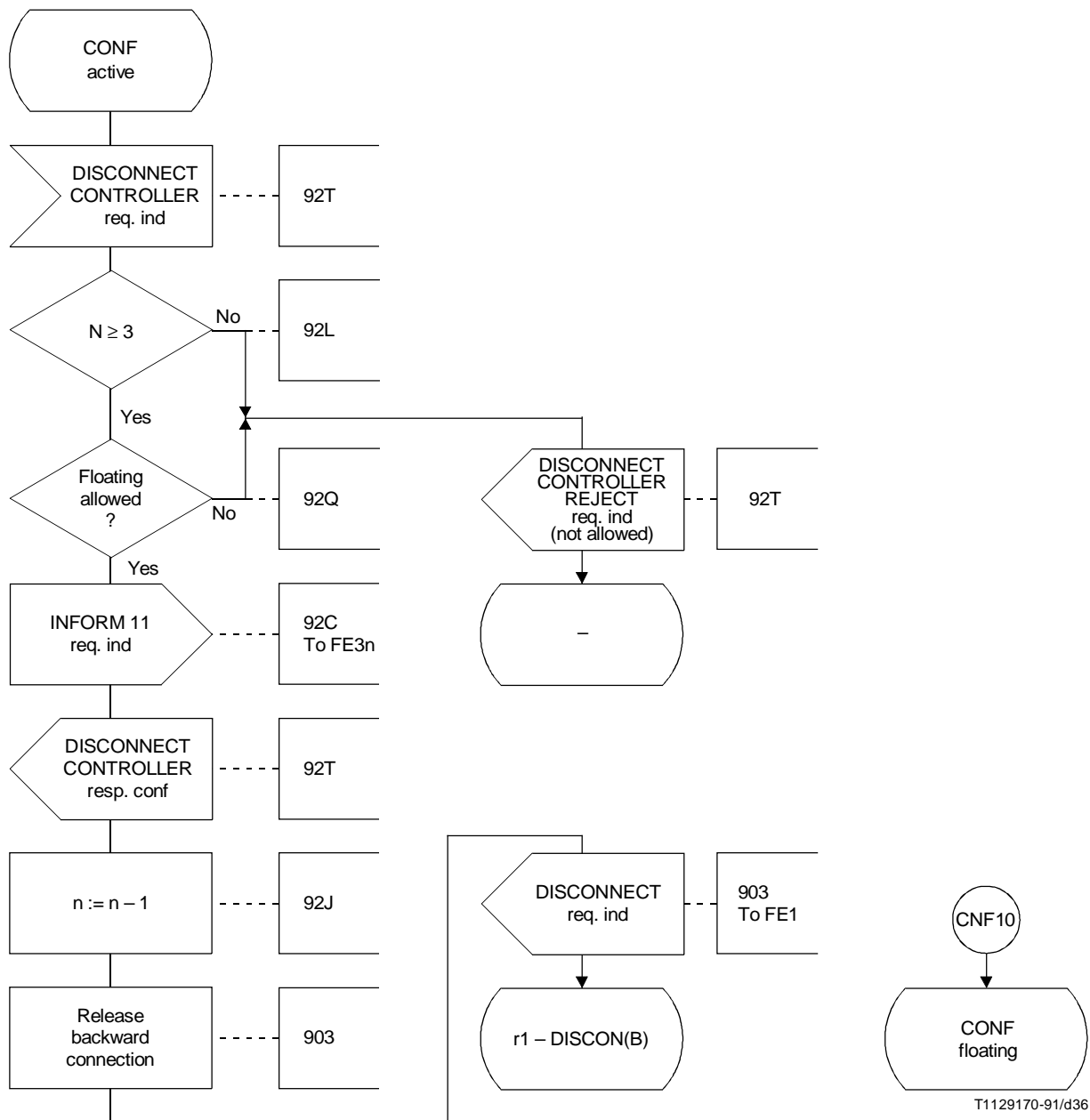
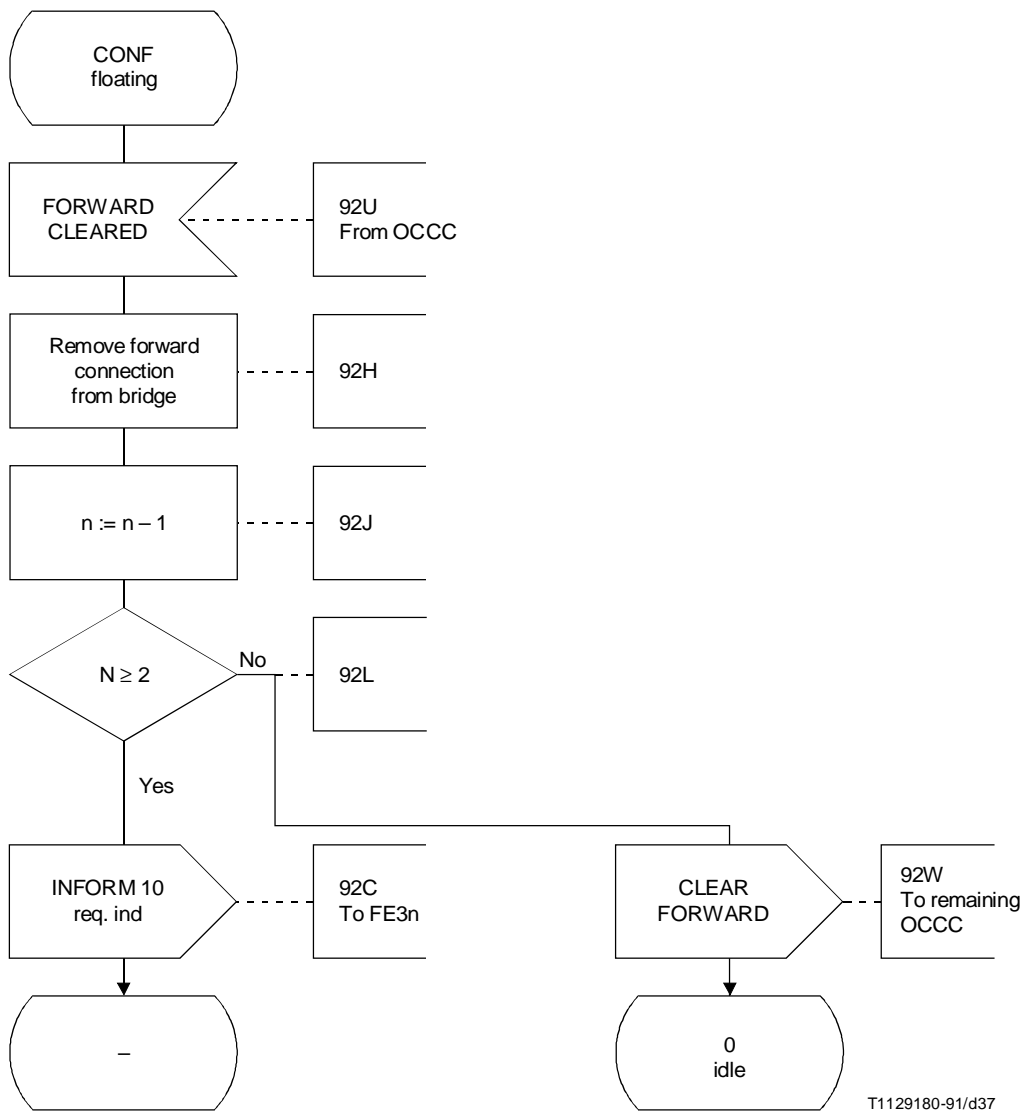

FIGURE 1-21/Q.84 (sheet 9 of 12)
FE2 process MCCC



NOTE – CNF10 breaks basic call at connector S2/11, see Recommendation Q.71 [4].

FIGURE 1-21/Q.84 (sheet 10 of 12)
FE2 process MCCC



T1129180-91/d37

FIGURE 1-21/Q.84 (sheet 11 of 12)
FE2 process MCCC

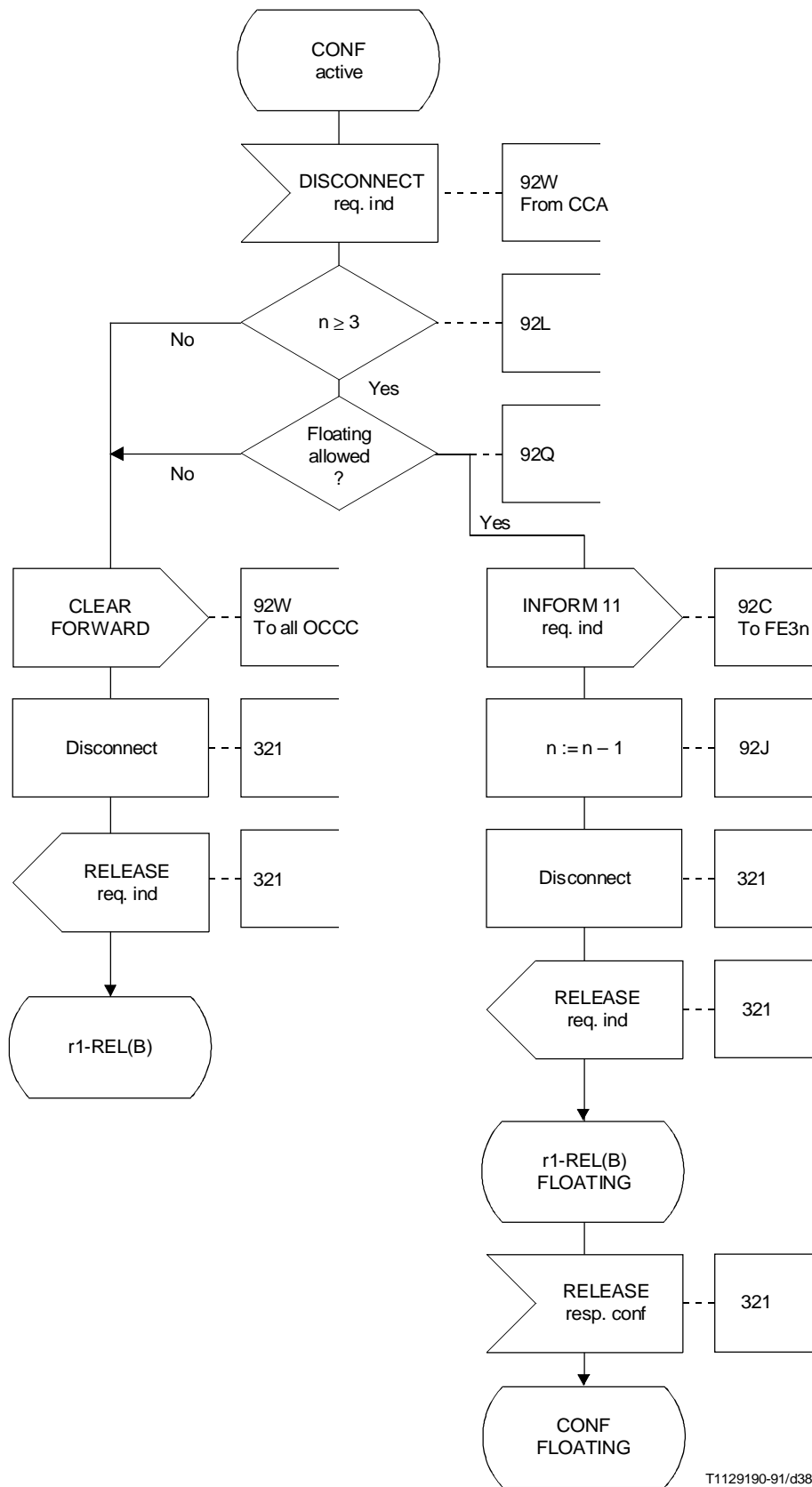

T1129190-91/d38

FIGURE 1-21/Q.84 (sheet 12 of 12)

FE2 process MCCC

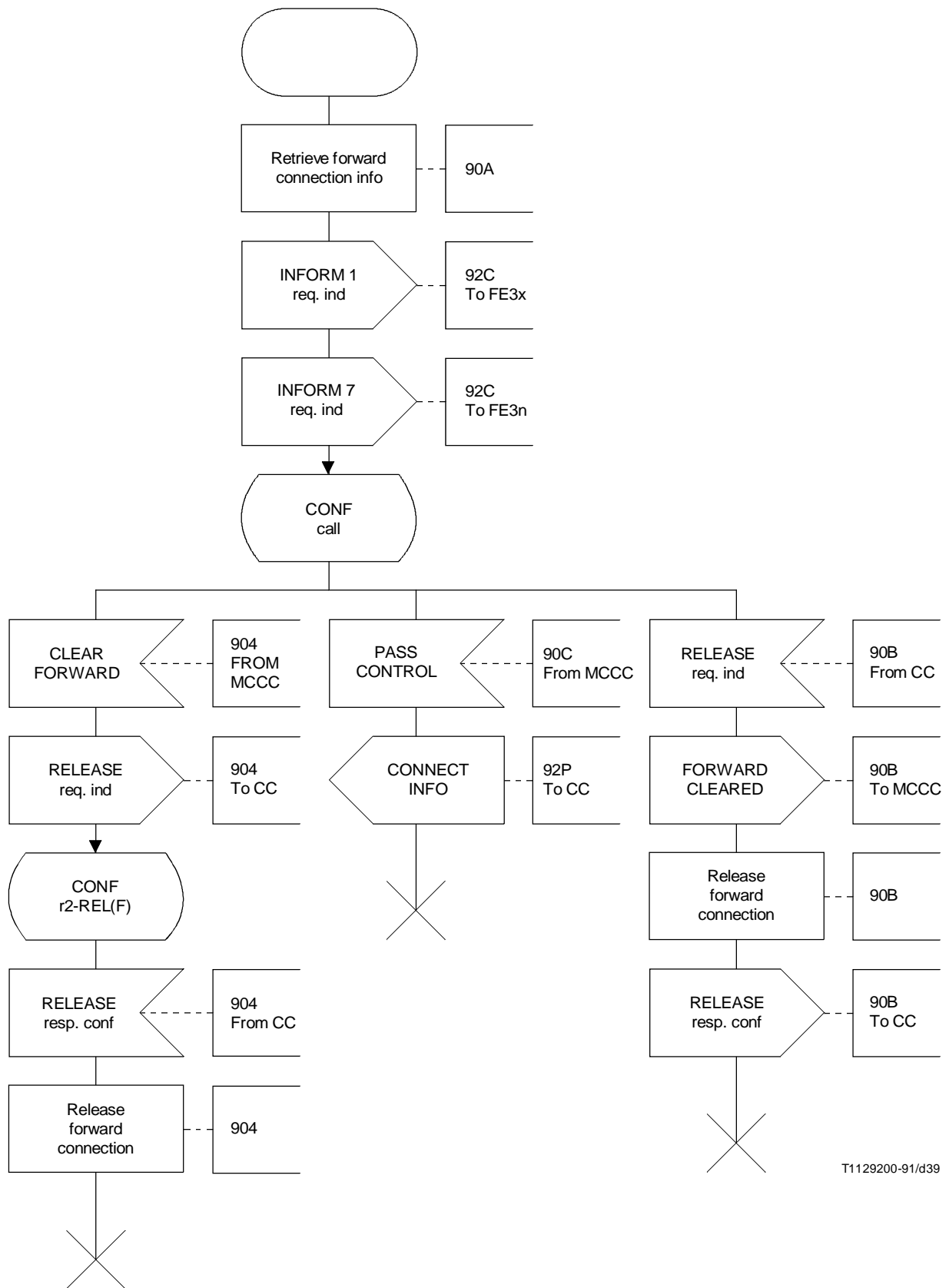

T1129200-91/d39

FIGURE 1-22/Q.84
Process OCCC

1.8.3 SDL diagrams for FE3

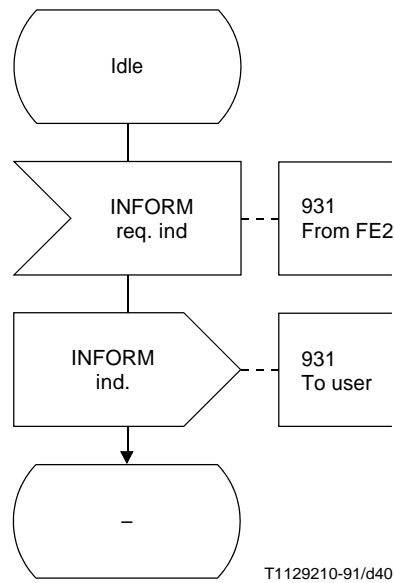

FIGURE 1-23/Q.84
Process FE3

1.9 Functional Entity Actions (FEAs)

1.9.1 FEAs of FE1

FE1 provides functional extension to the related CCA.

- 910: FE1 shall receive SPLIT req. from the user, include an indication that a conferee is to be split in the SETUP req.ind to FE2.
- 911: FE1 shall receive CONF req. from the user in an active call and forward this to FE2.
- 912: FE1 shall receive a response to CONF req.ind from FE2 and forward this to the user.
- 913: FE1 shall receive CONF req. from the user in an idle call, include information that a conference call is being requested in the SETUP req.ind to FE2.
- 914: FE1 shall receive user requests DROP req., ISOLATE req., ADD req., TERMINATE CONFERENCE req., DISCONNECT CONTROLLER req. and REATTACH req. and forward these to FE2.
- 915: FE1 shall receive responses to DROP req.ind, ISOLATE req.ind, ADD req.ind, DISCONNECT CONTROLLER req.ind and REATTACH req.ind and forward these to the user.
- 916: FE1 shall receive INFORM 6 req.ind and present an appropriate indication to the user.

1.9.2 FEAs of FE2

- 920: FE2 shall check for a valid party identity.
- 921: FE2 shall receive CONF req.ind.
- 922: FE2 shall test for the availability of a conference bridge and assign a conference identity (cid) if available.

- 923: FE2 shall connect a forward connection to the conference bridge.
- 924: FE2 shall connect a backward connection to the conference bridge.
- 925: FE2 shall create an OCCC process and assign a party identity (pid).
- 926: FE2 shall respond to CONF req.ind as appropriate.
- 927: FE2 shall detect a conference call request in SETUP req.ind.
- 928: FE2 shall determine the reason for failure.
- 929: FE2 shall receive ISOLATE req.ind.
- 92A: FE2 shall respond to ISOLATE req.ind as appropriate.
- 92B: FE2 shall isolate a party.
- 92C: FE2 shall send INFORM 1, INFORM 2, INFORM 3, INFORM 4, INFORM 5, INFORM 7, INFORM 8, INFORM 9, INFORM 10 or INFORM 11 to FE3 as appropriate.
- 92D: FE2 shall receive REATTACH req.ind.
- 92E: FE2 shall reattach a party.
- 92F: FE2 shall respond to REATTACH req.ind as appropriate.
- 92G: FE2 shall receive DROP req.ind.
- 92H: FE2 shall remove the forward connection from the conference bridge.
- 92J: FE2 shall set, increment or decrement the conferee counter as appropriate, stop the charging timing function (if running), determine and register cumulated charges and start the charging timing function for the new number of conferees.

NOTES

1 Cumulative charges are determined by adding to the previously determined cumulative charges, the charges over the last charging period for the total of conferees and controller.

2 This FEA describes actions which might be adopted by Administrations to implement the charging principles of the D-Series Recommendations.

- 92K: FE2 shall stimulate clearing in the required OCCC process.
- 92L: FE2 shall check whether sufficient conferees exist to allow continuation of the conference during floating.
- 92M: FE2 shall respond to DROP req.ind as appropriate.
- 92N: The MCCC process shall receive a SPLIT signal from a local CC process.
- 92P: FE2 shall transfer forward connection control from an OCCC process to a CC process.
- 92Q: FE2 shall check whether floating is allowed.
- 92R: FE2 shall respond to a SPLIT signal as appropriate.
- 92S: FE2 shall receive TERMINATE CONFERENCE req.ind send a CLEAR FORWARD signal to all OCCC processes, send DISCONNECT req.ind proceed FEA 321, stop the charging timing function, determine and register cumulated charges.

NOTE – This FEA describes actions which might be adopted by Administrations to implement the charging principles of the D-Series Recommendations.

- 92T: FE2 shall receive DISCONNECT CONTROLLER req.ind and respond depending on FEA 92L and FEA 92Q.
- 92U: The MCCC process shall receive a FORWARD CLEARED signal from an OCCC process.
- 92V: FE2 shall formulate INFORM 6 req.ind and send to FE1.
- 92W: FE2 shall receive DISCONNECT req.ind and if floating is not allowed send a CLEAR FORWARD signal to all OCCC processes, release the conference bridge, respond with RELEASE req.ind, enter the r1-REL (B) state, stop the charging timing function, determine and register cumulated charges.

NOTE – This FEA describes actions which might be adopted by Administrations to implement the charging principles of the D-Series Recommendations.

- 92X: The MCCC process shall receive an ADD signal from a CC process.
- 92Y: FE2 shall check whether the maximum number of conferees has been reached.
- 92Z: The MCCC process shall respond to an ADD signal dependent on FEA 92Y to the appropriate CC process.
- 900: FE2 shall receive ADD req.ind from FE1.
- 901: FE2 shall check for a valid conference identity.
- 902: The CC process shall send an ADD signal to the appropriate MCCC process and receive a response.
- 903: FE2 shall release the backward connection, send DISCONNECT req.ind to the CCA and enter the basic call r1-DISC (B) state.
- 904: The OCCC process shall receive a CLEAR FORWARD signal from the MCCC process, send RELEASE req.ind, await RELEASE resp.conf and release the forward connection.
- 905: FE2 shall release the conference identity (cid) in SETUP resp.conf.
- 907: FE2 shall send an appropriate response to ADD req.ind to FE1.
- 908: The CC process shall detect a split request in SETUP req.ind.
- 909: The CC process shall send a SPLIT signal to a MCCC process and await and receive a response.
- 90A: FE2 shall retrieve the information of a forward connection.
- 90B: The OCCC process shall receive RELEASE req.ind from a conferee, send a FORWARD CLEARED signal to the MCCC process, release the forward connection and respond with RELEASE resp.conf.
- 90C: The OCCC process shall receive a PASS CONTROL signal from a MCCC process.

1.9.3 FEAs of FE3

- 931: FE3 shall receive INFORM 1, INFORM 2, INFORM 3, INFORM 4, INFORM 5, INFORM 7, INFORM 8, INFORM 9, INFORM 10 or INFORM 11 and present an appropriate indication to the user.

1.10 Allocation of functions to physical entities

The possible physical locations of functional entities are shown in Table 1-16.

NOTE – All basic calls to be included in the conference shall have a CC at the same location as FE2. The procedures to control this routing requirement are outside the scope of this Recommendation.

TABLE 1-16/Q.84

Scenario	FE1	FE2	FE3
I	TE	LE	TE
II	TE	PNX	TE