



INTERNATIONAL TELECOMMUNICATION UNION

CCITT

THE INTERNATIONAL
TELEGRAPH AND TELEPHONE
CONSULTATIVE COMMITTEE

Q.932

(11/1988)

SERIES Q: SWITCHING AND SIGNALLING

DIGITAL SUBSCRIBER SIGNALLING SYSTEM No. 1
(DSS 1), NETWORK LAYER, USER-NETWORK
MANAGEMENT

Network layer

**GENERIC PROCEDURES FOR THE CONTROL
OF ISDN SUPPLEMENTARY SERVICES**

Reedition of CCITT Recommendation Q.932 published in
the Blue Book, Fascicle VI.11 (1988)

NOTES

1 CCITT Recommendation Q.932 was published in Fascicle VI.11 of the *Blue Book*. This file is an extract from the *Blue Book*. While the presentation and layout of the text might be slightly different from the *Blue Book* version, the contents of the file are identical to the *Blue Book* version and copyright conditions remain unchanged (see below).

2 In this Recommendation, the expression “Administration” is used for conciseness to indicate both a telecommunication administration and a recognized operating agency.

Recommendation Q.932

GENERIC PROCEDURES FOR THE CONTROL OF ISDN SUPPLEMENTARY SERVICES

1 General

This Recommendation defines the generic procedures applicable for the control of supplementary services at the user-network interface. These procedures may be used for the invocation and operation of supplementary services in association with existing calls or outside any existing calls.

The detailed procedures applicable to individual supplementary services are outside the scope of this Recommendation. However, typical examples of the application of these generic procedures to some supplementary services are provided in Appendix I to this Recommendation for explanatory and illustrative purposes only. The application of the Functional protocol defined in § 6, to the operation of individual supplementary services will be the subject of future Recommendations in this series.

2 Overview of the generic protocols and of their scope

Three generic protocols are defined for the control of supplementary services at ISDN user-network interfaces. These protocols operate at layer 3 of the control plane at the S/T reference points, and assume that the use of layers 1 and 2 conforms to Recommendations I.430 [1], I.431 [2] and Q.921 [3]. In addition, the three generic protocols assume the existence of an established data link and use the acknowledged information transfer service available at the layer 2 to layer 3 interface.

2.1 *Three generic protocols*

Three generic protocols are defined for the control of supplementary services, two of which are stimulus, the third being functional; these protocols are:

- the Keypad protocol;
- the Feature key management protocol;
- the Functional protocol.

2.1.1 *Keypad protocol*

The Keypad protocol is based on the use of the Keypad facility and Display information elements. The Keypad facility information element may be included in the SETUP and INFORMATION messages. The Display information element may be included in any message sent by the network to the user according to Recommendation Q.931[4].

This protocol applies to supplementary service invocation in the user-to-network direction, and the keypad facility codes used for the invocation of individual supplementary services are network dependent.

The protocol is stimulus in the sense that it does not require any knowledge about the invoked supplementary service by the user equipment. It may be used in any state of a call and in association with a call for supplementary service invocation and is applicable to both the basic and primary rate access structures. Paragraph 4 contains a detailed specification of this generic protocol.

2.1.2 *Feature key management protocol*

The Feature key management protocol is based on the use of two information elements that are specified in § 8: the Feature activation and Feature indication information elements. The Feature activation information element may be included in the SETUP and in the INFORMATION messages in the user-to-network direction. The Feature indication information element may be included in various basic call control messages in the network-to-user direction.

This protocol typically applies to supplementary service operation during calls but also allows for non-call related supplementary service control. Non-call related supplementary service control is accomplished by sending an INFORMATION message with the dummy call reference value and which contains a Feature activation information element. The user may send a Feature activation request at any time, and the network may send a Feature indication information element at any time. The supplementary service associated with the Feature identifier is service provider dependent and must be coordinated between the user and the service provider at subscription time. As a service provider option, more than one service profile may be allocated to an interface, but in this case the terminal identification procedures as defined in Annex A must be used in order to relate an appropriate service profile to a particular user.

Note – The term “service profile” refers to the information that the network maintains for a given user to characterize the service offered by the network to that user. A portion of this may contain the association of feature

identifiers to specific supplementary services. A service profile is normally allocated to an interface but may optionally be allocated to a particular user's terminal equipment or to a group of user's terminal equipment using the procedures as defined in Annex A.

This protocol is stimulus in the sense that it does not require knowledge of the invoked supplementary service by the user's terminal equipment. Knowledge of the service profile contained in the network and of the association of Feature keys to specific supplementary service invocations is required to unambiguously define the requested supplementary service. This protocol is typically applicable to the basic rate access structure. A detailed description of this protocol is contained in § 5.

2.1.3 *Functional protocol*

The Functional protocol is based on the use of the Facility information element and the FACILITY message, as well as of other specific functional messages specified in § 7. This protocol is symmetrical, and is applicable to both the basic and primary rate access structures.

This protocol is functional in the sense that it requires the knowledge of the related supplementary service by the user equipment supporting it. This facilitates user equipment operation without human intervention by defining semantics for the protocol elements which user equipment can process on its own.

Functional procedures may follow a Keypad or a Feature key management supplementary service invocation. Messages that are specific to a function are used to invoke supplementary services that require synchronization of resources at both sides of an interface. The common generic message (i.e., the FACILITY message) is used to invoke supplementary services that do not require such resource synchronization.

2.2 *Support of the various generic protocols*

Networks may support more than one of these generic protocols for the control of supplementary services. The support of multiple generic protocols is a network option. Users shall be informed by the service provider at subscription time of the supplementary services available, and of the generic protocols supported on their access.

2.3 *Co-existence of generic protocols*

As a general rule, the Functional protocol shall be used unless the network specifies the use of a stimulus protocol for the invocation of certain supplementary services, or the users have subscribed to a Feature key management facility and service profile.

Networks may support one or more of the three generic protocols; it is a network option as to whether one or more generic protocols are supported on a given access.

In general, the Keypad protocol and Feature key management protocol have only local significance while the Functional protocol may have other than local significance.

For a given call instance, the protocol applied at a local interface may be different from the one applied at a remote user's interface. For example, one of the two stimulus protocols may be used at the requesting user's interface, while a functional procedure will, in general, be applied at the remote user's interface unless a network chooses, as an option, to use the Keypad protocol or Feature key management protocol for supplementary service indication or notification in the network-to-user direction.

3 Arrangements by which co-existence of protocols may be supported by a network

Some networks may support only one of the generic protocols per user access for the invocation of supplementary services. Other networks may choose to support a single generic protocol for the control of supplementary services, depending on the user access interface type (e.g., Feature key or Keypad on the basic access, Functional on the primary access). This has to be arranged at subscription time.

Networks supporting multiple generic protocols per access in the user-to-network direction (i.e., for the supplementary service invocation) will implicitly recognize the protocol option chosen by the user on the basis of the received message type or information element type.

Networks supporting more than one generic protocol per access in the network-to-user direction (i.e., at the remote user interface) may choose to apply a particular protocol depending on the supplementary service characteristics involved. In a case where, for a given supplementary service, more than one protocol can be supported, then the use of the terminal identification procedure as described in Annex A may have to be used in order to determine the protocol supported by that user's terminal equipment, as registered at subscription time.

User service profile procedures, as described in Annex A of this Recommendation, provide a means of characterizing the service(s) offered to different groups of one or more terminals on the same user access interface. A network may, therefore, use a parameter within a user service profile to determine the appropriate procedures for network initiated supplementary services towards the associated group of one or more terminals.

4 Keypad protocol

The Keypad protocol is based on the use of the Keypad facility and Display information elements. While the generic procedures associated with Keypad invocation are specified in this section, the allocation of the access codes used to request/indicate a supplementary service are not to be standardized within the CCITT.

An example of the use of the Keypad protocol is given in Appendix I.

4.1 *General*

This generic procedure is based on the use of:

- the Keypad facility information element by the user to invoke a supplementary service from the network by providing access codes using either en-bloc or overlap sending; and
- the Display information element by the network to give an indication to the local or remote user regarding a supplementary service being invoked. This procedure may be complemented in the case of calls where the Bearer capability information element in the SETUP message is coded indicating “speech” or “3.1 kHz audio”, by the provision of in-band tones/announcements to the user.

Note – As a network option, the Keypad facility information element may be used by the network to give an indication to the user when the network expects an automatic reaction to the received information to acknowledge an invoked supplementary service. As the semantics of the Keypad facility information element are not standardized the use of the Keypad facility information element in the network-to-user direction may inhibit terminal portability since for a terminal to operate successfully on more than one network it must be capable of interpreting various different semantics as assigned by the network to the Keypad facility information. In any case, user equipment not supporting this option shall follow the error recovery procedures defined in § 5.8 of Recommendation Q.931 of receipt of the Keypad facility information element.

The Keypad protocol may be used in conjunction with the Feature key management (§ 5) or Functional protocol (§ 6) during the invocation of a supplementary service.

The Keypad protocol is based on the use of the Keypad facility information element within the INFORMATION or SETUP messages during the establishment, active and clearing phases of a call.

4.2 *Messages used in the Keypad protocol*

As specified in Recommendation Q.931, the Keypad facility information element may be included in both the SETUP and INFORMATION messages and may be sent in the user-to-network direction.

4.3 *Coding of the Keypad facility information element*

The contents of the Keypad facility information element are a string of IA5 characters. The syntax of the IA5 character string and the allocation of values for given supplementary services are not subject to CCITT standardization.

4.4 *Elements of procedure*

4.4.1 *General*

The Keypad protocol includes the following aspects:

- 1) the Keypad protocol may be used during the call establishment, active, and clearing phases of a call to invoke supplementary services. Supplementary service information is conveyed in Keypad facility information elements sent in either SETUP or INFORMATION messages;
- 2) supplementary service information can be sent from the user to the network either en-bloc or using overlap sending;
- 3) the network may prompt the user to send the required information using the Display information element and/or in-band tones or announcements. Whether this action shall occur or not is supplementary service and network specific. In any case, in-band tones or announcements shall only be used when the Bearer capability information element indicates “speech” or “3.1 kHz audio”;

- 4) there may be different combinations of user provided information followed by network prompts. Examples of such possible combinations are shown in Table 4-1/Q.932, where the term “stage” is used to refer to information sent by the user between network prompts (if any).

TABLE 4-1/Q.932

Example of stages for sending of information

Number of stages	Sending information		
1	All information sent en-bloc		
1	All information sent overlap		
2	Overlap	Prompt	Overlap
2	En-bloc	Prompt	En-bloc
2	Overlap	Prompt	En-bloc
2	En-bloc	Prompt	Prompt
3	Overlap	Prompt	Prompt
	... Prompt	Overlap, etc.	

Note – The number of possible stages is network dependent and may also be dependent on the specific supplementary service being invoked.

4.5 *Procedures at the invocation interface*

4.5.1 *User procedures*

The procedures below define how information (using either en-bloc or overlap sending) may be sent in a single stage from the user to the network. The procedures are applicable for each stage of user-to-network information sending.

4.5.1.1 *En-bloc sending of access codes*

En-bloc sending of supplementary service information is accomplished by sending the “complete” supplementary service information in:

- the SETUP message, if the supplementary service is being invoked during the call establishment; or
- the INFORMATION message, if the supplementary service is being invoked from the active phase of the call or during the clearing phase of a call.

The term “complete” supplementary service information means that sufficient supplementary service information is sent to the network to specify a service without any additional network prompting being required. The network determines that the supplementary service information is “complete” by either:

- analysis of the information contents of the Keypad facility information element; or
- the presence of a “sending complete” indication (see Recommendation Q.931, § 5.1.3).

If the network determines that the information contents of the Keypad facility information element are invalid, the network shall use the error procedures specified in § 4.5.2.3.

If the network determined that the information contents are valid and that the user is allowed to invoke the requested service, the network shall respond using the procedures as specified in § 4.5.2.1.

4.5.1.2 *Overlap sending of access codes*

Overlap sending of supplementary service information is the sending of the “complete” supplementary service information (see § 4.5.1.1 for the definition of complete) segmented such that a number of Recommendation Q.931 messages are used to convey the “complete” supplementary service information. The possible combination of messages:

- a) for supplementary services invoked during call establishment, consists of using the SETUP message plus one or more INFORMATION messages which will be sent in the overlap sending state; or
- b) for supplementary services invoked in the active or clearing phases of the call, consists of using two or more INFORMATION messages.

For case a), normal overlap sending procedures, as specified in Recommendation Q.931, § 5.1.3, shall be used.

For case b), the transmission or receipt of INFORMATION messages shall not cause any change to the Recommendation Q.931 call state.

The network shall respond to valid supplementary service information with one of the network responses as described in § 4.5.2.1. If the supplementary service information is invalid, then the error procedures as described in § 4.5.2.3 shall apply.

4.5.2 *Network procedures*

4.5.2.1 *Network responses to user requests*

After receiving information from the user, the network may take one of the following actions. Items 1)-4) are applicable in the cases of both en-bloc and overlap sending; item 5) is applicable only in the case of information sent using overlap sending.

- 1) Clear the call reference via the normal call clearing procedures (see Recommendation Q.931, § 5.3) including the appropriate Cause and optional Display information element(s).
- 2) Send a CALL PROCEEDING message to the user.
Note – This network response is only applicable in a case where the supplementary service is being invoked during call establishment and not in the cases of the supplementary service being invoked from the active or clearing phases of the call.
- 3) Send an INFORMATION or clearing message to the user that includes a Display information element containing an appropriate response to the request for a supplementary service. The receipt of an INFORMATION message by the user shall not cause any change to the Recommendation Q.931 call state.
- 4) Prompt the user for more information using the procedures as specified in § 4.5.2.2. This further information could be additional, or new information input by the user or another attempt by the user to re-input the original information correctly. Such procedures are network dependent and may be supplementary service specific.
- 5) Wait for more overlap information. The allowed waiting period is governed by timer T302 in the case of information sent in the overlap sending state and call control timers for overlap information sent during other phases of the call.

The precise action to be taken is dependent on the specific supplementary service being invoked.

4.5.2.2 *Network prompting and in-band tone/announcement control*

The network may prompt the user for more information or may provide in-band tones or announcements regardless of whether or not the Keypad facility information element was included in the initial SETUP message. The network shall determine whether prompting and/or in-band tone or announcement control should occur. Possible factors governing the provision of prompting and in-band information are:

- the nature of the supplementary service;
- the value of the inter-digit timer;
- the type of interface; and
- the current status or progress of the supplementary service request.

Simultaneously with the application of in-band tones or announcements, the network may send a PROGRESS message containing a Progress indicator information element with the progress descriptor No. 8, *In-band information or appropriate pattern now available*.

The network may, in addition to an audible prompt (i.e., tone or announcement), request information from the user by sending an INFORMATION message which contains the Display and/or Signal information elements (but shall not contain the Called party number information element).

The sending of the INFORMATION message by the network does not result in a change to the Recommendation Q.931 call state. However, when this message is sent in the network overlap sending state, timer T302 shall be re-initialized.

The network may prompt the user more than once (i.e., multiple stages may occur), but the network should not prompt the user again prior to the user's response, or, when in the overlap sending state, prior to the expiry of timer T302. This is to avoid situations where a user's response could be related to two unacknowledged network prompts.

Note – As a network option, the Information Request procedures described in Annex B of this Recommendation may be used to prompt the user for additional information related to a given service request.

4.5.2.3 *Error conditions and treatment*

An error condition exists in the following circumstances:

- a) timer T302 expires and complete information has not been received;
- b) information containing a “sending complete” indication indicating en-bloc sending, but the user information sent is not complete;
- c) information received by the network (complete or incomplete) is invalid. Invalid information is information sent with incorrect format or containing invalid facility identifier or parameter codes;
- d) the user attempts to invoke a supplementary service to which the user has not subscribed or to which the user is not allowed access.

The action to be taken by the network in these situations is as follows.

Note – The text below identifies possible actions that may be taken in an error situation. The specific action to be taken is network and supplementary service dependent.

4.5.2.3.1 *Supplementary service being invoked during call establishment*

The network shall take one of the following actions:

- i) In-band tones or announcements are applied. If a SETUP ACKNOWLEDGE message has not already been sent, the network shall send a CALL PROCEEDING message to the user, indicating the B-channel to be used and including the Progress indicator information element with progress descriptor No. 8, *In-band information or appropriate pattern is now available*.

If a SETUP ACKNOWLEDGE message has already been sent, the network shall send a PROGRESS message to the user, including the Progress indicator information element with the progress descriptor No. 8, *In-band information or appropriate pattern is now available*.

The network may prompt the user using the procedures as specified in § 4.5.2.2 to re-input the required information. Otherwise, after the in-band tone or announcement has been applied, the call reference shall be cleared by either the user initiating call clearing or the network initiating call clearing at the expiry of a tone or announcement timer. Both the network and the user shall use the clearing procedures as specified in Recommendation Q.931, § 5.3.

- ii) No in-band tones or announcements are to be applied. The call reference shall be cleared by the network initiating call clearing procedures as specified in Recommendation Q.931, § 5.3.

4.5.2.3.2 *Supplementary service being invoked from the active state or during the call clearing phase*

The network shall take one of the following actions:

- i) In-band tones or announcements are applied. The network may prompt the user using the procedures as specified in § 4.5.2.2 to re-input the request. Otherwise, depending on the specific supplementary service being invoked, the call shall either be cleared or remain in the same call state. In the case where the call is cleared, clearing shall occur after the in-band tone or announcement has been applied. Clearing shall occur either by the user initiating call clearing or by the network initiating call clearing at the expiry of a tone or announcement timer. Both the network and the user shall use the clearing procedures as specified in Recommendation Q.931, § 5.3.
- ii) No in-band tones or announcements are to be applied. Depending on the specific supplementary service being invoked, the call shall either be cleared or remain in the same call state. In the case where the call is to be cleared, the call reference shall be cleared by the network initiating call clearing using the procedures as specified in Recommendation Q.931, § 5.3. If the call remains in the same call state, the user may be informed that the supplementary service request was unsuccessful by the network sending an INFORMATION message in accordance with § 4.5.2.1, item 3).

4.6 *Procedures at the remote interface*

The Display and/or Signal information elements can be used for the purpose of providing notification to the remote user from the network. In this case, however, this information is used simply for the purpose of informing the human user, and no automatic reaction to the received information is to be performed by the user’s equipment itself.

5 Feature key management protocol

The Feature key management protocol is a mechanism allowing users to invoke network supplementary services. As these are stimulus procedures, the protocol elements do not, in and of themselves, identify the service invoked. To determine the service invoked requires knowledge of the user's service profile maintained in the network. No call state changes directly occur by these procedures.

The Feature key management protocol is based on two information elements: Feature activation and Feature indication. The Feature activation information element is the means by which a user requests a supplementary service. The Feature activation information element contains a feature identifier number which the network then maps to the corresponding service as indicated by that user's service profile. The user's equipment need not have any knowledge of what service is being indicated by the feature identifier number and the user may send a feature request at any time.

Feature indication is the means by which a response to a feature activation is indicated by the network. The feature identifier number correlates the network's response with a user's request and/or an indicator associated with a user's equipment. The Feature indication information element also contains a status indicator. The status indicator indicates the status of the requested service and may be used by the user's equipment as appropriate with its man-machine interface.

5.1 Messages

The Feature activation and Feature indication information elements may be present in several of the messages defined in Recommendation Q.931. The Feature activation information element may appear in the following messages in the user-to-network direction:

- a) SETUP
- b) INFORMATION.

The Feature indication information element may be sent in the network-to-user direction in the following messages:

- a) SETUP
- b) SETUP ACKNOWLEDGE
- c) CONNECT
- d) CALL PROCEEDING
- e) ALERTING
- f) INFORMATION
- g) DISCONNECT
- h) RELEASE
- i) RELEASE COMPLETE.

5.2 Procedures

5.2.1 Assumptions and restrictions

- a) These procedures assume that only one Feature activation request will appear in a message.
- b) The phrase "call associated services" used herein is defined as services which act upon or relate to an existing call (as defined by the existence of a call reference).
- c) These procedures are used for the invocation of supplementary services which relate to predefined specific bearer capabilities and/or are context dependent. Hence the capability to include protocol elements to indicate the bearer capability that the supplementary service is to act upon is not provided.

5.2.2 Invocation of supplementary services

The user may request a feature by including a Feature activation information element in the messages defined in § 5.1. If the INFORMATION message is used, it may be sent at any time. The user will indicate the desired feature by specifying the appropriate value in a feature identifier number.

5.2.2.1 Determination of call reference in the INFORMATION message

When the Feature activation information element is sent in the INFORMATION message, then the following rules apply:

- a) if no call references exist, then the dummy call reference must be used (for this non-call associated service type);
- b) if a call reference(s) has been established, then that value may be used regardless of whether the service type is call associated or non-call associated;
- c) if a call reference(s) has been established, the dummy call reference may be used only if the service type is non-call associated. If the service type is call associated, then the appropriate call reference must be used. An exception to this rule is when only one call is established. In this instance it is permissible for the user to use the dummy call reference for either service type.

This is summarized in Figure 5-1/Q.932.

Service type	No calls exist	Call(s) exist
Non-call associated	Use dummy call reference	Use dummy or active call reference
Call associated	Error; not allowed	Use an active call reference (Note)

Note – The dummy call reference value may be used if only one call is established.

FIGURE 5-1/Q.932

Use of the call reference in an INFORMATION message

It is always correct for the user’s equipment to use the dummy call reference when no calls exist, or to use an established call reference if one exists, independent of the service type.

5.2.3 *Network responses*

The network may respond to a Feature activation request in several ways. This action will be supplementary service and network specific.

5.2.3.1 *Normal responses*

5.2.3.1.1 *Return of a Feature indication*

The network may return a Feature indication information element in an INFORMATION message or any other appropriate call control message as defined in § 5.1. The feature indication may or may not have the same feature identifier number as was present in the original feature activation request. The status indicator will be provided as appropriate to the specific supplementary service requested.

5.2.3.1.2 *Prompting for further information*

The network may prompt the user for more information. When in the overlap sending state, it may do so using the information request procedures (described in Annex B).

The user’s response shall follow normal overlap sending procedures as defined in Recommendation Q.931. As a network option, the information request procedures described in Annex B of this Recommendation may be used to prompt the user for additional information related to a given service request.

5.2.3.1.3 *Implicit response*

The network, under certain situations, may not return any explicit indication to the user after a feature activation request. In this case the response is implicit, such as the acknowledgement inherent in providing the service.

5.2.3.1.4 *Return of Signal, Cause, or Display information elements*

The network may return any combination of Signal, Cause, or Display information elements in conjunction with the responses as described in § 5.2.3.1. The use of these information elements is supplementary service and network specific. Coding and the appropriate messages that may contain these information elements are as defined in Recommendation Q.931.

5.2.3.2 *Responses during error conditions*

When an error condition exists (as defined in § 5.2.5), the network may:

- a) Respond with one or more of the following options:
 - 1) return a Feature indication information element;
 - 2) prompt for further information (see Annex B);
 - 3) provide an implicit response; or
 - 4) return Signal, Cause, or Display information elements.
- b) Ignore the Feature activation request and not respond at all.
- c) Clear appropriate existing calls in conjunction with the above actions.

5.2.4 *General aspects*

5.2.4.1 *Use of Feature indication information elements independent of a feature request*

The network may choose to send Feature indication information at any time independent of the status of any call(s). Multiple Feature indication information elements may be returned in an INFORMATION message or in an appropriate call control message if more than one indicator is to be updated.

5.2.4.2 *Deactivation procedures*

When explicitly deactivating a supplementary service, two methods may be used:

- a) sending of a feature activation request with the same feature identifier may deactivate the supplementary service. Some supplementary services may be “toggled” on and off;
- b) sending of a feature activation request with a different feature identifier which is explicitly defined (between the user and network) as the deactivator for that particular supplementary service.

5.2.4.3 *Clearing of a call*

If a Feature activation information element is sent using the call reference of an active call, and that call is cleared for some reason, then there does not exist a call reference with which to correlate the feature indication. If a Feature indication information element is to be returned, then one of the following options may be used:

- a) the network may send a Feature indication information element in one of the call clearing messages (i.e., DISCONNECT, RELEASE, or RELEASE COMPLETE);
- b) the network may send a Feature indication information element in an INFORMATION message after clearing has occurred using the dummy call reference.

5.2.5 *Error conditions*

5.2.5.1 *Invalid feature activation request*

If a user requests a feature using an invalid feature identifier number, the network may take actions specified in § 5.2.3.2 as appropriate. An invalid feature identifier number is one in which the user has not subscribed to a corresponding service, or the value is not understood by the service provider (e.g., out of range).

5.2.5.2 *Invalid call reference*

If a user violates the use of the call reference as stated in § 5.2.2.1, the network should not provide the service and should respond as indicated in § 5.2.3.2.

5.2.5.3 *Sending of multiple feature activation requests*

If a sequence of feature activation requests is received in separate messages so rapidly that the network cannot respond to the first feature activation request prior to receiving a subsequent feature activation request, the network may take one of the following actions:

- a) act upon all feature activation requests by returning multiple Feature indication information elements (or other responses as detailed in § 5.2.3.1). These may be sent in a single message or in multiple messages;
- b) act upon the first feature activation request by returning a single response. This response should correspond to the first feature activation request. Feature activation requests after the first request are discarded and ignored by the network.

The determination of which action to take is network and supplementary service specific.

6 Functional protocol

6.1 General

6.1.1 Introduction

This section specifies the functional signalling procedures for the control of supplementary services at the user-network interface. This generic protocol utilizes functions and services provided by Recommendations Q.930 [5] and Q.931 [4] basic call control procedures and the functions of the data link layer as defined in Recommendations Q.920 [6]/Q.921 [3].

6.1.2 Scope of the procedures

The procedures defined in § 6 specify the basic methodology for the control (e.g., invocation, notification, cancellation, etc.) of supplementary services. The procedures are independent of whether or not the user-network interface is a basic or primary rate interface.

6.1.3 Categories of procedures

Two categories of procedures are defined for the functional signalling for supplementary services. The first category, called the separate message approach, utilizes separate message types to indicate a desired function. The HOLD and RETRIEVE set of messages are identified for this category.

The second category, called the common information element procedure, utilizes the Facility information element and applies only to supplementary services that do not require synchronization of resources between the user and the network.

Both categories are specified in a symmetrical manner and can be signalled both in the network-to-user and the user-to-network directions.

6.1.4 Supplementary service functions

The control of supplementary services by either the network or the user includes the following cases:

- a) the invocation of supplementary services during the establishment of a call;
- b) the invocation of supplementary services during the clearing of a call;
- c) the invocation of call related supplementary services during the active state of a call;
- d) the invocation or registration of supplementary services independent from an active call;
- e) the invocation of multiple, different supplementary services within a single message;
- f) the invocation of supplementary services related to different calls;
- g) cancellation of invoked supplementary services and notification to the initiator of the supplementary service.

The correlation of a call related supplementary service and the call which it modifies is provided by use of the call reference [cases a), b), c), e), f) and g) listed above].

The correlation of call independent supplementary service invocations and their responses, is provided by the combination of the call reference of the message containing the Facility information element and the invoke identifier present within the Facility information element itself [refer to cases d), e) and g)].

The identification of different supplementary service invocations within one single message is provided by the invoke identifier of the corresponding Facility information element [refer to cases e) and g)]. The identification of supplementary service invocations related to different calls is provided by different messages with the corresponding call reference of the appropriate call [refer to case f)], i.e., different call reference values are used to identify each call individually.

6.2 Separate messages category

The messages defined in this section are specified as separate functional messages for invoking specific functions which require changes of the resources and auxiliary state and also require synchronization of the peer-to-peer state machines. Therefore, these functions cannot be performed in conjunction with the call establishment and clearing procedures but may be used in conjunction with various supplementary services. The functions of these messages are not to be duplicated or overlapped by those of the Facility information element.

The following individual messages are defined:

HOLD

HOLD ACKNOWLEDGE
HOLD REJECT
RETRIEVE
RETRIEVE ACKNOWLEDGE
RETRIEVE REJECT.

6.2.1 *Hold and Retrieve functions*

The Hold function is used to put an existing call which is in the establishment or in the active phase in the Call Held auxiliary state. By default, it reserves the B-channel in use (if any) or any other B-channel (if none was already reserved) for that user which is identified by a Connection Endpoint Suffix (CES), as defined in Recommendation Q.921. In addition, the call reference of the held call shall be retained for possible subsequent call retrieval and channel reconnection.

As an option, based on a subscription arrangement between the user and the service provider, the B-channel may be released for subsequent re-use by the network for another call.

On receipt of a HOLD message the user or the network shall return a HOLD ACKNOWLEDGE message, provided that the requested function can be performed. The network disconnects any B-channel allocated to the call in progress or active when putting that call in the Call Held auxiliary state.

Note 1 – Generally, only one B-channel is reserved for each user having put one (or more) call(s) on hold. However, as a subscription option, a network may reserve more than one B-channel to a user.

Note 2 – Enhancements to the procedures may be required for users requesting the non-reservation of the B-channel, on a per call basis.

The HOLD ACKNOWLEDGE message puts the call in the held auxiliary state and indicates that the Hold function has been performed. The HOLD REJECT message indicates that the hold request was denied and returns the call to the condition it was in prior to the hold request. The HOLD REJECT message contains the Cause information element with e.g., cause No. 29, *Facility rejected*, or No. 50, *Requested facility not subscribed*, or No. 69, *Requested facility not implemented*.

The Retrieve function reconnects the user to the requested B-channel. The RETRIEVE message requests that a call be retrieved. The RETRIEVE ACKNOWLEDGE message indicates that the Retrieve function has been performed. The RETRIEVE REJECT message indicates that the retrieve request was denied. The RETRIEVE REJECT message contains the Cause information element with e.g., cause No. 44, *Requested channel not available*, or No. 34, *no channel available*.

The HOLD and RETRIEVE families of message may be used in a symmetrical manner.

6.2.2 *Hold procedures*

The Hold function should be invoked in association with an existing call (i.e., during the establishment or active phase of a call).

The invocation of the Hold function does not affect the existing Recommendation Q.931 call states but does affect the auxiliary state. The request for placing a call on hold places the auxiliary state in the Hold Request state. The responding entity will acknowledge this request with a HOLD ACKNOWLEDGE message if this operation was successful. This will result in the auxiliary state being put in the Call Held state. If the requested Hold function cannot be obtained, then a HOLD REJECT message will be returned with the appropriate cause. This will result in the auxiliary state returning to the Idle state.

6.2.3 *Retrieve procedures*

The Retrieve function is requested by sending a RETRIEVE message. This message may be sent while the auxiliary state is in the Call Held state.

The RETRIEVE message may indicate a preferred, any, or exclusive channel. Procedures for the use of the Channel identification information element are as defined for basic call control. Upon the sending of the RETRIEVE message, the auxiliary state of the initiator's terminal would be the Retrieve Request state.

If the Retrieve request is successful, the RETRIEVE ACKNOWLEDGE message will be returned with the selected B-channel indicated. The initiator should not assume that call retrieval has occurred until it receives this message. The auxiliary state would then return to the Idle state.

If the Retrieve request is not successful, the RETRIEVE REJECT message will be returned with an appropriate cause. The auxiliary state machine would then remain in the Call Held state.

6.2.4 *Auxiliary states for hold and retrieve*

It is possible to place a call on hold in the Outgoing Call Proceeding, Call Delivered, or the Active state. The concept of dimensioned state space is being introduced to ensure state synchronization between the user and the network. This concept suggests dimensioning the call state machine into two dimensions. In other words, there would be two states associated with each call. The first would be a Recommendation Q.931 call state and the second would be an auxiliary state associated with Hold. Suppose the dimensioned state space is represented by two coordinates: one is a Recommendation Q.931 call state coordinate and the other is a Hold coordinate. If a Recommendation Q.931 call state transition occurs, the former coordinate is updated. If a call is put on hold, the hold coordinate is updated. When the held call is reconnected, the hold coordinate is again updated.

There are four auxiliary states associated with the Hold and Retrieve functions:

- i) Idle;
- ii) Hold Request – A request has been made for the Hold function;
- iii) Call Held – The call is held;
- iv) Retrieve Request – A request has been made for the Retrieve function.

6.2.5 *An example of dimensioned state space*

Suppose a call is in the Outgoing Call Proceeding state. The dimensioned state space would be:

(Outgoing Call Proceeding, Idle)

Now the user requests the Hold function. The dimensioned state space would become:

(Outgoing Call Proceeding, Hold Request)

The call is then put on Hold. The user becomes aware of this upon receiving the HOLD ACKNOWLEDGE message from the network. The dimensioned state space would now be:

(Outgoing Call Proceeding, Call Held)

The user may receive subsequent call progress messages changing the dimensioned state space to:

(Active, Call Held)

Now the user requests the Retrieve function. The dimensioned state space would become:

(Active, Retrieve Request)

When a call is reconnected, the dimensioned state space would be:

(Active, Idle)

6.3 *Common information element category*

The Common information element category applies only to supplementary services where no synchronization of resources is required between the two signalling entities. However, the user equipment is required to have the capability to track the operation of the supplementary service procedures through various Recommendation Q.931 call states. The procedures are symmetrical and applicable to both user-network and NT2-NT2 applications.

A REGISTER, a FACILITY or an existing Recommendation Q.931 call control message is used to carry the Facility information element which requests the desired supplementary service.

This functional procedure provides a flexible and open ended approach to the provision of supplementary service protocols and:

- allows new services to be easily introduced;
- allows multiple supplementary service invocations within one message;
- supports supplementary services with a large number of variants without a proliferation of new messages;
- supports non-call associated supplementary services.

In addition, the use of the FACILITY message allows the actions and events related to supplementary services to be clearly separated from those associated with basic call control, hence providing improved stability to the basic call control procedures of Recommendation Q.931.

6.3.1 *Call related supplementary service procedures*

For call related supplementary service procedures initiated at call establishment or call clearing, the procedures for call control as specified in §§ 5 and 6 of Recommendation Q.931 are utilized. This enables, for example, the

originating user to send a supplementary service invocation within a SETUP message and to receive from the remote user a return result, return error, or reject component type in the Facility information element within an ALERTING message, CONNECT message, or any other appropriate message from the service provider. If for some reason the network or user is not able to process the call related invocation of a supplementary service contained in an outgoing SETUP message, then the following options apply:

- 1) the network or user may clear the call request and reject the supplementary service invocation by means of a RELEASE COMPLETE message which contains the Cause information element and a return error or reject component type with the appropriate parameters in the Facility information element;
- 2) the network or user may continue to process the call request according to normal Recommendation Q.931 call control procedures, and reject the supplementary service invocation by including a return error or reject component type with an appropriate data element in the Facility information element by means of a FACILITY message or in any appropriate Recommendation Q.931 message;
- 3) the network or user may continue to process the call request according to the Recommendation Q.931 call control procedures, and ignore the supplementary service invocation.

The option to be used depends on the individual supplementary service procedures, which are the subject of other Recommendations.

For call related supplementary service invocations during the Active state of a call, the FACILITY message is used for the exchange of the Facility information elements over the existing signalling connection. This signalling connection is identified by the call reference of the corresponding active call.

The call reference provides the means to correlate FACILITY messages belonging to the same signalling transaction. In the case of call related invocations, the call reference correlates with the appropriate call transaction. When a supplementary service affects more than one call, different call references are used to identify each call individually. This implies the use of different FACILITY messages in order to manage each call separately.

If a call related FACILITY message is sent using the call reference of a call in progress or of an active call, and this call is cleared due to call related causes, then the call reference may not be cleared simultaneously in call cases.

Depending upon the supplementary service invoked, one of the following will occur:

- the network or user may retain both the connection and the call reference association and may send a response within a Facility information element in a FACILITY message prior to the initiation of the normal call clearing procedures; or
- the network or user may send a response within a Facility information element in the first clearing message (i.e., DISCONNECT, RELEASE, or RELEASE COMPLETE message).

6.3.2 *Call independent supplementary service procedures*

For supplementary service procedures independent of an active call, the initiating side must first establish a reliable data link connection between the network and the user according to the data link services described in Recommendation Q.921. Once the data link connection is established the user or the network starts the establishment of the signalling connection by transferring a REGISTER message across the user-network interface. This signalling connection is identified by the call reference associated with the REGISTER message. The requested supplementary service is identified by the operation value within the Facility information element. This signalling connection may be released by the exchange of return result, return error or reject component types contained in the Facility information element within a RELEASE COMPLETE message.

Examples of message exchange for supplementary service control for various scenarios is described by means of arrow diagrams in Appendix I.

To assign a call reference value and convey the supplementary service invocation, a REGISTER message with an optional Facility information element is used. The Facility information element present either in the REGISTER message or in a subsequent message identifies the supplementary service involved and the type of operation (i.e., invoke, return result, return error or reject component). One of the following will occur:

- 1) When the REGISTER message contains a Facility information element and the requested service is available, a FACILITY message containing the Facility information element may be returned. One or more exchanges of FACILITY messages may subsequently occur. To terminate the service interaction and release the call reference value, a RELEASE COMPLETE message is sent by either side of the interface. The RELEASE COMPLETE message may also contain the Facility information element.
- 2) If the content of the Facility information element is not understood, then a FACILITY message or a RELEASE COMPLETE message with the Facility information element is returned with the Reject component type. When the rejection has been returned in a FACILITY message, the Facility information

element can be re-sent in another FACILITY message or the request can be cleared and the call reference value released with a RELEASE COMPLETE message.

- 3) If the content of the Facility information element is understood, but the supplementary service request cannot be provided, then a FACILITY message or a RELEASE COMPLETE message with the Facility information element is returned with the component return error. When the rejection has been returned in a FACILITY message, the Facility information element can be re-sent in another FACILITY message or the request can be cleared and the call reference value released with a RELEASE COMPLETE message.

6.3.3 *Responses to multiple supplementary service invocations*

The possible correlation of responses to multiple supplementary service invocations is the subject of future Recommendations.

6.3.4 *Coding of the call reference*

For general rules, format and coding of call reference values, § 4.3 of Recommendation Q.931 is applicable. For the functional supplementary service control, the dummy call reference is not applicable.

7 **Message functional definitions and content**

This section should be read in conjunction with § 3 of Recommendation Q.931. All messages are additional to those defined in that section and the following tables should be interpreted according to the introduction of § 3 of Recommendation Q.931.

7.1 *Messages for supplementary service control*

Table 7-1/Q.932 summarizes the messages specific to supplementary service control procedures.

TABLE 7-1/Q.932

Messages specific to supplementary service control

	Reference
FACILITY	7.1.1
HOLD	7.1.2
HOLD ACKNOWLEDGE	7.1.3
HOLD REJECT	7.1.4
REGISTER	7.1.5
RETRIEVE	7.1.6
RETRIEVE ACKNOWLEDGE	7.1.7
RETRIEVE REJECT	7.1.8

7.1.1 FACILITY

This message may be sent to request or acknowledge a supplementary service. The supplementary service to be invoked, and its associated parameters, are specified in the Facility information element (see Table 7-2/Q.932).

For the use of this message, see § 6.

TABLE 7-2/Q.932

FACILITY message content

Message type: FACILITY
Significance: local (Note 1)
Direction: both

Information element	Reference	Direction	Type	Length
Protocol discriminator	4.2/Q.931	both	M	1
Call reference	4.3/Q.931	both	M	2 – *
Message type	8.1/Q.932	both	M	1
Facility	8.2/Q.932	Both	M	8 – *
Display	4.5/Q.931	n → u	O (Note 2)	(Note 3)

M Mandatory
O Optional

Note 1 – This message has local significance; however, it may carry information of global significance.

Note 2 – Included if the network provides information that can be presented to the user.

Note 3 – The minimum length is 2 octets. The maximum length is network dependent and is either 34 or 82 octets.

7.1.2 HOLD

This message is sent by the network or the user to request the hold function for an existing call (see Table 7-3/Q.932).

For the use of this message, see § 6.

TABLE 7-3/Q.932

HOLD message content

Message type: HOLD
Significance: local
Direction: both

Information element	Reference	Direction	Type	Length
Protocol discriminator	4.2/Q.931	both	M	1
Call reference	4.3/Q.931	both	M	2 – *
Message type	8.1/Q.932	both	M	1
Display	4.5/Q.931	n → u	O (Note 1)	(Note 2)

Note 1 – Included if the network provides information that can be presented to the user.

Note 2 – The minimum length is 2 octets. The maximum length is network dependent and is either 34 or 82 octets.

7.1.3 *HOLD ACKNOWLEDGE*

This message is sent by the network or the user to indicate that the hold function has been successfully performed (see Table 7-4/Q.932).

For the use of this message, see § 6.

TABLE 7-4/Q.932

HOLD ACKNOWLEDGE message content

Message type: HOLD ACKNOWLEDGE

Significance: local

Direction: both

Information element	Reference	Direction	Type	Length
Protocol discriminator	4.2/Q.931	both	M	1
Call reference	4.3/Q.931	both	M	2 – *
Message type	8.1/Q.932	both	M	1
Display	4.5/Q.931	n → u	O (Note 1)	(Note 2)

Note 1 – Included if the network provides information that can be presented to the user.

Note 2 – The minimum length is 2 octets. The maximum length is network dependent and is either 34 or 82 octets.

7.1.4 *HOLD REJECT*

This message is sent by the network or the user to indicate the denial of a request to hold a call (see Table 7-5/Q.932).

For the use of this message, see § 6.

TABLE 7-5/Q.932

HOLD REJECT message content

Message type: HOLD REJECT

Significance: local

Direction: both

Information element	Reference	Direction	Type	Length
Protocol discriminator	4.2/Q.931	both	M	1
Call reference	4.3/Q.931	both	M	2 – *
Message type	8.1/Q.932	both	M	1
Cause	4.5/Q.931	both	M	4 – 32
Display	4.5/Q.931	n → u	O (Note1)	(Note 2)

Note 1 – Included if the network provides information that can be presented to the user.

Note 2 – The minimum length is 2 octets. The maximum length is network dependent and is either 34 or 82 octets.

7.1.5 REGISTER

This message is sent by the user or the network to assign a new call reference for non-call associated transactions (see Table 7-6/Q.932).

For the use of this message, see § 6.

TABLE 7-6/Q.932

REGISTER message content

Message type: REGISTER

Significance: local (Note 1)

Direction: both

Information element	Reference	Direction	Type	Length
Protocol discriminator	4.2/Q.931	both	M	1
Call reference	4.3/Q.931	both	M	2 – *
Message type	8.1/Q.932	both	M	1
Facility	8.2/Q.932	both	O (Note 4)	2 – *
Display	4.5/Q.931	n → u	O (Note 2)	(Note 3)

Note 1 – This message has local significance; however, it may carry information of global significance.

Note 2 – Included if the network provides information that can be presented to the user.

Note 3 – The minimum length is 2 octets. The maximum length is network dependent and is either 34 or 82 octets.

Note 4 – Included if the network or the user provides supplementary service information.

7.1.6 RETRIEVE

This message is sent by the network or the user to request the retrieval of a held call (see Table 7-7/Q.932).

For the use of this message, see § 6.

TABLE 7-7/Q.932

RETRIEVE message content

Message type: RETRIEVE

Significance: local

Direction: both

Information element	Reference	Direction	Type	Length
Protocol discriminator	4.2/Q.931	both	M	1
Call reference	4.3/Q.931	both	M	2 – *
Message type	8.1/Q.932	both	M	1
Channel identification	4.5/Q.931	both	O (Note 1)	2 – *
Display	4.5/Q.931	r → u	O (Note 2)	(Note 3)

Note 1 – If not included, its absence is interpreted as any channel acceptable.

Note 2 – Included if the network provides information that can be presented to the user.

Note 3 – The minimum length is 2 octets. The maximum length is network dependent and is either 34 or 82 octets.

7.1.7 RETRIEVE ACKNOWLEDGE

This message is sent by the network or the user to indicate that the retrieve function has been successfully performed (see Table 7-8/Q.932).

For the use of this message, see § 6.

TABLE 7-8/Q.932

RETRIEVE ACKNOWLEDGE message content

Message type: RETRIEVE ACKNOWLEDGE

Significance: local

Direction: both

Information element	Reference	Direction	Type	Length
Protocol discriminator	4.2/Q.931	both	M	1
Call reference	4.3/Q.931	both	M	2 – *
Message type	8.1/Q.932	both	M	1
Channel identification	4.5/Q.931	both	O (Note 1)	2 – *
Display	4.5/Q.931	n → u	O (Note 2)	(Note 3)

Note 1 – Mandatory in all cases except when the sender accepts the specific B-channel indicated in the RETRIEVE message. If included, a channel is indicated and specified as exclusive.

Note 2 – Included if the network provides information that can be presented to the user.

Note 3 – The minimum length is 2 octets. The maximum length is network dependent and is either 34 or 82 octets.

7.1.8 RETRIEVE REJECT

This message is sent by the network or the user to indicate the inability to perform the requested retrieve function (see Table 7-9/Q.932).

For the use of this message, see § 6.

TABLE 7-9/Q.932

RETRIEVE REJECT message content

Message type: RETRIEVE REJECT

Significance: local

Direction: both

Information element	Reference	Direction	Type	Length
Protocol discriminator	4.2/Q.931	both	M	1
Call reference	4.3/Q.931	both	M	2 – *
Message type	8.1/Q.932	both	M	1
Cause	4.5/Q.931	both	M	4 – 32
Display	4.5/Q.931	n → u	O (Note 1)	(Note 2)

Note 1 – Included if the network provides information that can be presented to the user.

Note 2 – The minimum length is 2 octets. The maximum length is network dependent and is either 34 or 82 octets.

8 General message format and information element coding

This section should be read in conjunction with § 4 of Recommendation Q.931 and contains the coding of the information elements specifically used by the procedures described in this Recommendation.

8.1 *Message type*

The following additional codings are defined in Table 8-1/Q.932 for message type.

8.2 *Other information elements*

These information elements are coded according to the general coding rules as defined in § 4.5.1 of Recommendation Q.931.

Note – The value used for Protocol discriminator shall be as defined for messages used in Recommendation Q.931.

Table 8-2/Q.932 contains the codepoints allocated to the information elements defined in this Recommendation.

8.2.1 *Endpoint identifier*

The purpose of the Endpoint identifier information element is:

- to indicate the user service identifier and terminal identifier for the purpose of terminal identification; and
- to indicate a specific terminal for the purpose of terminal selection.

(See Annex A for the associated procedures.)

The Endpoint identifier information element is coded as shown in Figure 8-1/Q.932 and Table 8-3/Q.932.

The default maximum length of the Endpoint identifier information element is four octets.

8.2.2 *Facility*

This section defines only the structure and the coding of the Facility information element. Specific procedures that will be required are subject to further study in relation to future Recommendations on specific supplementary services.

The purpose of the Facility information element is to indicate the invocation and operation of supplementary services, identified by the corresponding operation value within the Facility information element. The Facility information element is defined in Figures 8-2/Q.932 to 8-5/Q.932 and Tables 8-4/Q.932 to 8-20/Q.932.

The Facility information element may be repeated in a given message.

The maximum length of the Facility information element is application dependent consistent with the maximum length of the message.

8.2.2.1 *Component (Octets 4, etc.)*

This specification makes use of and is a subset of Recommendations X.208 [7] (Specification of Abstract Syntax Notation One (ANS.1)), X.209 [8] (Specification of basic encoding rules for Abstract Syntax Notation One (ANS.1)), X.219 [9] (Remote operations: model, notation and service definition) and X.229 [10] (Remote operations: protocol specification). Based on Recommendations X.208 and X.209, the following specific encoding apply.

A component is a sequence of data elements each of which is made up of a tag, a length and a contents. The component type is indicated by the first octet of the Facility information element component. The component types defined for the Facility information element are:

- Invoke
- Return result
- Return error
- Reject.

Note 1 – Recommendation X.229 which defines the Remote Operations Service Element (ROSE) uses the term Application Protocol Data Unit (APDU) in place of component. However since this protocol element may be applied to the support of network layer services and of application layer services, the term “component” is more appropriate in the context of this Recommendation.

Tables 8-5/Q.932 to 8-8/Q.932 show the structure of these component types.

Note 2 – See Appendix III for a general description of the component coding and formatting principles.

TABLE 8-1/Q.932

Q.932 message types

Bits								
8	7	6	5	4	3	2	1	
0	0	1	-	-	-	-	-	(Q.931 call information phase message group)
			0	0	1	0	0	HOLD
			0	1	0	0	0	HOLD ACKNOWLEDGE
			1	0	0	0	0	HOLD REJECT
			1	0	0	0	1	RETRIEVE
			1	0	0	1	1	RETRIEVE ACKNOWLEDGE
			1	0	1	1	1	RETRIEVE REJECT
0	1	1	-	-	-	-	-	(Q.931 miscellaneous message group)
			0	0	0	1	0	FACILITY
			0	0	1	0	0	REGISTER

TABLE 8-2/Q.932

Information elements specific to supplementary service control

Bits								Reference §	Maximum length (octets) (Note 1)	
8	7	6	5	4	3	2	1			
0	:	:	:	:	:	:	:	<i>Variable length information elements:</i>		
0	0	1	1	1	0	0		Facility	8.2.2	Note 3
0	1	1	0	0	1	0		Information request	8.2.5	3
0	1	1	1	0	0	0		Feature activation	8.2.3	4
0	1	1	1	0	0	1		Feature indication	8.2.4	5
0	1	1	1	0	1	0		Service profile identification	8.2.6	32
0	1	1	1	0	1	1		Endpoint identifier	8.2.1	4
All other values are reserved (Note 2)										

Note 1 – The length limits described for the variable length information elements below take into account only the present CCITT standardized coding values. Future enhancements and extensions to this Recommendation will not be restricted to these limits.

Note 2 – The reserved values with bits 5-8 coded “0000” are for future information elements for which comprehension by the receiver is required (see § 5.8.7.1 of Recommendation Q.931)

Note 3 – The maximum length of the Facility information element is application dependent consistent with the maximum length of the message.

		Bits							Octets	
		8	7	6	5	4	3	2	1	
0	Endpoint identifier							1		
	0	1	1	1	0	1	1			
		Information element identifier								
		Length of endpoint identifier contents							2	
1 Ext.	User service identifier							3		
1 Ext.	Interpreter	Terminal identifier					4*			

* This octet is optional.

FIGURE 8-1/Q.932

Endpoint identifier information element

TABLE 8-3/Q.932

Endpoint identifier information element

User service identifier (USID) (octet 3)

The USID is a selection parameter which identifies a group of terminals on an interface which share a common service profile and which may be addressed together. Upon receipt of this element, a terminal will consider itself as being addressed if the value received matches its stored value or if the value received is coded as all "1"s (127). When USID is coded as 127, octet 4 is not used.

Interpreter (octet 4)

Bit 7 of octet 4 indicates how a terminal is to interpret the TID field received. When set to "0", the terminal is being addresses only if the TID matches (see TID definition following). When set to "1", the terminal is being addressed only if the TID received is not 63 and does not match. In the user-to-network direction, this bit is set to "0".

Terminal identifier (TID) (octet 4)

The TID is a selection parameter which identifies a single terminal within a group designated by a USID value. For USID = 127, the TID does not apply. Upon receipt to this field, a terminal will consider itself addressed if one of the following is true:

- the interpreter bit = "0" and the value received matches the terminal's stored value;
- the interpreter bit = "1" and the value received does not match the terminal's stored value;
- the value received is coded all "1"s (63).

Bits								Octets
8	7	6	5	4	3	2	1	
Facility								1
0	0	0	1	1	1	0	0	
Information element identifier								
Length of facility contents								2
1 Ext.	0	0	Service discriminator					3
Component(s) (Note)								4, etc

Note – One or more components may be included depending on specific service requirements

FIGURE 8-2/Q.932

Facility information element

TABLE 8-4/Q.932

Facility information element

<i>Service discriminator</i>					
Bits					
5	4	3	2	1	
1	0	0	0	1	Discriminator for supplementary service applications
All other values are reserved and their usage is the subject of other Recommendations.					

TABLE 8-5/Q.932

Invoke component

Invoke component	Reference §	Mandatory indication	Octet group
Component type tag	8.2.2.3	Mandatory	4
Component length (Note 1)	8.2.2.2		5
Invoke identifier tag	8.2.2.4	Mandatory	6
Invoke identifier length	8.2.2.2		7
Invoke identifier			8
Linked identifier tag	8.2.2.4	Optional	9
Linked identifier length	8.2.2.2		10
Linked identifier			11
Operation value tag	8.2.2.5	Mandatory	12
Operation value length	8.2.2.2		13
Operation value	(Note 3)		14
Argument (Note 2)	8.2.2.8 (Note 3)	Optional	15, etc.

Note 1 – The component length is coded to indicate the number of octets contained in the component (excluding the component type tag and the component length octets).

Note 2 – This is a parameter of the invoke component type.

Note 3 – The coding is supplementary service specific and the subject of other Recommendations.

TABLE 8-6/Q.932

Return result component

Return result component	Reference	Mandatory indication	Octet group
Component type tag	8.2.2.3	Mandatory	4
Component length (Note 1)	8.2.2.2		5
Invoke identifier tag	8.2.2.4	Mandatory	6
Invoke identifier length	8.2.2.2		7
Invoke identifier			8
Sequence tag	8.2.2.8	Optional	9
Sequence length (Note 4)	8.2.2.2	(Note 1)	10
Operation value tag	8.2.2.5	Optional	11
Operation value length	8.2.2.2	(Note 2)	12
Operation value	(Note 6)		13
Result (Note 5)	8.2.2.8 (Note 6)	Optional	14, etc.

Note 1 – If the return result component does not include any result, then the sequence and operational value shall be omitted. Table 8-19/Q.932 indicates the encoding for the sequence tag.

Note 2 – If a result is included, then the operation value is mandatory and is the first element in the sequence.

Note 3 – The component length is coded to indicate the number of octets contained in the component (excluding the component type tag and the component length octets).

Note 4 – The sequence length is coded to indicate the number of octets contained in the sequence (excluding the sequence type tag and the sequence length octets).

Note 5 – This is parameter of the return result component type.

Note 6 – The coding is supplementary service specific and the subject of other Recommendations.

TABLE 8-7/Q.932

Return error component

Return error component	Reference	Mandatory indication	Octet group
Component type tag	8.2.2.3	Mandatory	4
Component length (Note 1)	8.2.2.2		5
Invoke identifier tag	8.2.2.4	Mandatory	6
Invoke identifier length	8.2.2.2		7
Invoke identifier			8
Error value tag	8.2.2.6	Mandatory	9
Error value length	8.2.2.2		10
Error value			11
Parameter (Note 2)	8.2.2.8 (Note 3)	Optional	12, etc.

Note 1 – The component length is coded to indicate the number of octets contained in the component (excluding the component type tag and the component length octets).

Note 2 – This is parameter of the return component type.

Note 3 – The coding is supplementary service specific and the subject of other Recommendations.

TABLE 8-8/Q.932

Reject component

Reject component	Reference	Mandatory indication	Octet group
Component type tag	8.2.2.3	Mandatory	4
Component length (Note)	8.2.2.2		5
Invoke identifier tag	8.2.2.4	Mandatory	6
Invoke identifier length	8.2.2.2		7
Invoke identifier			8
Problem tag	8.2.2.7	Mandatory	9
Problem length	8.2.2.2		10
Problem	8.2.2.7		11

Note – The component length is coded to indicate the number of octets contained in the component (excluding the component type tag and the component length octets).

8.2.2.2 *Length of each component or of their data elements*

Lengths up to 127 octets are coded using the short form of Recommendation X.209: bit 8 is set to zero and the remaining seven bits are a binary encoding of the length, with bit 1 the least significant bit. (This length encoding is identical to that of Recommendation Q.931 for lengths up to 127 octets.) This is illustrated in Figure 8-3/Q.932.

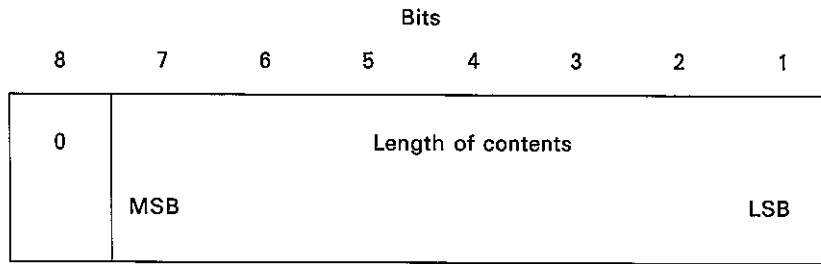
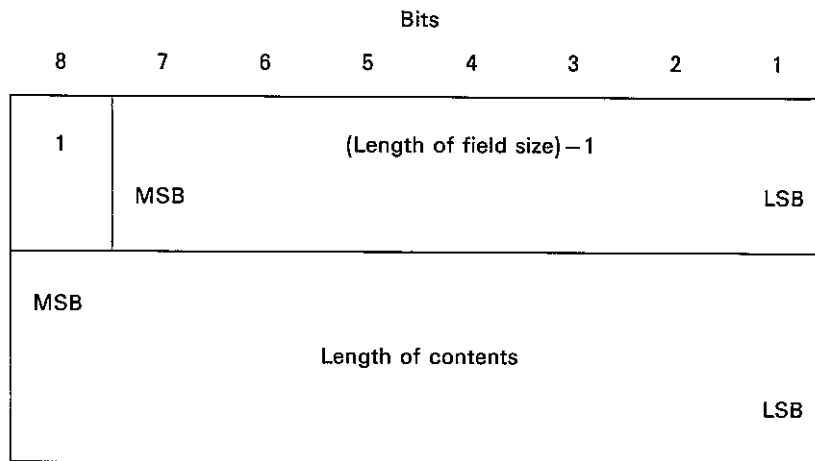

FIGURE 8-3/Q.932

Format of the length field (long form)

If the length of the contents is greater than 127 octets, then the long form of the length of the contents is used. The long form length is from 2 to 127 octets long. Bit 8 of the first octet is coded 1, and bits 1 to 7 of the first octet encode a number one less than the size of the length in octets as an unsigned binary number whose MSB and LSB are bits 7 and 1, respectively. The length itself is encoded as an unsigned binary number whose MSB and LSB are bit 8 of the second octet and bit 1 of the last octet, respectively. This binary number should be encoded in the fewest possible octets, with no leading octets having the value 0. This is illustrated in Figure 8-4/Q.932.



Note – The application of the indefinite form of the length is not precluded depending on future applications (see § III.3 of Appendix III).

FIGURE 8-4/Q.932

Format of the length field (long form)

8.2.2.3 *Component type tag*

The coding of the component type tag is shown in Table 8-9/Q.932.

TABLE 8-9/Q.932
Component type tag

Component type tag	Bits							
	8	7	6	5	4	3	2	1
Invoke	1	0	1	0	0	0	0	1
Return result	1	0	1	0	0	0	1	0
Return error	1	0	1	0	0	0	1	1
Reject	1	0	1	0	0	1	0	0

8.2.2.4 *Component identifier tags*

An invoke identifier is used to identify an operation invocation and is reflected in the return result or return error that responds to it. An invoke may refer to another invoke through the linked identifier. When a protocol error occurs, the invoke identifier is reflected in the reject component, but if it is not available, a null is returned. Invoke and linked identifiers are one octet long. The null has zero length. The coding of the component identifier tags is shown in Table 8-10/Q.932.

TABLE 8-10/Q.932
Coding of component identifier tag

	Bits							
	8	7	6	5	4	3	2	1
Invoke identifier	0	0	0	0	0	0	1	0
Linked identifier	1	0	0	0	0	0	0	0
Null	0	0	0	0	0	1	0	1

8.2.2.5 *Operation value tag*

The operation value specifies the facility or supplementary service application and operation being requested. Values are encoded as integers. The value of the operation value is supplementary service specific and will be specified in future Recommendations which contain the protocol for individual supplementary services. The coding for the operation value tag is shown in Table 8-11/Q.932.

TABLE 8-11/Q.932
Coding of operation value tag

	Bits							
	8	7	6	5	4	3	2	1
Operation value tag	0	0	0	0	0	0	1	0

8.2.2.6 *Error value tag*

Operations report errors as specified for each individual operation. Values are encoded as integers. The coding for the error value tag is shown in Table 8-12/Q.932.

TABLE 8-12/Q.932
Coding of error value tag

	8	7	6	5	Bits 4	3	2	1
Error value tag	0	0	0	0	0	0	1	0

8.2.2.7 *Problem tag*

Protocol problems are indicated in groups. Table 8-13/Q.932 indicates the tags for these groups. The contents for each of these tags is indicated in Tables 8-14/Q.932 to 8-17/Q.932. The contents of these tags are defined in Table 8-18/Q.932.

TABLE 8-13/Q.932
Coding of problem tags

Problem	8	7	6	5	Bits 4	3	2	1
General problem	1	0	0	0	0	0	0	0
Invoke problem	1	0	0	0	0	0	0	1
Return result problem	1	0	0	0	0	0	1	0
Return error problem	1	0	0	0	0	0	1	1

TABLE 8-14/Q.932
Coding of general problem

	8	7	6	5	Bits 4	3	2	1
Unrecognized component	0	0	0	0	0	0	0	0
Mistyped component	0	0	0	0	0	0	0	1
Badly structured component	0	0	0	0	0	0	1	0

Note – ROSE uses the term application protocol data unit (APDU) in place of component.

TABLE 8-15/Q.932
Coding of invoke problem

	8	7	6	5	Bits 4	3	2	1
Duplicate invocation	0	0	0	0	0	0	0	0
Unrecognized operation	0	0	0	0	0	0	0	1
Mistyped argument	0	0	0	0	0	0	1	0
Resource limitation	0	0	0	0	0	0	1	1
Initiator releasing	0	0	0	0	0	1	0	0
Unrecognized linked identifier	0	0	0	0	0	1	0	1
Linked response unexpected	0	0	0	0	0	1	1	0
Unexpected child operation	0	0	0	0	0	1	1	1

TABLE 8-16/Q.932

Coding of return result problem

	Bits							
	8	7	6	5	4	3	2	1
Unrecognized invocation	0	0	0	0	0	0	0	0
Result response unexpected	0	0	0	0	0	0	0	1
Mistyped result	0	0	0	0	0	0	1	0

TABLE 8-17/Q.932

Coding of return error problem

	Bits							
	8	7	6	5	4	3	2	1
Unrecognized invocation	0	0	0	0	0	0	0	0
Error response unexpected	0	0	0	0	0	0	0	1
Unrecognized error	0	0	0	0	0	0	1	0
Unexpected error	0	0	0	0	0	0	1	1
Mistyped parameter	0	0	0	0	0	1	0	0

TABLE 8-18/Q.932

Problem code definitions

<i>General-problem:</i>	
– unrecognized-component:	signifies that the type of the component, as evidenced by its type identifier, is not one of the four defined by Recommendation X.229 [10]
– mistyped-component:	signifies that the structure of the component does not conform to Recommendation X.229
– badly-structured-component:	signifies that the structure of the component does not conform to the standard notation and encoding, defined in Recommendations X.208 [7] and X.209 [8]
<i>Invoke problem:</i>	
– duplicate-invocation:	signifies that the invoke-identifier parameter violates the assignment rules of Recommendation X.219 [9]
– unrecognized-operation:	signifies that the operation is not one of those agreed between the user and the network
– mistyped-argument:	signifies that the type of the operation argument supplied is not that agreed between the user and the network
– resource-limitation:	the performing user or network is not able to perform the invoked operation due to resource limitation
– initiator-releasing:	the association-initiator is not willing to perform the invoked operation because it is about to attempt to release the application-association
– unrecognized-linked-identifier:	signifies that there is no operation in progress with an invoke-identifier equal to the specified linked-identifier
– linked-response-unexpected:	signifies that the invoked operation referred to by linked-identifier is not a parent-operation
– unexpected-child-operation:	signifies that the invoked child-operation is not one that the invoked parent-operation referred to by the linked-identifier allows
<i>Return-result-problem</i>	
– unrecognized-invocation:	signifies that no operation with the specified Invoke-identifier is in progress
– result-response-unexpected:	signifies that the invoke operation does not report a result
– mistyped-result:	signifies that the type of the result parameter supplied is not that agreed between the user and the network
<i>Return-error-problem:</i>	
– unrecognized-invocation:	signifies that no operation with the specified invoke-identifier is in progress
– error-response-unexpected:	signifies that the invoked operation does not report failure
– unrecognized-error:	signifies that the reported error is not one of those agreed between the user and the network
– unexpected-error:	signifies that the reported error is not one that the invoked operation may report
– mistyped-parameter:	signifies that the type of the error parameters supplied is not that agreed between the user and the network

Note – The former definitions are adapted from §§ 7.4.4.2 and 7.5.4.2 of Recommendation X.229 (Remote operations: protocol specification).

8.2.2.8 *Parameters*

The parameters included with a component (i.e., the argument with an invoke, the result with a return result or the parameter with a return error) are indicated in the specification of the operation. They may include optional and default parameters. Parameters shall be one of the following:

- a sequence of parameters
- a set of parameters
- a specific parameter with its own tag
- nothing at all (i.e., absent).

When more than one parameter is required, they shall follow a sequence or set tag as specified in the specification of the operation. (The usage of the sequence and set tags is defined in Recommendations X.208/X.209.)

Sequences and sets of parameters may contain further sequences and sets as specified for the operation to be performed. Table 8-19/Q.932 indicates the coding of the sequence and set tags.

TABLE 8-19/Q.932
Coding of sequence and set tags

	Bits							
	8	7	6	5	4	3	2	1
Sequence tag	0	0	1	1	0	0	0	0
Set tag	0	0	1	1	0	0	0	1

8.2.2.9 *Treatment of existing Recommendation Q.931 information elements as parameters*

Supplementary service protocol specifications are expected to require new parameters to be defined and to require existing Recommendation Q.931 information elements (Note 1).

New parameters shall be defined using Recommendation X.209 coding if they do not appear elsewhere in Q.931 messages.

Supplementary service protocol specifiers may elect to encapsulate one or more existing Recommendation Q.931 information elements within a Recommendation X.209 data element, thereby retaining the Recommendation Q.931 coding for these information elements. When this option is chosen, all the Recommendation Q.931 information elements should be grouped together as the content following the Recommendation Q.931 information elements tag. This is illustrated in Figure 8-5/Q.932. The tag is defined in Table 8-20/Q.932. This data element may appear by itself or as a member of a sequence or set as indicated in § 8.2.2.8.

Note 1 – Encapsulation of the Facility information element within Facility information elements shall not be used.

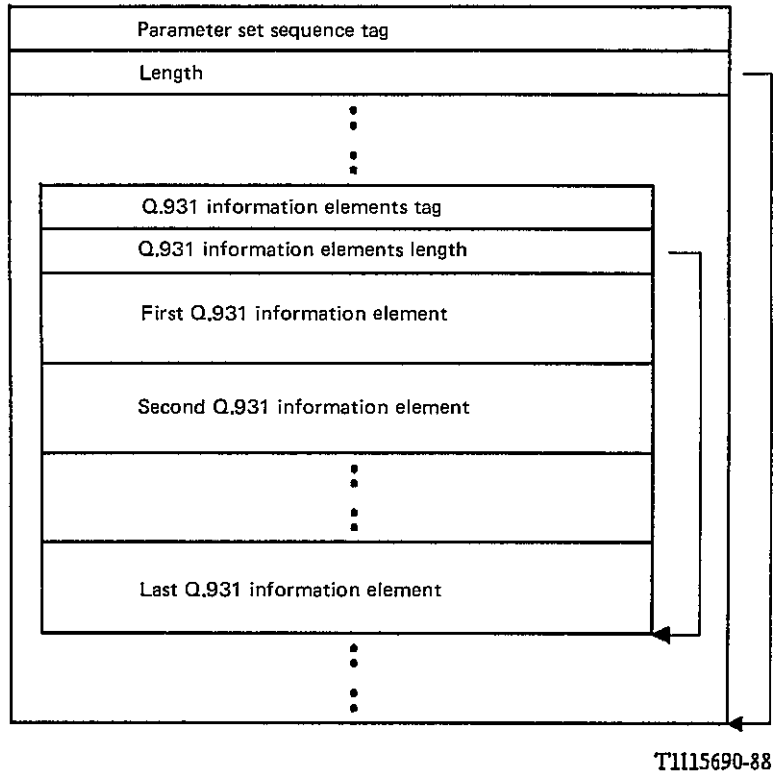

FIGURE 8-5/Q.932
Encapsulation of Q.931 information elements

TABLE 8-20/Q.932
Q.931 information elements tag

	Bits							
	8	7	6	5	4	3	2	1
Q.931 information elements	0	1	0	0	0	0	0	0

Note – All other values are reserved but this approach may also be applied in the future to coding structures from other Recommendations by defining other tags as required.

8.2.3 *Feature activation*

The purpose of the Feature activation information element is to invoke a supplementary service as identified by the feature identifier number. The service associated with the feature identifier number is dependent on that particular user's service profile.

The maximum length of this information element is 4 octets.

The Feature activation information element is coded as shown in Figure 8-6/Q.932 and Table 8-21/Q.932.

		Bits								
		8	7	6	5	4	3	2	1	Octets
0	Feature activation							1		
	0	1	1	1	0	0	0			
		Information element identifier								
		Length of feature activation contents							2	
0/1 Ext.	Feature identifier number							3		
1 Ext.	Feature identifier number (continuation)							3a		

FIGURE 8-6/Q.932

Feature activation information element

TABLE 8-21/Q.932

Feature activation information element

Feature identifier number (octets 3 and 3a)

The feature identifier number is a unique number assigned to a feature in a customer account that is coded as part of both the Feature activation and Feature indication information elements. This number identifies the feature that is being requested or updated. The association of a particular number to a particular feature may be different for each user.

Bit 8 in octet 3 is used to extend the feature identifier field. If bit 8 is 0, then another octet follows; if bit 8 is 1, then octet 3 is the last octet. The identifier numbers for a one octet field range from 1 to 127. For a multi-octet field, the order of bit values progressively decreases as the octet number increases.

8.2.4 *Feature indication*

The purpose of the Feature indication information element is to allow the network to convey feature indications to the user regarding the status of a supplementary service.

The maximum length of this information element is 5 octets.

The coding of the Feature indication information element is shown in Figure 8-7/Q.932 and Table 8-22/Q.932.

Bits								Octets
8	7	6	5	4	3	2	1	
Feature indication								1
0	0	1	1	1	0	0	1	
Information element identifier								
Length of feature indication contents								2
0/1 Ext.	Feature identifier number							3
1 Ext.	Feature identifier number (continuation)							3a
0	0	0	0	Status indicator				4
Spare								

FIGURE 8-7/Q.932

Feature indication information element

TABLE 8-22/Q.932

Feature indication information element

<i>Feature identifier number (octets 3 and 3a)</i>						
These fields are coded as described in Table 8-21/Q.932.						
<i>Status indicator (octet 4)</i>						
The status indicator field identifies the current status of a supplementary service.						
Bits						
4	3	2	1	<i>Status</i>	<i>Meaning</i>	<i>Examples of possible user equipment implementation</i>
0	0	0	0	Deactivated	Feature is in the deactivated state	Lamp off
0	0	0	1	Activated	Feature is in the active state	Lamp steady on
0	0	1	0	Prompt	Feature prompt (waiting for user input)	Lamp steady flash
0	0	1	1	Pending	Feature is pending	Lamp steady wink
All other values are reserved.						

8.2.5 *Information request*

The purpose of the Information request information element is to provide the capability for requesting additional information and signalling completion of the information request (see Annex B).

The Information request information element is coded as shown in Figure 8-8/Q.932 and Table 8-23/Q.932.

The default maximum length of the Information request information element is three octets.

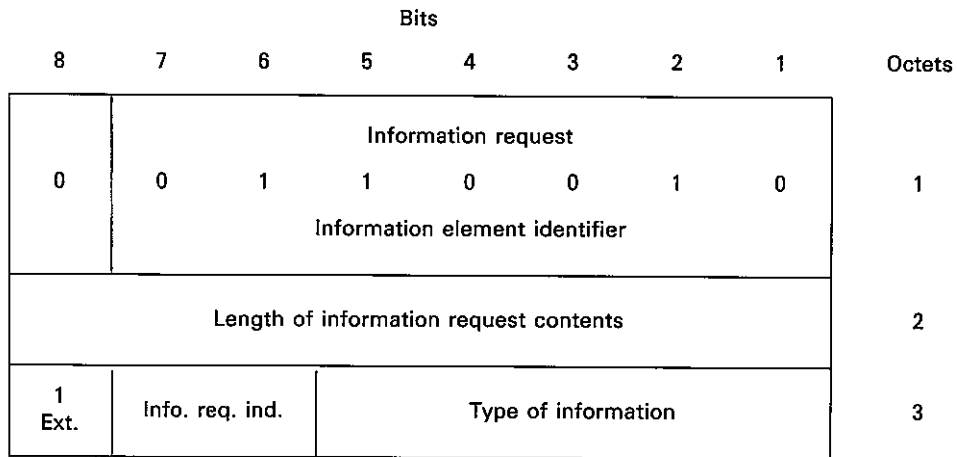

FIGURE 8-8/Q.932

Information request information element

TABLE 8-23/Q.932

Information request information element

<i>Information request indicator (octet 3, bit 7)</i>						
Bit						
7						
0	Information request completed					
1	Prompt for additional information					
<i>Type of information (octet 3, bits 1-6)</i>						
Bits						
6	5	4	3	2	1	
0	0	0	0	0	0	undefined
0	0	0	0	0	1	authorization code
0	0	0	0	1	0	address digits
0	0	0	0	1	1	terminal identification
All other values are reserved.						

8.2.6 *Service profile identification*

The purpose of the Service profile identification information element is to allow the user to initiate automatic assignment of the user service identifier and terminal identifier (see Annex A).

The Service profile identification information element is defined in Figure 8-9/Q.932 and Table 8-24/Q.932.

The default maximum length of the Service profile identification information element is 32 octets.

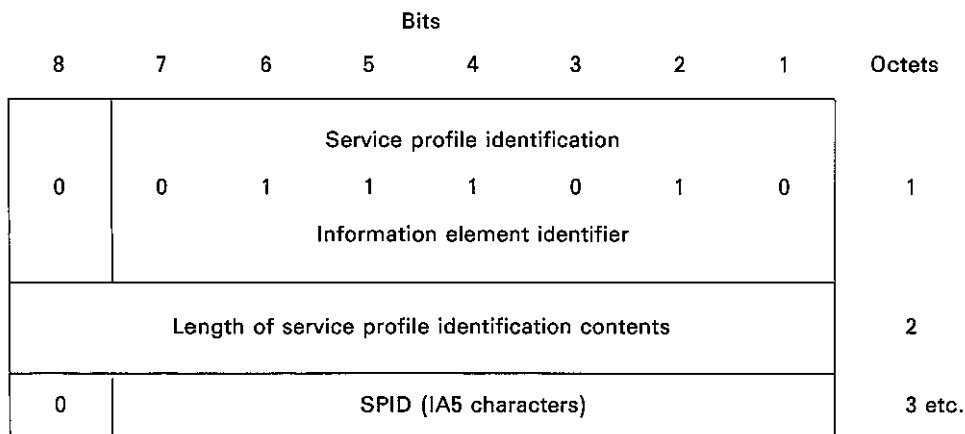

FIGURE 8-9/Q.932

Service profile identification information element

TABLE 8-24/Q.932

Service profile identification information element

<p><i>SPID (octet 3, etc.)</i></p> <p>The service profile identifier parameter is coded in IA5 characters, according to the format specified by the network.</p>
--

ANNEX A

(to Recommendation Q.932)

User service profiles and terminal identification

A.1 Introduction

These optional procedures allow an ISDN to support identification and selection of specific terminals on a multi-point user-network interface to support multiple user service profiles in those cases in which Recommendation Q.931 information elements are not sufficient for such purposes.

A terminal or network which desires to support such multiple profiles for terminals which could not otherwise be distinguished, must support this additional identification procedure. Otherwise, it is completely optional.

TABLE A-1/Q.932

Terminology

Service profile	Service profile refers to the information that the network maintains for a given user to characterize the service offered by the network to that user. As an example, this may contain the association of feature identifiers to specific supplementary services. A service profile may be allocated to an access interface or to a particular user equipment or a group of user equipments.
SPID	The service profile identifier is a parameter carried in a service profile identification information element that is sent from the user to network to allow network assignment of a USID and TID. A user's SPID should uniquely identify a specific profile of service characteristics stored within the network. The SPID will allow the network to distinguish between different terminals that would otherwise be indistinguishable (e.g., same ISDN number). The SPID value is provided to the user at subscription time.
USID	User service identifier. A USID uniquely identifies a service profile on an access interface.
TID	Terminal identifier. A TID value is unique within a given USID. If two terminals on an interface subscribe to the same service profile, then the two terminals will be assigned the same service USID. However, two different TIDs are required to uniquely identify each of the two terminals.
EID	Endpoint identifier. The endpoint identifier information element is used for terminal identification. The endpoint identifier parameters contain a USID and TID and additional information used to interpret them.

Figure A-1/Q.932 shows examples of the relationships of terminals, SPIDs, USIDs, and TIDs and their dynamic relationship to TEIs. In this example, terminals 1, 3, 4 and 5 support the automatic endpoint identifier parameter assignment procedure and terminal 2 does not, but has the endpoint identifier parameters locally entered. Terminal 6 does not support terminal identification, therefore it utilizes the specified default service profile.

Note – Items in parentheses indicate values or relationships which are dynamically established by initialization procedures (see § A.4). Others are established via administrative actions and stored as a result of manual entry.

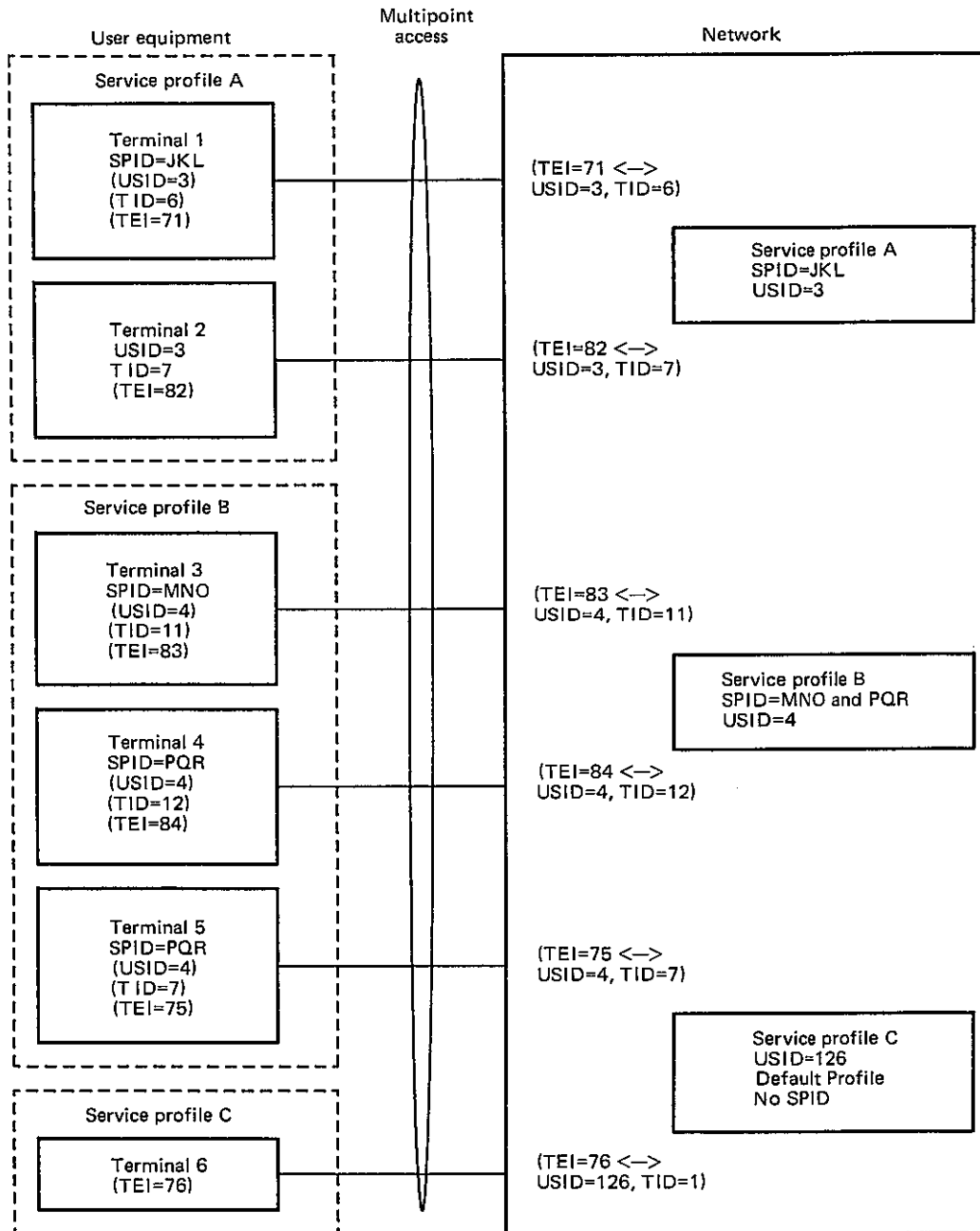

T1110600-88

FIGURE A-1/Q.932

Relationship of service profile, SPID, USID, TID and TEI

A user or network that does not recognize the information elements used by this Annex shall, if these elements are received, apply the error procedures defined in § 5.8 of Recommendation Q.931.

A.2 User service profiles

The support of user service profiles requires that the service requests from a terminal are associated by the network with a specific profile. A USID is used to identify the profile on an access. The service profile is assigned to a data link connection so that the network can associate all of the service requests from the corresponding Connection Endpoint Suffix (CES) with the required profile (see Note). The assignment of a service profile to a data link connection minimizes the per-service request overhead of profile identification.

The procedures for assigning service profile to a data link connection are incorporated into the initialization procedures described in § A.4.

Note – CES along with SAPI constitute the CEI (Connection Endpoint Identifier) that is used to identify message units passed between the data link layer (as represented by the TEI) and Layer 3.

A.3 *Terminal identification*

The support of terminal identification requires that a call sent by the network can be addressed to:

- all of the terminals of a user service profile;
- one terminal of a user service profile; or
- all but one terminal of a user service profile.

A USID is used to identify the user service profile with a (set of) terminals on an access interface and a TID is used to identify individual terminals within a user service profile on an access.

The USID and TID may be entered into the terminal by the user as arranged at subscription time, or dynamically downloaded to the terminal from the network with an automatic assignment procedure.

The USID and TID parameters are used by the terminal to check the compatibility of a call offered by the network. The inclusion of a USID and TID with only access uniqueness minimizes the per-call overhead of supporting terminal addressing.

The procedures for downloading the USID and TID to a terminal are incorporated into the automatic endpoint identifier allocation and initialization procedures described in § A.4. The procedures for using a USID and TID for terminal identification in an offered call sent by the network are described in § A.5.

A.4 *Initialization*

The initialization procedure provides for the association by the network of the service requests from a terminal on a particular data link connection (as represented by the TEI) with a user service profile. A user requested automatic assignment procedure is described to also support automatic assignment of USID and TID parameters and their downloading by the network to a terminal.

Since initialization provides the basis for subsequent association of a service profile with a data link connection, normally, user equipment that supports initialization is expected to request the initialization procedure (e.g., on the first Layer 3 message after dynamic assignment of a TEI). However, a request for initialization is allowed at any time. The data link connection is always associated with the most recently identified service profile. Under some circumstances, the network may solicit terminal initialization.

A.4.1 *Terminal requested initialization*

- a) Terminals may initialize by sending an Endpoint identifier information element (containing a USID and TID) in an INFORMATION message at any time to the network. Subsequent to this, the network may associate the service profile with the data link over which the message was sent.
- b) For terminals which support automatic assignment of USID and TID parameters, initialization (that is, association of a service profile with a data link connection) is provided as part of the automatic assignment procedure described here.

A user may initiate automatic assignment of the endpoint identifier by sending a Service profile identification information element in an INFORMATION message with the dummy call reference. The Service profile identification information element should contain the SPID parameter allocated at the time of subscription. The initialization is acknowledged with an INFORMATION message with the Endpoint identifier information element containing a USID and TID, the values of which are determined by the network. It results in an association of the data link over which it was received with the identified service profile.

When a terminal determines that the initialization procedure has failed, it assumes that the network cannot support the procedure and does not repeatedly attempt initialization.

A.4.2 *Network solicited initialization*

The network may solicit a request for initialization on a data link connection by sending an Information request information element with codepoint “terminal identification” in an INFORMATION message with the dummy call reference. Upon receiving the request, the terminal may respond as described in the previous § A.4.1 a) or b).

When a network determines that the initialization procedure has failed, it assumes that the terminal cannot support the procedures and does not repeatedly request initialization.

A.4.3 *Collision*

When terminal initialization and network solicitation procedures collide, the terminal ignores the solicitation from the network and the network proceeds as normal upon receipt of the initialization request from the terminal.

A.5 *Identification procedures*

When the network offers a call using terminal addressing, the Endpoint identifier information element is included in the SETUP message.

When a terminal receives a SETUP message containing the Endpoint identifier information element, it shall:

- if it is not supported, handle the Endpoint identifier information element in accordance with § 5.8.7 of Recommendation Q.931 and complete normal compatibility checking procedures; or,
- test for an address compatibility with the Endpoint identifier information element if it is supported in addition to completing the normal compatibility checking procedures.

ANNEX B

(to Recommendation Q.932)

Information request procedures

B.1 *Introduction*

This Annex specifies optional procedures to allow a network to request additional information from a user. These procedures do not impact the Recommendation Q.931 call state. This capability shall only be allowed during the Null, Overlap Sending, Outgoing Call Proceeding, Call Delivered, and Activate call states.

The capability is intended for use with the Keypad and Feature key management protocols.

A user or network that does not recognize the information elements used by this Annex shall, if these information elements are received, apply the error recovery procedures defined in § 5.8 of Recommendation Q.931.

B.2 *Procedures*

B.2.1 *Normal procedures*

The network will send an INFORMATION message to the user to request additional information. The INFORMATION message will contain the Information request information element (see § 8), with the information request indicator set to “prompt for additional information” and type of information set to the appropriate value. After sending the INFORMATION message, the network will start timer T302. The network will restart timer T302 on the receipt of every INFORMATION message if the requested information is not complete.

No Recommendation Q.931 call state changes should occur when the INFORMATION message is sent or received.

The user may always send the requested information in keypad facility information elements contained in one or more INFORMATION messages. In addition, if the information requested was a called party number, then the user may also send the requested information in the called party number information element in one or more INFORMATION messages.

In both the call associated and non-call associated cases, when the network has determined that sufficient information has been received to proceed, it may send an INFORMATION message to the user, containing an Information request information element, with the information request indicator set to “information request completed” to signal the required information has been received correctly. If the additional information was requested during Overlap Sending state, and no additional information is required before the network can proceed with processing of the call, a CALL PROCEEDING message may suffice to signal the end of information sending.

In the call associated case, the network may also indicate that sufficient information has been received by initiating call clearing according to § 5.3 of Recommendation Q.931.

B.2.2 *Abnormal procedures*

If no response is received from the user, or if the information received is incomplete upon expiry of timer T302, or if the information provided by the user is invalid, then:

- in the call associated case, the network shall initiate call clearing according to § 5.3 of Recommendation Q.931;
- in the non-call associated case, the network shall return an INFORMATION message containing a Cause information element with an appropriate cause value.

In the non-call associated case, if the user responds with a RELEASE COMPLETE message to an INFORMATION message containing an Information request information element, then the procedure shall be considered as terminated.

APPENDIX I

(to Recommendation Q.932)

Illustration of the application of the three protocol types

I.1 *Introduction*

This Appendix is provided as an illustration of the application of the three protocol types defined in this Recommendation. The examples shown should not be taken as definitive examples, since the support of the Keypad and the Feature key management protocols are network dependent.

The signalling sequences shown are not exhaustive and are only intended to illustrate possible supplementary service control sequences.

I.2 *Example use of the Keypad protocol*

This example shows the application of the Keypad protocol using the Keypad facility and Display information elements to establish a second call while holding the first one. It should be noted that the Keypad protocol does not necessarily allow a supplementary service to be supported to the same degree of functionality as the approach based on the Functional protocol. In addition, this protocol does not impose a need for the terminal to be aware of any states other than those required for basic call control. An objective of the Keypad protocol is to provide for the support of supplementary services in circumstances where a reduced level of functionality can be tolerated.

The example in Figure I-1/Q.932 illustrates a user feature request using the Keypad protocol. The network associates the contents of the Keypad information element with the appropriate feature. The user is shown to subsequently enter supplementary service parameters using the Keypad protocol. Feature status information may be provided by the network in the Display information element. The network completes feature processing and the user is shown to clear call reference. Alternatively, depending on the specific feature request, a CALL PROCEEDING message might be returned by the network and normal call processing procedures would continue.

The specific example shown in Figure I-2/Q.932 illustrates the support of a hold/retrieve function based on the use of INFORMATION messages for the conveyance of Keypad facility or Display information elements. An enquiry call is established through the conveyance of the called party address digits via a Keypad facility information element within INFORMATION messages. These address digits are sent after putting the existing call on hold through the transfer of a facility request via a Keypad facility information element within an INFORMATION message.

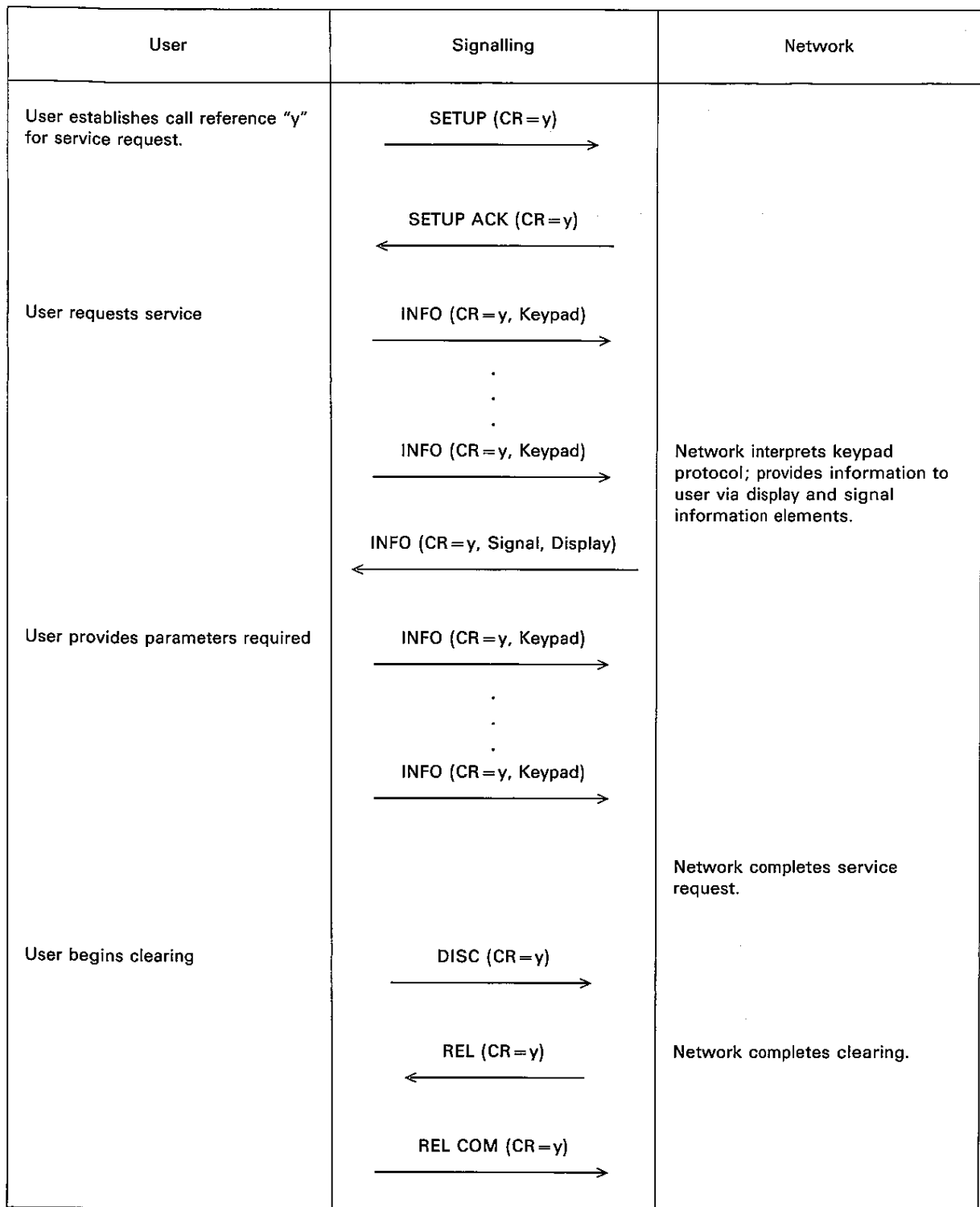
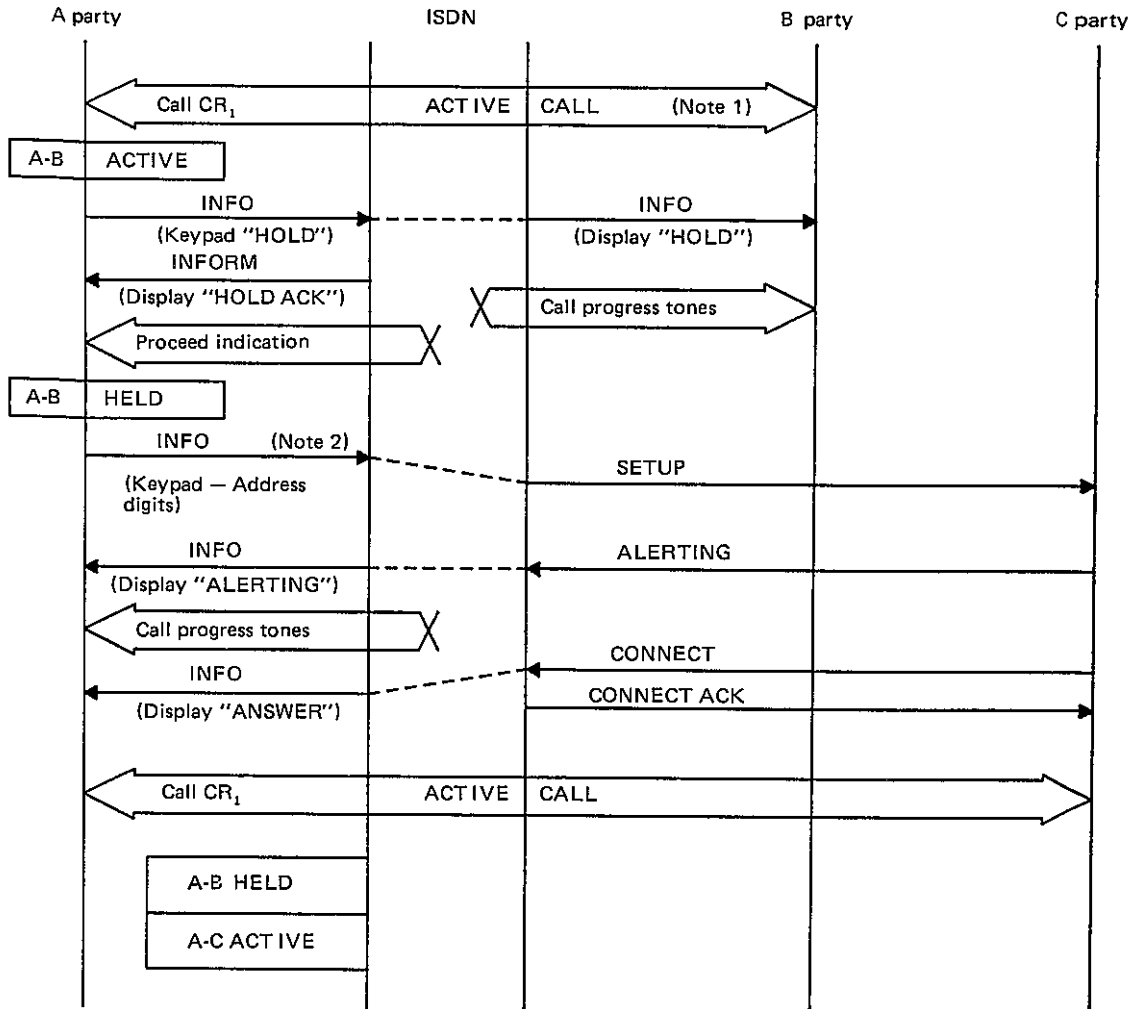

FIGURE I-1/Q.932

A generic example of the use of the keypad protocol



T1110610-88

Note 1 – The first call is established using the normal call establishment procedures specified in Recommendation Q.931

Note 2 – The same call reference as that of the active call is used to establish the enquiry call. The characteristics of the second call are assumed to be identical to the first call (e.g. same bearer capability, high layer compatibility, low layer compatibility, transit network selection, information elements, etc.).

FIGURE I-2/Q.932

Specific example of establishing a second call while holding the first one using the Keypad protocol

I.3 *Example of use of the Feature key management protocol*

This example illustrates the use of the Feature key management protocol for the invocation of a supplementary service by a user having initiated a call establishment by sending a SETUP message with incomplete (or no) address information, after having entered the overlap sending state upon receipt of the SETUP ACKNOWLEDGE message. Figure I-3/Q.932 depicts the user providing supplementary service parameters. This is accomplished via the Keypad facility information element within INFORMATION messages after having invoked the request of a supplementary service by sending a Feature activation information element contained in an INFORMATION message to the network. The association of the feature identifier number (provided within the Feature activation information element) with a given supplementary service has to be arranged between the user and the network at subscription time.

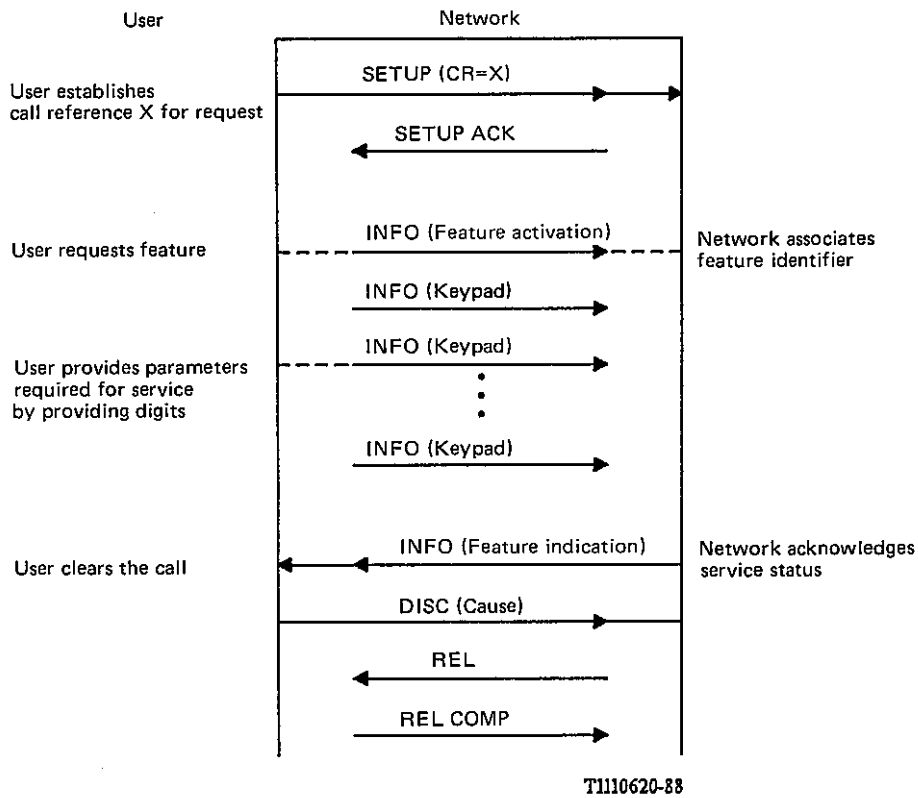

FIGURE I-3/Q.932
A generic example of the use of the Feature key management protocol

I.4 *Examples of use of the Functional protocol*

I.4.1 *Call related supplementary service procedures*

I.4.1.1 *Invocation with call establishment*

The example message sequence shows the initiation of a call establishment simultaneously with a supplementary service invocation.

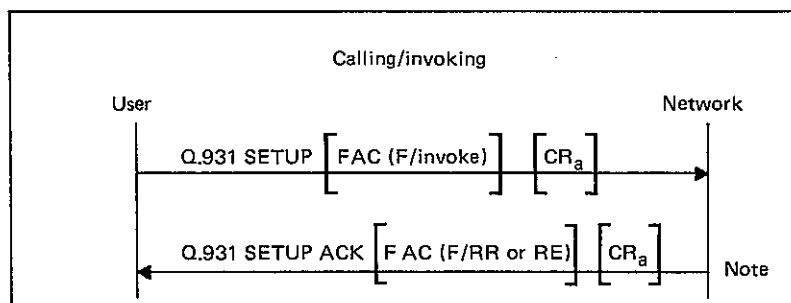

Note – Depending on the invoked supplementary service, and the basic call control procedure one of the Recommendation Q.931 messages in the network-to-user direction may be used to carry return result, return error or reject indication or even an invoke for further information.

FIGURE I-4/Q.932
Invocation with call establishment

I.4.1.2 *Invocation with call clearing*

The example message sequence shows the initiation of normal call clearing simultaneously with a supplementary service invocation.

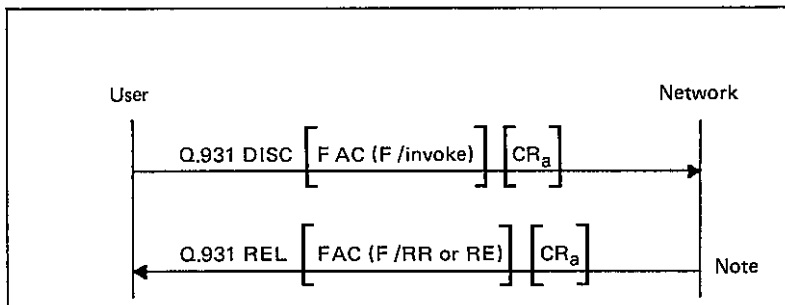

T1110640-88

Note – Assume the signalling association CR_a can be cleared together with the connection for the invoked supplementary service, otherwise a FACILITY message may be used instead.

FIGURE I-5/Q.932

Invocation with call clearing

I.4.1.3 *Invocation during the active phase of a call*

The example message sequence shows the initiation of a supplementary service via the established signalling association CR_a at any time during the active phase of a call.

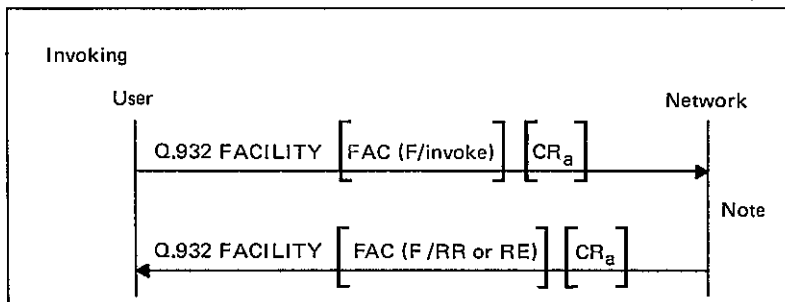

T1110650-88

Note – This sequence may occur several times during the active phase of a call, utilizing the existing signalling associations.

FIGURE I-6/Q.932

Invocation during the active phase of a call

I.4.2 Call independent supplementary service procedures

I.4.2.1 Establishment of a user-to-network transaction for supplementary service control

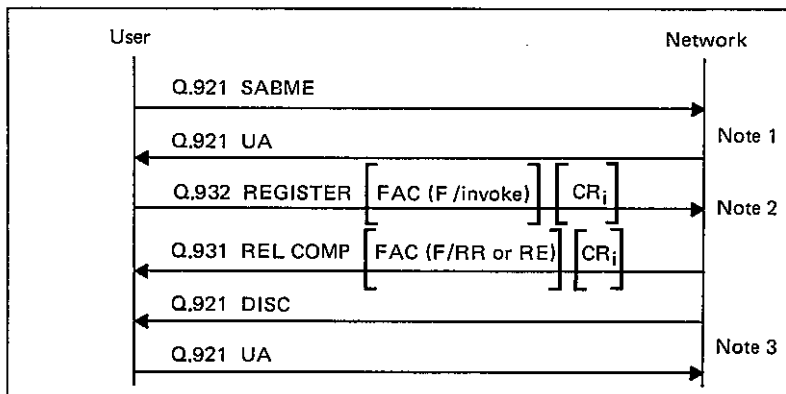

T1110660-88

Note 1 – Establishment of layer 2 connection if not yet established

Note 2 – If the procedure is used in the network-to-user direction, additional address information may be required. This requires further study.

Note 3 – Depending on the invoked supplementary service, the layer 2 connection may be kept or cleared.

FIGURE I-7/Q.932

Establishment of a user-to-network transaction for supplementary service control

I.4.2.2 Clearing of a user-to-network transaction for supplementary service control

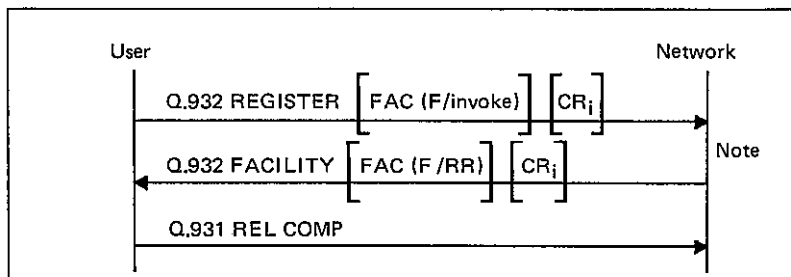

Note – After receiving the last return result the receiving side may initiate clearing of the layer 2 connection.

FIGURE I-8/Q.932

Clearing of a user-to-network transaction for supplementary service control

TABLE I-1/Q.932

Key to the Figures I-1/Q.932 to I-8/Q.932

<i>Layer 2 frames</i>	
SAMBE	Set asynchronous balance mode extended
UA	Unnumbered acknowledgement frame
DISC	Disconnect frame
<i>Layer 3 messages:</i>	
INFO	Information
SETUP ACK	Setup acknowledge
DISC	Disconnect
REL	Release
REL COMP	Release complete
<i>Layer 3 message information elements/parameters:</i>	
FAC	Facility information element
F	Facility identifier
Invoke	Invoke operation type
RR	Return result operation type
RE	Return error operation type
CR _a	Call reference of an active call
CR _l	Call reference assigned call independently

APPENDIX II

(to Recommendation Q.932)

**Functional reference model for the operation
of supplementary services**

This Appendix provides a functional model intended to show how the supplementary services can be operated by combining stimulus or Functional protocol types to interact with a unique supplementary service protocol controller which interfaces with the relevant supplementary functional components which provides and coordinates the required functions associated to each supplementary service (e.g., control of resources).

The intermediate feature function performs the necessary conversions between stimulus protocols and the supplementary service functional primitives which are the only ones treated and known from the supplementary service protocol controller. As an example, the intermediate feature function translates an access code received within the Keypad facility information element or a feature identifier number within a Feature activation information element to a supplementary service priority such as hold or retrieve request.

Functional reference model

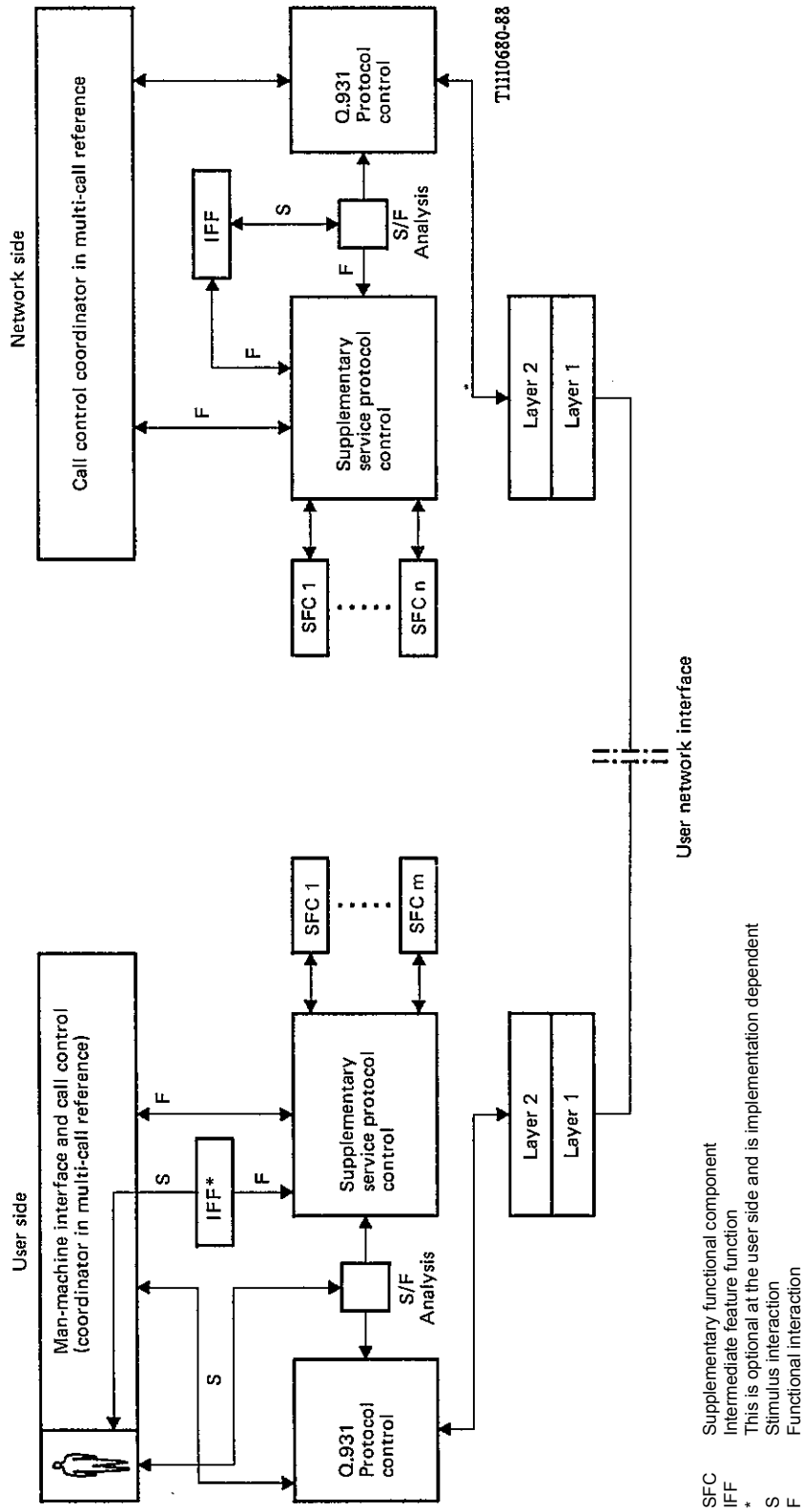

FIGURE II-1/Q.932
Protocol architecture model

APPENDIX III

(to Recommendation Q.932)

General description of component encoding rules

III.1 *General component structure*

Each data element within a component has the same structure. A data element consists of three fields, which always appear in the following order. The tag distinguishes one type from another and governs the interpretation of the contents. The length specifies the length of the contents. The contents is the substance of the data element, containing the primary information the data element is intended to convey. Figure III-1/Q.932 shows an overview of a component and a data element.

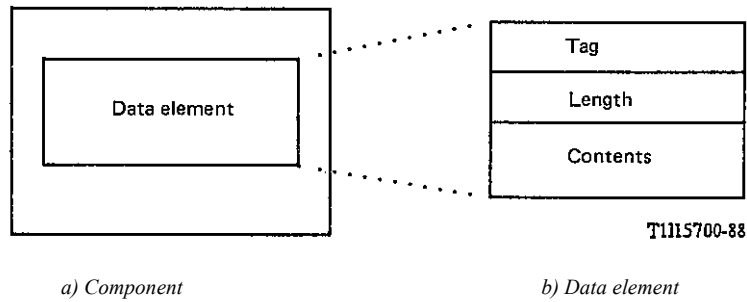

FIGURE III-1/Q.932

Structure of Component and data element

Each field is coded using one or more octets. Octets are labelled as shown in Figure III-2/Q.932. The first octet is the first transmitted. Bits in an octet are labelled as shown in Figure III-3/Q.932, with bit 1 the least significant and the first transmitted.

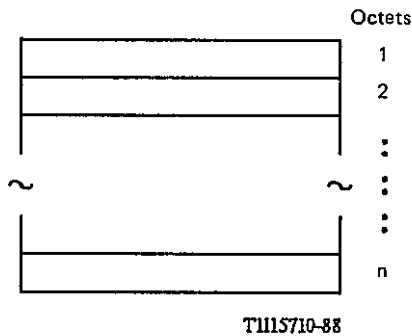

FIGURE III-2/Q.932

Octet labelling scheme

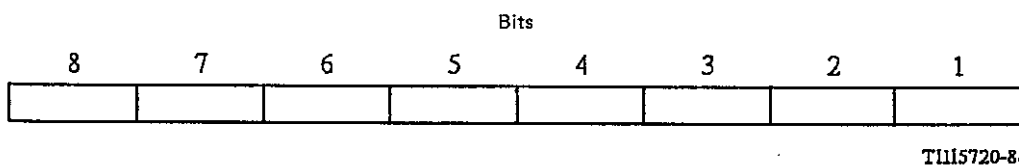

FIGURE III-3/Q.932

Bit labelling scheme

The contents of each data element is either one value (primitive) or one or more data elements (constructor), as shown in Figure III-4/Q.932.

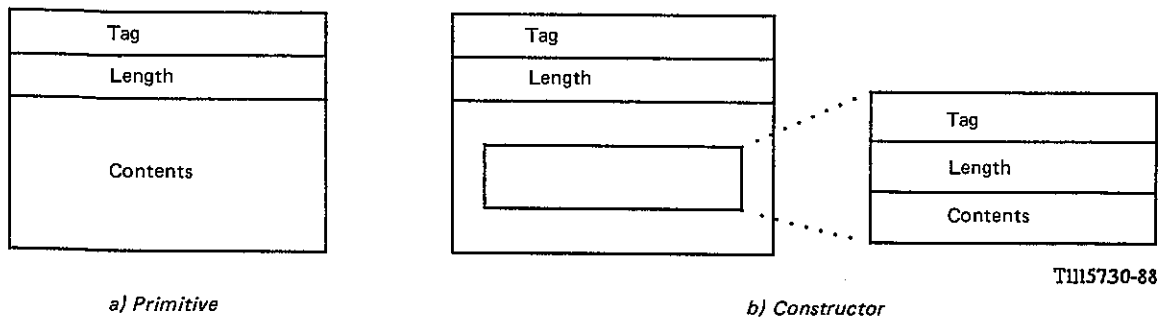
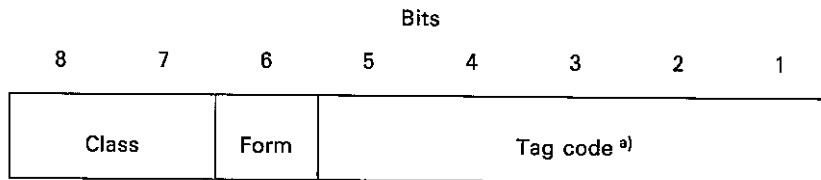

FIGURE III-4/Q.932

Types of contents

III.2 *Tag*

A data element is first interpreted according to its position within the syntax of the message. The tag distinguishes one data element from another and governs the interpretation of the contents. It is one or more octets in length. The tag is composed of “class”, “form” and “tag code”, as shown in Figure III-5/Q.932.



a) The tag code may be extended to the following octet(s) as discussed in section III.2.3.

FIGURE III-5/Q.932

Format of tag

III.2.1 *Tag class*

All tags use the two most significant bits (8 and 7) to indicate the tag class. These bits are coded as shown in Table III-1/Q.932.

TABLE III-1/Q.932

Coding of tag class

Class	Coding (87)
Universal	00
Application-wide	01
Context-specific	10
Private use	11

The universal class is used for tags that are exclusively standardized in Recommendation X.209 and are application independent types. Universal tags may be used anywhere a universal data element type is used. The universal class applies across all CCITT Recommendations, i.e., across Recommendation Q.932 facility information elements, CCITT Signalling System No. 7 ASEs, X.400 MHS, X.500 Directory Services, etc.

The application-wide class is used for data elements that are standardized across all applications (ASEs) using CCITT Recommendation Q.932 facility procedures for supplementary services.

The context-specific class is used for data elements that are specified within the context of the next higher construction and take into account the sequence of other data elements within the same construction. This class may be used for tags in a construction, and the tags may be re-used in any other construction.

The private use class is reserved for data elements specific to a nation, a network or a private user. Such data elements are beyond the scope of Recommendation Q.932.

The Tag codes of the application-wide class not assigned in Recommendation Q.932 are reserved for future use.

III.2.2 *Form of the data element*

Bit 6 is used to indicate whether the data element is “primitive” or ”constructor”, as shown in Table III-2/Q.932. A primitive element is one whose structure is atomic (i.e., one value only). A constructor element is one whose content is one or more data elements which may themselves be constructor elements.

Both forms of elements are shown in Figure III-4/Q.932.

TABLE III-2/Q.932

Coding of element form

Element form	Coding (6)
Primitive	0
Constructor	1

III.2.3 *Tag code*

Bits 1 to 5 of the first octet of the tag plus any extension octets represent a tag code that distinguishes one element type from another of the same class. Tag codes in the range 00000 to 11110 (0 to 30 decimal) are provided in one octet.

The extension mechanism is to code bits 1 to 5 of the first octet as 11111. Bit 8 of the following octet serves as an extension indication. If bit 8 of the extension octet is set to 0, then no further octets for this tag are used. If bit 8 is set to 1, the following octet is also used for extension of the tag code. The resultant tag consists of bits 1 to 7 of each extension octet with bit 7 of the first extension octet being most significant and bit 1 of the last extension octet being least significant. Tag code 31 is encoded as 0011111 in bits 7 to 1 of a single extension octet. Higher tag codes continue from this point using the minimum possible number of extension octets.

Figure III-6/Q.932 shows the detailed format of the tag code.

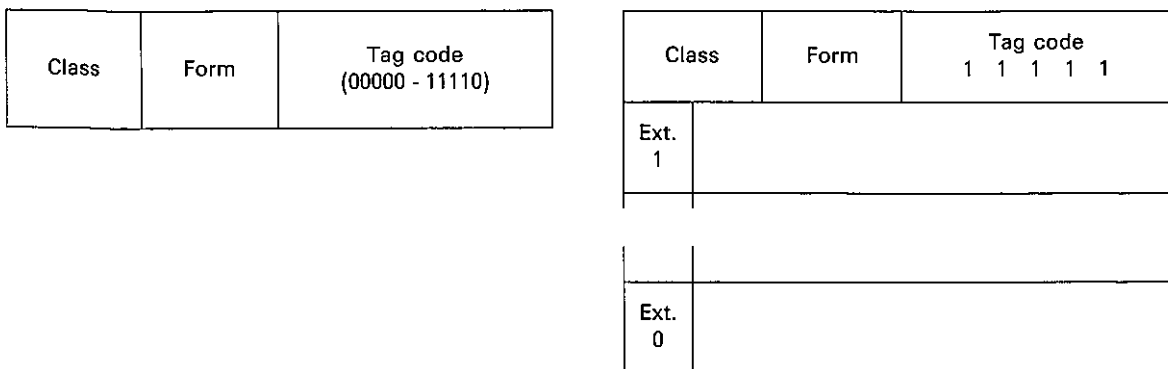

a) *One octet format*

b) *Extended format*

FIGURE III-6/Q.932

Format of the tag code

III.3 *Length of the contents*

The length of the contents is coded to indicate the number of octets in the contents. The length does not include the tag nor the length of the contents octets.

The length of the contents uses the short, long or indefinite form. If the length is less than 128 octets, the short form is used. In the short form, bit 8 is coded 0, and the length is encoded as a binary number using bits 1 to 7.

If the length of the contents is greater than 127 octets, then the long form of the length of the contents is used. The long form length is from 2 to 127 octets long. Bit 8 of the first octet is coded 1, and bits 1 to 7 of the first octet encode a number one less than the size of the length in octets as an unsigned binary number whose MSB and LSB are bits 7 and 1, respectively. The length itself is encoded as an unsigned binary number whose MSB and LSB are bit 8 of the second octet and bit 1 of the last octet, respectively. This binary number should be encoded in the fewest possible octets, with no leading octets having the value 0.

The indefinite form is one octet long and may (but need not) be used in place of the short or long form, whenever the element is a constructor. It has the value 10000000. When this form is employed, a special end-of-contents (EOC) indicator terminates the contents.

There is no notation for the end-of-contents indicator. Although considered part of the contents syntactically, the end-of-contents indicator has no semantic significance.

The representation for the end-of-contents indicator is an element whose class is universal, whose form is primitive, whose identifier code has the value 0, and whose contents is unused and absent (see Table III-3/Q.932).

TABLE III-3/Q.932

Representation for the end-of-contents indicator

EOC 00 (hex)	Length 00 (hex)	Contents Absent
-----------------	--------------------	--------------------

Figure III-7/Q.932 shows the formats of the length field described above. The maximum value that may be encoded is constrained by Q.931 information element size limitations.

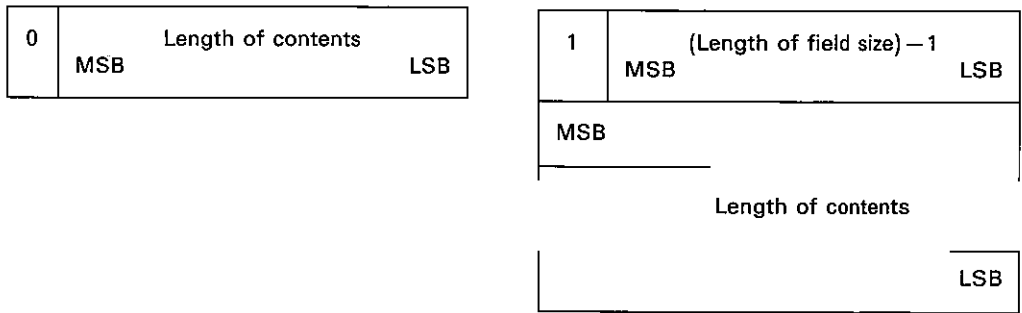

a) Short form

b) Long form

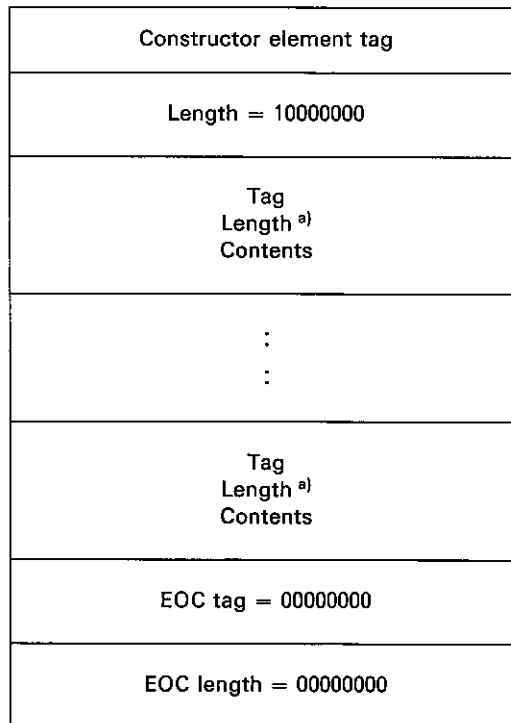

c) Indefinite form

^{a)} The length may take any of three forms: short, long and indefinite.

FIGURE III-7/Q.932
Format of length field

III.4 Contents

The contents is the substance of the data element and contains the information the data element is intended to convey. Its length is variable, but always an integral number of octets. The contents is interpreted in a type-dependent manner, i.e., according to the tag value.

Acronyms used in Recommendation Q.932

English	French	Spanish	Meaning
APDU	APDU	UDPA	Application Protocol Data Unit
ASN.1	ASN.1	NSA.1	Abstract Syntax Notation One (see Recommendations X.208/X.209)
CEI	CEI	IEC	Connection Endpoint Identifier (see Recommendation Q.920)
CES	CES	SEC	Connection Endpoint Suffix (see Recommendation Q.920)
IA5	IA5	AI5	International Alphabet No. 5
ISDN	RNIS	RDSI	Integrated Services Digital Network
LSB	LSB	BMenosS	Least Significant Bit
MSB	MSB	BMásS	Most Significant Bit
NT2	NT2	TR2	Network Termination Type Two (see Recommendation I.411)
ROSE	ROSE	ESOR	Remote Operations Service Element (see Recommendations X.219/X.229)
SAPI	SAPI	IPAS	Service Access Point Identifier (see Recommendation Q.920)
SPID	SPID	IDPS	Service Profile Identifier
TEI	TEI	IET	Terminal Endpoint Identifier (see Recommendation Q.920)
TID	TID	IDT	Terminal Identifier
USID	USID	IDSU	User Service Identifier

References

- [1] CCITT Recommendation *Basic user-network interface - Layer 1 specification*, Vol. III, Rec. I.430.
- [2] CCITT Recommendation *Primary rate user-network interface - Layer 1 specification*, Vol. III, Rec. I.431.
- [3] CCITT Recommendation *ISDN user-network interface - Data link layer specification*, Vol. VI, Rec. Q.921.
- [4] CCITT Recommendation *ISDN user-network interface layer 3 specification for basic call control*, Vol. VI, Rec. Q.931.
- [5] CCITT Recommendation *ISDN user-network interface layer 3 - General aspects*, Vol. VI, Rec. Q.930.
- [6] CCITT Recommendation *ISDN user-network interface data link layer - General aspects*, Vol. VI, Rec. Q.920.
- [7] CCITT Recommendation *Specification of abstract syntax notation specification of abstract syntax notation one (ASN.1)*, Vol. VIII, Rec. X.208.
- [8] CCITT Recommendation *Specification of basic encoding rules for abstract syntax notation one (ASN.1)*, Vol. VIII, Rec. X.209.
- [9] CCITT Recommendation *Remote operations: model, notation and service definition*, Vol. VIII, Rec. X.219.
- [10] CCITT Recommendation *Remote operations: protocol specification*, Vol. VIII, Rec. X.229.

ITU-T RECOMMENDATIONS SERIES

Series A	Organization of the work of the ITU-T
Series B	Means of expression: definitions, symbols, classification
Series C	General telecommunication statistics
Series D	General tariff principles
Series E	Overall network operation, telephone service, service operation and human factors
Series F	Non-telephone telecommunication services
Series G	Transmission systems and media, digital systems and networks
Series H	Audiovisual and multimedia systems
Series I	Integrated services digital network
Series J	Transmission of television, sound programme and other multimedia signals
Series K	Protection against interference
Series L	Construction, installation and protection of cables and other elements of outside plant
Series M	TMN and network maintenance: international transmission systems, telephone circuits, telegraphy, facsimile and leased circuits
Series N	Maintenance: international sound programme and television transmission circuits
Series O	Specifications of measuring equipment
Series P	Telephone transmission quality, telephone installations, local line networks
Series Q	Switching and signalling
Series R	Telegraph transmission
Series S	Telegraph services terminal equipment
Series T	Terminals for telematic services
Series U	Telegraph switching
Series V	Data communication over the telephone network
Series X	Data networks and open system communications
Series Y	Global information infrastructure and Internet protocol aspects
Series Z	Languages and general software aspects for telecommunication systems