



INTERNATIONAL TELECOMMUNICATION UNION

ITU-T

TELECOMMUNICATION
STANDARDIZATION SECTOR
OF ITU

T.4

(03/93)

**TERMINAL EQUIPMENTS AND PROTOCOLS
FOR TELEMATIC SERVICES**

**STANDARDIZATION OF GROUP 3
FACSIMILE APPARATUS FOR
DOCUMENT TRANSMISSION**

ITU-T Recommendation T.4

(Previously "CCITT Recommendation")

FOREWORD

The ITU Telecommunication Standardization Sector (ITU-T) is a permanent organ of the International Telecommunication Union. The ITU-T is responsible for studying technical, operating and tariff questions and issuing Recommendations on them with a view to standardizing telecommunications on a worldwide basis.

The World Telecommunication Standardization Conference (WTSC), which meets every four years, established the topics for study by the ITU-T Study Groups which, in their turn, produce Recommendations on these topics.

ITU-T Recommendation T.4 was revised by the ITU-T Study Group VIII (1988-1993) and was approved by the WTSC (Helsinki, March 1-12, 1993).

NOTES

1 As a consequence of a reform process within the International Telecommunication Union (ITU), the CCITT ceased to exist as of 28 February 1993. In its place, the ITU Telecommunication Standardization Sector (ITU-T) was created as of 1 March 1993. Similarly, in this reform process, the CCIR and the IFRB have been replaced by the Radiocommunication Sector.

In order not to delay publication of this Recommendation, no change has been made in the text to references containing the acronyms "CCITT, CCIR or IFRB" or their associated entities such as Plenary Assembly, Secretariat, etc. Future editions of this Recommendation will contain the proper terminology related to the new ITU structure.

2 In this Recommendation, the expression "Administration" is used for conciseness to indicate both a telecommunication administration and a recognized operating agency.

© ITU 1994

All rights reserved. No part of this publication may be reproduced or utilized in any form or by any means, electronic or mechanical, including photocopying and microfilm, without permission in writing from the ITU.

CONTENTS

| | | <i>Page</i> |
|---|--|-------------|
| 1 | Scanning track..... | 1 |
| 2 | Dimensions of apparatus..... | 1 |
| 3 | Transmission time per total coded scan line..... | 2 |
| 3.3 | Error correction mode..... | 4 |
| 4 | Coding scheme..... | 5 |
| 4.1 | One-dimensional coding scheme..... | 5 |
| 4.2 | Two-dimensional coding scheme..... | 8 |
| 4.3 | Extended two-dimensional coding scheme..... | 16 |
| 4.4 | Error limiting mode..... | 16 |
| 5 | Modulation and demodulation..... | 16 |
| 6 | Power at the transmitter output..... | 17 |
| 7 | Power at the receiver input..... | 17 |
| 8 | Implementation of apparatus..... | 17 |
| 9 | File transfer for group 3..... | 17 |
| 10 | Character mode of group 3..... | 17 |
| 11 | Mixed mode for group 3..... | 17 |
| 12 | 64 kbit/s option for group 3..... | 17 |
| Annex A – Optional error correction mode..... | | 18 |
| A.1 | Introduction..... | 18 |
| A.2 | Definitions..... | 18 |
| A.3 | Message format..... | 18 |
| Annex B – Optional error limiting mode..... | | 21 |
| B.1 | Data..... | 21 |
| B.2 | End of line (EOL)..... | 25 |
| B.3 | Fill..... | 25 |
| B.4 | Return to control (RTC)..... | 25 |
| Annex C – Optional file transfer for group 3..... | | 28 |
| C.1 | Introduction..... | 28 |
| C.2 | Definitions..... | 28 |
| C.3 | Normative references..... | 28 |
| C.4 | Definition of the different file transfer modes..... | 29 |
| C.5 | Coding of the file description..... | 30 |
| C.6 | Message format – Blocks structure..... | 32 |
| C.7 | Protocol aspects..... | 32 |
| Annex D – Optional character mode of group 3..... | | 34 |
| D.1 | Introduction..... | 34 |
| D.2 | Definitions..... | 34 |
| D.3 | Normative references..... | 34 |
| D.4 | Graphic character set – Repertoire and coding..... | 34 |
| D.5 | Page format..... | 35 |
| D.6 | Control functions..... | 36 |
| D.7 | Message format – Blocks structure..... | 37 |
| D.8 | Protocol aspects..... | 38 |
| D.9 | Imaging process..... | 39 |

| | <i>Page</i> |
|--|-------------|
| Annex E – Optional mixed mode for group 3 | 39 |
| E.1 Introduction | 39 |
| E.2 Definitions | 40 |
| E.3 Facsimile control field (FCF) | 40 |
| E.4 Frame numbering | 40 |
| E.5 Facsimile data field | 40 |
| E.6 Character coded data field | 41 |
| E.7 Graphic character set | 41 |
| E.8 Page format | 41 |
| E.9 Control functions | 41 |
| E.10 End of retransmission (EOR) | 41 |
| Annex F – 64 kbit/s option of facsimile group 3 [G3 (UDI)] | 41 |
| F.1 Introduction | 41 |
| F.2 Terminal characteristics for G3 (UDI) | 42 |
| F.3 Protocol set | 42 |
| F.4 Basic procedure for the interchange of G3-64 kbit/s option facsimile document | 44 |
| F.5 Interworking | 50 |
| Appendix I – Guaranteed reproducible area for group 3 apparatus conforming to Recommendation T.4 | 52 |
| Appendix II – Repertoire of box-drawing characters for character mode of group 3 apparatus | 55 |

Recommendation T.4

STANDARDIZATION OF GROUP 3 FACSIMILE APPARATUS FOR DOCUMENT TRANSMISSION

(Geneva, 1980; amended at Malaga-Torremolinos, 1984, Melbourne, 1988
and at Helsinki, 1993)

The CCITT,

considering

- (a) that Recommendation T.2 refers to group 1 type apparatus for ISO A4 document transmission over a telephone-type circuit in approximately six minutes;
- (b) that Recommendation T.3 refers to group 2 type apparatus for ISO A4 document transmission over a telephone-type circuit in approximately three minutes;
- (c) that there is a demand for group 3 apparatus which enables an ISO A4 document to be transmitted over a telephone-type circuit in approximately one minute;
- (d) that for a large number of applications black and white reproduction is sufficient;
- (e) that such a service may be requested either alternatively with telephone conversation, or when either or both stations are not attended; in both cases, the facsimile operation will follow Recommendation T.30,

unanimously declares the view

that group 3 facsimile apparatus for use on the general switched telephone network, international leased circuits and integrated services digital network (ISDN) should be designed and operated according to the following standards.

1 Scanning track

The message area should be scanned in the same direction in the transmitter and receiver. Viewing the message area in a vertical plane, the picture elements should be processed as if the scanning direction were from left to right with subsequent scans adjacent and below the previous scan.

2 Dimensions of apparatus

NOTE – The tolerances on the factors of cooperation are subject to further study.

2.1 The following dimensions shall be used for ISO A4, ISO B4 and ISO A3:

- a) a standard resolution of 3.85 line/mm \pm 1% in vertical resolution;
- b) optional higher resolution of 7.7 line/mm \pm 1% and 15.4 line/mm \pm 1% in vertical direction;
- c) 1728 black and white picture elements along the standard scan line length of 215 mm \pm 1%;
- d) optionally, 2048 black and white picture elements along a scan line length of 255 mm \pm 1%;
- e) optionally, 2432 black and white picture elements along a scan line length of 303 mm \pm 1%;
- f) optionally, 3456 black and white picture elements along a scan line length of 215 mm \pm 1%;
- g) optionally, 4096 black and white picture elements along a scan line length of 255 mm \pm 1%;
- h) optionally, 4864 black and white picture elements along a scan line length of 303 mm \pm 1%.

and, for equipment which provides A5 and/or A6 facilities:

- i) optionally, 864 black and white picture elements along a scan line length of 107 mm \pm 1%;
- j) optionally, 1216 black and white picture elements along a scan line length of 151 mm \pm 1%;
- k) optionally, 1728 black and white picture elements along a scan line length of 107 mm \pm 1%;
- l) optionally, 1728 black and white picture elements along a scan line length of 151 mm \pm 1%.

The normal method of interworking when transmitting from an A5 or A6 machine to an A4 machine not signalling such capabilities, is that the A5 or A6 content will be enlarged to fill the A4 page (see also Note 4). This means that if the document is then retransmitted, or if it has been stored for later retransmission, it will be received without additional reduction.

Where the full image contents being received from an A4 machine need to be maintained, k) or l) respectively should be used.

Interworking between equipments with A5/A6 and A4 facilities and between equipments with combinations of these facilities is shown in Table 1.

NOTES

1 In case of f), g) and h), those picture elements shall be used in combination with optional higher resolution of 15.4 line/mm \pm 1% in vertical direction.

2 Cases i) to l) describe equipments which may be implemented singly or in any combination and would not, for A5/A6 facsimile equipments, require implementation of a) or b). These equipments may be implemented with cases different for sending and receiving.

3 In cases i) to l), 1728 pels will always be provided to the coder (see Table 1).

In cases i) and j), the additional pels required are produced by pel processing (i.e. either by picture processing or by adding white pels on each side of the central picture information) prior to coding.

4 It could be possible, by a setting on the A5/A6 transmitting machine, to send the document so that it is received equal size on an A4 machine not signalling such capabilities. In this case the vertical resolution will be 3.85 (or 7.7) line/mm. The user should be made aware that in this particular equal size case if the received copy is transmitted back to the A5/A6 machine the subsequent copy will be reduced.

5 Some Administrations may require that equipments using i) or j) dimensions, when working with a receiver not signalling such capabilities, insert a message e.g. "ISO A6" or "ISO A5", as the case may be, into the picture at the transmitting side.

2.2 The following dimensions for inch based resolutions shall be used.

The optional inch based resolution requirements and their picture elements are given in Table 2. Specific values for the number of pels per line are given in Table 2 for all the group 3 resolutions for ISO A4, ISO B4 and ISO A3.

An alternative standard resolution of 200 pels/25.4 mm horizontally \times 100 lines/25.4 mm vertically may be implemented provided that one or more of 200 \times 200 pels/25.4 mm, 300 \times 300 pels/25.4 mm and 400 \times 400 pels/25.4 mm are included.

2.3 Input documents up to a minimum of ISO A4 size should be accepted.

NOTE – The size of the guaranteed reproducible area is shown in Appendix I.

3 Transmission time per total coded scan line

The total coded scan line is defined as the sum of data bits plus any required fill bits plus the end-of-line (EOL) bits.

For the optional two-dimensional coding scheme as described in 4.2, the total coded scan line is defined as the sum of data bits plus any required fill bits plus the EOL bits plus a tag bit.

To handle various printing methods, several optional minimum total coded scan line times are possible in addition to the 20 milliseconds standard.

TABLE 1/T.4

Interworking between equipments with A5/A6 and A4 facilities and between equipments with combinations of these facilities

| | | Terminal capabilities at reception side | | | | | |
|--------------------------------|-------------------------|--|---|--|--------------------------|--------------------------|--|
| | | b) | e) | f) | g) | h) | |
| Situation at transmission side | Case from subclause 2.1 | | | | | | |
| | Horizontal resolution | 1728 pels/215 mm | 864 pels/107 mm | 1216 pels/151 mm | 1728 pels/107 mm | 1728 pels/151 mm | |
| | Vertical resolution | 3.85 l/mm 7.7 l/mm | 7.7 l/mm 15.4 l/mm | 5.44 l/mm 10.9 l/mm | 7.7 l/mm 15.4 l/mm | 5.44 l/mm 10.9 l/mm | |
| | Pel process | 1728 Original | 864 ($\approx 1728 \times 0.70$) (Note 1) | 1216 ($\approx 1728 \times 0.70$) (Note 2) | 1728 Original | 1728 Original | |
| | Case from subclause 2.1 | DIS-DTC → DCS ↓ | Bit 33 = 1 Bit 35 = 1 | Bit 33 = 1 Bit 34 = 1 | Bit 33 = 1 Bit 37 = 1 | Bit 33 = 1 Bit 36 = 1 | |
| Pel process | Original 1728 | Equal (A4) | Reduced (A4 → A6) | Reduced (A4 → A5) | Reduced (A4 → A6) | Reduced (A4 → A5) | |
| | 864 × 2 (Note 1) | Enlarged (A6 → A4) | Equal (A6) (Note 1) | Enlarged (A6 → A5) | Equal (A6) | Enlarged (A6 → A5) | |
| | 1216 × 1.42 (Note 2) | Enlarged (A5 → A4) | Reduced (A5 → A6) | Equal (A5) (Note 2) | Reduced (A5 → A6) | Equal (A5) | |
| | Original 1728 | Enlarged (A6 → A4) | Equal (A6) | Enlarged (A6 → A5) | Equal (A6) | Enlarged (A6 → A5) | |
| Original 1728 | Original 1728 | Enlarged (A5 → A4) | Reduced (A5 → A6) | Equal (A5) | Reduced (A5 → A6) | Equal (A5) | |
| | Original 1728 | Enlarged (A6 → A4) | Equal (A6) | Enlarged (A6 → A5) | Equal (A6) | Enlarged (A6 → A5) | |
| Original 1728 | Original 1728 | Enlarged (A5 → A4) | Reduced (A5 → A6) | Equal (A5) | Reduced (A5 → A6) | Equal (A5) | |
| | Original 1728 | Enlarged (A6 → A4) | Equal (A6) | Enlarged (A6 → A5) | Equal (A6) | Enlarged (A6 → A5) | |
| Original 1728 | Original 1728 | Enlarged (A5 → A4) | Reduced (A5 → A6) | Equal (A5) | Reduced (A5 → A6) | Equal (A5) | |
| | Original 1728 | Enlarged (A6 → A4) | Equal (A6) | Enlarged (A6 → A5) | Equal (A6) | Enlarged (A6 → A5) | |
| Original 1728 | Original 1728 | Enlarged (A5 → A4) | Reduced (A5 → A6) | Equal (A5) | Reduced (A5 → A6) | Equal (A5) | |
| | Original 1728 | Enlarged (A6 → A4) | Equal (A6) | Enlarged (A6 → A5) | Equal (A6) | Enlarged (A6 → A5) | |
| Original 1728 | Original 1728 | Enlarged (A5 → A4) | Reduced (A5 → A6) | Equal (A5) | Reduced (A5 → A6) | Equal (A5) | |
| | Original 1728 | Enlarged (A6 → A4) | Equal (A6) | Enlarged (A6 → A5) | Equal (A6) | Enlarged (A6 → A5) | |
| NOTES | | | | | | | |
| 1 | Bit 33 = 1 | Transmit pel process = 432(W) + 864 + 432(W) | | | | | |
| | Bit 35 = 1 | Receive pel process extracts central 864 pels | | | | | |
| 2 | Bit 33 = 1 | Transmit pel process = 256(W) + 1216 + 256(W) | | | | | |
| | Bit 34 = 1 | Receive pel process extracts central 1216 pels | | | | | |

(W) White pels
1 Line

TABLE 2/T.4

| Resolution (pels/25.4 mm) | Tolerance | Number of picture elements along a scan line | | |
|--------------------------------|-----------|--|----------------|----------------|
| | | ISO A4 | ISO B4 | ISO A3 |
| Horizontal 200 Vertical 200 | ± 1% | 1728/219.46 mm | 2048/260.10 mm | 2432/308.86 mm |
| Horizontal 300 Vertical 300 | ± 1% | 2592/219.46 mm | 3072/260.10 mm | 3648/308.86 mm |
| Horizontal 400 Vertical 400 | ± 1% | 3456/219.46 mm | 4096/260.10 mm | 4864/308.86 mm |

NOTE – The resolutions 200 × 200 pels/25.4 mm and 8 × 7.7 lines/mm can be considered as being equivalent. Similarly, the resolutions 400 × 400 pels/25.4 mm and 16 × 15.4 lines/mm can be considered also as being equivalent. Consequently, conversion between mm based terminals and inch based terminals is not required for the communications in these cases. However, communication between these resolutions will cause the distortion and the reduction of reproducible area.

3.1 The minimum transmission times of the total coded scan line should conform to the following:

- 1) Alternative 1, where the minimum transmission time of the total coded scan line is the same both for the standard resolution and for the optional higher resolution:
 - a) 20 milliseconds recommended standard;
 - b) 10 milliseconds recognized option with a mandatory fall-back to the 20 milliseconds standard;
 - c) 5 milliseconds recognized option with a mandatory fall-back to the 10 milliseconds option and the 20 milliseconds standard;
 - d) 0 millisecond recognized option with a mandatory fall-back to the 5 milliseconds option, the 10 milliseconds option and the 20 milliseconds standard, and an optional fall-back to the 40 milliseconds option;
 - e) 40 milliseconds recognized option.
- 2) Alternative 2, where the minimum transmission time of the total coded scan line for the optional higher resolution is half of that for the standard resolution (see Note). These figures refer to the standard resolution:
 - a) 10 milliseconds recognized option with a mandatory fall-back to the 20 milliseconds standard;
 - b) 20 milliseconds recommended standard;
 - c) 40 milliseconds recognized option.

The identification and choice of this minimum transmission time is to be made in the pre-message (phase B) portion of Recommendation T.30 control procedure.

NOTE – Alternative 2 applies to equipment with printing mechanisms which achieve the standard vertical resolution by printing two consecutive, identical higher resolution lines. In this case, the minimum transmission time of the total coded scan line for the standard resolution is double the minimum transmission time of the total coded scan line for the higher resolution. The minimum transmission time for the optional resolutions of 15.4 lines/mm and 400 lines/25.4 mm can be a quarter of that for the standard resolution.

3.2 The maximum transmission time of any total coded scan line should be less than 5 seconds. When this transmission time exceeds 5 seconds, the receiver must proceed to disconnect the line.

3.3 Error correction mode

For the optional error correction mode, an HDLC frame structure is utilized to transmit the total coded scan line. This error correction mode is defined in Annex A.

4 Coding scheme

4.1 One-dimensional coding scheme

The one-dimensional run length coding scheme recommended for group 3 apparatus is as follows:

4.1.1 Data

A line of data is composed of a series of variable length code words. Each code word represents a run length of either all white or all black. White runs and black runs alternate. A total of 1728 picture elements represent one horizontal scan line of 215 mm length.

In order to ensure that the receiver maintains colour synchronization, all data lines will begin with a white run length code word. If the actual scan line begins with a black run, a white run length of zero will be sent. Black or white run lengths, up to a maximum length of one scan line (1728 picture elements or pels) are defined by the code words in Tables 3 and 4. The code words are of two types: terminating code words and make-up code words. Each run length is represented by either one terminating code word or one make-up code word followed by a terminating code word.

Run lengths in the range of 0 to 63 pels are encoded with their appropriate terminating code word. Note that there is a different list of code words for black and white run lengths.

Run lengths in the range of 64 to 1728 pels are encoded first by the make-up code word representing the run length which is equal to or shorter than that required. This is then followed by the terminating code word representing the difference between the required run length and the run length represented by the make-up code.

4.1.2 End-of-line (EOL)

This code word follows each line of data. It is a unique code word that can never be found within a valid line of data; therefore, resynchronization after an error burst is possible.

In addition, this signal will occur prior to the first data line of a page.

Format: 000000000001

4.1.3 Fill

A pause may be placed in the message flow by transmitting "fill". Fill may be inserted between a line of data and an EOL, but never within a line of data. Fill must be added to ensure that the transmission time of data, fill and EOL is not less than the minimum transmission time of the total coded scan line established in the pre-message control procedure.

Format: variable length string of 0s.

4.1.4 Return to control (RTC)

The end of a document transmission is indicated by sending six consecutive EOLs. Following the RTC signal, the transmitter will send the post message commands in the framed format and the data signalling rate of the control signals defined in Recommendation T.30.

Format: 000000000001 000000000001
(total of 6 times)

Figures 1 and 2 clarify the relationship of the signals defined herein. Figure 1 shows several scan lines of data starting at the beginning of a transmitted page. Figure 2 shows the last coded scan line of a page.

The identification and choice of either the standard code table or the extended code table is to be made in the pre-message (phase B) portion of Recommendation T.30 control procedures.

TABLE 3/T.4

Terminating codes

| White run length | Code word | Black run length | Code word |
|------------------|-----------|------------------|--------------|
| 0 | 00110101 | 0 | 0000110111 |
| 1 | 000111 | 1 | 010 |
| 2 | 0111 | 2 | 11 |
| 3 | 1000 | 3 | 10 |
| 4 | 1011 | 4 | 011 |
| 5 | 1100 | 5 | 0011 |
| 6 | 1110 | 6 | 0010 |
| 7 | 1111 | 7 | 00011 |
| 8 | 10011 | 8 | 000101 |
| 9 | 10100 | 9 | 000100 |
| 10 | 00111 | 10 | 0000100 |
| 11 | 01000 | 11 | 0000101 |
| 12 | 001000 | 12 | 0000111 |
| 13 | 000011 | 13 | 00000100 |
| 14 | 110100 | 14 | 00000111 |
| 15 | 110101 | 15 | 000011000 |
| 16 | 101010 | 16 | 0000010111 |
| 17 | 101011 | 17 | 0000011000 |
| 18 | 0100111 | 18 | 0000001000 |
| 19 | 0001100 | 19 | 00001100111 |
| 20 | 0001000 | 20 | 00001101000 |
| 21 | 0010111 | 21 | 00001101100 |
| 22 | 0000011 | 22 | 00000110111 |
| 23 | 0000100 | 23 | 00000101000 |
| 24 | 0101000 | 24 | 00000010111 |
| 25 | 0101011 | 25 | 00000011000 |
| 26 | 0010011 | 26 | 000011001010 |
| 27 | 0100100 | 27 | 000011001011 |
| 28 | 0011000 | 28 | 000011001100 |
| 29 | 00000010 | 29 | 000011001101 |
| 30 | 00000011 | 30 | 000001101000 |
| 31 | 00011010 | 31 | 000001101001 |
| 32 | 00011011 | 32 | 000001101010 |
| 33 | 00010010 | 33 | 000001101011 |
| 34 | 00010011 | 34 | 000011010010 |
| 35 | 00010100 | 35 | 000011010011 |
| 36 | 00010101 | 36 | 000011010100 |
| 37 | 00010110 | 37 | 000011010101 |
| 38 | 00010111 | 38 | 000011010110 |
| 39 | 00101000 | 39 | 000011010111 |
| 40 | 00101001 | 40 | 000001101100 |
| 41 | 00101010 | 41 | 000001101101 |
| 42 | 00101011 | 42 | 000011011010 |
| 43 | 00101100 | 43 | 000011011011 |
| 44 | 00101101 | 44 | 000001010100 |
| 45 | 00000100 | 45 | 000001010101 |
| 46 | 00000101 | 46 | 000001010110 |
| 47 | 00001010 | 47 | 000001010111 |
| 48 | 00001011 | 48 | 000001100100 |
| 49 | 01010010 | 49 | 000001100101 |
| 50 | 01010011 | 50 | 000001010010 |
| 51 | 01010100 | 51 | 000001010011 |
| 52 | 01010101 | 52 | 000000100100 |
| 53 | 00100100 | 53 | 000000110111 |
| 54 | 00100101 | 54 | 000000111000 |
| 55 | 01011000 | 55 | 000000100111 |
| 56 | 01011001 | 56 | 000000101000 |
| 57 | 01011010 | 57 | 000001011000 |
| 58 | 01011011 | 58 | 000001011001 |
| 59 | 01001010 | 59 | 000000101011 |
| 60 | 01001011 | 60 | 000000101100 |
| 61 | 00110010 | 61 | 000001011010 |
| 62 | 00110011 | 62 | 000001100110 |
| 63 | 00110100 | 63 | 000001100111 |

TABLE 3/T.4 (cont.)

Terminating codes

| White run length | Code word | Black run length | Code word |
|------------------|--------------|------------------|---------------|
| 64 | 11011 | 64 | 0000001111 |
| 128 | 10010 | 128 | 000011001000 |
| 192 | 010111 | 192 | 000011001001 |
| 256 | 01101111 | 256 | 000001011011 |
| 320 | 00110110 | 320 | 000000110011 |
| 384 | 00110111 | 384 | 000000110100 |
| 448 | 01100100 | 448 | 000000110101 |
| 512 | 01100101 | 512 | 0000001101100 |
| 576 | 01101000 | 576 | 0000001101101 |
| 640 | 01100111 | 640 | 0000001001010 |
| 704 | 011001100 | 704 | 0000001001011 |
| 768 | 011001101 | 768 | 0000001001100 |
| 832 | 011010010 | 832 | 0000001001101 |
| 896 | 011010011 | 896 | 0000001110010 |
| 960 | 011010100 | 960 | 0000001110011 |
| 1024 | 011010101 | 1024 | 0000001110100 |
| 1088 | 011010110 | 1088 | 0000001110101 |
| 1152 | 011010111 | 1152 | 0000001110110 |
| 1216 | 011011000 | 1216 | 0000001110111 |
| 1280 | 011011001 | 1280 | 0000001010010 |
| 1344 | 011011010 | 1344 | 0000001010011 |
| 1408 | 011011011 | 1408 | 0000001010100 |
| 1472 | 010011000 | 1472 | 0000001010101 |
| 1536 | 010011001 | 1536 | 0000001011010 |
| 1600 | 010011010 | 1600 | 0000001011011 |
| 1664 | 011000 | 1664 | 0000001100100 |
| 1728 | 010011011 | 1728 | 0000001100101 |
| EOL | 000000000001 | EOL | 000000000001 |

NOTE – It is recognized that machines exist which accommodate larger paper widths maintaining the standard horizontal resolution. This option has been provided for by the addition of the make-up code set defined in Table 4.

TABLE 4/T.4

Make-up codes

| Run length (black and white) | Make-up codes |
|------------------------------|---------------|
| 1792 | 00000001000 |
| 1856 | 00000001100 |
| 1920 | 00000001101 |
| 1984 | 000000010010 |
| 2048 | 000000010011 |
| 2112 | 000000010100 |
| 2176 | 000000010101 |
| 2240 | 000000010110 |
| 2304 | 000000010111 |
| 2368 | 000000011100 |
| 2432 | 000000011101 |
| 2496 | 000000011110 |
| 2560 | 000000011111 |

NOTE – Run lengths in the range of lengths longer than or equal to 2624 pels are coded first by the make-up code of 2560. If the remaining part of the run (after the first make-up code of 2560) is 2560 pels or greater, additional make-up code(s) of 2560 are issued until the remaining part of the run becomes less than 2560 pels. Then the remaining part of the run is encoded by terminating code or by make-up code plus terminating code according to the range as mentioned above.

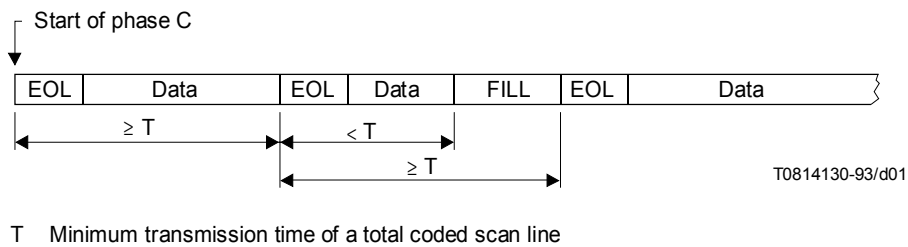

FIGURE 1/T.4

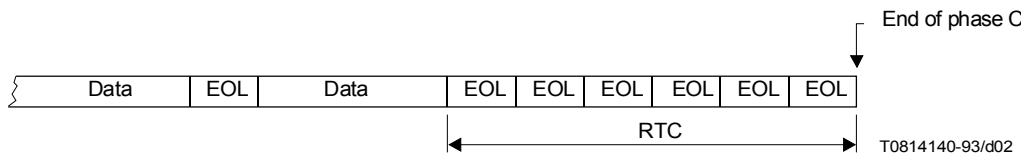

FIGURE 2/T.4

4.2 Two-dimensional coding scheme

The two-dimensional coding scheme is an optional extension of the one-dimensional coding scheme specified in 4.1 and is as follows:

4.2.1 Data

4.2.1.1 Parameter K

In order to limit the disturbed area in the event of transmission errors, after each line coded one-dimensionally, at most $K-1$ successive lines shall be coded two-dimensionally. A one-dimensionally coded line may be transmitted more frequently than every K lines. After a one-dimensional line is transmitted, the next series of $K-1$ two-dimensional lines is initiated. The maximum value of K shall be set as follows:

- Standard vertical resolution: $K = 2$
- Optional higher vertical resolution: $K = 4$.

NOTES

1 Some Administrations pointed out that for the optional higher vertical resolution K may optionally be set to a lower value.

2 Some Administrations reserve the right to approve only such apparatus for use in the facsimile service in their respective countries which will be able to produce a visible sign on its received facsimile message indicating that two-dimensional coding has been used in the transmission process.

4.2.1.2 One-dimensional coding

This conforms with the description of data in 4.1.1.

4.2.1.3 Two-dimensional coding

This is a line-by-line coding method in which the position of each changing picture element on the current or coding line is coded with respect to the position of a corresponding reference element situated on either the coding line or the reference line which lies immediately above the coding line. After the coding line has been coded it becomes the reference line for the next coding line.

4.2.1.3.1 Definition of changing picture elements (see Figure 3)

changing element: Element whose “colour” (i.e. black or white) is different from that of the previous element along the same scan line.

- a_0 The reference or starting changing element on the coding line. At the start of the coding line a_0 is set on an imaginary white changing element situated just before the first element on the line. During the coding of the coding line, the position of a_0 is defined by the previous coding mode. (See 4.2.1.3.2.)
- a_1 The next changing element to the right of a_0 on the coding line.
- a_2 The next changing element to the right of a_1 on the coding line.
- b_1 The first changing element on the reference line to the right of a_0 and of opposite colour to a_0 .
- b_2 The next changing element to the right of b_1 on the reference line.

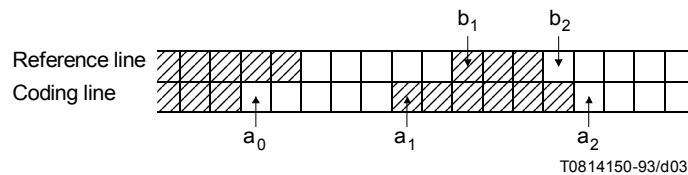

FIGURE 3/T.4
Changing picture elements

4.2.1.3.2 Coding modes

One of the three coding modes are chosen according to the coding procedure described in 4.2.1.3.3 to code the position of each changing element along the coding line. Examples of the three coding modes are given in Figures 4, 5 and 6.

a) Pass mode

This mode is identified when the position of b_2 lies to the left of a_1 . When this mode has been coded, a_0 is set on the element of the coding line below b_2 in preparation for the next coding (i.e. on a'_0).

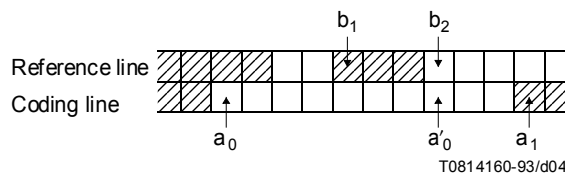

FIGURE 4/T.4
Pass mode

However, the state where b_2 occurs just above a_1 , as shown in Figure 5 is not considered as a pass mode.

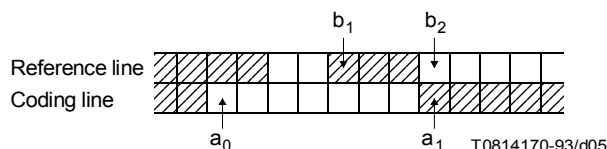

FIGURE 5/T.4
An example not corresponding to a pass mode

b) *Vertical mode*

When this mode is identified, the position of a_1 is coded relative to the position of b_1 . The relative distance a_1b_1 can take on one of seven values $V_R(0)$, $V_R(1)$, $V_R(2)$, $V_R(3)$, $V_L(1)$, $V_L(2)$ and $V_L(3)$, each of which is represented by a separate code word. The subscripts R and L indicate that a_1 is to the right or left respectively of b_1 , and the number in brackets indicates the value of the distance a_1b_1 . After vertical mode coding has occurred, the position of a_0 is set on a_1 (see Figure 6).

c) *Horizontal mode*

When this mode is identified, both the run-lengths a_0a_1 and a_1a_2 are coded using the code words $H + M(a_0a_1) + M(a_1a_2)$. H is the flag code word 001 taken from the two-dimensional code table (Table 5). $M(a_0a_1)$ and $M(a_1a_2)$ are code words which represent the length and “colour” of the runs a_0a_1 and a_1a_2 respectively and are taken from the appropriate white or black one-dimensional code tables (Tables 3 and 4). After a horizontal mode coding, the position of a_0 is set on a_2 (see Figure 6).

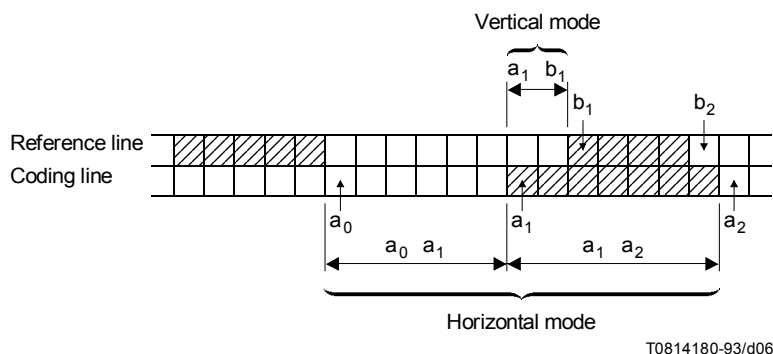
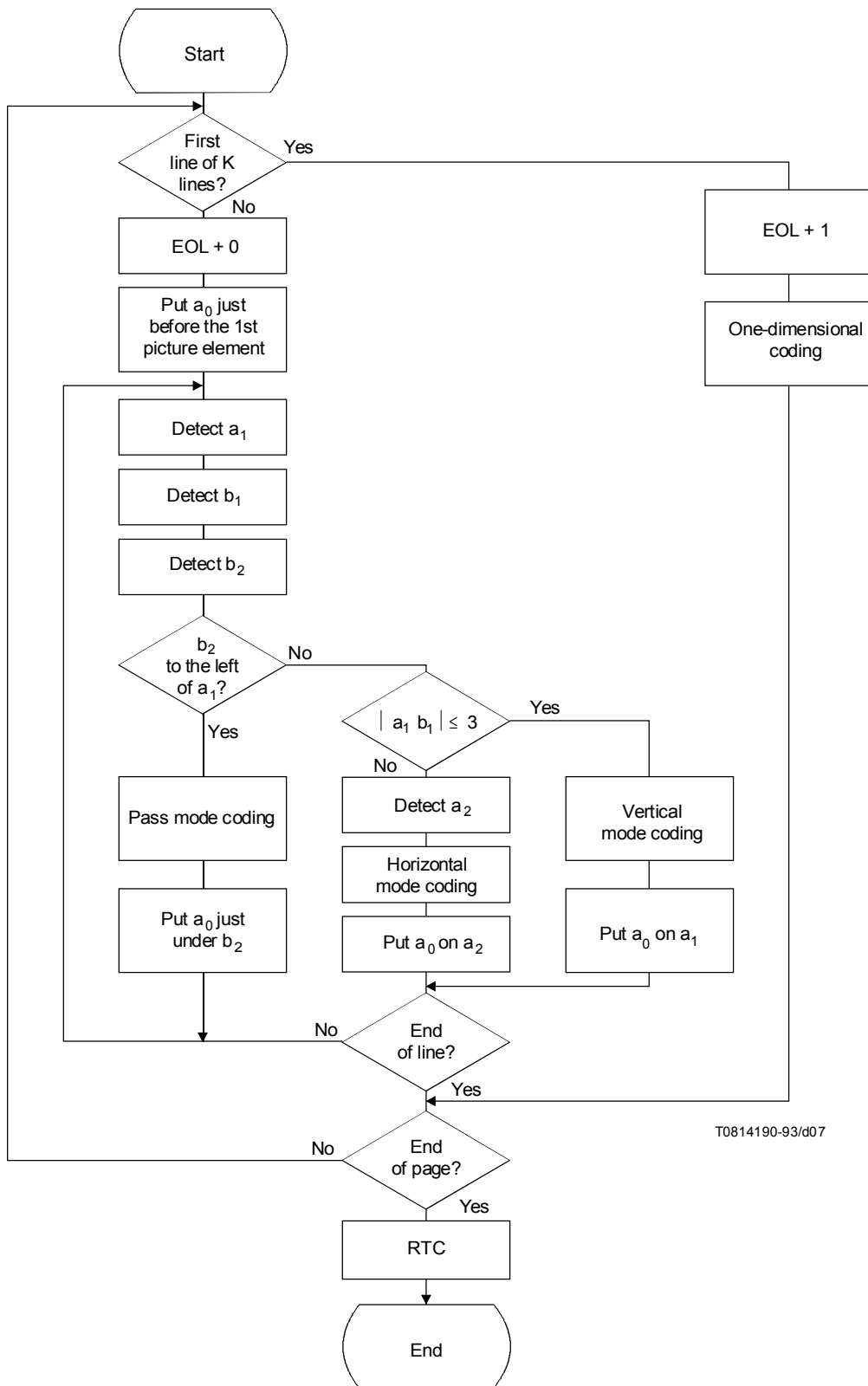

FIGURE 6/T.4
Vertical mode and horizontal mode

4.2.1.3.3 Coding procedure

The coding procedure identifies the coding mode that is to be used to code each changing element along the coding line. When one of the three coding modes has been identified according to step 1 or step 2 mentioned below, an appropriate code word is selected from the code table given in Table 5. The coding procedure is as shown in the flow diagram of Figure 7.



T0814190-93/d07

FIGURE 7/T.4
Two-dimensional coding flow diagram

NOTE – It does not affect compatibility to restrict the use of pass mode in the encoder to a single pass mode. Variations of the algorithm which do not affect compatibility should be the subject of further study.

Step 1

- i) If a pass mode is identified, this is coded using the word 0001 (Table 5). After this processing, picture element a'_0 just under b_2 is regarded as the new starting picture element a_0 for the next coding (see Figure 4).
- ii) If a pass mode is not detected then proceed to step 2.

Step 2

- i) Determine the absolute value of the relative distance a_1b_1 .
- ii) If $|a_1b_1| \leq 3$, as shown in Table 5, a_1b_1 is coded by the vertical mode, after which position a_1 is regarded as the new starting picture element a_0 for the next coding.
- iii) If $|a_1b_1| > 3$, as shown in Table 5, following horizontal mode code 001, a_0a_1 and a_1a_2 are respectively coded by one-dimensional coding. After this processing position a_2 is regarded as the new starting picture element a_0 for the next coding.

TABLE 5/T.4

Two-dimensional code table

| Mode | Elements to be coded | | Notation | Code word |
|--------------|--------------------------------------|--------------|--|---|
| Pass | b_1, b_2 | | P | 0001 |
| Horizontal | a_0a_1, a_1a_2 | | H | $001 + M(a_0a_1) + M(a_1a_2)$ (see Note 1) |
| Vertical | a_1 just under b_1 | $a_1b_1 = 0$ | $V(0)$ | 1 |
| | a_1 to the right of b_1 | $a_1b_1 = 1$ | $V_R(1)$ | 011 |
| | | $a_1b_1 = 2$ | $V_R(2)$ | 000011 |
| | | $a_1b_1 = 3$ | $V_R(3)$ | 0000011 |
| | a_1 to the left of b_1 | $a_1b_1 = 1$ | $V_L(1)$ | 010 |
| | | $a_1b_1 = 2$ | $V_L(2)$ | 000010 |
| $a_1b_1 = 3$ | | $V_L(3)$ | 0000010 | |
| Extension | 2-D (extensions) 1-D (extensions) | | 0000001xxx 000000001xxx (see Note 2) | |

NOTES

- 1 Code M() of the horizontal mode represents the code words in Tables 3 and 4.
- 2 It is suggested the uncompressed mode is recognized as an optional extension of two-dimensional coding scheme for group 3 apparatus. The bit assignment for the xxx bits is 111 for the uncompressed mode of operation whose code table is given in Table 6.
- 3 Further study is needed to define other unspecified xxx bit assignments and their use for any further extensions.
- 4 If the suggested uncompressed mode is used on a line designated to be one-dimensionally code, the coder must not switch into uncompressed mode following any code word ending in the sequence 000. This is because any code word ending in 000 followed by a switching code 000000001 will be mistaken for an end-of-line code.

TABLE 6/T.4

Uncompressed mode code words

| | | |
|--|---|--------------|
| Entrance code to uncompressed mode | On one-dimensionally coded line: 00000001111 On two-dimensionally coded line: 0000001111 | |
| Uncompressed mode code | Image pattern | Code word |
| | 1 | 1 |
| | 01 | 01 |
| | 001 | 001 |
| | 0001 | 0001 |
| | 00001 | 00001 |
| Exit from uncompressed mode code | 0 | 0000001T |
| | 00 | 00000001T |
| | 000 | 000000001T |
| | 0000 | 0000000001T |
| | 00000 | 00000000001T |
| T denotes a tag bit which tells the colour of the next run (black = 1, white = 0). | | |

4.2.1.3.4 Processing the first and last picture elements in a linea) *Processing the first picture element*

The first starting picture element a_0 on each coding line is imaginarily set at a position just before the first picture element, and is regarded as a white picture element (see 4.2.1.3.1).

The first run length on a line a_0a_1 is replaced by $a_0a_1 - 1$. Therefore, if the first run is black and is deemed to be coded by horizontal mode coding, then the first code word $M(a_0a_1)$ corresponds to a white run of zero length (see Figure 10, example 5).

b) *Processing the last picture element*

The coding of the coding line continues until the position of the imaginary changing element situated just after the last actual element has been coded. This may be coded as a_1 or a_2 . Also, if b_1 and/or b_2 are not detected at any time during the coding of the line, they are positioned on the imaginary changing element situated just after the last actual picture element on the reference line.

4.2.2 Line synchronization code word

To the end of every coded line is added the end-of-line (EOL) code word 00000000001. The EOL code word is followed by a single tag bit which indicates whether one- or two-dimensional coding is used for the next line.

In addition, EOL plus the tag bit 1 signal will occur prior to the first data line of a page.

Format:

EOL + 1: one-dimensional coding of next line

EOL + 0: two-dimensional coding of next line

4.2.3 Fill

Fill is inserted between a line of data and the line synchronization signal, EOL + tag bit, but is not inserted in data. Fill must be added to ensure that the transmission time of data, fill and EOL plus tag bit is not less than the minimum transmission time of the total coded scan line.

Format: variable length string of 0s.

4.2.4 Return to control (RTC)

The format used is six consecutive line synchronization code words, i.e. $6 \times (\text{EOL} + 1)$.

To further clarify the relationship of the signals defined herein, Figures 8 and 9 are offered in the case of $K = 2$. Figure 8 shows several scan lines of data starting at the beginning of a transmitted page. Figure 9 shows the last several lines of a page.

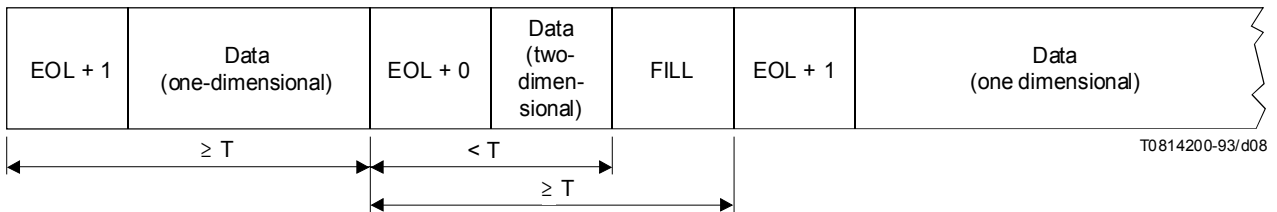

T Minimum transmit time of a total coded scan line

FIGURE 8/T.4
Message transmission (first part of page)

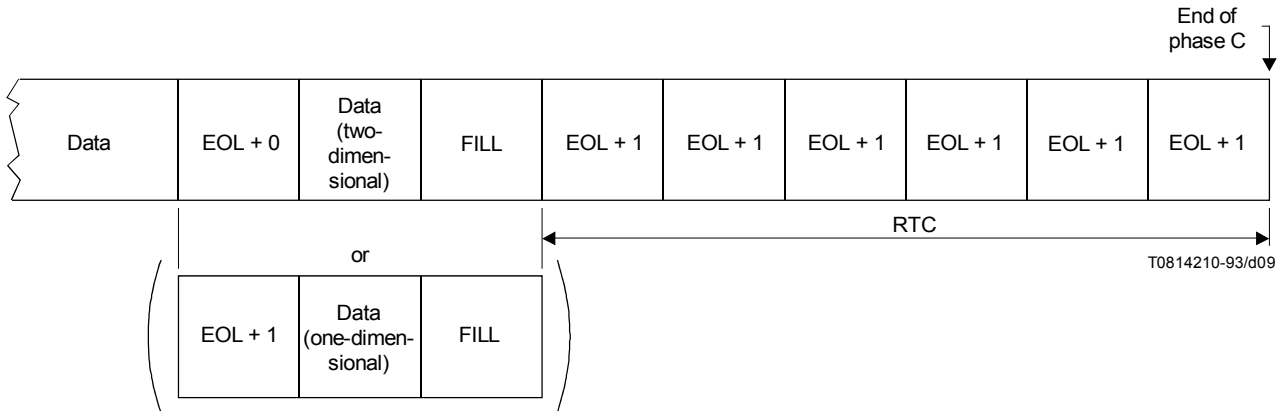
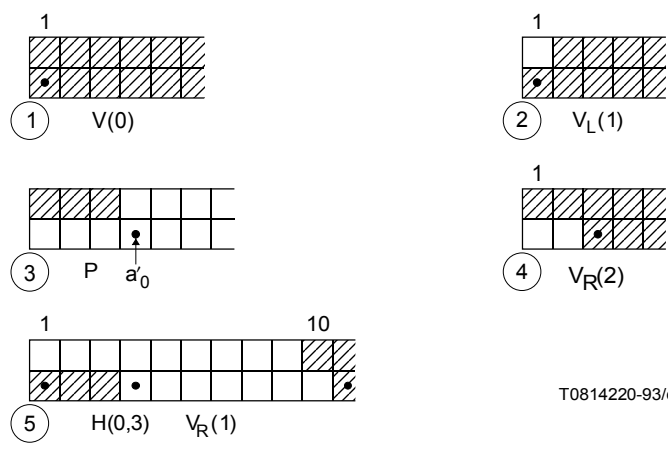

FIGURE 9/T.4
Message transmission (last part of page)

4.2.5 Coding examples

Figure 10 shows coding examples of the first part of scan lines and Figure 11 coding examples of the last part, while Figure 12 shows other coding examples. The notations P, H and V in the figures are, as shown in Table 5, the symbols for pass mode, horizontal mode and vertical mode respectively. The picture elements marked with black spots indicate the changing picture elements to be coded.



T0814220-93/d10

FIGURE 10/T.4
Coding examples: first part of scan line

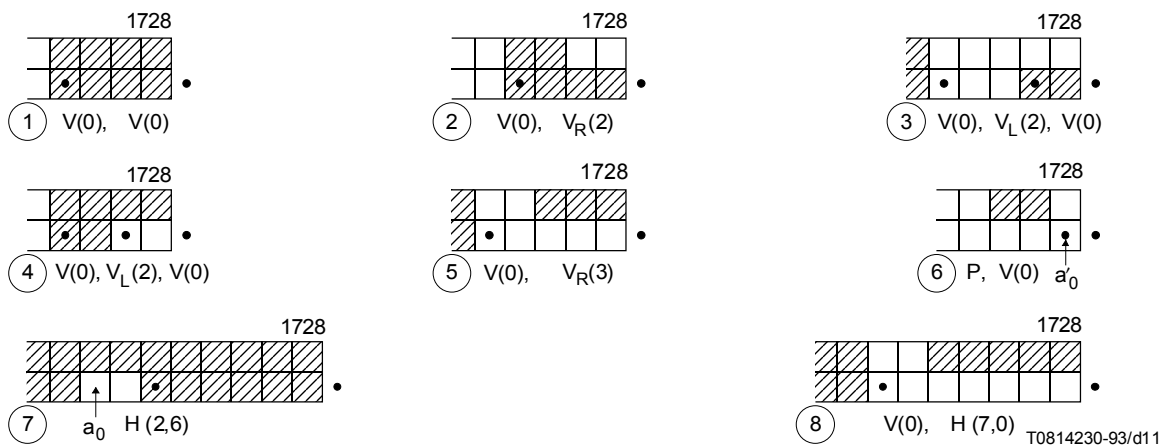

T0814230-93/d11

FIGURE 11/T.4
Coding examples: last part of scan line

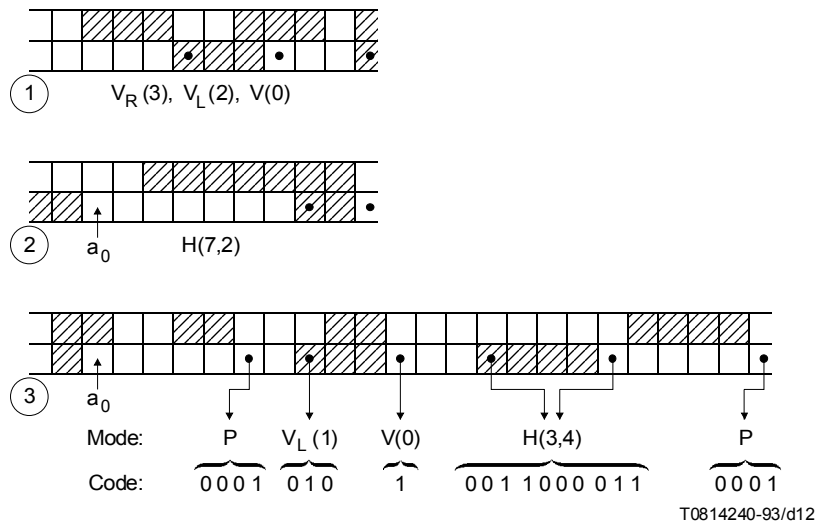

FIGURE 12/T.4
Coding examples

4.3 Extended two-dimensional coding scheme

The basic facsimile coding scheme specified in 2.2/T.6 may be used as an option in group 3 facsimile. This coding scheme is limited to the use of the error correction mode specified in 3.3.

4.4 Error limiting mode

One-dimensional coding scheme with the division of scan line into parts.

The one-dimensional coding scheme with the division of scan line into parts is an optional extension of the one-dimensional coding scheme specified in Annex B.

5 Modulation and demodulation

Group 3 apparatus operating on the general switched telephone network shall utilize the modulation, scrambler, equalization and timing signals defined in 2, 3, 7, 8, 9, 11/V.27 *ter* and in the Appendix I/V.27 *ter*.

5.1 The training signal to be used shall be the long training sequence with protection against talker echo (see 2.5.1/V.27 *ter* and Table 3/V.27 *ter*).

5.2 The data signalling rates to be used are 4800 bit/s and 2400 bit/s as defined in Recommendation V.27 *ter*.

NOTES

1 Some Administrations pointed out that it would not be possible to guarantee the service at a data signalling rate higher than 2400 bit/s.

2 It should be noted that there are equipments in service using, *inter alia*, other modulation methods.

3 When quality of communication service can successfully support higher speed operation, such as may be possible on leased circuits or high-quality switched circuits, group 3 apparatus may optionally utilize the modulation, scrambler, equalization and timing signals defined in Recommendations V.29, V.33 and V.17. For Recommendation V.29 this specifically refers to 1, 2, 3, 4, 7, 8, 9, 10 and 11. Under this option the data should be non-multiplexed and limited to the data signalling rates of 9600 bit/s and 7200 bit/s. For Recommendation V.33 this specifically refers to 1, 2, 3, 4, 7 and 8. Under this option the data should be non-multiplexed. For Recommendation V.17 this specifically refers to 1 through 5.

4 When V.33 signalling is used the training signal shall be preceded by a talker echo protection signal. The talker echo protection signal shall consist of an unmodulated carrier for a duration of 185 ms to 200 ms followed by a silent period of 20 to 25 ms.

5 When V.17 signalling is used the training signal shall include the talker echo protection (TEP) signal defined in 5.3/V.17.

6 Power at the transmitter output

The average power should be adjustable from –15 dBm to 0 dBm but the equipment should be so designed that there is no possibility of this adjustment being tampered with by an operator.

NOTE – The power levels over the international circuits will conform to Recommendation V.2.

7 Power at the receiver input

The receiving apparatus should be capable of functioning correctly when the received signal level is within the range of 0 dBm to –43 dBm. No control of receiver sensitivity should be provided for operator use.

8 Implementation of apparatus

Although paper sizes are referred to, this does not always require a physical paper scanner and/or printer to be implemented. Details may be defined by Administrations.

If the message is not generated from a physical scanner or displayed on paper, then the signals appearing across the network interface shall be identical to those which would be generated if paper input and/or output had been implemented.

9 File transfer for group 3

File transfer is an optional feature of group 3 which permits to transmit any data file with or without additional information concerning the file to be transmitted, by using error correction mode specified in Annex A and in Annex A/T.30.

This file transfer is defined in Annex C.

10 Character mode of group 3

Character mode is an optional feature of group 3 which permits to transmit character coded documents, by using error correction mode specified in Annex A and in Annex A/T.30.

This character mode is defined in Annex D.

11 Mixed mode for group 3

Mixed mode is an optional feature of group 3 which permits to transmit pages containing both character coded and facsimile coded information, by using error correction mode specified in Annex A and in Annex A/T.30.

This mixed mode is defined in Annex E.

12 64 kbit/s option for group 3

For group 3 facsimile, a capability to operate at a rate of 64 kbit/s over the integrated services digital network (ISDN) is provided as a standardized option. There are two technical solutions for this option. One, based on G4 class 1 protocol, is defined in Annex F and called group 3 64 kbit/s option F (G3F) which interworks with G4 class 1 terminals directly. The other, based upon T.30 ECM protocol, is defined in Annex C/T.30 and called group 3 64 kbit/s option C (G3C) which does not interwork directly with G4 class 1/G3F.

NOTE – Interworking between G3C terminals and G3F/G4 terminals may be provided by multiple mode terminals using the procedure defined in Annex F/T.90. The capability of group 3 terminals using the protocol defined in Annex C/T.30 to interwork directly with group 4 terminals is the subject of an urgent study under Question E/VIII.

Annex A

Optional error correction mode

(This annex forms an integral part of this Recommendation)

A.1 Introduction

This annex specifies the message format required for document transmission incorporating the optional error correction capability.

A.2 Definitions

The definitions contained in this Recommendation and in Recommendation T.30 shall be applied unless explicitly amended.

A.3 Message format

An HDLC frame structure is utilized for all binary coded facsimile message procedures. The basic HDLC structure consists of a number of frames each of which is subdivided into a number of fields. It provides for frame labelling and error checking.

Specific examples are given in Figures A.1 and A.2 of formats used for binary coded signalling. These examples show an initial partial page (PP) frame structure and a last PP frame structure.

In the following descriptions of the fields, the order in which the bits are transmitted is from the most to the least significant bit, i.e. from left to right as printed. The exception to this is the frame number (see A.3.6.1).

The equivalent between binary notation symbols and the significant condition of the signalling code should be in accordance with Recommendation V.1.

A.3.1 Synchronization

A synchronization sequence shall precede all binary coded information whenever a new transmission begins. The synchronization shall be a training sequence and a series of flag sequences for nominal 200 ms, tolerance + 100 ms.

NOTE – Continuous flags have two zeros as shown in the following diagram:

...0111 1110 0111 1110 0111 1110...

A.3.2 Flag sequence (F)

The eight bit HDLC flag sequence is used to denote the beginning and end of the frame for the facsimile message procedure. The flag sequence is also used to establish bit and frame synchronization. To facilitate this the synchronization defined in A.3.1 should be used prior to the first frame. Subsequent frames and end of the last frame need one or more than one flag sequence.

Format: 0111 1110

NOTE – The leading flag of a frame may be the trailing flag of the previous frame.

A.3.3 Address field (A)

The eight bit HDLC address field is intended to provide identification of specific station(s) in a multi-point arrangement. In the case of transmission on the general switched telephone network, this field is limited to a single format.

Format: 1111 1111

A.3.4 Control field (C)

The eight bit HDLC control field provides the capability of encoding the command unique to the facsimile message procedure.

Format: 1100 X000

The X bit is set to 0 for the FCD frame (facsimile coded data frame) and the RCP frame (return to control for partial page frame).

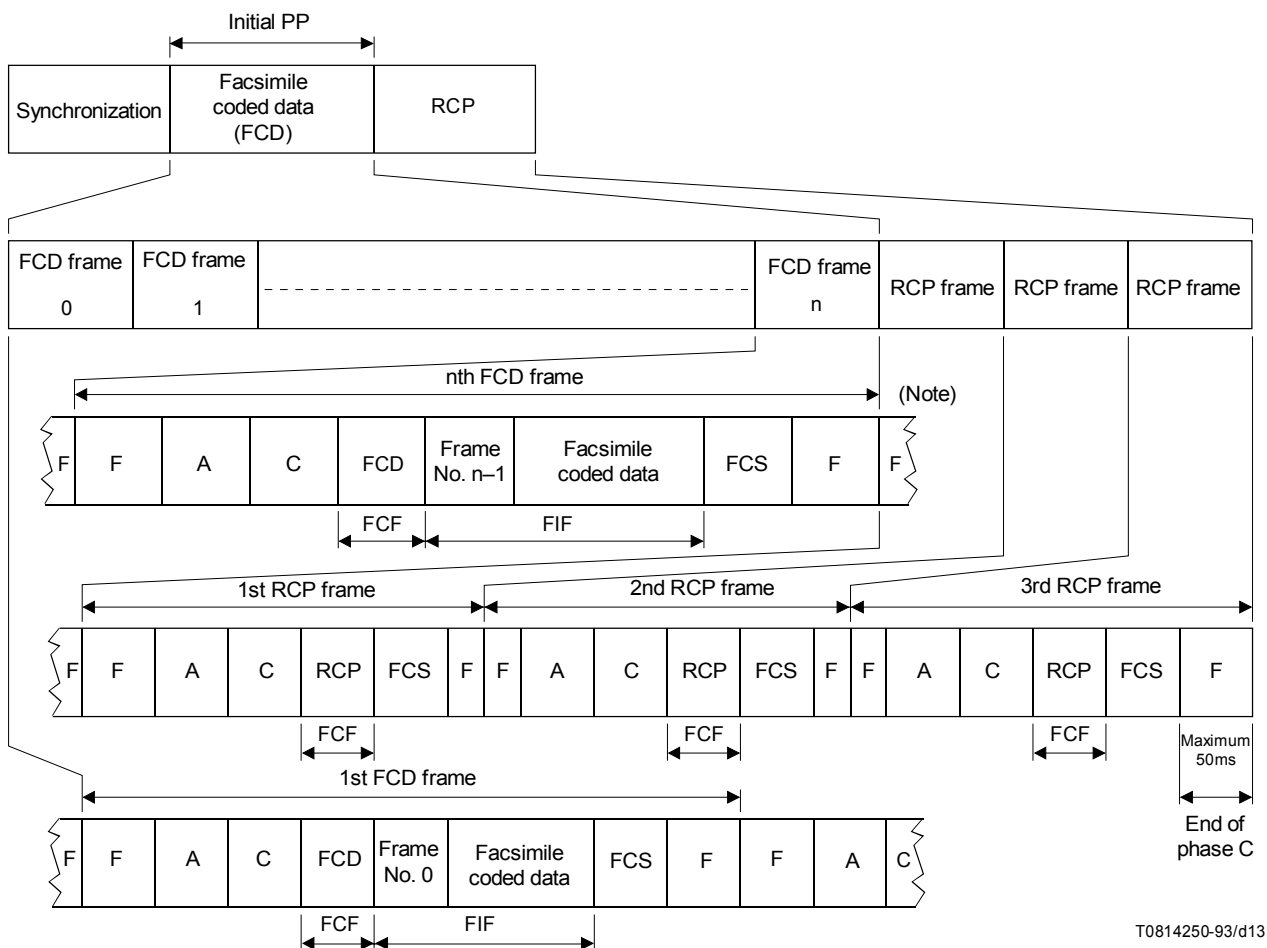

T0814250-93/d13

NOTE – See A.3.2.

FIGURE A.1/T.4
Initial partial page (PP) frame structure

A.3.5 Facsimile control field (FCF)

In order to distinguish between the FCD frame (facsimile coded data frame) and the RCP frame (return to control for partial page frame), the FCF for the in-message procedure is defined as follows:

- 1) FCF for the FCD frame
Format: 0110 0000
- 2) FCF for the RCP frame
Format: 0110 0001

A.3.6 Facsimile information field (FIF)

The facsimile information field is a length of 257 or 65 octets (see Note 1) and is divided into two parts, the frame number and the facsimile data field (see Note 2).

NOTES

- 1 This does not include bit stuffing to preclude non-valid flag sequences.
- 2 There is no information field in the RCP frame.

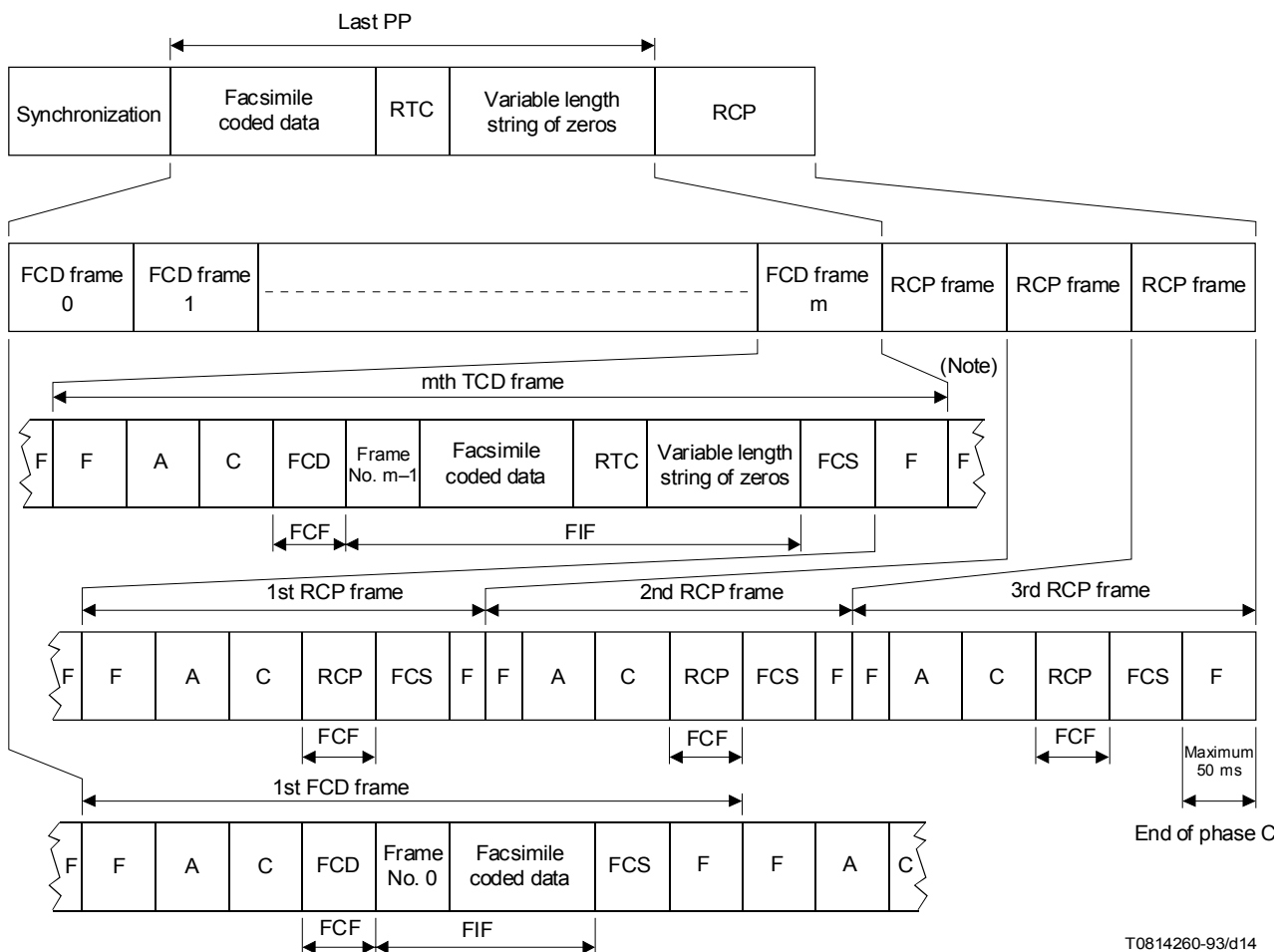

T0814260-93/d14

NOTE – See A.3.2.

FIGURE A.2/T.4
Last partial page (PP) frame structure

A.3.6.1 Frame number

This is an eight bit binary number. The frame number is defined to be the first eight bits of the facsimile information field. The least significant bit is transmitted first.

The frame number 0-255 (maximum number is 255) is used to identify the facsimile data field (see Annex A/T.30).

The frame 0 is transmitted first in each block.

A.3.6.2 Facsimile data field

The coding schemes specified in 4 are valid with the following notes.

- 1) The facsimile data field is a length of 256 or 64 octets.
- 2) The total coded scan line is defined as the sum of data bits plus the EOL bits. For the optional two-dimensional coding scheme as described in 4.2, the total coded scan line is defined as the sum of data bits plus the EOL bits plus a tag bit.
- 3) At the end of facsimile data field, if necessary, pad bits may be used to align on octet boundaries and frame boundaries (see Notes 1 and 2). The format is a variable length string of zeros.

NOTES

- 1 The receiver is able to receive both pad bits and fill bits.
- 2 The facsimile data field length of the final frame including RTC signal may be less than 256 or 64 octets.

A.3.7 Frame checking sequence (FCS)

The FCS shall be a 16 bit sequence (see 5.3.7/T.30).

A.3.8 Return to control for partial page (RCP)

The end of a partial page transmission is indicated by sending three consecutive RCP frames (see Note).

Following these RCP frames, the transmitter will send the post message commands in the framed format and the data signalling rate of the control signals defined in Annex A/T.30.

NOTE – The flag sequence following the last RCP frame shall be less than 50 ms.

Annex B

Optional error limiting mode

(This annex forms an integral part of this Recommendation)

NOTE – The text of Annex B shall be refined and studied during the next study period.

B.1 Data

B.1.1 The division of a scan line into parts

In order to limit the disturbed area in the event of transmission error, the scan lines are divided into parts before coding.

The number of parts shall be used as follows:

- a) standard, 12 parts in a line composed of 1728 black and white picture elements;
- b) optionally, 15 parts in a line composed of 2048 black and white picture elements;
- c) optionally, 17 parts in a line composed of 2432 black and white picture elements.

NOTE – For alternatives b) and c), the last part of a scan line can be shortened and then will contain 32 and 128 pels respectively.

B.1.2 Scan line coding

All parts of a scan line are divided into whites (W) if they are composed of all white picture elements and not-white (NW) if they contain at least one black element.

The coding procedure is as shown in the flow diagram of Figure B.1.

B.1.2.1 Shaping the extended description of a scan line

For each coded scan line the extended scan line description (ELD) is shaped. ELD represents a sequence, where the bit number is equal to the part number in a scan line, i.e. each part has corresponding bit in the sequence. This bit is equal to "1", if the part is "NW" and it is equal to "0" if the part is "W".

B.1.2.2 Scan line part coding

W-parts are not encoded. The coding of each NW-part is independent of the coding of other parts in the given scan line. In the NW-part the white and black runs alternate. The coding always begins with a white run. If the actual scan line begins with a black run then a white run length of zero will be sent. Run lengths are encoded using Table B.2. The last run of each NW-part is not encoded. Resulted coded run lengths (CRL) are sent directly one after another.

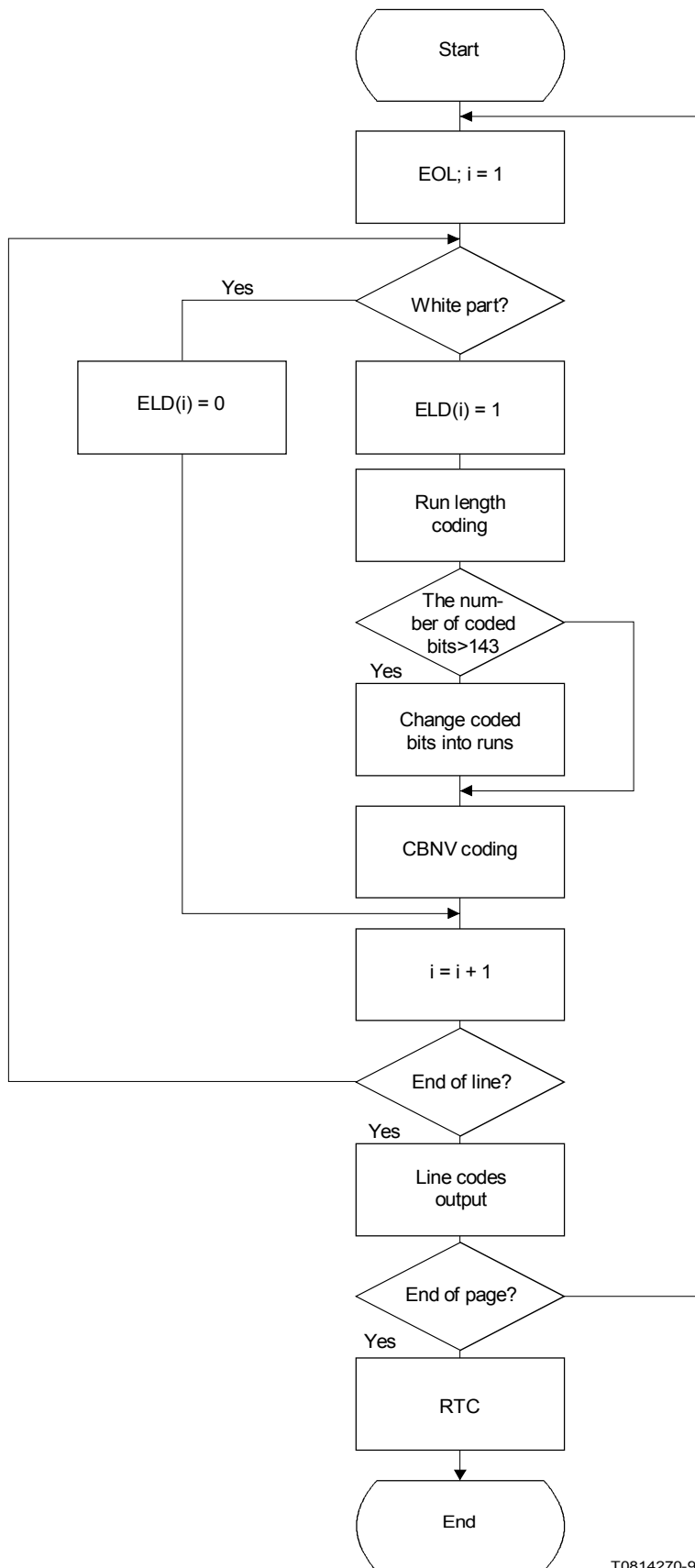

T0814270-93/d15

FIGURE B.1/T.4

B.1.2.3 Code bit number variation (CBNV)

It is necessary to code and send the number of coded bits for each NW-part. For this purpose the code bit number of the previous NW-part q_{i-1} is subtracted from the code bit number of the given NW-part q_i . The resulting difference $q_i - q_{i-1}$ is coded by using code words listed in Table B.1. For the first NW-part in a scan line q_0 is taken to be 40. In the code words given in Table B.1 the bit X corresponds to the sign of the difference $q_i - q_{i-1}$. When the difference is positive, bit X equals “0”, but when the difference is negative bit X equals “1”. If the sum q_i appears to be more than 143, run length encoding will be stopped and this part will be sent directly without coding and the value q_i is taken to be 144.

B.1.3 Data format

The data format for the scan line containing several NW-parts is shown in Figure B.2 and containing only one NW-part is shown in Figure B.3. The data format for the scan line containing all whites is shown in Figure B.4.

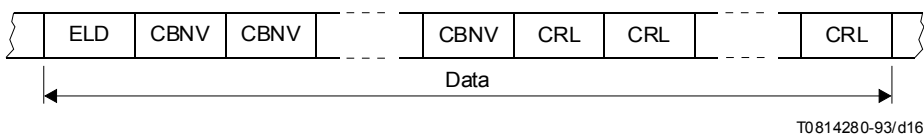

FIGURE B.2/T.4
Data format for the scan line containing several NW-parts

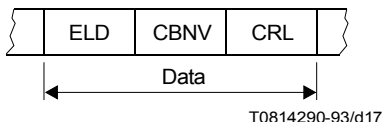

FIGURE B.3/T.4
Data format for the scan line containing one NW-part

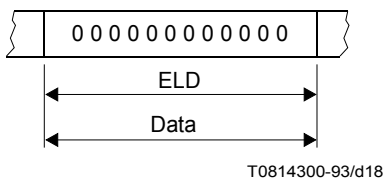

FIGURE B.4/T.4
Data format for the scan line containing 1728 white picture elements

TABLE B.1/T.4

Code table for the code bit number variation

| Absolute value of variation | Code | Absolute value of variation | Code |
|-----------------------------|---------------|-----------------------------|----------------------|
| 0 | 100000 | 51 | X11111 010101 |
| 1 | X00001 | 52 | X11111 010110 |
| 2 | X00010 | 53 | X11111 010111 |
| 3 | X00011 | 54 | X11111 011000 |
| 4 | X00100 | 55 | X11111 011001 |
| 5 | X00101 | 56 | X11111 011010 |
| 6 | X00110 | 57 | X11111 011011 |
| 7 | X00111 | 58 | X11111 011100 |
| 8 | X01000 | 59 | X11111 011101 |
| 9 | X01001 | 60 | X11111 011110 |
| 10 | X01010 | 61 | X11111 100000 |
| 11 | X01011 | 62 | X11111 100001 |
| 12 | X01100 | 63 | X11111 100010 |
| 13 | X01101 | 64 | X11111 100011 |
| 14 | X01110 | 65 | X11111 100100 |
| 15 | X01111 | 66 | X11111 100101 |
| 16 | X10000 | 67 | X11111 100110 |
| 17 | X10001 | 68 | X11111 100111 |
| 18 | X10010 | 69 | X11111 101000 |
| 19 | X10011 | 70 | X11111 101001 |
| 20 | X10100 | 71 | X11111 101010 |
| 21 | X10101 | 72 | X11111 101011 |
| 22 | X10110 | 73 | X11111 101100 |
| 23 | X10111 | 74 | X11111 101101 |
| 24 | X11000 | 75 | X11111 101110 |
| 25 | X11001 | 76 | X11111 101111 |
| 26 | X11010 | 77 | X11111 110000 |
| 27 | X11011 | 78 | X11111 110001 |
| 28 | X11100 | 79 | X11111 110010 |
| 29 | X11101 | 80 | X11111 110011 |
| 30 | X11110 | 81 | X11111 110100 |
| | | 82 | X11111 110101 |
| 31 | X11111 000001 | 83 | X11111 110110 |
| 32 | X11111 000010 | 84 | X11111 110111 |
| 33 | X11111 000011 | 85 | X11111 111000 |
| 34 | X11111 000100 | 86 | X11111 111001 |
| 35 | X11111 000101 | 87 | X11111 111010 |
| 36 | X11111 000110 | 88 | X11111 111011 |
| 37 | X11111 000111 | 89 | X11111 111100 |
| 38 | X11111 001000 | 90 | X11111 111101 |
| 39 | X11111 001001 | 91 | X11111 111110 |
| 40 | X11111 001010 | 92 | X11111 X11111 000001 |
| 41 | X11111 001011 | 93 | X11111 X11111 000010 |
| 42 | X11111 001100 | 94 | X11111 X11111 000011 |
| 43 | X11111 001101 | 95 | X11111 X11111 000100 |
| 44 | X11111 001110 | 96 | X11111 X11111 000101 |
| 45 | X11111 001111 | 97 | X11111 X11111 000110 |
| 46 | X11111 010000 | 98 | X11111 X11111 000111 |
| 47 | X11111 010001 | 99 | X11111 X11111 001000 |
| 48 | X11111 010010 | 100 | X11111 X11111 001001 |
| 49 | X11111 010011 | 101 | X11111 X11111 001010 |
| 50 | X11111 010100 | 102 | X11111 X11111 001011 |

TABLE B.1/T.4 (cont.)

Code table for the code bit number variation

| Absolute value of variation | Code | Absolute value of variation | Code |
|-----------------------------|----------------------|-----------------------------|----------------------|
| 103 | X11111 X11111 001100 | 119 | X11111 X11111 011100 |
| 104 | X11111 X11111 001101 | 120 | X11111 X11111 011101 |
| 105 | X11111 X11111 001110 | 121 | X11111 X11111 011110 |
| 106 | X11111 X11111 001111 | 122 | X11111 X11111 100000 |
| 107 | X11111 X11111 010000 | 123 | X11111 X11111 100001 |
| 108 | X11111 X11111 010001 | 124 | X11111 X11111 100010 |
| 109 | X11111 X11111 010010 | 125 | X11111 X11111 100011 |
| 110 | X11111 X11111 010011 | 126 | X11111 X11111 100100 |
| 111 | X11111 X11111 010100 | 127 | X11111 X11111 100101 |
| 112 | X11111 X11111 010101 | 128 | X11111 X11111 100110 |
| 113 | X11111 X11111 010110 | 129 | X11111 X11111 100111 |
| 114 | X11111 X11111 010111 | 130 | X11111 X11111 101000 |
| 115 | X11111 X11111 011000 | 131 | X11111 X11111 101001 |
| 116 | X11111 X11111 011001 | 132 | X11111 X11111 101010 |
| 117 | X11111 X11111 011010 | 133 | X11111 X11111 101011 |
| 118 | X11111 X11111 011011 | 134 | X11111 X11111 101100 |
| | | 135 | X11111 X11111 101101 |
| | | 136 | X11111 X11111 101110 |
| | | 137 | X11111 X11111 101111 |
| | | 138 | X11111 X11111 110000 |
| | | 139 | X11111 X11111 110001 |
| | | 140 | X11111 X11111 110010 |

NOTE – Bit X corresponds to the sign of the variation.

B.2 End of line (EOL)

This code word follows each line of data. There is a slight probability of occurrence of the same bit combination for ELD and the code word EOL. This should be taken account in the decoding algorithm. In addition, EOL is sent prior to the format data line of the page.

Format: 000000000001

B.3 Fill

A pause in the message may be filled as described in 4.1.3.

B.4 Return to control (RTC)

The return to control should comply with 4.1.4.

NOTE – When decoding, the correction of the corrupted parts can be performed by replacing the corrupted part with the corresponding uncorrupted part from the previous line. The exceeding of the value 144 by the decoded part length or the absence of code word of the given part in the code table vocabulary can be shown as a sign for replacement (see Table B.2).

TABLE B.2/T.4

| White run lengths | Code | Black run lengths | Code |
|-------------------|-----------|-------------------|---------------|
| 0 | 0100 | 0 | – |
| 1 | 1000 | 1 | 01111 |
| 2 | 1010 | 2 | 001 |
| 3 | 0110 | 3 | 100 |
| 4 | 1110 | 4 | 11 |
| 5 | 1100 | 5 | 010 |
| 6 | 1111 | 6 | 1010 |
| 7 | 00100 | 7 | 0110 |
| 8 | 10010 | 8 | 10111 |
| 9 | 11010 | 9 | 10110 |
| 10 | 10110 | 10 | 01110 |
| 11 | 000110 | 11 | 00010 |
| 12 | 110110 | 12 | 000110 |
| 13 | 000100 | 13 | 000111 |
| 14 | 011100 | 14 | 000010 |
| 15 | 010100 | 15 | 0000110 |
| 16 | 001100 | 16 | 00000100 |
| 17 | 100110 | 17 | 00000110 |
| 18 | 0000100 | 18 | 000011100 |
| 19 | 0000001 | 19 | 000011110 |
| 20 | 0010100 | 20 | 000001010 |
| 21 | 0011111 | 21 | 0000001000 |
| 22 | 0011110 | 22 | 0000011100 |
| 23 | 0011100 | 23 | 0000111010 |
| 24 | 0101100 | 24 | 00001111110 |
| 25 | 0111111 | 25 | 00001111100 |
| 26 | 0111110 | 26 | 00001111111 |
| 27 | 0111100 | 27 | 00001110110 |
| 28 | 1001110 | 28 | 00000011000 |
| 29 | 1011111 | 29 | 00000111100 |
| 30 | 1011110 | 30 | 00000101100 |
| 31 | 1011101 | 31 | 00001111101 |
| 32 | 1011100 | 32 | 00001110111 |
| 33 | 1101111 | 33 | 000000101000 |
| 34 | 1101110 | 34 | 000001111100 |
| 35 | 0001111 | 35 | 000001110100 |
| 36 | 0001110 | 36 | 000001011100 |
| 37 | 00010100 | 37 | 000000111100 |
| 38 | 10011110 | 38 | 000000110100 |
| 39 | 10011111 | 39 | 000000101100 |
| 40 | 01110100 | 40 | 000000111000 |
| 41 | 01110101 | 41 | 0000001001000 |
| 42 | 01110110 | 42 | 0000011111111 |
| 43 | 01110111 | 43 | 0000011111110 |
| 44 | 01111010 | 44 | 0000011111101 |
| 45 | 01111011 | 45 | 0000011111100 |
| 46 | 01010100 | 46 | 0000011111011 |
| 47 | 01010101 | 47 | 0000011111010 |
| 48 | 01010110 | 48 | 0000011110111 |
| 49 | 01010111 | 49 | 0000011110110 |
| 50 | 01011010 | 50 | 0000011110101 |
| 51 | 01011011 | 51 | 0000011110100 |
| 52 | 01011100 | 52 | 0000011101111 |
| 53 | 01011110 | 53 | 0000011101110 |
| 54 | 00110100 | 54 | 0000011101101 |
| 55 | 00101100 | 55 | 0000011101100 |
| 56 | 00001100 | 56 | 0000011101011 |
| 57 | 00000100 | 57 | 0000011101010 |
| 58 | 00000101 | 58 | 0000010111111 |
| 59 | 00000110 | 59 | 0000010111110 |
| 60 | 00000111 | 60 | 0000010111101 |
| 61 | 000101100 | 61 | 0000010111100 |
| 62 | 010111010 | 62 | 0000010111011 |
| 63 | 010111011 | 63 | 0000010111010 |
| 64 | 010111110 | 64 | 0000010110111 |
| 65 | 010111111 | 65 | 0000010110110 |

TABLE B.2/T.4 (cont.)

| White run lengths | Code | Black run lengths | Code |
|-------------------|-------------|-------------------|----------------|
| 66 | 001101010 | 66 | 0000010110101 |
| 67 | 001101011 | 67 | 0000010110100 |
| 68 | 001101100 | 68 | 0000001111100 |
| 69 | 001101101 | 69 | 0000001110100 |
| 70 | 001110100 | 70 | 0000001101100 |
| 71 | 001010100 | 71 | 0000001011100 |
| 72 | 001011100 | 72 | 0000001010100 |
| 73 | 000010100 | 73 | 00000011111111 |
| 74 | 000011100 | 74 | 00000011111110 |
| 75 | 001010101 | 75 | 00000011111101 |
| 76 | 0000111100 | 76 | 00000011111100 |
| 77 | 0000110100 | 77 | 00000011111011 |
| 78 | 0000101100 | 78 | 00000011111010 |
| 79 | 0010111111 | 79 | 00000011110111 |
| 80 | 0010111110 | 80 | 00000011110110 |
| 81 | 0010111101 | 81 | 00000011110101 |
| 82 | 0010111100 | 82 | 00000011110100 |
| 83 | 0010111011 | 83 | 00000011101111 |
| 84 | 0010111010 | 84 | 00000011101110 |
| 85 | 0010110111 | 85 | 00000011101101 |
| 86 | 0010110110 | 86 | 00000011101100 |
| 87 | 0010110101 | 87 | 00000011101011 |
| 88 | 0010110100 | 88 | 00000011101010 |
| 89 | 0010101111 | 89 | 00000011011111 |
| 90 | 0010101110 | 90 | 00000011011110 |
| 91 | 0010101101 | 91 | 00000011011101 |
| 92 | 0010101100 | 92 | 00000011011100 |
| 93 | 0011101111 | 93 | 00000011011011 |
| 94 | 0011101110 | 94 | 00000011011010 |
| 95 | 0011101101 | 95 | 00000011010111 |
| 96 | 0011101100 | 96 | 00000011010110 |
| 97 | 0011101011 | 97 | 00000011010101 |
| 98 | 0011101010 | 98 | 00000011010100 |
| 99 | 0011011111 | 99 | 00000010111111 |
| 100 | 0011011110 | 100 | 00000010111110 |
| 101 | 0011011101 | 101 | 00000010111101 |
| 102 | 0011011100 | 102 | 00000010111100 |
| 103 | 0001011100 | 103 | 00000010111011 |
| 104 | 0001010100 | 104 | 00000010111010 |
| 105 | 0001010101 | 105 | 00000010101111 |
| 106 | 0001010110 | 106 | 00000010101110 |
| 107 | 00010101111 | 107 | 00000010101101 |
| 108 | 00010101110 | 108 | 00000010101100 |
| 109 | 00010110101 | 109 | 00000010101011 |
| 110 | 00010110100 | 110 | 00000010101010 |
| 111 | 00010110111 | 111 | 00000010110111 |
| 112 | 00010110110 | 112 | 00000010110110 |
| 113 | 00010111011 | 113 | 00000010110101 |
| 114 | 00010111010 | 114 | 00000010110100 |
| 115 | 00010111101 | 115 | 00000010011111 |
| 116 | 00010111100 | 116 | 00000010011110 |
| 117 | 00010111111 | 117 | 00000010011101 |
| 118 | 00010111110 | 118 | 00000010011100 |
| 119 | 00001010101 | 119 | 00000010011011 |
| 120 | 00001010100 | 120 | 00000010011010 |
| 121 | 00001010111 | 121 | 00000010011001 |
| 122 | 00001010110 | 122 | 00000010011000 |
| 123 | 00001011011 | 123 | 00000010010111 |
| 124 | 00001011010 | 124 | 00000010010110 |
| 125 | 00001011101 | 125 | 00000010010101 |
| 126 | 00001011100 | 126 | 00000010010100 |
| 127 | 00001011111 | 127 | 00000011001111 |
| 128 | 00001011110 | 128 | 00000011001110 |
| 129 | 00001101011 | 129 | 00000011001101 |
| 130 | 00001101010 | 130 | 00000011001100 |
| 131 | 00001101101 | 131 | 00000011001011 |

TABLE B.2/T.4 (cont.)

| White run lengths | Code | Black run lengths | Code |
|-------------------|-------------|-------------------|----------------|
| 132 | 00001101100 | 132 | 00000011001010 |
| 133 | 00001101111 | 133 | 00000011001001 |
| 134 | 00001101110 | 134 | 00000011001000 |
| 135 | 00001110101 | 135 | 00000011100111 |
| 136 | 00001110100 | 136 | 00000011100110 |
| 137 | 00001110111 | 137 | 00000011100101 |
| 138 | 00001110110 | 138 | 00000011100100 |
| 139 | 00001111011 | 139 | 00000010100111 |
| 140 | 00001111010 | 140 | 00000010100110 |
| 141 | 00001111101 | 141 | 00000010100101 |
| 142 | 00001111100 | 142 | 00000010100100 |
| 143 | 00001111111 | 143 | 00000010010011 |
| 144 | 00001111110 | 144 | 00000010010010 |

Annex C

Optional file transfer for group 3

(This annex forms an integral part of this Recommendation)

C.1 Introduction

This annex specifies the technical features of the file transfer for group 3.

File transfer is an optional feature of group 3 which permits to transmit any data file with or without additional information concerning the file to be transmitted.

The content of the data file itself may be of any kind of coding.

The file transfer applied to group 3 equipments is based on Recommendation T.30 and on Annex A (Error correction mode).

Because files must be reliably transferred, using error correction mode described in Annex A and in Annex A/T.30 is mandatory in the context of Annex C.

From the point of view of service, file transfer is defined in Recommendation F.551 where alignment between different telematic applications (group 3, group 4, teletex) is achieved.

C.2 Definitions

The definitions contained in this Recommendation and in Recommendation T.30 apply unless explicitly amended.

C.3 Normative references

In addition to this Recommendation and Recommendation T.30, the present annex contains references to other CCITT and ISO Standards:

- [1] CCITT Recommendation T.50 International Alphabet No. 5
- [2] CCITT Recommendation X.209 Specification of basic encoding rules for Abstract Syntax Notation One (ASN.1)
- [3] CCITT Recommendation T.434 Binary file transfer protocol for the telematic services
- [4] ISO/IEC 9735 Electronic data interchange for administration commerce and transport (EDIFACT) – Application level syntax rules

- [5] CCITT Recommendation F.551 Service Recommendation for telematic file transfer within telefax 3, telefax 4, teletex services and message handling services.
- [6] CCITT Recommendation T.51 Coded characters sets for telematic services
- [7] ISO 8859-1 Information processing – 8 bit single byte coded graphic character sets – Part 1: Latin Alphabet No. 5

C.4 Definition of the different file transfer modes

At the time being, four file transfer modes exist:

- basic transfer mode: (BTM),
- document transfer mode: (DTM),
- binary file transfer: (BFT),
- EDIFACT transfer: (EDI).

For a comprehensive explanation, from the point of view of service, of the use of these four different file transfer modes, see Recommendation F.551 [5].

Additional file transfer modes besides these four modes may be issued in further versions of this Recommendation and Recommendation T.30.

C.4.1 Basic transfer mode (BTM)

Basic transfer mode provides the user of a group 3 equipment with a means to exchange files of any kind (binary files, wordprocessor native format documents, bitmaps, etc.) without any additional information.

C.4.2 Document transfer mode (DTM)

Document transfer mode provides the user of a group 3 equipment with a means to exchange files of any kind with additional information readable by the user and included in a file description.

The file description is a structured information regarding the file (e.g. file name, file type, file coding, etc.). On the receiving side, it can either be handled by automatic processing or read by the user.

The file description is transmitted ahead of the data file itself and concatenated with this latter.

C.4.3 Binary file transfer (BFT)

Binary file transfer provides the user of a group 3 equipment with a means to exchange files of any kind with additional information included in a file description and automatically processed at the receiving side.

The file description is a structured document which contains information regarding the file (e.g. file name, contents types, etc.). It is mainly aimed to be automatically processed at the receiving side.

The coding rules which apply for the coding of the file description are technically aligned on those of FTAM (coding according to Recommendation X.209 [2]).

The file description is transmitted ahead of the data file itself and concatenated with this latter.

For technical description of the binary file transfer, see Recommendation T.434 [3] and Annex B/Appendix VI/T.30.

C.4.4 EDIFACT transfer

EDIFACT transfer provides the user of a group 3 equipment with a means to exchange EDIFACT files coded according to ISO/IEC 9735 [4] rules.

C.5 Coding of the file description

C.5.1 Basic transfer mode (BTM)

BTM mode does not require to transmit any additional information. Then, no file description exists. Only the file itself is sent.

C.5.2 Document transfer mode (DTM)

The character set which shall be used to code the file description is the primary set of graphic characters of Recommendation T.51 [6] plus character "SPACE" (this later in position 2/0 of the table).

NOTE – This set is exactly the same one as that of International Alphabet No. 5 (Recommendation T.50 [1]) and that of the left part of characters set ISO 8859-1 (7).

Coding of the file description sent by a group 3 equipment

For details of the utility of the different fields of the file description listed below, see Recommendation F.551 [5].

| | | | | |
|-------|-----|----------------------------|-------------------------|-------------------------|
| CR FF | 6.1 | : ADDITIONAL INFORMATION : | | |
| CR LF | 1 | : FILE NAME : | | |
| CR LF | | | [file name] | (72 characters maximum) |
| CR LF | 2 | : APPLICATION REFERENCE : | | |
| CR LF | | | [application reference] | (72 characters maximum) |
| CR LF | 3 | : TYPE : | | |
| CR LF | | | [coding] | (72 characters maximum) |
| CR LF | 4 | : ENVIRONMENT : | | |
| CR LF | 4.1 | : MACHINE : | | |
| CR LF | | | [machine] | (72 characters maximum) |
| CR LF | 4.2 | : OPERATING SYSTEM : | | |
| CR LF | | | [operating system] | (72 characters maximum) |
| CR LF | 4.3 | : PROGRAM : | | |
| CR LF | | | [program] | (72 characters maximum) |
| CR LF | 4.4 | : CHARACTER SET : | | |
| CR LF | | | [machine character set] | (72 characters maximum) |
| CR LF | 5 | : LAST REVISION : | | |
| CR LF | | | [last revision] | (72 characters maximum) |
| CR LF | 6 | : LENGTH : | | |
| CR LF | | | [file length] | (72 characters maximum) |
| CR LF | 7 | : PATH : | | |
| CR LF | | | [path name] | (72 characters maximum) |
| CR LF | 8 | : RESERVED : | | |

| | | | |
|-------|----|-----------------------------------|---|
| CR LF | | [reserved] | (72 characters maximum) |
| CR LF | 9 | : AUTHOR'S NAME : | |
| CR LF | | [author 's name] | (72 characters maximum) |
| CR LF | 10 | : USER VISIBLE STRING : | |
| CR LF | | [[user 's comments]] | (8 lines, 72 characters maximum per line) |
| CR LF | 11 | : FUTUR FILE LENGTH : | |
| CR LF | | [futur file length] | (72 characters maximum) |
| CR LF | 12 | : STRUCTURE : | |
| CR LF | | [structure] | (72 characters maximum) |
| CR LF | 13 | : PERMITTED ACTIONS : | |
| CR LF | | [permitted actions] | (72 characters maximum) |
| CR LF | 14 | : LEGAL QUALIFICATIONS : | |
| CR LF | | [legal qualification] | (72 characters maximum) |
| CR LF | 15 | : CREATION : | |
| CR LF | | [date and time of creation] | (72 characters maximum) |
| CR LF | 16 | : LAST READ ACCESS : | |
| CR-LF | | [last read access] | (72 characters maximum) |
| CR LF | 17 | : IDENTITY OF THE LAST MODIFIER : | |
| CR LF | | [identity of the last modifier] | (72 characters maximum) |
| CR LF | 18 | : IDENTITY OF THE LAST READER : | |
| CR LF | | [identity of the last reader] | (72 characters maximum) |
| CR LF | 19 | : RECIPIENT : | |
| CR LF | | [recipient] | (72 characters maximum) |
| CR LF | 20 | : TFT VERSION : | |
| CR LF | | [TFT version] | (72 characters maximum) |
| CR LF | 21 | : COMPRESSED : | |
| CR LF | | [compression] | (72 characters maximum) |
| CR LF | | | |

NOTES

1 When only one [] is used, this element is included in one line. When [[]] is used, this element can be included in several lines.

2 Further additional information fields may be added in next versions of Annex C. An equipment shall not be disturbed by unknown fields.

3 The file description must contain at least the following information:

CR LF 6.1 : ADDITIONAL INFORMATION :

CR LF 1 : FILE NAME :

CR LF [file name] (72 characters maximum)

CR LF

CR LF

C.5.3 Binary file transfer (BFT)

The structure of the additional information to be transmitted is described in Recommendation T.434 [3].

C.5.4 EDIFACT transfer

To transfer EDIFACT files there is no need for a file description.

The structure of the information to be transmitted is described in the ISO/IEC 9735 specification [4].

C.6 Message format – Blocks structure

The structure of the data block sent by means of error correction mode is the same structure as when T.4 facsimile coded data is sent (see description in Annex A), except for the last block (see further).

The sequence of octets is transmitted beginning with the least significant bit of the first octet.

As normally, the sending equipment indicates the frame size by the DCS frame content (see Table 2/T.30). The values of frame size applicable are 256 or 64 octets.

At the end of the transmission of a file, the sending equipment may send a block the size of which is less than 256 frames. This block is called a short block.

This short block may have its last frame less than 256 or 64 octets.

Within the T.4 code exists an “end of page” (codeword RTC) which permits to delineate the pads bits which are usually inserted at the end of the last frame of the last block to match, either an octet boundary or the frame limit (see A.3.6.2).

As for file transfer such a general “end of page” codeword cannot exist because files may be of different kinds, the last frame of the short block shall contain no pad bit.

Hence, a sender must be able to send the last frame containing less than 256 or 64 data octets.

Figure C.1 represents the structure of the short block.

C.7 Protocol aspects

C.7.1 Abbreviations

The abbreviations contained in Recommendation T.30 and used in this annex are:

| | |
|----------|---|
| DCS | Digital command signal |
| DIS | Digital identification signal |
| DTC | Digital transmit command |
| PPS-EOM | Partial page signal – End of message |
| PPS-EOP | Partial page signal – End of procedure |
| PPS-MPS | Partial page signal – Multi page signal |
| PPS-NULL | Partial page boundary signal |

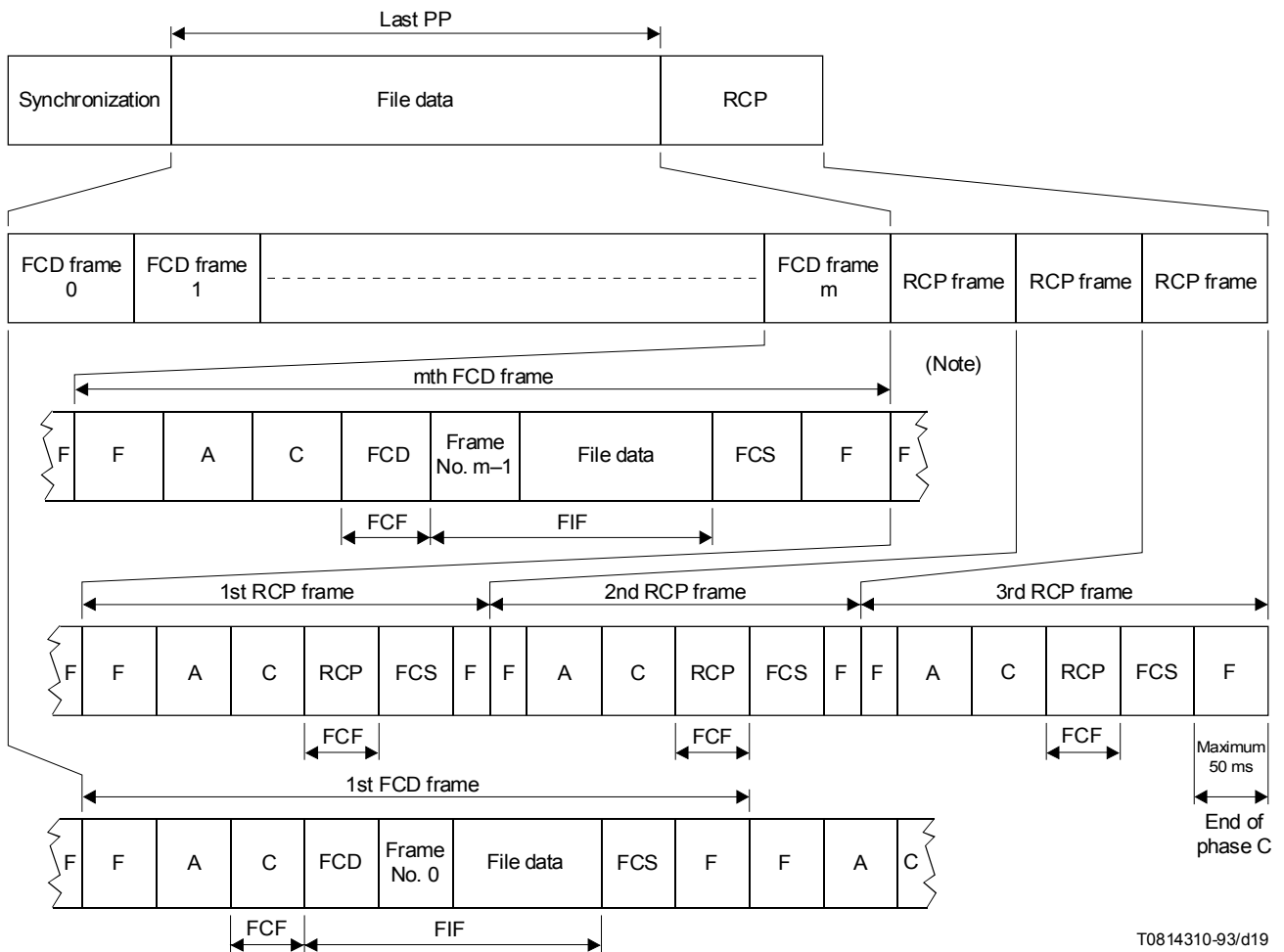

T0814310-93/d19

NOTE – See A.3.2.

FIGURE C.1/T.4
Last block frame structure

C.7.2 Phase B of T.30 (Pre-message procedure)

Group 3 equipment negotiates a file transfer mode among the above mentioned modes (BTM, DTM, BFT, EDIFACT) by using the usual DIS/DTC/DCS frames of T.30 protocol.

The facsimile information field of the frames DIS/DTC/DCS contains specific bits for the file transfer modes, see bits allocation in Table 2/T.30.

NOTE – The use of facsimile service info file (FSI) is for further study.

C.7.3 Specific application rules of T.30 protocol

This subclause is not applicable to binary file transfer. For precisions about specific application rules of T.30 protocol to BFT, see Annex B/Appendix VI/T.30.

Specific application rules of T.30 protocol concerning T.30 post-message commands exist for file transfer:

- Procedure interrupt post-message commands (PPS-PRI-Q) shall not be used.
- As files must be entirely transmitted, EOR-Q signals are not allowed. When the transmitter receives PPR four times, the modem speed must fall back (by use of CTC command) or the group 3 equipment has to switch to phase E (emission of DCN and call release). In case of failure, the file must be retransmitted as a whole.

Other post-message commands have largely their usual purpose as described in Annex A/T.30 (error correction mode):

- PPS-NULL commands are used normally to separate intermediate error correction mode blocks.
- Page boundary indications PPS-MPS commands are used in place of PPS-NULL commands at the end of intermediate files if several files are to be transmitted in the same communication.
- PPS-EOP command is sent at the end of the last block of the last file to be transmitted.
- PPS-EOM commands are sent at the end of intermediate files if several files are to be transmitted in the same communication and a change in the mode of the communication is desired.

Annex D

Optional character mode of group 3

(This annex forms an integral part of this Recommendation)

D.1 Introduction

This annex specifies the technical features of the character mode of group 3.

Character mode is an optional feature of group 3 which permits to transmit character coded documents by the means of T.30 protocol.

Character mode is based on Recommendation T.30 and on Annex A (Error correction mode).

Because character coded documents must be reliably transferred, using error correction mode described in Annex A and in Annex A/T.30 is mandatory in the context of this annex.

D.2 Definitions

The definitions contained in this Recommendation and in Recommendation T.30 apply, unless explicitly amended.

D.3 Normative references

In addition to this Recommendation and Recommendation T.30, this annex contains references to other CCITT and ISO Standards:

- CCITT Recommendation T.51 *Coded characters sets for telematic services*
- CCITT Recommendation T.61 *Character repertoire and coded character sets for the international Teletex service*
- ISO 8859-1 *Information processing – 8 bit single byte coded graphic character sets – Part 1 : Latin Alphabet No. 5*

D.4 Graphic character set – Repertoire and coding

D.4.1 Repertoire of graphic characters

The character repertoire which represents and describes the graphic characters allowed for character mode is that of ISO 8859-1 in addition with the box-drawing character repertoire which is a subset of registered CCITT set ISO 72.

From the character mode of group 3 apparatus, the following character positions are excluded: 4/4...4/11, 4/13...4/15, 5/11...5/14, 6/0...6/13, 7/0...7/15.

A group 3 equipment providing character mode shall not send any graphic character which is neither contained in repertoire ISO 8859-1 nor the box-drawing character repertoire.

Taking into account other graphic characters (e.g. national graphic characters) is for further study.

D.4.2 Coding of graphic characters

The coding of the graphic characters is not that of the code table given in ISO 8859-1; it shall follow the coding rules of Recommendation T.51.

The graphic characters are coded by bytes (8-bits environment of Recommendation T.51).

The left part of the table (bytes “0/0” to “7/15”) is fixed as the primary set of Recommendation T.51 (see Figure 1/T.51). That is fixed **by default**, then designation and invocation sequences as defined in Recommendation T.51 shall not be used prior to the transmission of these characters.

The “SPACE” character is coded “2/0”.

The right part of the table (bytes “8/0” to “15/15”) is fixed as the supplementary set of Recommendation T.51 (see Figure 2/T.51). That is fixed **by default**, then designation and invocation sequences as defined in Recommendation T.51 shall not be used prior to the transmission of these characters.

To be coded, some graphic characters represented in ISO 8859-1 need two bytes of the 8-bits code table specified above. For example, diacritical characters require two bytes : the diacritical mark followed by the basic character.

For using a box-drawing character, a single shift function SS2 is necessary prior to the 8 bits-code of the character itself. Then, each box-drawing character needs two octets for the transmission : SS2 followed by the character code.

SS2 is the “single shift two function” as described in Recommendation T.51. It is coded : “1/9”.

Then, following the T.51 rules, box-drawing character repertoire is the graphic character set “G2”.

This repertoire is fixed as G2 **by default**, then the designation sequence as defined in Recommendation T.51 shall not be used.

D.4.3 Fall-back in case of a graphic character of repertoire ISO 8859-1 not supported

When a character from repertoire ISO 8859-1 or from the box-drawing character repertoire is received by a group 3 equipment which does not support it, a fall-back behaviour is required in order that the reception of the document can go on.

The fall-back behaviour may be the following:

- upon reception of a diacritical character not supported, the receiver considers it as a basic character and discards the diacritical mark;
- upon reception of a basic character not supported, the receiver considers it as another basic character.

D.5 Page format

The character coded pages have their format fixed:

- Vertical basic format with **55 lines of 77 characters**.

NOTES

- 1 55 lines per page permit to print the text received at 6 LPI (lines per inch).
- 2 55 lines are the maximum length of a page. Shorter pages are permitted.
- 3 Different page formats are for further study.

D.6 Control functions

Control functions act on the formatting of the document (go to next line, etc.) and permit to switch on or to switch off character attributes.

Some control functions are represented with a unique byte; some others (with parameters) are represented by a sequence beginning by CSI (“9/11”).

If the receiving equipment receives a control function it cannot handle, it must simply ignore it and proceed normally.

If the receiving equipment receives a control function it can handle but the parameters which are unknown to it, it must also simply ignore the request.

NOTE – It is the responsibility of the sender to provide for correct sending format. If the sending equipment is providing an incorrect format, that will not necessarily be rejected by the receiving equipment, but the results of that cannot be predicted.

D.6.1 Single byte control functions applicable to character mode

The single byte control functions (coded by a single byte) applicable to character mode are:

| | |
|------------------------------------|------|
| LF : Line feed : | 0/10 |
| FF : Form feed : | 0/12 |
| CR : Carriage Return : | 0/13 |
| HT : Horizontal Tabulation : | 0/9 |
| SS2 : Single Shift two : | 1/9 |
| CSI : Control Sequence Introduce : | 9/11 |

Escape sequences (beginning by the control character “ESC”) shall not be emitted by a group 3 equipment.

NOTES

- 1 Other single byte control functions are for further study.
- 2 Coding values of LF, FF, CR, SS2 and CSI are in line with Recommendation T.61.

D.6.2 Control functions with parameters applicable to character mode

The character mode implements some control functions with parameters which are described further in this annex.

Control functions with parameters consist of control sequences beginning by control sequence introducer (CSI) and followed by one or several bytes.

NOTE – The rules of coding of control functions within this annex are in line with Annex D/T.61.

D.6.3 Control functions for format effectors

D.6.3.1 Page initiator

The “page initiator” shall be used at the beginning of each page.

Coding: CR FF (0/13 0/12)

D.6.3.2 End of line

The “end of line” shall be used at the end of each line, except for the last line of the last character coded page.

Coding : CR LF (0/13 0/10)

NOTE – “End of line” permits to send lines which contain less than 77 characters.

D.6.3.3 End of the last character coded page

The “end of the last character coded page” shall be used at the end of the last character coded page.

Coding : CR FF (0/13 0/12)

D.6.3.4 Horizontal tabulation

Horizontal tabulation moves the active position to the next horizontal tabulation stop. The horizontal tabulation stops are defined in fixed steps of 5 characters, the first one being at the fifth character of the line.

D.6.4 Control functions for characters attributes

Characters attributes permit to modify the rendition of the characters.

The graphic rendition is selected by the control function SGR.

Coding : CSI 3/X 6/13 (9/11 3/X 6/13),

X depends on the attribute, (see Table D.1).

The effect follows immediately the function and is cancelled by a new SGR function or by a page initiator.

The character attributes are not negotiated. If they are not supported at the receiving side, a fall-back behaviour is required (attribute ignored).

TABLE D.1/T.4

| Character attribute | Coding | Availability |
|-----------------------------|--------------|--------------|
| Default rendition | CSI 3/0 6/13 | Optional |
| Bold intensity | CSI 3/1 6/13 | Optional |
| Italicized | CSI 3/3 6/13 | Optional |
| Singly underlined character | CSI 3/4 6/13 | Optional |

D.7 Message format – Blocks structure

The structure of the block of data sent by means of error correction mode is the same structure as when T.4 facsimile data is sent (see description in Annex A), except for the last block (see further).

A sequence of octets is transmitted beginning with the least significant bit of the first octet.

As normally, the sending equipment indicates the frame size by the DCS frame content (see Table 2/T.30). The values of frame size applicable are 256 or 64.

At the end of the transmission of a page, the sending equipment may send a block the size of which is less than 256 frames. This block is called a short block.

This short block may have its last frame less than 256 (or 64 octets). Within this last frame, pad bytes may be used to align frame boundary.

The format is a variable sequence of octets “0/0”.

These pad bytes are inserted between the last “end of line” of the document and the end of the frame (same principle as for T.4 data where pad bits may be inserted after RTC code).

The receiver must be able to receive pad bytes and to discard them.

Figure D.1 represents the structure of the short block.

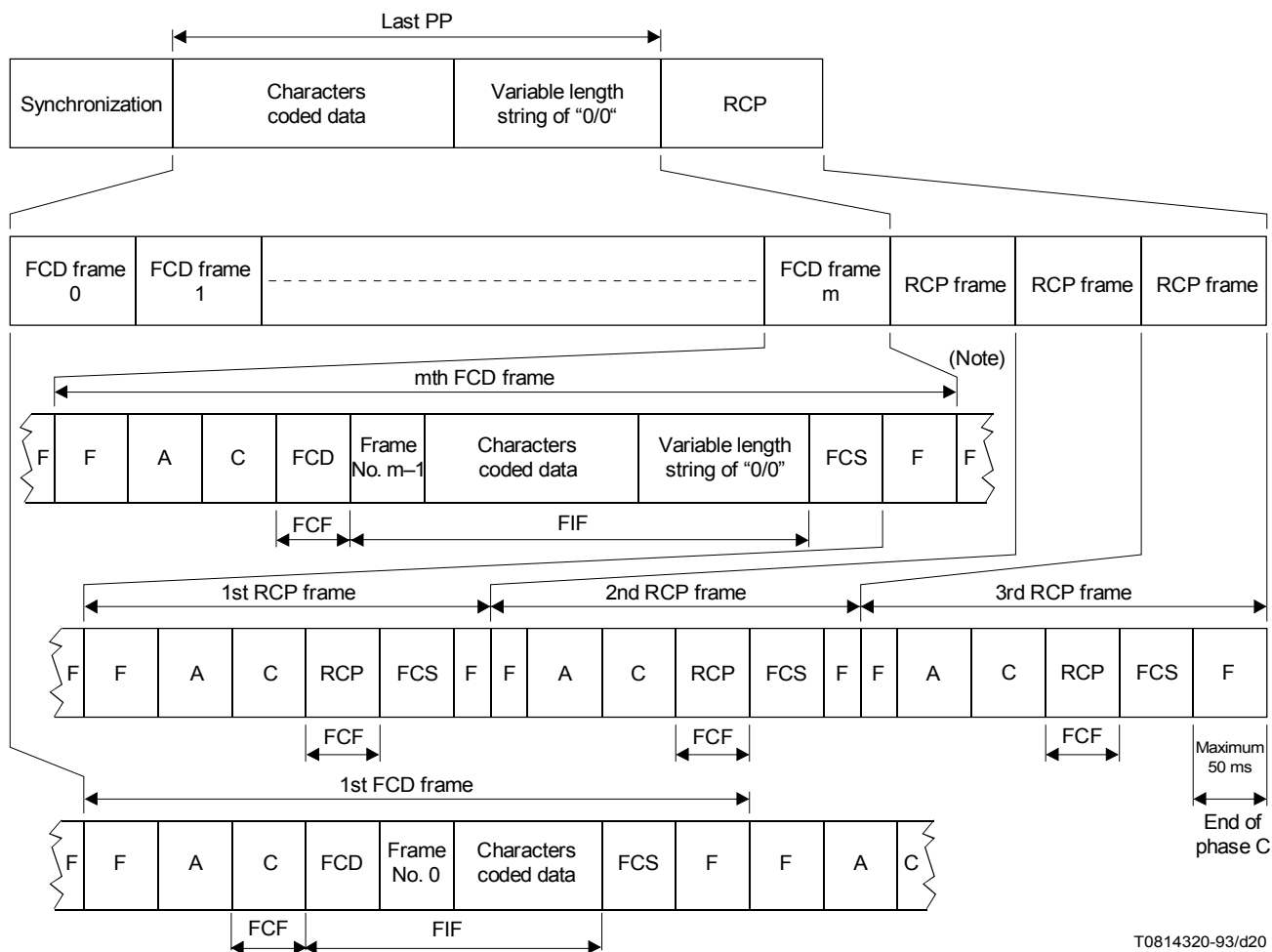

T0814320-93/d20

NOTE – See A.3.2.

FIGURE D.1/T.4
Last block frame structure

D.8 Protocol aspects

D.8.1 Abbreviations

The abbreviations contained in Recommendation T.30 and used in this annex are:

| | |
|----------|---|
| DCS | Digital command signal |
| DIS | Digital identification signal |
| DTC | Digital transmit command |
| PPS-EOM | Partial page signal – end of message |
| PPS-EOP | Partial page signal – end of procedure |
| PPS-MPS | Partial page signal – multi page signal |
| PPS-NULL | Partial page boundary signal |
| EOR | End of retransmission |

D.8.2 Phase B of Recommendation T.30 (Pre-message procedure)

Group 3 equipment negotiates the character mode by using the usual DIS/DTC/DCS frames of T.30 protocol.

The facsimile information field of the frames DIS/DTC/DCS contains specific bits for the character mode. See bits allocation in Table 2/T.30.

NOTES

- 1 The use of control document to access facsimile enhanced service is for further study.
- 2 Future negotiation mechanism is for further study.

D.8.3 End of document, beginning of page, end of block

Post message commands have their usual purpose as described in Annex A/T.30 (error correction mode):

- PPS-NULL command is used normally to separate intermediate error correction modes blocks.
- PPS-MPS command is sent at the end of each page.
- In addition, the “page initiator” (see D.6.3.1) is present at the beginning of each page.
- PPS-EOP command is sent at the end of the last block of the characters coded document if no further document is to be transmitted.
- PPS-EOM command is sent at the end of intermediate characters coded document if several are to be transmitted in the same communication.

The use of end of retransmission (EOR) command defined in A.4.3/T.30, is not permitted with the character mode. If all frames have not been correctly received after the third transmission of the error frames, then the transmitter shall use the continue to correct (CTC) command (A.4.1/T.30).

D.9 Imaging process

The displaying of the coded characters is assumed to be from left to right.

The position of the first character line on the facsimile page is the 105th pel on the 131st scanning line. (at 3.85 lines/mm).

The size of the character box are 20 pels wide by 16 lines / mm high and concatenated across the page. Since no gap is provided between the boxes, implementations should ensure that when the characters are displayed, there is a separation between the characters.

Annex E

Optional mixed mode for group 3

(This annex forms an integral part of this Recommendation)

E.1 Introduction

This annex specifies the technical features of the optional mixed mode (MM) for group 3 facsimile apparatus.

MM allows pages containing both character coded and facsimile coded information to be transferred between compatible apparatus. The use of the standardized error correction mode defined in Annex A of this Recommendation and Annex A/T.30 is mandatory with MM.

With MM, the page is divided into slices horizontally across the page, each slice contains either facsimile or character coded information but not both.

The content of the information field is identified by means of the facsimile control field (see E.3). The first slice is either facsimile or character coded. Subsequent slices are alternatively character or facsimile coded.

E.2 Definitions

The definitions contained in this Recommendation and Recommendation T.30 apply unless explicitly amended by this annex.

E.3 Facsimile control field (FCF)

In order to distinguish between the facsimile coded data (FCD), the return to control for partial-page (RCP), and the character coded data (CCD) frames, the FCF for the in-message procedure is defined as follows:

- 1) FCF for the FCD frame
0110 0000
- 2) FCF for the RCP frame
0110 0001
- 3) FCF for the CCD frame
0110 0010

NOTE – The FCF code 0110 0100 is reserved for future use.

E.4 Frame numbering

The frames in each partial page are numbered sequentially from 0 to the maximum of 255 irrespective of whether the partial page consists of FCD and/or CCD frames.

Figure E.1 shows one example of FCD and CCD frames in a partial page.

At the end of each slice, facsimile coded data field length or character coded data field length may be less than 256 or 64 octets.

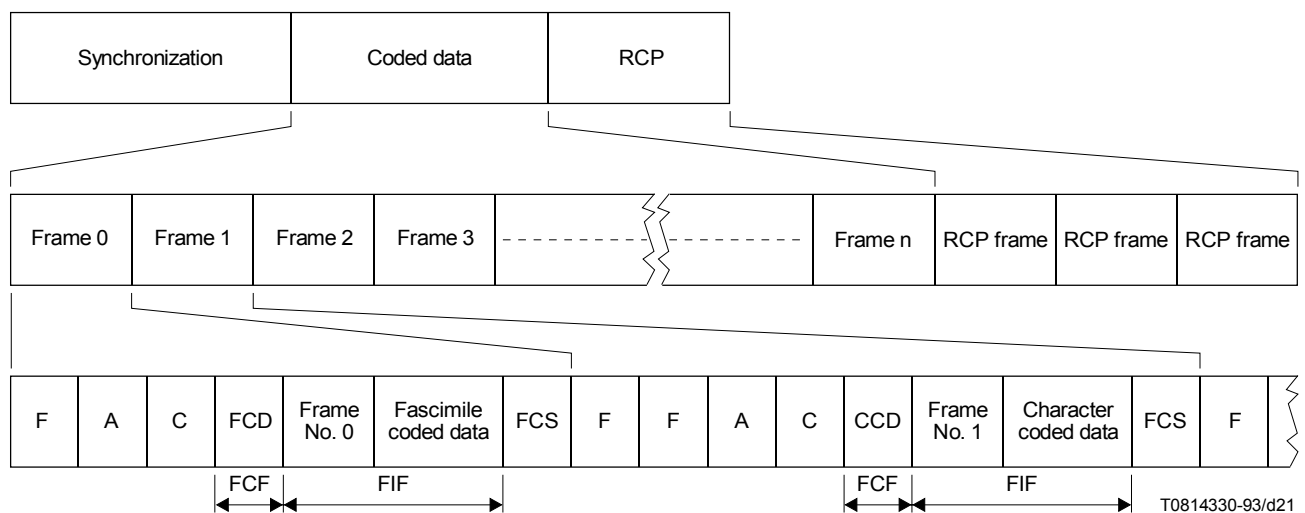

FIGURE E.1/T.4
Initial partial page frame structure

E.5 Facsimile data field

A.3.6.2 requirements apply.

“Facsimile slice terminator code” (FSTC) is defined as six times “EOL + 1”. FSTC is used at the end of each facsimile slice.

In case of T.6 coding, EOFB shall precede FSTC. Pad bits can be inserted after FSTC. Although this bit pattern is the same as that of RTC, this bit pattern shall be recognized as FSTC in case of MM.

E.6 Character coded data field

The character coded data field may be up to 256 octets.

D.7 requirements apply. “End of line (CR LF)” is used at the end of each character slice.

E.7 Graphic character set

The graphic character set used with MM is defined in D.4.

E.8 Page format

E.8.1 Facsimile coded slices

Facsimile coded slices must be transmitted as integral multiple of 16 scanning lines.

E.8.2 Character coded slices

Each character coded line is equivalent to 16 scanning lines (at standard resolution).

The width of each coded character is equivalent to 20 picture elements (at standard resolution).

To ensure printing on an A4 page, a maximum of 77 characters per line should be transmitted.

If the first slice on a page is character coded, the first six character lines may not be reproduced; therefore, it is recommended that the transmitter sends 6 combinations of CR-LF before the start of the information.

E.8.3 Page length

To ensure that the text can be reproduced on an A4 page, the total length of each page should not exceed 1024 scanning lines (at standard resolution). This means that the maximum length of a coded character slice is 64 character lines.

E.9 Control functions

The control functions used in MM are defined in D.6.

The “page initiator” is used only if the first slice of the page is character coded.

E.10 End of retransmission (EOR)

The use of the end of retransmission (EOR) command defined in A.4.3/T.30 is not permitted with MM. If all the frames have not been correctly received after the third transmission of the error frames, then the transmitter shall use the continue to correct (CTC) command (see A.4.1/T.30).

Annex F

64 kbit/s option of facsimile group 3 [G3 (UDI)]

(This annex forms an integral part of this Recommendation)

F.1 Introduction

This annex describes the terminal characteristics, protocol set and document application profile (DAP) used by 64kbit/s option of facsimile group 3 [G3 (UDI)] when operating over the integrated services digital network (ISDN).

F.2 Terminal characteristics for G3 (UDI)

F.2.1 Definitions

The clauses and annexes listed below shall not be applied.

| | |
|----------|--|
| Clause 3 | Transmission time per total coded scan line |
| Clause 5 | Modulation and demodulation |
| Clause 6 | Power at the transmitter |
| Clause 7 | Power at the receiver input |
| Annex A | Optional error correction mode |
| Annex B | Optional error limiting mode |
| Annex C | Interworking between equipments with A5/A6 and A4 facilities and between equipments with combinations of these facilities. |

F.2.2 Basic characteristics

Basic characteristics of G3 (UDI) are given in Table F.1.

Printing capability of the call identification line (CIL) is mandatory. Details of the CIL are covered in Recommendation T.563.

TABLE F.1/T.4

| | Values |
|---|--|
| Coding scheme | T.4 one-dimensional coding and T.6 coding |
| Paper size | ISO A4 |
| Pels / scan line length | 1728 pels/ 215 mm \pm 1% and/or 1728 pels/ 219.46 mm \pm 1% |
| Resolution in vertical direction | 3.85 line/mm \pm 1% and 200 pels/ 25.4 mm \pm 1% |
| NOTE – T.6 coding scheme, ISO A4 paper size, 1728 pels along a scale line length of 219.46 mm \pm 1% and the resolution of 200 pels 25.4 mm \pm 1% in vertical direction in this Table are basic characteristics of group 5 facsimile class 1. G3 (UDI) should be designed and operated as the terminal supporting the dual characteristics of group 3 facsimile and group 4 facsimile class 1. | |

F.2.3 Optional characteristics

Optional characteristics of G3 (UDI) are given in Table F.2.

F.3 Protocol set

The protocol set applied to the group 3 facsimile 64 kbit/s option is described in this clause.

TABLE F.2/T.4

| | Values |
|--|---|
| Coding scheme | T.4 two-dimensional coding |
| Paper size | ISO B4 ISO A3 |
| Pels/scan line length | 3456 pels/215 mm \pm 1% 2048 pels/255 mm \pm 1% 4096 pels/255 mm \pm 1% 2432 pels/303 mm \pm 1% 4864 pels/303 mm \pm 1% 2592 pels/219,46 mm \pm 1% 3456 pels/219,46 mm \pm 1% 2048 pels/260,10 mm \pm 1% 3072 pels/260,10 mm \pm 1% 4096 pels/260,10 mm \pm 1% 2432 pels/308,86 mm \pm 1% 3648 pels/308,86 mm \pm 1% 4864 pels/308,86 mm \pm 1% |
| Resolution in vertical direction | 7.7 line/mm \pm 1% 15.4 line/mm \pm 1% 300 pels/25.4 mm \pm 1% 400 pels/25.4 mm \pm 1% |
| NOTE – The resolutions of 200×200 pels/25.4 mm et $R8 \times 7.7$ lines/mm can be considered as being equivalent. Similarly, the resolutions of 400×400 pels/25.4 mm and $R16 \times 15.4$ lines/mm can be considered also as being equivalent. Consequently, conversion between mm based terminals and inch based terminals is not required for the communications in these cases. However, communication between these resolutions will cause the distortion and the reduction of reproducible area. | |

F.3.1 Application rules of low layer protocols

F.3.1.1 General

The group 3 facsimile apparatus with 64 kbit/s option shall be designed and operated according to Recommendation T.90 (1992) with the following application and implementation rules.

F.3.1.2 High layer compatibility (HLC)

HLC IE (information element), when encoded, shall be set to “group 4 facsimile class 1”. For further information, see 2.2.4./T.90.

Receipt of HLC IE set to “group 4 facsimile class 1” shall not cause the rejection of incoming call.

Interworking between group 3 facsimile 64 kbit/s option and group 4 facsimile class 1 is described in F 5.

The interoperability between facsimile terminals on the ISDN is for further study.

F.3.1.3 Clauses not to be referred in Recommendation T.90 (1992)

Recommendation T.90 (1992) clauses 7, 8 and 10 are not referred and out of the scope of this annex.

F.3.2 Application rules of high layer protocols

F.3.2.1 General

The group 3 facsimile apparatus with 64 kbit/s option shall be designed and operated according to the following CCITT Recommendations.

F.3.2.2 Transport layer

The transport end-to-end control procedure of group 3 facsimile 64 kbit/s option shall be in accordance with Recommendation T.70;

- Recommendation T.70 (1984) *Network-independent basic transport service for the telematic services*

F.3.2.3 Session layer

Session layer control procedure of group 3 facsimile 64 kbit/s option shall be in accordance with Recommendation T.62;

- Recommendation T.62 (1984) *Control procedures for teletex and group 4 facsimile services*

F.3.2.4 Communication application profile

Communication application profile of group 3 facsimile 64 kbit/s option shall be in accordance with Recommendation T.521;

- Recommendation T.521 (1992) *Communication application profile BTO for document bulk transfer based on the session service (according to the rules defined in T.62 bis)*

F.4 Basic procedure for the interchange of G3-64 kbit/s option facsimile document

This clause defines a document application profile that is in conformance with G3-64 kbit/s option facsimile.

F.4.1 Document architecture

The hierarchical structure of the document for G3-64 kbit/s option facsimile is illustrated in the figure below.

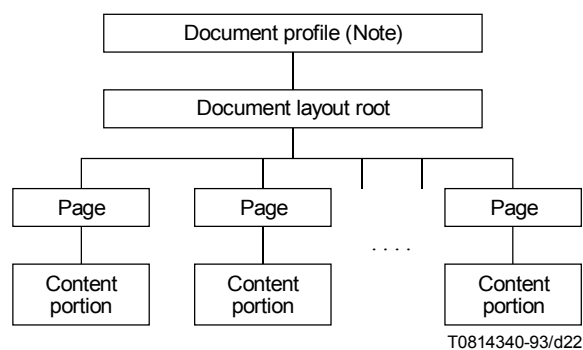

NOTE – Document profile is not transmitted. The responding terminal may re-generate the document profile descriptor based on the user data conveyed by SUD in CDS.

F.4.2 ASN.1 definition of user data conveyed by session PDU

Abstract syntax definition of APDUs conveyed by session PDU applicable to G3-64 kbit/s option facsimile and encoding examples are described in this subclause.

F.4.2.1 D-INITIATE request/response APDUs conveyed by SUD in CSS/RSSP

```
D-INITIATE-REQ/RESP ::= CHOICE {
    [4] IMPLICIT ApplicationCapabilities }
```

```
ApplicationCapabilities ::= SET {
    documentApplicationProfileT73 [0] IMPLICIT OCTET STRING,
        -- '02'H document application profile T.503
        -- '0204'H document application profile T.503 and G3-64k (see Note)
    documentArchitectureClass [1] IMPLICIT OCTET STRING,
        -- '00'H FDA
    }
```

NOTE – G3-64k shall set this value

Example (CSS) -----

```
A4 07 ApplicationCapabilities
80 02 0204 documentApplicationProfileT73 = T.503 and G3-64k
81 01 00 documentArchitectureClass = FDA
```

Example (RSSP) -----

```
A4 07 ApplicationCapabilities
80 02 0204 documentApplicationProfileT73 = T.503 and G3-64k
81 01 00 documentArchitectureClass = FDA
```

F.4.2.2 D-CAPABILITY request/response APDUs conveyed by SUD in CDCL/RDCLP

```
D-CAPABILITY-REQ/RESP ::= CHOICE {
    [4] IMPLICIT ApplicationCapabilities }
```

```
ApplicationCapabilities ::= SET {
    documentApplicationProfileT73 [0] IMPLICIT OCTET STRING,
        -- '04'H document application profile G3-64k
    documentArchitectureClass [1] IMPLICIT OCTET STRING,
        -- '00'H FDA
    nonBasicDocCharacteristics [2] IMPLICIT NonBasicDocCharacteristics OPTIONAL }
```

```
NonBasicDocCharacteristics ::= SET {
    page-dimensions [2] IMPLICIT SET OF Dimension-pair OPTIONAL,
    ra-gr-coding-attributes [3] IMPLICIT SET OF Ra-Gr-Coding-Attribute OPTIONAL,
    ra-gr-presentation-features [4] IMPLICIT SET OF Ra-Gr-Presentation-Feature OPTIONAL,
    types-of-coding [29] IMPLICIT SET OF Type-of-Coding OPTIONAL }
```

```
Dimension-pair ::= SEQUENCE {
    horizontal [0] IMPLICIT INTEGER,
    vertical CHOICE {
        fixed [0] IMPLICIT INTEGER,
        variable [1] IMPLICIT INTEGER }}
        -- ISO B4 = (11811, 16677 fixed or variable)
        -- ISO A3 = (14030, 19840 fixed or variable)
        -- ISO A4 = ( 9920, 14030 fixed or variable)
        -- default value is ISO A4 = ( 9920, 14030 fixed)
        - -- basic default value is ISO A4 = ( 9920, 14030 fixed or variable)
```

```

Ra-Gr-Coding-Attribute ::= CHOICE {
  compression           [0] IMPLICIT Compression }

Compression             ::= INTEGER { uncompressed (0) ,
                                     compressed (1) }
  -- default and basic value is compressed (1)

Ra-Gr-Presentation-Feature ::= CHOICE {
  pel-transmission-density [11] IMPLICIT Pel-Transmission-Density }

Pel-Transmission-Density ::= INTEGER { p6           (1), -- 6 BMU (200pels / 25.4 mm)
                                     p4           (3), -- 4 BMU (300pels / 25.4 mm)
                                     p3           (4), -- 3 BMU (400pels / 25.4 mm)
                                     R8 x 3.85    (5),
                                     R8 x 7.7      (6),
                                     R8 x 15.4     (7),
                                     R16 x 15.4    (8) }
  -- default and basic value is R8 x 3.85 (5)

Type-of-Coding          ::= CHOICE {
  [0] IMPLICIT INTEGER { T.6 coding (1),
                        T.4 one dimensional coding (2),
                        T.4 two dimensional coding (3) }
  -- default and basic value is T.4 one dimensional coding (2) }

```

```

Example -----
A4 31 ApplicationCapabilities
80 01 04 documentApplicationProfileT73 = G3-64k
81 01 00 documentArchitectureClass = FDA
A2 29 nonBasicDocCharacteristics
A2 14 page-dimensions
30 08 SEQUENCE
80 02 36CE horizontal = 14030 BMU
81 02 4D80 vertical = variable 19840 BMU (ISO A3 variable)
30 08 SEQUENCE
80 02 2E23 horizontal = 11811 BMU
81 02 4125 vertical = variable 16677 BMU (ISO B4 variable)
A4 09 ra-gr-presentation-features
8B 01 01 pel-transmission-density = 1 (6 BMU)
8B 01 03 pel-transmission-density = 3 (4 BMU)
8B 01 06 pel-transmission-density = 6 (R8 x 7.7)
BD 06 types-of-coding
80 01 01 Type-of-coding = 1 (T.6 coding)
80 01 03 Type-of-coding = 3 (T.4 two dimensional coding)
-----

```

F.4.2.3 User data conveyed by SUD in CDS

```

S-ACTIVITY-START-user-data ::= CHOICE {
  [4] IMPLICIT DocumentCharacteristics }

DocumentCharacteristics ::= SET {
  documentApplicationProfile [0] IMPLICIT OCTET STRING,
  -- '04'H document application profile G3-64k
  documentArchitectureClass [1] IMPLICIT OCTET STRING
  -- '00'H FDA
  nonBasicDocCharacteristics [2] IMPLICIT NonBasicDocCharacteristics OPTIONAL
  -- see F.4.2.2 }

```

```

Example -----
A4 2B DocumentCharacteristics
80 01 04 documentApplicationProfile = G3-64k
81 01 00 documentArchitectureClass = FDA
A2 23 nonBasicDocCharacteristics
A2 14 page-dimensions
30 08 SEQUENCE
80 02 2E23 horizontal = 11811 BMU
81 02 4125 vertical = variable 16677 BMU (ISO B4 variable)
30 08 SEQUENCE
80 02 36CE horizontal = 14030 BMU
81 02 4D80 vertical = variable 19840 BMU (ISO A3 variable)
A4 06 ra-gr-presentation-features
8B 01 06 pel-transmission-density = 6 (R8 x 7.7)
8B 01 07 pel-transmission-density = 7 (R8 x 15.4)
BD 03 types-of-coding
80 01 03 Type-of-coding = 3 (T.4 two dimensional coding)

```

F.4.2.4 Layout object descriptor (document layout root) conveyed by CSUI/CDUI

```

Interchange-Data-Element ::= CHOICE {
  layout-object           [2] IMPLICIT Layout-Object-Descriptor }

Layout-Object-Descriptor ::= SEQUENCE {
  object-type             Layout-Object-Type,
  descriptor-body         Layout-Object-Descriptor-Body OPTIONAL }

Layout-Object-Type       ::= INTEGER { document-layout-root (0) }

Layout-Object-Descriptor-Body ::= SET {
  object-identifier       Object-or-Class-Identifier OPTIONAL,
  subordinates            [0] IMPLICIT SEQUENCE OF NumericString OPTIONAL,
  default-value-lists     [7] IMPLICIT Default-Value-Lists-Layout OPTIONAL }

Object-or-Class-Identifier ::= [APPLICATION 1] IMPLICIT PrintableString
-- only digits and space are used in the present version
-- of the standard; other characters are reserved for extensions:
-- a "null" value is represented by an empty string.

Default-Value-Lists-Layout ::= SET {
  page-attributes         [2] IMPLICIT Page-Attributes OPTIONAL }

Page-Attributes          ::= SET {
  dimensions              < Attribute OPTIONAL,
  presentation-attributes < Attribute OPTIONAL }

Attributes               ::= CHOICE {
  dimensions              [1] IMPLICIT Dimension-Pair,
  presentation-attributes [3] IMPLICIT Presentation-Attributes
-- see section 4.2.2
-- see F.4.2.5 }

```

Example -----

```

A2 03 Layout-Object-Descriptor
02 01 00 INTEGER = document-layout-root

```

F.4.2.5 Layout object descriptor (page) conveyed by CSUI/CDUI

| | | |
|---|-----|--|
| Interchange-Data-Element layout-object | ::= | CHOICE { [2] IMPLICIT Layout-Object-Descriptor } |
| Layout-Object-Descriptor object-type descriptor-body | ::= | SEQUENCE { Layout-Object-Type, Layout-Object-Descriptor-Body OPTIONAL } |
| Layout-Object-Type | ::= | INTEGER { page (2) } |
| Layout-Object-Descriptor-Body object-identifier content-portions dimensions presentation-attributes | ::= | SET { Object-or-Class-Identifier OPTIONAL, [1] IMPLICIT SEQUENCE OF NumericString OPTIONAL, [4] IMPLICIT Dimension-Pair OPTIONAL, <i>-- see F.4.2.2</i> [6] IMPLICIT Presentation-Attributes OPTIONAL } |
| Object-or-Class-Identifier | ::= | [APPLICATION 1] IMPLICIT PrintableString <i>-- see F.4.2.4</i> |
| Presentation-Attributes content-type raster-graphics-attributes | ::= | SET { Content-Type OPTIONAL, [1] IMPLICIT Raster-Graphics-Attributes OPTIONAL } |
| Content-Type | ::= | [APPLICATION 2] IMPLICIT INTEGER { formatted-raster-graphics (1) } |
| Raster-Graphics-Attributes pel-path line-progression pel-transmission-density | ::= | SET { [0] IMPLICIT One-of-Four-Angles OPTIONAL, [1] IMPLICIT One-of-Two-Angles OPTIONAL, [2] IMPLICIT Pel-Transmission-Density OPTIONAL <i>-- see F.4.2.2 (See Note) }</i> |

NOTE – *The transmitter shall correctly indicate the resolution of the transmitted document. Consequently, the transmitter may use the resolution of 6BMU when the receiver indicates the resolution of R8 x 7.7 or vice versa. Similarly, the transmitter may use the resolution of 3BMU when the receiver indicates the resolution of R16 x 15.4 or vice versa.*

| | | |
|--------------------|-----|--|
| One-of-Four-Angles | ::= | INTEGER { d0 (0) -- 0 } <i>-- default and basic value is d0 (0)</i> |
| One-of-Two-Angles | ::= | INTEGER { d270 (3) -- 270 } <i>-- default and basic value is d270 (3)</i> |

Example 1 -----

```
A2 03    Layout-Object-Descriptor
02 01 02  INTEGER = page
-- This means ISOA4 fixed and R8 x 3.85
```

Example 2 -----

```
A2 16    Layout-Object-Descriptor
02 01 02  INTEGER = page
31 11    SET
    A4 08    dimensions
        80 02 26C0    horizontal = 9920 BMU
        81 02 36CE    vertical   = 14030 BMU (ISO A4 variable)
    A6 05    presentation-attributes
        A1 03    raster-graphics-attributes
            82 01 06    pel-transmission-density = R8 x 7.7
```

F.4.2.6 Content portion conveyed by CSUI/CDUI

```

Interchange-Data-Element ::= CHOICE {
    content-portion          [3] IMPLICIT Text-Unit }

Text-Unit ::= SEQUENCE {
    content-portion-attributes Content-Portion-Attributes OPTIONAL,
    content-information       Content-Information }

Content-Portion-Attributes ::= SET {
    content-identifier-layout Content-Portion-Identifier OPTIONAL,
    type-of-coding           Type-of-Coding           OPTIONAL,
    -- see F.4.2.2

    coding-attributes        CHOICE {
    raster-gr-coding-attributes [2] IMPLICIT Raster-Gr-Coding-Attributes } OPTIONAL }

Content-Portion-Identifier ::= [APPLICATION 0] IMPLICIT PrintableString
    -- only digits and space are used in the present version
    -- of the standard; other characters are reserved for extensions.

Raster-Gr-Coding-Attributes ::= SET {
    number-of-pels-per-line [0] IMPLICIT INTEGER OPTIONAL,
    --ISO A4 R8              = 1728
    -- R16                   = 3456
    -- 200 pels/25.4 mm      = 1728
    -- 300 pels/25.4 mm      = 2592
    -- 400 pels/25.4 mm      = 3456
    --ISO B4 R8              = 2048
    -- R16                   = 4096
    -- 200 pels/25.4 mm      = 2048
    -- 300 pels/25.4 mm      = 3072
    -- 400 pels/25.4 mm      = 4096
    --ISO A3 R8              = 2432
    -- R16                   = 4864
    -- 200 pels/25.4 mm      = 2432
    -- 300 pels/25.4 mm      = 3648
    -- 400 pels/25.4 mm      = 4864
    -- default and basic value is 1728 (ISO A4 R8)

    compression             [2] IMPLICIT Compression   OPTIONAL,
    -- see F.4.2.2

Content-Information ::= OCTET STRING
    -- basic value is T.4 one dimensional coding string

```

Example 1

```

-----
A3 LI Text-Unit
    04 LI XXXXX (T.4 one dimensional coding string) XXXXX OCTET STRING (primitive)
-----

```

Example 2

```

-----
A3 80 Text Unit
31 09 content-portion-attributes
    80 01 01 Type-of-coding = 1 (T.6 coding)
    A2 04 coding-attributes
    80 02 0800 number-of-pels-per-line = 2048
24 80 OCTET STRING (constructed)
    04 LI XXXXXXXXXX (T.6 coding string) XXXXXXXXXX OCTET STRING (primitive)
    04.LI XXXXXXXXXX (T.6 coding string) XXXXXXXXXX OCTET STRING (primitive)
    0000 EOC
    0000 EOC
-----

```

F.4.3 Communication concepts

F.4.3.1 General

A G3-64 kbit/s facsimile may negotiate the capability to use the document application profile and the document architecture class within an association. This negotiation is accomplished with the DINQ/DINR APDUs (user data of CSS/RSSP) and DCPQ/DCPR APDUs (user data of CDCL/RDCLP) exchanges during the association establishment phase. However, only one type of document may be invoked at any given time during the document transfer phase. The negotiation and invocation are described below.

F.4.3.2 Negotiation

The application capabilities are negotiated as follows:

- For DINQ/DINR, the application capabilities indicated within the session user data (SUD) parameter CSS/RSSP shall only indicate which document application profile(s) and document architecture class(es) are available as receiving capabilities of the sender of the command/response.
- For DCPQ, the application capabilities indicated within the SUD of CDCL should include a list of non-basic document characteristics that may be needed at the receiver by the sender of this command.
- For DCPR, the non-basic document characteristics available should be indicated and are conveyed in the SUD of RDCLP.

F.4.3.3 Invocation

The document characteristics indicated within the SUD of CDS/CDC should include the non-basic document characteristics which are required for the document. The non-basic document characteristics are conveyed in the SUD, using the document characteristics protocol element. The document sender only sends documents which the sink has indicated it is capable of handling.

F.4.3.4 Data transfer

The layout object descriptors and the text units are carried inside the session service data units (CSUI-CDUI T.62 commands). Within the data stream, the interchange data elements are ordered in accordance with “interchange format class B”, as defined in Recommendation T.415. Every text unit follows immediately the descriptor of the associated lowest-level object. When a document is transmitted, a synchronization point is set at each page boundary of the specific structure.

F.5 Interworking

The sequence diagrams of session establishment phase between group 3 facsimile 64 kbit/s option and group 4 class 1 facsimile are shown as follows.

F.5.1 In case of group 3-64 kbit/s option calling

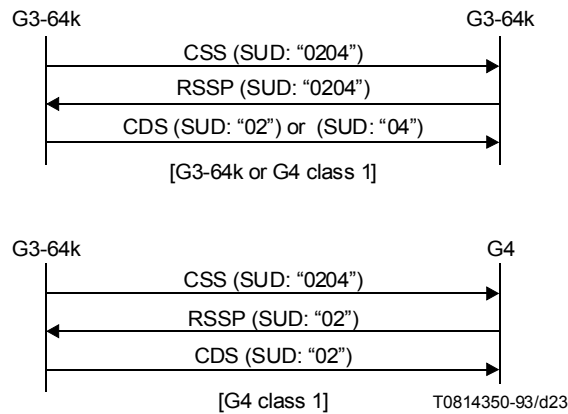

FIGURE F.1/T.4

F.5.2 In case of group 4 class 1 facsimile calling

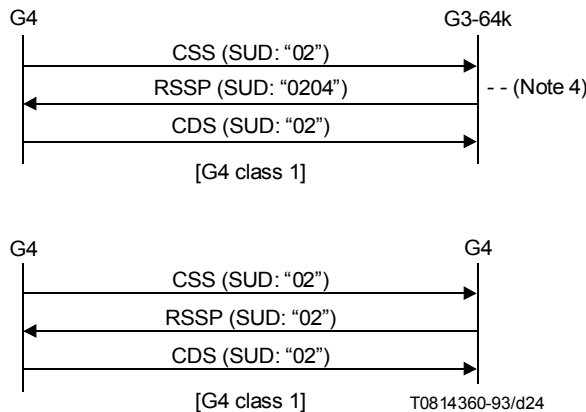

FIGURE F.2/T.4

NOTES

1 The document application profile in the session user data (SUD) of CSS indicates "0204" for T.503 and group 3-64 kbit/s as described in F.4.2. The document application profile contained in the SUD of RSSP indicates the capability of the called side by using "0204" for T.503 and group 3-64 kbit/s option F. CDS shall indicate one of the document application profiles T.503 ("02") and group 3-64 kbit/s ("04") in the SUD.

2 When the calling side intends to use NonBasicCharacteristics, it shall emit CDCL command prior to CDS command and negotiates the capability of the called side according to T.62 procedures. The document application profile contained in the SUD of CDCL shall be either T.503 ("02") or group 3-64 kbit/s ("04").

3 When both document application profiles are available at both ends, the document transmitting side shall select one of the two profiles by CDCL and/or CDS commands.

4 In this case, called side may transmit only T.503 ("02") in the SUD.

Appendix I

Guaranteed reproducible area for group 3 apparatus conforming to Recommendation T.4

(This appendix does not form an integral part of this Recommendation)

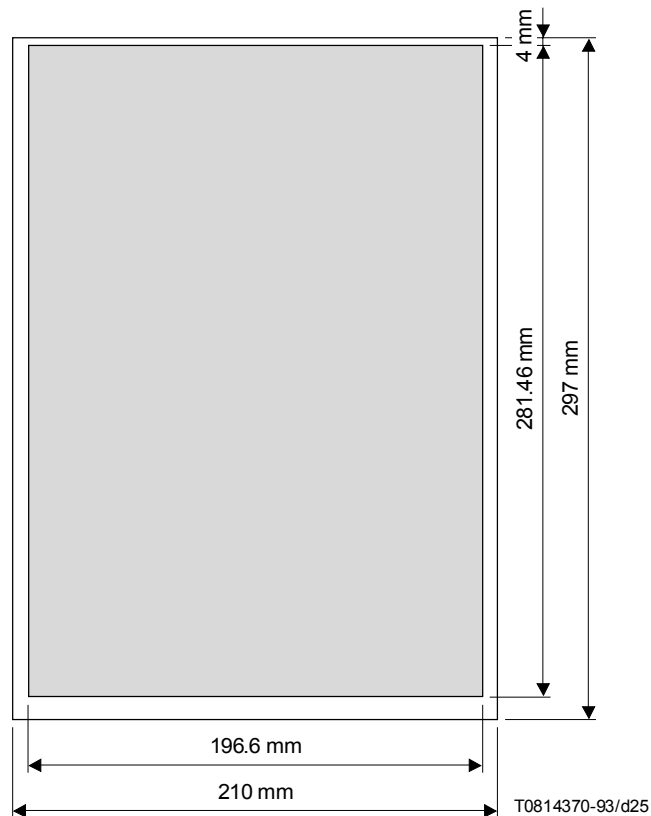

NOTES

- 1 Paper characteristics (i.e. weight) are important parameters. Lightweight paper may cause additional paper handling errors and result in a reduced guaranteed reproducible area.
- 2 Sheet feed mechanism may reduce the guaranteed reproducible area.
- 3 All calculations were done using worst values. Using nominal values increases the reproducible area.
- 4 The exact horizontal position of this area within the ISO A4 paper size as well as sizes larger than the above are subject to national recommendations and/or definitions.

FIGURE I.1/T.4

**Guaranteed reproducible area for Group 3 machines for use on
facsimile services referring to ISO A4 paper size**

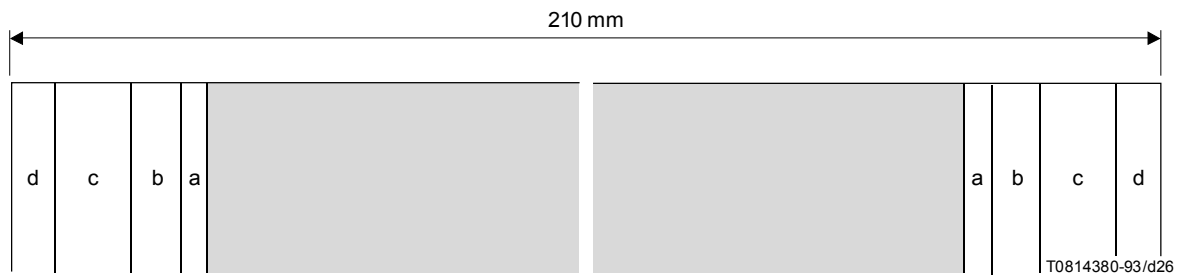

- a Printer/scanner tolerances
- b Loss caused by the enlarging effect due to TLL tolerance
- c Loss caused by skew
- d Record medium positioning errors

FIGURE I.2/T.4
Horizontal loss

TABLE I.1/T.4
Horizontal losses

| | | |
|--------------------|---|--------------|
| Printer/scanner | a | ± 0.5 mm |
| Enlarging | b | ± 2.1 mm |
| Skew | c | ± 2.6 mm |
| Positioning errors | d | ± 1.5 mm |

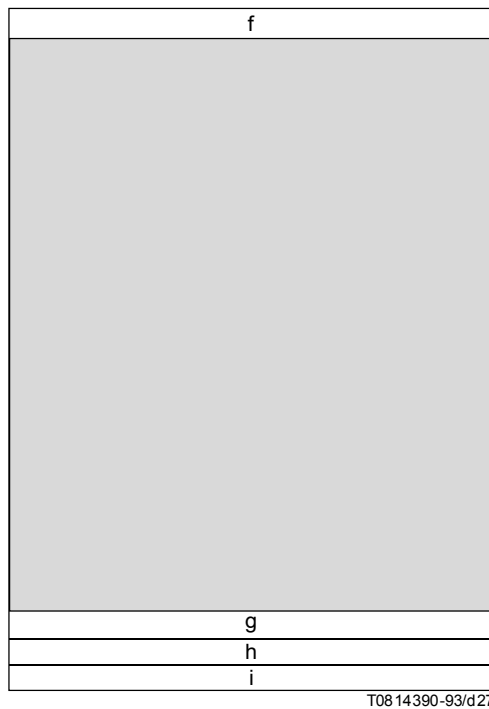

T08 14390-93/d27

- f Paper insertion loss
- g Loss caused by skew
- h Scanning density tolerance
- i Gripping loss

FIGURE I.3/T.4
Vertical loss (ISO A4 format)

TABLE I.2/T.4

Vertical losses

| | | |
|---|---|-----------|
| Paper insertion | f | 4.0 mm |
| Skew | g | ±1.8 mm |
| Scanning density tolerance | h | ± 2.97 mm |
| Gripping loss | i | 2.0 mm |
| NOTE – Scanning density tolerance will reduce to 0 mm on roll-fed machines. | | |

Appendix II

Repertoire of box-drawing characters for character mode of group 3 apparatus

(This appendix does not form an integral part of this Recommendation)

| | 0 | 1 | 2 | 3 | 4 | 5 | 6 | 7 |
|----|---|---|---|---|---|---|---|---|
| 0 | | | | ▢ | ▣ | ▤ | | |
| 1 | | | ▥ | ▦ | ▧ | ▨ | | |
| 2 | | | ▩ | ▪ | ▫ | ▬ | | |
| 3 | | | ▭ | ▮ | ▯ | ▰ | | |
| 4 | | | ▱ | ▲ | | △ | | |
| 5 | | | ▴ | ▵ | | ▶ | | |
| 6 | | | ▷ | ▸ | | ▹ | | |
| 7 | | | ► | ▻ | | ▼ | | |
| 8 | | | ▽ | ▾ | | ▿ | | |
| 9 | | | ▾ | ▿ | | ▸ | | |
| 10 | | | ▿ | ▸ | | ▹ | | |
| 11 | | | ▸ | ▹ | | | | |
| 12 | | | ▹ | ► | ▻ | | | |
| 13 | | | ▻ | ▼ | | | | |
| 14 | | | | ▱ | | | | |
| 15 | | | ▢ | ▣ | | | | |

T0814400-93/d28

FIGURE II.1/T.4
Repertoire of box-drawing characters

