



INTERNATIONAL TELECOMMUNICATION UNION

**CCITT**

THE INTERNATIONAL  
TELEGRAPH AND TELEPHONE  
CONSULTATIVE COMMITTEE

**V.42**

(11/1988)

SERIES V: DATA COMMUNICATION OVER THE  
TELEPHONE NETWORK

Error control

---

**ERROR-CORRECTING PROCEDURES FOR  
DCES USING ASYNCHRONOUS-TO-  
SYNCHRONOUS CONVERSION**

Reedition of CCITT Recommendation V.42 published in  
the Blue Book, Fascicle VIII.1 (1988)

---

## NOTES

- 1 CCITT Recommendation V.42 was published in Fascicle VIII.1 of the *Blue Book*. This file is an extract from the *Blue Book*. While the presentation and layout of the text might be slightly different from the *Blue Book* version, the contents of the file are identical to the *Blue Book* version and copyright conditions remain unchanged (see below).
- 2 In this Recommendation, the expression “Administration” is used for conciseness to indicate both a telecommunication administration and a recognized operating agency.

## Recommendation V.42

### ERROR-CORRECTING PROCEDURES FOR DCEs USING ASYNCHRONOUS-TO-SYNCHRONOUS CONVERSION

(Melbourne, 1988)

The CCITT,

*considering*

- (a) that the use of high-speed DCEs for transmission of asynchronous data on the GSTN is increasing;
- (b) that there is a demand for an improved error performance on such connections by the use of an error-correcting protocol;
- (c) that there is a need to interwork with DCEs not providing such a protocol,

*declares*

that the error-correcting procedures to be followed by DCEs using asynchronous-to-synchronous conversion are as specified in this Recommendation.

#### CONTENTS

1	<i>Scope</i>
	1.1 General
	1.2 Relationship to other international standards
2	<i>Definitions</i>
3	<i>Abbreviations</i>
4	<i>Establishing an error-corrected connection</i>
5	<i>Interchange circuits affected by error correction</i>
6	<i>Overview of error-correcting DCE operation</i>
	6.1 General
	6.2 Overview of the control function
	6.3 Overview of the error control function
	6.4 Communication between the control function and the error control function
7	<i>Operation of the control function</i>
	7.1 Physical handshake
	7.2 Phases of error-correcting protocol establishment
	7.3 Data transfer
	7.4 Transfer of break signal
	7.5 Receipt of break
	7.6 Negotiation indication of parameter values and optional procedures
	7.7 Orderly release of the error-corrected connection
	7.8 Loop-back test
8	<i>Operation of the error control function: LAPM procedures</i>
	8.1 General
	8.2 LAPM elements of procedures and field formats
	8.3 Establishment of the error-corrected connection
	8.4 Transfer of user data from the V.24 interface
	8.5 Exception condition reporting and recovery

8.6	Transfer of user-control information
8.7	Orderly release of an error-corrected connection
8.8	Disconnected state
8.9	Collision of unnumbered commands and responses
8.10	Negotiation/indication of parameter values and optional procedures
8.11	Loop-back test
8.12	Monitoring functions
8.13	Transfer of break
9	<i>System parameters</i>
9.1	Parameters of the control function
9.2	Parameters of the error control function
10	<i>Negotiation of optional procedures</i>
11	<i>Control function-to-control function connection</i>
12	<i>Encoding of information fields</i>
12.1	Information fields in I frames
12.2	Information fields in XID frames
12.3	Information fields in UI frames
12.4	Information fields in TEST frames
<i>Annex A</i>	– Operation of the error control function – alternative procedure
<i>Annex B</i>	– Mapping of character formats to 8-bit format
<i>Appendix I</i>	– Interworking with a non-error-correcting DCE
<i>Appendix II</i>	– Data forwarding conditions
<i>Appendix III</i>	– Cross reference with CCITT Recommendations Q.920 and Q.921
<i>Appendix IV</i>	– Factors for determining the acknowledgement timer
<i>Appendix V</i>	– Potential enhancements to LAPM protocol

## **1 Scope**

### **1.1 General**

This Recommendation describes error-correcting protocols for use with V-Series duplex DCEs to accept start-stop data from the DTE and transmit in synchronous mode. Use in half-duplex DCEs is for further study.

The Recommendation contains an HDLC-based protocol referred to as the Link Access Procedure for Modems, LAPM. Additionally, an alternative procedure is defined in Annex A.

*Note* – There are DCEs currently in operation that implement the protocol defined in Annex A.

Compliance with this Recommendation requires implementation of both protocols. However, unless otherwise specified by user options, two V.42 DCEs will communicate using LAPM. A V.42 DCE dialing or dialled by DCEs currently in operation that only use the protocol in Annex A will communicate using that protocol.

It is the intention of CCITT to further enhance and extend the LAPM protocol. Several topics for further study are listed in Appendix V. It is not intended to further enhance the protocol defined in Annex A.

The principal characteristics of the protocols are as follows:

- a) interworking in the non-error-correcting mode with V-Series DCEs that include asynchronous-to-synchronous conversion according to Recommendation V.14;
- b) error detection through the use of a cyclic redundancy check;
- c) error correction through the use of automatic retransmission of data;
- d) synchronous transmission through the conversion of start-stop data;
- e) an initial handshake in start-stop format which minimizes disruption to the DTEs.

## 1.2 Relationship to other international standards

The error-correcting protocol defined in the main body of this Recommendation can be specified in terms of the High-level Data Link Control (HDLC) formats and procedures. In particular, it makes use of the Balanced asynchronous Class (BAC) of HDLC procedures. The basic mode (i.e. without options) of this protocol makes use of HDLC "Optional Functions" 1, 2, 4, 7 8 and 10. (This mode is identical to CCITT Recommendations Q.920/Q.921.) When using optional procedures of this error-correcting protocol, HDLC "Optional Functions" 3 (for selective retransmission), 12 (for loop-back test), and 14 (for 32-bit FCS) are added.

## 2 Definitions

An error-correcting protocol may be used with a signal converter to create an error-correcting DCE.

### 2.1 DCE

In this Recommendation, a DCE, when used without further qualification, consists primarily of three sections: interchange circuits for the interface to the DTE and signal converters for transmission over telephone circuits. A control function is used to provide a user interface and to coordinate the operation of the interchange circuits. A control function is used to provide a user interface to coordinate the operation of the interchange circuits and the signal converter. The structure of a DCE is shown in Figure 1/V.42.

- The DTE exchanges data with the DCE through a V.24 interface. The data is exchanged in start-stop format.
- The signal converter provides the modulation and demodulation of signals exchanged on the GSTN, or two-wire point-to-point leased circuits.
- The control function provides overall control and coordination between each of the DCE components. Further, the controller provides the specific operational configuration for the DCE selected by the user. The user interface to the controller is implementation dependent.

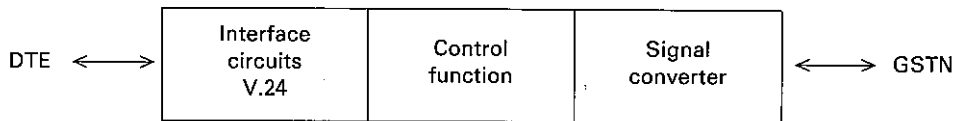

FIGURE 1/V.42

### DCE

### 2.2 error-Correcting DCE

The logical structure of an error-correcting DCE is shown in Figure 2/V.42. The error control functions implements the error-correcting protocols of this Recommendation.

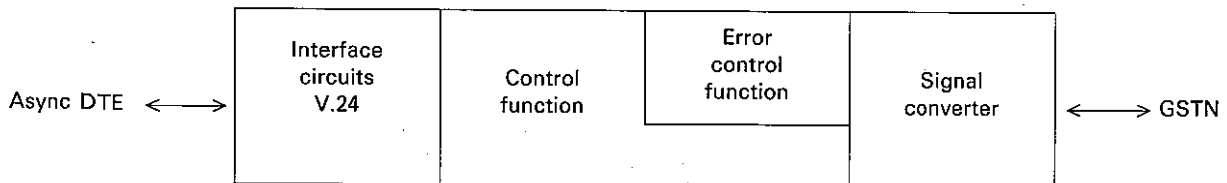

FIGURE 2/V.42

### Error-Correcting DCE

## 3 Abbreviations

Abbreviations used in this Recommendation are:

- ADP Answerer detection pattern  
C/R Command/response bit

CRC	Cyclic redundancy check
DCE	Data circuit-terminating equipment
DISC	Disconnect (frame)
DLCI	Data link connection identifier
DM	Disconnected mode (frame)
DTE	Data terminal equipment
FCS	Frame check sequence
FI	Format identifier
FRMR	Frame reject (frame)
GI	Group identifier
GL	Group length
GSTN	General switched telephone network
HDLC	High-level data link control (protocol)
I	Information (frame)
LA	Link acknowledgement (frame of the alternative error-correcting procedure)
LAPM	Link access procedure for modems
LD	Link disconnect (frame of the alternative error-correcting procedure)
LN	Link attention (frame of the alternative error-correcting procedure)
LNA	Link attention acknowledgment (frame of the alternative error-correcting procedure)
LR	Link request (frame of the alternative error-correcting procedure)
LT	Link transfer (frame of the alternative error-correcting procedure)
ODP	Originator detection pattern
P/F	Poll/Final (bit)
PI	Parameter identifier
PL	Parameter length
PV	Parameter value
REJ	Reject (frame)
RNR	Receive not ready (frame)
RR	Receive ready (frame)
SABME	Set asynchronous balanced mode extended (frame)
SREJ	Selective reject (frame)
UA	Unnumbered acknowledgement (frame)
XID	Exchange identification (frame)

#### **4 Establishing an error-corrected connection**

A connection over which the DCE's error-correcting protocol operates is established in two phases. Initially, a physical connection is established between the peer signal converters, as specified by the appropriate V-Series Recommendation. After the physical connection has been established, the signal converter is in the data mode.

Error-correcting DCEs shall provide a mechanism for enabling or disabling establishment of the error-correcting protocol. This mechanism may be used in situations where the attempt to establish the error-correcting protocol interferes with operation of the remote DTE or when error-correction between DCEs is not desired or needed (such as when the DTEs provide higher-layer error control). The ability to initiate or terminate the error-correction protocol independent of the physical connection (i.e. while a physical connection is already in progress or retained) may optionally be provided, but coordination of protocol initiation at times other than immediately following establishment of the physical connection is not a subject of this Recommendation.

If establishment of the error-correcting protocol is enabled, then after the signal converter is in the data mode, the peer error control functions will establish the error-corrected connection.

**5 Interchange circuits affected by error correction**

The affected circuits are listed in Table 1/V.42.

The interconnection of the functional elements of an error-correcting DCE is shown in Figure 3/V.42.

TABLE 1/V.42

**Interchange circuits affected by error control**

No.	Description
103	Transmitted data
104	Received data
106	Ready for sending
109	Data channel received line signal detector
133	Ready for receiving

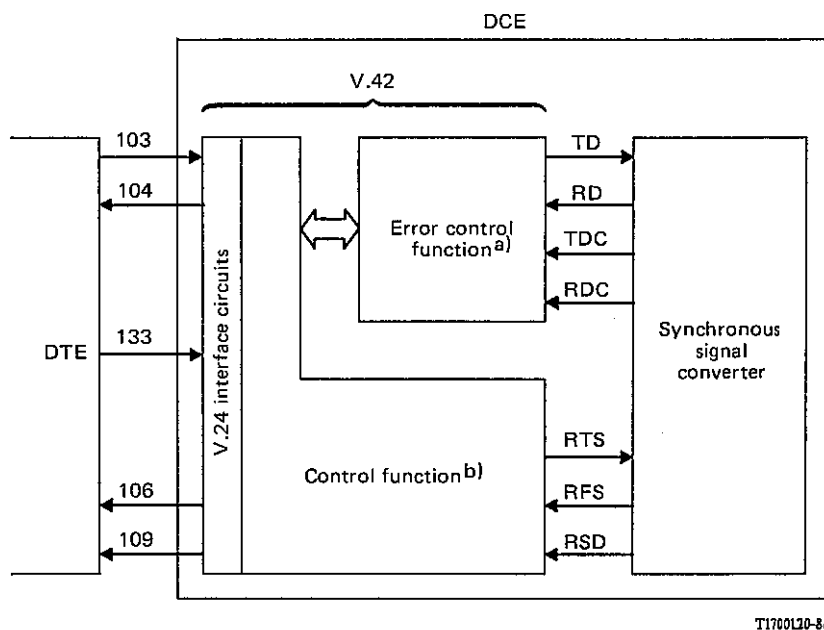

a) See § 8 and Annex A.

b) See § 7.

FIGURE 3/V.42

**Circuits affected by error control**

**6 Overview of error-correcting DCE operation**

**6.1 General**

An error-correcting DCE, as depicted in Figure 2/V.42, contains four components:

- a) V.24 interface circuits;
- b) a signal converter;
- c) a control function;
- d) an error control function.

While the first three components are also found in the DCE depicted in Figure 1/V.42, the control function in an error-correcting DCE is enhanced beyond the functionality of a control function in a DCE. For example, the control

function in an error-correcting DCE shall be capable of determining whether the remote DCE is an error-correcting DCE or a non-error-correcting DCE. The error control function is unique to an error-correcting DCE.

Paragraph 7 provides a detailed description of the control function. Paragraph 8 and Annex A provide detailed descriptions of the error-correcting protocols and their interactions with the control function.

*Note* – The decomposition of the functionality of an error-correcting DCE into a control function and an error control function, as well as the description of their interaction, is not meant to imply a particular method of implementation.

The remainder of § 6 gives an overview of the control function and the error control function.

## 6.2 *Overview of the control function*

The control function shall be responsible for the overall coordination of functions within a DCE. When realized in an error-correcting DCE, the control function shall be responsible for the following additional aspects of operation:

- a) conducting an initial handshake to determine whether the remote DCE is also a V.42 error-correcting DCE;
- b) falling back to a non-error-correcting mode to interwork with V-Series DCEs that include asynchronous-to-synchronous conversion according to Recommendation V.14;
- c) coordinating the negotiation and/or indication of any necessary parameters;
- d) coordinating the negotiation of optional procedures;
- e) coordinating the establishment of an error-corrected connection after the establishment of the physical connection with a peer error-correcting DCE;
- f) coordinating the delivery of data between the V.24 interface and the error control function so that data loss, to the extent possible, does not occur due to congestion on the DTE/DCE or DCE/DCE interface (this includes inspection of the characters received from the V.24 interface to determine whether the DTE has invoked flow control);
- g) converting data received on the V.24 interface with start-stop framing to a format suitable for synchronous transmission;
- h) converting data received on the DCE/DCE interface in synchronous format for delivery with start-stop framing on the V.24 interface;
- i) processing a break (spacing) signal received on the V.24 interface for synchronous transmission;
- j) processing a break indication received on the DCE/DCE interface;
- k) coordinating a loop-back test;
- l) re-negotiating parameters if conditions warrant it; and
- m) releasing the error-corrected connection in an orderly fashion.

## 6.3 *Overview of the error control function*

The error control function shall be responsible for the operation of the protocol that realizes the error-corrected connection. The protocol shall have the following functional capabilities:

- a) negotiation and/or indication of appropriate operational parameters;
- b) negotiation of optional procedures;
- c) establishment of an error-corrected connection;
- d) transmission and reception of data;
- e) error detection and correction;
- f) transmission and reception of a break signal;
- g) initiation of and responding to loop-back testing; and
- h) orderly release of an error-corrected connection.

## 6.4 *Communication between the control function and the error control function*

Communication between the control function and error control function is modeled as a set of abstract primitives, which represents the logical exchange of information and control to accomplish a task or service. In the



context of this Recommendation, the control function is viewed as the “service-user” while the error control function is viewed as the “service-provider”.

A primitive is of the general form  
X-NAME TYPE

where:

X designates a particular pair of communicating entities;  
NAME designates the service being invoked;  
TYPE designates the initiator of the communication.

Table 2/V.42 shows the services expected by the control function (i.e. the values that “NAME” can take on).

There are four “TYPES” of primitives. These are:

- a) a request primitive, which is used by the service-user to request a service;
- b) an indication primitive, which is used by the service-provider to notify the service-user of a request for a service or an action initiated by the service-provider;
- c) a response primitive, which is used by the service-user to respond to a request for a service; and
- d) a confirm primitive, which is used to indicate that a service request has been completed.

TABLE 2/V.42

**Services expected by the control function**

Service	Primitive	§
Establish an error-corrected connection between peer error-correcting entities	L-ESTABLISH	7.2.2
Transfert data	L-DATA	7.3
Release an error-corrected connection	L-RELEASE	7.2.2, 7.7
Transfer a break signal	L-SIGNAL	7.4, 7.5
Negotiate/indicate parameter values and optional procedures	L-SETPARM	7.6
Conduct a loop-back test between error-correcting entities	L-TEST	7.8

**7 Operation of the control function**

Paragraph 6.2 provided an overview of the control function. This section details the operation of the control function, which completely controls all phases of error control function operation.

*7.1 Physical handshake*

The procedures for establishing a physical connection are specified by the appropriate V-Series Recommendation. After the physical connection has been established, the control function shall be aware of the following information:

- a) whether the DCE is the originating or answering DCE;
- b) various aspects concerning the transmission facility (e.g. speed); and
- c) the character format used by the DTE.

The method for determining the above information is beyond the scope of this Recommendation. This information is used to govern some aspects of error-correcting-DCE operation.

*7.2 Phases of error-correcting protocol establishment*

Upon receipt of an indication that the signal converter element has completed carrier handshake and that the physical connection is ready for communications, the control function initiates error-correcting protocol operation. This process has been divided into two phases:

- a) the detection phase determines whether the remote DCE is also an error-correcting DCE; and
- b) the protocol establishment phase determines parameter values and optional procedures to be used, as necessary, and establishes the error-corrected connection.

The detection phase has been designed to avoid the potential disruption to the called DTE that could occur if the control function immediately entered the protocol establishment phase and the remote DCE was *not* an error-correcting DCE. However, the detection phase may optionally be disabled by the user if, for example, the answering DCE is known to be of a compatible type. The error-correcting DCE does not transmit any data received on the V.24 interface to the remote DCE in error-correcting mode until the successful establishment of the error-corrected connection. At that time, the control function adjusts the V.24 interface to inform the DTE that DTE-to-DTE data transfer may commence.

### 7.2.1 *Detection phase*

This phase allows the control function to verify the presence of a remote error-correcting DCE.

Considerations for interworking between an error-correcting DCE and a non-error-correcting DCE are given in Appendix I.

#### 7.2.1.1 *Determination of role*

The success of the detection phase depends on both control functions knowing their roles as originating DCE (hereinafter called the *originator*) or answering DCE (*answerer*). The role is determined by the frequencies used for communication or the role assumed during carrier handshake as assigned in the particular modulation Recommendations. In the situation where no phone call is placed (such as in a “leased line” connection) or where, because of the nature of the modulation, there is no clear differentiation between originator and answerer, the roles must be determined by parameterization (stopping options or other user indication of desired role to the control function).

#### 7.2.1.2 *Originator actions*

The detection phase actions by the originator may be disabled by the user. In this case, the originator moves directly to the protocol establishment phase (see § 7.2.2).

If the detection phase is enabled, when circuits RFS and RSD go ON, indicating a successful connection between the signal converters, the originator shall then send the originator detection pattern (ODP). The ODP is defined as the following pattern of bits (listed left to right in order of transmission):

0 1000 1000 1 11 . . 11 0 1000 1001 1 11 . . 11

This pattern represents DC1 with even parity, followed by 8 to 16 one's, followed by DC1 with odd parity, followed by 8 to 16 one's. The ODP is transmitted for the period of the detection phase timer, T400 (see § 9.1.1) or until the answerer detection pattern (ADP), which is defined in § 7.2.1.3, is received.

All transmissions are sent using the scrambling function of the signal converter (if any) and in synchronization with the derived carrier clock signal (i.e. without use of any inherent asynchronous speed-matching capability of the signal converter that would otherwise be used in an asynchronous non-error-correcting DCE).

The originator shall examine the incoming bit stream from the receiver signal element for the presence of the ADP. Correct receipt of the characters from at least two adjacent ADPs shall be required for the originator to determine that the pattern is being observed.

If the ADP is *not* observed within the period of T400 (see § 9.1.1), following completion of the transmission of the last repetition of the ODP the originator shall decide that the answerer does not possess V.42 error-correcting capability. In this case, the originator may fall back to non-error-correcting mode or may attempt to detect the presence of an alternative error-correcting capability, such as that described in Annex A.

If the ADP is observed within the period of T400, the originator stops transmission of the ODP and takes the appropriate action based upon the ADP received (e.g. if “EC” is received, initiate LAPM).

#### 7.2.1.3 *Answerer actions*

Upon indication of successful establishment of a connection between the signal converters, the control function of the answerer shall transmit 1-bits (mark) until termination of the detection phase, receipt of the ODP, or detection of the start of the protocol phase (the start of the protocol phase is indicated by receipt of continuous flags, or of a LAPM or alternative procedure protocol frame).

The answerer shall examine the incoming bit stream from the signal converter for the presence of the ODP, which is defined in § 7.2.1.2. Correct receipt of at least four DC1's of alternating parity shall be required for the answerer to determine that the ODP is being observed.

If, after establishment of the physical connection, the ODP is *not* observed within the period of T400 (see § 9.1.1) and the start of the protocol establishment phase is not observed within the same period, then the answerer shall decide that the originator is not capable of V.42 error-correcting operation and shall fall back to non-error-correcting operation.

If the ODP is observed, the answerer interprets this as an indication from the originator that the originator is capable of error-correcting operation and desires to continue into the protocol establishment phase. The answerer shall immediately send one of the answerer detection patterns (ADPs) defined in Table 3/V.42 ten times.

All transmissions are sent using the scrambling function of the signal converter and in synchronization with the derived carrier clock signal.

TABLE 3/V.42

**Answerer detection patterns**

Type	Meaning
0 1010 0010 1 11...11 0 1100 0010 1 11...11 (E) and (C) separated by 8 to 16 one's	V.42 supported
0 1010 0010 1 11...11 0 0000 0000 1 11...11 (E) and (Null) separated by 8 to 16 one's	No error-correcting protocol desired
0 1010 0010 1 11...11 0 0000 XXXX 1 11...11	The remaining 15 code points are reserved for study and assignment

*Note* – The above bit patterns are listed left to right in order of transmission (i.e., low-order bit transmitted first).

**7.2.2 Protocol establishment phase**

The protocol establishment phase is initiated by the originating DCE upon successful completion of the detection phase if enabled. The purpose of this phase is to:

- a) negotiate and/or indicate the parameters and any optional procedures that govern the subsequent operation of the DCE; and
- b) establish the error-corrected connection.

Negotiation/indication may be omitted if default parameter values and procedures are satisfactory. When needed, the control function shall follow the procedures in § 7.6 for the negotiation/indication of parameter values and optional procedures.

After the negotiation/indication process has been completed, the originating DCE initiates establishment of the error-corrected connection. The control function in the originating DCE instructs its error control function to initiate connection establishment by issuing an L-ESTABLISH request primitive.

Upon receiving an L-ESTABLISH indication primitive from its error control function, a control function must determine whether it wishes to accept the request for error-corrected connection establishment. If it wishes to accept the request, it issues an L-ESTABLISH response primitive; data may now be transmitted over the error-corrected connection. Otherwise, the control function issues an L-RELEASE request primitive to the error control function. The control function may fall back to operation in a non-error-control mode or it may release the physical connection.

After having issued an L-ESTABLISH request primitive, the control function, upon receipt of an L-ESTABLISH confirm primitive, considers the establishment of the error-corrected connection to be completed and may transmit data over it. If the control function receives an L-RELEASE indication primitive (e.g. as a result of a failure to set up the error-corrected connection or the remote control function refusing to accept error-corrected connection setup), then it may fall back to operation in a non-error-correcting mode or it may release the physical connection.

**7.3 Data transfer**

Upon completion of the protocol establishment phase, the control function shall request transmission by the error control function of data received on the V.24 interface. Regardless of the character format used, each character received on the V.24 interface shall be transmitted as an 8-bit character (without start and stop bits) across the DCE/DCE interface.

Annex B provides the mapping of various character formats to an 8-bit character format.

*Note* – It is beyond the scope of this Recommendation to specify how the control function determines when to request the error control function to transmit data. Some considerations are given in Appendix II.

To transmit data, the control function shall issue an L-DATA request primitive to the error control function. This primitive shall indicate the data to be transmitted.

Upon receipt of an L-DATA indication primitive, the control function shall deliver the received data to the V.24 interface. Each character shall contain the proper start-stop framing.

#### 7.3.1 *Flow control across the DTE/DCE interface*

The control function will be capable of indicating to the DTE a temporary inability to accept data on Circuit 103 (DCE not-ready condition), and of recognizing a corresponding indication from the DTE (DTE not-ready condition). Upon receiving such an indication, the DCE shall and the DTE should complete transmission of any partially-transmitted character and then cease transmitting data on Circuit 104 (103) and clamp Circuit 104 (103) to binary 1. When the not-ready condition is cleared, the DCE (DTE) may resume the transmission of data on Circuit 104 (103).

The flow control indication may be performed in one of two ways:

- a) using Circuit 133 and 106:
  - a DCE not-ready condition may be indicated by turning Circuit 106 OFF and cleared by turning Circuit 106 ON;
  - a DTE not-ready condition may be recognized by an ON-to-OFF transition and cleared by an OFF-to-ON transition of Circuit 133;
- b) using DC1/DC3 characters (XON/XOFF functions):
  - a DCE not-ready condition may be indicated by transmitting a DC3 character and cleared by transmitting a DC1 character on Circuit 104;
  - a DTE not-ready condition may be recognized by the reception of a DC3 character and the condition cleared by the reception of a DC1 character on Circuit 103;

Optionally, DC1 and DC3 characters received from the DTE may remain in the data stream.

Both techniques (a) and (b) shall be provided, however, the choice of technique is a user-configurable option.

The response times of the DCE of indication of a DTE not-ready condition and the DTE to indication of a DCE not-ready condition are for further study. These times should be kept as short as practical. DCEs should accommodate latency in DTE recognition of the DCE not-ready indication by accepting several characters on Circuit 103 after the indication is given.

#### 7.4 *Transfer of break signal*

Upon receipt of a break signal on the V.24 interface, the control function shall determine:

- a) how to handle data (discard or deliver) not yet transmitted across the V.24 interface or to the remote DCE; and
- b) in what sequence (in sequence or preceding) the break signal shall be delivered to the remote V.24 interface with respect to data delivery.

The control function shall issue an L-SIGNAL request primitive to the error control function, indicating the break-handling option corresponding to the appropriate actions. The break-handling option and the actions to be followed are given in Table 4/V.42. The L-SIGNAL request primitive may also indicate the length of the break.

The control function shall not issue a subsequent L-SIGNAL request primitive before a prior one has been acknowledged by an L-SIGNAL confirm primitive from the error control function.

#### 7.5 *Receipt of break*

The control function is informed of a break upon receipt of an L-SIGNAL indication primitive. It shall acknowledge this primitive with an L-SIGNAL response primitive as soon as possible. Actions to be taken on receipt of the break depend on the break-handling option, as shown in Table 5/V.42. If a break length is not indicated, a break of default length is delivered to the DTE.

#### 7.6 *Negotiation/indication of parameter values and optional procedures*

During the protocol establishment phase (see § 7.2.2), negotiation and/or indication of parameter values and optional procedures is initiated by the control function in the originating DCE if default values are not satisfactory. It may also be initiated at any time thereafter by the control function in either DCE.

*Note* – The criteria by which the control function determines to change parameter values and optional procedures, once set during the protocol establishment phase, are beyond the scope of this Recommendation. Examples may include detection of changing transmission-line conditions.

The control function issues an L-SETPARM request primitive to instruct its error control function to initiate negotiation and/or indication of parameter values and optional functions.

Upon receipt of an L-SETPARM indication primitive from its error control function, the control function shall perform the necessary negotiation (see §§ 9 and 10). It shall then issue an L-SETPARM response primitive to its error control function and complete the negotiation/indication process (see below).

Upon receipt of an L-SETPARM confirm primitive from its error control function, the control function completes the negotiation/indication process (see below).

Negotiation/indication of parameter values and optional procedures follow the procedures in §§ 9 and 10. To complete the negotiation/indication process, the control function shall set the affected parameters to their new values and activate/deactivate the affected procedures.

*Note* – Some parameters are set independently of and without informing the remote DCE. In such cases, the control function sets these parameters to their new values without interacting with the error control function as described below.

TABLE 4/V.42

**Transmitting DCE actions on receipt of break signal on the V.24 interface**

Break handling option	With respect to data			
	Going to remote DCE	Going to local DTE	Coming from remote DCE	Coming from local DTE
Destructive/expedited <sup>a)</sup>	– Complete data transmission in progress, then transmit break – Discard data not yet transmitted	– Discard data not yet delivered	– Discard data until receive acknowledgement	– Hold data until receive acknowledgement
Non-destructive/expedited	– Complete data transmission in progress, then transmit break – Hold data until receive acknowledgement	– Continue delivering data	– Continue receiving data	– Continue receiving data
Non-destructive/non-expedited	– Wait for acknowledgement of data previously transmitted, and then transmit break – Hold data until receive acknowledgement	– Continue delivering data	– Continue receiving data	– Continue receiving data

<sup>a)</sup> All state variables pertaining to control function and error control function operation, except those pertaining to break transfer, are reset to their initial values.

TABLE 5/V.42

**Receiving DCE actions on receipt of break from the remote DCE**

Break handling option	With respect to data	
	Going to remote DCE	Going to local DTE
Destructive/expedited <sup>a) b)</sup>	– Discard data not yet transmitted	– Discard data not yet delivered – Deliver break signal
Non-destructive/expedited	– No effect	– Deliver break signal immediately – Resume normal data delivery
Non-destructive/non-expedited	– No effect	– Deliver break signal in sequence with respect to data

<sup>a)</sup> All state variables pertaining to control function and error control function operation, except those pertaining to break transfer, are reset to their initial values.

<sup>b)</sup> For all break options, acknowledgement should be returned as soon as possible.

### 7.7 *Orderly release of the error-corrected connection*

After prior establishment of an error-corrected connection, the control function may instruct its error control function to release the error-corrected connection in an orderly fashion by issuing an L-RELEASE request primitive. At this time, the control function considers the procedure completed. The control function also determines whether to release the physical connection.

*Note* – The stimuli by which the control function orders the error control function to release the error-corrected connection in an orderly fashion are beyond the scope of this Recommendation. The control function may disconnect the physical connection, without requesting an orderly release of the error-corrected connection, upon detection of the corresponding changes on the V.24 interface.

The control function is informed of an orderly release of the error-corrected connection when it receives an L-RELEASE indication primitive from its error control function. The control function may then release the physical connection and effect the corresponding changes on the V.24 interface.

### 7.8 *Loop-back test*

As an optional function agreed to during the protocol establishment phase, a control function may initiate a loop-back test with the remote control function.

*Note* – How a control function determines the need to conduct a loop-back test is for further study.

To initiate a loop-back test, the control function shall issue an L-TEST request primitive to its error control function. The control function is responsible for generating unique data to be returned by the remote control function to indicate a successful test.

A loop-back test may be initiated at any time after completion of the protocol establishment phase.

The test is considered terminated on receipt of L-TEST indication primitive containing the data sent with the L-TEST request primitive or when a locally-defined period of time has expired.

A control function receiving an L-TEST indication primitive without having issued a prior L-TEST request primitive (i.e. it needs to respond to a loop-back test from the remote control function) shall issue an L-TEST request primitive to its error control function. This primitive shall contain the data received in the L-TEST indication primitive to be returned to the test initiator.

## 8 **Operation of the error control function: LAPM procedures**

This section and Annex A describe the operation of the error control function.

Within LAPM, all messages are transmitted in *frames*, which are delimited by opening and closing *flags*. The frame structure and flag pattern are described in § 8.1.1 below.

The procedures in this Recommendation include functions for:

- a) frame delimiting, alignment, and transparency;
- b) transfer of user information (data and break);
- c) sequence control;
- d) detection of transmission, format, and operational errors;
- e) recovery from detected transmission, format, and operational errors with notification of unrecoverable errors;
- f) flow control;
- g) negotiation/indication of parameter values and optional procedures; and
- h) initialization and orderly release of the error-corrected connection.

In addition, LAPM makes provision for one or more “logical” error-corrected connections; discrimination between these connections is by means of a data link connection identifier (DCLI) contained in each frame.

### 8.1 *General*

This section specifies the frame structure and procedures for the proper operation of the Link Access Procedure for Modems (LAPM).

8.1.1 *Frame structure and fields*

8.1.1.1 *Frame structure*

All DCE-to-DCE communications are accomplished using the frame structure shown in Figure 4/V.42.

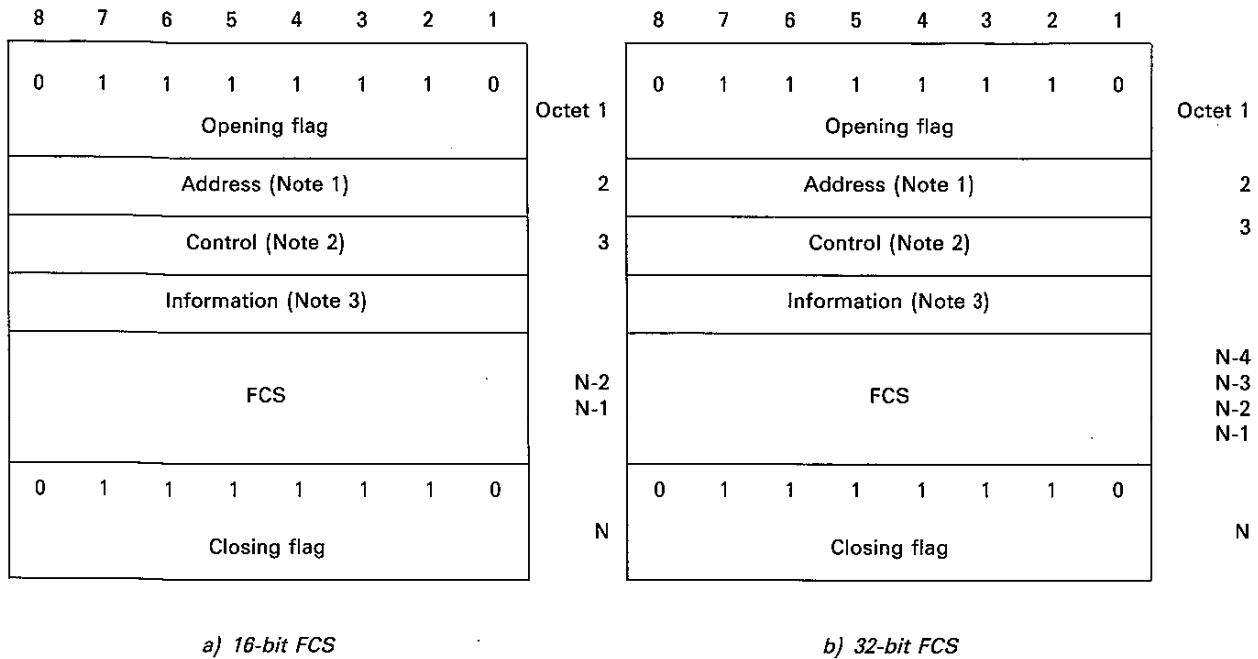

*Note 1* – The maximum size of this field is limited to two octets.

*Note 2* – The control field is two octets for frame types with sequence numbers and one octet for frame types without sequence numbers, see § 8.2.2.

*Note 3* – Not all frame types have an information field

FIGURE 4/V.42

**Frame structure**

8.1.1.2 *Flag sequence and transparency*

All frames are delimited by the unique bit pattern “01111110”, known as a *flag*. The flag preceding the address field is defined as the opening flag. The flag following the frame check sequence field is defined as the closing flag. The closing flag of one frame may also serve as the opening flag of the next frame.

Transparency is maintained by the transmitter's examining the frame content between the opening and closing flags and inserting a “0” bit after all sequences of five contiguous “1” bits. The receiver examines the frame content between the opening and closing flags and discards any “0” bit that directly follows five contiguous “1” bits.

8.1.1.3 *Address field*

The primary purpose of the address field is to identify an error-corrected connection and the error-correcting entity associated with it. The format of this field is defined in § 8.2.1.

8.1.1.4 *Control field*

The control field is used to distinguish between different frame types. This field is further defined in § 8.2.2.

8.1.1.5 *Information field*

Depending on the frame type, an information field may also be present in the frame. The maximum number of octets in this field is governed by parameter N401 (see § 9.2.3).

8.1.1.6 *Frame check sequence (FCS) field*

This field uses a CRC polynomial to guard against bit errors.

#### 8.1.1.6.1 16-bit frame check sequence

The FCS field shall be the sixteen-bit sequence preceding the closing flag. The 16-bit FCS shall be the ones complement of the sum (modulo 2) of:

- a) the remainder of  $x^k(x^{15} + x^{14} + x^{13} + x^{12} + x^{11} + x^{10} + x^9 + x^8 + x^7 + x^6 + x^5 + x^4 + x^3 + x^2 + x^1)$  divided (modulo 2) by the generator polynomial  $x^{16} + x^{12} + x^5 + 1$ , where  $k$  is the number of bits in the frame existing between, but not including, the final bit of the opening flag and the first bit of the FCS, excluding bits inserted for transparency; and
- b) the remainder of the division (modulo 2) by the generator polynomial  $x^{16} + x^{12} + x^5 + 1$ , of the product of  $x^{16}$  by the content of the frame existing between, but not including, the final bit of the opening flag and the first bit of the FCS, excluding bits inserted for transparency.

As a typical implementation at the transmitter, the initial content of the register of the device computing the remainder of the division is preset to all 1's and is then modified by division by the generator polynomial (as described above) of the address, control and information fields; the ones complement of the resulting remainder is transmitted as the sixteen-bit FCS.

As a typical implementation at the receiver, the initial content of the register of the device computing the remainder is preset to all 1's. The final remainder, after multiplication by  $x^{16}$  and then division (modulo 2) by the generator polynomial  $x^{16} + x^{12} + x^5 + 1$  of the serial incoming protected bits and the FCS, will be "0001 1101 0000 1111" ( $x^{15}$  through  $X^0$ , respectively) in the absence of transmission errors.

#### 8.1.1.6.2 32-bit frame check sequence

The FCS shall be the 32-bit sequence preceding the closing flag. The 32-bit FCS shall be the ones complement of the sum (modulo 2) of:

- a) the remainder of  $x^k(x^{31} + x^{30} + x^{29} + x^{28} + x^{27} + x^{26} + x^{25} + x^{24} + x^{23} + x^{22} + x^{21} + x^{20} + x^{19} + x^{18} + x^{17} + x^{16} + x^{15} + x^{14} + x^{13} + x^{12} + x^{11} + x^{10} + x^9 + x^8 + x^7 + x^6 + x^5 + x^4 + x^3 + x^2 + x^1 + 1)$  divided (modulo 2) by the generator polynomial  $x^{32} + x^{26} + x^{23} + x^{22} + x^{16} + x^{12} + x^{11} + x^{10} + x^8 + x^7 + x^5 + x^4 + x^2 + x + 1$ , where  $k$  is the number of bits in the frame existing between, but not including, the final bit of the opening flag and the first bit of the FCS, excluding bits inserted for transparency; and
- b) the remainder of the division (modulo 2) by the generator polynomial  $x^{32} + x^{26} + x^{23} + x^{22} + x^{16} + x^{12} + x^{11} + x^{10} + x^8 + x^7 + x^5 + x^4 + x^2 + x + 1$ , of the product of  $x^{32}$  by the content of the frame existing between, but not including, the final bit of the opening flag and the first bit of the FCS, excluding bits inserted for transparency.

As a typical implementation at the transmitter, the initial content of the register of the device computing the remainder of the division is preset to all 1's and is then modified by division by the generator polynomial (as described above) of the address, control and information fields; the ones complement of the resulting remainder is transmitted as the 32-bit FCS.

As a typical implementation at the receiver, the initial content of the register of the device computing the remainder is preset to all 1's. The final remainder, after multiplication by  $x^{32}$  and then division (modulo 2) by the generator polynomial  $x^{32} + x^{26} + x^{23} + x^{22} + x^{16} + x^{12} + x^{11} + x^{10} + x^8 + x^7 + x^5 + x^4 + x^2 + x + 1$  of the serial incoming protected bits and the FCS, will be "1100 0111 0000 0100 1101 1101 0111 1011" ( $x^{31}$  through  $x^0$ , respectively) in the absence of transmission errors.

### 8.1.2 Format conventions

#### 8.1.2.1 Numbering convention

The basic convention used in this Recommendation is illustrated in Figure 5/V.42. The bits are grouped into octets. The bits of an octet are shown horizontally and are numbered from 1 to 8. Multiple octets are shown vertically and are numbered from 1 to  $n$ .



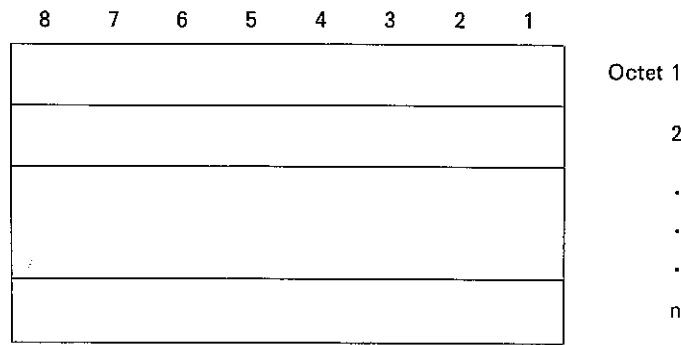

FIGURE 5/V.42

**Format convention**

8.1.2.2 *Order of bit transmission*

The octets are transmitted in ascending numerical order; inside an octet, bit 1 is the first bit to be transmitted.

8.1.2.3 *Field mapping convention*

When a field is contained within a single octet, the lowest bit number of the field represents the lowest-order value.

When a field spans more than one octet, the order of bit values within each octet progressively decreases as the octet number increases. The lowest bit number associated with the field represents the lowest-order value.

For example, a bit number can be identified as a couple (o,b) where o is the octet number and b is the relative bit number within the octet. Figure 6/V.42 illustrates a field that spans from bit (1,3) to bit (2,7). The high-order bit of the field is mapped on bit (1,3) and the low-order bit is mapped on bit (2,7).

An exception to the preceding field-mapping convention is the FCS field, which spans two or four octets. In this case, bit 1 of the first octet is the high-order bit; bit 8 of the second octet (for 16-bit FCS) or bit 8 of the fourth octet (for 32-bit FCS) is the low-order bit (Figure 7.V.42).

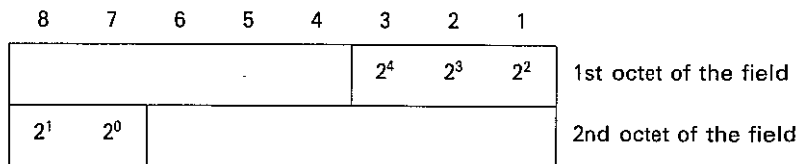
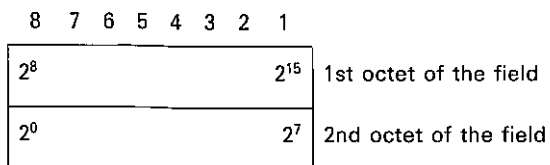
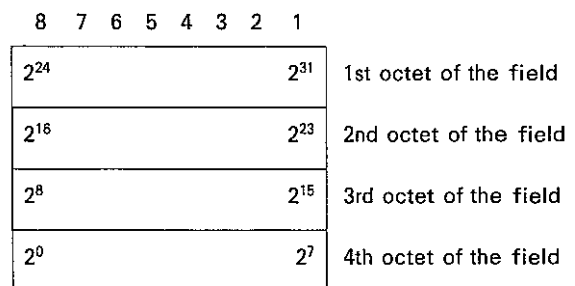

FIGURE 6/V.42

**Field mapping convention**



a) 16-bit FCS



b) 32-bit FCS

FIGURE 7/V.42

**FCS mapping convention**

### 8.1.3 Invalid frames

An invalid frame is one which:

- a) is not properly bounded by two flags; or
- b) for 16-bit FCS mode, has fewer than five octets between flags of frames that contain sequence numbers and fewer than four octets between flags of frames that do not contain sequence numbers; or  
for 32-bit FCS mode, has fewer than seven octets between flags of frames that contain sequence numbers and fewer than six octets between flags of frames that do not contain sequence numbers; or
- c) does not consist of an integral number of octets prior to zero-bit insertion or following zero-bit extraction; or
- d) contains a frame check sequence error; or
- e) contains an address field with more than two octets or with a DLCI value not supported by the receiver.

Invalid frames shall be discarded without notification to the sender (however, see § 8.5.4). No action is taken as a result of having received the frame.

### 8.1.4 Frame abort

Receipt of seven or more contiguous 1 bits shall be interpreted as an abort and the error control function shall ignore the frame currently being received.

### 8.1.5 Interframe time fill

Interframe time fill is accomplished by transmitting contiguous flags between frames, i.e. multiple eight-bit flag sequences (see § 8.1.1.2).

## 8.2 LAPM elements of procedures and field formats

The elements of procedures define the commands and responses that are used on a LAPM error-corrected connection. Procedures, which are derived from these elements of procedures, are described in subsequent sections.

### 8.2.1 Address field format

The format of the address field is shown in Figure 8/V.42. The address field contains the data link connection identifier (DLCI), the C/R bit, and the address field extension (EA) bit.

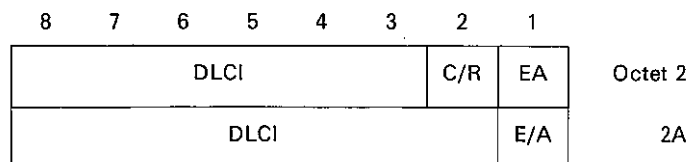

Figure 8/V.42

### Address field format

#### 8.2.1.1 Data link connection identifier

Within the scope of this Recommendation, two DLCI values are defined. One DLCI value is used to transfer information exchanged between V.24 interfaces. The other value, which is optional, is used as a control function-to-control function information connection; it is described in § 11. The value for each DLCI is defined in § 9.2.7 of this Recommendation.

When using the optional two-octet address field (see § 8.2.1.3), the DLCI also includes bits 8 through 2 of octet 2A.

#### 8.2.1.2 Command/response (C/R) bit field

The C/R (command/response) bit identifies the frame as either a command or a response. In conformance with HDLC rules, a command frame contains the “address” of the error-correcting entity to which it is transmitted while a response frame contains the “address” of the error-correcting entity transmitting the frame. For a given error-corrected connection, the DLCI value of the address field remains the same but the C/R bit changes, as defined by Table 6/V.42.

TABLE 6/V.42

**Command/response bit usage**

Command/response	Direction			C/R value
Command	Originator	→	Answerer	1
	Answerer	→	Originator	0
Response	Originator	→	Answerer	0
	Answerer	→	Originator	1

8.2.1.3 *Address field extension (EA) bit*

According to the rules of HDLC, the range of the address field may be extended by reserving the first transmitted bit of each octet of this field to indicate whether the octet is the last one of the field. Within the scope of this Recommendation, the address field is limited to a maximum of two octets.

When the EA bit is set to 1 in an octet, it signifies that this octet is the last octet of the address field. When the EA bit is set to 0, it signifies that another octet of the address field follows.

8.2.2 *Control field format*

The control field identifies the type of frame, which will be a command or response. The control field will contain sequence numbers, where applicable.

Three types of control-field formats are specified: numbered information transfer (I format), supervisory functions (S format), and unnumbered information transfers and control functions (U format). The control-field formats are shown in Table 7/V.42.

TABLE 7/V.42

**Control field formats**

Format	Control field bits (modulo 128)								
	8	7	6	5	4	3	2	1	
I format	N(S)							0	Octet 3
	N(R)							P	4
S format	X	X	X	X	S	S	0	1	3
	N(R)							P/F	4
U format	M	M	M	P/F	M	M	1	1	3

N(S) Transmitter send sequence number

N(R) Transmitter receive sequence number

S Supervisory function bit

M Modifier function bits

P/F Poll when issued as a command  
Final bit when issued as a response

X Reserved and set to 0

8.2.2.1 *Information transfer (I) format*

The I format shall be used to perform an information transfer between error-correcting entities. The functions of N(S), N(R), and P are independent; that is, each I frame has an N(S) sequence number, an N(R) sequence number that may or may not acknowledge additional I frames received by error-correcting entity, and a P bit that may be set to 0 or 1.

### 8.2.2.2 *Supervisory (S) format*

The S format shall be used to perform supervisory control procedures on the error-corrected connection, such as acknowledge I frames, request retransmission of one or more I frames, and request temporary suspension of transmission of I frames. The functions of N(R) and P/F are independent; that is, each supervisory frame has an N(R) sequence number that may or may not acknowledge additional I frames received by the error-correcting entity, and a P/F bit that may be set to 0 or 1.

### 8.2.2.3 *Unnumbered (U) format*

The U format shall be used to provide additional connection control procedures and unnumbered information transfers. The U format does not include sequence numbers but does include a P/F bit that may be set to 0 or 1.

## 8.2.3 *Control field parameters and associated state variables*

The various parameters associated with the control-field formats are described in this section. The coding of the bits within these parameters is such that the lowest numbered bit within the parameter field is the least-significant bit.

### 8.2.3.1 *Poll/final (P/F) bit*

All frames contain the poll/final (P/F) bit. The P/F bit serves a function in both command frames and response frames. In command frames, the P/F bit is referred to as the P bit. In response frames, it is referred to as the F bit. The P bit set to 1 is used by an error-correcting entity to solicit (poll) a response frame from the peer error-correcting entity. The F bit set to 1 is used by an error-correcting entity to indicate the response frame transmitted as a result of a soliciting (poll) command.

### 8.2.3.2 *Variable and sequence numbers*

#### 8.2.3.2.1 *Modulus*

Each I frame is sequentially numbered and may have the value 0 through  $n$  minus 1 (where  $n$  is the modulus of the sequence numbers). The modulus equals 128 and the sequence numbers cycle through the entire range, 0 through 127.

*Note* – All arithmetic operations on state variables and sequence numbers contained in this Recommendation are affected by the modulus operation.

#### 8.2.3.2.2 *Send state variable V(S)*

Each connection shall have an associated  $V(S)$  when using I frame commands.  $V(S)$  denotes the sequence number of the next I frame to be transmitted.  $V(S)$  can take on the value 0 through  $n$  minus 1. The value of  $V(S)$  shall be incremented by 1 with each successive I frame transmission, and shall not exceed  $V(A)$  by more than the maximum number of outstanding I frames,  $k$ . The value of  $k$  may be in the range of  $1 \leq k \leq 127$ .

#### 8.2.3.2.3 *Acknowledge state variable V(A)*

Each connection shall have an associated  $V(A)$  when using I frame commands and supervisory frame commands/response.  $V(A)$  identifies the last frame that has been acknowledged by its peer ( $V(A) - 1$  equals the  $N(S)$  of the last acknowledged I frame).  $V(A)$  can take on the value 0 through  $n$  minus 1. The value of  $V(A)$  shall be updated by the valid  $N(R)$  values received from its peer (see § 8.2.3.2.6). A valid  $N(R)$  value is one that is in the range  $V(A) \leq N(R) \leq V(S)$ .

#### 8.2.3.2.4 *Send sequence number N(S)*

Only I frames contain  $N(S)$ , the send sequence number of transmitted I frames. At the time that an in-sequence I frame is designated for transmission, the value of  $N(S)$  is set equal to  $V(S)$ .

#### 8.2.3.2.5 *Receive state variable V(R)*

Each connection shall have an associated  $V(R)$  when using I frame commands and supervisory frame commands/responses.  $V(R)$  denotes the sequence number of the next in-sequence I frame expected to be received.  $V(R)$  can take on the value 0 through  $n$  minus 1. The value of  $V(R)$  shall be incremented by one with the receipt of an error-free, in-sequence I frame whose  $N(S)$  equals  $V(R)$ .

#### 8.2.3.2.6 *Receive sequence number N(R)*

All I frames and supervisory frames contain  $N(R)$ , the expected send sequence number of the next received I frame. At the time that a frame of the above types is designated for transmission, the value of  $N(R)$  is set equal to  $V(R)$ .  $N(R)$  indicates that the error-correcting entity transmitting the  $N(R)$  has correctly received all I frames numbered up to and including  $N(R) - 1$ .

8.2.4 *Frame types*

8.2.4.1 *Commands and responses*

The command and response frames listed in Table 8/V.42 are used by either error-correcting entity. For purposes of the LAPM procedures, those frame types not identified in Table 8/V.42 are classified as undefined command and/or response control fields; the actions to be taken are specified in § 8.5.5.

The commands and responses in Table 8/V.42 are defined in §§ 8.2.4.2 through 8.2.4.14.

TABLE 8/V.42  
**Commands and Responses**

Format	Commands	Responses	Encoding								
			8	7	6	5	4	3	2	1	
Information transferion	I (information)		N(S)							0	Octet 3
			N(R)							P	4
Supervisory	RR (receive ready)	RR (receive ready)	0	0	0	0	0	0	0	1	3
			N(R)							P/F	4
	RR (receive not ready)	RR (receive not ready)	0	0	0	0	0	1	0	1	3
			N(R)							P/F	4
	REJ (reject)	REJ (reject)	0	0	0	0	1	0	0	1	3
			N(R)							P/F	4
	SREJ (selective reject)	SREJ (selective reject)	0	0	0	0	1	1	0	1	3
			N(R)							P/F = 0	4
Unnumbered	SABME (set asynchronous balanced mode extended)		0	1	1	P	1	1	1	1	3
		DM (disconnected mode)	0	0	0	F	1	1	1	1	3
	UI (unnumbered information)	UI (unnumbered information)	0	0	0	P/F	0	0	1	1	3
	DISC (disconnect)		0	1	0	P	0	0	1	1	3
		UA (unnumbered acknowledgement)	0	1	1	F	0	0	1	1	3
		FRMR (frame reject)	1	0	0	F	0	1	1	1	3
	XID (exchange identification)	XID (exchange identification)	1	0	1	P/F = 0	1	1	1	1	3
	TEST (test)		1	1	1	P=0	0	0	1	1	3

8.2.4.2 *Information (I) command*

The function of the information (I) command is to transfer, across an error-corrected connection, sequentially numbered frames containing data received from the V.24 interface and provided by the control function.

#### 8.2.4.3 *Set asynchronous balanced mode extended (SABME) command*

The SABME unnumbered command is used to place the addressed error-correcting entity into the *connected* state.

No information field is permitted with the SABME command. An error-correcting entity confirms acceptance of an SABME command by the transmission at the first opportunity of a UA response. Upon acceptance of this command, the error-correcting entity's V(S), V(A), and V(R) are set to 0. The transmission of an SABME command indicates the clearance of all exception conditions.

Previously-transmitted I frames that are unacknowledged when this command is processed remain unacknowledged and are discarded.

#### 8.2.4.4 *Disconnect (DISC) command*

The DISC unnumbered command is used to return to the *disconnected* state.

No information field is permitted with the DISC command. The error-correcting entity receiving the DISC command confirms the acceptance of a DISC command by the transmission of a UA response. The error-correcting entity sending the DISC command terminates the error-corrected connection when it receives the acknowledging UA or DM response.

Previously-transmitted I frames that are unacknowledged when this command is processed remain unacknowledged and are discarded.

#### 8.2.4.5 *Unnumbered information (UI) command/response*

Unnumbered information (UI) frames are used to convey control information outside the DTE information stream, which is carried by I frames. This control information may be associated with the DTE's information stream (e.g. a break signal). No sequence numbers are contained within the control field of a UI frame. The P/F bit of a UI frame is set to 0.

The encoding of this information field is given in § 12.3.

#### 8.2.4.6 *Receive ready (RR) command/response*

The RR supervisory frame is used by an error-correcting entity to:

- a) indicate it is ready to receive an I frame;
- b) acknowledge previously received I frames numbered up to and including  $N(R) - 1$  (as defined in § 8.4.3.1); and
- c) clear a busy condition that was indicated by the earlier transmission of an RNR frame by that same error-correcting entity.

In addition to indicating the status of an error-correcting entity, the RR command with the P bit set to 1 may be used by the error-correcting entity to ask for the status of its peer error-correcting entity.

#### 8.2.4.7 *Reject (REJ) command response*

The REJ supervisory frame is used by an error-correcting entity to request retransmission of I frames starting with the frame numbered  $N(R)$ . The value of  $N(R)$  in the REJ frame acknowledges I frames numbered up to and including  $N(R) - 1$ . New I frames pending initial transmission shall be transmitted following the retransmitted I frame(s).

Only one REJ exception condition for a given direction of information transfer is established at a time. The REJ exception condition is cleared (reset) upon the receipt of an I frame with an  $N(S)$  equal to the  $N(R)$  of the REJ frame.

The transmission of an REJ frame shall also indicate the clearance of any busy condition within the sending error-correcting entity that was reported by the earlier transmission of an RNR frame by that same error-correcting entity.

In addition to indicating the status of an error-correcting entity, the REJ command with the P bit set to 1 may be used by the error-correcting entity to ask for the status of its peer error-correcting entity.

#### 8.2.4.8 *Selective reject (SREJ) command/response*

Implementation of the selective reject (SREJ) frame is optional. When implemented, it is used by an error-correcting entity to request retransmission of the single I frame numbered  $N(R)$ . Within the scope of this Recommendation, the P/F bit of a SREJ frame is always set to 0. In this case, the  $N(R)$  of the SREJ frame does not indicate acknowledgement of any I frames.

Each SREJ exception condition is cleared upon receipt of the I frame with an N(S) equal to the N(R) of the SREJ frame. An error-correcting entity may transmit one or more SREJ frames, each containing a different N(R), with the P/F bit set to 0 before one or more earlier SREJ exception conditions have been cleared.

I frames that may have been transmitted following the I frame indicated by the SREJ frame shall not be retransmitted as the result of receiving an SREJ frame. Additional I frames awaiting initial transmission may be transmitted following the retransmission of the specific I frame requested by the SREJ frame.

#### 8.2.4.9 *Receive not ready (RNR) command/response*

The RNR supervisory frame is used by an error-correcting entity to indicate a busy condition; that is, a temporary inability to accept additional incoming I frames. The value of N(R) in the RNR frame acknowledges I frames numbered up to and including N(R) – 1.

In addition to indicating the status of an error-correcting entity, the RNR command with the P bit set to 1 may be used by the error-correcting entity to ask for the status of its peer error-correcting entity.

#### 8.2.4.10 *Unnumbered acknowledgement (UA) response*

The UA unnumbered response is used by an error-correcting entity to acknowledge the receipt and acceptance of the mode-setting commands (SABME or DISC). Received mode-setting commands are not processed until the UA response is transmitted. No information field is permitted with the UA response. The transmission of the UA response indicates the clearance of any busy condition that was reported by the earlier transmission of an RNR frame by that same error-correcting entity.

#### 8.2.4.11 *Disconnected mode (DM) response*

The DM unnumbered response is used by an error-correcting entity to report to its peer that the error-correcting entity is in the disconnected state and/or unable or unwilling to enter the connected state. No information field is permitted with the DM response.

#### 8.2.4.12 *Frame reject (FRMR) response*

The FRMR unnumbered response may be received by an error-correcting entity as a report of an error condition not recoverable by retransmission of the identical frame, i.e. at least one of the following error conditions resulting from the receipt of a valid frame:

- a) the receipt of a command or response control field that is undefined or not implemented;
- b) the receipt of a supervisory or unnumbered frame with incorrect length;
- c) the receipt of an invalid N(R); or
- d) the receipt of an I frame with an information field which exceeds the maximum established length.

An undefined control field is any of the control-field encodings not identified in Table 8/V.42.

A valid N(R) value is one that is in the range  $V(A) \leq N(R) \leq V(S)$ .

An information field which immediately follows the control field and consists of five octets is returned with this response and provides the reason for the FRMR response. This information-field format is given in Figure 9/V.42.

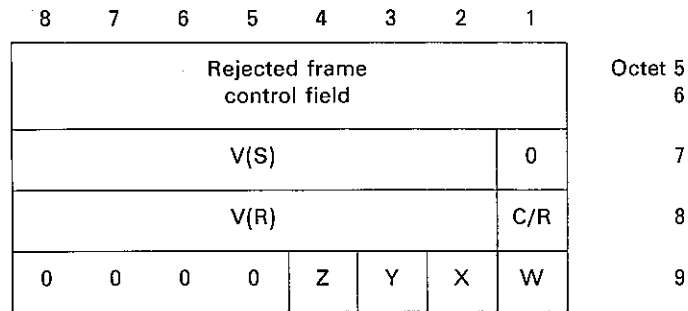

Rejected frame control field is the control field of the received frame which caused the frame reject. When the rejected frame is an unnumbered frame, the control field of the rejected frame is positioned in octet 5, with octet 6 set to 0000 0000.

V(S) is the current send state variable value of the error-correcting entity reporting the rejection condition.

C/R is set to 1 if the frame rejected was a response and is set to 0 if the frame rejected was a command.

V(R) is the current receive state variable value of the error-correcting entity reporting the rejection condition.

W set to 1 indicates that the control field received and returned in octets 5 and 6 was undefined or not implemented.

X set no 1 indicates that the control field received and returned in octets 5 and 6 was considered invalid because the frame contained an information field which is not permitted with this frame or is a supervisory or unnumbered frame with incorrect length. Bit W must be set to 1 in conjunction with this bit.

Y set to 1 indicates that the information field received exceeded the maximum established information-field length (N401) of the error-correcting entity reporting the rejection condition.

Z set to 1 indicates that the control field received and returned in octets 5 and 6 contained an invalid N(R).

Octet 7, bit 1 and octet 9, bits 5 through 8 shall be set to 0.

FIGURE 9/V.42

**FRMR information field format**

8.4.2.13 *Exchange identification (XID) command/response*

XID frames are used to exchange general identification information. No sequence numbers are contained within the control field of an XID frame. The P/F bit of an XID frame is set to 0.

Within the scope of this Recommendation, the information field of XID frames is used for negotiation/indication of parameter values and optional procedures. The encoding of this information field is given in § 12.2.

8.2.4.14 *Test (TEST) command*

Implementation of the TEST command frame is optional. When implemented, it is used to conduct a loop-back test between the two control functions. No sequence numbers are contained within the control field of a TEST frame. the P bit of a TEST command frame is set to 0.

An information field, not specified by this Recommendation, is also included in the frame. The control function initiating a loop-back test chooses the contents of the information field. The control function responding to a loop-back test returns the information field received from the initiator.

8.2.5 *Use of timers*

For various functions in the following sections, timers are used to ensure proper operation of the protocol. In these sections, the following terminology is used to describe timer operations:

- a) to *start* or *restart* a timer both imply that the timer is set to run from a predefined value;
- b) to *stop* a timer implies that it no longer runs and that the value of the timer at the time it is stopped is of no significance.



## 8.3 *Establishment of the error-corrected connection*

### 8.3.1 *General*

The procedures in this section are used to establish the error-corrected connection (i.e. go from a disconnected to a connected state) to allow the transfer of user data from V.24 interface to V.24 interface.

On receipt of an L-ESTABLISH request primitive from its control function, the error control function shall attempt to establish the error-corrected connection. The L-ESTABLISH request primitive is also used to re-establish the error-corrected connection (see § 8.4.9). In either case, the error-correcting entity transmits an SABME frame. All frames other than unnumbered format frames received at this time shall be ignored.

### 8.3.2 *Detailed procedures*

#### 8.3.2.1 *Establishment procedures*

A request to establish the error-corrected connection is initiated by the transmission of the SABME command. All existing exception conditions shall be cleared, the retransmission counter shall be reset, and timer T401 shall then be started (timer T401 is defined in § 9.2.1).

*Note 1* – To avoid misinterpretation of a received DM response frame, the SABME frame shall always be transmitted with its P bit set to 1.

*Note 2* – When sending the above frame as the first protocol frame following the detection phase (if used) or establishment of the physical connection (if the detection phase is not used), the originator shall first transmit flag patterns for a period of time sufficient to guarantee the transmission of at least 16 flag patterns.

Transmission of an SABME command as a result of receiving an L-ESTABLISH request primitive implies the discard of all data in queue.

*Note* – When an SABME frame is transmitted or received to establish or re-establish (see § 8.4.9) the error-corrected connection, any unacknowledged I frames remain unacknowledged with respect to the error control function. Responsibility for the contents of the information fields of such I frames reverts to the control function. Whether or not the contents of these information fields are reassigned to the error control function is decided by the control function.

An error-correcting entity receiving an SABME command, if it is able to establish the error-corrected connection (as indicated by receipt of an L-ESTABLISH response primitive from the control function in response to an L-ESTABLISH indication primitive), shall:

- respond with a UA response with the F bit set to the same binary value as the P bit in the received SABME command;
- set V(S), V(R), and V(A) to O;
- consider the error-corrected connection as established and enter the connected state;
- clear all existing exception conditions;
- clear any existing peer-receiver busy condition; and
- start timer T403 (timer T403 is defined in § 9.2.6) if implemented.

If the control function is unable to accept establishment of the error-corrected connection (as indicated by an L-RELEASE request primitive from the control function in response to an L-ESTABLISH indication primitive), the error-correcting entity shall respond to the SABME command with a DM response with the F bit set to the same binary value as the P bit in the received SABME command.

Upon receipt of the UA response with the F bit set to 1, the originator of the SABME command shall:

- stop timer T401;
- start timer T403 if implemented;
- set V(S), V(R), and V(A) to O; and
- consider the error-corrected connection as established (i.e. enter the connected state) and inform the control function by using the L-ESTABLISH confirm primitive.

Upon reception of a DM response with the F bit set to 1, the originator of the SABME command shall inform its control function of a failure to establish the error-corrected connection (by issuing an L-RELEASE indication primitive) and stop timer T401. DM responses with the F bit set to O shall be ignored in this case.

An L-RELEASE request primitive received during re-establishment initiated by the error-correcting entity shall be serviced on completion of the re-establishment procedure.

### 8.3.2.2 Procedure on expiry of timer T401

If timer T401 expires before the UA or DM response with the F bit set to 1 is received, the error-correcting entity shall:

- retransmit the SABME command as above;
- restart timer T401; and
- increment the retransmission counter (N400).

After retransmission of the SABME command N400 times and failure to receive a response, the error-correcting entity shall indicate this to the control function by means of the L-RELEASE indication primitive. Any data in queue shall be discarded.

The value of N400 is defined in § 9.2.2.

## 8.4 Transfer of user data from the V.24 interface

Having either transmitted the UA response to a received SABME command or received the UA response to a transmitted SABME command, information transfer may commence. This section deals with transfer of user data from the V.24 interface. Paragraph 8.6 deals with the transfer of control information.

### 8.4.1 Transmitting I frames

Data received by the error-correcting entity from the control function by means of an L-DATA request primitive shall be transmitted in an I frame. The control field parameters N(S) and N(R) shall be assigned the values V(S) and V(R), respectively. (V(S) shall be incremented by 1 at the end of the transmission of the I frame.

If timer T401 is not running at the time of transmission of an I frame, it shall be started. If timer T401 expires, the procedures defined in § 8.4.8 shall be followed.

If V(S) is equal to V(A) plus k (where k is the maximum number of outstanding I frames – see § 9.2.4), the error-correcting entity shall not transmit any new I frames, but may retransmit an I frame as a result of the error-recovery procedures as described in §§ 8.4.4 and 8.4.5.

When an error-correcting entity is in an own-receiver busy condition, it may still transmit I frames, provided that a peer-receiver busy condition does not exist.

*Note* – L-DATA request primitives received while in the timer-recovery condition (see § 8.5.3) shall be queued.

### 8.4.2 Receiving I frames

Independent of a timer-recovery condition, when an error-correcting entity is not in an own-receiver busy condition and receives a valid I frame whose N(S) is equal to the current V(R), the error-correcting entity shall:

- pass the information field of this frame to the control function using the L-DATA indication primitive;
- increment by 1 its V(R) and act as indicated below.

#### 8.4.2.1 P bit set to 1

If the P bit of the received I frame was set to 1, the error-correcting entity shall respond to its peer in one of the following ways:

- if the error-correcting entity receiving the I frame is still not in an own-receiver busy condition, it shall send an RR response with the F bit set to 1;
- if the error-correcting entity receiving the I frame enters the own-receiver busy condition upon receipt of the I frame, it shall send an RNR response with the F bit set to 1.

#### 8.4.2.2 P bit set to 0

If the P bit of the received I frame was set to 0 and:

- a) if the error-correcting entity is still not in an own-receiver busy condition:
  - if no I frame is available for transmission or if an I frame is available for transmission but a peer-receiver busy condition exists, the error-correcting entity shall transmit an RR response with the F bit set to 0; or
  - if an I frame is available for transmission and no peer-receiver busy condition exists, the error-correcting entity shall transmit I frame with the value of N(R) set to the current value of V(R) as defined in § 8.4.1; or

- b) if, on receipt of this I frame, the error-correcting entity is now in an own-receiver busy condition, it shall transmit an RNR response with the F bit set to 0.

When the error-correcting entity is in an own-receiver busy condition, it shall process any received I frame according to § 8.4.7.

### 8.4.3 *Sending and receiving acknowledgements*

#### 8.4.3.1 *Sending acknowledgements*

Whenever an error-correcting entity transmits an I frame or an RR, RNR, or REJ supervisory frame, N(R) shall be set equal to V(R).

#### 8.4.3.2 *Receiving acknowledgements*

On receipt of a valid I frame or an RR, RNR, or REJ supervisory frame, even in the own-receiver busy or the time-recovery condition, the error-correcting entity shall treat the N(R) contained in this frame as an acknowledgement for all the I frames it has transmitted with an N(S) up to and including the received N(R) – 1. V(A) shall be set to N(R). The error-correcting entity shall stop the timer T401 on receipt of a valid I frame or an RR, RNR, or REJ supervisory frame with the N(R) higher than V(A) (actually acknowledging some I frames), or an REJ frame with an N(R) equal to V(A). The error-correcting entity shall stop the timer T401 on receipt of an SREJ supervisory frame with an N(R) equal to or higher than V(A), even though there is no acknowledgement function associated with the N(R) contained in the SREJ frame.

*Note 1* – If an RR, RNR, or REJ supervisory frame with P bit set to 1 has been transmitted and not acknowledged, timer T401 shall not be stopped.

*Note 2* – Upon receipt of a valid I frame, timer T401 shall not be stopped if the error-correcting entity is in the peer-receiver busy condition (i.e. the remote error-correcting entity had indicated a busy condition).

If timer T401 has been stopped by the receipt of an I, RR, or RNR frame, and if there are outstanding I frames still unacknowledged, the error-correcting entity shall restart timer T401. If timer T401 then expires, the error-correcting entity shall follow the recovery procedure as defined in § 8.4.8 with respect to the unacknowledged I frames.

If timer T401 has been stopped by the receipt of an REJ frame, the error-correcting entity shall follow the retransmission procedures in § 8.4.4.

If timer T401 has been stopped by the receipt of an SREJ frame, the error-correcting entity shall follow the selective retransmission in § 8.4.5 and stop timer T401. If timer T401 then expires, the error-correcting entity shall follow the recovery procedure defined in § 8.4.8 with respect to the unacknowledged I frames.

### 8.4.4 *Receiving REJ frames*

On receipt of a valid REJ frame, the error-correcting entity shall act as follows:

- a) if it is not in the timer-recovery condition:
- clear an existing peer-receiver busy condition;
  - set its V(S) and its V(A) to the value of the N(R) contained in the REJ frame control field;
  - stop timer T401;
  - start timer T403 if implemented;
  - if it was an REJ command frame with the P bit set to 1, transmit an appropriate supervisory response frame (see Note 2 in § 8.4.6) with the F bit set to 1;
  - transmit the corresponding I frame as soon as possible, as defined in § 8.4.1, taking into account the items 1) to 3) below and the paragraph following items 1) to 3); and
  - note that a protocol violation has occurred if the received frame was an REJ response frame with the F bit set to 1.
- b) if it is the timer-recovery condition and it was an REJ response frame with the F bit set to 1:
- clear an existing peer-receiver busy condition;
  - set its V(S) and its V(A) to the value of the N(R) contained in the control field of the REJ frame;
  - stop timer T401;
  - start timer T403 if implemented; and
  - transmit the corresponding I frame as soon as possible, as defined in § 8.4.1, taking into account the items 1) to 3) below and the paragraph following items 1) to 3).

- c) if it is in the timer-recovery condition and it was an REJ frame other than an REJ response frame with the F bit set to 1:
  - clear an existing peer-receiver busy condition;
  - set its V(A) to the value of the N(R) contained in the control field of the REJ frame; and
  - if it was an REJ command frame with the P bit set to 1, transmit an appropriate supervisory response frame with the F bit set to 1 (see Note 2 in § 8.4.6).

Transmission of I frames shall take account of the following:

- 1) if the error-correcting entity is transmitting a supervisory frame when it receives the REJ frame, it shall complete that transmission before commencing transmission of the requested I frame;
- 2) if the error-correcting entity is transmitting an SABME command, a DISC command, a UA response, or a DM response when it receives the REJ frame, it shall ignore the request for retransmission; and
- 3) if the error-correcting entity is not transmitting a frame when the REJ is received, it shall immediately commence transmission of the requested I frame.

All outstanding unacknowledged I frames, commencing with the I frame identified in the received REJ frame shall be transmitted. Other I frames not yet transmitted may be transmitted following the retransmitted I frames.

#### 8.4.5 *Receiving SREJ frames*

If the optional selective retransmission procedure has been agreed for use on the error-corrected connection, then receipt of an SREJ frame results in the retransmission of the I frame whose N(S) is equal to the N(R) in the SREJ frame. No other I frames shall be retransmitted as a result of receiving the SREJ frame (however, I frames pending initial transmission may be transmitted).

Transmission of I frames shall take account of the following:

- 1) if the error-correcting entity is transmitting a supervisory frame when it receives the SREJ frame, it shall complete that transmission before commencing transmission of the requested I frame;
- 2) if the error-correcting entity is transmitting an SABME command, a DISC command, a UA response, or a DM response when it receives the SREJ frame, it shall ignore the request for retransmission; and
- 3) if the error-correcting entity is not transmitting a frame when the SREJ is received, it shall immediately commence transmission of the requested I frame.

If the optional selective retransmission procedure has not been agreed for use, then receipt of an SREJ frame shall be treated as an unrecognized command/response control field (see § 8.5.5).

#### 8.4.6 *Receiving RNR frames*

After receiving a valid RNR command or response, if the error-correcting entity is not engaged in a mode-setting operation (i.e. not transmitting an SABME or DISC frame), it shall set a peer-receiver busy condition and then:

- if it was an RNR command with the P bit set to 1, it shall respond with an RR response with the F bit set to 1 if the error-correcting entity is not in an own-receiver busy condition, and shall respond with an RNR response with the F bit set to 1 if the error-correcting entity is in an own-receiver busy condition; and
- if it was an RNR response with the F bit set to 1, an existing timer-recovery condition shall be cleared and the N(R) contained in this RNR response shall be used to update V(S).

The error-correcting entity shall take note of the peer-receiver busy condition and not transmit any I frames to the remote error-correcting entity.

*Note 1* – The N(R) in any RR or RNR command frame (irrespective of the setting of the P bit) will not be used to update the send state variable V(S).

The error-correcting entity shall then:

- treat the N(R) contained in the received RNR frame as an acknowledgement for all the I frames that have been (re)transmitted with an N(S) up to and including N(R) minus 1, and set its V(A) to the value of the N(R) contained in the RNR frame; and
- restart timer T401 unless an RR, RNR, or REJ supervisory response frame with F bit set to 1 is still expected.

If timer T401 expires, the error-correcting entity shall:

- if it is not yet in a timer-recovery condition, enter the timer-recovery condition and reset the retransmission count variable; or
- if it is already in a timer-recovery condition, add one to its retransmission count variable.

The error-correcting entity shall then:

- a) if the value of the retransmission count variable is less than N400:
  - transmit an appropriate RR, RNR, or REJ supervisory command (see Note 2 below) with P bit set to 1;
  - restart timer T401; and
- b) if the value of the retransmission count variable is equal to N400, initiate a re-establishment procedure as defined in § 8.4.9.

The error-correcting entity receiving the RR, RNR, or REJ supervisory frame with the P bit set to 1 shall respond, at the earliest opportunity, with an RR, RNR, or REJ supervisory response frame (see Note 2 below) with the F bit set to 1 to indicate whether or not its own-receiver busy condition still exists.

Upon receipt of the RR, RNR, or REJ supervisory response with the F bit set to 1, the error-correcting entity shall stop timer T401, and:

- if the response is an RR or REJ response, the peer-receiver busy condition is cleared and the error-correcting entity may transmit new I frames or retransmit I frames as defined in § 8.4.1 or 8.4.4, respectively; or
- if the response is an RNR response, the error-correcting entity receiving the response shall proceed according to the first paragraph of this section.

If a supervisory command (RR, RNR, or REJ) with P bit set to 0 or 1, or a supervisory response frame (RR, RNR, or REJ) with the F bit set to 0 is received during the enquiry process, the error-correcting entity shall:

- if the supervisory frame is an RR or REJ command frame or an RR or REJ response frame, clear the peer-receiver busy condition and if the supervisory frame received was a command with the P bit set to 1, transmit the appropriate supervisory response frame (see Note 2 below) with the F bit set to 1. However, the transmission or retransmission of I frames shall not be undertaken until the appropriate supervisory response frame with the F bit set to 1 is received or until the expiry of timer T401; or
- if the supervisory frame is an RNR command frame or an RNR response frame, retain the peer-receiver busy condition and if the supervisory frame received was an RNR command with P bit set to 1, transmit the appropriate supervisory response frame (see Note 2 below) with the F bit set to 1.

Upon receipt of an SABME command, the error-correcting entity shall clear the peer-receiver busy condition.

*Note 2* – If the error-correcting entity is not in an own-receiver busy condition and is in a reject-exception condition (that is, an N(S) sequence error has been detected and an REJ frame has been transmitted, but the requested I frame has not been received), the appropriate supervisory frame is the RR frame.

If the error-correcting entity is not in an own-receiver busy condition but is in an N(S) sequence error exception condition (that is, an N(S) sequence error has been detected but an REJ frame has not been transmitted), the appropriate supervisory frame is the REJ frame.

If the error-correcting entity is in its own-receiver busy condition, the appropriate supervisory frame is the RNR frame.

Otherwise, the appropriate supervisory frame is the RR frame.

#### 8.4.7 *Own-receiver busy condition*

When the error-correcting entity enters an own-receiver busy condition, it shall transmit an RNR frame at the earliest opportunity.

The RNR frame may be either:

- an RNR frame with the F bit set to 0; or
- if this condition is entered on receiving a command frame with P bit set to 1, an RNR response with the F bit set to 1; or
- if this condition is entered on expiry of timer T401, an RNR command with the P bit set to 1.

All received I frames with the P bit set to 0 shall be discarded, after updating V(A).

All received RR, RNR, REJ supervisory frames with the P/F bit set to 0 shall be processed, including updating V(A).

All received SREJ supervisory frames with the P/F bit set to 0 shall be processed as specified in § 8.4.5.

All received I frames with the P bit set to 1 shall be discarded, after updating V(A). However, an RNR response frame with the F bit set to 1 shall be transmitted.

All received RR, RNR, REJ supervisory frames with the P bit set to 1 shall be processed, including updating V(A). An RNR response with the F bit set to 1 shall be transmitted.

To indicate to the peer error-correcting entity the clearance of the own-receiver busy condition, the error-correcting entity shall transmit an RR frame or, if a previously-detected N(S) sequence error has not yet been reported, an REJ frame with its N(R) set to the current value of V(R) or an SREJ frame (if agreed for use).

The transmission of an SABME command or a UA response (in reply to an SABME command) also indicates to the peer error-correcting entity the clearance of the own-receiver busy condition.

#### 8.4.8 *Waiting acknowledgement*

The error-correcting entity shall maintain an internal retransmission count variable.

If timer T401 expires, the error-correcting entity shall:

- if it is not yet in the timer-recovery condition, enter the timer-recovery condition and reset the retransmission count variable; or
- if it is already in the timer-recovery condition, add one to its retransmission count variable.

The error-correcting entity shall then:

- a) if the value of the retransmission count variable is less than N400, restart. Timer T401 and transmit an appropriate supervisory command (see Note 2 in § 8.4.6) with the P bit set to 1; or
- b) if the value of the retransmission count variable is equal to N400, initiate a re-establishment procedure as defined in § 8.4.9.

The time-recovery condition is cleared when the error-correcting entity receives a valid RR, RNR, or REJ supervisory response frame with the F bit set to 1. If the received RR, RNR, or REJ supervisory frame N(R) is within the range from its current V(A) to its current V(S), inclusive, it shall set its V(S) to the value of the received N(R). Timer T401 shall be stopped if the received supervisory frame response is an RR or REJ response, and then the error-correcting entity shall resume with I frame transmission or retransmission, as appropriate. Timer T401 shall be stopped and restarted if the received supervisory response is an RNR response, to proceed with the enquiry process according to § 8.4.6.

#### 8.4.9 *Re-establishment of the error-corrected connection*

##### 8.4.9.1 *Criteria for re-establishment*

The criteria for re-establishing an error-corrected connection are defined in this section by the following conditions:

- the receipt, while in the connected state, of an SABME;
- the receipt of an L-ESTABLISH request primitive from the control function (see § 8.3.1);
- the occurrence of N400 retransmission failures while in the time-recovery condition (see § 8.4.8);
- the occurrence of a frame-rejection condition as identified in § 8.5.5;
- the receipt, while in the connected state, of an FRMR response frame (see § 8.5.6);
- the receipt, while in the connected state, of an unsolicited DM response with the F bit set to 0 (see § 8.5.7);
- the receipt, while in the time-recovery condition, of a DM response with the F bit set to 1.

##### 8.4.9.2 *Procedures*

In all re-establishment situations, the error-correcting entity shall follow the procedures defined in § 8.3. All locally-generated conditions for re-establishment will cause the transmission of the SABME.

In the case of re-establishment initiated by either error-correcting entity, the error-correcting entity shall also, if  $V(S) > V(A)$  prior to re-establishment, issue an L-ESTABLISH indication primitive to the control function and discard all I frames in queue.

In the case of re-establishment initiated by the control function or if an L-ESTABLISH request primitive occurs pending re-establishment, the L-ESTABLISH confirm primitive shall be used.

#### 8.5 *Exception condition reporting and recovery*

Exception conditions may occur as the result of errors on the physical connection or procedural errors by an error-correcting entity.

The error-recovery procedures that are available to effect recovery following the detection of an exception condition by an error-correcting entity are defined in this section.

#### 8.5.1 *N(S) sequence error*

An N(S) sequence error exception condition occurs in the receiver when a valid I frame is received containing an N(S) value that is not equal to the V(R) at the receiver. The action of the receiver depends on whether or not the optional selective-retransmission procedure has been agreed for use on the error-corrected connection. If it has, the information field of I frames whose N(S) is not equal to the V(R) at the receiver shall be held for subsequent delivery to the control function until the expected I frame (i.e. the I frame with its N(S) = V(R)) is received. If the selective-retransmission procedure has not been agreed for use, the information field of all I frames whose N(S) does not equal the V(R) shall be discarded.

In either case, the receiver shall not acknowledge (nor increment its V(R)) the I frame causing the sequence error, nor any I frames which may follow, until an I frame with the correct N(S) is received.

An error-correcting entity that receives one or more I frames having sequence errors but which are otherwise error-free, or subsequent RR, RNR, and REJ supervisory frames, shall use the N(R) and P/F bit setting contained in the control field to perform connection-control functions, for example, to receive acknowledgement of previously-transmitted I frames and to cause the error-correcting entity to respond if the P bit set to 1. Therefore, the retransmitted I frame may contain an N(R) value and P bit that are updated from, and therefore different from, the ones contained in the originally transmitted I frame.

Either the REJ frame or the SREJ frame is used by a receiving error-correcting entity to initiate an exception condition recovery (retransmission) following the detection of an N(S) sequence error.

Only one REJ exception condition for a given direction of information transfer shall be established at a time. Any number of SREJ exception conditions for a given direction of information transfer may be established at a time.

An error-correcting entity receiving an REJ command or response shall initiate sequential transmission (retransmission) of I frames starting with the I frame indicated by the N(R) contained in the REJ frame.

An error-correcting entity receiving an SREJ command or response frame shall initiate retransmission of the I frame indicated by the N(R) contained in the SREJ frame.

An REJ or SREJ exception condition is cleared when the requested I frame is received or when an SABME or DISC command is received.

Neither REJ or SREJ frames may be retransmitted (in case of loss of either, the expiration of timer T401 in the remote error-correcting entity will eventually cause resending of the requested I frame(s)). However, if examination of received I frames indicates that retransmission of the requested frame has occurred without having satisfied the reject condition, a new REJ or SREJ condition may optionally be established and the REJ or SREJ frame repeated.

#### 8.5.2 *N(R) sequence error*

An N(R) sequence error exception condition occurs in the transmitter when a valid supervisory frame or I frame is received that contains an invalid N(R) value.

A valid N(R) is one that is in the range  $V(A) \leq N(R) \leq V(S)$ .

The information field contained in an I frame that is correct in sequence and format may be delivered to the control function by means of the L-DATA indication primitive.

The error-correcting entity shall initiate re-establishment according to § 8.4.9.2.

#### 8.5.3 *Timer-recovery condition*

In an error-correcting entity, due to a transmission error, does not receive a single I frame or the last I frame(s) in a sequence of I frames, it will not detect an out-of-sequence exception condition and, therefore, will not transmit an REJ or SREJ frame.

The error-correcting entity that transmitted the unacknowledged I frame(s) shall, on the expiry of timer T401, take appropriate recovery action as defined in § 8.4.8 to determine at which I frame retransmission must begin.

#### 8.5.4 *Invalid-frame condition*

Any frame received that is invalid (as defined in § 8.1.3) shall be discarded, and no action shall be taken as a result of that frame.

As an optional procedure in response to a received frame with an FCS error, an error-correcting entity may transmit an REJ frame rather than ignoring the frame without taking any action. In all other respects, the received frame shall be discarded, without any indication to the control function of its receipt.

8.5.5 *Frame-rejection condition*

A frame-rejection condition results from one of the conditions described in § 8.2.4.1 (first paragraph) or § 8.2.4.12, items b, c and d.

Upon occurrence of a frame-rejection condition, the error-correcting entity shall initiate re-establishment (see § 8.4.9.2).

*Note* – For satisfactory operation, it is essential that a receiver is able to discriminate between invalid frames, as defined in § 8.1.3, and I frames with an information field that exceeds the maximum established length (see item d) in § 8.2.4.12). An unbound frame may be assumed and thus, discarded if two times the longest-permissible frame plus two octets are received without a flag detection.

8.5.6 *Receipt of an FRMR response frame*

Upon receipt of an FRMR response frame in the connected state, the error-correcting entity shall initiate re-establishment (see § 8.4.9.2).

8.5.7 *Unsolicited response frames*

The action to be taken on the receipt of an unsolicited response frame is defined in Table 9/V.42.

TABLE 9/V.42

**Actions taken on receipt of unsolicited response frame**

Unsolicited response frame	Disconnected state	Awaiting connection establishment	Awaiting connection release	Connected state	
				Not in timer-recovery condition	In timer-recovery condition
UA response F = 1	Ignore *	(Solicited)	(Solicited)	Ignore *	Ignore *
UA response F = 0	Ignore *	Ignore *	Ignore *	Ignore *	Ignore *
DM response F = 1	Ignore	(Solicited)	(Solicited)	Ignore *	(Solicited)
DM response F = 0	Establish connection	Ignore	Ignore	Re-establish connection	Re-establish connection
RR, RNR, REJ response: F = 1	Ignore	Ignore	Ignore	Ignore *	(Solicited)
RR, RNR, REJ response: F = 0	Ignore	Ignore	Ignore	(Solicited)	(Solicited)
SREJ response F = 1	Ignore	Ignore	Ignore	Re-establish connection	Re-establish connection
SREJ response F = 0	Ignore	Ignore	Ignore	(Solicited)	(Solicited)

*Note 1* – For ignore-cases marked with an asterisk (\*), the error-correcting entity may inform the control function of a protocol violation.

*Note 2* – Cases marked as (solicited) represent proper protocol operation.

8.6 *Transfer of user-control information*

User-control information is transferred using the information field of UI frames. A UI frame has the same value of DLCI as that used for transferring user data.

In general, the transfer of user-control information can be done immediately or in sequence with respect to user data. In the first case, the UI frame shall be transmitted immediately after transmission of the current I frame, if any, is completed. In the second case, the UI frame is transmitted only after acknowledgement is received for all



unacknowledged I frames. Whether subsequent transmission of I frames can resume immediately after the transmission of the UI frame or await some further event depends on the type of control information transmitted.

See § 8.13 for procedures for transmitting a break signal between V.24 interfaces.

## 8.7 *Orderly release of an error-corrected connection*

### 8.7.1 *General*

These procedures shall be used to return to the disconnected state.

The control function requests release of an error-corrected connection by use of the L-RELEASE request primitive.

All frames other than unnumbered frames received during the release procedures shall be ignored.

All outstanding L-DATA and L-SIGNAL request primitives and all associated frames in queue shall be discarded.

### 8.7.2 *Release procedure*

An error-correcting entity shall initiate a request for release of the connection by transmitting the disconnect (DISC) command.

*Note* – To avoid misinterpretation of a received DM response frame, the DISC frame shall always be transmitted with its P bits set to 1.

Timer T401 shall then be started and the retransmission counter reset.

An error-correcting entity receiving a DISC command while in the connected state shall transmit a UA response with the F bit set to the same binary value as the P bit in the received DISC command. An L-RELEASE indication primitive shall be passed to the control function, and the disconnected state shall be entered.

If the originator of the DISC command receives either.

- a UA response with the F bit set to 1; or
- a DM response with the F bit set to 1, indicating that the peer error-correcting entity is already in the disconnected state,

it shall enter the disconnected state and stop timer T401.

The error-correcting entity that issued the DISC command is now in the disconnected state and will notify its control function by means of the L-RELEASE indication primitive. The conditions relating to this state are defined in § 8.8.

### 8.7.3 *Procedure on expiry of timer T401*

If timer T401 expires before a UA or DM response with its F bit set to 1 is received, the originator of the DISC command shall:

- retransmit the DISC command as defined in § 8.7.2;
- restart timer T401; and
- increment the retransmission counter.

If the error-correcting entity has not received the correct response as defined in § 8.7.2, after N400 attempts to recover, the error-correcting entity shall enter the disconnected state and notify its control function by means of the L-RELEASE indication primitive.

## 8.8 *Disconnected state*

While in the disconnected state:

- the receipt of a DISC command shall result in the transmission of a DM response with F bit set to the value of the received P bit;
- on receipt of an SABME command, the procedures defined in § 8.3 shall be followed;
- on receipt of an unsolicited DM response with the F bit set to 0, the error-correcting entity shall, if it is able to and the control function is willing, initiate the error-correction establishment procedures by the transmission of an SABME (see § 8.3.2.1); otherwise, the DM shall be ignored; and
- all other frame type shall be discarded.

## 8.9 *Collision of unnumbered commands and responses*

### 8.9.1 *Identical transmitted and received set-mode commands*

If transmitted and received unnumbered set-mode commands (SABME or DISC) are the same, the error-correcting entities shall send the UA response at the earliest possible opportunity. The indicated state (the connected state if the commands were SABMEs, or the disconnected state if they were DISCs) shall be entered after receiving the UA response. The error-correcting entity shall notify its control function by means of the appropriate primitive.

### 8.9.2 *Different transmitted and received set-mode commands*

If the transmitted and received unnumbered set-mode commands (SABME or DISC) are different, the error-correcting entities shall issue a DM response at the earliest possible opportunity. Upon receipt of a DM response with the F bit set to 1, the error-correcting entity shall enter the disconnected state and notify its control function by means of an L-RELEASE indication primitive.

### 8.9.3 *Unsolicited DM response and SABME or DISC command*

A DM response with its F bit to 0 colliding with an SABME or DISC command shall be ignored.

## 8.10 *Negotiation/indication of parameter values and optional procedures*

### 8.10.1 *General*

Upon receipt of an L-SETPARM request primitive from its control function, an error-correcting entity shall initiate procedures using XID frames to negotiate/indicate parameter values and optional procedures with the remote DCE. If data transfer is possible (i.e. the error-corrected connection is in the connected state), then the error-correcting entity shall first transmit an RNR command frame with its P bit set to 1 (see § 8.4.7) to its peer and cease transmission of I frames.

*Note* – This is necessary since parameters/procedures to be negotiated/indicated may affect the procedures governing I frame transmission.

Upon completion of the negotiation/indication process, the affected parameter values/procedure settings shall be recorded. If a busy condition had been initiated as part of the process of changing parameter values/procedure settings (see above), then an indication of busy-condition clearance shall be transmitted.

Paragraphs 9 and 10 indicate which parameters and procedures, respectively, may be negotiated/indicated while § 12.2 indicates the encoding of the information field of the XID frame.

### 8.10.2 *Negotiation/indication procedure*

Upon receipt of an L-SETPARM request primitive, the error-correcting entity shall transmit an XID command frame. The information field of this frame shall be used to convey the parameters/procedures to be negotiated/indicated to the remote error-correcting entity. Timer T401 shall then be started and the retransmission counter, N400, reset.

*Note* – When sending the above frame as the first protocol frame following the detection phase (if used) or establishment of the physical connection (if the detection phase is not used), the originator shall first transmit flag patterns for a period of time sufficient to guarantee the transmission of at least 16 flag patterns.

On receipt of an XID command frame used for parameter/procedure negotiation/indication, the error control function shall issue an L-SETPARM indication primitive to its control function, passing it the contents of the information field.

On receipt of an L-SETPARM response primitive from its control function, an error control function shall return the indicated parameter values/procedure settings in the information field of an XID response frame.

If 32-bit FCS is requested and agreed during the protocol establishment phase (see § 7.2.2), a called DCE shall be capable of checking subsequent frames against both the 16-bit FCS (see § 8.1.1.6.1) and the 32-bit FCS (see § 8.1.1.6.2) simultaneously (a frame shall be discarded only if it fails both FCS checks). Until a SABME frame is received, the called DCE transmits frames with a 16-bit FCS. Receipt of a SABME frame with 16- or 32-bit FCS indicates use of the corresponding FCS for all subsequent frames (and checking of frames against both the 16-bit and 32-bit FCS may be disabled). Receipt of another XID command frame, with a 16-bit FCS, shall be responded to according to the negotiation/indication rules using an XID response frame with a 16-bit FCS.

On receipt of an XID response frames used for parameter/procedure negotiation/indication, the error control function shall inform its control function by an L-SETPARM confirm primitive of the values contained in the information field.

### 8.10.3 *Procedure on expiry of timer T401*

If timer T401 expires before receipt of the XID response frame, the error-correcting entity shall:

- retransmit the XID command as above;
- restart timer T410; and
- increment the retransmission counter (N400).

After retransmission of the XID command N400 times and failure to receive an XID response, the error-correcting shall notify the control function that the negotiation/indication procedure did not complete.

The value of N400 is defined in § 9.2.2.

### 8.11 *Loop-back test*

Upon receipt of an L-TEST request primitive from its control function, the error-correcting entity shall transmit a TEST command frame with its P bit set to 0. The information field of the TEST frame shall be used to convey the information provided by the control function. An L-TEST request primitive may be received at any time after completion of the protocol establishment phase. Its receipt does not affect the flow of other frames.

On receipt of a TEST command frame with its P bit set to 0, the error-correcting entity shall issue an L-TEST indication primitive to its control function that also conveys the contents of the information field from the received TEST frame.

### 8.12 *Monitoring functions*

#### 8.12.1 *General*

The procedural elements defined in the earlier parts of § 8 allow for the supervision of the error-corrected connection. This section describes procedures that may be used to provide this supervision function. The use of this function is optional.

#### 8.12.2 *Supervision during the connected state*

The connection verification is a service provided by the error-correcting entity to its control function. This implies that the control function is informed in case of a failure only. Furthermore, the procedure may be incorporated in the “normal” exchange of information and may become more efficient than a procedure based on the involvement of the control function.

The procedure is based on supervisory command frames (RR command, RNR command) and timer T403, and operates during the connected state as follows.

If there are no frames being exchanged on the error-corrected connection (neither new nor outstanding I frames, nor supervisory frames with a P bit set to 1), there is no means to detect a faulty error-corrected connection condition. Timer T403 represents the maximum time allowed without frames being exchanged.

If timer T403 expires, a supervisory command with a P bit set to 1 is transmitted. Such a procedure is protected against transmission errors by making use of timer T401 and the N400 retransmission count.

#### 8.12.3 *Connection verification procedures*

##### 8.12.3.1 *Start timer T403*

The timer T403 is started:

- when the connected state is entered; and
- in the connected state whenever timer T401 is stopped.

Upon receiving an I or supervisory frame, timer T403 will be restarted if timer T401 is not to be started.

##### 8.12.3.2 *Stop timer T403*

The timer T403 is stopped

- when, in the connected state, the timer T401 is started; and
- upon leaving the connected state.

### 8.12.3.3 *Expiry of timer T403*

If timer T403 expires, the error-correcting entity will act as follows (it should be noted that timer T401 is neither running nor expired):

- a) set the retransmission count variable to 0;
- b) enter the timer-recovery condition (see § 8.5.3);
- c) transmit a supervisory command with the P bit set to 1 as follows:
  - if there is not an own-receiver busy condition, transmit an RR command;
  - if there is an own-receiver busy condition, transmit an RNR command;
- d) start timer T401; and
- e) inform the control function after N400 retransmissions.

## 8.13 *Transfer of break*

### 8.13.1 *General*

Upon receipt of an L-SIGNAL request primitive from its control function, an error-correcting entity shall transmit a UI command frame with its P bit set to 0. The information field of the UI command frame shall be encoded to indicate a break (BRK) message and shall contain the break-handling option as indicated by the control function. If the L-SIGNAL request primitive includes a break length, it shall also be encoded in the information field of the UI frame. (See § 12.3 on the encoding of UI frames for transferring a break signal.) Actions taken by the DCE (including the error-correcting entity) are specified in Table 4/V42.

On receipt of a UI command frame indicating a BRK, the error-correcting entity shall issue an L-SIGNAL indication primitive to its control function, conveying the break-handling option and, if present, the break length and follow the actions specified in Table 5/V.42. On receipt of an L-SIGNAL response primitive from its control function, an error-correcting entity shall transmit a UI response frame as soon as possible with its F bit set to the same binary value as the received UI command frame. The information field of the UI response frame shall be encoded to indicate a break acknowledgement (BRKACK) message.

On receipt of a UI response frame with a BRKACK message in reply to a UI command frame conveying a BRK message, an error-correcting entity shall issue an L-SIGNAL confirm primitive to its control function.

*Note* – The exchange of UI frames, in and of itself, does not provide a confirmed service. The confirmed nature of the L-SIGNAL service provided to the control function, as described here, comes about through the association and interpretation of the contents of the information fields of the UI frames exchanged and not the association of a UI response frame with a previously-transmitted UI command frame.

### 8.13.2 *State variables and parameters*

#### 8.13.2.1 *Send and receive sequence numbers*

To distinguish between unique and duplicate UI frames carrying break information, an error-correcting entity shall perform a sequencing operation, modulo 2, on the information field of the UI frame. Bit 8 of the first octet of the information field shall be used for this purpose. As such, bit 8 serves as a break send sequence number, N(SB), in BRK message while it serves as a break receive sequence number, N(RB), in BRKACK messages.

#### 8.13.2.2 *Send state variable V(SB)*

The error-correcting entity shall maintain the break send state variable V(SB). V(SB) denotes the value of N(SB) in the next BRK message sent as a result of receiving an L-SIGNAL request primitive from the control function. V(SB) is complemented each time a transmitted BRK message is correctly acknowledged by a BRKACK message. Initially, when the physical connection has been established, V(SB) is set to zero; it is not reset even if the error-corrected connection is re-established per § 8.4.9.

#### 8.13.2.3 *Receive state variable V(RB)*

The error-correcting entity shall maintain the break receive state variable V(RB). V(RB) denotes the expected value of N(SB) in the next BRK message to be received. If N(SB) in the next received BRK message is equal to V(RB), then V(RB) shall be complemented prior to sending the BRKACK message. Initially, when the physical connection has been established, V(RB) is set to zero; it is not reset even if the error-corrected connection is re-established per § 8.4.9.

### 8.13.3 Break procedures

#### 8.13.3.1 Transmitting a BRK message

On receipt of an L-SIGNAL request primitive, the error-correcting entity shall transmit a BRK message in a UI command frame with its P bit set to 0. The error-correcting entity shall set N(SB) to the current value of V(SB), start the acknowledgement timer T401 (see § 9.2.1) and set the retransmission counter N400 (see § 9.2.2) to zero.

#### 8.13.3.2 Receiving a BRK message

When receiving a BRK message in a UI command frame, the error-correcting entity shall check whether N(SB) is equal to the current value of V(RB). If it is, the error-correcting entity shall issue an L-SIGNAL indication primitive to the control function, passing it the break-handling option and, if present, the length of break information. The error-correcting entity shall also complement the value of V(RB).

Upon receipt of an L-SIGNAL response primitive, the error-correcting entity shall transmit a BRKACK message in a UI response frame with N(RB) equal to the value of V(RB). The F bit of the UI response frame shall be set to the same binary value as the received UI command frame.

If N(SB) in the received BRK message is not equal to V(RB), then the error-correcting entity shall discard the BRK message and retransmit the previous BRKACK message with N(RB) equal to the current value of V(RB). No L-SIGNAL indication primitive shall be issued to the control function.

#### 8.13.3.3 Receiving a BRKACK message

When receiving a BRKACK message in a UI response frame, the error-correcting entity shall check whether N(RB) is equal to V(SB) + 1. If it is, the error-correcting entity shall complement V(SB), stop the acknowledgement timer T401, and issue an L-SIGNAL confirm primitive to the control function. If N(RB) is not equal to V(SB) + 1, the error-correcting entity shall ignore the BRKACK message.

#### 8.13.3.4 Expiration of the acknowledgement timer

If T401 expires before a BRKACK message is received to acknowledge the last BRK message transmitted, the error-correcting entity shall retransmit the BRK message with N(SB) equal to the current value of V(SB). No more than N400 retransmissions shall occur. Failure to receive a BRKACK after N400 retransmissions shall be reported to the control function.

## 9 System parameters

This section specifies the parameters needed for proper operation. For each parameter, it indicates:

- a) whether the parameter is used by the control function or the error control function;
- b) the definition of the parameter;
- c) whether information about the parameter is carried in XID frames and, if so, whether the information is for negotiation or indication purposes;
- d) for those parameters that are negotiated by XID frames, what the negotiation rules are; and
- e) what the default value of the parameter is.

### 9.1 Parameters of the control function

#### 9.1.1 Detection phase timer (T400)

The detection phase timer governs the amount of time that a control function in an originating or answering DCE waits for the ADP or the ODP, respectively (see § 7.2.1). Information about this timer is *not* carried in XID frames. The default value shall be 750 ms. (This is the estimated maximum propagation delay of all required transmissions including a single satellite link, plus sufficient time for the required transmissions at the data rate used in any V-Series modem that uses asynchronous-to-synchronous conversion.)

*Note* – Implementations may provide a mechanism for the user to set a value different from the default.

### 9.2 Parameters of the error control function

#### 9.2.1 Acknowledgement timer (T401)

The acknowledgement timer governs the amount of time that an error-correcting entity will wait for an acknowledgement before resorting to other action (e.g. transmitting a frame). Information about this timer is *not* carried

in XID frames. The two error-correcting entities associated with an error-corrected connection may operate with a different value of T401.

*Note* – This timer should be regarded as a logical parameter. That is, there can be one acknowledgement timer associated with each LAPM function (e.g. transmitting an I frame, transmitting a BRK message) that requires an acknowledgement to be received before expiration of this timer. This does not necessarily imply separate timer circuits.

Appendix IV shows the various factors that influence T401.

#### 9.2.2 *Maximum number of retransmissions (N400)*

N400 governs the maximum number of times that an error-correcting entity will re-attempt a procedure requiring a response. Information about this counter is *not* carried in XID frames. The two error-correcting entities associated with an error-corrected connection may operate with a different value of N400. While no default value is specified for N400, it shall have a minimum value of 1.

#### 9.2.3 *Maximum number of octets in an information field (N401)*

N401 governs the maximum number of octets that can be carried in the information field of an I frame, an XID frame, a UI frame, or a TEST frame transmitted by an error-correcting entity. The default value of N401 shall be 128 octets for both directions of data transmission. If the default is not satisfactory to the negotiation initiator, then a different value may be negotiated separately for each direction by use of the XID frame. The initiator of the negotiation shall indicate the N401 value it wishes to use for each direction (absence of a value indicates use of the default). The responder to the negotiation indicates the N401 value it wishes to use for each direction. The value chosen by the responder shall be between the value chosen by the initiator and the default value, inclusive, and shall be the value used during the operation of the error-corrected connection (unless overridden by a subsequent negotiation).

#### 9.2.4 *Window size (k)*

k governs the maximum number of I frames that an error-correcting entity can have outstanding (i.e. unacknowledged). The default value of k shall be 15 for both directions of data transmission. If the default is not satisfactory to the negotiation initiator, then a different value may be negotiated separately for each direction by use of the XID frame. The initiator of the negotiation shall indicate the k value it wishes to use for each direction (absence of a value indicates use of the default). The responder to the negotiation indicates the k value it wishes to use for each direction. The value chosen by the responder shall be between the value chosen by the initiator and the default value, inclusive, and shall be the value used during the operation of the error-corrected connection (unless overridden by a subsequent negotiation).

#### 9.2.5 *Reply delay timer (T402) – optional*

T402 is the maximum amount of time the error-correcting entity may wait, following receipt of any frame requiring a reply, before it initiates transmission of an appropriate reply in order to ensure that the reply frame is received by the remote error-correcting entity prior to expiration of the remote error-correcting entity's T401 timer. Information about this timer is *not* carried in XID frames. If this timer expires, then the reply that would have been returned prior to its expiration shall not be sent.

*Note* – The necessity for and operation of such a timer remains for further study.

#### 9.2.6 *Inactivity timer (T403) – optional*

T403 represents the maximum amount of time an error-correcting entity will allow to elapse without frames being exchanged on the error-corrected connection. Information about this timer is *not* carried in XID frames. The two error-correcting entities associated with an error-corrected connection may operate with a different value of T403. While no default value is specified for T403, it should take on relatively small values so that faults can be detected early.

#### 9.2.7 *DLCI values*

The DLCI value in the address field of a frame transmitted by the error control function serves to identify the connection between two peer error-correcting entities. Information about these values is not carried in XID frames. DLCI values are defined in Table 10/V.42.

TABLE 10/V.42

**Allocation of DLCI values**

DLCI value	Used for
0	DTE-to-DTE (V.24 interfaces) data
1-31	Reserved for future use by this Recommendation
32-62	Not reserved for use by this Recommendation
63	Reserved for control-function to control-function information (for further study)

*Note* – The DLCI assignments above are use with an address field consisting of a single octet (see § 8.2.1). Allocation of DLCI values that make use of optional octet 2A (see Figure 8/V.42) is for further study.

**10 Negotiation of optional procedures**

Within the scope of this Recommendation, there are three procedures that are optional for error control function operation. These are:

- a) selective retransmission, using an SREJ frame to request retransmission of only a single frame;
- b) loop-back test, where a control function can determine whether its peer is operational; and
- c) extended FCS, where a 32-bit FCS (rather than a 16-bit FCS) is used.

Use of any optional procedure requires agreement by both control functions using the mechanisms in § 8.10. The negotiation-initiator can choose whether to request use of a particular procedure. The procedure is used only if the negotiation-initiator requests its use and the responder agrees to its use.

**11 Control function-to-control function connection**

An error-corrected connection, with a DLCI value of 63, has been reserved for use as a control function-to-control function connection. The protocol used between two control functions is for further study.

**12 Encoding of information fields****12.1 Information fields in I frames**

The encoding of the information field of I frames is determined by the use of the error-corrected connection (e.g. when used to carry data received from the V.24 interface).

**12.2 Information fields in XID frames****12.2.1 General**

The general structure of the information field of an XID frame is based on the encoding in ISO Standard 8885 and is shown in Figure 10/V.42 below. The information field is composed of a number of subfields. These subfields are a format identifier subfield, zero or more data link layer subfields, and, possibly, a user data subfield.

When an octet encoding is shown for any of the subfields, it is shown with the right-most bit being the low-order bit and the bit transmitted first.

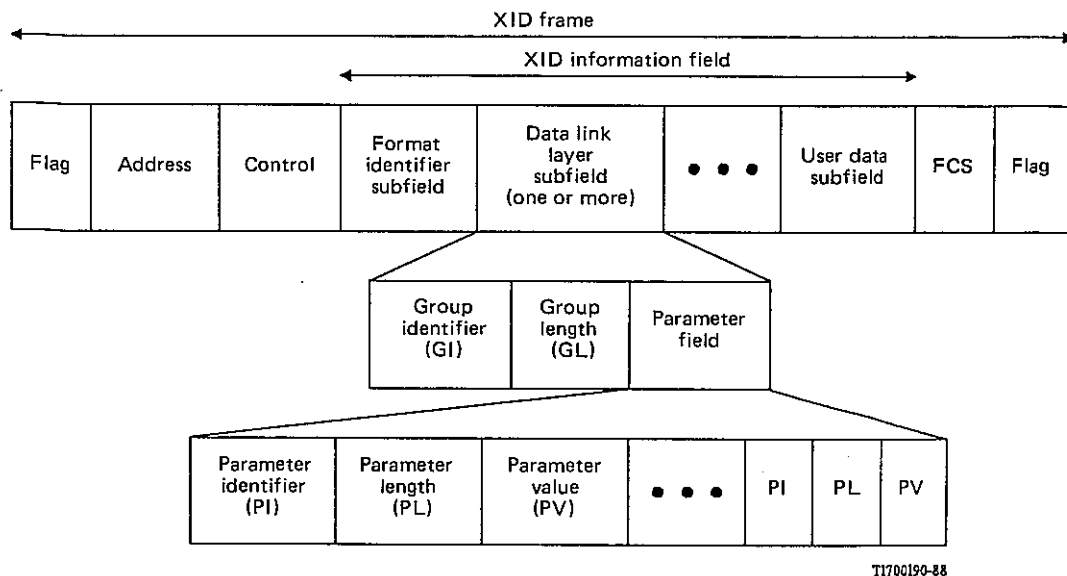

FIGURE 10/V.42

**General format of XID information field**

12.2.1.1 *Format identifier subfield*

Format identifier (FI) subfield is one octet in length and is the first octet of the information field of the XID frame. In general, the FI is encoded such that it can designate 128 different formats standardized by ISO and 128 different formats defined by users. Each ISO-standardized format is associated with a different FI value. The only such format defined at this time is the “general purpose” format.

12.2.1.2 *Data link layer subfields*

Data link layer subfields are used to specify various data link layer characteristics, such as operational parameters. In terms of Figure 10/V.42, a data link layer subfield consists of a group identifier (GI) one octet in length, a group length (GL) two octets in length, and a parameter field (whose length is given by GL). The parameter field, in turn, is similarly decomposed into one or more sets of a parameter identifier (PI), a parameter length (PL), and a parameter value (PV) (the parameter length, however, is only one octet in length).

12.2.1.3 *User data subfield*

A GI has been defined to specify a user data subfield used in conjunction with the “general purpose” FI. This subfield follows all data link layer subfields, as Figure 10/V.42 shows. The subsequent information is bounded by the frame's FCS field.

For the purposes of this Recommendation, this subfield is also divided into sets of PIs, PLs, and PVs.

12.2.2 *Encoding for negotiation/indication of parameter values and optional procedures*

The information field shall be encoded as specified below. Fields that are not recognized are ignored.

*Format identifier subfield*

For negotiation/indication of parameter values and optional procedures, the FI subfield shall be encoded as “10000010” to indicate the ISO-standardized “general purpose” FI.

*Data link layer subfields*

Only the data link layer subfield associated with “parameter negotiation” shall be present. This subfield has a GI value of “10000000”. The length of this subfield (GL) is dependent on the actual information to be transmitted.

Each item to be negotiated and/or indicated is identified by a PI. Table 11/V.42 shows the items and their PI values.



### User data subfield

The user data subfield may be present independently of whether negotiation and/or indication is performed. This subfield has a GI value of “11111111”.

The only parameter within this subfield defined in this Recommendation at this time is a “manufacturer ID”. This parameter shall be identified by a PI value of “11111111”. The encoding of the associated PV subfield is manufacturer-specific. The high-order bit of the first octet of the PV field is used as follows:

- bit = 0: Manufacturer IDs not assigned by CCITT;
- bit = 1: CCITT-assigned manufacturer IDs (the assignment of these identifiers is for further study)

When receiving a manufacturer ID that is not recognized, the manufacturer ID field is ignored.

### 12.3 Information fields in UI frames

In the encodings below, bit 1 is the low-order bit and is transmitted first.

The first octet of the information field of a UI frame shall be encoded to indicate the usage of the field, as given in Table 12/V.42.

TABLE 11/V.42  
Parameter/Procedures

PI		Parameter/procedure	Units
Decimal	Binary		
3	0000011	HDLC optional functions	(Note 1)
5	0000101	Maximum length of information field (N401): transmit direction	bits (Note 2)
6	0000110	Maximum length of information field (N401): receive direction	bits (Note 2)
7	0000111	Window size (k): transmit direction	Frames
8	0001000	Window size (k): receive direction	Frames

*Note 1* – The length of this item is 3 octets (i.e., PL = 3). The bits in these octets constitute a 24-bit mask, each for a particular HDLC optional function. Bit 1 of this mask is the low-order bit octet 1 and is transmitted first; bit 9 is the low-order bit of octet 2; etc. The bits corresponding to the optional procedures used within this Recommendation are as follows:

- 3 Selective retransmission procedure (SREJ frame)
- 14 Loop-back test procedure (TEST frame)
- 17 Extended FCS procedure (32-bit FCS).

A bit position set to 1 indicates request/agreement to use the procedure. A bit position set to 0 indicates no request/no agreement to use the procedure.

For conformance with the encoding rules in ISO Standard 8885, the transmitter of an XID command frame shall set bit positions 2, 4, 8, 9, 12 et 16 to 1. The transmitter of an XID response frame shall also set these bit positions to 1, except bit position 16 shall be set to 0 if bit position 17 is set to 1. A receiver of these frames should ignore these bit positions.

*Note 2* – N401 is expressed in octets. However, for negotiation purposes, units of “bits” shall be used.

*Note 3* – The value of PL shall be the smallest number of octets needed to express the value of the parameter.

*Note 4* – Parameter values for PI equal to 5, 6, 7, and 8 shall be encoded in binary. Within an octet, the first bit transmitted shall be the lowest-order bit. Where multiple octets are needed to express a parameter value, the first octet transmitted shall contain the higher-order bits.

TABLE 12/V.42

### Encoding of octet 1 of the information field in a UI frame

Message type	Bits							
	8	7	6	5	4	3	2	1
BRK	x	1	0	0	0	0	0	0
BRKACK	x	1	1	0	0	0	0	0

*Note 1* – Encodings not shown in the table are reserved.

*Note 2* – The value of x is set as discussed below.

### 12.3.1 Encoding of BRK message

The encoding of a BRK message is shown in Figure 11/V.42. Bit 8 of octet 1 is used as a sequence number, modulo 2 (see § 8.13.2.1).

#### Break-handling option

The break-handling option is encoded as “DS”, where:

- the “D” bit (bit 8 of octet 2) shall indicate whether data previously accumulated but not yet delivered should be discarded:
  - D=0 indicates no discarding of data
  - D=1 indicates discarding of data
- the “S” bit (bit 7 of octet 2) shall indicate whether the break should be delivered in sequence:
  - S=0 indicates that the break shall be delivered in sequence with respect to data generated before the break.
  - S=1 indicates that the break shall precede all data previously received but not yet delivered

#### Break length

The break length, which is optional, is binary-encoded in octet 3 in units of 10 ms where bit 1 is the low-order bit. The value of “11111111” shall be used to indicate a break longer than 2.54 seconds. Absence of a break length in a received BRK message shall be interpreted as a break of default length.

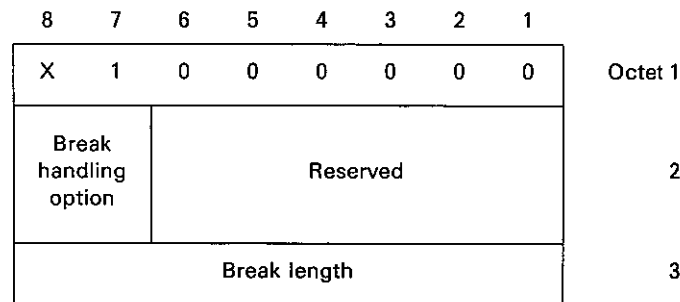

- [7] ISO 4335, *Data communication – High-level data link control elements of procedures*
- [8] ISO 7809, *Data communication – High-level data link control procedures – Consolidation of classes of procedures*
- [9] ISO 8885, *Data communication – High-level data link control procedures – General purpose XID frame information field content and format*

## ANNEX A

(to Recommendation V.42)

### **Operation of the error control function – Alternative procedure**

#### A.1 *General*

This Annex specifies the frame structure and procedures for the proper operation of the alternative error-correcting procedure for DCEs.

#### A.2 *Format conventions*

See § 8.1.2.

#### A.3 *Start-stop, octet-oriented framing mode*

In this mode, the error-correcting entities operate on an octet data stream. The framing format for start-stop, octet-oriented framing mode is shown in Figure A-1/V.42. This framing mode requires the use of four special octet values (SYN, DLE, STX, and ETX) for transparency. The transparency method is described in § A.3.4 below.

Each octet is transmitted with a start and stop bit.

##### A.3.1 *Start-flag field*

All frames shall begin with the three-octet, start-flag sequence SYN-DLE-STX. The values for the flag sequence are shown in Figure A-1/V.42.

##### A.3.2 *Header field*

The contents of the header field are described in §§ A.6.2 and A.6.3.

##### A.3.3 *Information field*

The information field of a frame, when present, contains transparent user data.

8	7	6	5	4	3	2	1	
Start flag SYN								Octet 1
0	0	0	1	0	1	1	0	
DLE								2
0	0	0	1	0	0	0	0	
STX								3
0	0	0	0	0	0	1	0	
Header K octets								4 .
Information L octets								.
Stop flag DLE								N-3
0	0	0	1	0	0	0	0	
ETX								N-2
0	0	0	0	0	0	1	1	
Frame check sequence (FCS)								N-1 N

FIGURE A-1/V.42

**Frame format for start-stop, octet-oriented mode**

A.3.4 *Transparency*

The transmitting error-correcting entity shall examine the frame body (consisting of the header and information fields) and insert a DLE octet immediately following any occurrence of a DLE octet in the frame body octet stream. The receiving error-correcting entity shall examine the frame body and discard the second DLE of a two-octet DLE-DLE sequence. The first DLE is considered part of the frame body field. The DLE used in the start and end flag to delimit the STX and ETX control octets shall not be doubled, so that they shall be recognized as framing fields.

A.3.5 *End-flag field*

All frames shall end with the two-octet, end-flag sequence DLE-ETX (followed by the FCS field). The values for the flag sequence are shown in Figure A-1/V.42.

A.3.6 *Frame check sequence (FCS) field*

The FCS is a 16-bit sequence generated by the cyclic redundancy check (CRC) polynomial  $x^{16} + x^{15} + x^2 + 1$ . The frame body and ETX octet of the stop flag are included in the FCS calculation. The start flag and all DLE octets used to maintain data transparency (§ A.3.4) are excluded from the FCS calculation.

*Note* – The CRC polynomial used in this frame mode differs from that specified in § 8.1.1.6.1.

A.4 *Bit-oriented framing mode*

In this mode, the error-correcting entities operate on a bit data stream. The framing format for bit-oriented mode is shown in Figure A-2/V.42.

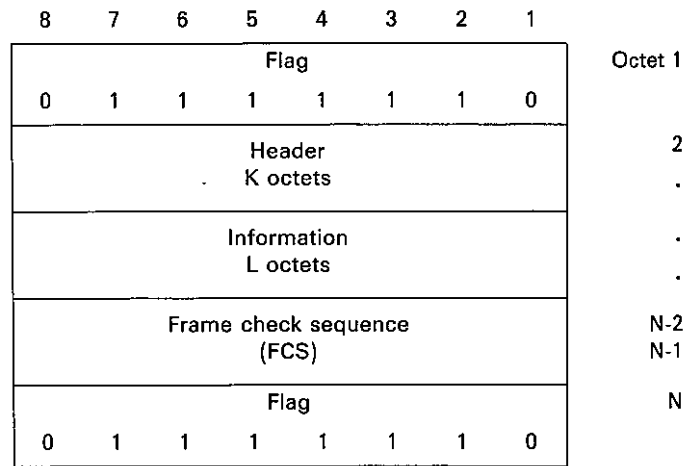

FIGURE A-2/V.42

**Frame format for bit-oriented mode**

A.4.1 *Flag sequence and transparency*

See § 8.1.1.2.

A.4.2 *Header field*

The contents of the header field are defined in §§ A.6.2 and A.6.3.

A.4.3 *Information field*

The information field of a frame, when present, contains transparent user data. The contents of the information field shall consist of an integer number of octets.

A.4.4 *Frame check sequence (FCS) field*

See § 8.1.1.6.1.

A.5 *Invalid frames*

For octet-oriented framing mode, see § 8.1.3, item d). For bit-oriented framing mode, see § 8.1.3, items a) to d).

A.6 *Alternative elements of procedure and field formats*

A.6.1 *General*

The elements of procedure define the message formats that are used on an alternative error-corrected connection.

A.6.2 *Header field – format*

The header field consists of fixed-length and variable-length parameters. Fixed-length parameters, or fixed parameters, have a predetermined length defined by the value of the type indication. Variable-length parameters, or variable parameters, have a length of three or more octets.

All valid header fields shall have a length indication (fixed parameter 0) and a type indication (fixed parameter 1) to identify the encoding for the remaining portion of the header field. The format is illustrated in Figure A-3/V.42.

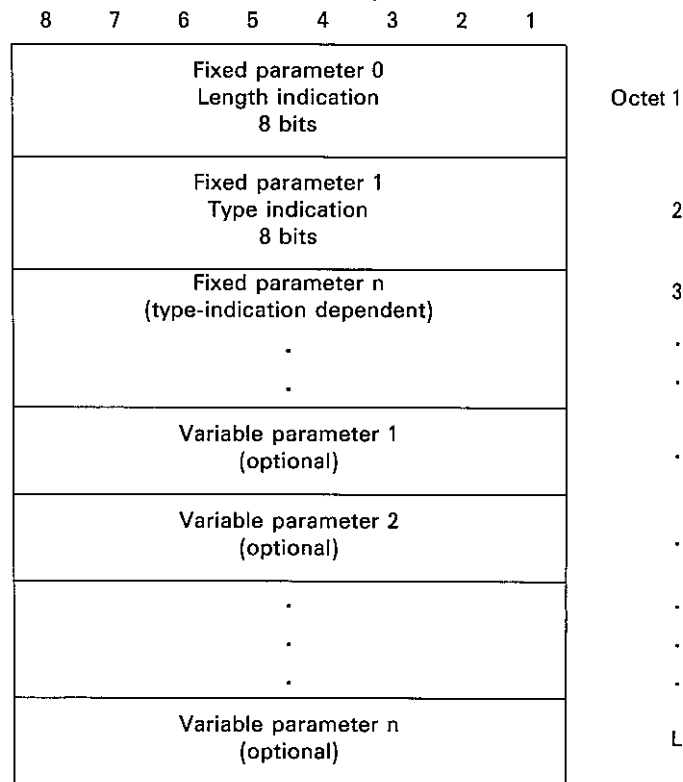

FIGURE A-3/V.42

**Header field format**

**A.6.2.1 Fixed parameter 0 – length indication**

The length indication shall be the first octet of the header field. The value of the length indication determines the total length of the header field, in octets. This length value does not include the length indication itself.

The value of 255 shall be used to indicate that the next two octets constitute a 16-bit extended length indication. The length indication requires three octets to represent lengths over 254 octets.

**A.6.2.2 Fixed parameter 1 – type indication**

The type indication shall be the second octet of the header field. The type indication identifies the header-field type and encoding for the remainder of the header field. The header-field types are shown in Table A-1/V.42.

TABLE A-1/V.42

**Header field types**

Type indication		Value
Link request	LR	1
Link disconnect	LD	2
Link transfer	LT	4
Link acknowledgement	LA	5
Link attention	LN	6
Link attention acknowledgement	LNA	7

A.6.2.3 *Fixed parameter 2 through n*

The presence of fixed parameters 2 through n is dependent on the header-field type.

A.6.2.4 *Variable parameters*

All variable parameters shall have three parts:

- a) parameter-type indication,
- b) parameter-length indication,
- c) parameter values.

The structure of a variable parameter is shown in Figure A-4/V.42.

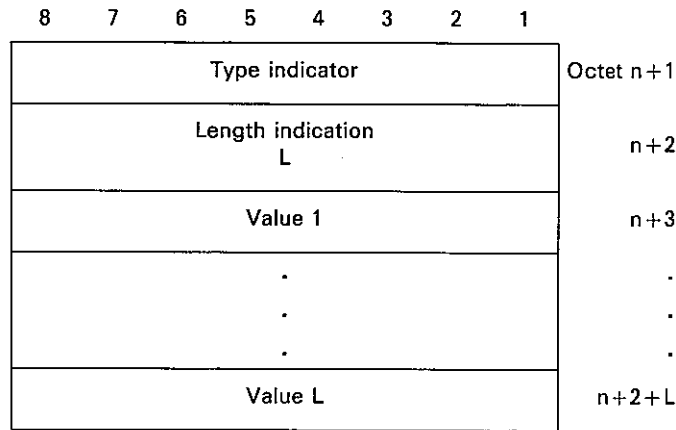

FIGURE A-4/V.42

**Variable parameter format**

A.6.2.4.1 *Variable parameter type indication*

The variable parameter-type indication shall consist of one octet, containing a value in the range from 1 to 254. For each header-field type, there is a separate and independent numbering sequence for variable parameter types.

A.6.2.4.2 *Variable parameter length indication*

The variable parameter-length indication shall be a single octet which specifies the number of octets contained in the variable parameter value.

A.6.4.2.3 *Variable parameter value*

The variable parameter field shall consist of one or more octets; the number of octets is specified by the parameter length indication.

A.6.3 *Header field – parameters*

A.6.3.1 *Modulus*

Each LT frame and LN frame is sequentially numbered and may have the value 0 through modulus minus 1 (where modulus is the modulus of the sequence numbers). The modulus is 256 and the sequence numbers cycle through the entire range.

A.6.3.2 *Send state variable V(S)*

The send state variable V(S) denotes the sequence number of the next in-sequence LT frame to be transmitted. V(S) can take on the values 0 through modulus minus 1. The value of V(S) is incremented by 1 with each successive LT frame transmission, but cannot exceed N(R) of the last received LA frame by more than the maximum number of outstanding LT frames (k). The value of k is defined in §§ A.6.4.1.6 and A.7.5.7.

Upon data phase initialization, V(S) is set to 1.

#### A.6.3.3 *Send sequence number N(S)*

Only LT frames contain  $N(S)$ , the send sequence number of transmitted LT frames. At the time that an in-sequence LT frame is designated for transmission, the value of  $N(S)$  is set equal to the value of the send state variable  $V(S)$ .

#### A.6.3.4 *Receive state variable V(R)*

The receive state variable  $V(R)$  denotes the sequence number of the next in-sequence LT frame expected to be received.  $V(R)$  can take on the values 0 through modulus minus 1. The value of  $V(R)$  is incremented by 1 by the receipt of an error-free, in-sequence LT frame whose send sequence number  $N(S)$  equals the receive state variable  $V(R)$ .

Upon data phase initialization,  $V(R)$  is set to 1.

#### A.6.3.5 *Receive sequence number N(R)*

All LA frames contain  $N(R)$ , the send sequence number of the last received LT frame. At the time that an LA frame is designated for transmission, the value of  $N(R)$  is set equal to the current value of the receive state variable  $V(R) - 1$ .  $N(R)$  indicates that the error-correcting entity transmitting the  $N(R)$  has received correctly all LT frames numbered up to and including  $N(R)$ .

#### A.6.3.6 *Attention send state variable V(SA)*

The attention send state variable  $V(SA)$  denotes the sequence number of the next in-sequence LN frame to be transmitted.  $V(SA)$  can take on the values 0 through modulus minus 1. The value of  $V(SA)$  is incremented by 1 with each successive transmission of an LN frame.

Upon data phase initialization,  $V(SA)$  is set to 1.

#### A.6.3.7 *Attention send sequence number N(SA)*

Only LN frames contain  $N(SA)$ , the attention send sequence number of transmitted LN frames. At the time that an in-sequence LN frame is designated for transmission, the value of  $N(SA)$  is set equal to the value of the attention send state variable  $V(SA)$ .

#### A.6.3.8 *Attention receive state variable V(RA)*

The attention receive state variable  $V(RA)$  denotes the sequence number of the next in-sequence LN frame expected to be received.  $V(RA)$  can take on the values 0 through modulus minus 1. The value of  $V(RA)$  is incremented by 1 by the receipt of an error-free, in-sequence LN frame whose attention send sequence number  $N(SA)$  equals the attention receive state variable  $V(RA)$ .

Upon data phase initialization,  $V(RA)$  is set to 1.

#### A.6.3.9 *Attention receive sequence number N(RA)*

The LNA frame contains  $N(RA)$ , the attention send sequence number of the last received LN frame. At the time that an LNA frame is designated for transmission, the value of  $N(RA)$  is set equal to the current value of the receive state variable  $V(RA) - 1$ .  $N(RA)$  indicates that the error-correcting entity transmitting the  $N(RA)$  has received correctly all LN frames numbered up to and including  $N(RA)$ .

#### A.6.3.10 *Receive credit state variable R(k)*

The receive credit state variable  $R(k)$  denotes the number of LT frames the receiver is able to receive. The number of received LT frames not acknowledged plus  $R(k)$  can not be greater than  $k$  (the maximum number of outstanding LT frames). System parameter  $k$  is defined in § A.7.5.7.

When the error-correcting entity enters the data phase,  $R(k)$  is set equal to  $k$ . During the data phase,  $R(k)$  is updated by the error-correcting entity as often as is required to accurately represent the receiver's ability to accept LT frames.

#### A.6.3.11 *Receive credit number N(k)*

Only LA frames contains  $N(k)$ . At the time that an LA frame is designated for transmission, the value of  $N(k)$  is set equal to the value of the receive credit state variable  $R(k)$ .  $N(k)$  indicates that the error-correcting entity transmitting the  $N(k)$  can properly receive LT frames numbered up to and including  $N(R) + N(k)$ .

#### A.6.3.12 *Send credit state variable S(k)*

The send credit state variable  $S(k)$  denotes the number of LT frames the sender is able to transmit without receiving additional credit from the receiver. The number of LT frames not acknowledged plus  $S(k)$  can not be greater than  $k$  (the maximum number of outstanding LT frames). System parameter  $k$  is defined in § A.7.5.7.



Upon data phase initialization, S(k) is set to k.

#### A.6.4 Protocol establishment phase

The alternative error-correcting procedure begins operation in the protocol establishment phase. In this phase, the error-correcting entity attempts to initialize an error-corrected connection for exchanging data.

The protocol messages in the connection establishment message exchange shall be transmitted in start-stop, octet-oriented mode. The framing mode for the subsequent phases of error-corrected connection operation is determined during the protocol establishment phase.

##### A.6.4.1 Link request (LR) frame

The link request (LR) frame is used to establish an error-corrected connection between two error-correcting entities with an active physical connection. The LR frame is also used to negotiate operational parameters to be in effect for the duration of the error-corrected connection (see § A.7.1.5).

The header-field parameters of the LR frame are shown in Table A-2/V.42. No information field is permitted with the LR frame.

TABLE A-2/V.42

**Link request header field parameters**

Parameter name	F V	M O	Value name	Value
Length indication	F	M	–	Variable
Type indication	F	M	LR	1
Constant parameter 1	F	M	–	2
Constant parameter 2	V	M	Type Length – – – – – –	1 6 1 0 0 0 0 255
Framing mode	V	M	Type Length Mode  (see § A.6.4.1.5)	2 1 2 ou 3
Maximum number of outstanding LT frames, k	V	M	Type Length k	3 1 Variable
Maximum information field length, N401	V	M	Type Length Max length (two octets)	4 2 Variable
Data phase optimization	V	M	Type Length Facilities  (see § A.6.4.1.8)	8 1 Variable

- F Fixed parameter
- M Mandatory parameter
- V Variable parameter
- O Optional parameter

##### A.6.4.1.1 Fixed parameter 0 – length indication

The value of the length indication shall be a computed value equal to the length of the header field, excluding the length indicator.

#### A.6.4.1.2 *Fixed parameter 1 – type indication*

The value of the type indication shall be an octet value of 1.

#### A.6.4.1.3 *Fixed parameter 2 – constant parameter 1*

This constant parameter shall be the third octet of the header field. The value of this constant is an octet value of 2.

#### A.6.4.1.4 *Variable parameter 1 – constant parameter 2*

This constant parameter shall be an octet sequence of value (1,6,1,0,0,0,255).

#### A.6.4.1.5 *Variable parameter 2 – framing mode parameter*

The framing mode parameter defines the framing mode to be used on the error-corrected connection.

Two-way simultaneous, start-stop, octet-oriented framing mode shall be represented by framing mode 2.

Two-way simultaneous, bit-oriented framing mode shall be represented by framing mode 3.

An error-correcting entity that supports framing mode 3 must also support framing mode 2.

The responding error-correcting entity sends a response LR with the framing mode parameter set to the lesser of the framing-mode values for the framing mode that is supported by the responding entity or the framing mode parameter value received in the initiating LR frame. The framing mode represented by the framing mode parameter value in the response LR determines the framing mode used on the error-corrected connection after the protocol establishment phase is completed.

#### A.6.4.1.6 *Variable parameter 3 – Maximum number of outstanding LT frames parameter, k*

The maximum number of outstanding LT frames parameter, k, defines the maximum number of LT frames with a maximum-length information fields that an error-correcting entity may send at a given time without waiting for an acknowledgement. The value of k shall never exceed the sequence number modulus minus 1.

Any value of k less than or equal to the maximum value may be used.

#### A.6.4.1.7 *Variable parameter 4 – maximum information field length parameter N401*

The maximum information-field length parameter, N401, defines the maximum length of user data, in octets, that can be sent in the information field of the link transfer (LT) frame.

#### A.6.4.1.8 *Variable parameter 8 – data phase optimization*

The data phase optimization parameter defines optional facilities may be supported on an error-corrected connection to improve data throughput.

The value of this parameter is a bit map that indicates protocol facilities to be used, as follows:

bit 1      1 = maximum information-field length of 256 octets

bit 2      1 = fixed field LT and LA frames

bit 3-8    reserved

Reserved bits are set to 0 on transmission and ignored upon receipt.

The responding error-correcting entity sends a response LR with a data phase optimization parameter if it agrees to use any data phase optimization facility. The facilities represented by the bit values in the response LR determine the facilities to be used on the error-corrected connection during the data phase.

#### A.6.4.2 *Link acknowledgement (LA) frame*

The link acknowledgement (LA) frame is used to confirm the completion of the protocol establishment phase of the alternative error-correcting procedure. The confirming LA is sent by the error-correcting entity that sent the initiating LR frame.

Upon sending or receiving the confirming LA of the connection-establishment, three-message exchange, the error-correcting correcting entity enters the data phase.

The header-field parameters of the link acknowledgement frame are shown in Table A-3a/V.42 and A-3b/V.42. No information field is permitted in the LA frame.

TABLE A-3a/V.42

**Link acknowledgement header field parameters  
(non-optimized data phase)**

Parameter name	F V	M O	Value name	Value
Length indication	F	M	–	7
Type indication	F	M	LA	5
Receive sequence number, N(R)	V	M	Type Length N(R)	1 1 8 bits
Receive credit number, N(k)	V	M	Type Length Credit	2 1 8 bits

- F Fixed parameter
- M Mandatory parameter
- V Variable parameter
- O Optional parameter

TABLE A-3b/V.42

**Link acknowledgement header field parameters  
(optimized data phase)**

Parameter name	F V	M O	Value name	Value
Length indication	F	M	–	3
Type indication	F	M	LA	5
Receive sequence number, N(R)	f	M	N(R)	8 bits
Receive credit number, N(k)	F	M	N(k)	8 bits

- F Fixed parameter
- M Mandatory parameter
- V Variable parameter
- O Optional parameter

*A.6.4.2.1 Fixed parameter 0 – length indication*

The value of the length indication shall be an octet value of 7 in a non-optimized data phase (see Table -a/V.42) and 3 in an optimized data phase (see Table A-3b/V.42).

*A.6.4.2.2 Fixed parameter 1 – type indication*

The value of the type indication shall be an octet value of 5.

*A.6.4.2.3 Variable parameter 1 – receive sequence number (non-optimized data phase)*

The receive sequence number parameter contains the value of the receive number, N(R), of the last correctly received LT frame. The value used for the receive sequence number in the protocol establishment phase confirming the LA shall be 0.

*A.6.4.2.4 Variable parameter 2 – receive credit number (non-optimized data phase)*

The receive credit number parameter contains the value of the maximum number of LT frames that can be sent by an error-correcting entity before it must suspend sending LT frames and wait for an acknowledgement.

The value used for the receive credit for the confirming LA is the value received as the receive credits in the response LR.

A.6.4.2.5 *Fixed format for variable parameters 1 and 2 (optimized data phase)*

When the fixed format LA frame facility is in effect during an optimized data phase, the receive sequence number and the receive credit number are included in the fixed part of the frame header field.

The received sequence number value octet is fixed parameter 2.

The received credit number value octet is fixed parameter 3.

The header-field parameter of the LA frame in an optimized data phase is shown in Table A-3b/V.42.

A.6.5 *Disconnect phase*

The alternative error-correcting procedure terminates operation in the disconnect phase. The disconnect phase may be entered from any other phase of error-corrected connection operation. The disconnect phase shall use the same framing mode as used in the phase prior to the disconnect phase.

A.6.5.1 *Link disconnect (LD) frame*

The link disconnect (LD) frame is used to terminate operation of an active error-corrected connection, or to reject an attempt to establish an error-corrected connection.

The header-field parameters of the LD frame are shown in Table A-4/V.42. No information field is permitted in the LD frame.

A.6.5.1.1 *Fixed parameter 0 – length indication*

The value of the length indication shall be an octet value of 4 for LD frames without variable parameter 2 and 7 for LD frames with variable parameter 2.

A.6.5.1.2 *Fixed parameter 1 – type indication*

The value of the type indication shall be an octet value of 2.

A.6.5.1.3 *Variable parameter 1 – reason code*

The reason-code parameter defines the reason for disconnection when sent in an LD frame on an active error-corrected connection, or the reason for failure to establish when sent in an LD frame in response to a connection attempt.

The reason codes are listed in Table A-5/V.42. Reason codes 1, 2 and 3 are used if the disconnect phase is the result of failure in the protocol establishment phase.

TABLE A-4/V.42

**Link disconnect header field parameters**

Parameter name	F V	M O	Value name	Value
Length indication	F	M	–	4 or 7 (see § A.6.5.1.1)
Type indication	F	M	LD	2
Reason code	V	M	Type Length Value	1 1 Variable (see § A.6.5.1.3)
User code	V	O	Type Length Value	2 1 Variable

- F Fixed parameter
- M Mandatory parameter
- V Variable parameter
- O Optional parameter

TABLE A-5/V.42

**Link disconnect reason code**

Code	Reason
1	Protocol establishment phase error, LR expected but not received
2	LR constant parameter 1 contains an unexpected value
3	LR received with incompatible or unknown parameter value
4-254	Reserved
255	User-initiated disconnect

*Note* – Code 3 is only used during the protocol establishment phase by the establishment initiator.

#### A.6.5.1.4 Variable parameter 2 – user code

The user code parameter is an optional parameter. If this parameter is present, this parameter defines the error-correcting user's reason for releasing the connection.

#### A.6.6 Data transfer phase

The alternative error-correcting procedure transfers user data in the data transfer phase.

##### A.6.6.1 link transfer (LT) frame

The function of the LT transfer (LT) frame is to transfer user data across the error-corrected connection in sequentially numbered information fields. The header-field parameters of the link transfer frame are shown in Table-6a/V.42 and Table A-6b/V.42. The information field shall contain one or more octets of user data up to the maximum information-field length negotiated during the protocol establishment phase. A null (zero octets) information field is not allowed.

##### A.6.6.1.1 Fixed parameter 0 – length indication

The value of the length indication shall be an octet value of 4 in a non-optimized data phase (see Table-a/V.42) and 2 in an optimized data phase (see Table A-6b/V.42).

##### A.6.6.1.2 Fixed parameter 1 – type indication

The value of the type indication shall be an octet value of 4.

##### A.6.6.1.3 Variable parameter 1 – send sequence number parameter (non-optimized data phase)

The send sequence number parameter defines the order of this frame and its information field in the data-sequence phase. At the time that an LT frame is designated for transmission, the value of this parameter is set equal to the send state variable V(S). The send state variable is initially 1, and is incremented modulo 256 with each successive LT frame transmission.

##### A.6.6.1.4 Fixed format for variable parameter 1 (optimized data phase)

When the fixed format LT frame facility is in effect during an optimized data phase, the send sequence number is included in the fixed part of the frame header field.

The send sequence number value octet is fixed parameter 2.

This format is shown in Table A-6b/V.42.

#### A.6.6.2 Link acknowledgement (LA) frame

The link acknowledgement (LA) frame is used to confirm the receipt of LT frames up to and including N(R). A single LA frame may acknowledge multiple LT frames.

##### A.6.6.2.1 Header field parameters

The header-field parameters of the LA frame are shown in Table A-3a/V.42 and Table A-3b/V.42; the parameters are described in §§ A.6.4.2.1 through A.6.4.2.5. No information field is permitted in the LA frame.

#### A.6.6.2.2 *LT frame credit*

The LT frame credit parameter contains the value that represents the number of LT frames with maximum-length information fields that the receiver is able to accept at the moment of LA frame transmission. A credit value of zero serves to halt the transmission of LT frames by the sender. Transmission of LT frames from the sender shall resume when an LA frame with a non-zero credit value is sent.

#### A.6.7 *Transfer of break*

The attention frame provides a reliable mechanism for signalling between error-correcting entities a break condition on the DTE/DCE interface.

TABLE A-6a/V.42

#### Link transfer header field parameters (non-optimized data phase)

Parameter name	F V	M O	Value name	Value
Length indication	F	M	–	4
Type indication	F	M	LT	4
Send sequence number, N(S)	V	M	Type Length N(S)	1  8 bits

- F Fixed parameter
- M Mandatory parameter
- V Variable parameter
- O Optional parameter

TABLE A-6b/V.42

#### Link transfer header field parameters (optimized data phase)

Parameter name	F V	M O	Value name	Value
Length indication	F	M	–	2
Type indication	F	M	LT	4
Send sequence number, N(S)	F	M	N(S)	8 bits

- F Fixed parameter
- M Mandatory parameter
- V Variable parameter
- O Optional parameter

#### A.6.7.1 *Link attention (LN) frame*

The header-field parameters of the link attention (LN) frame are shown in Table A-7/V.42. No information field is permitted in the LN frame.

TABLE A-7/V.42

**Link attention header field parameters**

Parameter name	F V	M O	Value name	Value
Length indication	F	M	–	7
Type indication	F	M	LN	6
Attention send sequence number, N(SA)	V	M	Type Length N(SA)	1 1 8 bits
Attention type	V	M	Type Length Break	2 1 1 = D&E 2 = non-D&E 3 = non-D&non-E

- F Fixed parameter
- M Mandatory parameter
- D Destructive break
- V Variable parameter
- O Optional parameter
- E Expedited break

**A.6.7.1.1 Fixed parameter 0 – length indication**

The value of the length indication shall be an octet value of 7.

**A.6.7.1.2 Fixed parameter 1 – type indication**

The value of the type indication shall be an octet value of 6.

**A.6.7.1.3 Variable parameter 1 – attention send sequence number**

The attention send sequence number, N(SA), parameter defines the order of this frame in the attention sequence space. At the time that an LN frame is designated for transmission, the value of this parameter is set equal to the attention send state variable V(SA). The attention send state variable is initially 1, and is incremented modulo 256 with each successive LN frame transmission.

**A.6.7.1.4 Variable parameter 2 – attention type**

The attention type parameter defines error-correcting entity handling of the break condition relative to the user data.

If destructive break handling is specified, the error-correcting entity shall flush all data transmitted or received before the break signal that is in transit to the correspondent entity or not delivered to the user.

If expedited break handling is specified, the error-correcting entity shall process the break signal immediately and ahead of any user data pending transmission.

See §§ 7.4 and 7.5.

**A.6.7.2 Link attention acknowledgement (LNA) frame**

The link attention acknowledgement (LNA) frame is used to acknowledge successful receipt of an LN frame. The header-field parameters of the LNA frame are shown in Table A-8/V.42. No information field is permitted in the LNA frame.

TABLE A-8/V.42

**Link attention acknowledgement header field parameters**

Parameter name	F V	M O	Value name	Value
Length indication	F	M	–	4
Type indication	F	M	LNA	7
Attention receive sequence number, N(RA)	V	M	Type Length N(RA)	1 1 8 bits

- F Fixed parameter  
M Mandatory parameter  
V Variable parameter  
O Optional parameter

**A.6.7.2.1 Fixed parameter 0 – length indication**

The value of the length indication shall be an octet of value 4.

**A.6.7.2.2 Fixed parameter 1 – type indication**

The value of the type indication shall be an octet of value 7.

**A.6.7.2.3 Variable parameter 1 – attention receive sequence number**

The attention receive sequence number parameter is used to acknowledge the receipt of LN frames up to and including N(RA).

**A.7 Description of the error-correcting procedure****A.7.1 Protocol establishment phase procedure****A.7.1.1 Initiating the establishment procedure**

The protocol establishment phase begins after a physical connection is established. The originating DCE's error-correcting entity (the initiator) begins the procedures of the protocol establishment phase. The answering DCE's error-correcting entity (the responder) shall be ready to respond to protocol messages immediately after the physical connection is established.

**A.7.1.2 Initiator procedure**

The initiator shall begin connection establishment by transmitting an LR frame to the responder entity and starting its timer T401 in order to determine when too much time has elapsed waiting for a reply. When a reply LR is received, the initiator performs parameter negotiation (see § A.7.1.5) to determine the parameter values which will characterize the error-corrected connection.

If negotiation is successful, the initiator transmits an LA frame and enters the data phase.

The initiator shall resend the initial LR if:

- timer T401 expires while waiting for the LR response, or
- a protocol message arrives with an incorrect frame check sequence.

After resending the initial LR, the initiator restarts its timer T401 and waits for a reply. If the timer T401 again expires or another protocol message arrives with an invalid frame check sequence, the initiator may reject the connection establishment. However, the initiator may also repeat this procedure.

**A.7.1.3 Responder procedure**

The responder shall begin a connection establishment attempt by starting timer T401. When an LR is received, the responder performs parameter negotiation (see § A.7.1.5) to determine the parameter values which will characterize the error-corrected connection.

If negotiation is successful, the responder transmits an LR to the initiator and starts its timer T401 in order to determine when too much time has elapsed waiting for an acknowledgement. When an acknowledgment LA is received, the responder enters the data phase.



The responder shall resend the response LR if:

- a) timer T401 expires while waiting for the LA response,
- b) a protocol message arrives with an incorrect frame check sequence, or
- c) another LR arrives.

After resending the response LR, the responder restarts timer T401 and waits for a reply. If the timer T401 again expires or if another protocol message arrives with an invalid frame check sequence, the responder rejects the connection establishment.

#### A.7.1.4 *Establishment rejection*

If the responder a) receives an LR with parameters that the responder is not prepared to accept, or b) does not receive an expected reply, then the responder shall enter the disconnect phase.

If the initiator a) receives an LR with parameters that fail the parameter negotiation, or b) does not receive an expected reply, then the initiator shall enter the disconnect phase.

#### A.7.1.5 *Parameter negotiation*

The error-correcting entity examines the parameters and parameter values of the LR it receives and compares them to its internal parameters. The negotiation rules are used to resolve parameter differences. If the negotiation rules can not resolve the parameter differences, then negotiation fails.

##### A.7.1.5.1 *Constant parameter 1*

Fixed parameter 1 shall always be of value 2. If another value is used, negotiation fails.

##### A.7.1.5.2 *Constant parameter 2*

This parameter must always be present. The negotiation rule accepts any value for constant parameter 2 and always produces the constant parameter value (see § A.6.4.1.3) as a result.

##### A.7.1.5.3 *Framing mode*

The negotiation rule selects the lower of the two values.

##### A.7.1.5.4 *Maximum number of outstanding LT frames, k*

The value for the maximum number of outstanding LT frames, k, will be the lower of the two values. If the resultant value is an unsupported number, then negotiation fails.

##### A.7.1.5.5 *Maximum information field length, N401*

The maximum information-field length, N401, will be the smaller of the two values. If the resultant value is an unsupported size, then negotiation fails.

##### A.7.1.5.6 *Unknown parameters*

During negotiation, the responder shall ignore all known parameters. When the responder sends its response LR, it includes only those parameters which it both received and understood.

#### A.7.2 *Disconnect phase procedures*

The LD frame is used to terminate a connection between two error-correcting entities. When an LD frame is received by an error-correcting entity, the entity shall terminate all protocol procedures.

##### A.7.2.1 *User initiated disconnect*

At the end of user data transfer, the user may initiate disconnection of the error-corrected connection. The interface between the user and the error-correcting entity is beyond the scope of this Recommendation.

A user-initiated disconnect shall cause the error-correcting entity to send an LD to terminate the error-corrected connection. After sending the LD, the error-correcting entity shall terminate the physical connection.

##### A.7.2.2 *Establishment rejection*

During the protocol establishment phase, both negotiation initiator and responder entities may reject the attempt to establish an error-corrected connection.

If the disconnect phase is initiated by a failure of the negotiation rules, the error-correcting entity shall send an LD to terminate the error-corrected connection. After sending the LD, the error-correcting entity shall terminate the physical connection.

If the disconnect phase is initiated by the expiration of timer T401 and the receipt of protocol messages with an invalid frame check sequence, the error-correcting entity shall send an LD to terminate the error-corrected connection. After sending the LD, the error-correcting entity shall terminate the physical connection.

If the disconnect phase is initiated by the expiration of timer T401 and no protocol messages were received, the error-correcting entity shall terminate operation without sending an LD. The physical connection shall continue to operate and data from the DTE interface will be directly presented to the Signal Converter for transmission over the physical connection in start-stop data transmission without error correction.

#### A.7.2.3 *Protocol errors*

If the error-correcting entity receives unexpected protocol messages or no response from the remote error-correcting entity, the local entity will release the connection by sending an LD to terminate the error-corrected connection. After sending the LD, the error-correcting entity shall terminate the physical connection.

#### A.7.2.4 *Executive retransmissions*

If the error-correcting entity repeats transmission of a frame and exceeds N400, the maximum number of attempts to complete a transmission, the local entity will release the connection by sending an LD to terminate the error-corrected connection. After sending the LD, the error-correcting entity shall terminate the physical connection.

### A.7.3 *Data phase procedures*

The data phase is entered once the physical connection is established and the protocol establishment phase is completed. The procedures that apply to the transmission of user data frames and acknowledgments during the information phase are described below.

The LT and LA frames are used to transfer data across an error-corrected connection.

#### A.7.3.1 *Sending an LT frame*

When an error-correcting entity has user data to transmit, the entity will transmit an LT with an N(S) equal to its current send state variable V(S). Each LT shall contain no more than N401 user octets in the information field. At the end of transmission of the LT frame, the error-correcting entity will increment, modulo 256, its send state variable V(S) by 1 and decrement S(k) by 1.

If timer T401 is not running at the time of transmission of an LT frame, it will be started. When  $k = 1$ , the timer is started after the error-correcting entity completes LT frame transmission. When  $k > 1$ , the timer is started when the error-correcting entity begins LT frame transmission.

If  $S(k) = 0$ , the error-correcting entity will not transmit any LT frames until S(k) is updated to a non-zero value through the receipt of an LA frame.

#### A.7.3.2 *Receiving an LT frame*

When an error-correcting entity receives a valid LT frame whose send sequence number N(S) is equal to the local receive state variable V(R), the error-correcting entity will accept the information field of this frame and increment by one, modulo 256, its receive state variable V(R).

Reception of an LT frame will start timer T402 if timer T402 is not already running.

Reception of an LT frame may also cause transmission of an acknowledgment (LA) frame (see § A.7.3.3).

##### A.7.3.2.1 *Reception of invalid frames*

When an error-correcting entity receives an invalid frame (see § A.5), it shall discard this frame.

##### A.7.3.2.2 *Reception of out-of-sequence LT frames*

When an error-correcting entity receives a valid LT frame whose send sequence number N(S) is not equal to the current receive state variable V(R), the error-correcting entity shall discard the information field of the LT frame and transmit an LA frame as described in § A.7.3.3.

The first reception of an LT frame with  $N(S) = V(R) - 1$ , however, is ignored and does not cause transmission of an LA frame.

##### A.7.3.2.3 *Reception of LT frames without receive credit*

When an error-correcting entity receives a valid LT frame when the receive credit  $R(k) = 0$ , the error-correcting entity shall discard the information field of the LT frame and transmit an LA frame as described in § A.7.3.3.

### A.7.3.3 *Sending of an LA frame*

An error-correcting entity sends an LA frame to acknowledge successful reception of one or more LT frames or to signal the correspondent entity of a condition which may require retransmission of one or more LT frames. The LA frame also communicates the receiver's ability to accept additional LT frames.

The transmission of an LA frame can occur under two sets of conditions grouped according to the value of  $k$ .

#### A.7.3.3.1 $k = 1$

When  $k = 1$ , an LA frame shall be sent if one of the following conditions occur. The conditions are listed in declining order of precedence.

- a) An invalid frame is received (§ A.5).
- b) An LT frame is received out-of-sequence (§ A.7.3.2.2).
- c) An LT frame is received without receive credit (§ A.7.3.2.3).
- d) An LT frame is properly received.

#### A.7.3.2.2 $k > 1$

When  $k > 1$ , an LA frame shall be sent if one of the following conditions occur. The conditions are listed in declining order of precedence.

- a) An invalid frame is received (§ A.5).
- b) An LT frame is received out-of-sequence (§ A.7.3.2.2).
- c) An LT frame is received without receive credit (§ A.7.3.2.3).
- d) Timer T404 expires.
- e) One or more correctly received LT frames have not yet been acknowledged and there is no user data to transmit.
- f) One or more correctly received LT frames have not yet been acknowledged, there is user data to transmit, and the number of correctly received but unacknowledged LT frames is equal to or greater than  $k/2$ .
- g) One or more correctly received LT frames have not yet been acknowledged, there is user data to transmit, and the number of correctly received but unacknowledged LT frames is less than  $k/2$ , and timer T402 expires.

Timer T404 shall be started when an error-correcting entity enters the data phase. Timer T404 shall be restarted whenever an LA frame is sent.

### A.7.3.4 *Receiving an LA frame*

When an LA frame is received, the receiving error-correcting entity will consider the  $N(R)$  contained in this frame as an acknowledgement for all LT frames it has transmitted with an  $N(S)$  up to and including the received  $N(R)$ . Timer T401 will be stopped if no additional LT frames remain unacknowledged, i.e., the received LA frame acknowledges all outstanding LT frames. Timer T401 will be restarted if additional LT frames remain unacknowledged.

An error-correcting entity that receives an LA frame uses the  $N(k)$  contained in the frame, minus the number of still unacknowledged LT frames in transit, as the new  $S(k)$  value.

### A.7.3.5 *Retransmission of LT frames*

An error-correcting entity will initiate retransmission of LT frames when it has sent LT frames that have been acknowledged and one of the following conditions occurs:

- a) An LA frame is received with an  $N(R)$  value equal to the  $N(R)$  of the last received LA frame.
- b) Timer T401 expires.

Retransmission starts with the first LT frame in sequence which has not yet been acknowledged.

If  $S(k) = 0$ , the error-correcting entity will not retransmit any LT frame until  $S(k)$  is updated to a non-zero value through the receipt of an LA frame.

Timer T401 shall be restarted at the time of retransmission of the first LT frame in sequence. When  $k = 1$ , the timer is started after the error-correcting entity completes LT frame transmission. When  $k > 1$ , the timer is started when the receiving entity begins LT frame transmission.

During retransmission, the receipt of an LA frame may acknowledge some of the LT frames pending retransmission; any unacknowledged LT frames are not retransmitted.

#### A.7.3.6 *Link failure detection*

A transmitting error-correcting entity maintains a count of the number of times a particular LT frame is retransmitted. If this count for any LT frame reaches N400, failure of the connection is assumed and the error-correcting entity enters the disconnect phase.

#### A.7.4 *Break-signalling procedures*

The error-correcting entity in the data phase shall use the break-signalling procedures when it receives a break signal from the user at the V.24 interface. The break signal shall cause the transmission of link attention (LN) frame. The procedures that apply to the transmission of the LN frame are described below.

The link attention (LN) frame and link attention acknowledgement (LNA) frames are used to transfer break signals across an error-corrected connection.

##### A.7.4.1 *Sending an LN frame*

When an error-correcting entity has a break signal to transmit, the entity will transmit an LN frame with an N(SA) equal to its current attention send state variable V(SA). Timer T401 shall be started after the LN is sent.

An LN frame can only be transmitted if there is no outstanding LN frame which has not yet been acknowledged.

If an expedited LN frame is specified, the LN frame shall be transmitted immediately if no transmission is in progress, or immediately following the transmission in progress, if any. Non-expedited LN frames are sent after the acknowledgement of any LT frames pending transmission or retransmission at the time of the LN request, but before any subsequent user data.

##### A.7.4.2 *Effect of a transmitted LN frame on data*

See Table 4/V.42.

##### A.7.4.3 *Receiving an LN frame*

An error-correcting entity shall begin the break-signalling procedures when the entity receives a valid LN frame whose attention send sequence number N(SA) is equal to the attention receive state variable V(RA). The error-correcting entity shall accept this frame and increment its attention receive state variable V(RA) by one, modulo 256. If a valid LN frame is received with N(SA) less than V(RA), the error-correcting entity shall ignore the break signal of the LN frame.

Reception of any valid LN frame shall cause transmission of an attention acknowledgement (LNA) frame by the error-correcting, as described in § A.7.4.5.

##### A.7.4.4 *Effect of a received LN frame on data*

See Table 5/V.42.

##### A.7.4.5 *Sending an LA frame*

An error-correcting entity uses an LNA frame to acknowledge successful reception of an LN frame. It is transmitted in response to receipt of a valid LN frame. The LNA frame shall contain an N(RA) value equal to the N(SA) value contained in the received LN frame.

##### A.7.4.6 *Receiving an LNA frame*

A received LNA frame that contains N(RA) shall be the acknowledgment for the LN frame transmitted with an N(SA) equal to the received N(RA). If the received N(RA) is equal to N(SA) for the outstanding LN frame, timer T401 will be stopped and the attention send state variable V(SA) be incremented by 1, modulo 256.

After proper receipt of the LNA frame to acknowledge the outstanding LN frame, the break-signalling procedure is completed and the error-correcting entity resumes the sending of user data.

##### A.7.4.7 *Retransmission of LN frames*

At the expiration of timer T401, the error-correcting entity will retransmit the unacknowledged LN frame. The unacknowledged LN frame will also be retransmitted if an LNA frame is received with an N(RA) value less than N(SA).

Timer T401 shall be restarted at the time of transmission of the LN frame.

A.7.4.8 *Link failure protection*

A transmitting error-correcting entity shall maintain a count of the number of times a particular LN frame is retransmitted. If this count for any LN frame reaches N400, failure of the connection is assumed and the error-correcting entity enters the disconnect phase.

A.7.5 *List of error-correction system parameters*

A.7.5.1 *Timer T401 – acknowledgment timer*

The period of timer T401, at the end of which retransmission of a frame may be initiated, shall take into account whether T401 is started at the beginning or the end of the transmission of a frame.

The period of timer T401 in the protocol establishment phase shall be in the range 0.5-9 seconds.

The period of timer T401 for transmission of LT and LN frames is dependent on the transmission speed of the physical connection and shall be determined by the following formula:

$$T_{401} \geq \frac{2((k/2) \times L_b(L_f + L_{lt} + N401) + L_b(L_f + L_{la}))}{\text{bps}} + T_{rt}$$

where

- $L_b$  is the number of bits (framing mode 2 = 10, framing mode 3 = 8)
- $L_r$  is the length of frame overhead (octet-oriented framing mode = 7, bit-oriented framing mode = 4)
- $L_{lt}$  is the length of LT header field (non-optimized data phase = 5, optimized data phase = 3)
- $L_{la}$  is the length of LA header field (non-optimized data phase = 8, optimized data phase = 4)
- $T_{rt}$  is the round trip propagation delay (including remote processing and queuing delay)
- bps is the physical connected speed in bits per second.

Typical values are shown in Table A-9/V.42.

TABLE A-9/V.42

**Timer T401 values for transmission of LT and LN frames**

Physical connection speed (in bit/s)	Period (in seconds) for N401 = 64	Period (in seconds) for N401 = 256
1200	6	16
2400	4	9

A.7.5.2 *Timer T402 – LA timer*

The period of timer T402, at the end of which an acknowledgement must be sent, shall indicate the maximum amount of time available to the error-correcting entity between transmission of the acknowledging frames in order to ensure receipt of acknowledgments by the correspondent entity, prior to timer T401 expiring at the correspondent entity (timer T402 = 0.5 timer T401).

A.7.5.3 *Timer T403 – inactivity timer*

The error-correcting entity may, optionally, support a timer T403 with a period of at least 59 seconds. The period of timer T 403 shall be used by an error-correcting entity to detect a half-open connection condition in which the correspondent entity is non-active and non-operational.

T403 is started upon entering the data phase and is restarted upon receipt of any valid frame.

If T403 is enabled and expires, the observing entity shall enter the disconnect phase and terminate the connection.

A.7.5.4 *Timer T404 – flow control timer*

The period of timer T404, at the end of which transmission of an acknowledgment frame is sent, shall be used during the data phase of an error-corrected connection. The period of timer T404 shall be dependent on the transmission rate of the physical connection and shall be determined by the Table A-10/V.42.

TABLE A-10/V.42

**Timer T404 values**

Physical connection speed (in bit/s)	Period (in seconds)
1200	7
2400 or faster	3

**A.7.5.5 Maximum number of retransmissions (N400)**

The value of N400 shall indicate the maximum number of attempts made by the error-correcting entity to complete the successful transmission of a frame to the correspondent entity.

The value of N400 shall be 12.

**A.7.5.6 Maximum number of octets in an information field (N401)**

The value of N401 shall indicate the maximum number of octets in the information field, excluding DLE octets (in start-stop, octet-oriented framing mode) or 0 bits (in bit-oriented framing mode) inserted for transparency, that an error-correcting entity is willing to accept from the correspondent entity.

The value of N401 shall be determined during the protocol establishment phase by LR variable parameter 4 (§ A.6.4.1.7).

*Note* – Applications should support a value of N401 = 64.

**A.7.5.7 Maximum number of outstanding LT frames (k)**

The value of k shall indicate a maximum number of sequentially numbered LT frames that the error-correcting entity may have outstanding (i.e., unacknowledged).

The value of k shall be determined during the protocol establishment phase by LR variable parameter 3 (§ A.6.4.1.6).

The value of k shall never exceed 255.

*Note* – Applications should support a value of k = 8.

**ANNEX B**

(to Recommendation V.42)

**Mapping of character formats to 8-bit format**

This Annex presents the mapping for converting between character formats used on the DTE/DCE interface and those used on the control function/error control function interface. Only support of the 10-bit DTE-to-DCE format is mandatory; support of the other formats shown here is optional. Character formats other than those listed below are not supported.

DTE/DCE: Total bits per character	Specific formats of octets supported	Control function to error control function formatting of octets)
11	Start/ 8 data/ 2 stop Start/ 8 data/ parity/ stop	8 data (parity or second stop bit is independently generated on each DTE/DCE interface)
10	Start/ 8 data/ stop	8 data
	Start/ 7 data/ 2 stop	7 data plus 0-bit pad in high-order bit
	Start/ 7 data/ parity/ stop	7 data plus parity as high-order bit
9	Start/ 7 data/ stop	7 data plus 0-bit pad in high-order bit
	Start/ 6 data/ 2 stop	6 data plus two 0-bit pads in two highest-order bits
	Start/ 6 data/ parity/ stop	6 data plus parity in next-to-high-order bit plus 0-bit pad in high-order bit
8	Start/ 6 data/ stop	6 data plus 0-bit pad in two highest-order bits
	Start/ 5 data/ 2 stop	5 data plus three 0-bit pads in three highest-order bits
	Start/ 5 data/ parity/ stop	5 data plus parity in third highest-order bit plus two 0-bit pads in two highest-order bits

## APPENDIX I

(to Recommendation V.42)

### Interworking with a non-error correcting DCE

This Appendix presents some considerations for interworking between an error-correcting DCE and a non-error-correcting DCE.

#### I.1 *Interworking with a non-error-correcting answerer*

A non-error-correcting answering DCE will pass the ODP through to its attached DTE. When passed through the asynchronous-to-synchronous converter of a DCE, the ODP produces a bit sequence that is interpreted by a large majority of DTEs as a series of IA5 characters of alternating parity (assuming that the DTE is using the following data format: one start bit, seven data bits, parity, one stop bit). The sequence may interfere with automatic baud rate or character format detection mechanisms of the Answerer or cause the inadvertent bypassing of prompts necessary to the establishment of non-error-corrected DTE-to-DTE communications. In this event, it will be necessary for the Originator to disconnect, manually disable error correction, and reattempt the call.

#### I.2 *Interworking with a non-error-correcting originator*

An error-correcting answerer called by a non-error-correcting originator will send only mark bits, which cause no observable effect at the originating DTE (since mark-idle is the "normal" state for an asynchronous DTE). After the detection phase timeout period, the error-correcting answerer will revert to non-error-correcting-DCE operation (i.e., non-error-correcting mode).

#### I.3 *Disposition of unrecognized bits*

If the detection phase is successful (i.e., the error-control DCEs each recognize the error-control capabilities of the other and move into the protocol establishment phase), none of the bits received during the detection phase (i.e., the ODP and the ADP) are delivered to the DTE.

If the detection phase fails, an error-correcting DCE reverts to the non-error-correcting-DCE operation. While the bits received during the failed detection phase were of no value to the error control function, they may indeed have been of value to the DTEs, since the non-error-control DCE will have already given its attached DTE the go-ahead to begin transmitting. There are several possible options for handling these bits, as discussed below; other possibilities also exist.

- a) The error-correcting DCE may discard the bits received during the detection phase timeout period. This disposition is the minimal implementation. If the DTE attached to the non-error-correcting DCE did transmit data during the timeout period, it would be necessary, in this case, for the transmission to be repeated if, indeed, the fact that the bits were discarded is recognizable (perhaps because the transmission was meant to evoke some type of response, which fails to materialize).

- b) The error-correcting DCE could buffer bits received during the detection phase and, upon termination of the detection phase, forward all of these bits to the DTE. Because of the possibility of continuous transmission from the other DTE, this optional mode of operation would likely require the implementation of fully buffered operation (i.e., every character received is held for forwarding after previously-received characters have been forwarded). While the non-error-correcting-DCE Recommendations do not require this mode of operation, the error-correcting DCE Recommendation does require fully buffered operation any way (as well as DTE/DCE flow control) because of the possibility of retransmission in the event of errors. Buffered and flow-controlled operation without error control could thus be considered a recognized subset of the error-correcting Recommendation that manufacturers could choose to implement and make available to users. This not only overcomes possible lost data during the detection phase, but also supports a constant-speed DTE/DCE interface during non-error-correcting operation. This Recommendation does not require this mode of operation to be available, however.

## APPENDIX II

(to Recommendation V.42)

### Data forwarding conditions

The control function is responsible for determining when to initiate data transfer for the purpose of transmitting the data received on the V.24 interface to the remote DCE. While it is beyond the scope of this Recommendation to specify when the control function initiates data transfer, several data-forwarding criteria are possible. These include the following:

- a) *Data forwarding character* (this corresponds to parameter 3 of Recommendation X.3): The control function may trigger transmission of data received based on reception across the V.24 interface of a pre-designated character or character sequence.
- b) *Idle timer* (this corresponds to Parameter 4 of Recommendation X.3): With this method, the control function starts a timer whenever a new character is received across the V.24 interface. If a pre-determined period passes without receipt of a further character, the control function instructs its error control function to transmit the accumulated characters.
- c) *Interval timer* : With this method, the control function accumulates characters from the V.24 interface for a period of time. When this time has elapsed, the control function instructs its error control function to transmit the accumulated characters.
- d) *Stream mode* : Upon receipt of a character from the V.24 interface, the control function instructs its error control function to commence transmission of data. As the error control function is transmitting an I frame to carry this data and prior to appending the FCS field to close out the I frame, the control function may provide to the error control function additional characters received from the V.24 interface for inclusion in the I frame.
- e) *Block mode* : The control function may accumulate a pre-determined number of characters before requesting their transmission by the error control function.

Other data-forwarding criteria may also be used by the control function. The control function may use several methods at the same time.

## APPENDIX III

(to Recommendation V.42)

### Cross-reference with CCITT Recommendations Q.920 and Q.921

The concepts and procedures used in the main body of this Recommendation are based mostly on CCITT Recommendations Q.920 and Q.921. This Appendix provides a complete cross-reference of sections of Q.920/Q.921 applicable to this Recommendation. In particular, this Appendix indicates, for each section of Q.920 and Q.921, whether:

- it is not applicable to this Recommendation (indicated by a “No” entry in the tables below);
- it is applicable in a general way (indicated by only a “Yes” entry in the tables below); or
- it is applicable in a direct fashion whereby the concepts and/or procedures are nearly similar or identical (indicated by a “Yes” entry in the tables below followed by the applicable V.42 section).



Section of Rec. Q.920	Applicable here?	Section of Rec. Q.920	Applicable here?
1	Yes	4.2	No
2	Yes (§ 6.4)	4.2.1	No
3	Yes	4.2.2	Yes
3.1	Yes (§ 8)	4.3	No
Figure 6	only <i>a</i> )	4.4	No
Figure 7	No	4.5	Yes
3.2	No	4.5.1	Yes
3.3	Yes	4.5.2	No
3.4.1	Yes	Table 1	Yes for only point-to-point acknowledged
3.4.2	Yes	4.6	No
3.4.3	No	5	TEI related procedures: No Other procedures: Yes
3.4.4	Yes	5.1	Yes
4	Yes	5.2	Yes
4.1	Yes	5.3	Yes

Section of Rec. Q.921	Applicable here?	Section of Rec. Q.921	Applicable here?
1	Yes	4.2	Yes
2	Yes (§ 8.1)	4.2.1	Yes
3	Yes	4.2.2	Yes
3.1	Yes	5	Yes
3.2	Yes (§ 8.2.1)	5.1	Yes
3.3	Yes	5.1.1	No
3.3.1	Yes (§ 8.2.1.3)	5.1.2	Yes
3.3.2	Yes (§ 8.2.1.2)	5.2	Yes
3.3.3	Yes	5.3	No
3.3.4	Yes	5.4	Yes
3.3.4.1	No	5.5	Yes (§ 8.3, 8.7-8.9)
3.3.4.2	No	5.6	Yes (§ 8.4.1-8.4.8)
3.4	Yes (§ 8.2.2)	5.7	Yes (§ 8.4.9)
3.5	Yes (§ 8.2.3)	5.8	Yes, except 5.8.8: (§ 8.5)
3.6	Yes (§ 8.2.4)	5.9	Yes
4	Yes	5.9.1	Yes (§ 9.2.1)
4.1	Yes (§ 6.4)	5.9.2	Yes (§ 9.2.2)
4.1.1	Yes	5.9.3	Yes (§ 9.2.3)
4.1.1.1	Yes	5.9.4	No
4.1.1.2	Yes	5.9.5	Yes (§ 9.2.4)
4.1.1.3	Yes	5.9.6	No
4.1.1.4	No	5.9.7	No
4.1.1.5	No	5.9.8	Yes (§ 9.2.5)
4.1.1.6	No	5.10	Yes (§ 8.12)
4.1.1.7	No	5.10.1	Yes (§ 8.12.1)
4.1.1.8	No	5.10.2	Yes (§ 8.12.2)
4.1.1.9	Yes	5.10.3	Yes (§ 8.12.3)
4.1.1.10	No	Annex A	No
4.1.1.11	No	Annex B	Yes
4.1.1.12	No	Annex C	No
4.1.1.13	No	Annex D	Yes
4.1.1.14	No	Appendix I	Yes
4.1.1.15	No	Appendix II	No
4.1.2	Yes (§ 6.4)	Appendix III	No
4.1.3	No	Appendix IV	Yes (§ 12.2.1)

## APPENDIX IV

(to Recommendation V.42)

### Factors for determining the acknowledgment timer

Several procedures of the error control function utilize an acknowledgment timer (T401) to ensure timely receipt of the acknowledgment from the remote error control function. To ensure receipt of such an acknowledgment before the transmitter's T401 expires, the two communicating error control functions must take into account the following time factors:

- a) the propagation delay involved in transmitting the frame requiring acknowledgment – ( $T_a$ )
- b) the time needed for the remote DCE to process the received frame and formulate the acknowledgment – ( $T_b$ )
- c) the maximum time allowed to complete transmission of those frames in the remote DCE's "transmit queue" (e.g., a frame already in progress of being transmitted or a frame that can not be displaced) – ( $T_c$ )
- d) the time needed to transmit the acknowledging frame – ( $T_d$ )
- e) the propagation delay involved in transmitting the acknowledging frame – ( $T_e$ )
- f) the processing time needed by the error control function to recognize the acknowledging frame – ( $T_f$ )

Given values for the above time limits, the value of the acknowledgement timer used by the transmitting error control function should then be set as follows:

$$T401 \geq T_a + T_b + T_c + T_d + T_e + T_f$$

## APPENDIX V

(to Recommendation V.42)

### Potential enhancements to LAPM protocol

During the development of V.42, several issues were raised that may lead to enhancements to the LAPM protocol (defined in the main body of V.42) or modifications to related V-Series Recommendations during the 1989-1992 Study Period. This Appendix briefly reviews these issues so that manufacturers are aware of the likely development path of V.42. Unless otherwise specified, the enhancements would be implemented as optional features.

#### V.1 *Data compression*

The performance of the error-correcting DCE may be enhanced considerably through the use of data compression on the character stream received from the DTE prior to transmission by the error control function.

#### V.2 *Forward error correction*

In certain applications of V-series modems, the bit error rate occurring over the physical connection may be sufficiently high to seriously reduce the throughput obtained by the error control function. An example of this type of application is the use of modems for data transmission over cellular radio links. Under these conditions, performance may be improved if the output of the error control function is encoded using a forward error-correction code prior to transmission over the physical connection.

#### V.3 *Statistical multiplexing*

Multiplexing of several streams of user data over a single physical connection may be performed in two ways. The procedures described in the LAPM definition are able to support multiple logical connections; therefore, a separate DLCI could be associated with each data stream. Alternatively, a single logical connection may be used to transport data from several DTEs that would require some means of structuring the information field of an I frame.

#### V.4 *End-to-end transport of interface state information*

A common requirement related to § V.3 is the ability to replicate the state of a subset of the V.24 interface leads at the remote DTE/DCE interface as, for example, described in Recommendation V.110. This could be accomplished by using a UI frame (see §§ 8.6 and 12.3) and encoding the interface circuit states within the information field, or by adding a header to each I frame.

#### V.5 *Issues related to control function-to-control function information exchange*

- a) A DLCI value has been reserved for the transport of control function-to-control function information between the peer-DCE control functions. The protocol for this information exchange has been left for further study.
- b) Loop-back testing between control functions is possible using the procedures defined within LAPM.

#### V.6 *Rate negotiation*

The DCE control functions may communicate information relating to the available transmission speeds and modulation schemes over the DLCI discussed in § V.5 so that a fallback/fall-forward strategy may be agreed. This has particular application in multi-standard DCEs where the ability to switch between, for example, V.32 and V.22 during the call may result in performance improvements due to poor line quality.

#### V.7 *Operation over an asymmetric or half-duplex physical connection*

Several issues were raised relating to operation over an asymmetric or half-duplex connection. The performance of the error-correcting protocol may be optimized for use over a specific physical connection; however, the means by which this is accomplished are for further study. One possible technique is described in § V.8 below. Another possible technique is given in Recommendation X.32 and is known as LAPX for operation on half-duplex connections.

#### V.8 *Multiple frame reject*

The selective reject mechanism defined for LAPM permits several I frames to be individually rejected; however, a control frame – SREJ – must be transmitted for each frame rejected (i.e., for each frame for which retransmission is requested). In certain applications, for example, for use with a half-duplex physical connection, performance would be significantly improved if a single control frame could be used to request retransmission of several I frames, not necessarily consecutive. The control frame (MREJ) could contain an information field with a bit map of length  $k$  bits, in which the state of each bit indicates the acknowledgment or rejection of the corresponding frame within the  $k$ -frame window of outstanding frames.

#### V.9 *Character format indication/negotiation*

While it is possible for the start-stop mode character format to be associated at each end with the DTE/DCE interface (i.e., that the format used by the DTE at each end of the connection may be different), certain inconsistencies would not be permitted. In the case of differences in the use of parity or the number of stop bits, it is sufficient that the data bits are carried end-to-end. If the character formats at the two DTE/DCE interfaces differ in the number of data bits, the call must be cleared or the DCEs negotiate a common format. This is for further study.

#### V.10 *Preservation of framing/parity errors*

When an 11-bit character format is used, there is no mechanism defined by which the state of the parity bit may be indicated to the remote DTE. In addition, other character-format errors detected at the DTE/DCE interface would not be signaled. There are two alternative options; to remove the requirement for octet alignment and, hence, allow a ninth or subsequent bits to be sent, or to send subsidiary information when an error is detected.

#### V.11 *Encryption*

The use of encryption within an error-correcting DCE has some advantages, specifically when used in conjunction with data compression. If encrypted data is received from the DTE, the properties that would normally be used to obtain data compression may be affected by the encryption process and, hence, poor compression achieved. The effectiveness of encryption employed after the data is compressed is higher, due to the lower redundancy within the encoded stream.

#### V.12 *ISDN compatibility*

Some advantage may be obtained from compatibility with ISDN access protocols in applications involving ISDN/GSTN interworking, i.e., where dial-up access to ISDN services or subscribers is required. LAPD-based protocols have been proposed for several applications within ISDN, for example, terminal adaptation.





## ITU-T RECOMMENDATIONS SERIES

Series A	Organization of the work of the ITU-T
Series B	Means of expression: definitions, symbols, classification
Series C	General telecommunication statistics
Series D	General tariff principles
Series E	Overall network operation, telephone service, service operation and human factors
Series F	Non-telephone telecommunication services
Series G	Transmission systems and media, digital systems and networks
Series H	Audiovisual and multimedia systems
Series I	Integrated services digital network
Series J	Transmission of television, sound programme and other multimedia signals
Series K	Protection against interference
Series L	Construction, installation and protection of cables and other elements of outside plant
Series M	TMN and network maintenance: international transmission systems, telephone circuits, telegraphy, facsimile and leased circuits
Series N	Maintenance: international sound programme and television transmission circuits
Series O	Specifications of measuring equipment
Series P	Telephone transmission quality, telephone installations, local line networks
Series Q	Switching and signalling
Series R	Telegraph transmission
Series S	Telegraph services terminal equipment
Series T	Terminals for telematic services
Series U	Telegraph switching
<b>Series V</b>	<b>Data communication over the telephone network</b>
Series X	Data networks and open system communications
Series Y	Global information infrastructure and Internet protocol aspects
Series Z	Languages and general software aspects for telecommunication systems