



INTERNATIONAL TELECOMMUNICATION UNION

ITU-T

TELECOMMUNICATION
STANDARDIZATION SECTOR
OF ITU

V.56 *bis*

(08/95)

**DATA COMMUNICATION OVER
THE TELEPHONE NETWORK**

**NETWORK TRANSMISSION MODEL FOR
EVALUATING MODEM PERFORMANCE
OVER 2 - WIRE VOICE GRADE CONNECTIONS**

ITU-T Recommendation V.56 *bis*

(Previously "CCITT Recommendations")

FOREWORD

The ITU-T (Telecommunication Standardization Sector) is a permanent organ of the International Telecommunication Union (ITU). The ITU-T is responsible for studying technical, operating and tariff questions and issuing Recommendations on them with a view to standardizing telecommunications on a worldwide basis.

The World Telecommunication Standardization Conference (WTSC), which meets every four years, establishes the topics for study by the ITU-T Study Groups which, in their turn, produce Recommendations on these topics.

The approval of Recommendations by the Members of the ITU-T is covered by the procedure laid down in WTSC Resolution No. 1 (Helsinki, March 1-12, 1993).

ITU-T Recommendation V.56 *bis* was prepared by ITU-T Study Group 14 (1993-1996) and was approved under the WTSC Resolution No. 1 procedure on the 29th of August 1995.

NOTES

1. In this Recommendation, the expression "Administration" is used for conciseness to indicate both a telecommunication administration and a recognized operating agency.
2. The status of annexes and appendices attached to the Series V Recommendations should be interpreted as follows:
 - an *annex* to a Recommendation forms an integral part of the Recommendation;
 - an *appendix* to a Recommendation does not form part of the Recommendation and only provides some complementary explanation or information specific to that Recommendation.

© ITU 1996

All rights reserved. No part of this publication may be reproduced or utilized in any form or by any means, electronic or mechanical, including photocopying and microfilm, without permission in writing from the ITU.

CONTENTS

	<i>Page</i>
1 Scope	1
2 References	2
3 Definitions	5
4 Description of model	5
4.1 Overview	5
4.2 Echo control requirements	5
4.3 Round-trip delay criteria	5
4.4 Modem impedance requirements	5
4.5 Model limitations	5
4.6 Digital impairment requirements	6
4.7 Network Model Coverage (NMC)	6
5 Impairment level set-up	6
Annex A – Attenuation and envelope delay distortion characteristics	22
Annex B – Minimizing test time	44
Appendix I – Rare intracontinental network model	46
I.1 Model description	46
Appendix II – Basis for network models	47
Appendix III – Error rate vs. network model coverage	56
III.1 Bit- and block-error rate vs. network model coverage	57
Appendix IV – Supplemental round trip delay model	58

SUMMARY

This Recommendation provides a network model to be used in the evaluation and comparison of 2-wire voiceband modems. The model is intended to be representative of the transmission impairment conditions that will be encountered on both intracontinental and intercontinental connections.

INTRODUCTION

It has long been recognized that the test evaluation methodology used in Recommendation V.56 for evaluating modem performance does not provide a definitive answer for the user on how a particular modem will perform in the actual Network.

This Recommendation has been developed with the understanding that the traditional technique for evaluating modem performance in the presence of Gaussian noise and other analogue transmission parameters, did not effectively represent the vast majority of connections in the Network today that are digital transmission in nature.

This Recommendation introduces the concept of using Network Model Coverage (NMC) as a tool for modem performance evaluation, and abandons the traditional method of Signal-to-Noise Ratio (SNR) (more recently referred to as 1 kHz Tone to Total Distortion ratio or T/TD) waterfall performance curves. The concept of rating a modem's performance statistically, based on the Likelihood Of Occurrence (LOO) of a given connection, is new to the industry. This new technique was first developed by CCITT SG XVII (now ITU-T SG 14) for evaluating candidate modulation technologies for the then proposed CCITT V. fast study (now ITU-T Recommendation V.34), and is detailed in the test document referred to as the "V. fast test suite" (CCITT SG XVII D.229 - 1992). This methodology was further refined by ANSI TIA TR-30.3 when creating ANSI TIA TSB-37A "Telephone Network Transmission Model for Evaluating Modem Performance" approved in the United States in September 1994.

The numerical values of the characteristic (impairment levels) of each type of connection, as well as the Likelihood Of Occurrence (LOO) of a certain type of connection, are based upon a model of the Network as is commonly found in the business environments in industrial countries. It has been assumed that the networks in these industrial countries are already primarily a digital Network. Additionally, it is further assumed that the Networks of all countries worldwide are evolving or will evolve towards a digital Network. Therefore, the characteristics and likelihood of occurrences proposed in this Recommendation are assumed to become more and more representative of the worldwide Network with each passing year.

Depending on the country, the actual Network likelihoods of occurrences of particular Network combinations may vary significantly from this model. It is important to emphasize that the model is based on the available information on Network characteristics and not statistically valid surveys of the Network and that the Network is continually changing. Therefore, while the percentages of the Network Model Coverage (NMC) derived from tests using the model may provide a suitable basis for comparing modem performance, it should not be considered to be representative of actual Network coverage.

Differences in NMC percentages for different modems are more meaningful for modem comparisons in today's digital network than differences in the tolerance to noise obtained from traditional waterfall curve testing.

This network model serves to remind the user that a large percentage of connections worldwide are very good lines and that most modems will perform suitably over a significant percentage of connections. The concept in the past was to create all severe stress conditions in which many modems would not even connect and yet the user knew that these same modems performed well most of the time in the real network.

As was the case in the V. fast test suite, ITU-T SG 14 has developed a network model that contains three major sections, namely, local loop A, the 4-wire End-Office-to-End-Office (EO-EO) and local loop B. A LOO is assessed independently for each Test Loop Combination (TLC) and for each EO-EO setting. These are combined in such a way as to provide an overall NMC estimate for a particular modem as a percentage of the total network model for a specific data performance requirement. An important aspect of this network model is that there is a representative sample of local loop topologies and EO-EO facility combinations.

The impedance characteristics, 1 kHz losses and frequency responses of the local loops are in Annex A, while the topology model of the loops is in Figure 2. The loss and frequency response characteristics of the EO-EO section are also in Annex A while the network impairments associated with the EO-EO section are in Table 1.

A LOO is assigned to each of the EO-EO impairment combinations in Table 1 and to each of the TLCs in Table 2.

The scoring assessment of NMC using the complete model can be found in Table 3, while the scoring assessment for truncated versions of the model, representing decreasing percentages of the complete network model, are in Tables 4 through 6.

The rationale for the network model, along with a description of the topology for EO-EO impairment combinations 1 through 16 (main body) and optional EO-EO impairment combinations 17 through 20 (Appendix I), is located in Appendix II.

Test methods and procedures for bit- and block-error rate transmission performance has been included here in Appendix III.

A supplemental test to determine the effects of low Round-Trip Delay (RTD) on modem performance is contained in Appendix IV.

NETWORK TRANSMISSION MODEL FOR EVALUATING MODEM PERFORMANCE OVER 2-WIRE VOICE GRADE CONNECTIONS

(Geneva, 1995)

1 Scope

This Recommendation contains the network model, test equipment configuration and calibration, and parameter values to be used in the evaluation and comparison of 2-wire modems.

Means to reduce testing time are also specified in this Recommendation. This includes truncated network models and conditional testing procedures.

The model is intended to be representative of the transmission impairment conditions encountered on intracontinental network connections within the continental United States, Europe and Asia and is represented in Table 1a. Additionally, Table 1a has been adjusted to account for the presence of the large Private Branch Exchange (PBX) systems commonly found in business environments. Finally, the model has been extended to include Intercontinental connections between the United States and both Europe and Asia and is represented by Table 1b. The PBX systems represented are certainly not representative of an exhaustive study of existing PBX systems as they are both too numerous and ever changing. However, it is felt that a substantial number of the larger PBX systems are represented by the transmission impairments in Tables 1a and 1b. Each impairment combination has an associated "score" that reflects the estimated LOO of a connection containing such impairments.

The score provides a basis for estimating the percentage of connections (excluding those that may include trouble conditions or unusual conditions such as discussed in Appendix I) within a continental connection over which a modem should be expected to provide satisfactory performance. For modems that adjust their transmission rate dependent upon the channel impairments, the model provides a basis for estimating the percentage for each rate at which operation is possible.

It is important to emphasize that the model is based on the available information on network characteristics, not a statistically valid survey of the network and that the network is continually changing. Therefore, while the percentages of NMC derived from tests using the model may provide a suitable basis for comparing modems, it should only be considered as an indication of potential coverage of the real network.

A satisfactory V.56 bis test result should be considered as an indication, not a formal assurance of success on any particular connection of the real network complying with relevant M- and G-Series Recommendations.

This model assumes that network echo cancellers, suppressors, and speech enhancement devices have been disabled. The model does not take into account the effects on performance of digital link slips ("T1 slips"), or automatic balancing of End-Office hybrids. Furthermore, loop current is not specified, nor are conditions for evaluating the compatibility of a modem with the range of loop currents that may be encountered. The derivation of the model impairment combinations is discussed in Appendix II.

This Recommendation also contains network conditions (Appendix I) covering very unusual situations that an individual user may encounter on all or most intercontinental connections. While these conditions may represent a very small percentage of connections, they are important in providing a basis for explaining the limited performance that may be available to individual users.

This Recommendation also contains an intercontinental network model (Appendix II). The model does not include scores for the different impairment combinations such as provided in the intercontinental network model. However, the impairment combinations that represent unusual conditions are distinguished from those that represent conditions that have a significant LOO.

2 References

The following Recommendations and other references contain provisions which, through reference in this text, constitute provisions of this Recommendation. At the time of publication, the editions indicated were valid. All Recommendations and other referenced Standards are subject to revision; all users of this Recommendation are therefore encouraged to investigate the possibility of applying the most recent editions of the Recommendations and other references listed below. A list of currently valid ITU-T Recommendations is regularly published.

- CCITT Recommendation V.56 (1988), *Comparative tests of modems for use over telephone type circuits*.
- CCITT Recommendation O.42 (1992), *Equipment to measure non-linear distortion using the 4-tone intermodulation method*.
- CCITT Recommendation G.726 del CCITT (1990), *40, 32, 24, 16 kbit/s Adaptive Differential Pulse Code Modulation (ADPCM)*.

3 Definitions

For the purposes of this Recommendation, the following definitions shall apply.

3.1 adaptive differential pulse coded modulation (ADPCM): Adaptive digital speech compression techniques employed to reduce the transmitted bit rate in digital carrier systems for voiceband signals.

ADPCM allows the network provider to accommodate more voiceband channels on a digital carrier facility than would be present without it, while still maintaining signal and perceptual quality in the connection. While ADPCM algorithms preserve the quality of speech, they have widely differing impact on data modem performance. This is particularly true for connections between modems supporting modem-to-modem line rates of 9.6 kbit/s and higher.

ADPCM algorithm performance generally is signal dependent; to employ ADPCM properly in a mixed voice/voiceband-data application, careful choice of which adaptive techniques to combine, or alternatively careful choice of a method for switching between separately optimized ADPCM algorithms, is required.

Standard versions of ADPCM are specified in Recommendation G.726. Non-standard versions of ADPCM (CCITT Contributions COM XVIII-101 and 102: 1984-1988) are also encountered in practice.

3.2 attenuation distortion (AD): Differences in signal loss as a function of frequency compared to the signal loss of a 1 kHz reference signal, expressed in dB.

3.3 digital loop carrier system (DLC): A system that provides access to a local office via a digital carrier link for multiple loops to a cluster of subscribers remote from the office.

3.4 envelope delay distortion (EDD): Differences in narrow-band signal envelope propagation time through a connection as a function of frequency compared to the propagation time of a 1.8 kHz reference signal, expressed in microseconds.

A linear network (channel) has the property that a sinusoidal input signal produces a sinusoidal output signal of the same frequency. The output signal will, in general, not have the same amplitude and phase as the input signal; the amplitude and phase differences will be functions of frequency. Envelope delay is the derivative of the difference between the input phase and the output phase, in radians, with respect to radian frequency.

3.5 exchange carrier (EC): Refers to the local telephone company (telecommunications common carrier). The EC is franchised to provide service to the customer for all local calls or connections in a specific geographic area.

3.6 far-end (talker) echo: Talker signal reflected back to the talker from the far-end hybrid. This echo is the direct result of the hybrid not achieving complete rejection.

The magnitude of the far-end talker echo is calculated as follows:

$$\begin{aligned} \text{far-end (talker) echo (B)} &= \text{loop (B) loss} + \text{4-wire (B-A) loss} + \text{THL (A)} \\ &+ \text{4-wire (A-B) loss} + \text{loop (B) loss} \end{aligned}$$

3.7 intermodulation distortion: Spurious signals at the sum and difference frequencies of the original signal spectrum caused by non-linearity in the channel. Clause 4.6.3 of IEEE 743-1989 describes the 4-tone measurement technique that is used in this Recommendation.

3.8 frequency offset (FO): Change in frequency, expressed in Hz, of a 1 kHz tone after passing through a connection.

Frequency offset occurs only when there is a single sideband analogue carrier system in the connection. FO occurs when the single sideband analogue Frequency Division Multiplexed (FDM) carrier facility transmitter has a carrier offset from the receiver analogue carrier facility - caused by differences in crystal frequencies. If there is only one analogue carrier system involved in the connection, then the FO in one direction is both equal in magnitude and opposite in sign to that in the other direction.

It is implied by this definition that digital transmission facilities do not and cannot cause any frequency offset.

3.9 interexchange carrier (IC): Refers to the long-distance carriers or providers. ICs provide the connection between EC segments of the connection.

3.10 intercontinental connection (ICC): Refers to a telephone circuit that spans more than one continent; for example, between the United States and Germany.

3.11 listener echo: Signal reflected by the listener-end hybrid, then by the talker-end hybrid, such that the listener hears the signal two times in succession separated by a delay equal to the round-trip delay.

Listener echo is the direct result of finite THL in both of the network hybrids.

The magnitude of the listener echo signal is calculated as follows:

$$\begin{aligned} \text{listener echo (B)} &= \text{loop (A) loss} + \text{4-wire (A-B) loss} + \text{THL (B)} + \text{4-wire (B-A)} \\ &\text{loss} + \text{THL (A)} + \text{4-wire (A-B) loss} + \text{loop (B) loss} \end{aligned}$$

3.12 loaded loop: Subscriber access line which includes inductors ("loading coils") that reduce the loss at frequencies below approximately 3.3 kHz on long loops.

A specified value of inductor is inserted in series with the loop at specific intervals along the cable. The loading coils, being inserted at specific intervals, effectively turn the entire loop into a high order low pass filter with a cut-off frequency of approximately 3.3 kHz.

3.13 near-end (talker) echo: Refers to the signal echo generated internally within the modem's hybrid. The level of near-end echo that a modem will experience depends directly on how well the modem hybrid deals with the impedance of the subscriber loop and the network termination impedance at the far end of the subscriber loop.

3.14 non-loaded loop: Subscriber access line that consists solely of twisted-pair wire without any inductors.

3.15 phase jitter (PJ): The term Phase Jitter (PJ) refers to phase modulation for this Recommendation. PJ or modulation is inherent in analogue (FDM) carrier transmission facilities. The modulating frequency that is used in this Recommendation is sinusoidal and 50 Hz. It is also believed that even this form of PJ is becoming more rare and, therefore, is only added to one EO-EO impairment combination in the network model.

3.16 phase roll of the far-end (talker) echo: Phase roll refers to a slow phase rotation of the far-end talker echo, and, as was the case for FO, is a phenomena that can only occur when there is a single sideband analogue (FDM) carrier transmission facility in the connection. Phase roll occurs when the FO in one direction is not equal in magnitude and opposite in sign to the offset in the other direction.

3.17 private branch exchange (PBX): The term Private Branch Exchange (PBX) refers to a class of private facilities that interconnect with the network. By definition, since the PBX is privately owned, the user is at risk when considering performance related issues. The specific functionality and distortion that a particular PBX might cause is beyond the scope of this Recommendation.

3.18 pulse coded modulation (PCM): The term Pulse Coded Modulation (PCM) refers to the coding used within networks for digital switching or transmission of voiceband signals. All PCM systems in the world today digitally encode a 4 kHz analogue signal into a 64 kbit/s digital bit stream at an 8 kHz sampling rate. Analogue-to-Digital Converters (ADCs) and Digital-to-Analogue Converters (DACs) are commonly implemented in pairs in a "codec" (i.e. CODer-DECoder). These codecs use either A-law or μ -law companding as specified in Recommendation G.711 to effectively provide a dynamic range that is equivalent to that of a linear 12-bit coding system, with a sample size of only 8 bits.

3.19 robbed bit signalling (RBS): The term Robbed Bit Signalling (RBS) refers to the occasional use of PCM coded bits to convey signalling information for call control for connections in an associated DS1. Robbed bit signalling, more appropriately called in-band signalling, uses the least significant bit from every 6th and 12th frame of the DS1 signal. The end result is that when the least significant bit is used (robbed), the signal is effectively a 7-bit quantizer for that sample. Since the signal was originally quantized to 8 bits, the resulting output effectively appears as the original signal and a low level impulse hit. The use of robbed bit signalling is being reduced by the increased use of common channel signalling in the network.

3.20 round-trip delay (RTD): The term Round-Trip Delay (RTD) refers to the summation of the A-to-B and the B-to-A delays excluding loops.

3.21 tandem connection: The term tandem connection implies that the network connection between two transmission facilities has first been converted back to analogue (voiceband) and then back to digital in the second transmission facility in the case of two digital transmission facilities. A tandem connection results in a significant increase in S/TD.

3.22 tone-to-noise ratio (TNR): The ratio of the 1 kHz tone power to the Gaussian noise power added by the channel simulator, expressed in dB.

The tone power is the power that would be measured at TP3 or TP4 (as appropriate) when to TP1 or TP4 (as appropriate) a tone is applied with a level of -9 dBm less the loop loss. The noise power is the power that would be measured at TP3 or TP4 (as appropriate), through a 3 kHz flat band pass filter [the ratio of the measured power of the holding tone (1004, 1014 or 1020 Hz) to the measured power of the total distortion signal dependent distortion (IMD and quantization noise) and signal independent distortion (Gaussian noise and cross-talk)] through a "3 kHz Flat" bandpass weighting filter [ANSI IEEE 743 – 1989].

3.23 transhybrid loss (THL): Transhybrid Loss (THL) is the ratio of the measured power of a signal at the 4-wire network side input of hybrid (A or B) to the measured power of the same signal at the 4-wire network side output of hybrid (A or B) and is expressed in decibels (dB).

3.24 intracontinental connection (TCC): The term Intracontinental Connection (TCC) also commonly referred to as transcontinental, refers to a connection of a telephone circuit that remains within a continent.

3.25 trunk: The term trunk refers to all 2- or 4-wire transmission facilities between switching offices and their associated impairments.

4 Description of model

4.1 Overview

Figure 1 shows the test equipment configuration to be used. It consists of two loop simulators and a bidirectional network simulator(s). Loop A is connected to the modem that serves as the test transmitter. Loop B is connected to the modem that serves as the test receiver. EO-EO impairment combinations are defined in Tables 1a and 1b. The ordering of the EO-EO impairments shall be as shown in Figure 1. The loops to be simulated are illustrated in Figure 2. The configurations of these loops are defined in Table 2.

The AD and EDD curves are shown in Annex A. An error rate test procedure is provided in Appendix III.

4.2 Echo control requirements

In order to produce controlled echo levels, the internal far-end echo paths of the simulator shall be used. The near-end echo is dependent upon the modem hybrid's ability to match the characteristics of the loops. Near-end echo shall not be introduced in the 4-wire path of the trunk simulator. Good control of far-end echo levels requires that the latent THL of the simulator hybrids be greater than 25 dB across the bandwidth of interest. Therefore, as shown in Figure 1, balancing loops shall be used. These loops (A2 & B2) are connected to the external balance network port(s) of the simulator and terminated with a 600 ohm resistor. The same loop combination shall be used for Loop A2 (B2) as is used for Loop A1 (B1) for any given test.

NOTE – Ideally speaking, optimum balance or THL can only be achieved when the termination impedances for Loops A2 and B2 are also identical to the source/termination impedances of the modems attached to Loops A1 and B1 respectively. This also implies that this termination would need to be a complex impedance and not a simple resistor. However, in most circumstances, if the return loss of the modems into 600 ohms is greater than 18 dB, then a 600 ohm resistor can be used in place of the complex termination to produce reliable results.

4.3 Round-trip delay criteria

The RTDs specified for the impairment combinations in Table 1a (row 10a) are representative of typical and long intracontinental connections. A supplemental RTD model that may be used to evaluate the effects of low delays on modem performance is provided in Appendix IV. The RTDs specified for the intercontinental network model in Table 1b (row 10a) provide a basis for evaluating the effects of maximum delays on modem performance. For all of these cases, the RTD shall be divided equally between the two directions of transmission.

4.4 Modem impedance requirements

The end-to-end network losses presented in this Recommendation assume that the modems have nominal source and terminating impedances of 600 ohms. If a particular modem under test has an impedance that is significantly different from 600 ohms, then all of the values for both loss and AD will be different and modem performance may be impacted. It is also important to understand that a significant difference in impedance will impact the network (end-to-end) simulator hybrid balance and will result in different signal to far-end (talker) echo and signal to listener echo ratios that may also impact modem performance.

4.5 Model limitations

The network model is only applicable for transmission tests from Modem A to Modem B. Test results shall be recorded for the data received by Modem B. It is important to note that the performance of Modem B may depend upon the characteristics of Modem A.

While the percentages of NMC derived from the tests contained herein may provide a suitable basis for comparing modems, it should only be considered indicative of potential coverage of the real network.

4.6 Digital impairment requirements

The tandem connection of PCMs shall comply with the definition in clause 3.

Where indicated in Tables 1a, 1b and I.1, RBS shall always be applied to the first PCM in a tandem and with a pattern of alternating zeros and ones. Where indicated, ADPCM shall be applied to the first PCM when 1 PCM is specified, and to the second PCM when 2 or 3 PCMs are specified.

4.7 Network Model Coverage (NMC)

Tables 1a and 1b, with its EO-EO impairment combinations, represents the complete model of the Intracontinental Network and Intercontinental Network. Table 2, with its 7 TLCs, represents the complete local loop model.

The set of tests in Table 3 represents 100% of either the intracontinental (Table 1a) or Intercontinental (Table 1b) of the network model (which excludes very unusual conditions) and contains 168 tests, one test for each combination of TLC and EO-EO impairment combination. If modem performance is evaluated over the complete network model, the user will have an overall NMC rating for a particular modem that will provide a reasonable estimate of the percentage of the real network over which the modem can be expected to meet the specific data performance requirement. The same modem will provide different NMC ratings for different data signalling rates and different bit- or block-error ratios and/or throughput requirements.

It is understood that 168 tests may be too time-consuming for a particular modem evaluation process. Therefore, this Recommendation has specified three alternative truncated sets of tests, representing decreasing coverage of the network model. All truncations are performed by eliminating a specified percentage of the cross product values found in Table 3. Although this cross product truncation does result in fewer tests, the resultant NMC is less than 100%. By specifying several sets of tests covering a range of NMC, this Recommendation gives the tester the flexibility to trade testing time for a more accurate estimate of NMC.

- The set of tests in Table 4 represents approximately 99% of the network model and contains 100 tests. It is derived by eliminating all LOO cross products that are less than 0.035%.
- The set of tests in Table 5 represents approximately 95% of the network model and contains 55 tests. It is derived by eliminating all LOO cross products that are less than 0.17%.
- The set of tests in Table 6 represents just over 90% of the network model and contains only 36 tests. It is derived by eliminating all LOO cross products that are less than 0.38%.

To perform the error rate test procedures described in Appendix III, one of the sets of tests outlined in Tables 3 through 6 shall be chosen. Test results shall be reported per the table number used.

Normalizing the test results to 100% for Tables 4 to 6 is not allowed in this Recommendation. The resulting answer one would get by normalizing to 100%, would not at all be representative of the actual NMC tested to for the aforementioned truncated tables. As an example, a particular modem may be capable of achieving an NMC score of 99.5% at a data signalling rate of 19.2 kbit/s when using the complete set of 168 tests in Table 3, but if the tester evaluates this modem using the set of 36 tests in Table 6, the maximum achievable score that can be reported is 90.55%, and this particular modem would not even achieve this score if it failed any of the 36 tests.

Use of any of the truncated network models is acceptable for a given application as long as the maximum achievable NMC for that set of tests is reported along with the test results. This way, there will be no misinterpretation of the test results.

5 Impairment level set-up

- The transmitted signal power is measured at the line terminals of the modem across a 600 ohm resistor. The transmitted power shall conform to the requirements specified for the country in which the modem is to be evaluated.
- The specified IMD values shall be produced by the channel simulator with a 1 kHz tone input level at TP1 (and TP4) of –12 dBm.

- The specified TNR values (impairment combinations 7 and 8) shall be produced by the channel simulator with a 1 kHz tone level at TP1 (or TP4) equal to -9 dBm less the 1 kHz loss of Loop A (or Loop B).
- The specified THL (adjusted with the hybrid by-pass attenuator) shall be produced by the channel simulator with the modem replaced by a 600-ohm resistor.

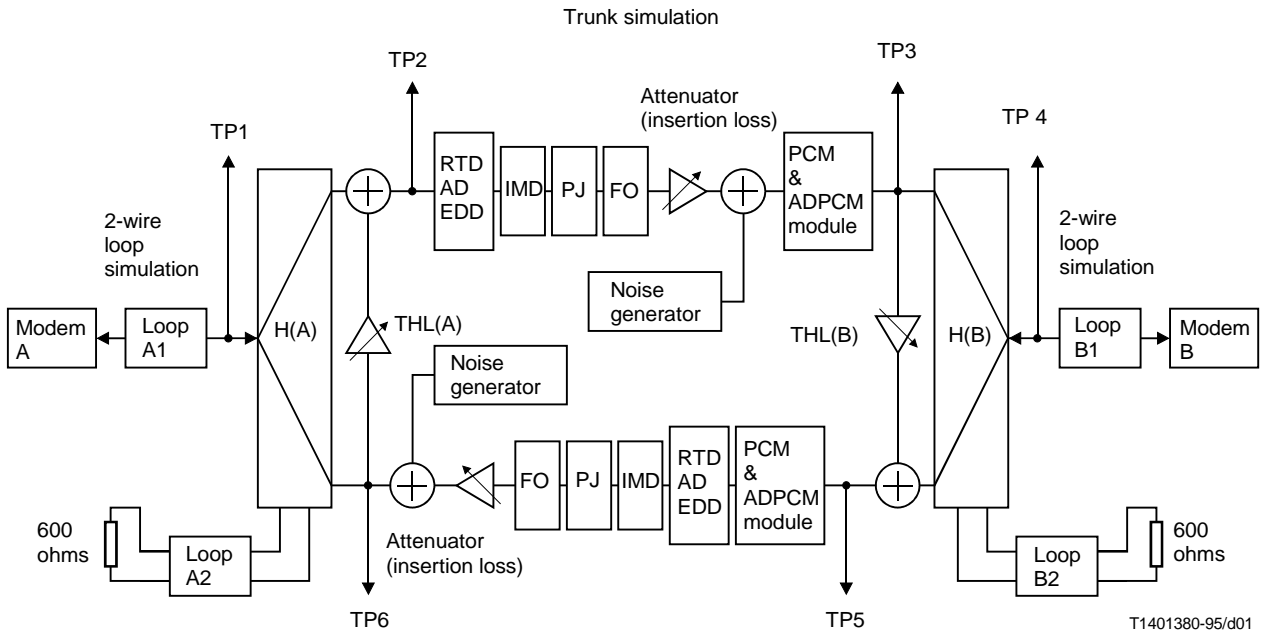

FIGURE 1/V.56 bis
Test equipment configuration

TABLE 1a/V.56 bis

Intracontinental network (End office-to-end office) combinations

Types of impairments Connection type – Score Combination – Score	Units Per cent Per cent	1a 2.8%	1b 55.3% 2.8%	1c 49.7%	2a 1.4%	2b 19.2% 1.4%	2c 16.4%
1 AD		None	None	None	None	None	None
2 EDD		None	None	None	None	None	None
3 1 kHz loss	dB	6.0	6.0	6.0	8.0	6.0	6.0
4a Added noise	dBm	-68	-68	-68	-68	-68	-68
4b TNR	dB	N/A	N/A	N/A	N/A	N/A	N/A
5 Phase jitter							
5a P-P deviation	Deg.	None	None	None	None	None	None
5b Frequency	Hz	None	None	None	None	None	None
6 IMD-(4 Tone)							
6a 2nd Order (H2/R2)	dB	40	43	50	43	50	55
6b 3rd Order (H3/R3)	dB	41	44	51	44	51	56
7 Frequency offset							
7a FO (A-to-B)	Hz	None	None	None	None	None	None
7b FO (B-to-A)	Hz	None	None	None	None	None	None
8 PCM (64 kbit/s)		μ -law	μ -law	A-law	μ -law	μ -law	A-law
8a Tandem links	No.	1	1	1	1	1	1
8b Robbed bit signalling		Yes	Yes	No	Yes	Yes	No
8c RBS location	Link No.	1	1		1	1	
9 ADPCM							
9a Type		None	None	None	None	None	None
9b Signalling rate	kbit/s	None	None	None	None	None	None
9c ADPCM location	Link No.	None	None	None	None	None	None
10 Echo							
10a RTD	ms	80	80	80	80	80	80
10b THL (A)	dB	12	16	20	16	20	22
10c THL (B)	dB	12	16	20	16	20	22

TABLE 1a/V.56 bis (continued)

Intracontinental network (End office-to-end office) combinations

Types of impairments Connection type – Score Combination – Score	Units Per cent Per cent	3a 0.5%	3b 10.3% 0.5%	3c 9.3%	4a 0.25%	4b 5.2% 0.25%	4c 4.7%
1 AD		None	None	None	None	None	None
2 EDD		None	None	None	None	None	None
3 1 kHz loss	dB	8.0	6.0	6.0	8.0	6.0	6.0
4a Added noise	dBm	-68	-68	-68	-68	-68	-68
4b TNR	dB	N/A	N/A	N/A	N/A	N/A	N/A
5 Phase jitter							
5a P-P deviation	Deg.	None	None	None	None	None	None
5b Frequency	Hz	None	None	None	None	None	None
6 IMD-(4 Tone)							
6a 2nd Order (H2/R2)	dB	40	43	50	40	43	50
6b 3rd Order (H3/R3)	dB	41	44	51	41	44	51
7 Frequency offset							
7a FO (A-to-B)	Hz	None	None	None	None	None	None
7b FO (B-to-A)	Hz	None	None	None	None	None	None
8 PCM (64 kbit/s)		μ -law	μ -law	A-law	μ -law	μ -law	A-law
8a Tandem links	No.	2	2	2	3	3	3
8b Robbed bit signalling		Yes	Yes	No	Yes	Yes	No
8c RBS location	Link No.	1	1		1	1	
9 ADPCM							
9a Type		None	None	None	None	None	None
9b Signalling rate	kbit/s	None	None	None	None	None	None
9c ADPCM location	Link No.	None	None	None	None	None	None
10 Echo							
10a RTD	ms	80	80	80	80	80	80
10b THL (A)	dB	12	16	20	12	16	20
10c THL (B)	dB	12	16	20	12	16	20

TABLE 1a/V.56 bis (continued)

Intracontinental network (End office-to-end office) combinations

Types of impairments Connection type – Score Combination – Score	Units Per cent Per cent	5a 0.35%	5b 5.0% 0.35%	5c 4.3%	6a 0.05%	6b 1.0% 0.05%	6c 0.9%
1 AD		AD-7	AD-6	AD-5	AD-7	AD-6	AD-5
2 EDD		None	None	None	None	None	None
3 1 kHz loss	dB	8.0	6.0	6.0	8.0	6.0	6.0
4a Added noise	dBm	-68	-68	-68	-68	-68	-68
4b TNR	dB	N/A	N/A	N/A	N/A	N/A	N/A
5 Phase jitter							
5a P-P deviation	Deg.	None	None	None	None	None	None
5b Frequency	Hz	None	None	None	None	None	None
6 IMD-(4 Tone)							
6a 2nd Order (H2/R2)	dB	60	60	60	43	50	55
6b 3rd Order (H3/R3)	dB	58	58	58	44	51	56
7 Frequency offset							
7a FO (A-to-B)	Hz	None	None	None	None	None	None
7b FO (B-to-A)	Hz	None	None	None	None	None	None
8 PCM (64 kbit/s)					A-law	A-law	A-law
8a Tandem links	No.	None	None	None	1	1	1
8b Robbed bit signalling		No	No	No	No	No	No
8c RBS location	Link No.						
9 ADPCM							
9a Type		None	None	None	None	None	None
9b Signalling rate	kbit/s	None	None	None	None	None	None
9c ADPCM location	Link No.	None	None	None	None	None	None
10 Echo							
10a RTD	ms	35	35	35	80	80	80
10b THL (A)	dB	12	16	20	12	16	20
10c THL (B)	dB	12	16	20	12	16	20

TABLE 1a/V.56 bis (end)

Intracontinental network (End office-to-end office) combinations

Types of impairments Connection type – Score Combination – Score	Units Per cent Per cent	7a 0.15%	7b 2.0% 0.15%	7c 1.7%	8a 0.15%	8b 2.0% 0.15%	8c 1.7%
1 AD		AD-9	AD-8	AD-1	AD-9	AD-8	AD-1
2 EDD		EDD-3	EDD-2	EDD-1	EDD-3	EDD-2	EDD-1
3 1 kHz loss	dB	9.0	8.0	6.0	8.0	6.0	6.0
4a Added noise	dBm	N/A	N/A	N/A	N/A	N/A	N/A
4b TNR	dB	30	33	36	33	36	39
5 Phase jitter							
5a P-P deviation	Deg.	3	3	3	3	3	3
5b Frequency	Hz	50	50	50	50	50	50
6 IMD-(4 Tone)							
6a 2nd Order (H2/R2)	dB	43	46	51	43	46	51
6b 3rd Order (H3/R3)	dB	44	47	53	44	47	53
7 Frequency offset							
7a FO (A-to-B)	Hz	+0.8	+0.2	+0.2	None	None	None
7b FO (B-to-A)	Hz	-0.4	-0.1	-0.2	None	None	None
8 PCM (64 kbit/s)					A-law	A-law	A-law
8a Tandem links	No.	None	None	None	1	1	1
8b Robbed bit signalling		No	No	No	No	No	No
8c RBS location	Link No.	None	None	None	None	None	None
9 ADPCM							
9a Type		None	None	None	None	None	None
9b Signalling rate	kbit/s	None	None	None	None	None	None
9c ADPCM location	Link No.	None	None	None	None	None	None
10 Echo							
10a RTD	ms	35	35	35	80	80	80
10b THL (A)	dB	16	20	22	16	20	22
10c THL (B)	dB	16	20	22	16	20	22

TABLE 1b/V.56 bis

Intercontinental network (End office-to-end office) combinations

Types of impairments Connection type – Score Combination – Score		Units Per cent Per cent	9a 2.8%	9b 55.3% 2.8%	9c 49.7%	10a 1.4%	10b 19.2% 1.4%	10c 16.4%
1	AD		None	None	None	None	None	None
2	EDD		None	None	None	None	None	None
3	1 kHz loss	dB	6.0	6.0	6.0	8.0	6.0	6.0
4a	Added noise	dBm	-68	-68	-68	-68	-68	-68
4b	TNR	dB	N/A	N/A	N/A	N/A	N/A	N/A
5	Phase jitter		None	None	None	None	None	None
5a	P-P deviation	Deg.	0	0	0	0	0	0
5b	Frequency	Hz	0	0	0	0	0	0
6	IMD-(4 Tone)							
6a	2nd Order (H2)	dB	46	50	55	46	50	55
6b	3rd Order (H3)	dB	47	51	56	47	51	56
7	Frequency offset		None	None	None	None	None	None
7a	FO (A-to-B)	Hz	0	0	0	0	0	0
7b	FO (B-to-A)	Hz	0	0	0	0	0	0
8	PCM (64 kbit/s)		A-law	A-law	A-law	μ -law	μ -law	A-law
8a	Tandem links	No.	1	1	1	1	1	1
8b	Robbed bit signalling		No	No	No	Yes	Yes	No
8c	RBS location	Link No.				1	1	
9	ADPCM							
9a	Type		XVIII-102	XVIII-102	XVIII-102	XVIII-101	XVIII-101	XVIII-101
9b	Signalling rate	kbit/s	32	32	32	32	32	32
9c	ADPCM location		1	1	1	1	1	1
10	Echo							
10a	RTD	ms	700	200	100	700	200	100
10b	THL (A)	dB	12	16	20	16	20	22
10c	THL (B)	dB	12	16	20	16	20	22

TABLE 1b/V.56 bis (continued)

Intercontinental network (End office-to-end office) combinations

Types of impairments Connection type – Score Combination – Score	Units Per cent Per cent	11a 0.5%	11b 10.3% 0.5%	11c 9.3%	12a 0.25%	12b 5.2% 0.25%	12c 4.7%
1 AD		None	None	None	None	None	None
2 EDD		None	None	None	None	None	None
3 1 kHz loss	dB	8.0	6.0	6.0	8.0	6.0	6.0
4a Added noise	dBm	-68	-68	-68	-68	-68	-68
4b TNR	dB	N/A	N/A	N/A	N/A	N/A	N/A
5 Phase jitter		None	None	None	None	None	None
5a P-P deviation	Deg.	0	0	0	0	0	0
5b Frequency	Hz	0	0	0	0	0	0
6 IMD-(4 Tone)							
6a 2nd Order (H2)	dB	46	50	55	46	50	55
6b 3rd Order (H3)	dB	47	51	56	47	51	56
7 Frequency offset		None	None	None	None	None	None
7a FO (A-to-B)	Hz	0	0	0	0	0	0
7b FO (B-to-A)	Hz	0	0	0	0	0	0
8 PCM (64 kbit/s)		μ -law	μ -law	A-law	μ -law	μ -law	A-law
8a Tandem links	No.	2	1	1	3	3	3
8b Robbed bit signalling		Yes	Yes	No	Yes	Yes	No
8c RBS location	Link No.	1	1		1	1	
9 ADPCM							
9a Type		Rec. G.726	Rec. G.726	Rec. G.726	Rec. G.726	Rec. G.726	Rec. G.726
9b Signalling rate	kbit/s	40	40	40	40	40	40
9c ADPCM location		1	1	1	2	2	2
10 Echo							
10a RTD	ms	1180	150	100	200	150	100
10b THL (A)	dB	12	16	20	12	16	20
10c THL (B)	dB	12	16	20	12	16	20

TABLE 1b/V.56 bis (continued)

Intercontinental network (End office-to-end office) combinations

Types of impairments Connection type – Score Combination – Score		Units Per cent Per cent	13a 0.35%	13b 5.0% 0.35%	13c 4.3%	14a 0.05%	14b 1.0% 0.05%	14c 0.9%
1	AD		AD-7	AD-6	AD-5	AD-7	AD-6	AD-5
2	EDD		None	None	None	None	None	None
3	1 kHz loss	dB	8.0	6.0	6.0	8.0	6.0	6.0
4a	Added noise	dBm	-68	-68	-68	-68	-68	-68
4b	TNR	dB	N/A	N/A	N/A	N/A	N/A	N/A
5	Phase jitter		None	None	None	None	None	None
5a	P-P deviation	Deg.	0	0	0	0	0	0
5b	Frequency	Hz	0	0	0	0	0	0
6	IMD-(4 Tone)							
6a	2nd Order (H2)	dB	46	50	55	46	50	55
6b	3rd Order (H3)	dB	47	51	56	47	51	56
7	Frequency offset		None	None	None	None	None	None
7a	FO (A-to-B)	Hz	0	0	0	0	0	0
7b	FO (B-to-A)	Hz	0	0	0	0	0	0
8	PCM (64 kbit/s)		A-law	A-law	A-law	μ-law	μ-law	A-law
8a	Tandem links	No.	1	1	1	1	1	1
8b	Robbed bit signalling		No	No	No	Yes	Yes	No
8c	RBS location	Link No.				1	1	
9	ADPCM							
9a	Type		XVIII-102	XVIII-102	XVIII-102	Rec. G.726	Rec. G.726	Rec. G.726
9b	Signalling rate	kbit/s	32	32	32	40	40	40
9c	ADPCM location		1	1	1	1	1	1
10	Echo							
10a	RTD	ms	700	200	100	700	200	100
10b	THL (A)	dB	12	16	20	12	16	20
10c	THL (B)	dB	12	16	20	12	16	20

TABLE 1b/V.56 bis (continued)

Intercontinental network (End office-to-end office) combinations

Types of impairments Connection type – Score Combination – Score		Units Per cent Per cent	15a 0.15%	15b 2.0% 0.15%	15c 1.7%	16a 0.15%	16b 2.0% 0.15%	16c 1.7%
1	AD		AD-9	AD-8	AD-1	AD-9	AD-8	AD-1
2	EDD		EDD-3	EDD-2	EDD- 1	EDD-3	EDD-2	EDD-1
3	1 kHz loss	dB	9.0	8.0	6.0	8.0	6.0	6.0
4a	Added noise	dBm	N/A	N/A	N/A	N/A	N/A	N/A
4b	TNR	dB	30	33	36	33	36	39
5	Phase jitter							
5a	P-P deviation	Deg.	3	3	3	3	3	3
5b	Frequency	Hz	50	50	50	50	50	50
6	IMD-(4 Tone)							
6a	2nd Order (H2)	dB	46	50	55	46	50	55
6b	3rd Order (H3)	dB	47	51	56	47	51	56
7	Frequency offset							
7a	FO (A-to-B)	Hz	+0.8	+0.2	+0.2	None	None	None
7b	FO (B-to-A)	Hz	-0.4	-0.1	-0.2	None	None	None
8	PCM (64 kbit/s)		A-law	A-law	A-law	μ-law	μ-law	μ-law
8a	Tandem links	No.	1	1	1	1	1	1
8b	Robbed bit signalling		No	No	No	No	No	No
8c	RBS location	Link No.						
9	ADPCM							
9a	Type		XVIII-102	XVIII-102	XVIII-102	Rec. G.726	Rec G.726	Rec. G.726
9b	Signalling rate	kbit/s	32	32	32	40	40	40
9c	ADPCM location		1	1	1	1	1	1
10	Echo							
10a	RTD	ms	700	200	100	700	200	100
10b	THL (A)	dB	16	20	22	16	20	22
10c	THL (B)	dB	16	20	22	16	20	22

Nominal
DC resistance
(ohms)

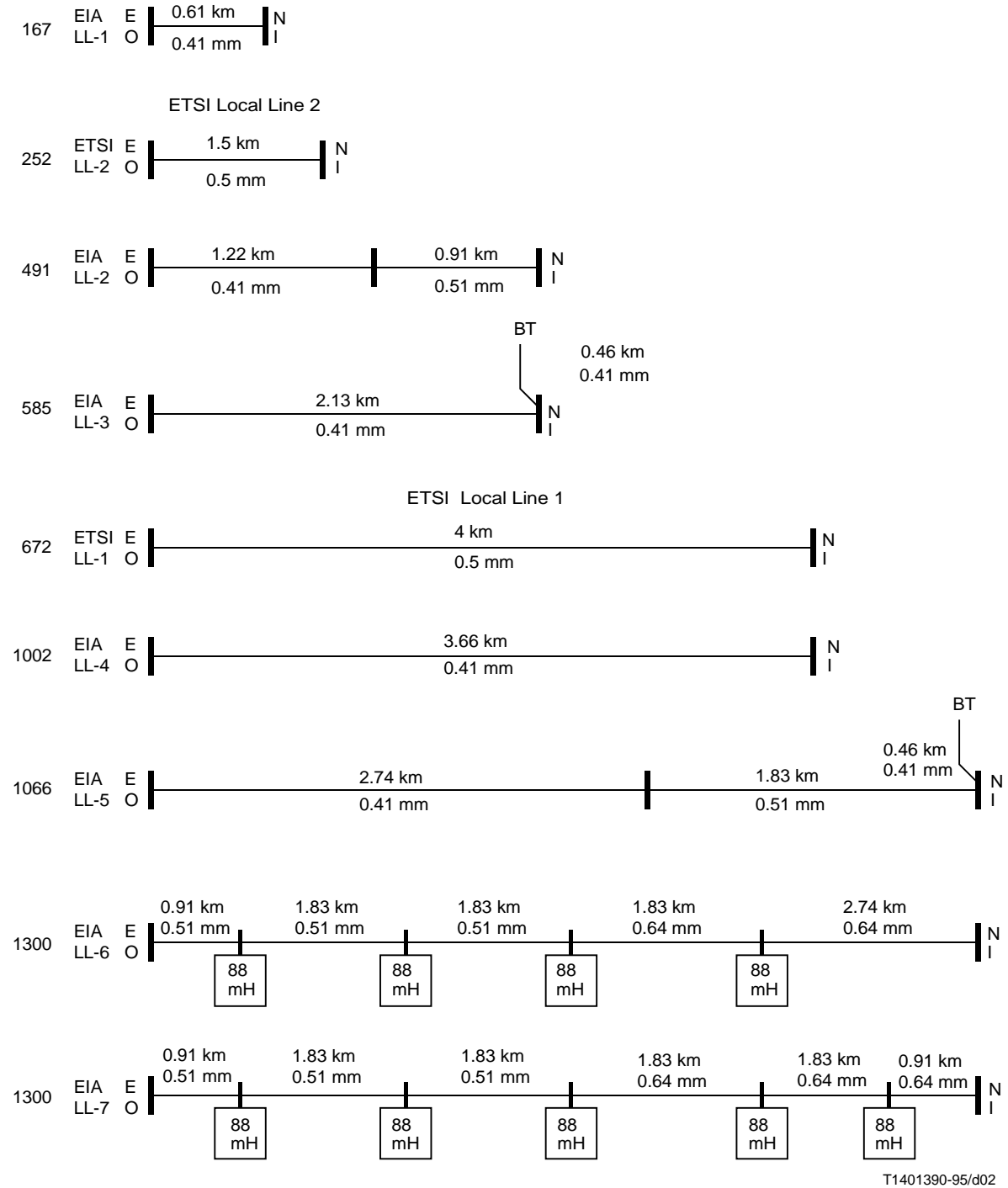

FIGURE 2/V.56 bis
Local loop configurations

TABLE 2/V.56 bis

Test Loop Combination (TLC) impairments

Test Loop Combination (TLC)	Type	Score Por cent	Test loops (Annex A)	
			A Loop type	B Loop type
1	Non-loaded	46.0%	EIA LL-2	EIA LL-2
2	Non-loaded	23.0%	ETSI LL-2	ETSI LL-2
3	Non-loaded/ Non-loaded	10.0%	EIA LL-4	EIA LL-3
4	Non-loaded/ Non-loaded	10.0%	EIA LL-1	ETSI LL-1
5	Loaded/ Non-loaded	8.0%	EIA LL-6	EIA LL-2
6	Non-loaded	1.6%	EIA LL-5	EIA LL-5
7	Loaded	1.4%	EIA LL-7	EIA LL-7
EIA LL-1	EIA test loop 1	(see Table A.1)		
ETSI LL-2	ETSI local line 2	(see Table A.2)		
EIA LL-2	EIA test loop 2	(see Table A.3)		
EIA LL-3	EIA test loop 3	(see Table A.4)		
ETSI LL-1	ETSI local line 1	(see Table A.5)		
EIA LL-4	EIA test loop 4	(see Table A.6)		
EIA LL-5	EIA test loop 5	(see Table A.7)		
EIA LL-6	EIA test loop 6	(see Table A.8)		
EIA LL-7	EIA test loop 7	(see Table A.9)		

TABLE 3/V.56 bis

Network model coverage = 100%
0% cross product truncation
Number of tests = 168

TLC								
EO-EO (Note)	1	2	3	4	5	6	7	Total
1c/9c	22.8620%	11.4310%	4.9700%	4.9700%	3.9760%	0.7952%	0.6958%	49.70%
2c/10c	7.5440%	3.7720%	1.6400%	1.6400%	1.3120%	0.2624%	0.2296%	16.40%
3c/11c	4.2780%	2.1390%	0.9300%	0.9300%	0.7440%	0.1488%	0.1302%	9.30%
4c/12c	2.1620%	1.0810%	0.4700%	0.4700%	0.3760%	0.0752%	0.0658%	4.70%
5c/13c	1.9780%	0.9890%	0.4300%	0.4300%	0.3440%	0.0688%	0.0602%	4.30%
1b/9b	1.2880%	0.6440%	0.2800%	0.2800%	0.2240%	0.0448%	0.0392%	2.80%
1a/9a	1.2880%	0.6440%	0.2800%	0.2800%	0.2240%	0.0448%	0.0392%	2.80%
7c/15c	0.7820%	0.3910%	0.1700%	0.1700%	0.1360%	0.0272%	0.0238%	1.70%
8c/16c	0.7820%	0.3910%	0.1700%	0.1700%	0.1360%	0.0272%	0.0238%	1.70%
2b/10b	0.6440%	0.3220%	0.1400%	0.1400%	0.1120%	0.0224%	0.0196%	1.40%
2a/10a	0.6440%	0.3220%	0.1400%	0.1400%	0.1120%	0.0224%	0.0196%	1.40%
6c/14c	0.4140%	0.2070%	0.0900%	0.0900%	0.0720%	0.0144%	0.0126%	0.90%
3b/11b	0.2300%	0.1150%	0.0500%	0.0500%	0.0400%	0.0080%	0.0070%	0.50%
3a/11a	0.2300%	0.1150%	0.0500%	0.0500%	0.0400%	0.0080%	0.0070%	0.50%
5b/13b	0.1610%	0.0805%	0.0350%	0.0350%	0.0280%	0.0056%	0.0049%	0.35%
5a/13a	0.1610%	0.0805%	0.0350%	0.0350%	0.0280%	0.0056%	0.0049%	0.35%
4b/12b	0.1150%	0.0575%	0.0250%	0.0250%	0.0200%	0.0040%	0.0035%	0.25%
4a/12a	0.1150%	0.0575%	0.0250%	0.0250%	0.0200%	0.0040%	0.0035%	0.25%
7b/15b	0.0690%	0.0345%	0.0150%	0.0150%	0.0120%	0.0024%	0.0021%	0.15%
7a/15a	0.0690%	0.0345%	0.0150%	0.0150%	0.0120%	0.0024%	0.0021%	0.15%
8b/16b	0.0690%	0.0345%	0.0150%	0.0150%	0.0120%	0.0024%	0.0021%	0.15%
8a/16a	0.0690%	0.0345%	0.0150%	0.0150%	0.0120%	0.0024%	0.0021%	0.15%
6b/14b	0.0230%	0.0115%	0.0050%	0.0050%	0.0040%	0.0008%	0.0007%	0.05%
6a/14a	0.0230%	0.0115%	0.0050%	0.0050%	0.0040%	0.0008%	0.0007%	0.05%

NOTE – Numbers indicate EO to EO combinations for either Table 1a Intracontinental network or Table 1b Intercontinental network.

TABLE 4/V.56 bis

Network model coverage = 99.101%

0.035% cross product truncation

Number of tests = 100

TLC								
EO-EO (Note)	1	2	3	4	5	6	7	Total
1c/9c	22.8620%	11.4310%	4.9700%	4.9700%	3.9760%	0.7952%	0.6958%	49.70%
2c/10c	7.5440%	3.7720%	1.6400%	1.6400%	1.3120%	0.2624%	0.2296%	16.40%
3c/11c	4.2780%	2.1390%	0.9300%	0.9300%	0.7440%	0.1488%	0.1302%	9.30%
4c/12c	2.1620%	1.0810%	0.4700%	0.4700%	0.3760%	0.0752%	0.0658%	4.70%
5c/13c	1.9780%	0.9890%	0.4300%	0.4300%	0.3440%	0.0688%	0.0602%	4.30%
1b/9b	1.2880%	0.6440%	0.2800%	0.2800%	0.2240%	0.0448%	0.0392%	2.80%
1a/9a	1.2880%	0.6440%	0.2800%	0.2800%	0.2240%	0.0448%	0.0392%	2.80%
7c/15c	0.7820%	0.3910%	0.1700%	0.1700%	0.1360%	N/A	N/A	1.649%
8c/16c	0.7820%	0.3910%	0.1700%	0.1700%	0.1360%	N/A	N/A	1.649%
2b/10b	0.6440%	0.3220%	0.1400%	0.1400%	0.1120%	N/A	N/A	1.358%
2a/10a	0.6440%	0.3220%	0.1400%	0.1400%	0.1120%	N/A	N/A	1.358%
6c/14c	0.4140%	0.2070%	0.0900%	0.0900%	0.0720%	N/A	N/A	0.873%
3b/11b	0.2300%	0.1150%	0.0500%	0.0500%	0.0400%	N/A	N/A	0.485%
3a/11a	0.2300%	0.1150%	0.0500%	0.0500%	0.0400%	N/A	N/A	0.485%
5b/13b	0.1610%	0.0805%	0.0350%	0.0350%	N/A	N/A	N/A	0.3115%
5a/13a	0.1610%	0.0805%	0.0350%	0.0350%	N/A	N/A	N/A	0.3115%
4b/12b	0.1150%	0.0575%	N/A	N/A	N/A	N/A	N/A	0.1725%
4a/12a	0.1150%	0.0575%	N/A	N/A	N/A	N/A	N/A	0.1725%
7b/15b	0.0690%	N/A	N/A	N/A	N/A	N/A	N/A	0.0690%
7a/15a	0.0690%	N/A	N/A	N/A	N/A	N/A	N/A	0.0690%
8b/16b	0.0690%	N/A	N/A	N/A	N/A	N/A	N/A	0.0690%
8a/16a	0.0690%	N/A	N/A	N/A	N/A	N/A	N/A	0.0690%
6b/14b	N/A	N/A	N/A	N/A	N/A	N/A	N/A	N/A
6a/14a	N/A	N/A	N/A	N/A	N/A	N/A	N/A	N/A

NOTE – Numbers indicate EO to EO combinations for either Table 1a Intracontinental network or Table 1b Intercontinental network.

TABLE 5/V.56 bis

Network model coverage = 95.32%

0.17% cross product truncation

Number of tests = 55

TLC								
EO-EO (Note)	1	2	3	4	5	6	7	Total
1c/9c	22.8620%	11.4310%	4.9700%	4.9700%	3.9760%	0.7952%	0.6958%	49.70%
2c/10c	7.5440%	3.7720%	1.6400%	1.6400%	1.3120%	0.2624%	0.2296%	16.40%
3c/11c	4.2780%	2.1390%	0.9300%	0.9300%	0.7440%	N/A	N/A	9.021%
4c/12c	2.1620%	1.0810%	0.4700%	0.4700%	0.3760%	N/A	N/A	4.559%
5c/13c	1.9780%	0.9890%	0.4300%	0.4300%	0.3440%	N/A	N/A	4.171%
1b/9b	1.2880%	0.6440%	0.2800%	0.2800%	0.2240%	N/A	N/A	2.716%
1a/9a	1.2880%	0.6440%	0.2800%	0.2800%	0.2240%	N/A	N/A	2.716%
7c/15c	0.7820%	0.3910%	0.1700%	0.1700%	N/A	N/A	N/A	1.513%
8c/16c	0.7820%	0.3910%	0.1700%	0.1700%	N/A	N/A	N/A	1.513%
2b/10b	0.6440%	0.3220%	N/A	N/A	N/A	N/A	N/A	0.9660%
2a/10a	0.6440%	0.3220%	N/A	N/A	N/A	N/A	N/A	0.9660%
6c/14c	0.4140%	0.2070%	N/A	N/A	N/A	N/A	N/A	0.6210%
3b/11b	0.2300%	N/A	N/A	N/A	N/A	N/A	N/A	0.230%
3a/11a	0.2300%	N/A	N/A	N/A	N/A	N/A	N/A	0.230%
5b/13b	N/A	N/A	N/A	N/A	N/A	N/A	N/A	N/A
5a/13a	N/A	N/A	N/A	N/A	N/A	N/A	N/A	N/A
4b/12b	N/A	N/A	N/A	N/A	N/A	N/A	N/A	N/A
4a/12a	N/A	N/A	N/A	N/A	N/A	N/A	N/A	N/A
7b/15b	N/A	N/A	N/A	N/A	N/A	N/A	N/A	N/A
7a/15a	N/A	N/A	N/A	N/A	N/A	N/A	N/A	N/A
8b/16b	N/A	N/A	N/A	N/A	N/A	N/A	N/A	N/A
8a/16a	N/A	N/A	N/A	N/A	N/A	N/A	N/A	N/A
6b/14b	N/A	N/A	N/A	N/A	N/A	N/A	N/A	N/A
6a/14a	N/A	N/A	N/A	N/A	N/A	N/A	N/A	N/A

NOTE – Numbers indicate EO to EO combinations for either Table 1a Intracontinental network or Table 1b Intercontinental network.

TABLE 6/V.56 bis

Network model coverage = 90.55%

0.38% cross product truncation

Number of tests = 36

TLC								
EO-EO (Note)	1	2	3	4	5	6	7	Total
1c/9c	22.8620%	11.4310%	4.9700%	4.9700%	3.9760%	0.7952%	0.6958%	49.70%
2c/10c	7.5440%	3.7720%	1.6400%	1.6400%	1.3120%	N/A	N/A	15.908%
3c/11c	4.2780%	2.1390%	0.9300%	0.9300%	0.7440%	N/A	N/A	9.0210%
4c/12c	2.1620%	1.0810%	0.4700%	0.4700%	N/A	N/A	N/A	4.1830%
5c/13c	1.9780%	0.9890%	0.4300%	0.4300%	N/A	N/A	N/A	3.8270%
1b/9b	1.2880%	0.6440%	N/A	N/A	N/A	N/A	N/A	1.9320%
1a/9a	1.2880%	0.6440%	N/A	N/A	N/A	N/A	N/A	1.9320%
7c/15c	0.7820%	0.3910%	N/A	N/A	N/A	N/A	N/A	1.1730%
8c/16c	0.7820%	0.3910%	N/A	N/A	N/A	N/A	N/A	1.1730%
2b/10b	0.6440%	N/A	N/A	N/A	N/A	N/A	N/A	0.6440%
2a/10a	0.6440%	N/A	N/A	N/A	N/A	N/A	N/A	0.6440%
6c/14c	0.4140%	N/A	N/A	N/A	N/A	N/A	N/A	0.4140%
3b/11b	N/A	N/A	N/A	N/A	N/A	N/A	N/A	N/A
3a/11a	N/A	N/A	N/A	N/A	N/A	N/A	N/A	N/A
5b/13b	N/A	N/A	N/A	N/A	N/A	N/A	N/A	N/A
5a/13a	N/A	N/A	N/A	N/A	N/A	N/A	N/A	N/A
4b/12b	N/A	N/A	N/A	N/A	N/A	N/A	N/A	N/A
4a/12a	N/A	N/A	N/A	N/A	N/A	N/A	N/A	N/A
7b/15b	N/A	N/A	N/A	N/A	N/A	N/A	N/A	N/A
7a/15a	N/A	N/A	N/A	N/A	N/A	N/A	N/A	N/A
8b/16b	N/A	N/A	N/A	N/A	N/A	N/A	N/A	N/A
8a/16a	N/A	N/A	N/A	N/A	N/A	N/A	N/A	N/A
6b/14b	N/A	N/A	N/A	N/A	N/A	N/A	N/A	N/A
6a/14a	N/A	N/A	N/A	N/A	N/A	N/A	N/A	N/A

NOTE 1 – Numbers indicate EO to EO combinations for either Table 1a Intracontinental network or Table 1b Intercontinental network.

Annex A

Attenuation and envelope delay distortion characteristics

This annex contains the specifications for the AD and EDD characteristics. The data is in both numerical format (Tables A.1-A.13) and graphic format (Figures A.1-A.13). AD curves are referenced to the 1 kHz loss value, while EDD curves are referenced to the 1.8 kHz envelope delay value.

It is important to note that while the data presented below is representative of the various transmission facilities and loop population, it is by no means a conclusive representation. The characteristics for the transmission facilities were taken from Bellcore TR-NPL-000037 Issue 1, 1984, while the majority of the loop information was derived from Bellcore ST-TSY-000041 – 1984. An example of this process are the AD-(5-7) curves, which were derived from Bellcore TR-NPL-000037 Issue 1, 1984, based on data for two-wire analogue trunks.

The exception to this procedure was the AD-(1, 8 and 9) set of curves. In this case, the data from Bellcore TR-NPL-000037 Issue 1, 1984, was used as a guideline and compared against AD curves that already existed and were readily available on at least three manufacturer's simulators. These curves, which are in fact representative of analogue carrier transmission facilities in Japan (AD-1) and Europe (AD-8 and AD-9), also turn out to be fairly representative of analogue carrier transmission facilities throughout the world.

In the case of PCM filter responses, the simulator manufacturers utilize actual PCM codecs that are used in the network in vast numbers, therefore, it was felt that these curves were indeed, by design, representative of digital transmission facilities.

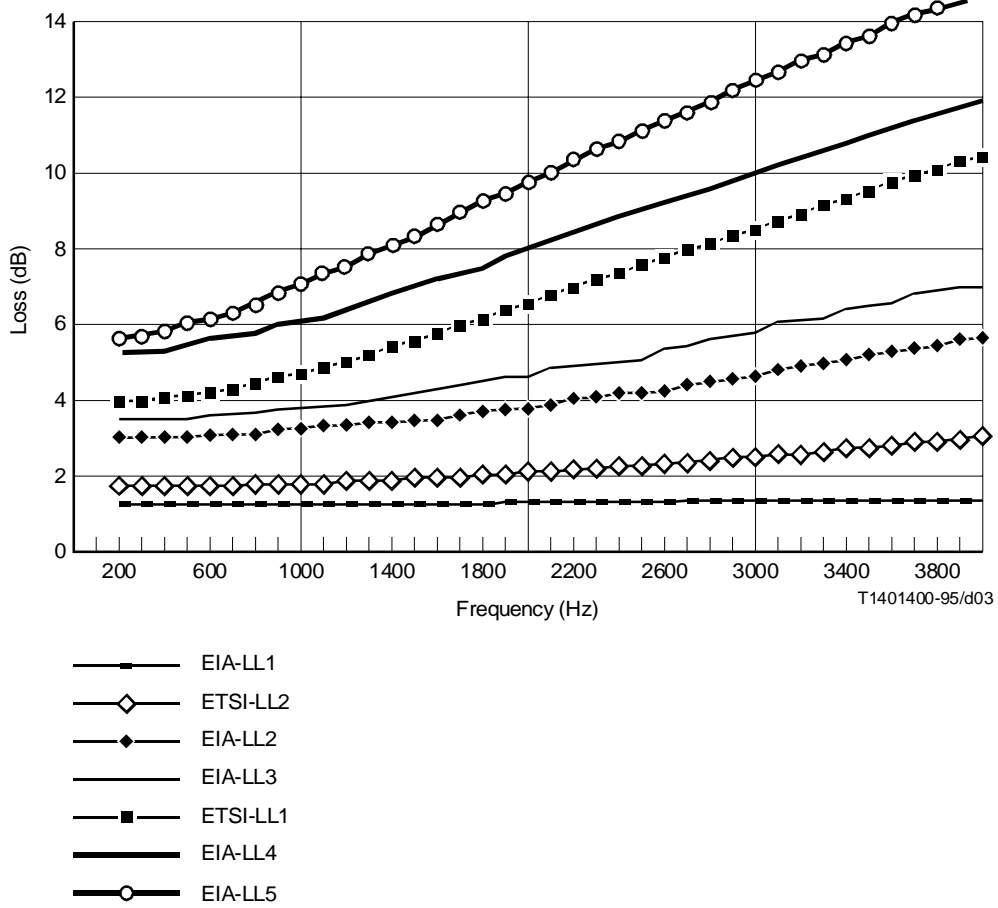

FIGURE A.1/V.56 bis
Attenuation distortion, EIA LL (1-5) and ETSI LL (1 and 2)

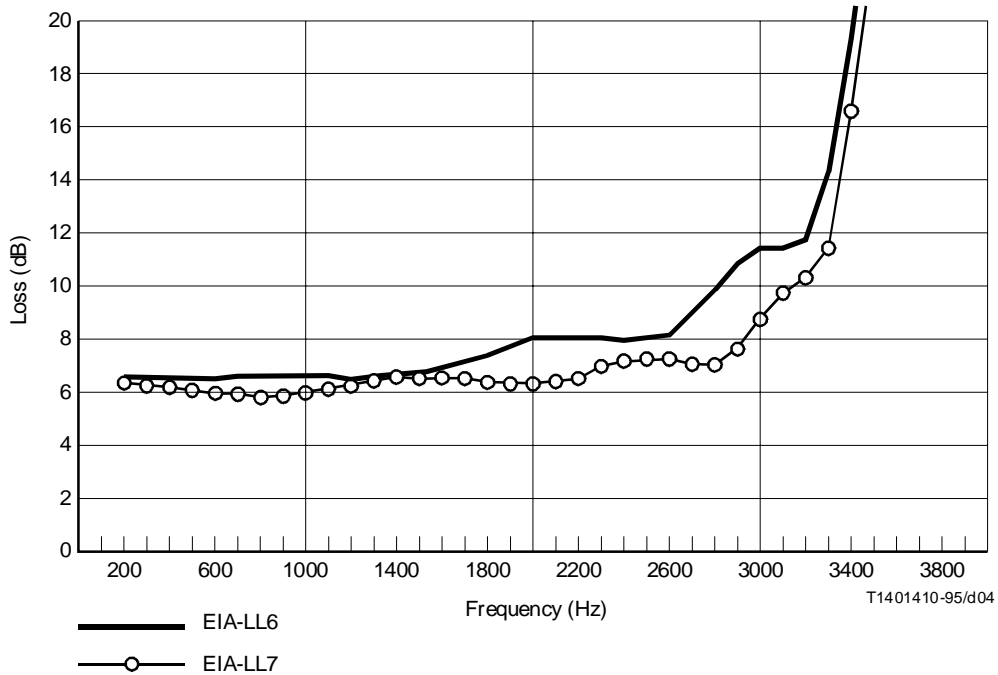

FIGURE A.2/V.56 bis
Attenuation distortion, EIA LL (6 and 7)

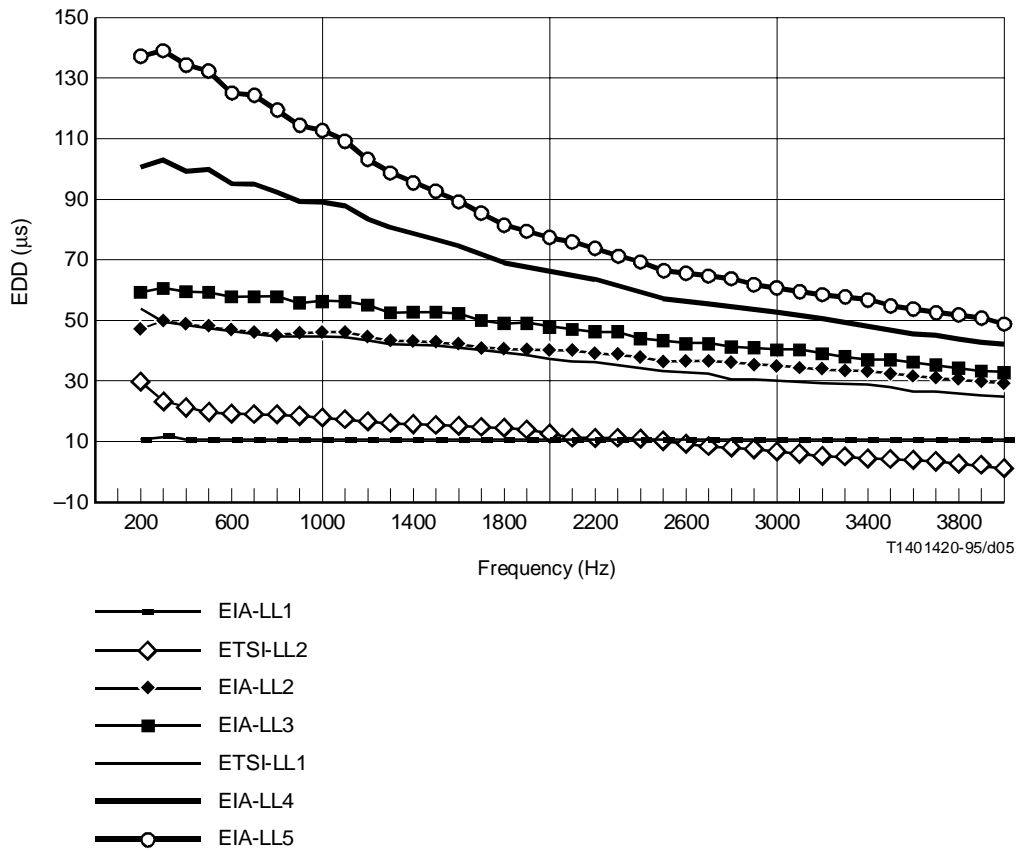

FIGURE A.3/V.56 bis
Envelope delay distortion, EIA LL (1-5) and ETSI LL (1 and 2)

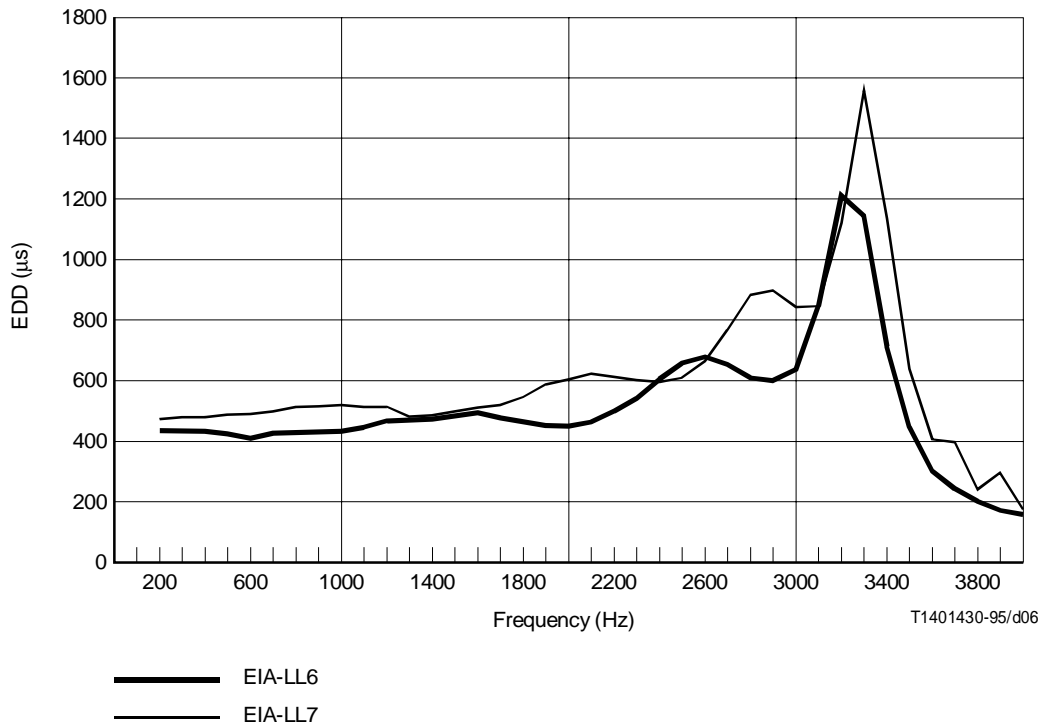

FIGURE A.4/V.56 bis
Envelope delay distortion, EIA LL (6 and 7)

TABLE A.1/V.56 bis

EIA LL-1, non-loaded loop

End Office to Network Interface					Network Interface to End Office			
Freq. (Hz)	AD (dB)	EDD (μ s)	Z (ohms)	Phase (deg.)	Z (ohms)	Phase (deg.)	AD (dB)	EDD (μ s)
200	0.0	0.4	767	-1.4	767	-1.4	0.0	0.4
300	0.0	0.7	766	-2.0	766	-2.0	0.0	0.7
400	0.0	0.5	763	-2.8	763	-2.8	0.0	0.5
500	0.0	0.6	765	-3.4	765	-3.4	0.0	0.6
600	0.0	0.2	764	-4.1	764	-4.1	0.0	0.2
700	0.0	0.4	764	-4.7	764	-4.7	0.0	0.4
800	0.0	0.4	762	-5.4	762	-5.4	0.0	0.4
900	0.0	0.2	762	-6.0	762	-6.0	0.0	0.2
[1000]	[1.2]	0.5	[761]	[-6.7]	[761]	[-6.7]	[1.2]	0.5
1100	0.0	0.6	759	-7.4	759	-7.4	0.0	0.6
1200	0.0	0.4	757	-8.1	757	-8.1	0.0	0.4
1300	0.0	0.1	757	-8.6	757	-8.6	0.0	0.1
1400	0.0	0.3	755	-9.3	755	-9.3	0.0	0.3
1500	0.0	0.4	753	-10.0	753	-10.0	0.0	0.4
1600	0.0	0.3	751	-10.7	751	-10.7	0.0	0.3
1700	0.0	0.1	748	-11.3	748	-11.3	0.0	0.1
[1800]	0.0	[11.0]	748	-11.9	748	-11.9	0.0	[11.0]
1900	0.1	0.1	745	-12.5	745	-12.5	0.1	0.1
2000	0.1	0.3	743	-13.9	743	-13.9	0.1	0.3
2100	0.1	0.3	740	-13.9	740	-13.9	0.1	0.3
2200	0.1	0.3	737	-14.5	737	-14.5	0.1	0.3
2300	0.1	0.3	734	-15.2	734	-15.2	0.1	0.3
2400	0.1	0.2	731	-15.8	731	-15.8	0.1	0.2
2500	0.1	0.0	728	-16.4	728	-16.4	0.1	0.0
2600	0.1	0.0	729	-16.8	729	-16.8	0.1	0.0
2700	0.2	0.1	726	-17.4	726	-17.4	0.2	0.1
2800	0.2	0.2	722	-18.0	722	-18.0	0.2	0.2
2900	0.2	0.3	719	-18.6	719	-18.6	0.2	0.3
3000	0.2	0.4	715	-19.3	715	-19.3	0.2	0.4
3100	0.2	0.4	712	-19.9	712	-19.9	0.2	0.4
3200	0.2	0.5	708	-20.5	708	-20.5	0.2	0.5
3300	0.2	0.5	704	-21.1	704	-21.1	0.2	0.5
3400	0.2	0.5	700	-21.7	700	-21.7	0.2	0.5
3500	0.2	0.5	696	-22.3	696	-22.3	0.2	0.5
3600	0.2	0.4	692	-22.9	692	-22.9	0.2	0.4
3700	0.2	0.3	688	-23.5	688	-23.5	0.2	0.3
3800	0.2	0.2	684	-24.1	684	-24.1	0.2	0.2
3900	0.2	0.1	680	-24.7	680	-24.7	0.2	0.1
4000	0.2	-0.1	676	-25.2	676	-25.2	0.2	-0.1

[] Denotes the Reference Loss and/or Delay Value

TABLE A.2/V.56 bis

ETSI LL-2, non-loaded loop

End Office to Network Interface					Network Interface to End Office			
Freq. (Hz)	AD (dB)	EDD (μ s)	Z (ohms)	Phase (deg.)	Z (ohms)	Phase (deg.)	AD (dB)	EDD (μ s)
200	-0.10	15.0	850.3	-3.4	850.3	-3.4	-0.10	15.0
300	-0.09	8.0	848.1	-5.1	848.1	-5.1	-0.09	8.0
400	-0.09	7.0	845.1	-6.7	845.1	-6.7	-0.09	7.0
500	-0.08	5.0	841.3	-8.4	841.3	-8.4	-0.08	5.0
600	-0.07	4.6	836.7	-10.0	836.7	-10.0	-0.07	4.6
700	-0.06	4.3	831.3	-11.6	831.3	-11.6	-0.06	4.3
800	-0.04	3.8	825.3	-13.2	825.3	-13.2	-0.04	3.8
900	-0.02	3.4	818.6	-14.8	818.6	-14.8	-0.02	3.4
[1000]	[1.8]	3.0	[811.4]	[-16.3]	[811.4]	[-16.3]	[1.8]	3.0
1100	0.02	2.6	803.6	-17.8	803.6	-17.8	0.02	2.6
1200	0.04	2.3	795.3	-19.3	795.3	-19.3	0.04	2.3
1300	0.06	1.3	786.6	-20.7	786.6	-20.7	0.06	1.3
1400	0.09	0.9	777.5	-22.1	777.5	-22.1	0.09	0.9
1500	0.12	0.6	768.1	-23.5	768.1	-23.5	0.12	0.6
1600	0.15	0.3	758.4	-24.8	758.4	-24.8	0.15	0.3
1700	0.18	0.0	748.4	-26.1	748.4	-26.1	0.18	0.0
[1800]	0.21	[15]	738.4	-27.3	738.4	-27.3	0.21	[15]
1900	0.24	-1.0	728.1	-28.5	728.1	-28.5	0.24	-1.0
2000	0.28	-2.3	717.8	-29.7	717.8	-29.7	0.28	-2.3
2100	0.32	-2.6	707.4	-30.8	707.4	-30.8	0.32	-2.6
2200	0.36	-3.0	697.0	-31.9	697.0	-31.9	0.36	-3.0
2300	0.40	-3.3	686.6	-33.0	686.6	-33.0	0.40	-3.3
2400	0.44	-3.6	676.2	-34.0	676.2	-34.0	0.44	-3.6
2500	0.48	-4.5	665.9	-35.0	665.9	-35.0	0.48	-4.5
2600	0.53	-5.4	655.6	-35.9	655.6	-35.9	0.53	-5.4
2700	0.57	-6.3	645.5	-36.8	645.5	-36.8	0.57	-6.3
2800	0.62	-6.6	635.5	-37.7	635.5	-37.7	0.62	-6.6
2900	0.67	-6.9	625.6	-38.6	625.6	-38.6	0.67	-6.9
3000	0.72	-7.5	615.8	-39.4	615.8	-39.4	0.72	-7.5
3100	0.77	-8.3	606.2	-40.2	606.2	-40.2	0.77	-8.3
3200	0.82	-8.6	596.7	-40.9	596.7	-40.9	0.82	-8.6
3300	0.87	-9.3	587.4	-41.6	587.4	-41.6	0.87	-9.3
3400	0.92	-9.6	578.3	-42.3	578.3	-42.3	0.92	-9.6
3500	0.98	-10.3	569.3	-43.0	569.3	-43.0	0.98	-10.3
3600	1.03	-10.6	560.6	-43.7	560.6	-43.7	1.03	-10.6
3700	1.09	-11.3	552.0	-44.3	552.0	-44.3	1.09	-11.3
3800	1.14	-11.6	543.5	-44.9	543.5	-44.9	1.14	-11.6
3900	1.20	-12.3	535.3	-45.4	535.3	-45.4	1.20	-12.3
4000	1.26	-13.3	527.2	-46.0	527.2	-46.0	1.26	-13.3

[] Denotes the Reference Loss and/or Delay Value

TABLE A.3/V.56 bis

EIA LL-2, non-loaded loop

End Office to Network Interface					Network Interface to End Office			
Freq. (Hz)	AD (dB)	EDD (µs)	Z (ohms)	Phase (deg.)	Z (ohms)	Phase (deg.)	AD (dB)	EDD (µs)
200	-0.2	6.6	1086	-4.9	1085	-5.6	-0.2	6.6
300	-0.2	7.7	1079	-7.3	1077	-8.3	-0.2	7.7
400	-0.2	6.7	1062	-9.9	1058	-11.2	-0.2	6.7
500	-0.2	7.1	1059	-12.0	1053	-13.6	-0.2	7.1
600	-0.1	5.2	1041	-14.4	1034	-16.3	-0.1	5.2
700	-0.1	5.8	1030	-16.5	1020	-18.6	-0.1	5.8
800	-0.1	5.4	1010	-18.7	998	-21.0	-0.1	5.4
900	0.0	4.5	997	-20.5	982	-23.1	0.0	4.5
[1000]	[3.2]	5.1	[976]	[-22.5]	[959]	[-25.3]	[3.2]	5.1
1100	0.1	5.0	954	-24.5	934	-27.4	0.1	5.0
1200	0.1	4.0	931	-26.2	909	-29.4	0.1	4.0
1300	0.2	2.7	918	-27.6	894	-30.9	0.2	2.7
1400	0.2	2.8	897	-29.2	871	-32.6	0.2	2.8
1500	0.3	2.6	874	-30.7	847	-34.3	0.3	2.6
1600	0.3	2.0	852	-32.1	823	-35.8	0.3	2.0
1700	0.4	0.9	831	-33.4	800	-37.2	0.4	0.9
[1800]	0.5	[40.8]	816	-34.4	783	-38.4	0.5	[40.8]
1900	0.6	0.0	796	-35.6	762	-39.6	0.6	0.0
2000	0.6	-0.2	776	-36.6	741	-40.7	0.6	-0.2
2100	0.7	-0.6	756	-37.6	720	-41.8	0.7	-0.6
2200	0.8	-1.1	737	-38.6	700	-42.9	0.8	-1.1
2300	0.9	-1.8	719	-39.4	681	-43.8	0.9	-1.8
2400	1.0	-2.6	701	-40.2	663	-44.7	1.0	-2.6
2500	1.0	-3.7	684	-41.0	646	-45.5	1.0	-3.7
2600	1.1	-4.1	678	-41.3	639	-45.9	1.1	-4.1
2700	1.2	-4.3	663	-42.0	623	-46.6	1.2	-4.3
2800	1.3	-4.5	647	-42.6	607	-47.3	1.3	-4.5
2900	1.4	-4.8	632	-43.1	591	-47.9	1.4	-4.8
3000	1.5	-5.2	617	-43.6	576	-48.4	1.5	-5.2
3100	1.6	-5.6	603	-44.1	562	-49.0	1.6	-5.6
3200	1.7	-6.0	589	-44.5	548	-49.5	1.7	-6.0
3300	1.8	-6.5	576	-44.9	535	-49.9	1.8	-6.5
3400	1.9	-7.1	563	-45.3	522	-50.3	1.9	-7.1
3500	2.0	-7.7	551	-45.6	509	-50.7	2.0	-7.7
3600	2.1	-8.4	539	-45.9	498	-51.0	2.1	-8.4
3700	2.2	-9.1	528	-46.2	486	-51.3	2.2	-9.1
3800	2.3	-9.9	518	-46.4	476	-51.6	2.3	-9.9
3900	2.4	-10.6	507	-46.6	466	-51.9	2.4	-10.6
4000	2.5	-11.5	498	-46.8	456	-52.1	2.5	-11.5

[] Denotes the Reference Loss and/or Delay Value

TABLE A.4/V.56 bis

EIA LL-3, non-loaded loop

End Office to Network Interface					Network Interface to End Office			
Freq. (Hz)	AD (dB)	EDD (μ s)	Z (ohms)	Phase (deg.)	Z (ohms)	Phase (deg.)	AD (dB)	EDD (μ s)
200	-0.3	10.5	1176	-5.9	1173	-7.4	-0.3	10.5
300	-0.3	11.5	1165	-8.8	1159	-11.0	-0.3	11.5
400	-0.3	10.6	1140	-11.8	1130	-14.7	-0.3	10.6
500	-0.3	11.0	1133	-14.3	1117	-17.8	-0.3	11.0
600	-0.2	8.5	1108	-17.1	1086	-21.2	-0.2	8.5
700	-0.2	8.5	1090	-19.4	1062	-24.0	-0.2	8.5
800	-0.1	8.4	1062	-21.9	1029	-27.0	-0.1	8.4
900	0.0	7.1	1042	-23.9	1003	-29.4	0.0	7.1
[1000]	[3.8]	7.7	[1013]	[-23.0]	[969]	[-31.9]	[3.8]	7.7
1100	0.1	7.4	982	-28.1	934	-34.3	0.1	7.4
1200	0.1	6.0	953	-29.9	900	-36.5	0.1	6.0
1300	0.2	4.2	935	-31.3	878	-38.1	0.2	4.2
1400	0.3	4.2	907	-32.8	847	-40.0	0.3	4.2
1500	0.4	3.7	880	-34.3	817	-41.7	0.4	3.7
1600	0.5	2.7	853	-35.6	787	-43.2	0.5	2.7
1700	0.6	1.2	827	-36.8	760	-44.6	0.6	1.2
[1800]	0.7	[48.7]	809	-37.8	739	-45.8	0.7	[48.7]
1900	0.8	-0.2	785	-38.8	715	-47.0	0.8	-0.2
2000	0.9	-0.7	763	-39.7	691	-48.0	0.9	-0.7
2100	1.0	-1.3	741	-40.5	668	-49.1	1.0	-1.3
2200	1.1	-2.1	719	-41.3	647	-50.0	1.1	-2.1
2300	1.2	-2.1	699	-42.0	625	-50.8	1.2	-2.1
2400	1.2	-4.3	680	-42.6	606	-51.6	1.2	-4.3
2500	1.3	-5.6	663	-43.2	588	-52.3	1.3	-5.6
2600	1.6	-6.2	656	-43.4	581	-52.7	1.6	-6.2
2700	1.7	-6.6	640	-43.9	564	-53.3	1.7	-6.6
2800	1.8	-7.0	624	-44.3	548	-53.9	1.8	-7.0
2900	1.9	-7.5	609	-44.7	533	-54.4	1.9	-7.5
3000	2.0	-8.0	594	-45.0	518	-54.8	2.0	-8.0
3100	2.2	-8.6	580	-45.3	504	-55.3	2.2	-8.6
3200	2.3	-9.2	566	-45.6	490	-55.7	2.3	-9.2
3300	2.4	-9.9	553	-45.8	477	-56.0	2.4	-9.9
3400	2.6	-10.7	540	-46.0	465	-56.3	2.6	-10.7
3500	2.7	-11.4	529	-46.2	454	-56.6	2.7	-11.4
3600	2.8	-12.3	517	-46.3	443	-56.9	2.8	-12.3
3700	3.0	-13.1	507	-46.4	432	-57.1	3.0	-13.1
3800	3.1	-14.0	497	-46.5	422	-57.3	3.1	-14.0
3900	3.2	-14.9	487	-46.6	413	-57.5	3.2	-14.9
4000	3.3	-15.9	478	-46.6	404	-57.7	3.3	-15.9

[] Denotes the Reference Loss and/or Delay Value

TABLE A.5/V.56 bis

ETSI LL-1, non-loaded loop

End Office to Network Interface					Network Interface to End Office			
Freq. (Hz)	AD (dB)	EDD (μ s)	Z (ohms)	Phase (deg.)	Z (ohms)	Phase (deg.)	AD (dB)	EDD (μ s)
200	-0.78	14.0	1248.5	-9.7	1248.5	-9.7	-0.78	14.0
300	-0.74	10.0	1220.9	-14.3	1220.9	-14.3	-0.74	10.0
400	-0.68	8.0	1185.2	-18.6	1185.2	-18.6	-0.68	8.0
500	-0.60	7.0	1143.9	-22.6	1143.9	-22.6	-0.60	7.0
600	-0.51	6.0	1099.0	-26.2	1099.0	-26.2	-0.51	6.0
700	-0.40	5.6	1052.5	-29.5	1052.5	-29.5	-0.40	5.6
800	-0.28	5.3	1005.9	-32.4	1005.9	-32.4	-0.28	5.3
900	-0.14	5.0	960.3	-35.0	960.3	-35.0	-0.14	5.0
[1000]	[4.7]	4.6	[916.4]	[-37.3]	[916.4]	[-37.3]	[4.7]	4.6
1100	0.16	4.3	874.6	-39.3	874.6	-39.3	0.16	4.3
1200	0.33	3.6	835.3	-41.1	835.3	-41.1	0.33	3.6
1300	0.49	2.6	798.5	-42.6	798.5	-42.6	0.49	2.6
1400	0.67	2.0	764.2	-43.9	764.2	-43.9	0.67	2.0
1500	0.85	1.0	732.3	-45.1	732.3	-45.1	0.85	1.0
1600	1.04	0.6	702.7	-46.1	702.7	-46.1	1.04	0.6
1700	1.23	0.3	675.3	-47.0	675.3	-47.0	1.23	0.3
[1800]	1.43	[40.0]	649.8	-47.7	649.8	-47.7	1.43	[40.0]
1900	1.63	-1.0	626.2	-48.4	626.2	-48.4	1.63	-1.0
2000	1.83	-2.0	604.3	-48.9	604.3	-48.9	1.83	-2.0
2100	2.03	-3.3	584.0	-49.4	584.0	-49.4	2.03	-3.3
2200	2.23	-3.6	565.1	-49.8	565.1	-49.8	2.23	-3.6
2300	2.44	-4.3	547.5	-50.1	547.5	-50.1	2.44	-4.3
2400	2.64	-5.0	531.1	-50.4	531.1	-50.4	2.64	-5.0
2500	2.84	-6.1	515.9	-50.6	515.9	-50.6	2.84	-6.1
2600	3.05	-6.6	501.6	-50.8	501.6	-50.8	3.05	-6.6
2700	3.25	-7.3	488.2	-51.0	488.2	-51.0	3.25	-7.3
2800	3.45	-7.6	475.7	-51.1	475.7	-51.1	3.45	-7.6
2900	3.65	-8.3	464.0	-51.1	464.0	-51.1	3.65	-8.3
3000	3.85	-8.6	453.0	-51.2	453.0	-51.2	3.85	-8.6
3100	4.04	-9.3	442.6	-51.2	442.6	-51.2	4.04	-9.3
3200	4.24	-10.3	432.9	-51.2	432.9	-51.2	4.24	-10.3
3300	4.43	-10.6	423.7	-51.2	423.7	-51.2	4.43	-10.6
3400	4.62	-11.3	415.1	-51.2	415.1	-51.2	4.62	-11.3
3500	4.81	-11.6	406.9	-51.1	406.9	-51.1	4.81	-11.6
3600	5.00	-12.3	399.1	-51.1	399.1	-51.1	5.00	-12.3
3700	5.19	-13.0	391.8	-51.0	391.8	-51.0	5.19	-13.0
3800	5.37	-13.4	384.9	-51.0	384.9	-51.0	5.37	-13.4
3900	5.56	-13.8	378.3	-50.9	378.3	-50.9	5.56	-13.8
4000	5.74	-14.4	372.0	-50.8	372.0	-50.8	5.74	-14.4

[] Denotes the Reference Loss and/or Delay Value

TABLE A.6/V.56 bis

EIA LL-4, non-loaded loop

End Office to Network Interface					Network Interface to End Office			
Freq. (Hz)	AD (dB)	EDD (μ s)	Z (ohms)	Phase (deg.)	Z (ohms)	Phase (deg.)	AD (dB)	EDD (μ s)
200	-0.8	31.0	1564	-10.7	1564	-10.7	-0.8	31.0
300	-0.8	32.6	1520	-15.6	1520	-15.6	-0.8	32.6
400	-0.8	29.8	1447	-20.5	1447	-20.5	-0.8	29.8
500	-0.6	29.7	1402	-24.3	1402	-24.3	-0.6	29.7
600	-0.5	24.9	1328	-28.1	1328	-28.1	-0.5	24.9
700	-0.4	24.8	1270	-31.2	1270	-31.2	-0.4	24.8
800	-0.3	22.7	1200	-34.0	1200	-34.0	-0.3	22.7
900	-0.1	19.8	1148	-36.2	1148	-36.2	-0.1	19.8
[1000]	[6.1]	19.3	[1086]	[-38.3]	[1086]	[-38.3]	[6.1]	19.3
1100	0.1	17.5	1027	-40.1	1027	-40.1	0.1	17.5
1200	0.3	14.3	974	-41.6	974	-41.6	0.3	14.3
1300	0.5	10.9	941	-42.6	941	-42.6	0.5	10.9
1400	0.7	9.6	897	-43.7	897	-43.7	0.7	9.6
1500	0.9	7.7	856	-44.6	856	-44.6	0.9	7.7
1600	1.1	5.3	818	-45.3	818	-45.3	1.1	5.3
1700	1.3	2.4	784	-45.9	784	-45.9	1.3	2.4
[1800]	1.4	[69.1]	761	-46.3	761	-46.3	1.4	[69.1]
1900	1.7	-1.3	732	-46.6	732	-46.6	1.7	-1.3
2000	1.9	-2.7	706	-46.9	706	-46.9	1.9	-2.7
2100	2.1	-4.3	682	-47.1	682	-47.1	2.1	-4.3
2200	2.3	-6.0	659	-47.3	659	-47.3	2.3	-6.0
2300	2.5	-7.9	638	-47.4	638	-47.4	2.5	-7.9
2400	2.7	-9.9	619	-47.4	619	-47.4	2.7	-9.9
2500	2.9	-12.0	602	-47.5	602	-47.5	2.9	-12.0
2600	3.1	-13.0	596	-47.4	596	-47.4	3.1	-13.0
2700	3.3	-13.9	580	-47.4	580	-47.4	3.3	-13.9
2800	3.5	-14.8	566	-47.3	566	-47.3	3.5	-14.8
2900	3.7	-15.7	552	-47.2	552	-47.2	3.7	-15.7
3000	3.9	-16.7	539	-47.1	539	-47.1	3.9	-16.7
3100	4.1	-17.7	526	-47.0	526	-47.0	4.1	-17.7
3200	4.3	-18.7	515	-46.8	515	-46.8	4.3	-18.7
3300	4.5	-19.8	504	-46.7	504	-46.7	4.5	-19.8
3400	4.7	-20.8	493	-46.5	493	-46.5	4.7	-20.8
3500	4.9	-21.8	484	-46.4	484	-46.4	4.9	-21.8
3600	5.1	-22.9	475	-46.2	475	-46.2	5.1	-22.9
3700	5.3	-23.9	466	46.0	466	46.0	5.3	-23.9
3800	5.5	-25.0	458	-45.9	458	-45.9	5.5	-25.0
3900	5.6	-26.1	451	-45.7	451	-45.7	5.6	-26.1
4000	5.8	-27.2	444	-45.5	444	-45.5	5.8	-27.2

[] Denotes the Reference Loss and/or Delay Value

TABLE A.7/V.56 bis

EIA LL-5, non-loaded loop

End Office to Network Interface					Network Interface to End Office			
Freq. (Hz)	AD (dB)	EDD (μs)	Z (ohms)	Phase (deg.)	Z (ohms)	Phase (deg.)	AD (dB)	EDD (μs)
200	-1.4	55.8	1607	-12.7	1574	-17.4	-1.4	55.8
300	-1.3	57.2	1541	-18.3	1478	-24.8	-1.3	57.2
400	-1.2	52.2	1443	-23.6	1350	-31.5	-1.2	52.2
500	-1.0	51.0	1379	-27.5	1261	-36.4	-1.0	51.0
600	-0.9	43.2	1287	-31.2	1150	-40.7	-0.9	43.2
700	-0.7	41.8	1216	-34.0	1066	-44.0	-0.7	41.8
800	-0.5	37.4	1137	-36.5	979	-46.9	-0.5	37.4
900	-0.2	32.4	1080	-38.3	915	-48.9	-0.2	32.4
[1000]	[7.0]	30.5	[1015]	[-39.8]	[848]	[-50.7]	[7.0]	30.5
1100	0.3	26.8	956	-41.1	788	-52.2	0.3	26.8
1200	0.5	21.5	904	-42.1	736	-53.3	0.5	21.5
1300	0.8	16.6	873	-42.7	703	-54.1	0.8	16.6
1400	1.0	14.1	832	-43.2	663	-54.8	1.0	14.1
1500	1.3	10.9	795	-43.7	627	-55.3	1.3	10.9
1600	1.6	7.3	762	-44.0	595	-55.7	1.6	7.3
1700	1.9	3.2	733	-44.2	567	-56.0	1.9	3.2
[1800]	2.2	[81.5]	713	-44.3	547	-56.2	2.2	[81.5]
1900	2.4	-1.9	689	-44.4	524	-56.4	2.4	-1.9
2000	2.7	-3.9	667	-44.4	503	-56.5	2.7	-3.9
2100	3.0	-6.1	646	-44.4	485	-56.5	3.0	-6.1
2200	3.3	-8.3	628	-44.4	466	-56.5	3.3	-8.3
2300	3.6	-10.7	610	-44.3	450	-56.5	3.6	-10.7
2400	3.8	-13.1	595	-44.2	436	-56.4	3.8	-13.1
2500	4.1	-15.5	581	-44.1	422	-56.3	4.1	-15.5
2600	4.3	-16.7	577	-44.0	417	-56.2	4.3	-16.7
2700	4.6	-17.7	565	-43.9	406	-56.1	4.6	-17.7
2800	4.8	-18.8	553	-43.8	395	-56.0	4.8	-18.8
2900	5.1	-19.9	542	-43.7	395	-55.9	5.1	-19.9
3000	5.4	-21.0	531	-43.6	375	-55.7	5.4	-21.0
3100	5.6	-22.1	521	-43.5	366	-55.6	5.6	-22.1
3200	5.9	-23.2	511	-43.4	357	-55.4	5.9	-23.2
3300	6.1	-24.3	502	-43.3	349	-55.3	6.1	-24.3
3400	6.4	-25.4	494	-43.2	341	-55.1	6.4	-25.4
3500	6.6	-26.5	486	-43.1	334	-55.0	6.6	-26.5
3600	6.9	-27.6	478	-43.0	327	-54.8	6.9	-27.6
3700	7.1	-28.7	471	-42.9	321	-54.7	7.1	-28.7
3800	7.3	-29.9	464	-42.8	315	-54.6	7.3	-29.9
3900	7.5	-31.0	458	-42.7	310	-54.4	7.5	-31.0
4000	7.8	-32.1	452	-42.7	304	-54.3	7.8	-32.1

[] Denotes the Reference Loss and/or Delay Value

TABLE A.8/V.56 bis

EIA LL-6, loaded loop

End Office to Network Interface					Network Interface to End Office			
Freq. (Hz)	AD (dB)	EDD (μs)	Z (ohms)	Phase (deg.)	Z (ohms)	Phase (deg.)	AD (dB)	EDD (μs)
200	-0.2	-39.3	1756	-12.0	1748	-19.8	-0.2	-39.3
300	-0.2	-31.7	1642	-15.9	1689	-26.9	-0.2	-31.7
400	-0.2	-37.5	1506	-18.4	1427	-33.4	-0.2	-37.5
500	-0.1	-34.7	1442	-19.5	1301	-37.7	-0.1	-34.7
600	-0.1	-46.0	1363	-20.1	1153	-40.7	-0.1	-46.0
700	0.0	-40.8	1320	-20.7	1045	-42.2	0.0	-40.8
800	0.0	-40.1	1269	-21.5	943	-42.3	0.0	-40.1
900	0.0	-40.6	1227	-22.5	878	-41.3	0.0	-40.6
[1000]	[6.6]	-28.0	[1161]	[-23.4]	[825]	[-39.3]	[6.6]	-28.0
1100	0.0	-16.5	1082	-23.5	797	-36.8	0.0	-16.5
1200	-0.1	0.3	1000	-22.2	798	-34.4	-0.1	0.3
1300	0.0	-2.3	943	-19.3	826	-33.2	0.0	-2.3
1400	0.0	13.5	896	-14.0	870	-33.8	0.0	13.5
1500	0.1	22.6	890	-7.2	916	-36.8	0.1	22.6
1600	0.3	30.3	940	-0.3	938	-42.0	0.3	30.3
1700	0.5	12.5	1052	4.6	929	-48.0	0.5	12.5
[1800]	0.8	[458.6]	1212	6.9	880	-52.8	0.8	[458.6]
1900	1.1	-5.1	1410	3.5	814	-56.5	1.1	-5.1
2000	1.4	-5.0	1579	-3.6	747	-58.5	1.4	-5.0
2100	1.5	6.1	1618	-13.2	688	-58.8	1.5	6.1
2200	1.5	33.5	1491	-21.5	646	-57.7	1.5	33.5
2300	1.4	80.5	1275	-24.9	625	-55.6	1.4	80.5
2400	1.3	142.3	1078	-20.8	633	-53.8	1.3	142.3
2500	1.4	196.5	985	-9.3	664	-54.5	1.4	196.5
2600	1.6	214.5	1045	2.4	692	-57.6	1.6	214.5
2700	2.4	196.8	1326	13.7	684	-63.5	2.4	196.8
2800	3.4	150.4	1887	14.7	637	-68.3	3.4	150.4
2900	4.3	125.3	2608	1.3	501	-70.7	4.3	125.3
3000	4.9	174.6	2730	-21.8	533	-70.6	4.9	174.6
3100	4.9	380.0	2094	-33.7	506	-68.5	4.9	380.0
3200	5.2	759.3	1642	-21.3	522	-67.0	5.2	759.3
3300	8.0	680.1	2348	0.5	531	-72.9	8.0	680.1
3400	13.1	237.8	4510	-20.9	482	-77.3	13.1	237.8
3500	18.2	-18.8	4116	-59.6	439	-78.0	18.2	-18.8
3600	22.7	-145.4	3041	-74.4	487	-77.7	22.7	-145.4
3700	26.8	-214.5	2427	-80.1	383	-77.1	26.8	-214.5
3800	30.4	-257.0	2054	-82.7	364	-76.4	30.4	-257.0
3900	33.7	-285.6	1803	-84.2	348	-75.0	33.7	-285.6
4000	36.8	-306.2	1621	-85.1	334	-75.7	36.8	-306.2

[] Denotes the Reference Loss and/or Delay Value

TABLE A.9/V.56 bis

EIA LL-7, loaded loop

End Office to Network Interface					Network Interface to End Office			
Freq. (Hz)	AD (dB)	EDD (μ s)	Z (ohms)	Phase (deg.)	Z (ohms)	Phase (deg.)	AD (dB)	EDD (μ s)
200	0.4	-81.3	1848	-10.5	1737	-15.6	0.4	-81.3
300	0.3	-68.9	1785	-16.2	1585	-21.6	0.3	-68.9
400	0.2	-68.1	1646	-22.0	1388	-25.8	0.2	-68.1
500	0.1	-57.0	1528	-26.2	1247	-27.7	0.1	-57.0
600	0.0	-59.8	1349	-28.9	1087	-27.3	0.0	-59.8
700	0.0	-45.0	1205	-29.1	975	-24.8	0.0	-45.0
800	-0.1	-36.9	1064	-26.8	885	-19.7	-0.1	-36.9
900	-0.1	-37.1	989	-22.6	846	-13.5	-0.1	-37.1
[1000]	[5.9]	-29.2	[944]	[-16.6]	[847]	[-6.1]	[5.9]	-29.2
1100	0.1	-30.8	951	-10.5	900	0.3	0.1	-30.8
1200	0.2	-40.7	1008	-5.9	999	4.9	0.2	-40.7
1300	0.4	-53.3	1897	-4.0	1122	4.6	0.4	-53.3
1400	0.5	-52.7	1197	-4.8	1253	1.9	0.5	-52.7
1500	0.6	-48.3	1269	-8.4	1339	-3.8	0.6	-48.3
1600	0.6	-38.0	1274	-13.2	1337	-10.4	0.6	-38.0
1700	0.5	-21.6	1208	-16.9	1250	-15.2	0.5	-21.6
[1800]	0.4	[539.7]	1119	-17.8	1143	-16.6	0.4	[539.7]
1900	0.3	35.4	1027	-14.7	1036	-13.7	0.3	35.4
2000	0.3	64.1	989	-7.9	998	-6.9	0.3	64.1
2100	0.4	76.1	1045	0.1	1040	1.0	0.4	76.1
2200	0.6	69.8	1210	5.3	1197	6.9	0.6	69.8
2300	1.0	55.9	1460	4.6	1430	5.4	1.0	55.9
2400	1.2	51.3	1692	-2.8	1640	-1.7	1.2	51.3
2500	1.3	72.6	1730	-13.4	1666	-11.5	1.3	72.6
2600	1.3	117.1	1613	-49.6	1556	-16.9	1.3	117.1
2700	1.1	222.5	1371	-19.5	1334	-16.1	1.1	222.5
2800	1.1	332.3	1258	-8.9	1243	-5.1	1.1	332.3
2900	1.7	356.1	1474	4.8	1480	8.4	1.7	356.1
3000	2.8	299.9	2128	6.6	2143	9.8	2.8	299.9
3100	3.9	309.4	2813	-10.5	2882	-7.1	3.9	309.4
3200	4.4	576.4	2490	-27.7	2487	-22.2	4.4	576.4
3300	5.6	1030.6	2237	-17.4	2385	-9.0	5.6	1030.6
3400	10.7	570.2	3882	-19.2	4855	-14.9	10.7	570.2
3500	17.3	83.5	4116	-57.4	4649	-63.5	17.3	83.5
3600	23.2	-130.6	3057	-74.0	3175	-78.6	23.2	-130.6
3700	28.3	-153.9	2432	-80.0	2471	-83.1	28.3	-153.9
3800	32.8	-292.4	2055	-82.8	2072	-85.1	32.8	-292.4
3900	36.9	-249.9	1803	-84.2	1811	-86.1	36.9	-249.9
4000	40.7	-356.2	1621	-85.1	1625	-86.7	40.7	-356.2

[] Denotes the Reference Loss and/or Delay Value

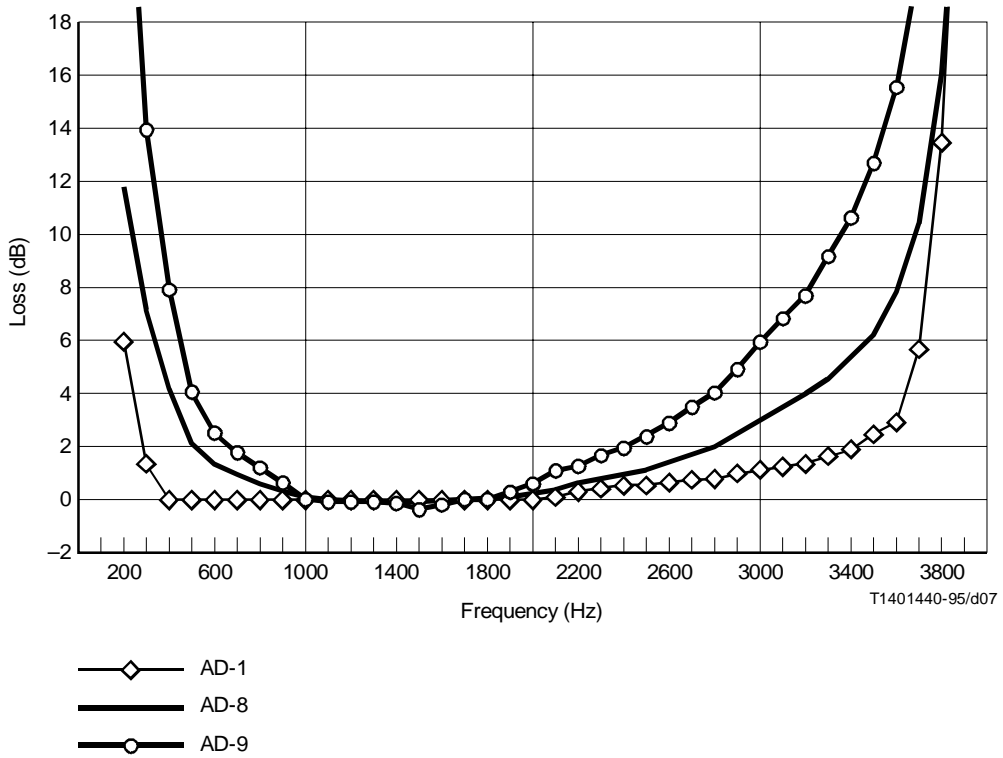

FIGURE A.5/V.56 bis
Attenuation distortion, AD-(1, 8 and 9)

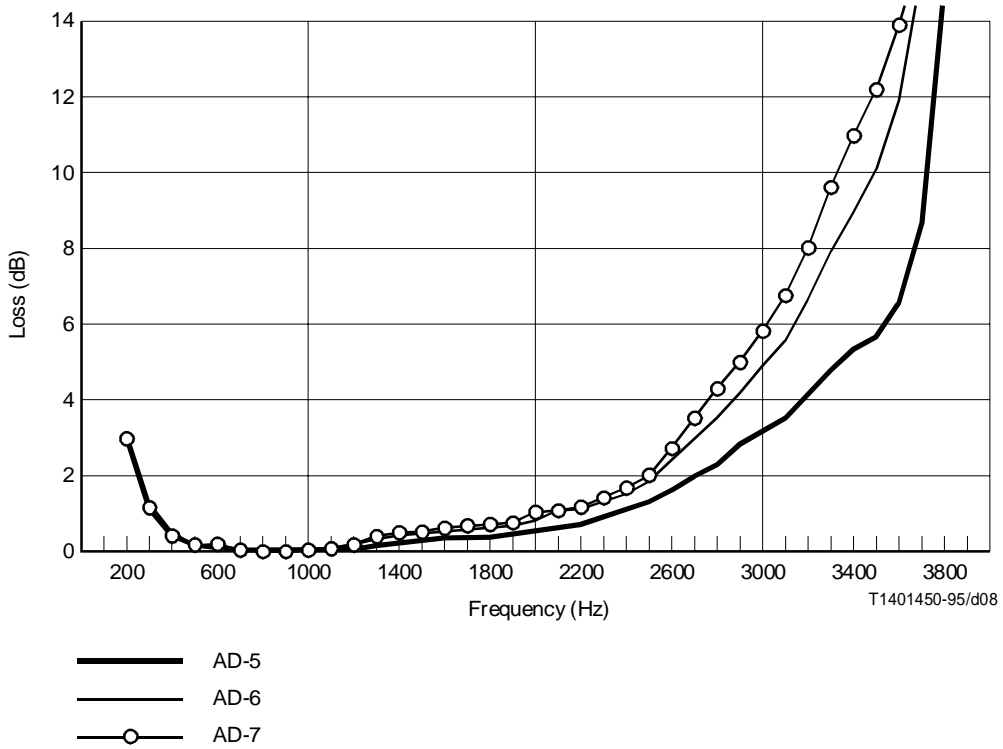

FIGURE A.6/V.56 bis
Attenuation distortion, AD-(5, 6 and 7)

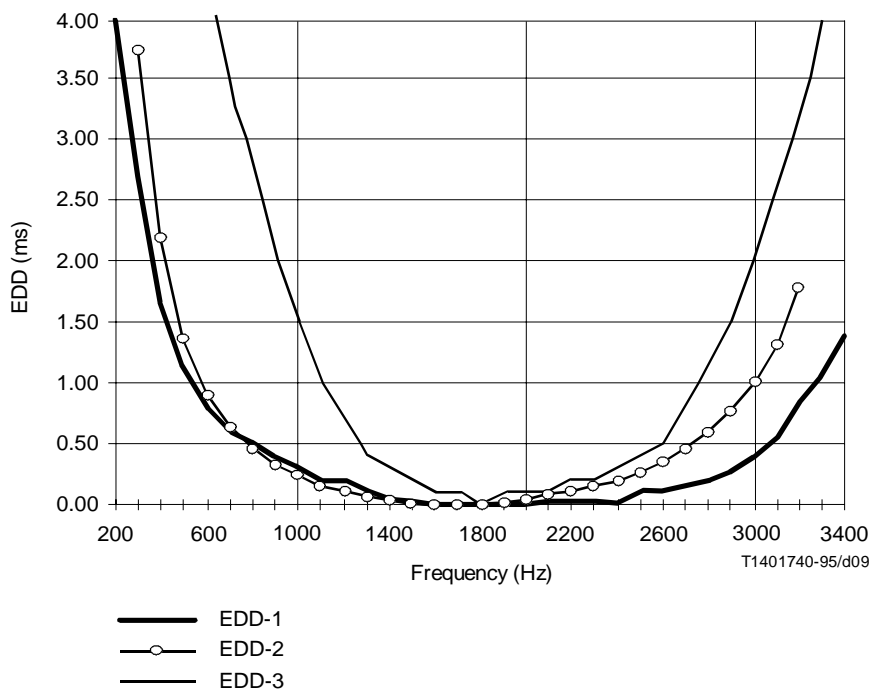

FIGURE A.7/V.56 bis
Envelope delay distortion, EDD-(1-3)

TABLE A.10/V.56 bis

AD-(1, 5-9) characteristics

	AD-1	AD-5	AD-6	AD-7	AD-8	AD-9
Freq. (Hz)	AD (dB)	AD (dB)	AD (dB)	AD (dB)	AD (dB)	AD (dB)
200	6.0	3.2	3.0	2.9	11.6	23.3
300	1.3	1.4	1.2	1.1	6.9	13.9
400	0.0	0.4	0.3	0.3	4.0	7.9
500	0.0	-0.1	0.0	0.1	2.0	4.1
600	0.0	-0.1	0.0	0.1	1.2	2.4
700	0.0	0.1	0.0	0.0	0.8	1.7
800	0.0	0.0	0.0	-0.1	0.5	1.1
900	0.0	0.0	0.0	-0.1	0.2	0.4
[1000]	[0.0]	[0.0]	[0.0]	[0.0]	[0.0]	[0.0]
1100	0.0	0.0	0.1	0.0	-0.1	-0.2
1200	0.0	0.0	0.1	0.1	-0.1	-0.2
1300	0.0	0.1	0.2	0.3	-0.1	-0.2
1400	0.0	0.2	0.3	0.4	-0.1	-0.3
1500	0.0	0.2	0.3	0.4	-0.2	-0.4
1600	0.0	0.3	0.5	0.5	-0.1	-0.3
1700	0.0	0.3	0.5	0.6	-0.1	-0.1
1800	0.0	0.3	0.5	0.6	0.0	0.0
1900	0.0	0.4	0.7	0.7	0.1	0.2
2000	0.0	0.5	0.8	0.9	0.2	0.5
2100	0.1	0.6	1.0	1.0	0.5	0.9
2200	0.2	0.7	1.1	1.1	0.6	1.1
2300	0.3	0.9	1.2	1.4	0.8	1.5
2400	0.4	1.1	1.5	1.6	0.9	1.8
2500	0.5	1.3	1.8	2.0	1.1	2.3
2600	0.6	1.6	2.4	2.7	1.4	2.8
2700	0.7	2.0	3.0	3.5	1.7	3.4
2800	0.7	2.3	3.5	4.3	2.0	4.0
2900	0.9	2.8	4.2	5.0	2.4	4.9
3000	1.1	3.2	4.9	5.8	3.0	5.9
3100	1.2	3.5	5.6	6.7	3.4	6.8
3200	1.3	4.1	6.7	8.0	3.9	7.7
3300	1.6	4.8	8.0	9.6	4.6	9.2
3400	1.8	5.3	9.1	11.0	5.4	10.7
3500	2.4	5.7	10.3	12.2	6.3	12.6
3600	3.0	6.6	12.1	13.9	7.8	15.5
3700	5.7	8.9	15.8	17.3	10.3	20.5
3800	13.5	15.7	24.4	25.7	16.2	32.4
3900	31.2	31.1	42.2	43.3	29.9	59.9
AD Tolerance						
200 Hz to 300 Hz ± 2 dB						
300 Hz to 400 Hz ± 1 dB						
400 Hz to 3000 Hz ± 0.5 dB						
3000 Hz to 3300 Hz ± 1 dB						
3300 Hz to 3600 Hz ± 2 dB						
3600 Hz to 3900 Hz ± 3 dB						
[] Denotes the Reference Loss and/or Delay Value						

TABLE A.11/V.56 bis

Envelope delay distortion EDD-1-3

	EDD-1	EDD-2	EDD-3
Freq. (Hz)	EDD (ms)	EDD (ms)	EDD (ms)
200	3.98	*	*
300	2.70	3.76	8.0
400	1.69	2.20	6.9
500	1.15	1.36	5.5
600	0.80	0.91	4.4
700	0.60	0.64	3.4
800	0.50	0.46	2.8
900	0.40	0.34	2.0
1000	0.30	0.24	1.5
1100	0.20	0.16	1.0
1200	0.20	0.11	0.7
1300	0.10	0.07	0.4
1400	0.05	0.05	0.3
1500	0.00	0.03	0.2
1600	0.00	0.01	0.1
1700	0.00	0.0	0.1
[1800]	[0.0]	[0.0]	[0.0]
1900	0.00	0.02	0.1
2000	0.00	0.04	0.1
2100	0.02	0.08	0.1
2200	0.02	0.12	0.2
2300	0.02	0.16	0.2
2400	0.02	0.20	0.3
2500	0.10	0.27	0.4
2600	0.12	0.36	0.5
2700	0.15	0.47	0.8
2800	0.20	0.60	1.1
2900	0.27	0.77	1.5
3000	0.40	1.01	2.0
3100	0.56	1.32	2.6
3200	0.83	1.78	3.2
3300	1.07	*	4.0
3400	1.39	*	*
3500	*	*	*

EDD tolerance
200 Hz to 400 Hz (+ 0.5/- 0.2) ms
500 Hz to 3100 Hz ± 0.1 ms
3200 Hz to 3500 Hz (+ 0.5/- 0.2) ms
[] Denotes the Reference Delay Value
* Values in this range are not specified, but assumed not to decrease

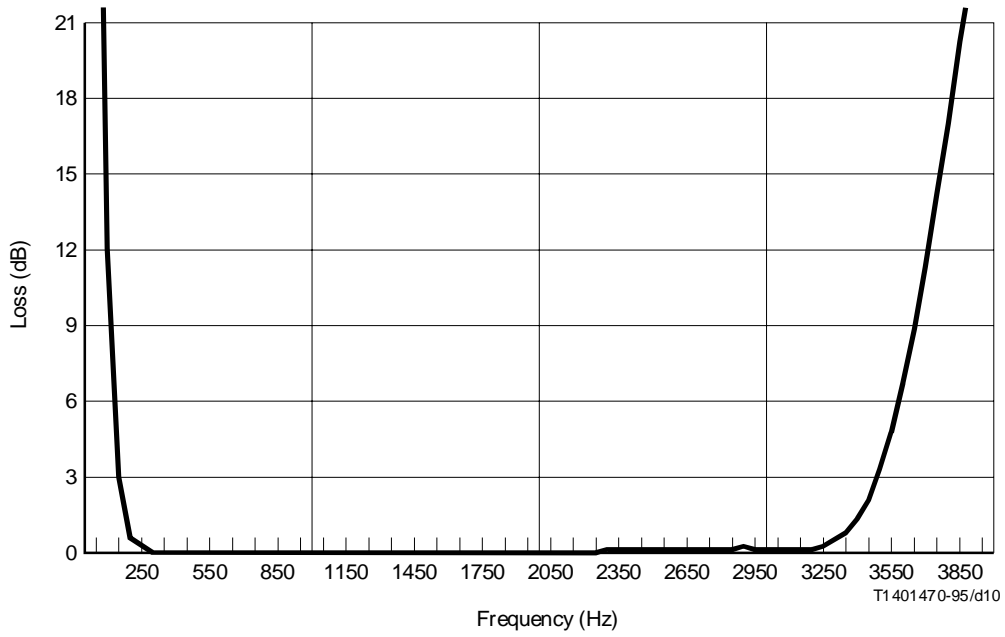

FIGURE A.8/V.56 bis
1 PCM codec attenuation distortion (combined transmit and receive filter)

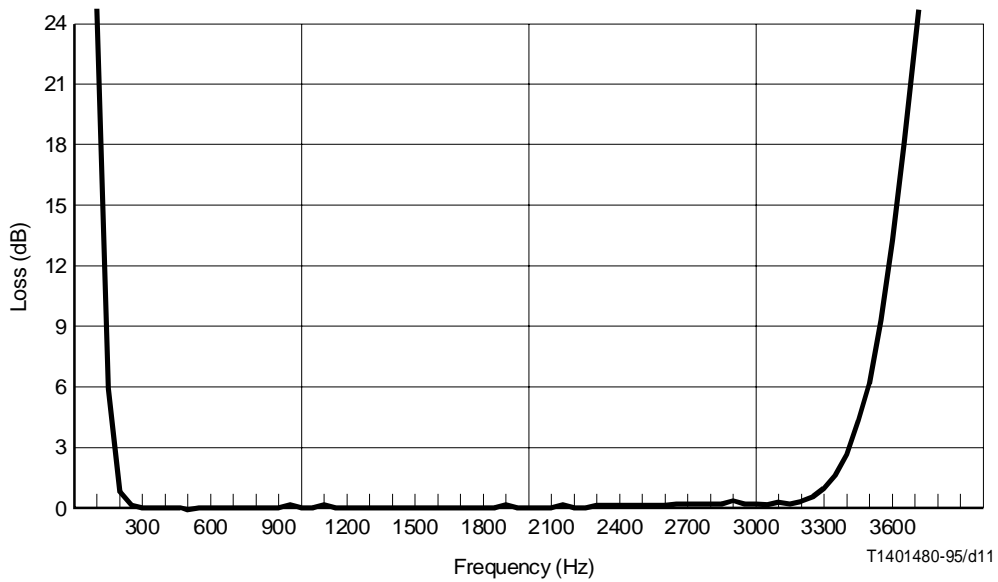

FIGURE A.9/V.56 bis
2 PCM codecs attenuation distortion (combined transmit and receive filters)

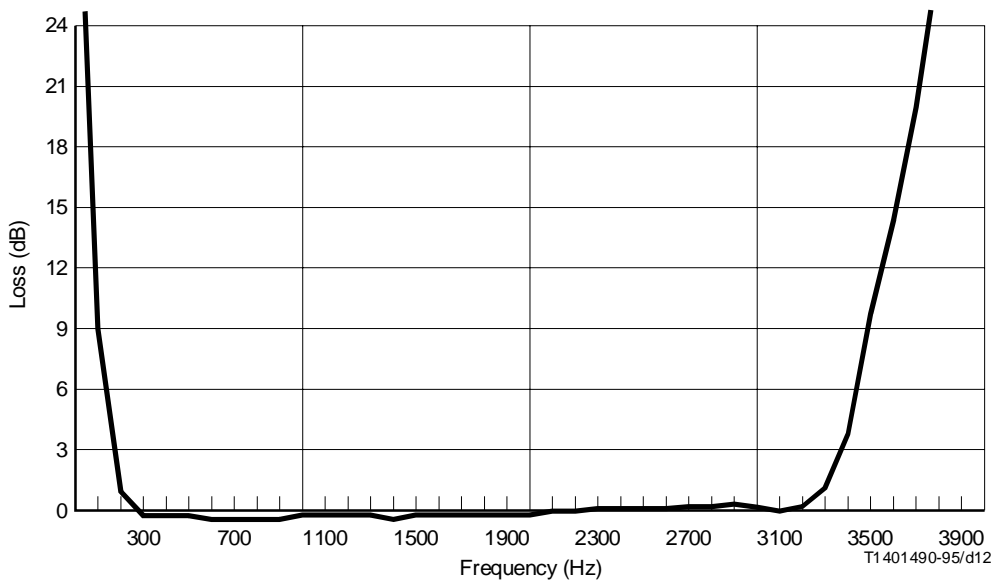

FIGURE A.10/V.56 bis
3 PCM codecs attenuation distortion (combined transmit and receive filters)

TABLE A.12/V.56 bis

PCM codec attenuation distortion

Frequency (Hz)	1 PCM AD (dB)	2 PCM AD (dB)	3 PCM AD (dB)
50	41.4	77.8	114.2
100	15.5	27.7	39.9
150	3.7	6.1	8.6
200	0.5	0.8	1.0
250	-0.2	-0.2	-0.3
300	-0.2	-0.3	-0.4
400	0.0	-0.2	-0.3
500	-0.2	-0.4	-0.5
600	-0.2	-0.3	-0.5
700	-0.2	-0.3	-0.5
800	-0.2	-0.4	-0.5
900	-0.2	-0.3	-0.4
1000	-0.1	-0.2	-0.3
1100	-0.2	-0.3	-0.3
1200	-0.2	-0.3	-0.4
1300	-0.2	-0.3	-0.5
1400	-0.1	-0.3	-0.4
1500	-0.1	-0.3	-0.4
1600	-0.1	-0.2	-0.3
1700	-0.1	-0.3	-0.4
1800	-0.2	-0.3	-0.4
1900	-0.2	-0.3	-0.3
2000	-0.1	-0.2	-0.3
2100	-0.1	-0.2	-0.3
2200	-0.1	-0.3	-0.4
2300	-0.1	-0.1	-0.2
2400	-0.1	-0.1	-0.2
2500	0.0	-0.1	-0.1
2600	0.0	-0.1	-0.1
2700	0.0	0.0	0.1
2800	0.0	0.0	0.1
2900	0.1	0.2	0.2
3000	0.0	0.0	0.1
3100	0.0	0.0	0.0
3200	0.0	0.0	0.1
3300	0.3	0.7	1.0
3400	1.2	2.4	3.6
3500	3.2	6.3	9.5
3550	5.0	9.6	14.3
3600	7.0	13.5	19.9
3650	10.0	18.7	27.5
3700	13.4	24.6	35.8
3750	18.1	32.1	46.2
3800	24.3	41.2	58.2
3850	32.5	52.6	72.7
3900	43.4	66.6	89.8

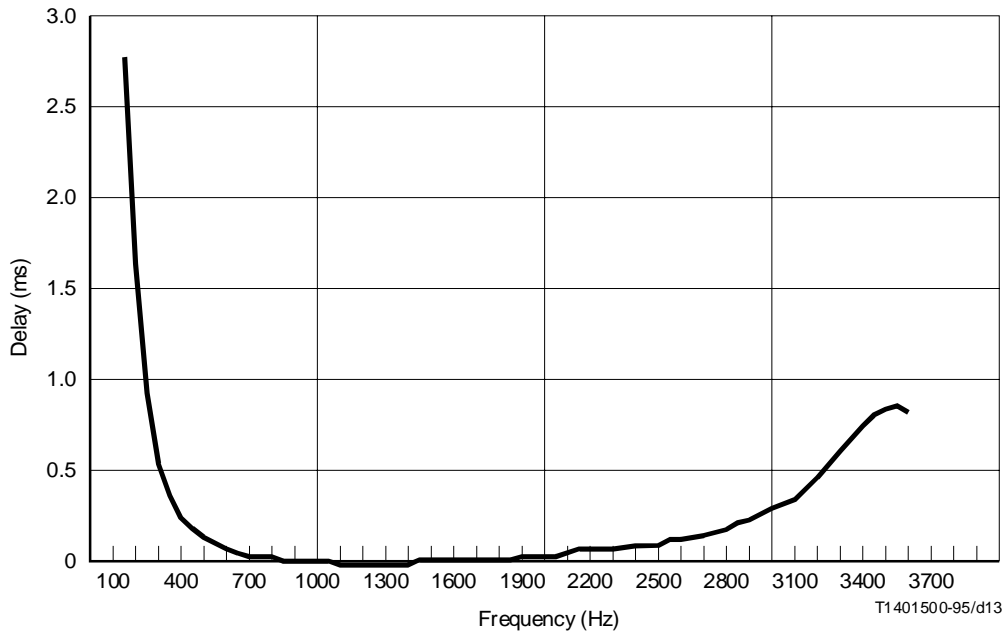

FIGURE A.11/V.56 bis
1 PCM codec envelope delay distortion (EDD)
 (combined transmit and receive filter)

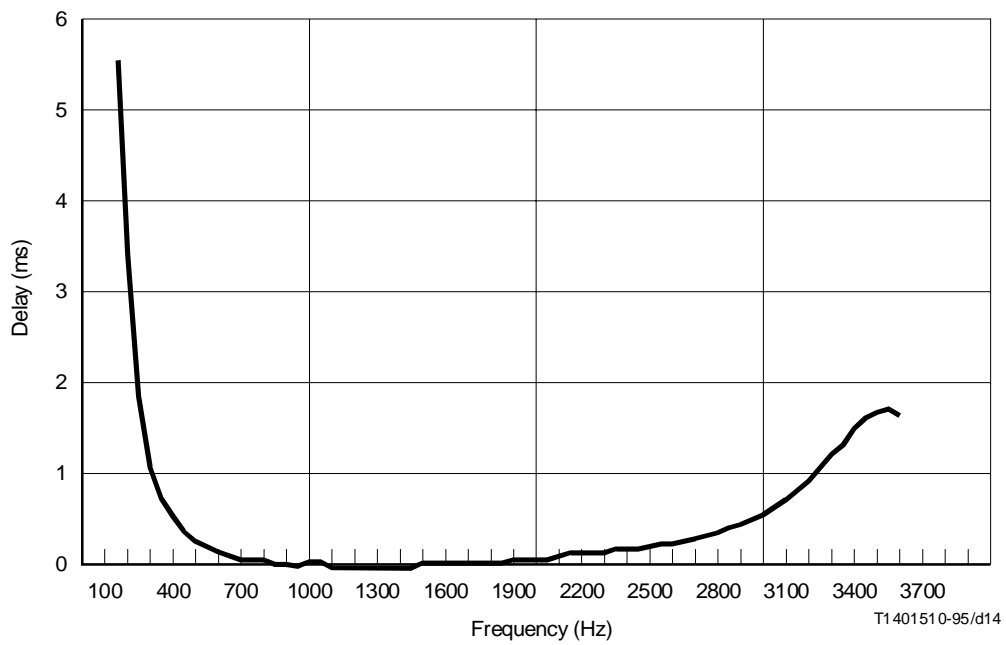

FIGURE A.12/V.56 bis
2 PCM codecs envelope delay distortion (EDD)
 (combined transmit and receive filters)

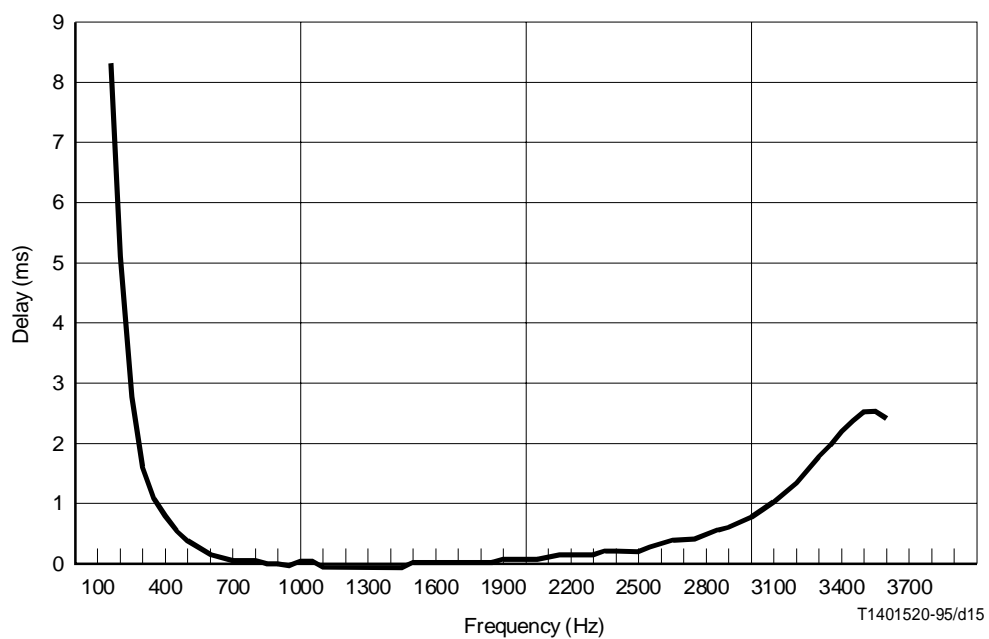

FIGURE A.13/V.56 bis
3 PCM codecs envelope delay distortion (EDD)
(combined transmit and receive filters)

TABLE A.13/V.56 bis

PCM codec envelope delay distortion (EDD)

Frequency (Hz)	1 PCM EDD (ms)	2 PCM EDD (ms)	3 PCM EDD (ms)
150	2.76	5.5	8.3
200	1.70	3.4	5.1
250	0.92	1.8	2.8
300	0.55	1.1	1.7
400	0.25	0.5	0.7
500	0.12	0.2	0.4
600	0.06	0.1	0.2
700	0.03	0.1	0.1
800	0.01	0.0	0.0
900	0.00	0.0	0.0
1000	-0.01	0.0	0.0
1100	-0.01	0.0	0.0
1200	-0.02	0.0	-0.1
1300	-0.02	0.0	-0.1
1400	-0.01	0.0	0.0
1500	-0.01	0.0	0.0
1600	0.00	0.0	0.0
1700	0.00	0.0	0.0
1800	0.01	0.0	0.0
1900	0.02	0.0	0.0
2000	0.02	0.0	0.1
2100	0.04	0.1	0.1
2200	0.05	0.1	0.2
2300	0.06	0.1	0.2
2400	0.07	0.1	0.2
2500	0.10	0.2	0.3
2600	0.11	0.2	0.3
2700	0.14	0.3	0.4
2800	0.18	0.4	0.5
2900	0.22	0.4	0.6
3000	0.27	0.5	0.8
3100	0.34	0.7	1.0
3200	0.45	0.9	1.4
3250	0.52	1.0	1.6
3300	0.60	1.2	1.8
3350	0.66	1.3	2.0
3400	0.74	1.5	2.2
3450	0.79	1.6	2.4
3500	0.83	1.7	2.5
3550	0.84	1.7	2.5
3600	0.81	1.6	2.4

Annex B

Minimizing test time

In 4.7, four representations of the network model are specified, giving the tester the flexibility to trade testing time against the percentage of the network model covered. This annex describes a basis for defining a conditional testing procedure which can further reduce the testing time for error ratio testing for modem modulations that implement several modem-to-modem data rates. The use of this conditional procedure is based on the following assumptions:

- If a modem modulation achieves, for a given data signalling rate, a certain error rate over a certain impairment combination, it will achieve an equal or better error rate for those impairment combinations that are the same, except for having either a lower IMD level, lower noise level, fewer PCM encodings, or a higher THL.
- If a modem modulation achieves, for a given data signalling rate, a certain error rate over a certain impairment combination, it will achieve an equal or better error rate at all lower signalling rates on the same impairment combination. Note that this property only applies to the set of signalling rates within a modem modulation (e.g. 4800-14 400 bps for Recommendation V.32 *bis*, or 2400-28 800 for Recommendation V.34), and cannot be applied across different modulation standards.

These assumptions are technically reasonable for all standard modem modulations.

Since the time saved is most significant for the complete network model shown in Table 3, this is the only case considered here. It is possible to design a conditional testing procedure for the truncated versions of the network model, but it is not recommended because the procedure becomes more complex and the testing time saved is significantly less.

It is not mandatory to use this form of conditional testing; however, if the test equipment supports it, it is highly recommended because it results in a very significant reduction in the number of tests to be performed. This is particularly true when the modems being tested have a large number of possible transmission rates which need to be tested, such as performing block-error rate tests on V.34 modems.

If this form of conditional testing is used, the following rules shall be followed:

- Tests shall be performed first at the highest transmission rate supported by the modems.
- Tests shall be performed in the order specified below, as illustrated in Figure B.1. The first set of tests to perform with each TLC shall be with EO-EO Table 1a impairment combinations 4a, 1a, 6a, 7a and 8a or Table 1b impairment combinations 12a, 9a, 14a, 15a and 16a, the entries at the top of each tree shown in Figures B.1 and B.2 respectively. These combinations represent the most severe conditions for each tree. This ordering of the tests has been constructed based on the following observations:
 - 1) the “a” impairment combinations are more severe than the “b” combinations;
 - 2) the “b” impairment combinations are more severe than the “c” combinations;
 - 3) impairment combinations “4 or 12” are more severe than combinations “3 or 11”;
 - 4) impairment combinations “3 or 11” are more severe than combinations “2 or 10”;
 - 5) impairment combinations “1 or 9” are more severe than combinations “2 or 10”; and finally
 - 6) impairment combinations “6 or 14” are more severe than combinations “5 or 13”.
- Tests that exceed the maximum error ratio threshold of interest during the test may be terminated early. The recommended error-rate threshold is a block-error ratio of $1E^{-1}$ or bit-error ratio of $1E^{-3}$.

- If a test results in an error ratio that falls below the minimum threshold of 10 block errors, the block-error ratio shall be scored simply as “<10 errors” rather than the measured value, and all EO-EO impairment combination tests that the current test points to (either directly or indirectly) in the appropriate tree in Figure B.1, for the current TLC, shall automatically receive the same recorded result without requiring the tests to be performed.
- If a test results in an error ratio measurement that either exceeds the maximum threshold or lies within the range of interest, the next set of tests to run shall include all of those that the current test directly points to in Figure B.1.
- If a test results in an error ratio measurement that falls below the minimum threshold of 10 block errors at a given modem transmission rate, it is not necessary to perform the same test at lower transmission rates. All lower transmission rates for that particular TLC and EO-EO impairment combination test shall automatically be given the same recorded result, namely “<10 errors”.
- If a test results in an error ratio measurement that either exceeds the maximum threshold or lies within the range of interest, the test shall be repeated at the next lower transmission rate.

The process of eliminating tests is best understood by way of an example. Suppose that for a particular transmission rate and TLC, the first set of tests has been run, namely with impairment combinations 4a, 1a, 6a, 7a and 8a, and that the number of block errors measured for combination 1a is less than 10. Combinations 1b and c, and 2a, b and c are then all granted the same result, namely “<10 errors”. The next set of tests to perform would be with impairment combinations 4b, 3a, 6b, 5a, 7b and 8b.

Suppose that the number of block errors for combination 6b is then less than 10. Combinations 6c and 5b and c are then granted the same result. The next set of tests to run would be with impairment combinations 4c, 3b, 7c and 8c.

Suppose that the number of block errors for impairment combination 4c is then less than 10. Combination 3c is then granted the same result, and the testing for the current TLC and transmission rate is finished.

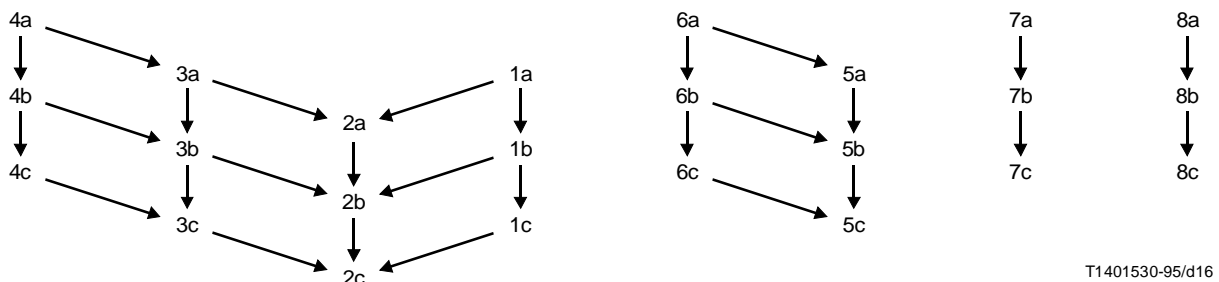

FIGURE B.1/V.56 bis

EO to EO impairment combination hierarchy for intracontinental connections (Table 1a)

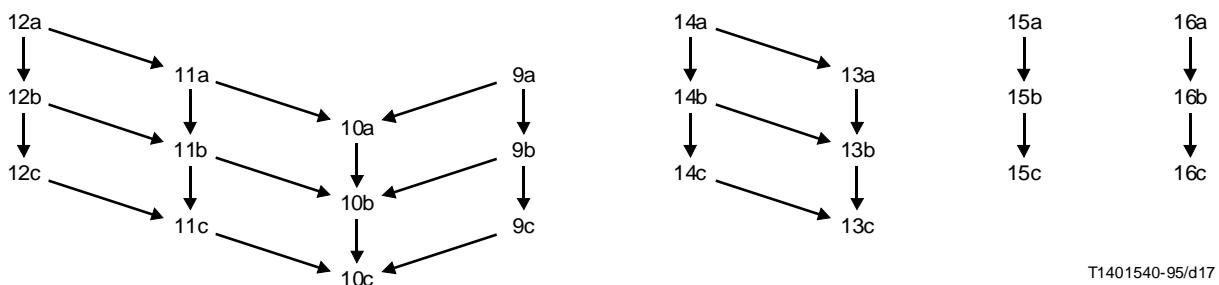

FIGURE B.2/V.56 bis

EO to EO impairment combination hierarchy for intercontinental connections (Table 1b)

Appendix I

Rare intracontinental network model

I.1 Model description

Table I.1 contains EO-EO impairment combinations that are representative of unusual intracontinental connections that may be encountered by some users. Even though the likelihood of these impairments is low, users that encounter these impairments are likely to experience them on all or essentially all connections.

Combinations 17 through 20 may be encountered on connections within a continent. For tests using impairment combinations given in this table, it is recommended that the tests be conducted with subsets of the TLCs from Table 2 as indicated.

It is also recommended that a test be conducted for impairment combination 18 using a TLC (long loop simulation) having the characteristics of EIA test loops 1 and 5 connected together, on both sides of the connection (Loop A and Loop B). This TLC is referred to as TLC 8.

It is important to note that impairment combination 17, which includes a G.726 ADPCM link, represents a particularly stressful condition for modems. The impairment combinations represent unusual intracontinental conditions.

TABLE I.1/V.56 bis

Rare intracontinental (EO to EO) model

Types of Impairments Test Loop Combinations		Units TLC	17 1, 5 & 6	18 1, 5, 6 & 8	19 5	20 7
1	AD		None	AD-7	None	None
2	EDD		None	None	None	None
3	1 kHz Loss	dB	8.0	9.0	6.0	6.0
4a	Added Noise	dBm	-68	-68	-68	-68
4b	TNR	dB	N/A	N/A	N/A	N/A
5	Phase Jitter					
5a	P-P deviation	Deg.	None	None	None	None
5b	Frequency	Hz	None	None	None	None
6	IMD-(4 Tone)					
6a	2nd Order (H2/R2)	dB	60	50	55	56
6b	3rd Order (H3/R3)	dB	58	51	55	56
7	Frequency Offset					
7a	FO (A to B)	Hz	None	None	None	None
7b	FO (B to A)	Hz	None	None	None	None
8	PCM (64 kbit/s)		A-law	A-law	A-law	A-law
8a	Tandem Links	No.	1	1	1	1
8b	Robbed Bit Signalling		No	No	No	No
8c	RBS Location	Link No.				
9	ADPCM					
9a	Type		Rec. G.726	None	None	None
9b	Signalling Rate	kbit/s	32	None	None	None
9c	ADPCM Location	Link No.	1	None	None	None
10	Echo					
10a	RTD	ms	80	80	80	80
10b	THL (A)	dB	22	22	6	6
10c	THL (B)	dB	22	22	22	6

Appendix II

Basis for network models

The basis of the various EO-EO impairment combinations given in Table 1 and the TLCs given in Table 2 are discussed in this appendix. The optional tests connections given in Appendix I are also discussed.

The EO-EO characteristics are based largely on information from North America. Facility characteristics (impairment magnitudes) are based on ANSI TIA TSB-37A TELEPHONE NETWORK TRANSMISSION MODEL FOR EVALUATING MODEM PERFORMANCE issued in September 1994.

Each combination in Table 1 reflects a combination of different types of interoffice transmission facilities and switching equipment. A graphical representation of these combinations is depicted in Figures II.2-II.19 and Figure II.1 contains the legend. For example, combination 1 represents the connection configuration to which networks are presently evolving: digital switches in local offices connected through digital transport.

Combination 1 also includes the situation where a user is served with a digital PBX on a digital local switch and where a user is served on a digital subscriber carrier system. In all cases, users' loops terminate in a codec, and the codecs are connected with digital transport end-to-end.

Combination 2 represents connections where the local office serving the transmitting modem has an analogue (commonly referred to as space division) switch but where the transport across the network is digital.

Combination 3 represents a connection including 2 PCM links. Such a situation occurs under a variety of conditions; for example, a user served on a digital subscriber carrier system on an analogue local switch with digital transport between end offices.

Combination 4 is the extension of this situation where conversion to analogue and back to digital occurs at both ends of the connection, resulting in 3 PCM links in tandem.

Combination 5 is representative of the local connection where the interoffice trunk is a metallic pair and the switches are analogue.

Combination 6 is the extension of the connection that includes a metallic pair to, typically, a toll or tandem connection resulting in a metallic pair trunk in tandem with a PCM link.

Combinations 7 and 8 are intended to represent connections including links on the nearly extinct (when considering industrial ECs) analogue type of carrier systems. However, it is recognized many small ECs continue to use these older type analogue carrier facilities and therefore, these carrier facilities are included as part of the network model. But, in recognition of the relatively small percentage of data traffic that is carried by such ECs, the total LOO associated with combinations including these facilities is limited to 4%. Only a 2% LOO has been assigned to the impairment combinations using an analogue only carrier system. The other 2% LOO has been assigned to the more common situation that would arise in today's network, namely, a mixed connection including links on both analogue carrier system and a digital carrier system. It is expected that, over time, all ECs will convert the analogue carrier facilities over to digital carrier facilities.

Combination 9 represents the connection configuration to which networks are presently evolving: digital switches in local offices connected through digital transport. However, combination 9 also represents transoceanic transmission implementing a non-standard 32 kbit/s ADPCM voice compression technique commonly encountered across the Atlantic Ocean.

Combination 10 represents the connection configuration identical to combination 9. However, combination 10 represents transoceanic transmission implementing yet another non-standard 32 kbit/s ADPCM voice compression technique frequently encountered across the Pacific Ocean.

Combination 11 represents another transoceanic connection utilizing a standard 40 kbit/s ADPCM technique (Recommendation G.726) that also includes a second PCM link in tandem. Such a situation occurs under a variety of conditions; for example, a user served on a digital subscriber carrier system on an analogue local switch with digital transport between end offices where the second end office is on another continent.

Combination 12 is the extension of combination 11 where there is a conversion to analogue and back to digital occurs at both ends of the connection, resulting in 3 PCM links in tandem. As was the case in the above intercontinental connections, the transoceanic portion of the connection contains a facility utilizing a Recommendation G.726 40 kbit/s ADPCM voice compression technique.

Combination 13 represents the connection configuration where there is a metallic trunk added in the connection, before going over a transoceanic transmission facility utilizing the same non-standard 32 kbit/s ADPCM voice compression technique as is in combination 9.

Combination 14 represents the connection configuration where there is a metallic trunk added in the connection, before going over a transoceanic transmission facility utilizing the standard Recommendation G.726 40 kbit/s ADPCM voice compression technique.

Combination 15 represents the connection configuration where there is an analogue carrier facility added in the connection, before going over a transoceanic transmission facility utilizing the non-standard 32 kbit/s ADPCM voice compression technique as in combination 9.

Combination 16 represents the connection configuration where there is an analogue carrier facility added in the connection, before going over a transoceanic transmission facility utilizing the standard Recommendation G.726 40 kbit/s ADPCM voice compression technique.

It is worth noting that the AD and EDD associated with PCM links are assumed to be included in the codecs used in simulators and the "none" in the tables indicates that no additional distortion is to be added.

Combinations 1 through 6 are based largely on estimates for 1994 of the characteristics of the Networks of the larger North American telephone companies. Combinations 7 and 8 are included to account for the capabilities of small independent telephone companies.

Combinations 1c, 3c, 4c and 6c are intended to reflect the 90% worst case point on the distribution of impairments (IMD and THL). The "b" and "a" combinations are intended to reflect the 95 and 99 percentiles, respectively, on the distributions. Note that these combinations all assume that the local switches are digital for which each loop has an associated codec and hybrid or small group of such elements. This means that the THL and IMD experienced by a user will be essentially the same for all connections.

Combinations 2c, 5c, 7c and 8c are intended to reflect the 85% worst case point on the distribution of impairments (IMD and THL). The "b" and "a" combinations are intended to reflect the 90 and 95 percentiles, respectively, on the distributions. Note that these combinations simulate network connections where the local switch is analogue. In this case, the impairments are determined by elements on the trunk side of the local switch and for the user, will vary in magnitude from connection to connection. Many such users can be expected to try a second connection when unacceptable performance is provided by an initial connection. Therefore, the same overall quality of service will be realized by users on a digital switch. The assignment of impairment levels corresponding to lower percentiles on the impairment distributions for combinations that simulate connections involving analogue local switches reflects this consideration.

The loop combinations reflect the distribution of loops in North America, but modified to reflect the fact that many loaded loops are used in rural areas where modems are less likely to be used. The LOOs also reflect an attempt to recognize the inclusion of loops behind PBXs, which are relatively short. The number of combinations included reflects an attempt to cover the range of stresses that are caused by different loop conditions without unnecessarily increasing the number of combinations to be tested.

The combinations specified in Appendix I contain impairments that are particularly stressful (G.726 ADPCM and TLC 8) and would have a very low LOO. They provide a basis for assessing the modem's ability to deal with unusual intracontinental conditions that may be encountered by some users on all or essentially all connections.

Combinations 17 and 18 in Table I.1 simulate conditions that individual users may encounter on essentially all connections. Combination 17 represents the DLC system or PBX with digital trunks that uses the G.726 ADPCM coding algorithm, which severely limits high speed modem performance. Combination 18 simulates the condition of a metallic pair trunk that has an unusually high loss.

It should be noted that a test with loops having nearly the worst-case loss is suggested in Appendix I. While the combination of loops 1 and 5 does not have the loss of the worst case loop, it is specified to avoid the need for a loop that is not available in most simulators.

The combinations specified in Table 1b provide a basis for evaluating the performance of modems on typical intercontinental connections. Combinations 9 through 16 cover intercontinental connections including an ADPCM link. Connections may be encountered that do include only PCM coding, but such connections are adequately covered by the intracontinental combinations in Table 1a. Table 1b specifies the three different types of 32 kbit/s ADPCM coding that may be encountered. The RTDs specified are intended to be typical of the different delays that can be encountered on intercontinental connections.

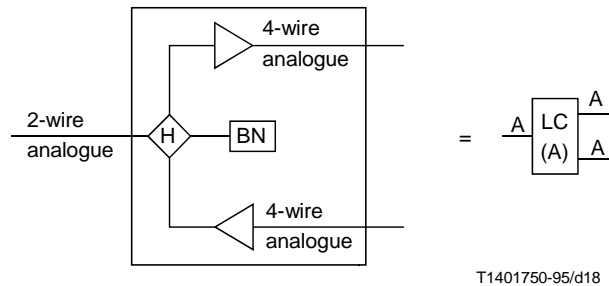

a) Line Card – Analogue [LC (A)]

2-wire analogue:

Metallic analogue 2-wire (loop) interface to the line card.

Hybrid:

Represented by the diamond with the letter “H” in the centre. The hybrid regardless of design, serves the role of a 2-wire to 4-wire converter of an analogue signal.

Balance Network (BN):

A network of components typically used to achieve an acceptable level of hybrid rejection (commonly referred to as a Transhybrid loss) to minimize echo levels in the network. This balancing network is a compromise estimate of the local loop connected to the line card.

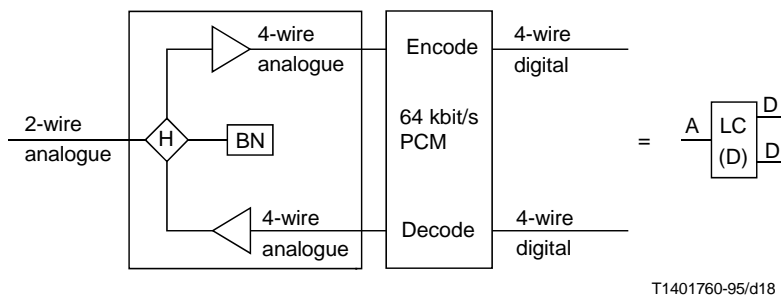

b) Line Card – Digital [LC (D)]

The 2-wire analogue interface, hybrid and balancing network are the same as for the Line Card – Analogue above.

Encode:

The 4 kHz analogue signal being encoded (analogue to digital converted) into a 64 kbit/s PCM (digital) serial bit stream.

Decode:

The 64 kbit/s PCM (digital) serial bit stream being decoded (digital to analogue converted) to a 4 kHz analogue signal.

FIGURE II.1A/V.56 bis

Legend

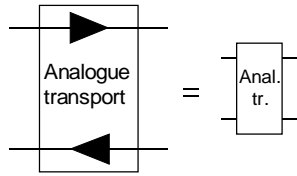

Indicates analogue transport (FDM)

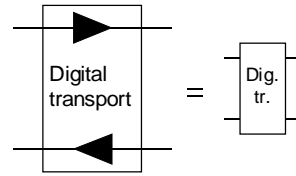

Indicates digital transport

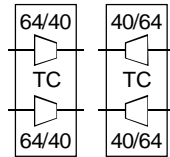

Indicates 40 kbit/s ADPCM to 64 kbit/s PCM conversion

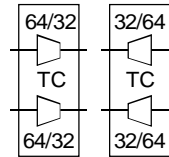

Indicates 32 kbit/s ADPCM to 64 kbit/s PCM conversion

Network transcoder (TC)



2-wire analogue trunk

Indicates a 2-wire local connection through analogue switches offices. The connection represents the case where there are 2 analogue switch offices separated by a 2-wire trunk (typically the trunk has no amplification)



Indicates a 2-wire analogue switch (bidirectional)

T1401770-95/d19

FIGURE II.1B/V.56 bis

Legend

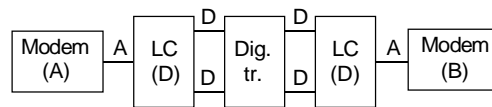

T1401780-95/d20

FIGURE II.2/V.56 bis

Connection types 1, 19 and 20 representation
(1 PCM line – digital transmission representation)

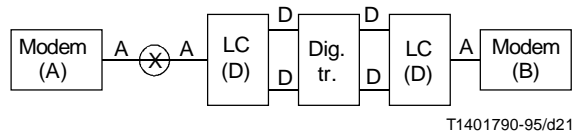

FIGURE II.3/V.56 bis
Connection type 2 representation
 (1 PCM line – digital transmission representation
 with an analogue switch)

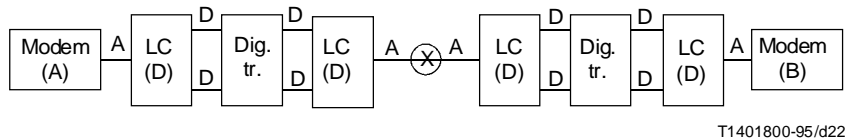

FIGURE II.4/V.56 bis
Connection type 3 representation
 (2 PCM links in tandem – digital transmission representation
 with an analogue switch)

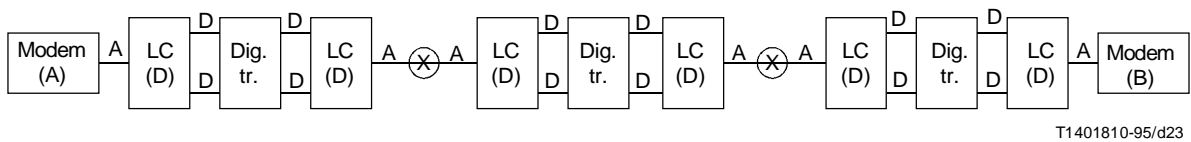

FIGURE II.5/V.56 bis
Connection type 4 representation
 (3 PCM links in tandem – digital transmission representation
 with 2 analogue switches)

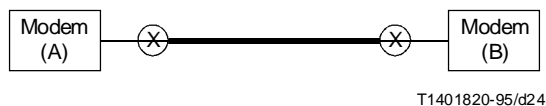

FIGURE II.6/V.56 bis
Connection type 5 representation
 (2-wire analogue trunk representation
 with 2 analogue switches)

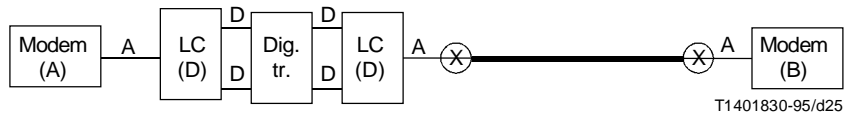

FIGURE II.7/V.56 bis

Connection type 6 representation
 (2-wire analogue trunk, 2 analogue switches
 and 1 PCM link digital transmission representation)

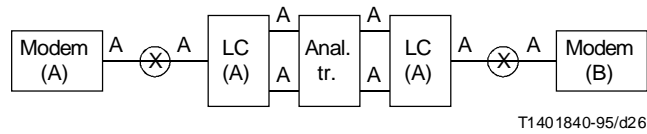

FIGURE II.8/V.56 bis

Connection type 7 representation
 (Analogue carrier transmission representation
 with 2 analogue switches)

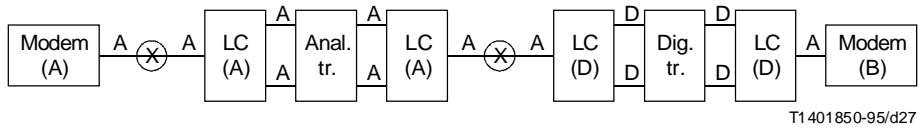

FIGURE II.9/V.56 bis

Connection type 8 representation
 (Combined analogue carrier and digital transmission representation
 with 2 analogue switches)

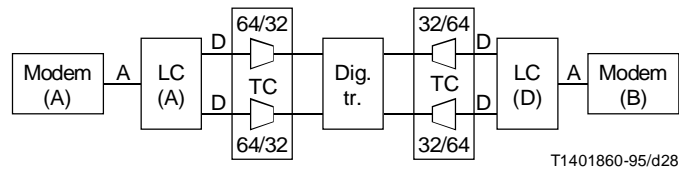
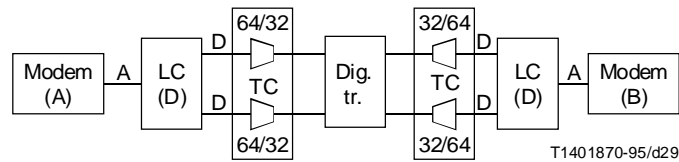

FIGURE II.10/V.56 bis

Connection type 9 representation
 (CCITT COM XVIII-102: 1984-1988 digital transmission representation)
 Transoceanic connection



T1401870-95/d29

FIGURE II.11/V.56 bis

Connection type 10 representation 32 kbit/s ADPCM
 (CCITT COM XVIII-101: 1984-1988 digital transmission representation)
 Transoceanic connection

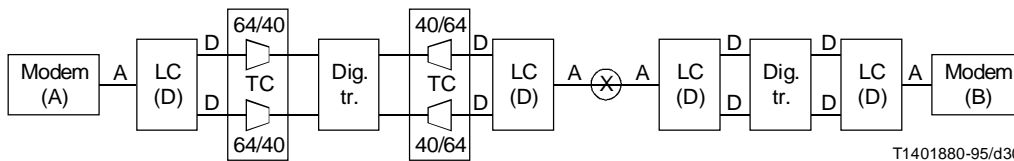

T1401880-95/d30

FIGURE II.12A/V.56 bis

Connection type 11a representation 40 kbit/s ADPCM
 (Analogue switch, Rec. G.726 and 2 PCM links in tandem and double satellite hop)
 Transatlantic connection

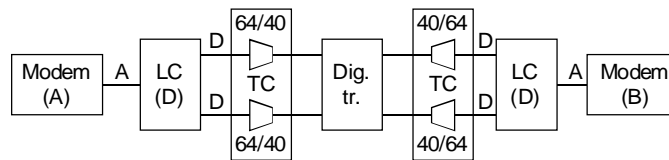

T1401890-95/d31

FIGURE II.12B/V.56 bis

Connection type 11b and 11c representation 40 kbit/s ADPCM
 (Rec. G.726 and 1 PCM links in tandem)
 Transatlantic connection

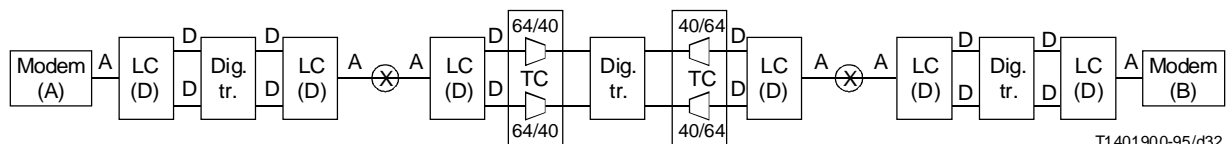

T1401900-95/d32

FIGURE II.13/V.56 bis

Connection type 12 representation 40 kbit/s ADPCM
 (Rec. G.726 and 3 PCM links in tandem)
 Transatlantic connection

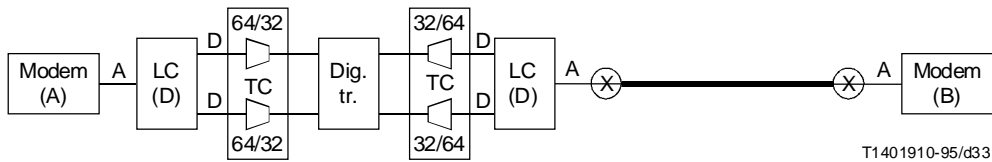

T1401910-95/d33

FIGURE II.14/V.56 bis

Connection type 13 representation 32 kbit/s ADPCM
 (2-wire analogue trunk, 2 analogue switches and CCITT COM XVIII-102: 1984-1988 digital transmission representation)
 Transoceanic connection

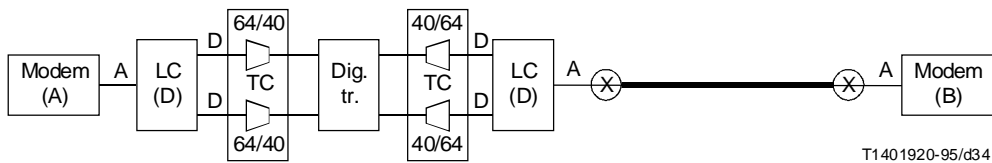

T1401920-95/d34

FIGURE II.15/V.56 bis

Connection type 14 representation 40 kbit/s ADPCM
 (2-wire analogue trunk, 2 analogue switches and Rec. G.726 digital transmission representation)
 Transoceanic connection

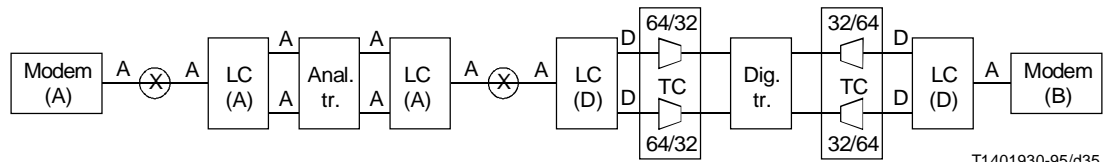

T1401930-95/d35

FIGURE II.16/V.56 bis

Connection type 15 representation 32 kbit/s ADPCM
 (1 analogue carrier transmission, 2 analogue switches and CCITT COM XVIII-102: 1984-1988 digital transmission representation)
 Transoceanic connection

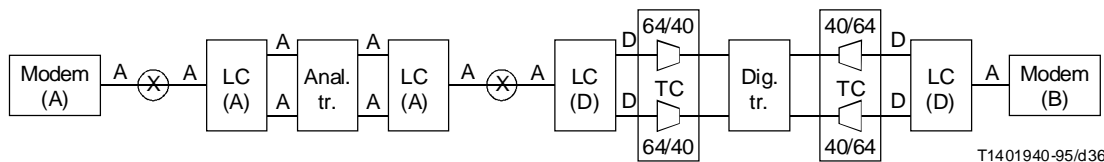

T1401940-95/d36

FIGURE II.17/V.56 bis

Connection type 16 representation 40 kbit/s ADPCM
 (1 analogue carrier transmission, 2 analogue switches and Rec. G.726 digital transmission representation)
 Transoceanic connection

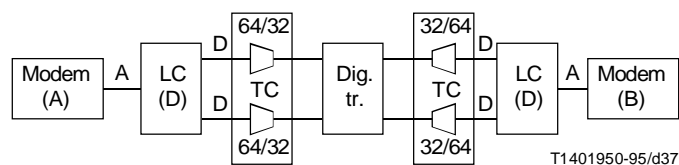

FIGURE II.18/V.56 bis

Connection type 17 representation 32 kbit/s ADPCM
(Rec. G.726 and 1 PCM link in tandem)

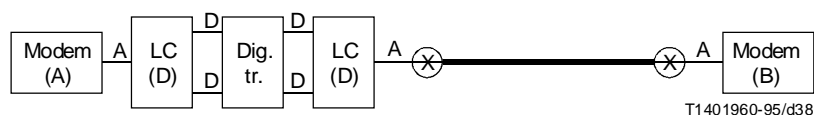

FIGURE II.19/V.56 bis

Connection type 18 representation
(2-wire analogue trunk, 2 analogue switches
and digital transmission representation with excessive loss)

Appendix III

Error rate vs. network model coverage

Depending on the application, testers may wish to evaluate a modem's performance over different ranges of error ratio. Therefore, Table III.1 specifies 4 different test durations for minimum block-error ratios from 1×10^{-2} down to 2×10^{-4} .

For each of these test durations, the minimum number of block errors that can be reported is ten. For bit-error rate testing, there must be a minimum of ten block errors before the bit-error rate can be reported.

At this minimum error ratio threshold, there is approximately a 95% confidence level that the true error rate is within a factor of 2 of the measured error ratio.

TABLE III.1/V.56 bis

Error rate test durations

Minimum block-error ratio to measure	Number of 1000-bit blocks to transmit
1×10^{-2}	1 000
2×10^{-3}	5 000
1×10^{-3}	10 000
2×10^{-4}	50 000

III.1 Bit- and block-error rate vs. network model coverage

III.1.1 Overview

The purpose of the bit- and block-error ratio tests is to measure the modem's synchronous signal converter performance over a variety of telephone network conditions. The output from these tests is an estimate of the NMC over a defined range of bit- or block-error ratios for a particular data signalling rate. The NMC obtained will vary with both error ratio and data signalling rate.

These tests are useful for the evaluation of modems for synchronous applications. Block-error rate is an appropriate measure of modem performance in applications where the DTE implements a link layer error control protocol. Other applications exist, such as real-time video transmission, for which bit-error ratio may be a better indicator of modem performance.

See 4.7 and Tables 3 through 6 to select the particular set of tests to perform. Based on the application requirements, choose the number of blocks to be transmitted for the duration of the testing with the selected set of tests. The recommended choices are listed in Table III.1 above.

It is recommended that Table 4 (100 tests, 99% of the network model) be used for most testing, and that ten thousand (10 000) blocks be transmitted for each test.

III.1.2 DTE configuration

Both DTEs shall be configured as follows:

- synchronous data format;
- DTE rate: maximum rate supported by the modem (changed during testing);
- transmit clock supplied by modem.

III.1.3 Modem configuration

Configure the modems as follows:

- synchronous data mode;
- modem-to-modem line rate: fixed to the desired line rate (changed during testing);
- compression disabled;
- select internal modem clock;
- modem-to-modem adaptive rate changes, retrain: disabled.

III.1.4 Network simulator configuration

Set the network simulator to the first impairment combination and test loop combination for the test.

During the course of testing, the network simulator parameters will be changed.

III.1.5 Test procedure

- a) Establish a connection with modem A originating the call.
- b) Begin continuous transmission of the 511 test pattern at DTE A.
- c) Wait for indications of data pattern synchronization at DTE B. When DTE B is in synchronization with the received test pattern, begin analysis of the test pattern for errors.
- d) After the chosen number of blocks of 1000 bits each have been analysed at DTE B, record the BER or BLER (depending on the test being performed) at DTE B.
- e) Clear the connection.
- f) Repeat steps a) through e) for each of the impairment combinations to be tested.
- g) Repeat steps a) through f) for each modem transmission rate for which results are desired.

III.1.6 Results

Results of each test are to be presented in terms of error ratios for each impairment combination and line rate tested.

This test yields the number of measurements specified in the selected table (Tables 3 to 6) used for the test.

There are at most 168 measurements for each modem line rate.

Appendix IV

Supplemental round trip delay model

The purpose of this appendix is to provide a basis for evaluating the effects of low RTDs on modem performance.

The RTDs specified in row 10a of Table 1a are typical values. They do not provide a basis for evaluating the effects of RTD on modem performance. The RTDs specified in Table 1b are for intercontinental network connections and provide a basis for evaluating the effects of the maximum RTDs on modem performance.

Most low delay connections are local connections. Since local connections usually consist of only one PCM link, the following 34 test channels are suggested for testing the performance of modems on low-delay connections.

The channels are all combinations of impairment combination 1c with RTD of 4 to 20 ms in 1 ms steps and test loop combinations 1 and 5.