



INTERNATIONAL TELECOMMUNICATION UNION

CCITT

Z.100 Annex C2

THE INTERNATIONAL
TELEGRAPH AND TELEPHONE
CONSULTATIVE COMMITTEE

(11/1988)

SERIES Z: LANGUAGES AND GENERAL SOFTWARE
ASPECTS FOR TELECOMMUNICATION SYSTEMS

Functional specification and description language (SDL)
Criteria for using formal description techniques (FDTs)

SDL PR SYNTAX SUMMARY

Reedition of CCITT Recommendation Z.100 Annex C2
published in the Blue Book, Fascicle X.1 (1988)

NOTES

- 1 CCITT Recommendation Z.100 Annex C2 was published in Fascicle X.1 of the *Blue Book*. This file is an extract from the *Blue Book*. While the presentation and layout of the text might be slightly different from the *Blue Book* version, the contents of the file are identical to the *Blue Book* version and copyright conditions remain unchanged (see below).
- 2 In this Recommendation, the expression “Administration” is used for conciseness to indicate both a telecommunication administration and a recognized operating agency.

ANNEX C2
(to Recommendation Z.100)

SDL PR syntax summary

1 *system*

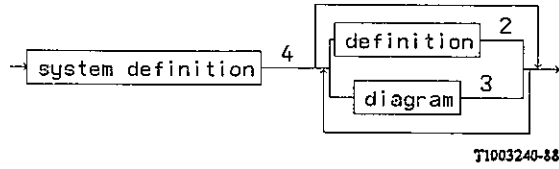

2 *definition*

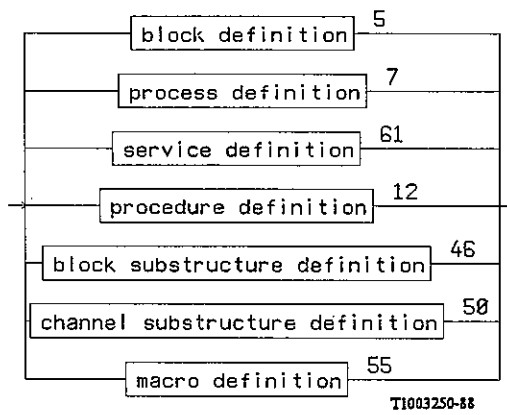

3 *diagram*

Diagram is defined in GR syntax summary.

4 *system definition* (Basic SDL 2.4.1)

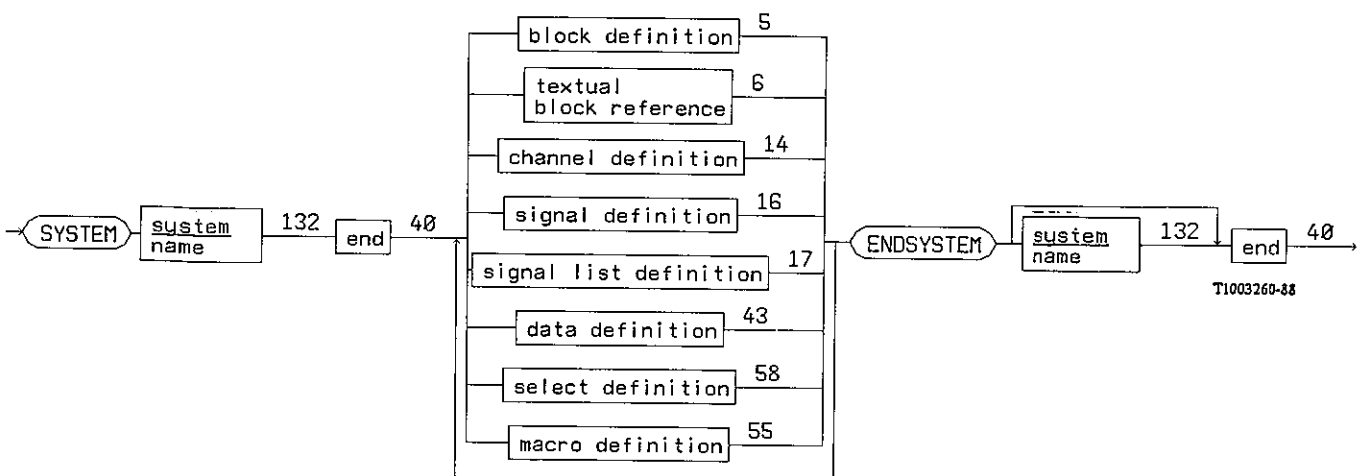

5 *block definition* (Basic SDL 2.4.2)

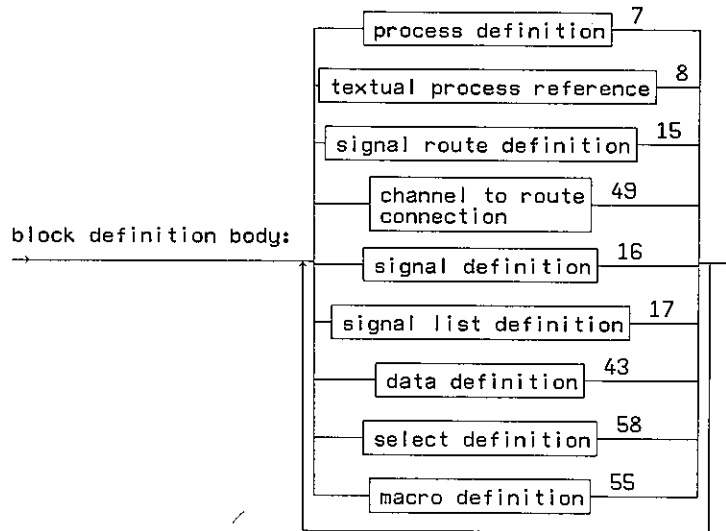
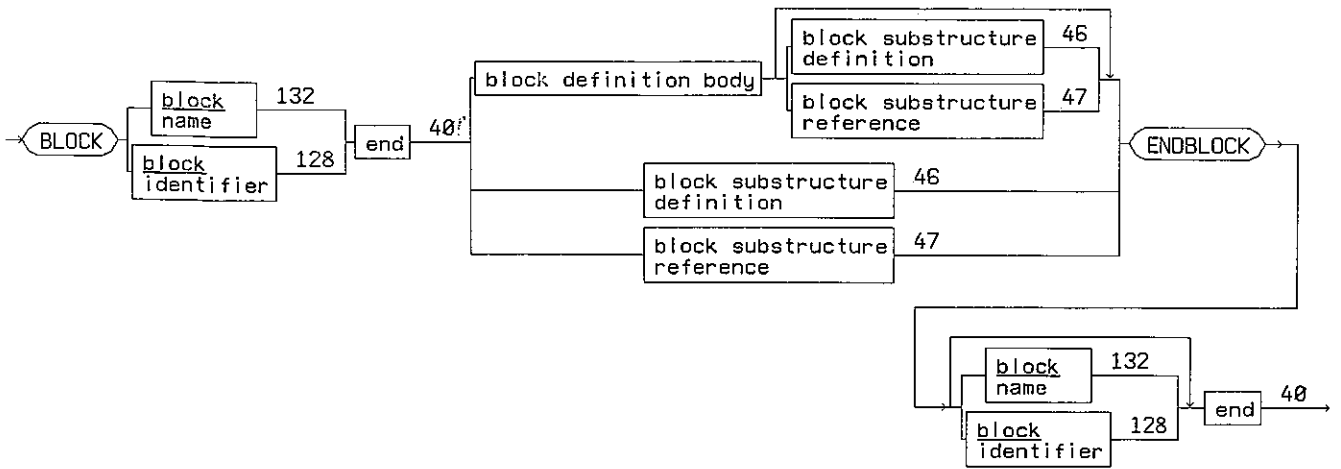

(Basic SDL 2.4.2)

T1003270-88

6 *textual block reference* (Basic SDL 2.4.2)

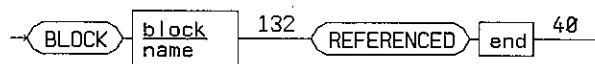

T1003280-88

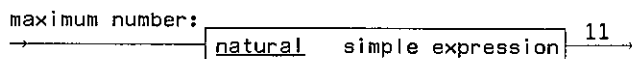
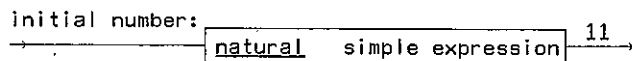
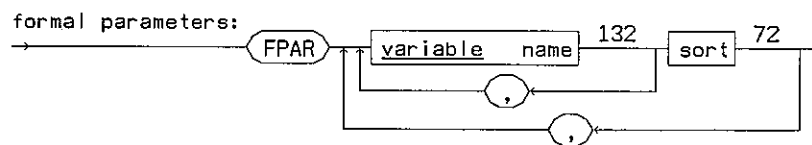
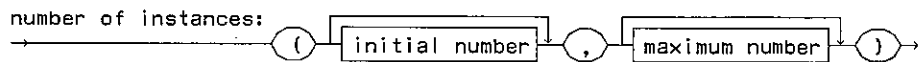
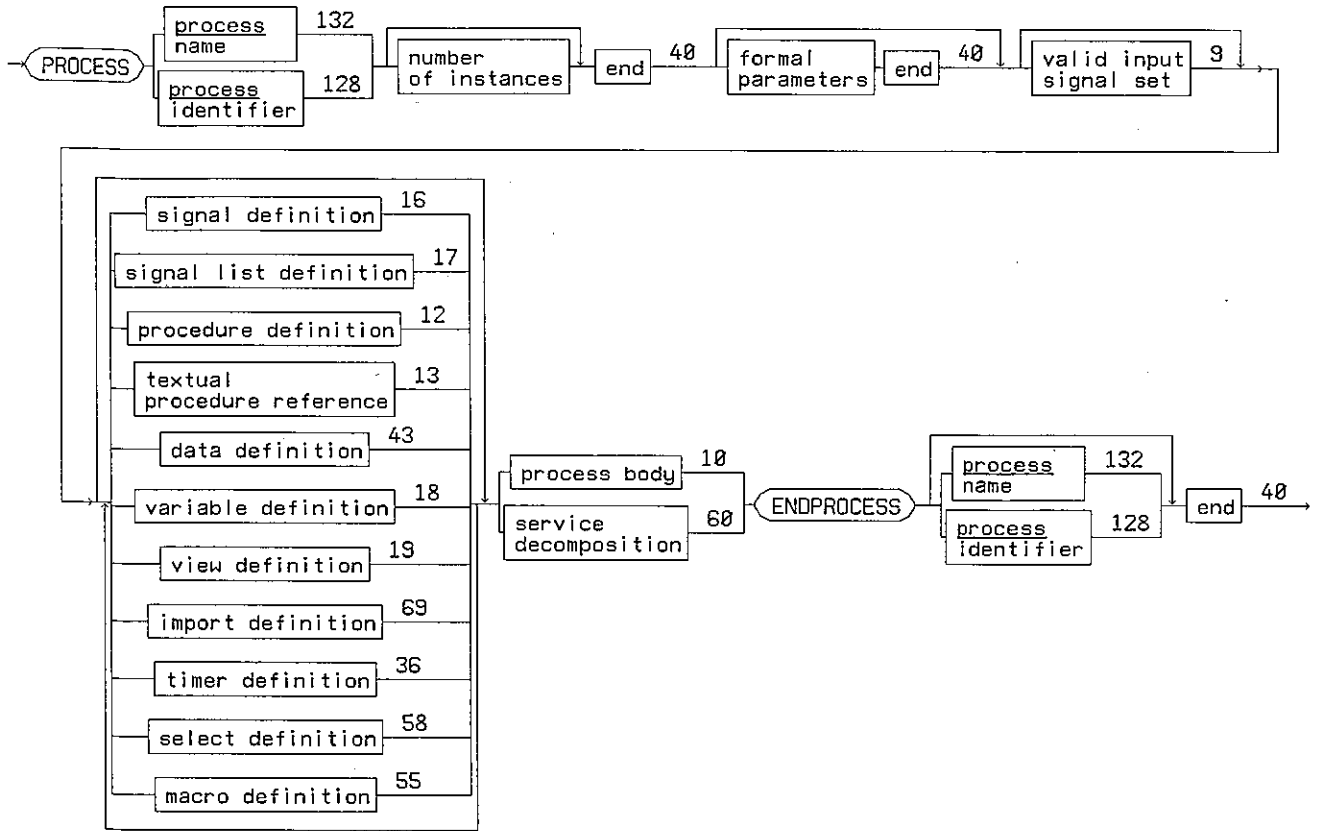

T1003290-88

8 *textual process reference* (Basic SDL 2.4.3)

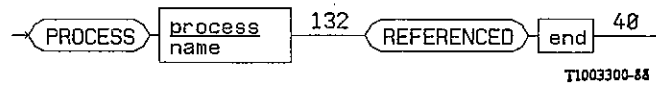

9 *valid input signal set*

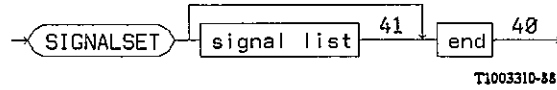

10 *process body* (Basic SDL 2.4.3)

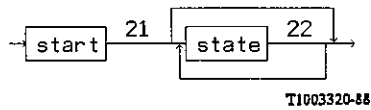

11 *simple expression*

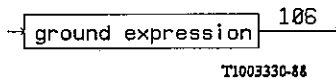

12 *procedure definition* (Basic SDL 2.3.4)

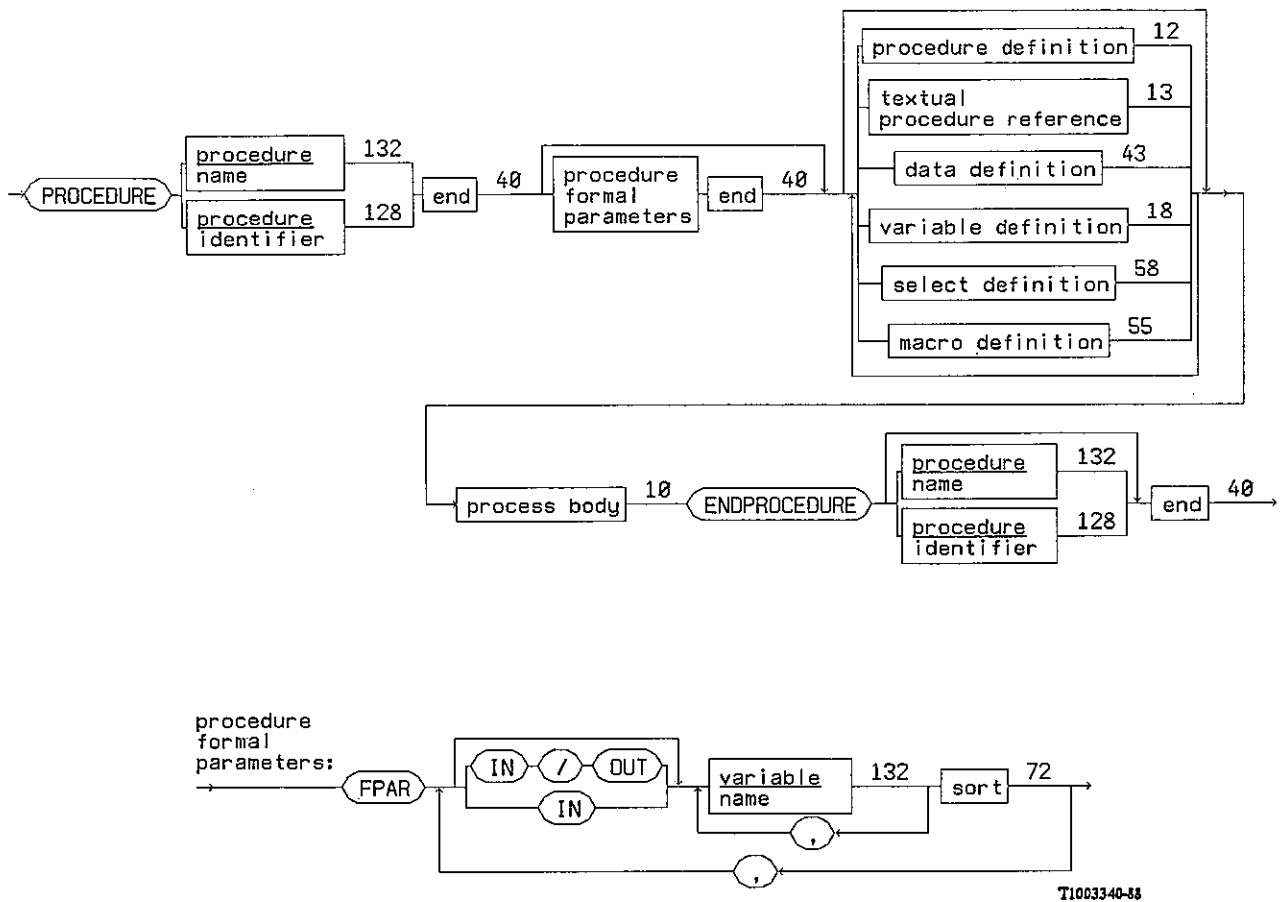

13 *textual procedure reference* (Basic SDL 2.3.4)

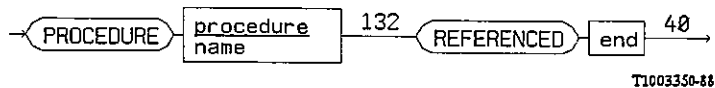

14 *channel definition* (Basic SDL 2.5.1)

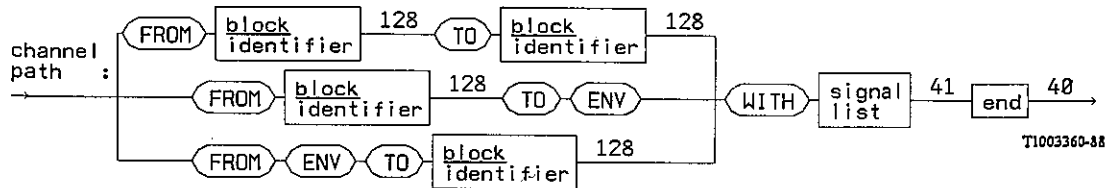
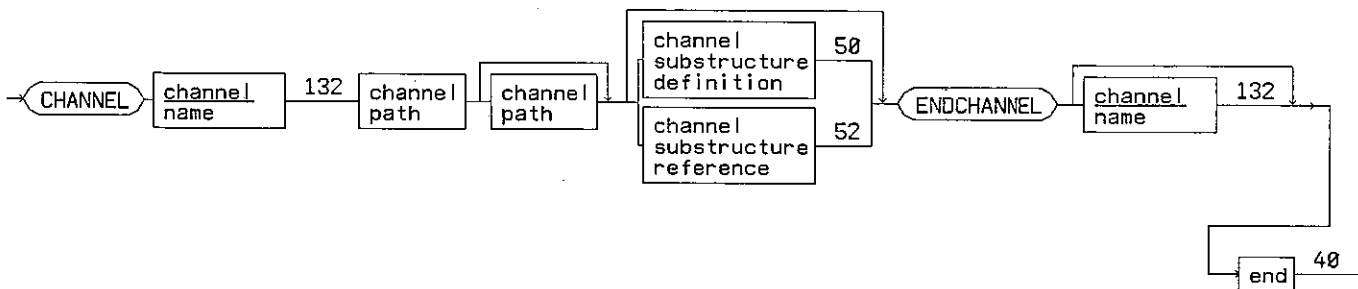

15 *signal route definition* (Basic SDL 2.5.2)

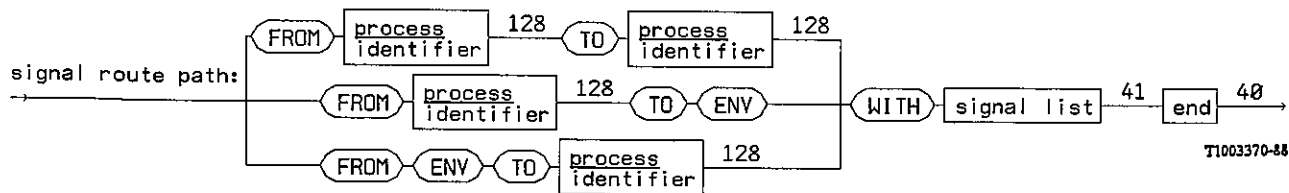
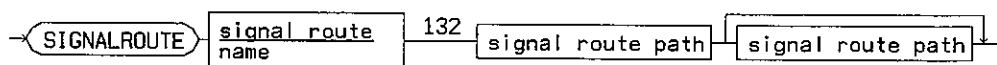

16 *signal definition* (Basic SDL 2.5.4)

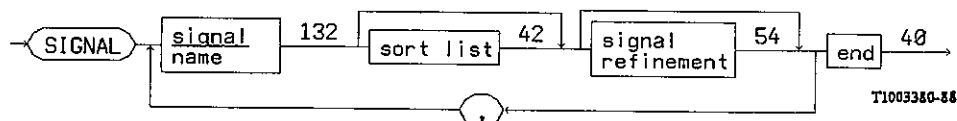

17 *signal list definition* (Basic SDL 2.5.5)

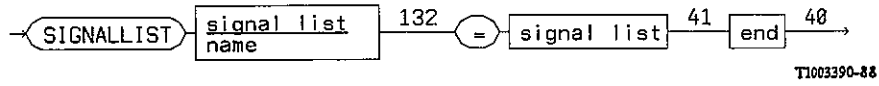

18 *variable definition* (Basic SDL 2.6.1.1)

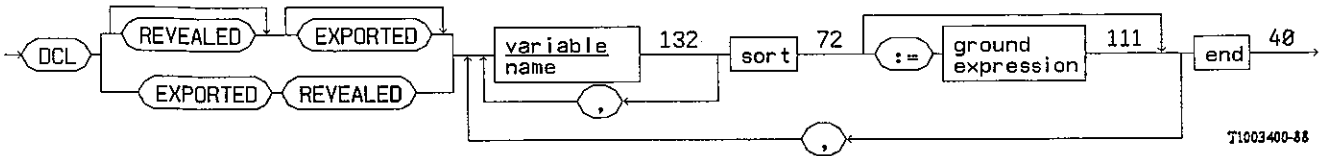

19 *view definition* (Basic SDL 2.6.1.2)

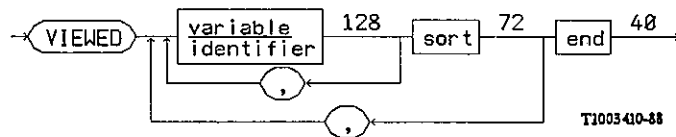

20 *view expression* (Data 5.5.4.4)

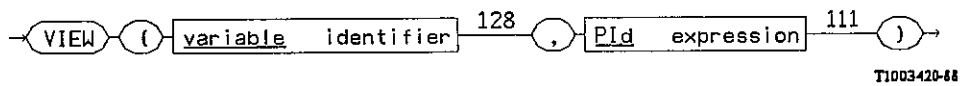

21 *start* (Basic SDL 2.6.2)

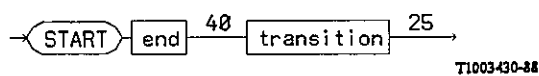

22 *state* (Basic SDL 2.6.3)

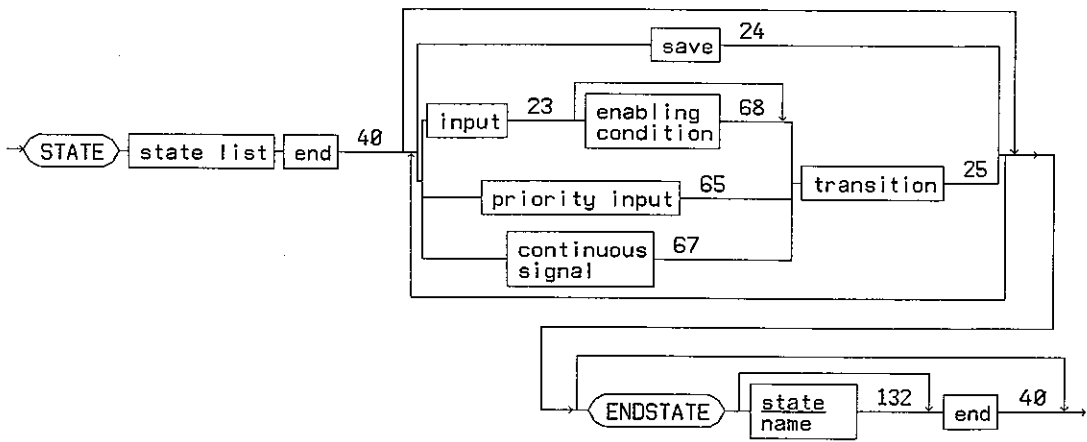

(Additional concepts 4.4)

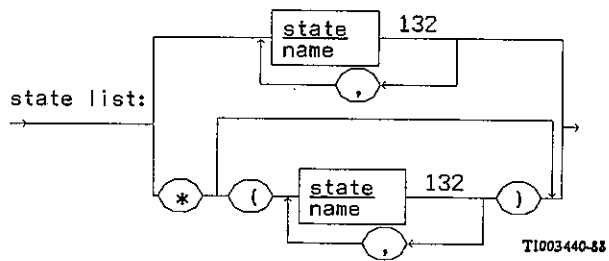

23 *input* (Basic SDL 2.6.4)

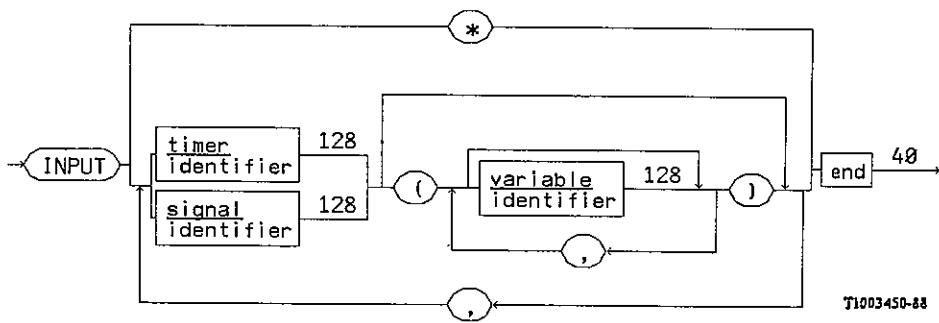

24 *save* (Basic SDL 2.6.5)

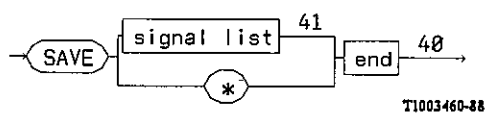

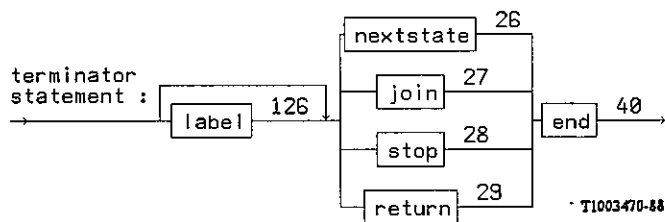
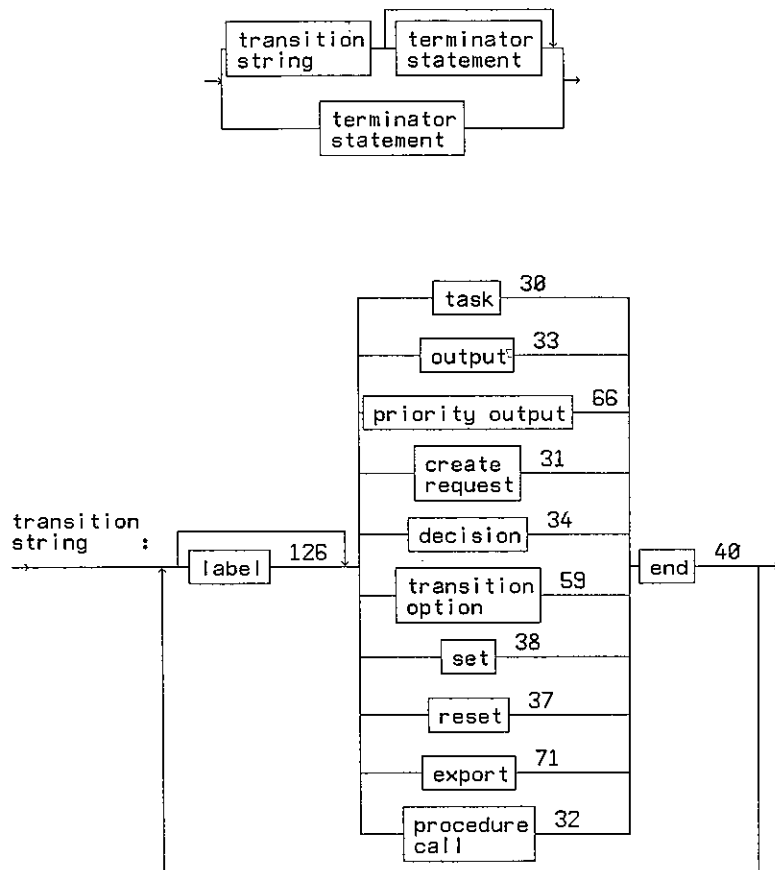

26 *nextstate* (Basic SDL 2.6.7.2.1)

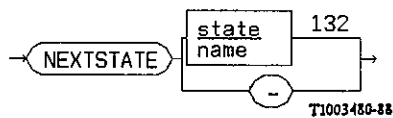

27 *join* (Basic SDL 2.6.7.2.2)

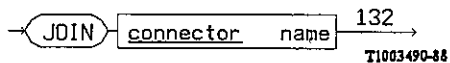

28 *stop* (Basic SDL 2.6.7.2.3)

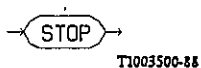

29 *return* (Basic SDL 2.6.7.2.4)



30 *task* (Basic SDL 2.7.1)

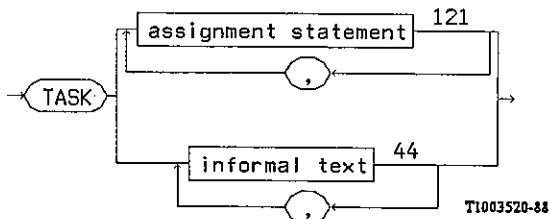

31 *create request* (Basic SDL 2.7.2)

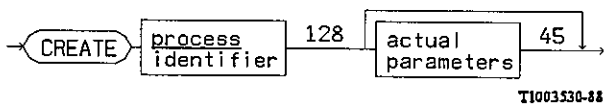

32 *procedure call* (Basic SDL 2.7.3)

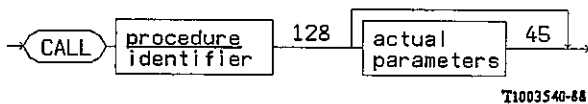

33 *output* (Basic SDL 2.7.4)

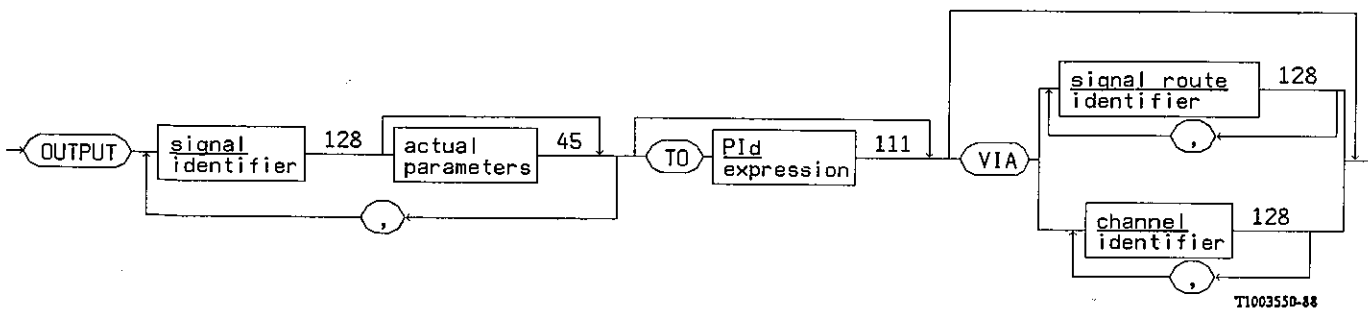

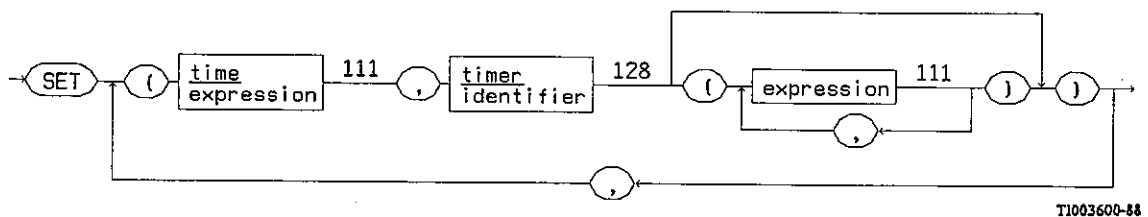
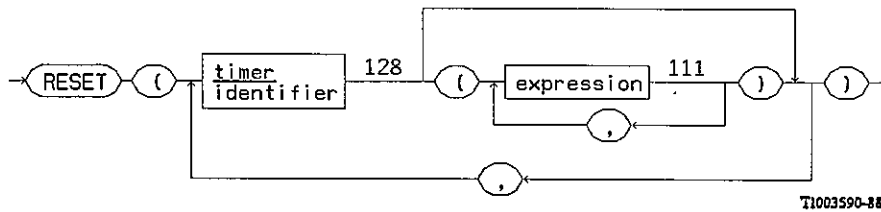
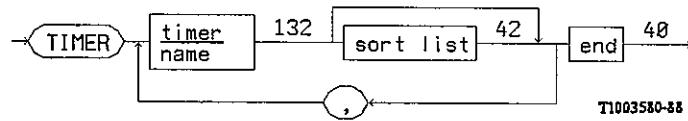
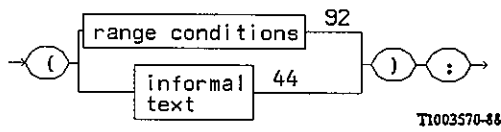
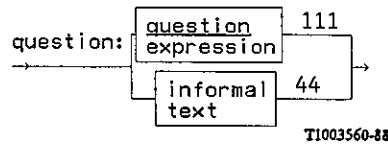
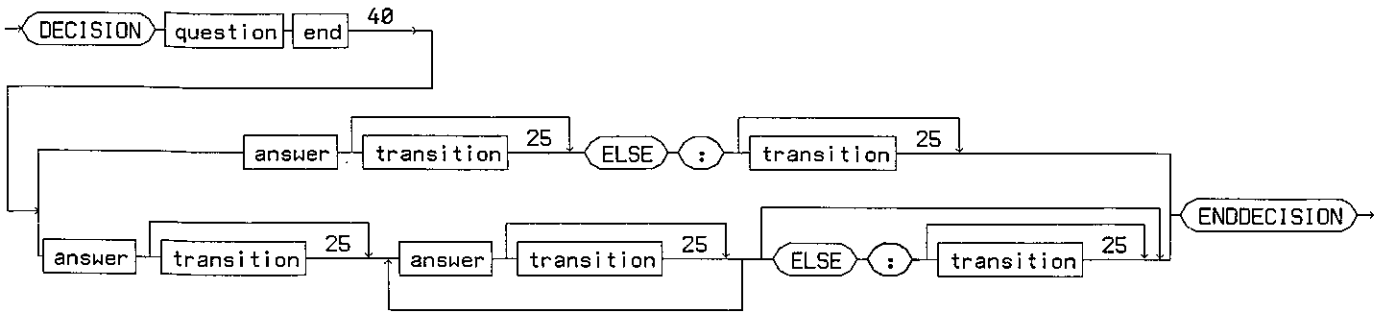

(Data 5.5.4.5)

39 *timer active expression* (Data 5.5.4.5)

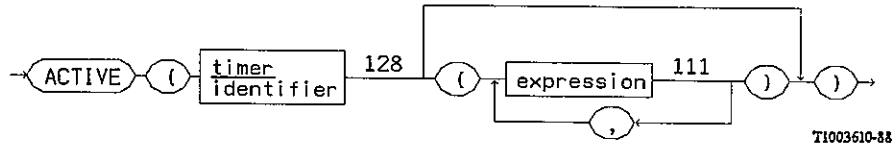

40 *end*

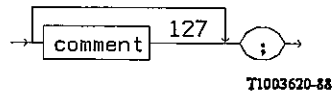

41 *signal list*

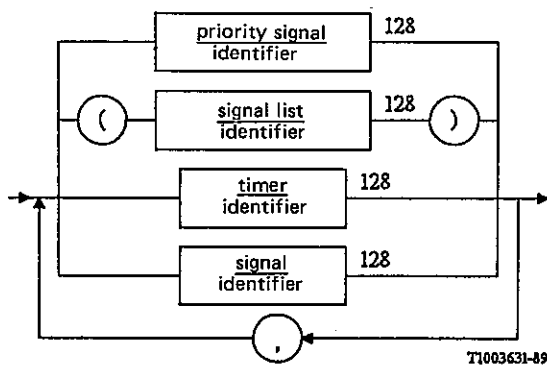

42 *sort list*

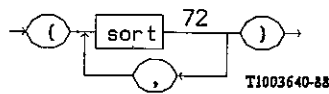

43 *data definition*

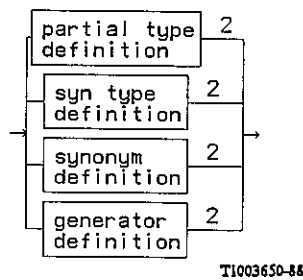

44 *informal text*

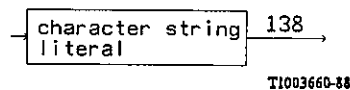

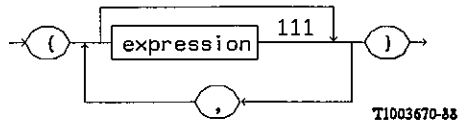

46 block substructure definition (Structural concepts 3.2.2)

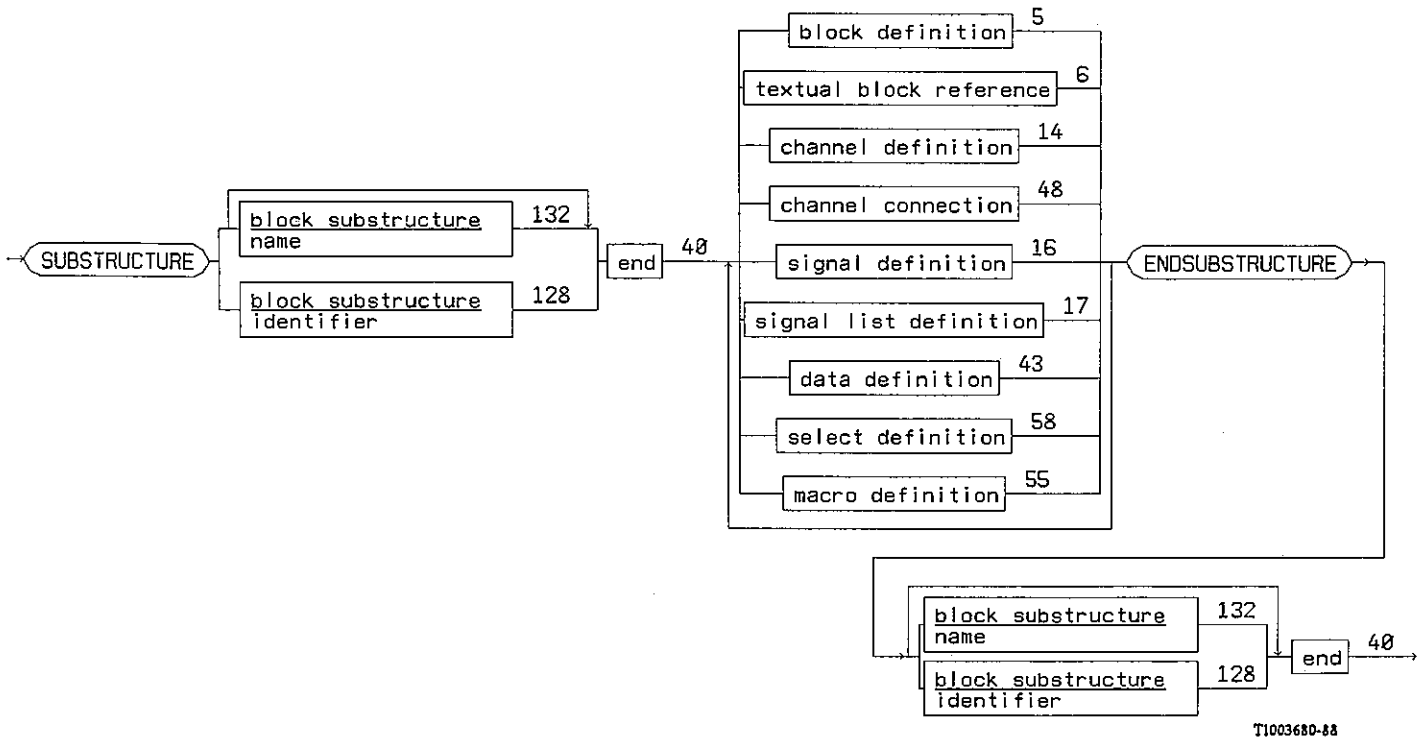

47 block substructure reference (Structural concepts 3.2.2)

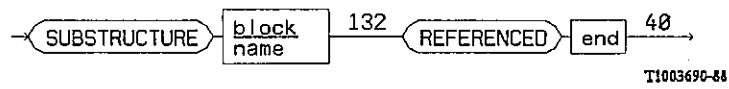

48 channel connection (Structural concepts 3.2.2)

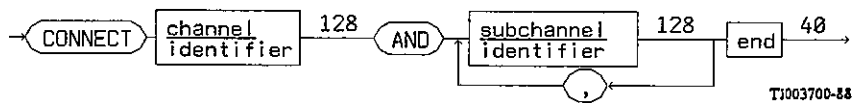

49 *channel to route connection* (Structural concepts 3.2.2)

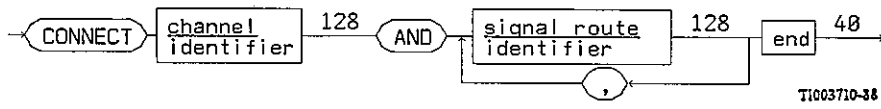

50 *channel substructure definition* (Structural concepts 3.2.3)

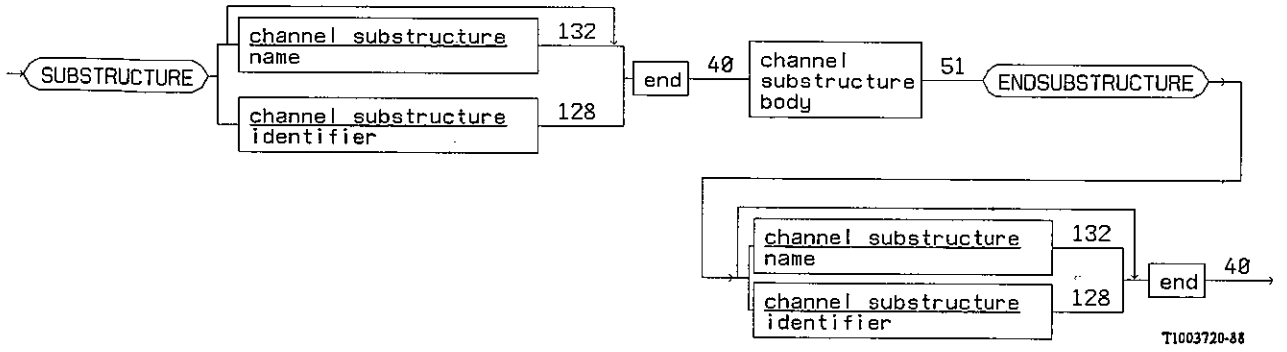

51 *channel substructure body* (Structural concepts 3.2.3)

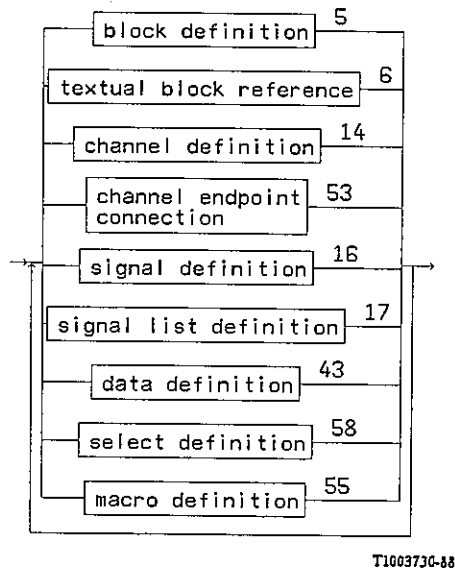

52 *channel substructure reference* (Basic SDL 2.5.1)

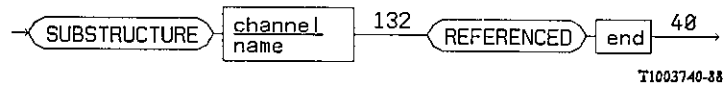

53 *channel endpoint connection* (Structural concepts 3.2.3)

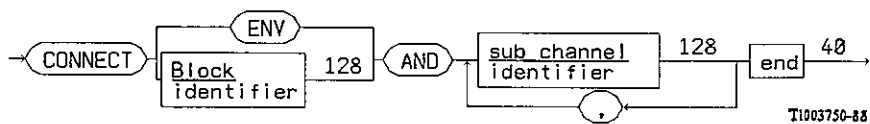

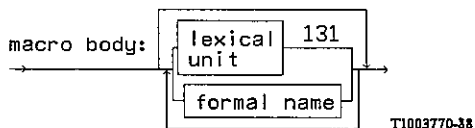
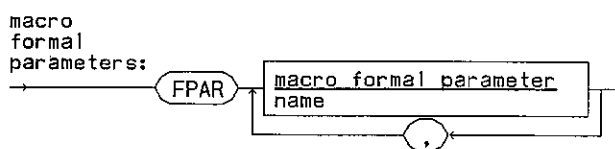
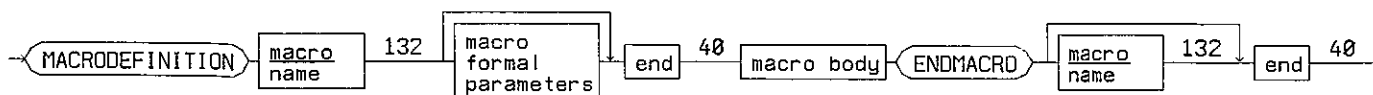
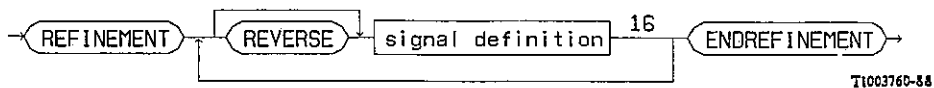

(Additional concepts 4.2.3)

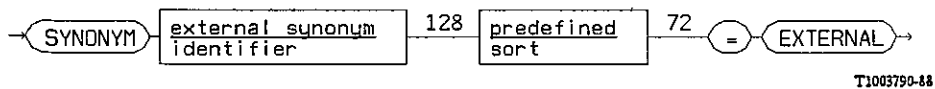
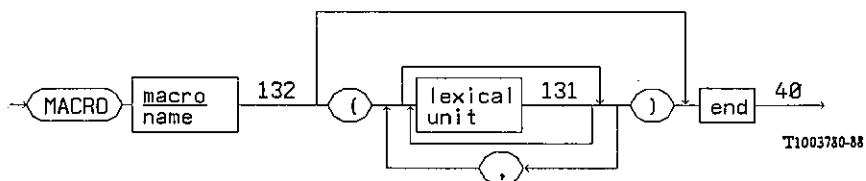

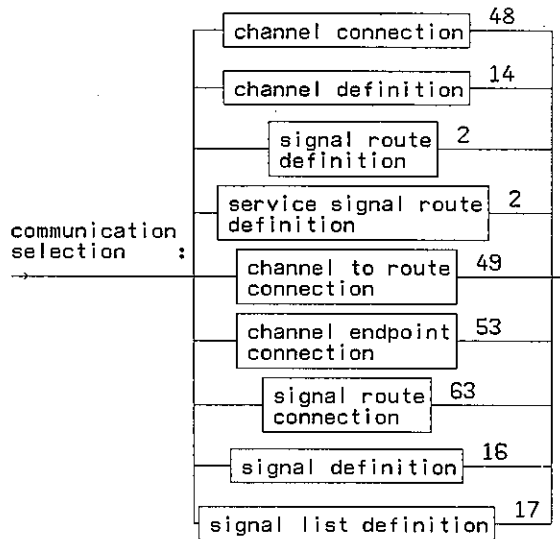
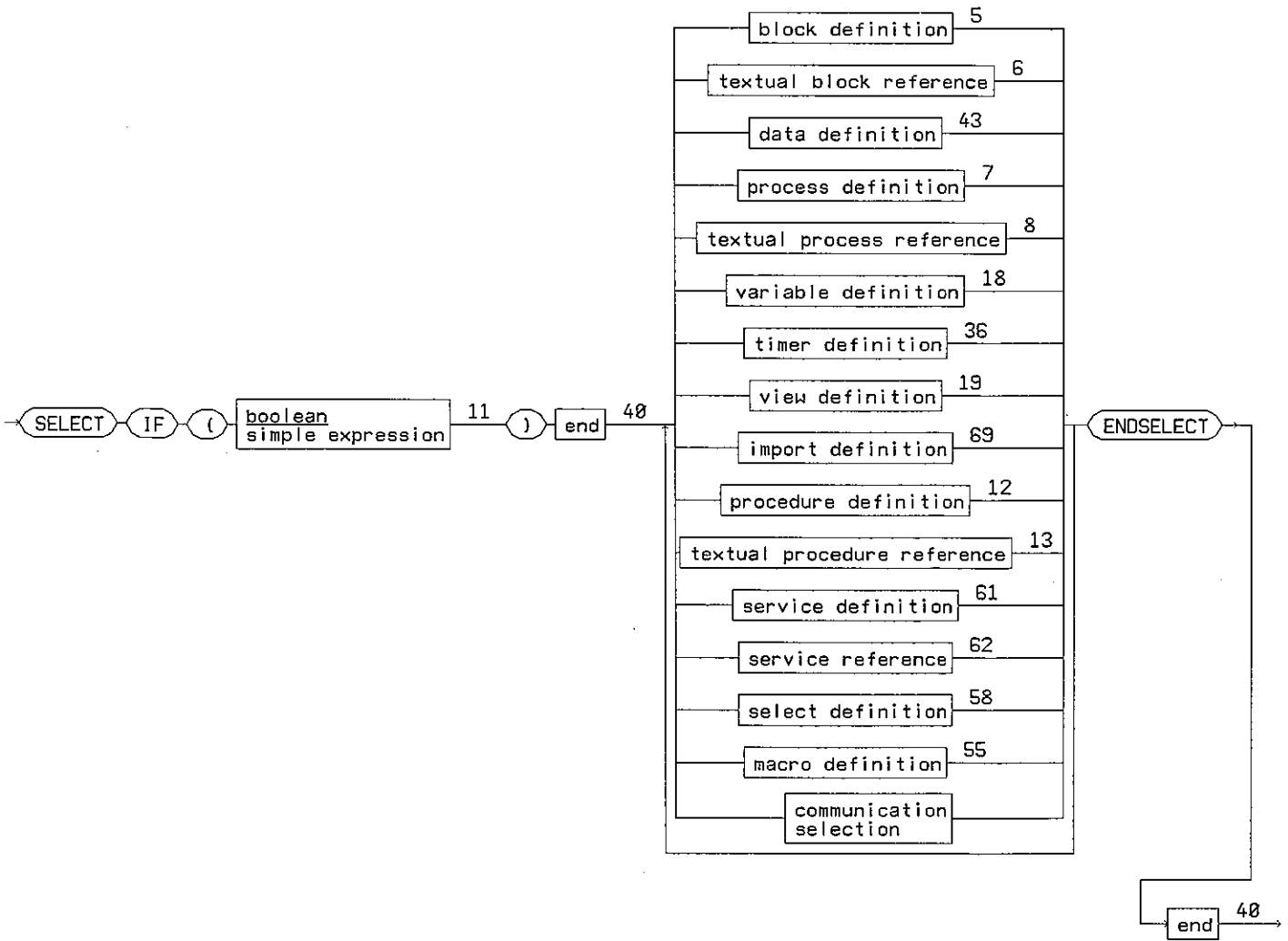

T1003800-58

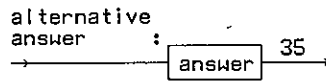
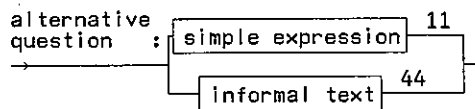
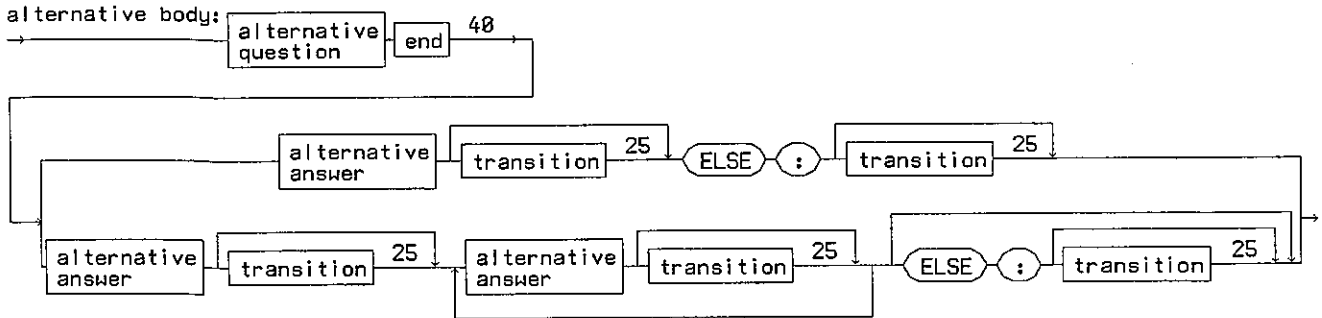
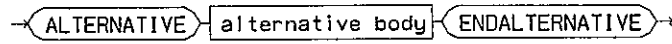

T1003810-88

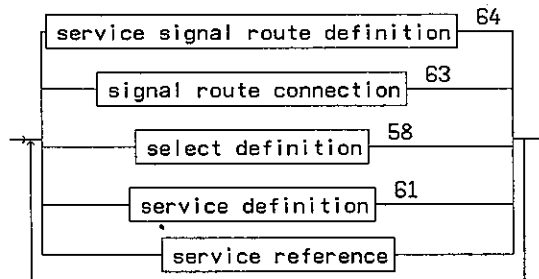

T1003820-88

61 *service definition* (Additional concepts 4.10.2)

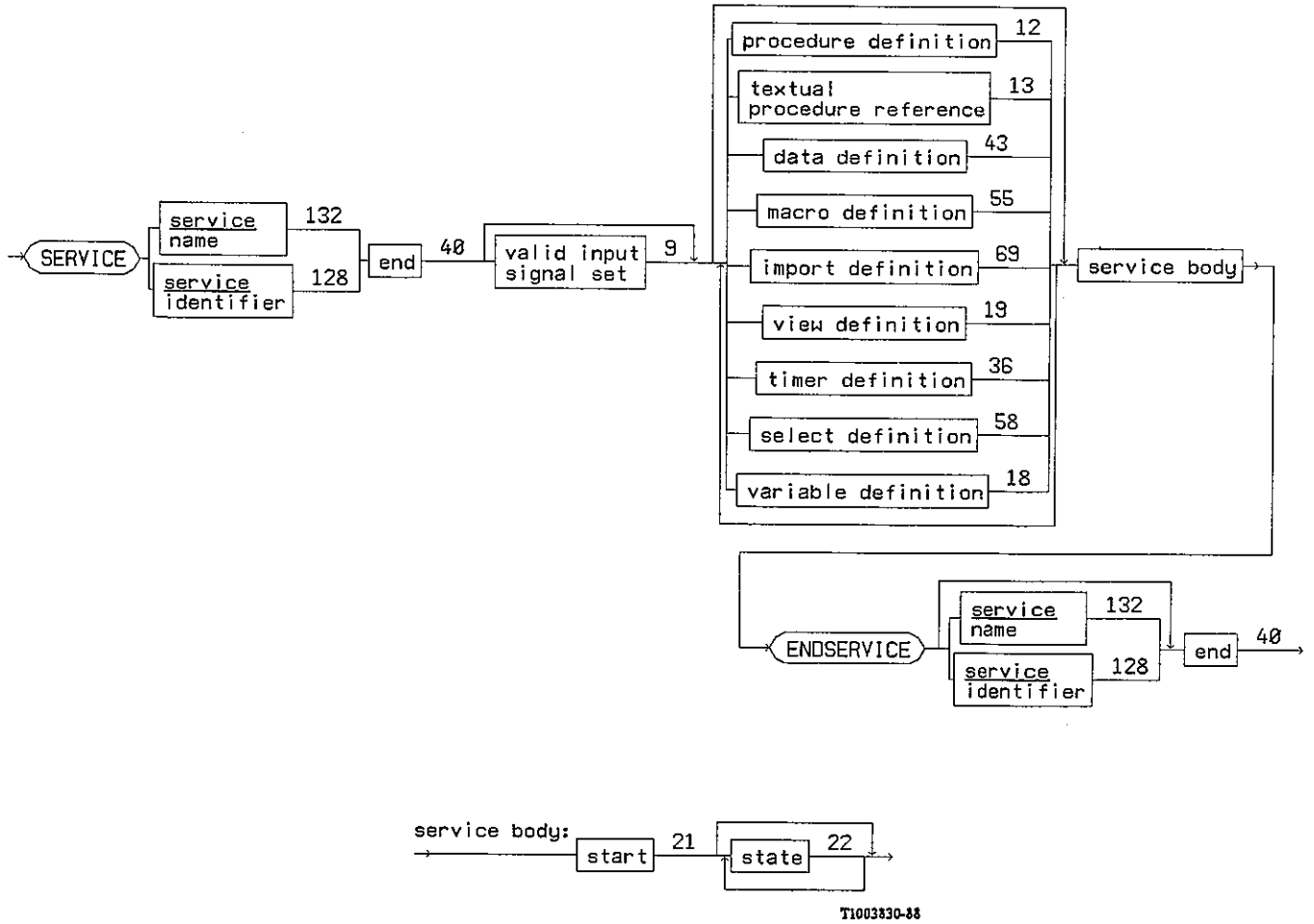

62 *service reference* (Additional concepts 4.10.1)

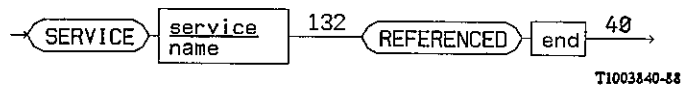

63 *signal route connection* (Additional concepts 4.10.1)

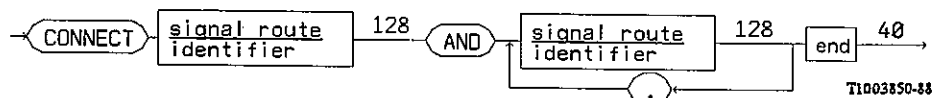

64 *service signal definition* (Additional concepts 4.10.1)

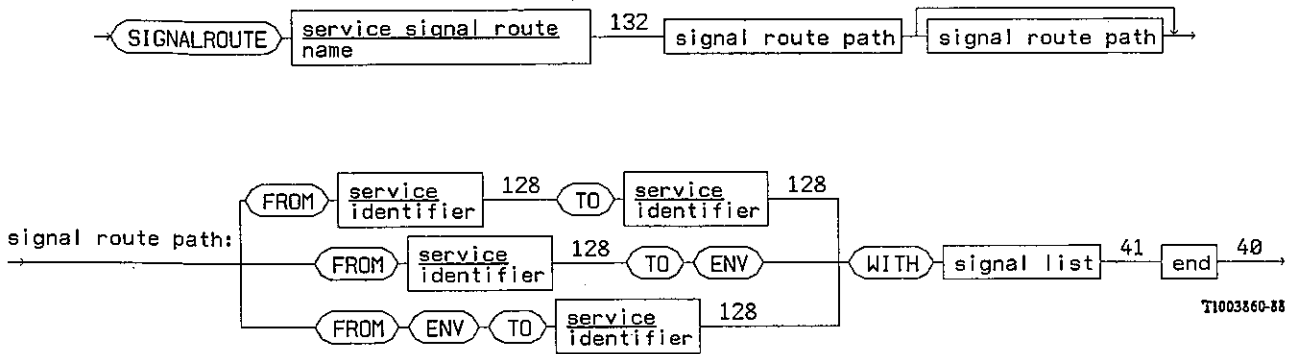

65 *priority input* (Additional concepts 4.10.2)

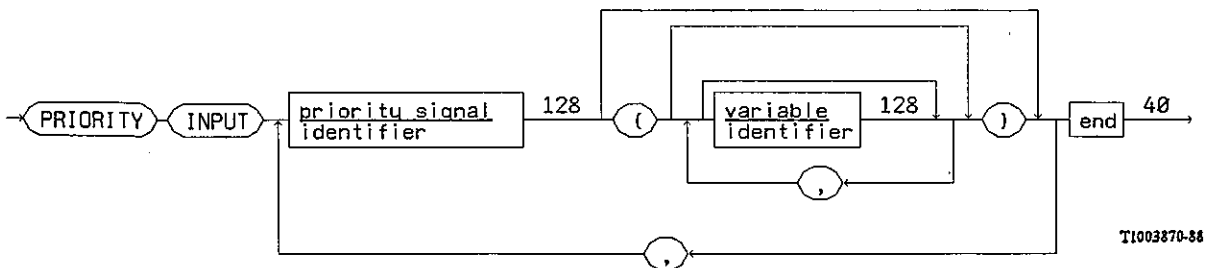

66 *priority output* (Additional concepts 4.10.2)

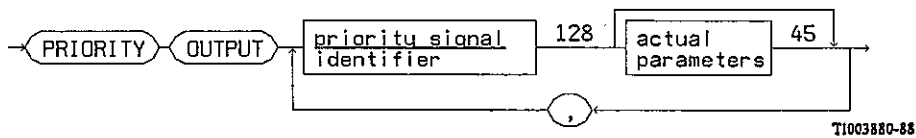

67 *continuous signal* (Additional concepts 4.11)



68 *enabling condition* (Additional concepts 4.12)

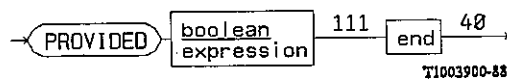

69 *import definition* (Additional concepts 4.13)

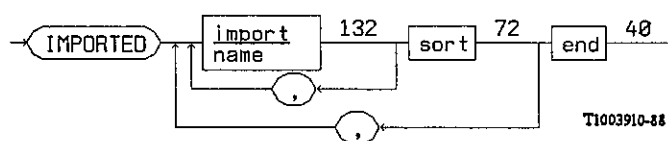

70 *import expression* (Additional concepts 4.13)

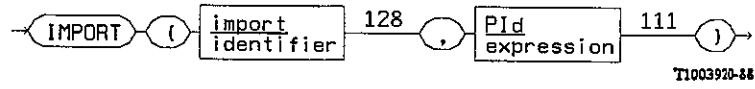

71 *export* (Additional concepts 4.13)

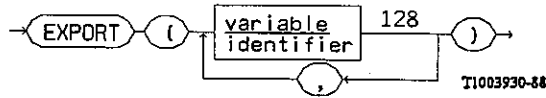

72 *sort* (Data 5.2.2)

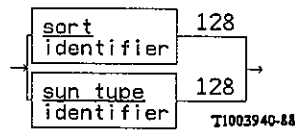

73 *partial type definition* (Data 5.2.1)

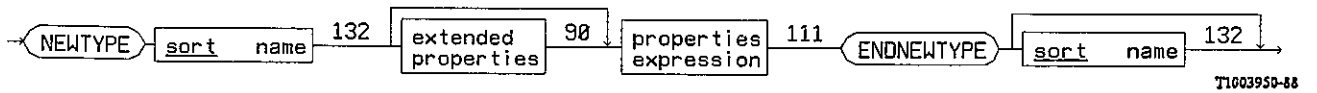

74 *properties expression* (Data 5.2.1 and 5.5.3.3)

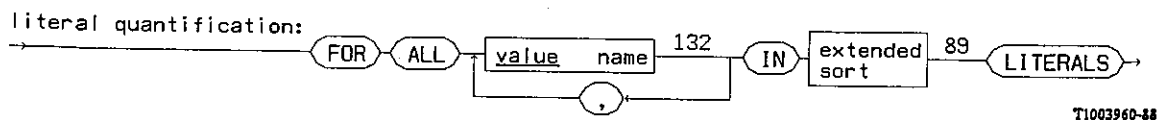
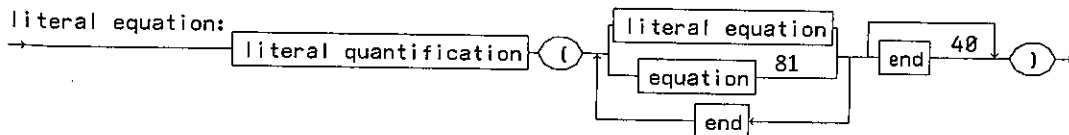
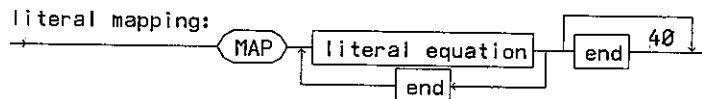
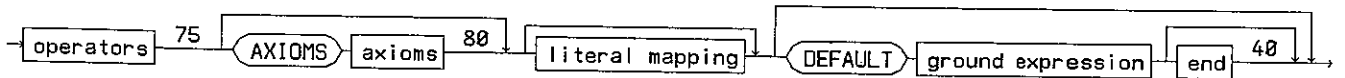

75 *operators* (Data 5.2.2 and 5.4.1.8)

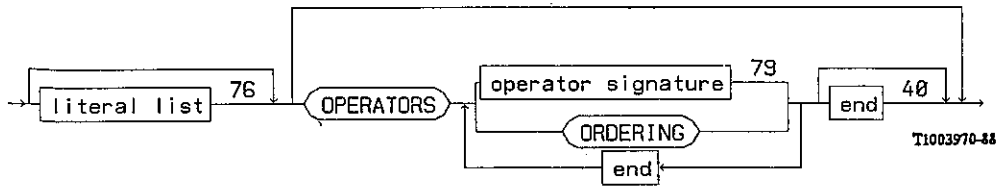

76 *literal list* (Data 5.2.2)

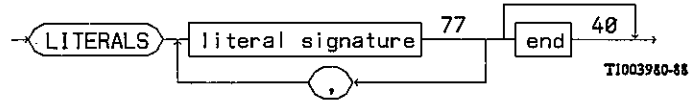

77 *literal signature* (Data 5.2.2 & 5.4.1.8)

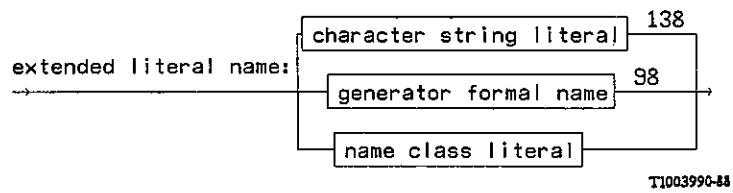
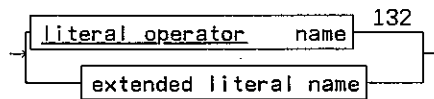

78 *character string literal identifier*

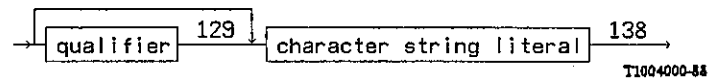

79 *operator signature* (Data 5.2.2)

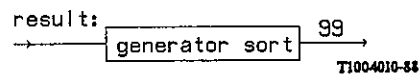
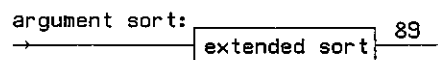
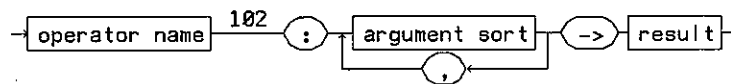

80 *axioms* (Data 5.2.3 and 5.2.4)

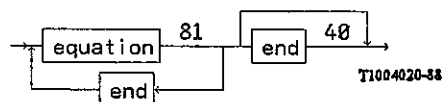

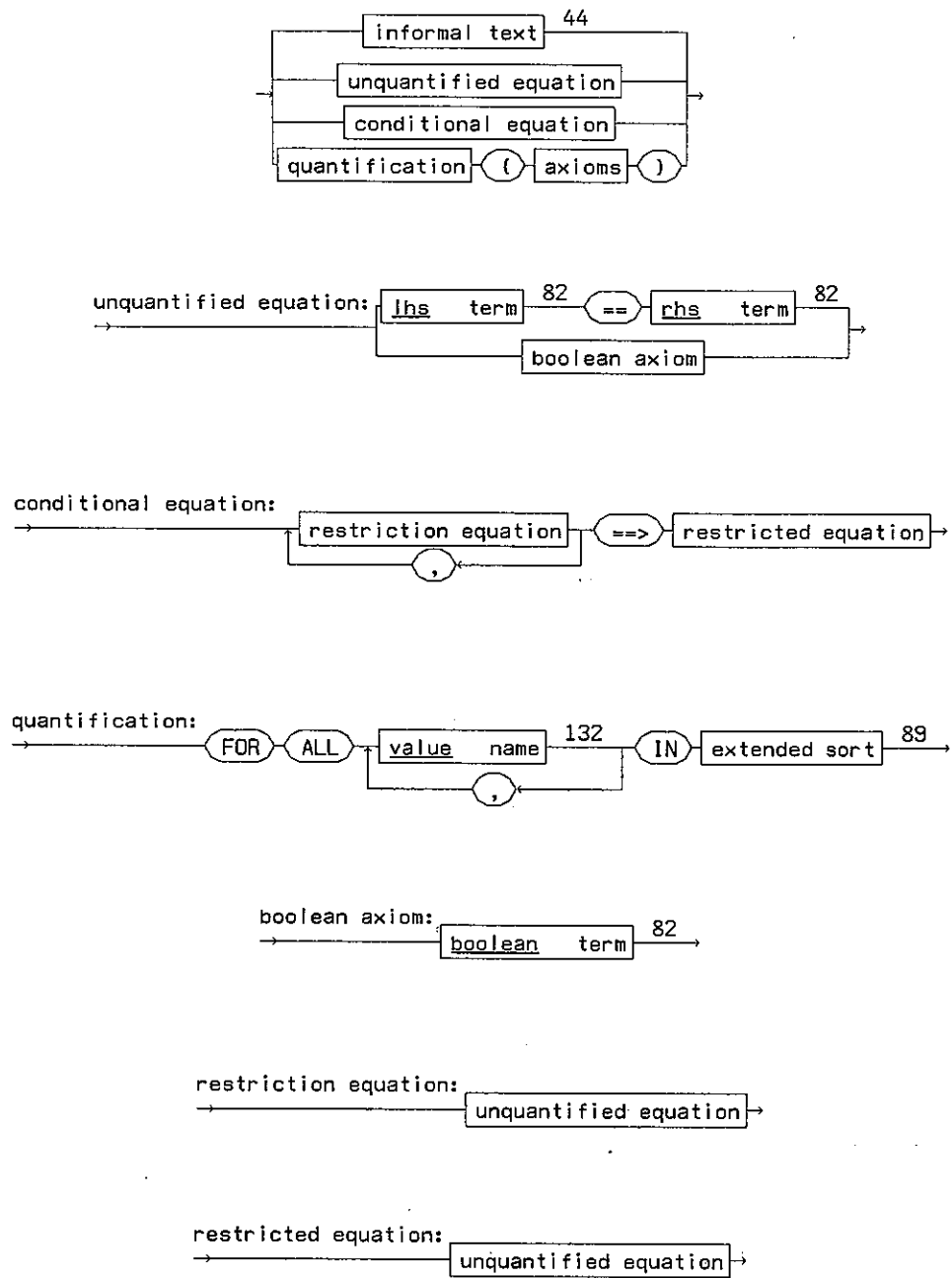

T1004030-88

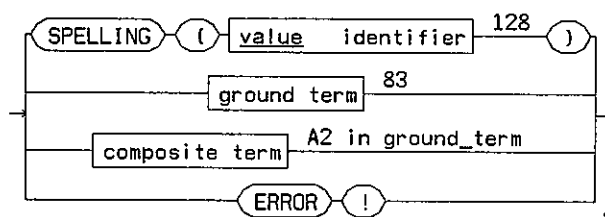

T1004040-88

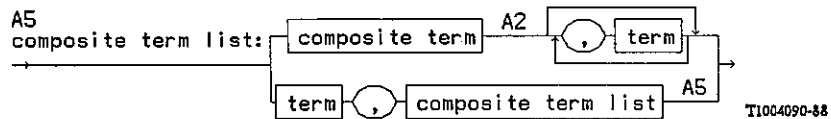
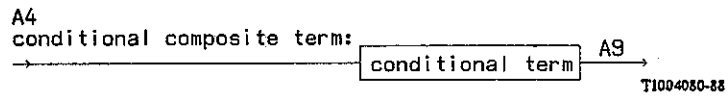
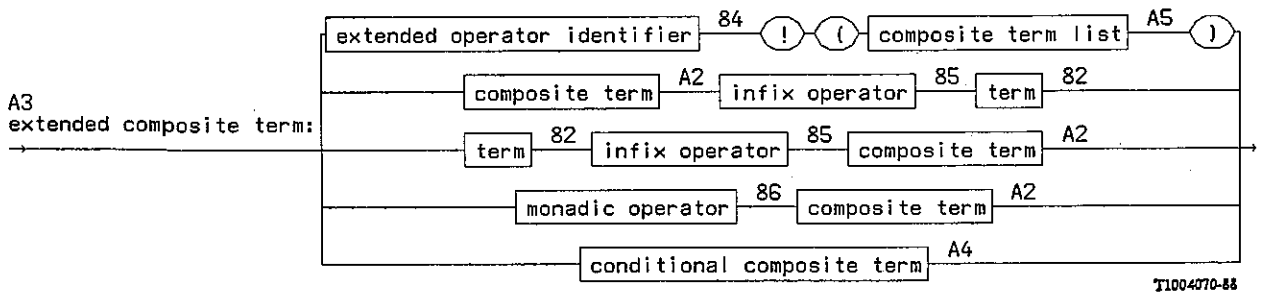
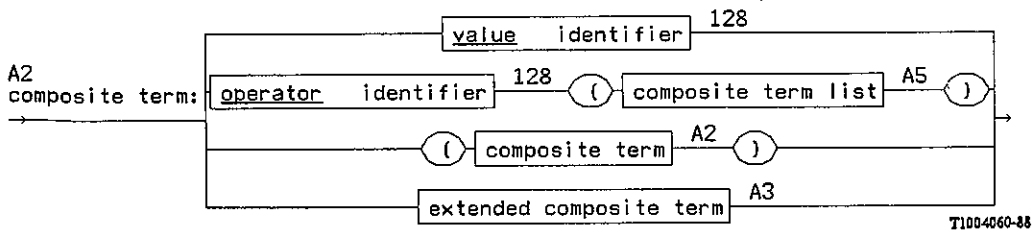
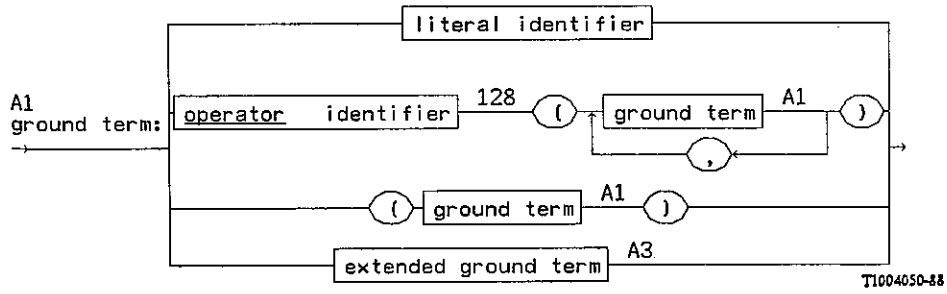

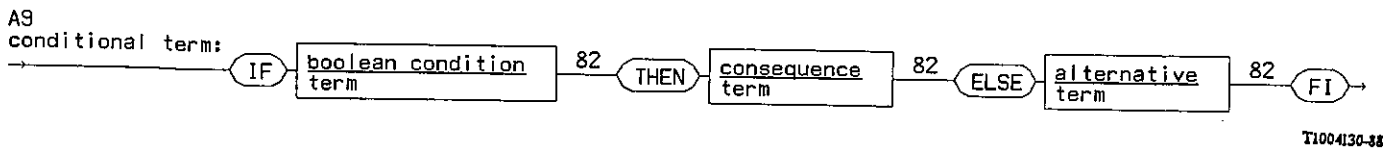
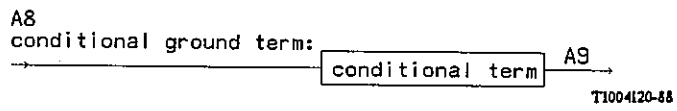
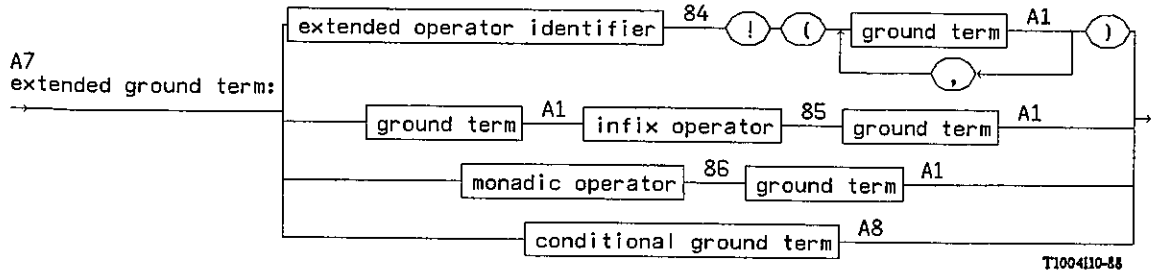
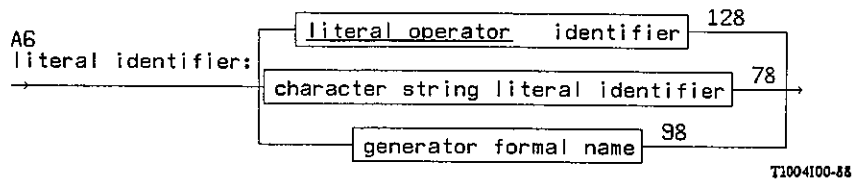

84 *extended operator identifier*

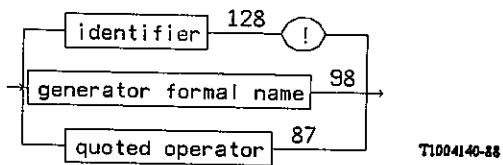

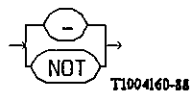
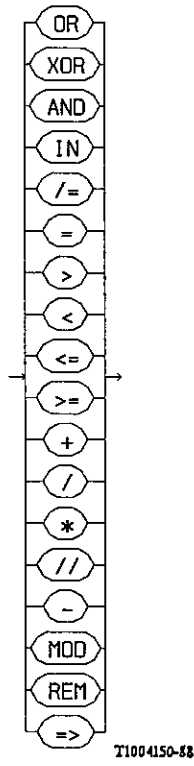

87 *quoted operator*

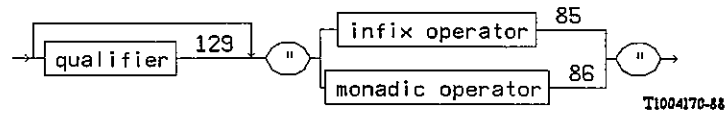

88 *extended operator name* (Data 5.4.1)

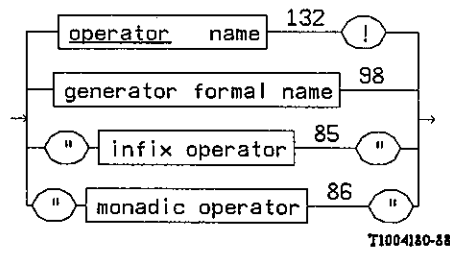

89 *extended sort* (Data 5.4.1.9)

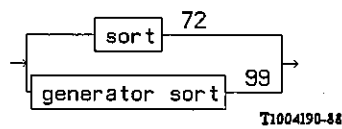

90 *extended properties* (Data 5.4.1)

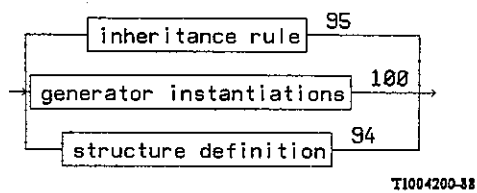

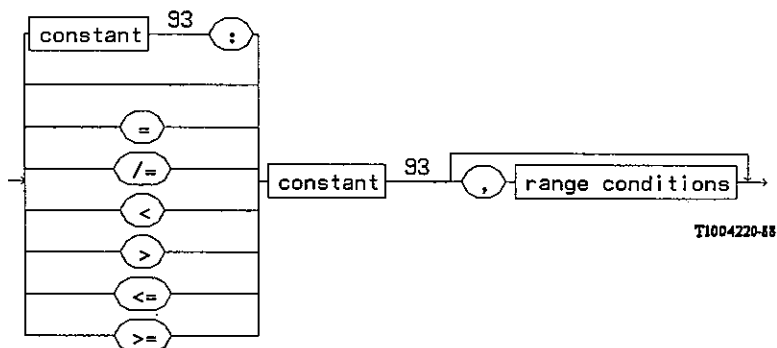
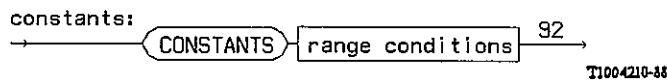
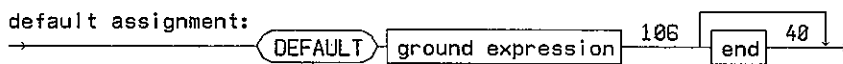
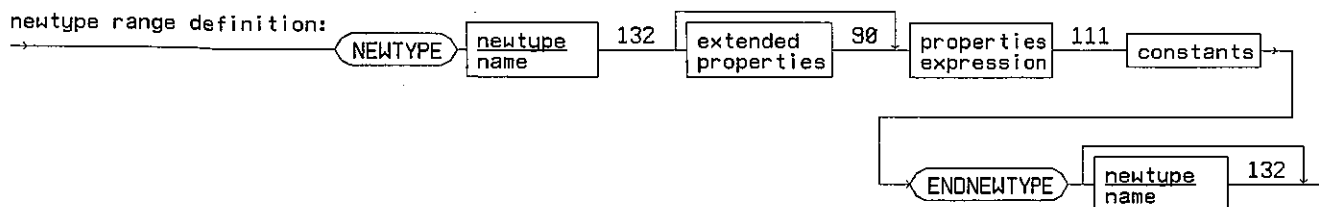
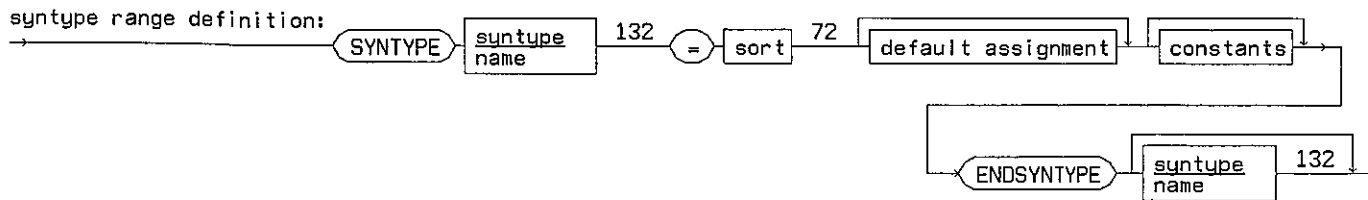
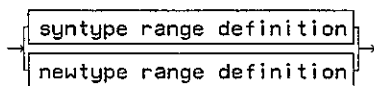

93 *constant* (Data 5.4.1.9)

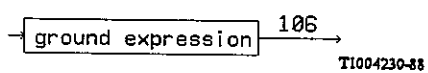

94 *structure definition* (Data 5.4.1.10)

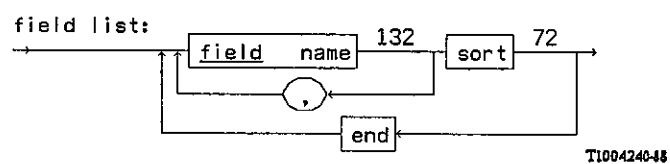
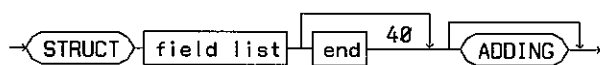

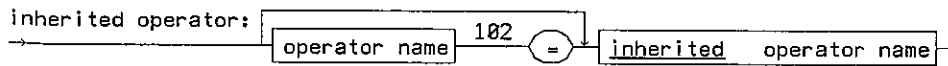
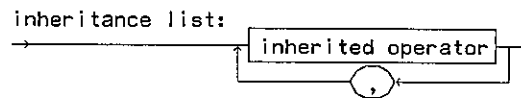
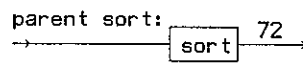
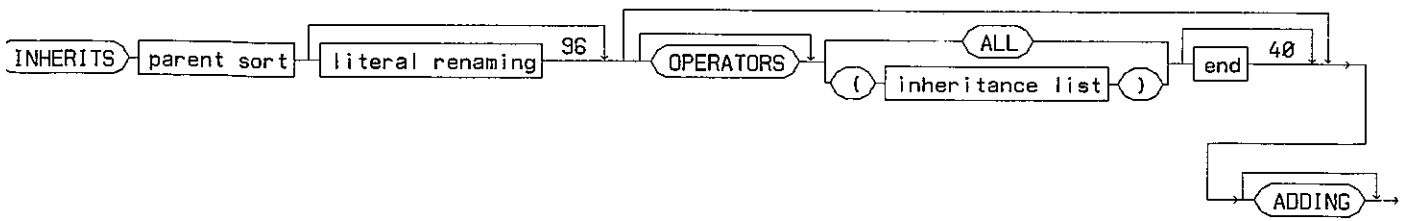

T1004250-88

96 *literal renaming* (Data 5.4.1.11)

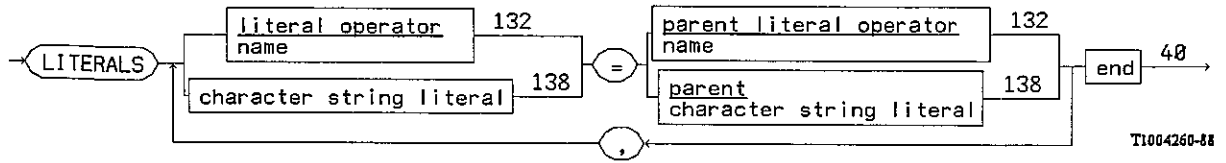

97 *generator definition* (Data 5.4.1.12.1)

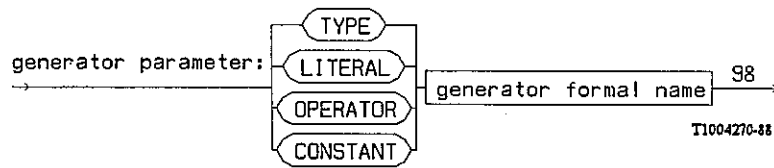
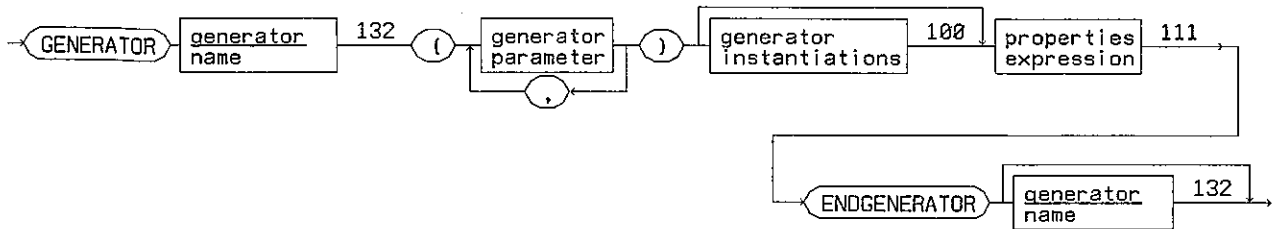

98 *generator formal name* (Data 5.4.1.12.1)

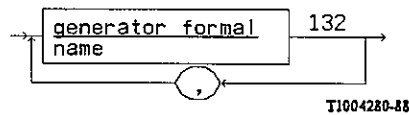

99 *generator sort* (Data 5.4.1.12.1)

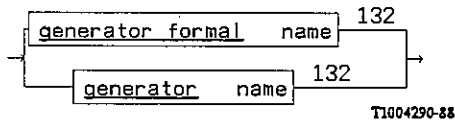

100 *generator instantiations* (Data 5.4.1.12.2)

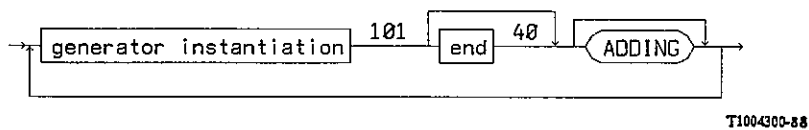

101 *generator instantiation* (Data 5.4.1.12.2)

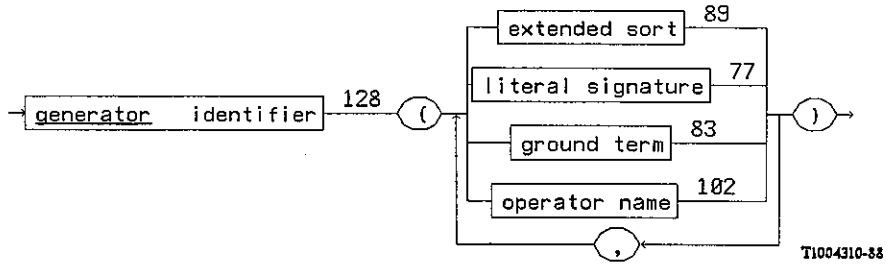

102 *operator name*

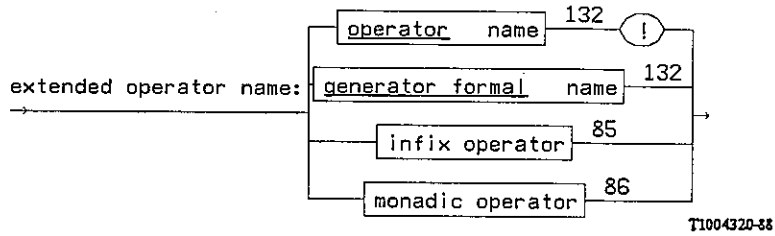
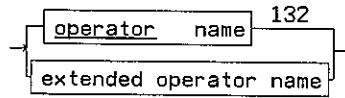

103 *synonym definition* (Data 5.4.1.13)

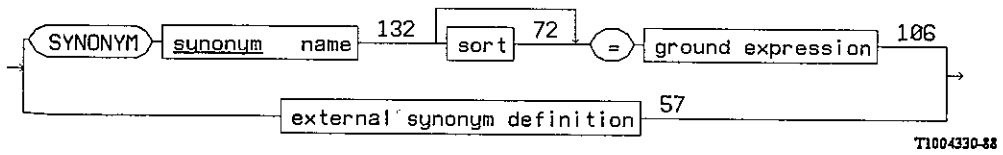

104 *name class literal* (Data 5.4.1.14)

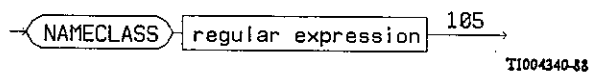

105 *regular expression* (Data 5.4.1.14)

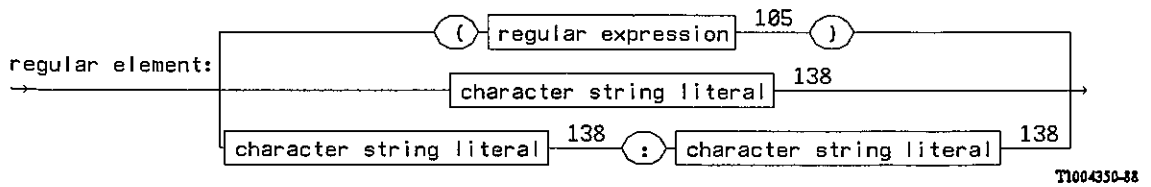
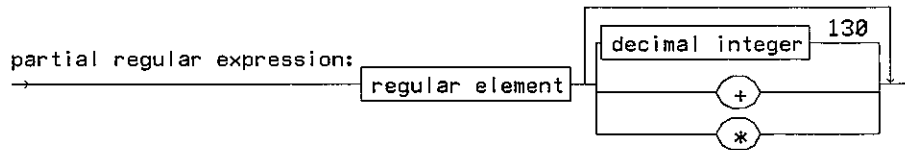
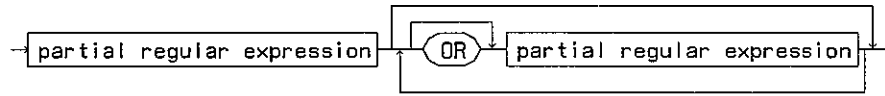

106 *ground expression* (Data 5.4.2.1)

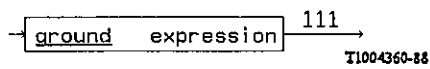

107 *active expression* (Data 5.4.2.2)

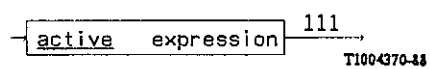

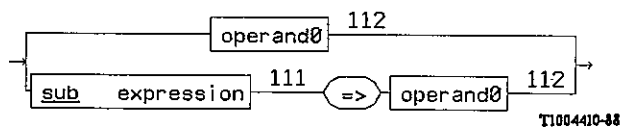
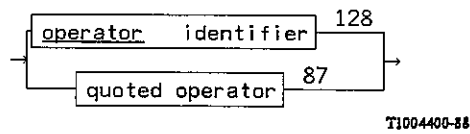
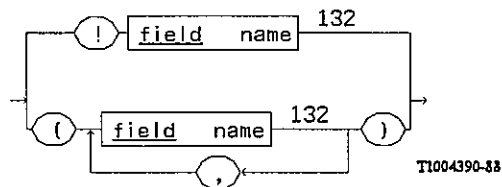
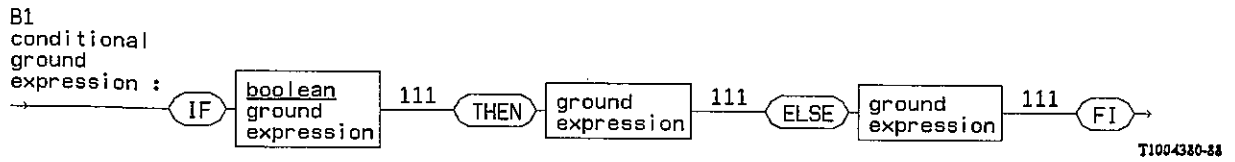
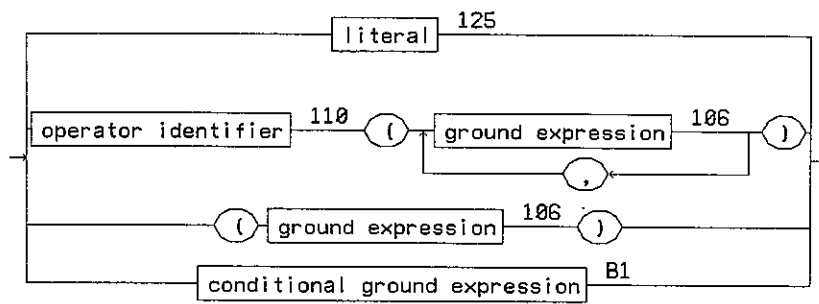

112 *operand0* (Data 5.5.2.1)

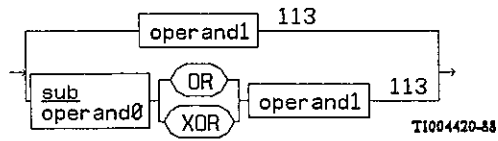

113 *operand1* (Data 5.5.2.1)

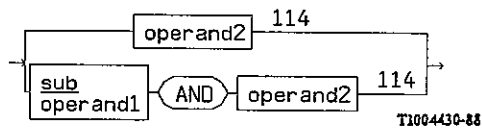

114 *operand2* (Data 5.5.2.1)

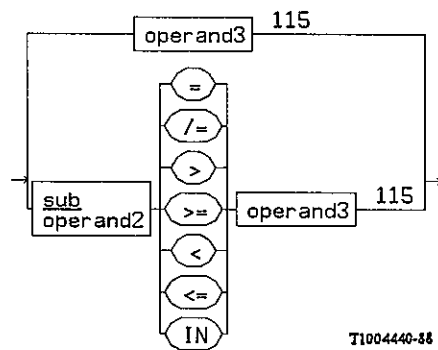

115 *operand3* (Data 5.5.2.1)

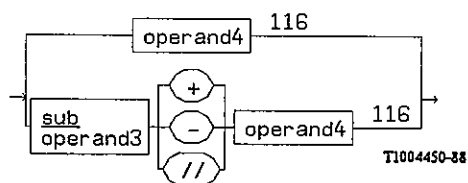

116 *operand4* (Data 5.5.2.1)

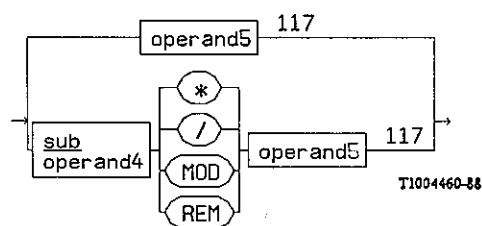

117 *operands* (Data 5.5.2.1)

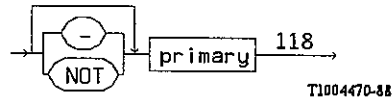

118 *primary*

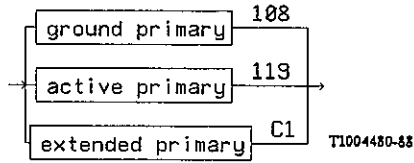

119 *active primary*

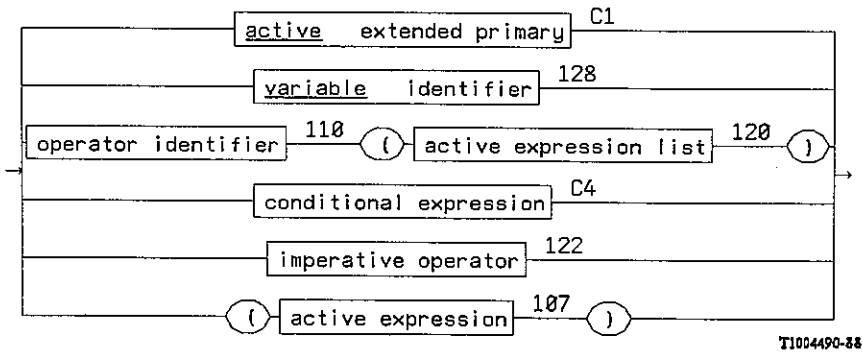

120 *active expression list* (Data 5.5.2.1)

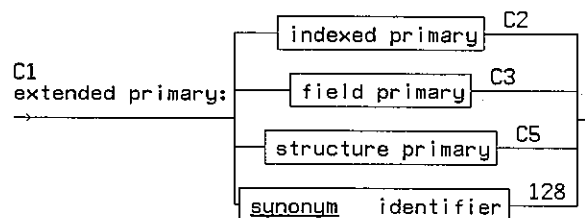
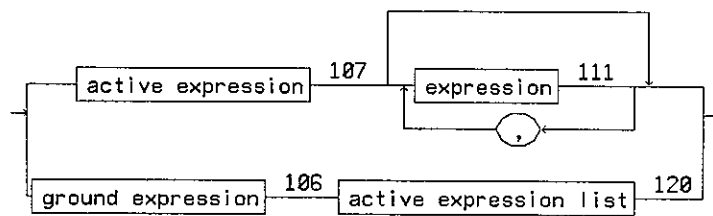

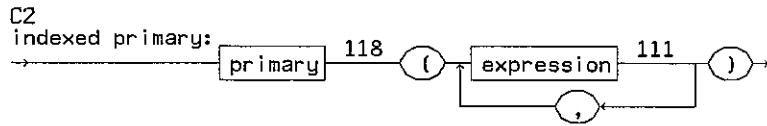

T1004510-88

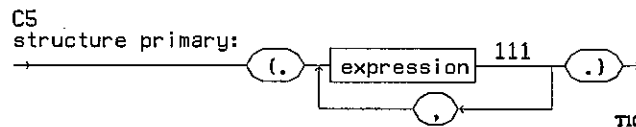
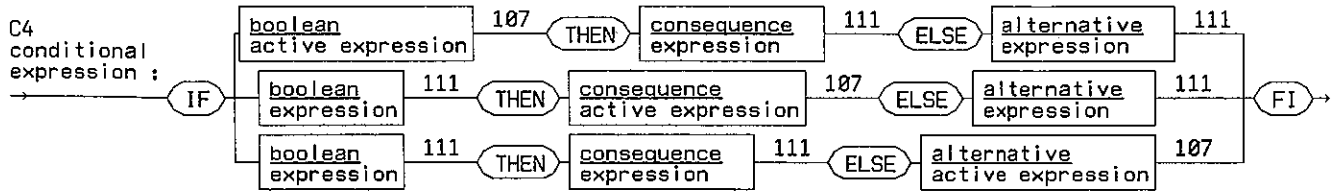
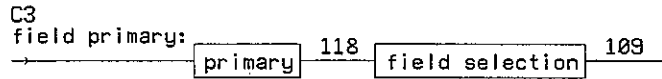

T1004540-88

121 *assignment statement*

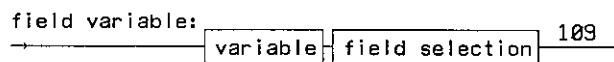
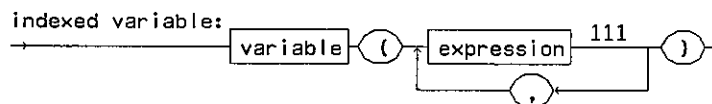
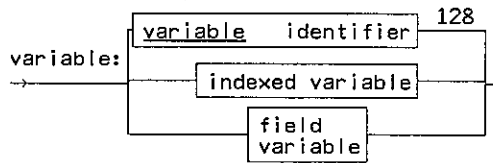
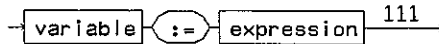

T1004550-88

122 *imperative operator* (Data 5.5.4)

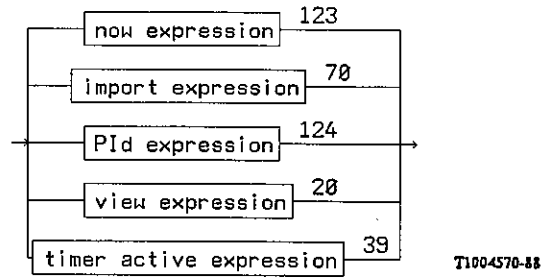

123 *now expression*

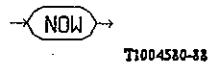

124 *PId expression*

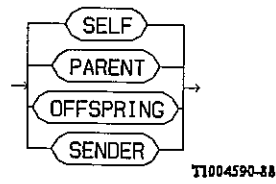

125 *literal*

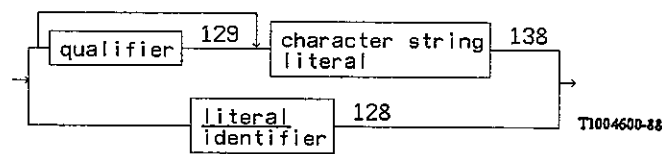

126 *label*

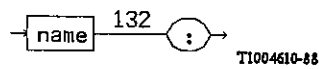

127 *comment*

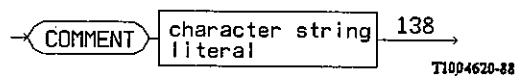

128 *identifier*

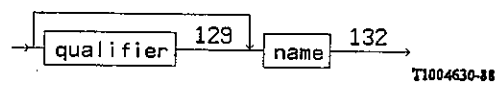

129 *qualifier*

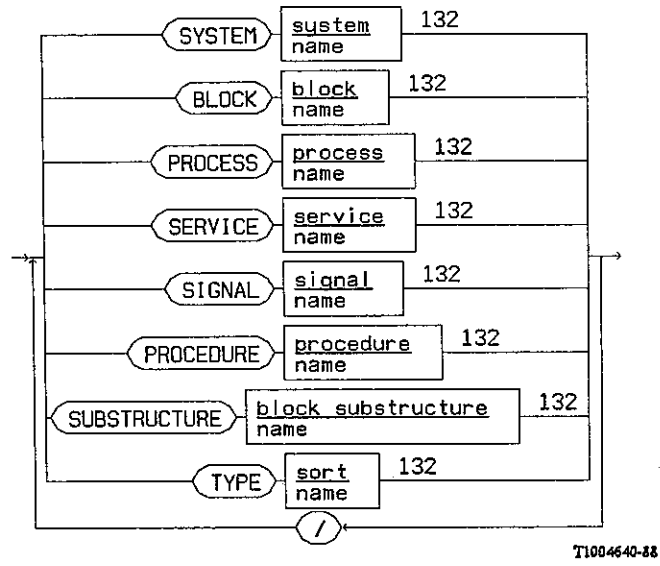

130 *decimal integer*

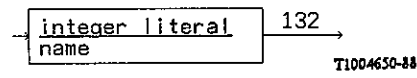

Lexical rules syntax diagrams

131 *lexical unit*

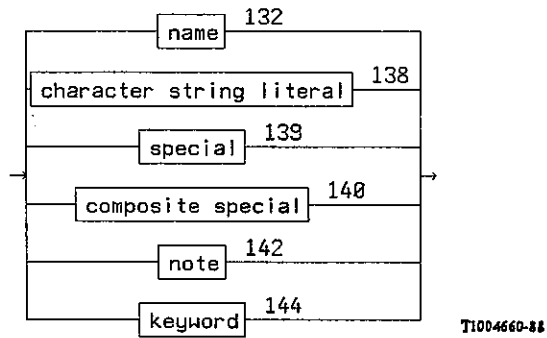

132 *name*

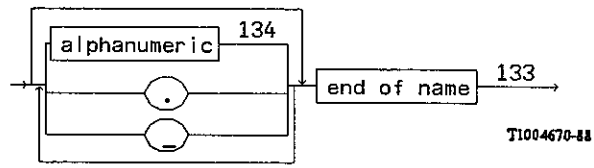

A *name* must contain at least one alphabetic character.

133 *end of name*

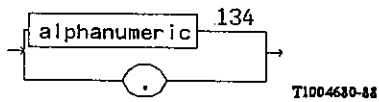

134 *alphanumeric*

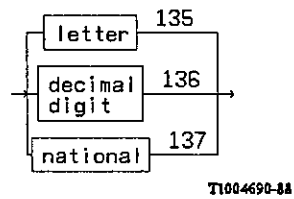

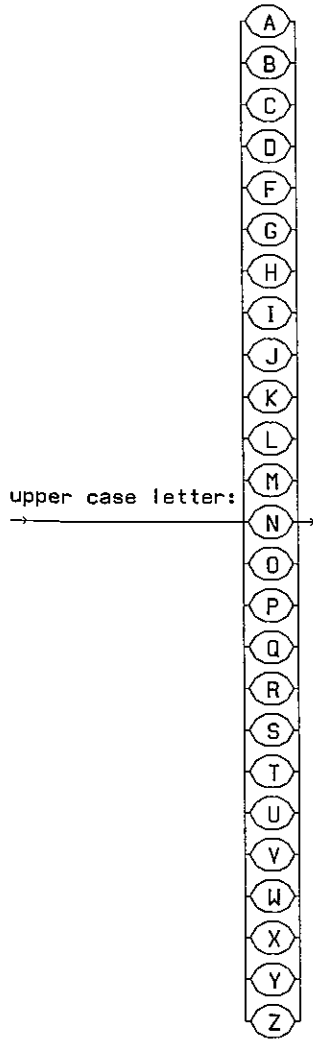
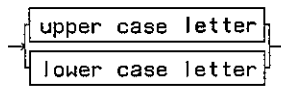

T1004700-88

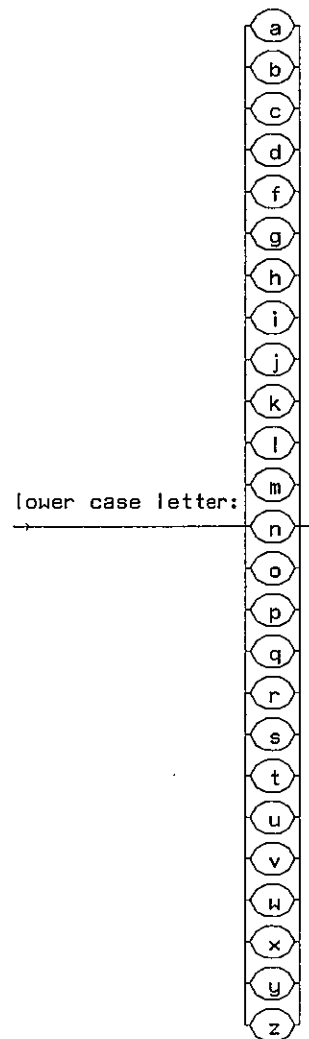

T1004700-88

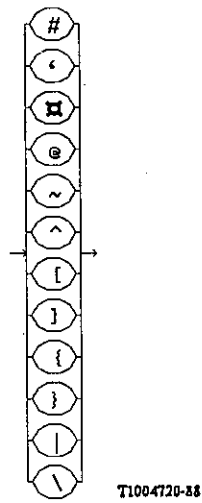
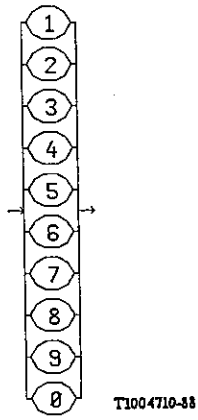

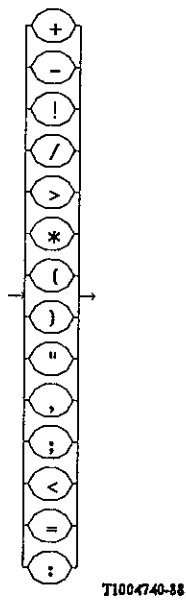
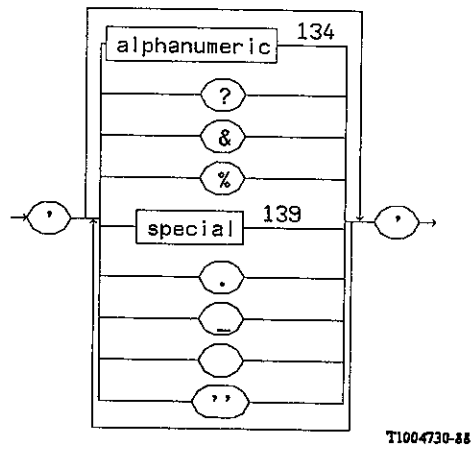

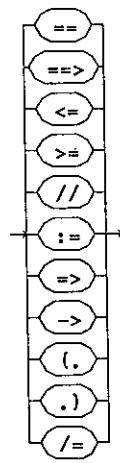

T1004750-88

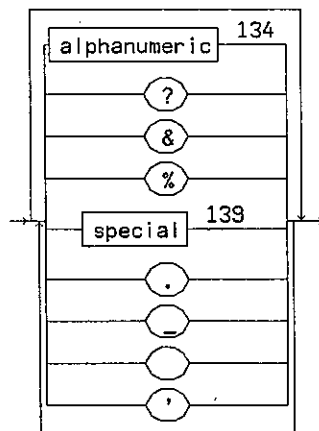

T1004760-88

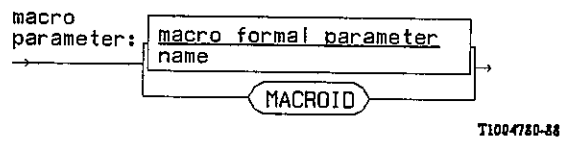
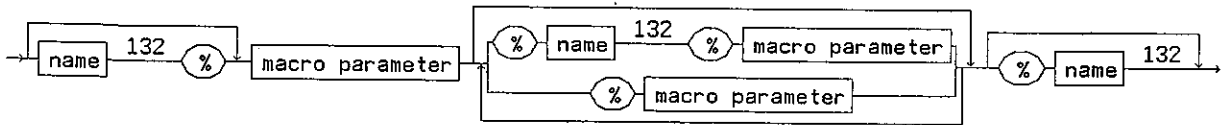
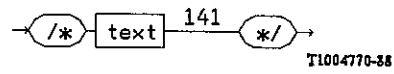

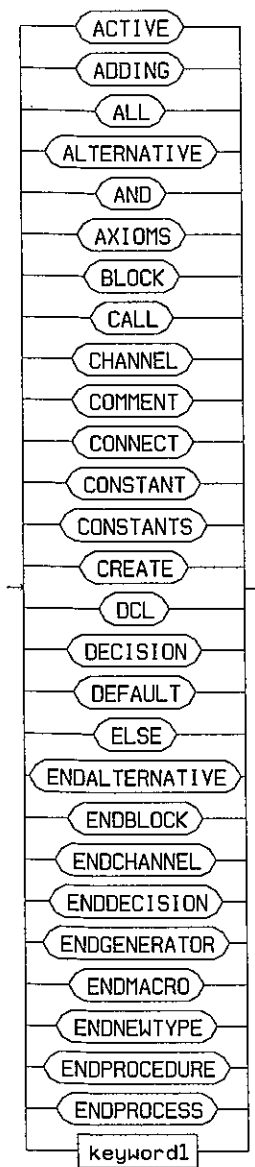

T1004790-88

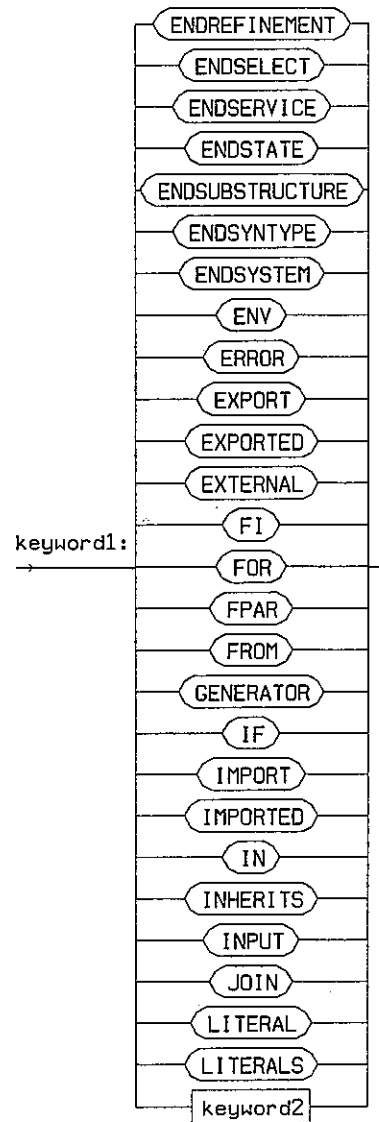

T1004790-88

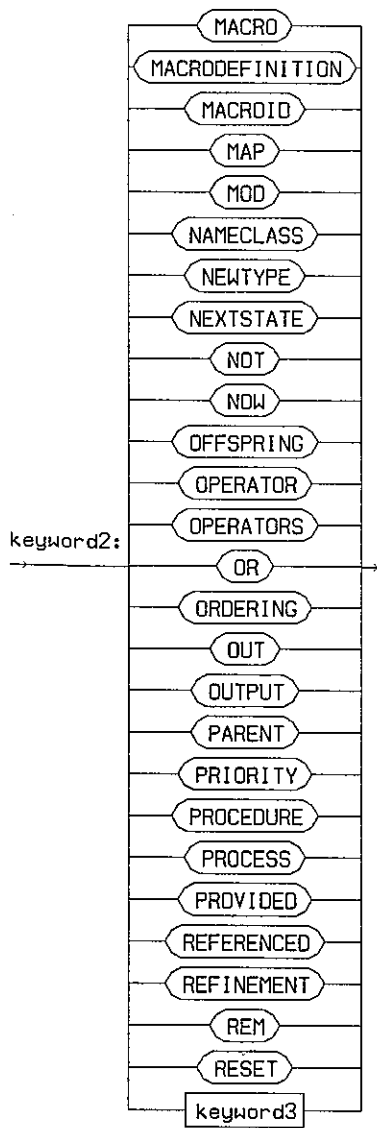

T1004600-68

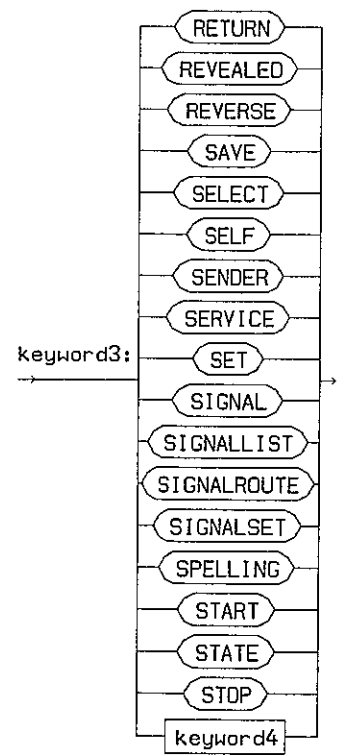

keyword4:

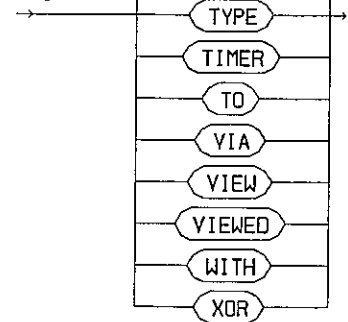

T1004600-68

INDEX

107	active expression	85	infix operator
120	active expression list	44	informal text
119	active primary	95	inheritance rule
45	actual parameters	23	input
134	alphanumeric	27	join
35	answer	144	keyword
121	assignment statement	126	label
80	axioms	135	letter
5	block definition	131	lexical unit
46	block substructure definition	125	literal
47	block substructure reference	76	literal list
48	channel connection	96	literal renaming
14	channel definition	77	literal signature
53	channel endpoint connection	56	macro call
51	channel substructure body	55	macro definition
50	channel substructure definition	86	monadic operator
52	channel substructure reference	132	name
49	channel to route connection	104	name class literal
138	character string literal	137	national
78	character string literal identifier	26	nextstate
127	comment	142	note
140	composite special	123	now expression
93	constant	112	operand0
67	continuous signal	113	operand1
31	create request	114	operand2
43	data definition	115	operand3
136	decimal digit	116	operand4
130	decimal integer	117	operand5
34	decision	110	operator identifier
2	definition	102	operator name
3	diagram	79	operator signature
68	enabling condition	75	operators
40	end	33	output
133	end of name	73	partial type definition
81	equation	124	PId expression
71	export	118	primary
111	expression	65	priority input
84	extended operator identifier	66	priority output
88	extended operator name	32	procedure call
90	extended properties	12	procedure definition
89	extended sort	10	process body
57	external synonym definition	7	process definition
109	field selection	74	properties expression
143	formal name	129	qualifier
97	generator definition	87	quoted operator
98	generator formal name	92	range conditions
101	generator instantiation	105	regular expression
100	generator instantiations	37	reset
99	generator sort	29	return
106	ground expression	24	save
108	ground primary	58	select definition
83	ground term	60	service decomposition
128	identifier	61	service definition
122	imperative operator	62	service reference
69	import definition	64	service signal route definition
70	import expression	38	set

16	signal definition	1	system
41	signal list	4	system definition
17	signal list definition	30	task
54	signal refinement	82	term
63	signal route connection	141	text
15	signal route definition	6	textual block reference
11	simple expression	13	textual procedure reference
72	sort	8	textual process reference
42	sort list	39	timer active expression
139	special	36	timer definition
21	start	25	transition
22	state	59	transition option
28	stop	9	valid input signal set
94	structure definition	18	variable definition
91	syntype definition	19	view definition
103	synonym definition	20	view expression

39	ACTIVE	83, 108, 120	FI
94, 95, 100	ADDING	74, 81	FOR
74, 81, 95	ALL	7, 55	FPAR
59	ALTERNATIVE	14, 15, 64	FROM
48, 49, 53, 63, 85, 113	AND	97	GENERATOR
74	AXIOMS	58, 83, 108, 120	IF
5, 6, 129	BLOCK	70	IMPORT
32	CALL	69	IMPORTED
14	CHANNEL	12, 74, 81, 85, 114	IN
127	COMMENT	95	INHERITS
48, 49, 53, 63	CONNECT	23, 65	INPUT
97	CONSTANT	27	JOIN
91	CONSTANTS	97	LITERAL
31	CREATE	74, 76, 96	LITERALS
18	DCL	56	MACRO
34	DECISION	55	MACRODEFINITION
74, 91	DEFAULT	143	MACROID
34, 59, 83, 108, 120	ELSE	74	MAP
59	ENDALTERNATIVE	85, 116	MOD
5	ENDBLOCK	104	NAMECLASS
14	ENDCHANNEL	73, 91	NEWTYPER
34	ENDDECISION	26	NEXTSTATE
97	ENDGENERATOR	86, 117	NOT
55	ENDMACRO	123	NOW
73, 91	ENDNEWTYPER	124	OFFSPRING
12	ENDPROCEDURE	97	OPERATOR
7	ENDPROCESS	75, 95	OPERATORS
54	ENDREFINEMENT	85, 105, 112	OR
58	ENDSELECT	75	ORDERING
61	ENDSERVICE	12	OUT
22	ENDSTATE	33, 66	OUTPUT
46, 50	ENDSUBSTRUCTURE	124	PARENT
91	ENDSYNTYPER	65, 66, 67	PRIORITY
4	ENDSYSTEM	12, 13, 129	PROCEDURE
14, 15, 53, 64	ENV	7, 8, 129	PROCESS
82	ERROR	67, 68	PROVIDED
71	EXPORT	6, 8, 13, 47, 52, 62	REFERENCED
18	EXPORTED	54	REFINEMENT
57	EXTERNAL	85, 116	REM

37	RESET	22	STATE
29	RETURN	28	STOP
18	REVEALED	94	STRUCT
54	REVERSE	46, 47, 50, 52, 129	SUBSTRUCTURE
24	SAVE	57, 103	SYNONYM
58	SELECT	91	SYNTYPE
124	SELF	4, 129	SYSTEM
124	SENDER	30	TASK
61, 62, 129	SERVICE	83, 108, 120	THEN
38	SET	97, 129	TYPE
16, 129	SIGNAL	36	TIMER
17	SIGNALLIST	14, 15, 33, 64	TO
15, 64	SIGNALROUTE	33	VIA
9	SIGNALSET	20, 33	VIEW
82	SPELLING	19	VIEWED
21	START	14, 15, 64	WITH
		85, 112	XOR

ITU-T RECOMMENDATIONS SERIES

Series A	Organization of the work of the ITU-T
Series B	Means of expression: definitions, symbols, classification
Series C	General telecommunication statistics
Series D	General tariff principles
Series E	Overall network operation, telephone service, service operation and human factors
Series F	Non-telephone telecommunication services
Series G	Transmission systems and media, digital systems and networks
Series H	Audiovisual and multimedia systems
Series I	Integrated services digital network
Series J	Transmission of television, sound programme and other multimedia signals
Series K	Protection against interference
Series L	Construction, installation and protection of cables and other elements of outside plant
Series M	TMN and network maintenance: international transmission systems, telephone circuits, telegraphy, facsimile and leased circuits
Series N	Maintenance: international sound programme and television transmission circuits
Series O	Specifications of measuring equipment
Series P	Telephone transmission quality, telephone installations, local line networks
Series Q	Switching and signalling
Series R	Telegraph transmission
Series S	Telegraph services terminal equipment
Series T	Terminals for telematic services
Series U	Telegraph switching
Series V	Data communication over the telephone network
Series X	Data networks and open system communications
Series Y	Global information infrastructure and Internet protocol aspects
Series Z	Languages and general software aspects for telecommunication systems