



INTERNATIONAL TELECOMMUNICATION UNION

ITU-T

TELECOMMUNICATION
STANDARDIZATION SECTOR
OF ITU

Z.317

MAN-MACHINE LANGUAGE

MAN-MACHINE DIALOGUE PROCEDURES

ITU-T Recommendation Z.317

(Extract from the *Blue Book*)

NOTES

1 ITU-T Recommendation Z.317 was published in Fascicle X.7 of the *Blue Book*. This file is an extract from the *Blue Book*. While the presentation and layout of the text might be slightly different from the *Blue Book* version, the contents of the file are identical to the *Blue Book* version and copyright conditions remain unchanged (see below).

2 In this Recommendation, the expression “Administration” is used for conciseness to indicate both a telecommunication administration and a recognized operating agency.

MAN-MACHINE DIALOGUE PROCEDURES

1 General

Man-machine communication comprises two types of information interchange, namely *dialogue* and *output outside dialogue*; they occur sequentially and in no particular order. Output outside dialogue is fully defined in Recommendation Z.316.

Dialogue is that part of man-machine communication initiated and, normally, terminated by the user. It is accomplished by means of the dialogue procedures described in this Recommendation. In the text, the terms “dialogue” and “dialogue procedure” are used interchangeably.

The text in § 2 describes the dialogue procedure, the syntax diagrams of which are given in § 3 in sub-divisions having numbers corresponding to those used in § 2.

A systematic analysis of possible errors made by users is not considered. Diagrams mainly refer to correctly given commands and only obvious error situations are considered. It is recognized that the diagrams are not exhaustive and some of them might be modified when error recovery procedures have been completely considered.

2 Definition of the dialogue procedure

2.1 Overview of the dialogue procedure

A dialogue is opened by a procedure prologue. The procedure prologue contains the various preparations which must be performed before commands can be initiated. It may include a header from the system. Following the procedure prologue a destination prologue can precede one or more interactive operating sequences. The dialogue can be terminated by a procedure epilogue.

2.2 procedure prologue

The procedure prologue may consist of three parts given in the following order:

- the request, which is an action to activate the man-machine terminal and the system;
- the identification of the user. The identification of the user is optional. Identification may be bypassed under special conditions, for example system initialization. In situations where no identification procedure is used, then it must be possible to allow access only for certain periods per day, e.g., office hours;
- a header, which is given from the system and contains the exchange identification, information relating to date and time, etc. Headers can be optional for a system or within a system for certain terminals.

The procedure prologue is intended to be executed only once at the beginning of a dialogue. The procedure prologue is followed by a ready indication inviting a destination prologue or an interactive operating sequence.

The request, the identification of the user and the header are defined in the following paragraphs.

2.2.1 request

The request is a manual action to activate the terminal and the system or to cause an interrupt. The composition of the request is highly dependent on the type of terminal and implementation.

The request can consist of keying the break key or actuating a control switch, power on, etc. and/or keying a sequence of characters on the keyboard.

2.2.2 identification procedure

The identification procedure is used to identify the user to the system. The identification procedure may involve the use of identity cards which provide secure access to the system.

After a user has been identified to the system, different authorization levels may be applied that restrict access to groups of commands depending on security or functional classification.

The identification procedure (see figure 3.2.2/Z.317) is flexible, with many options, but the following guidelines

apply:

- if an identity card is used, it should always be preceded or followed by a password;
- for security reasons, it might be required to suppress all response from the system to the identification procedures;
- after a number of consecutive attempts some appropriate action is needed. For example: generate an alarm, or temporarily block access to the system from that terminal.

2.2.2.1 ready indication

The ready indication indicates that the direction of the dialogue has changed and that the system is waiting for information to be given at the terminal. The ready indication is defined as the character < (less than sign) optionally preceded by the appropriate format effectors. The < (less than sign) character is not necessarily required in extended MML (Recommendations Z.321-Z.323), as the information that the terminal is ready for input can be given by cursor position, or additional information contained somewhere in the menu or form.

2.2.3 header

The header (see Recommendation Z.316) is output by the system at the end of the procedure prologue.

2.3 destination prologue

The destination prologue consists of a destination identifier terminated by the separator > (greater than sign) so as to distinguish it from a command.

The destination identifier indicates the physical area where the command is to be mainly processed, e.g., exchange identification, processor number. It consists of one or more information units separated by - (hyphen). The destination could also be defined by a parameter in the command.

The destination identifier may be followed by a header to indicate that a selected destination is allowed, available and ready or alternatively by a rejection output to indicate the converse.

2.4 procedure epilogue

The procedure epilogue is used to terminate the dialogue procedure. The composition of the procedure epilogue is highly dependent on the type of terminal and implementation. The procedure epilogue can consist of actuating a control switch, power off, etc. and/or keying a sequence of characters on the keyboard and/or the output of end of dialogue from the system.

2.5 interactive operating sequence

The interactive operating sequence may consist of a single command entry sequence terminated by an optional end statement or of a series of command entry sequences or special actions. The latter occurs when, as a result of partial execution of a function, the system requests the supply of further information in the form of special actions or further commands for which human judgement and/or decision is required.

2.5.1 command entry sequence

A command entry sequence contains a single command code, together with an alternating sequence of one or more parameter blocks and an appropriate number of executions.

Any interactive operating sequence may be stopped prematurely by the user with the entry of a particular command entry sequence. The latter could consist of a certain command which is independent of any interactive operating sequence, e.g., EXIT, etc.

2.5.2 Manual response

Special actions can include manual responses, such as the actuation of keys on terminals or switchframes and the replacement of equipment.

2.5.3 Interaction request output

The system generates an interaction request output in order to obtain further actions.

2.5.4 **end statement**

An end statement is an indication that an operating sequence has finished.

2.6 *Direct parameter input*

Only one method of inputting parameters is dealt with in direct parameter input. For other methods refer to Recommendations Z.321 to Z.323.

Direct parameter input consists of an optional parameter block entry sequence preceded by the separator: (colon). The none or more parameter blocks are to be terminated by the execution character; (semicolon) or by the continuation character ! (exclamation mark) to initiate the required functions which will result in a response output.

If terminated by an execution character and responded by an acceptance or rejection output, the system concludes the direct parameter input. If terminated by a continuation character and responded by an acceptance or rejection output, the system is required to return a parameter block request indication that functions as an indication to proceed with the input of the next block or blocks of parameters. If responded by a request output the system is required to return a parameter block request indication that functions as an invitation for entering either an updated part of the current block of parameters (e.g., a parameter that was erroneously input) or an expansion of the current block of parameters, dependent on the contents of the request output. Following the parameter block request indication, the command entry sequence can be abandoned by invoking the delete command function.

The parameters are input in accordance with the parameter block entry sequence.

2.6.1 *Parameter block entry sequence*

The parameter block entry sequence is used to input a block of parameters. All parameters are entered according to the input syntax. The entry of the parameters may be done directly without help from the system as described in Recommendation Z.315, or assistance from the system may be requested by calling the prompting facility. Prompting helps in providing a correct input by the system giving guidance on the next input requirement.

The output given by the prompting facility can be either of the following:

- a) Guidance output followed by a ? (question mark). The guidance may apply to the complete block of parameters, to that part of the block of parameters that is still to be input or to the single parameter next to be input. Moreover it may contain an indication that the input supplied is sufficient and that an execution order may be given. Guidance can be requested anywhere in the parameter block entry sequence.
- b) Parameter name output followed by an = (equal sign). The parameter name applies to the parameter value next to be input.

It is the objective of the parameter name output or guidance output to assist the user in giving correct input required by the system for the current command. In both cases the system may verify input received – if possible – and prompt with enough information to enable input to continue.

What kind of prompting output is given is dependent on the prompting facilities supported by the system involved and – if more than one facility is supported – on the place of the request for prompting.

These recommendations address prompting on request of the user. Unsolicited system directed prompting is also possible but is not covered by these recommendations.

Following “parameter name output”, a default value for the parameter cannot be implied by simply omitting the value. A specific “default indicator” must be given. If, however, a further ? (question mark) is input, the system will give guidance output, and default by omission may then be possible.

2.6.2 *Parameter block request indication*

The parameter block request indication consists of a: (colon) optionally preceded by the appropriate format effectors and/or the appropriate command code.

2.7 *Response output*

Response output covers all types of output conveying information about the state of an input. Types of response output are acceptance output, rejection output and request output.

A list of categories of each type of response output is given below. Each category is identified by means of the status of the requested action or by means of the error introduced by the user. The title of each category is not meant to be interpreted as the text to be associated with each response output. Additional categories may be created, e.g., by dividing into several parts any one of the categories listed below.

2.7.1 Acceptance output

Acceptance output is an indication that an input to the system is syntactically correct and complete and that the appropriate system actions will be initiated, or have already been carried out. In the latter case, this indication may take the form of the result of the actual action.

<i>Category of acceptance output</i>	<i>Description</i>
COMMAND EXECUTED	The input command was correct and the requested action(s) was successfully performed. The execution of some commands may produce a result to be output immediately after the command has been input. In this case, the result itself may act as the acceptance output.
COMMAND ACCEPTED	The input command was correct and the requested action(s) was accepted. This action(s) is either in progress or has been scheduled to be performed. Subsequent outputs related to this requested action may follow later.

2.7.2 Rejection output

Rejection output is an indication by the system that the input received is not valid and will not be acted upon, nor can correction be applied, e.g., when the system determines that the user is not authorized to request the action required by the command.

<i>Category of rejection output</i>	<i>Description</i>
UNACCEPTABLE COMMAND	The command form is valid but the requested action conflicts with the current system or equipment status, e.g., an attempt to restore an in-service unit.
NO SYSTEM RESOURCES	The requested action cannot be executed now due to unavailable system resources such as system overload, excessive queue lengths, busy programs, etc. The command may be entered again later.
TRANSMISSION ERROR	A transmission error occurred in the input and the system will not accept the command.
SYSTEM ACCESS UNAVAILABLE	Input/output access to the system is currently unavailable.
GENERAL ERROR	Any rejection that cannot be placed in one of the more specific rejection output categories.
INVALID PASSWORD	The input password is unknown to the system or has been input from an improper terminal.
ILLEGAL COMMAND	The input command cannot be requested under the current password or from the terminal from which it has been requested.
INVALID SEQUENCE	In an interactive operating sequence a command has been entered in the wrong sequence.
TIME OUT ERROR # 1	The next input character has not been received in time for processing and the command has been aborted.
INVALID COMMAND CODE SEPARATOR	The command code contains an invalid separator.
INVALID COMMAND CODE IDENTIFIER	The command code contains an invalid identifier.

2.7.3 Request output

Request output is an output message which requests further input action, e.g., to correct an erroneous parameter.

<i>Category of request output</i>	<i>Description</i>
INVALID SEPARATOR	The wrong input character has been used as a separator.

INVALID INDICATOR	The wrong input character has been used as an indicator.
INVALID PARAMETER NAME	A parameter name not associated with this command has been input.
EXTRA PARAMETERS	Too many parameters have been entered or a parameter has been entered in a command not requiring parameters.
MISSING PARAMETER	One or more parameters required by the command have not been entered.
INCONSISTENT PARAMETER	The set of parameters in a command does not form a valid set, or the parameters received at an intermediate point are not a valid subset.
MISSING DATA	One or more information units of a parameter argument have been omitted.
INCONSISTENT DATA	One or more parameter arguments are inconsistent with arguments associated with other parameters, or with the presence (absence) of other parameters in the command, or with data already in the system, although each could be individually valid.
INVALID INFORMATION GROUPING	The type of information grouping used in the input of the parameter value is not valid.
RANGE ERROR	The value(s) assigned to a parameter is out of the range of the allowed values.
INVALID INFORMATION UNIT	The information unit(s) introduced to specify the value(s) of a parameter does not match with the syntactic element requested for the information unit(s).

2.7.4 *Miscellaneous output*

A category of output that does not belong to one of the types above is that given when the dialogue is closed on the initiative of the system.

Category of output

Description

TIME OUT ERROR # 2

The next input after the completion of a command has not been received in time and the dialogue has been aborted.

3 Definition of the dialogue procedure syntax in diagrams

Recommendations Z.315 and Z.316 describe the input and output syntactic elements used, but not defined, in this Recommendation.

3.1 *Dialogue procedure*

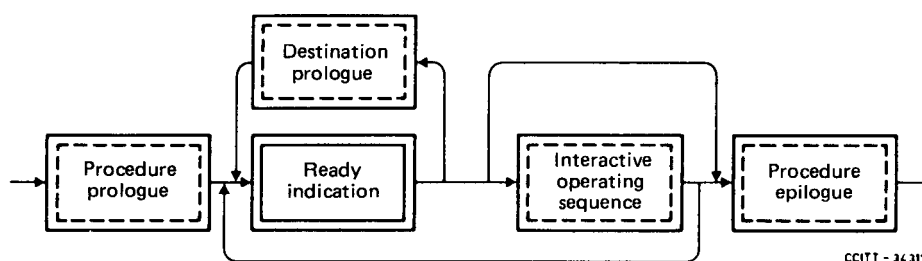

3.2 Procedure prologue

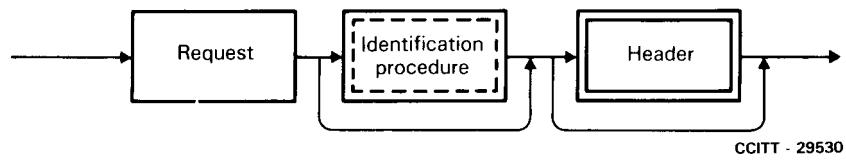

3.2.1 Request

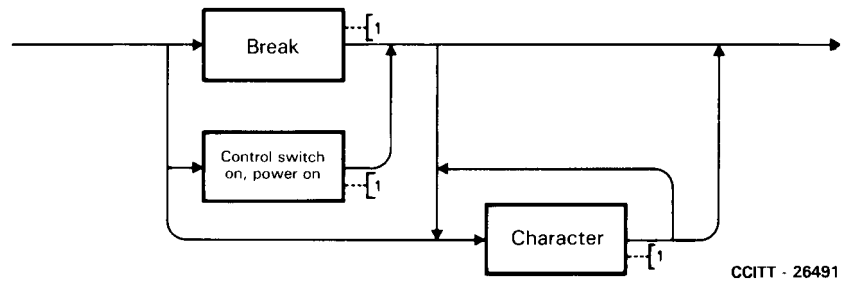

3.2.2 Identification procedure

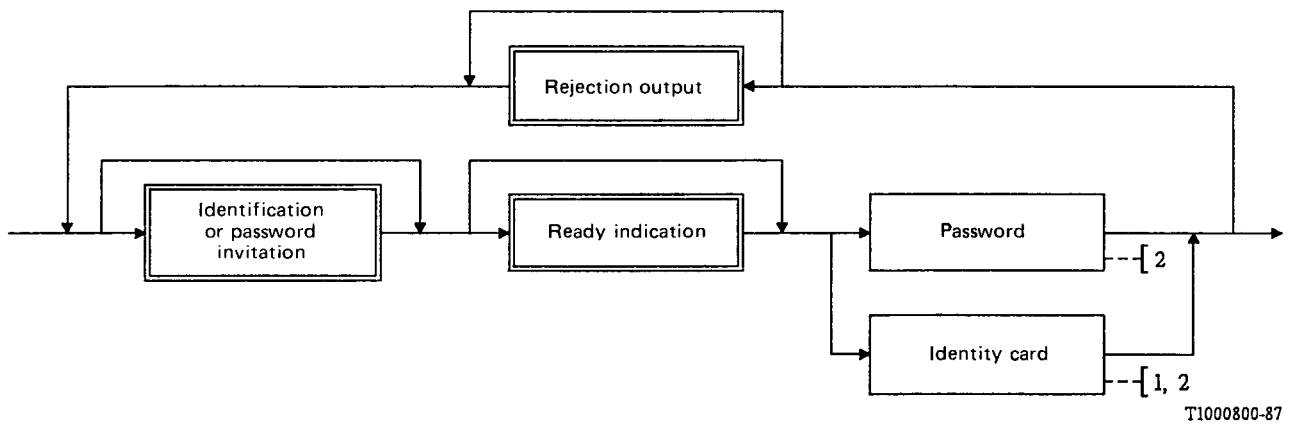

3.2.2.1 Ready indication

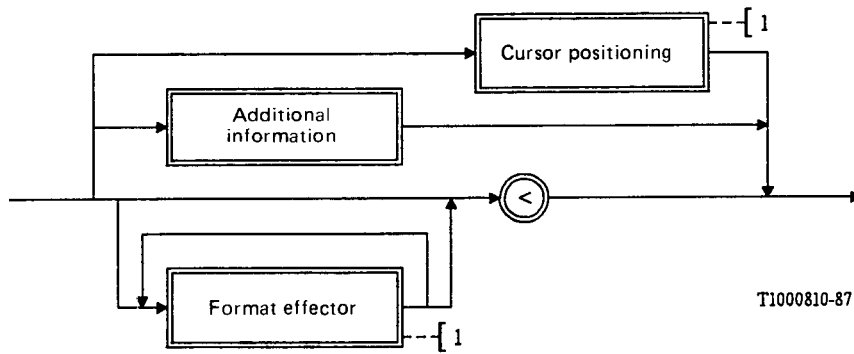

T1000810-87

1) Not further expanded in diagram form.

3.2.2.2 Identification or password invitation

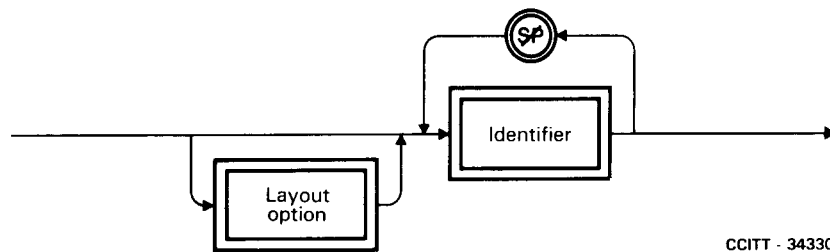

CCITT - 34330

3.2.2.3 Password

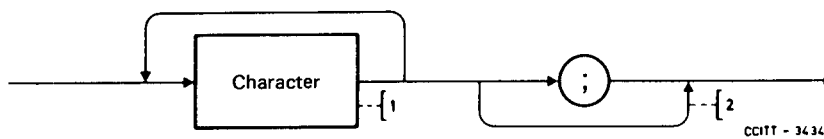

CCITT - 34341

- 1) Not further expanded in diagram form.
- 2) If an explicit MML indicator is used to terminate the input, it is recommended to be the ; (semicolon). On the other hand the bypass reflects that other mechanisms to terminate the input are available, e.g. an implicit length of a password.

3.3 Destination prologue

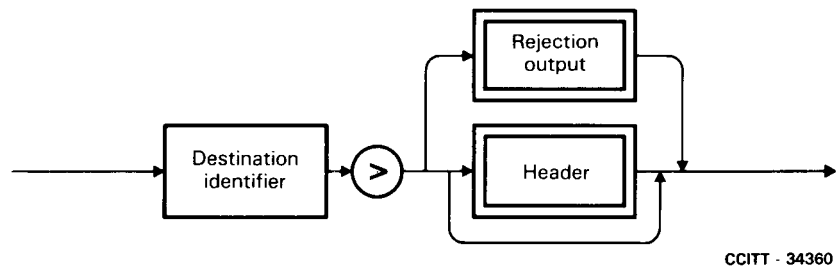

3.3.1 Destination identifier

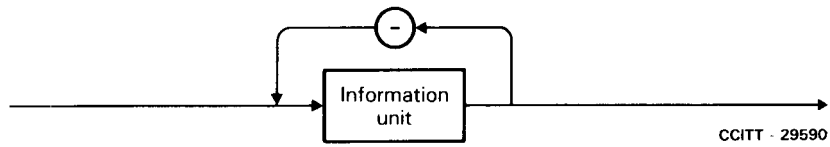

3.4 Procedure epilogue

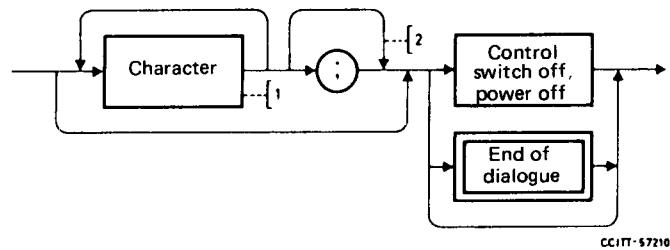

- 1) Not further expanded in diagram form.
- 2) If an explicit MML indicator is used to terminate the input it is recommended to be the ; (semicolon). On the other hand the bypass reflects that other mechanisms to terminate the input are available, e.g. a unique set of characters such as "OFF", "BYE".

3.4.1 *End of dialogue*

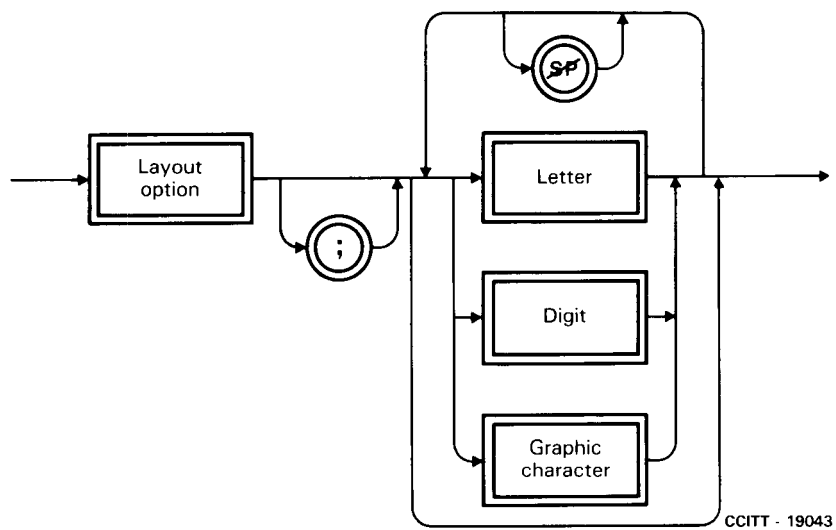

3.5 *Interactive operating sequence*

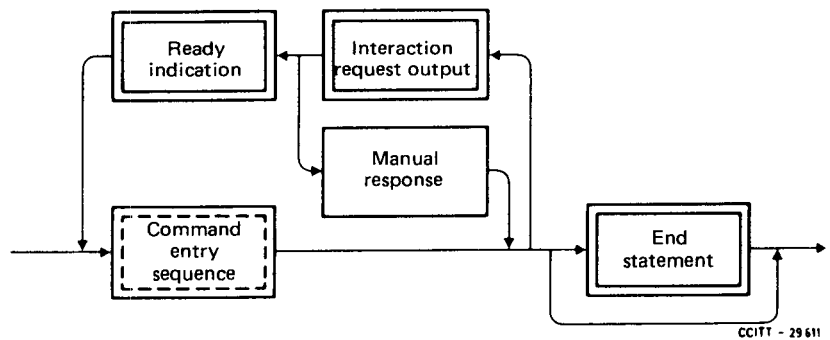

3.5.1 *Command entry sequence*

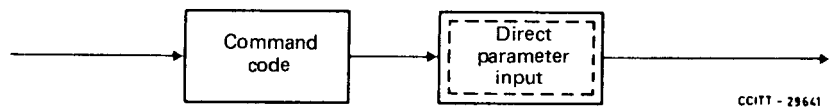

3.5.2 Manual response

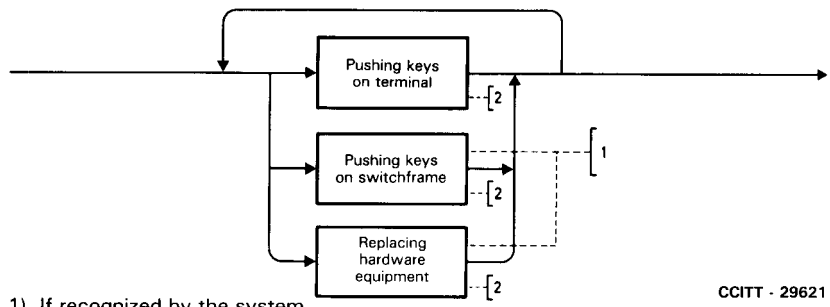

CCITT - 29621

- 1) If recognized by the system.
- 2) Not further expanded in diagram form.

3.5.3 Interaction request output

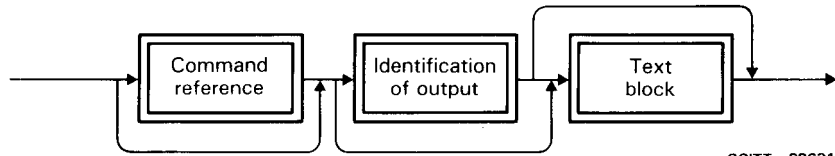

CCITT - 29631

3.5.4 End statement

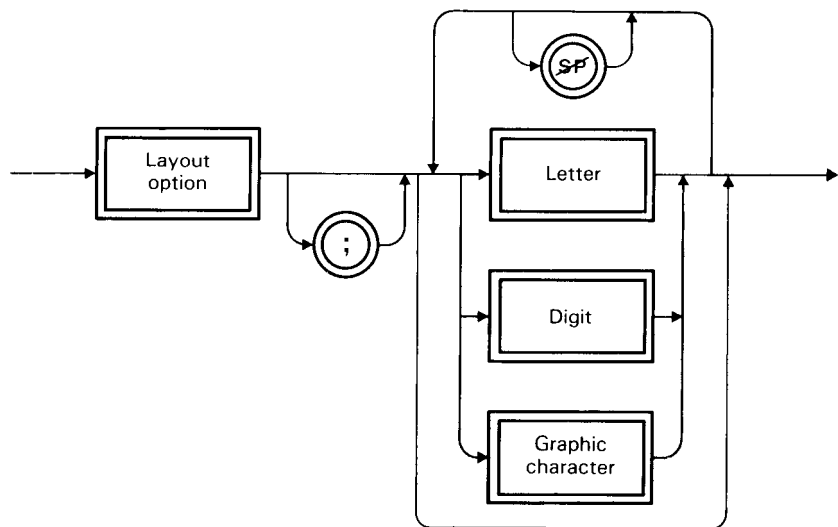

CCITT - 19043

3.6.1 Parameter block entry sequence

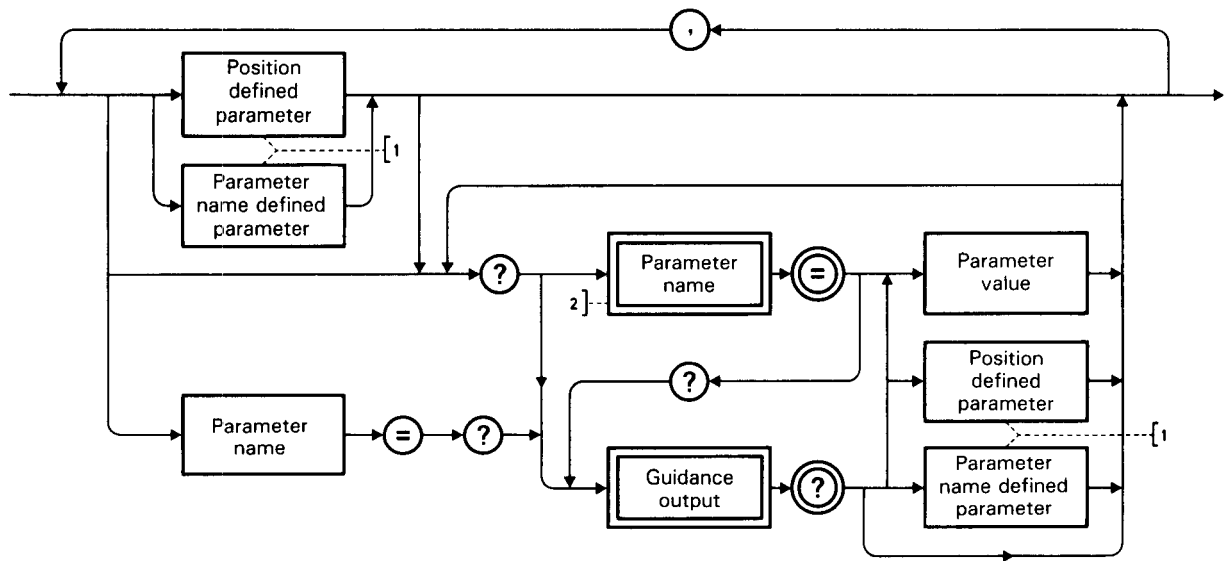

CCITT - 29671

- 1) It is not permitted to mix parameters of different types within a block of parameters.
- 2) See Recommendation Z.315.

3.6.2 Parameter block request indication

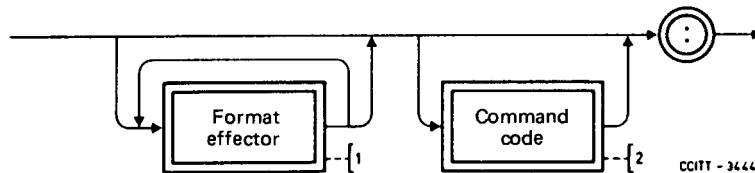

CCITT - 34441

- 1) Not further expanded in diagram form.
- 2) See Recommendation Z.315.

3.6.3 Guidance output

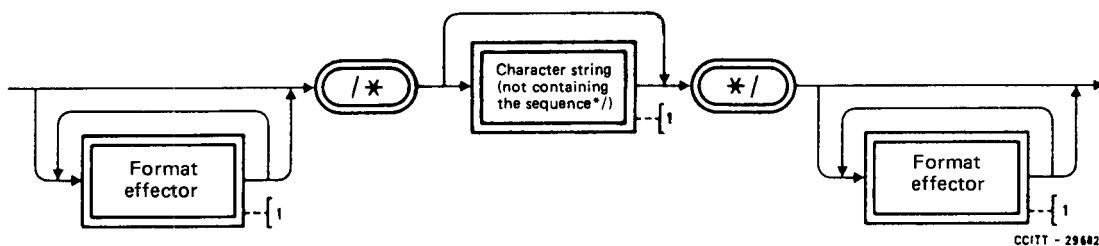

CCITT - 29682

- 1) Not further expanded in diagram form.

3.7 *Response output*

3.7.1 *Acceptance output*

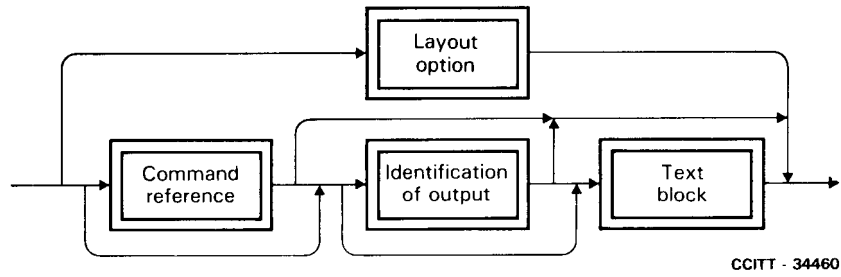

3.7.2 *Rejection output*

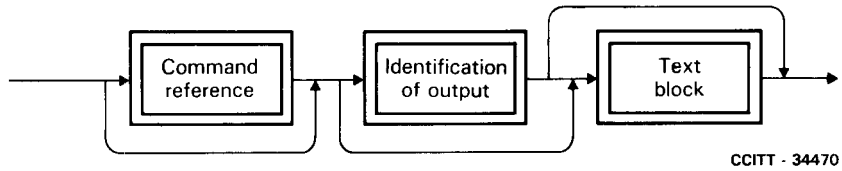

3.7.3 *Request output*

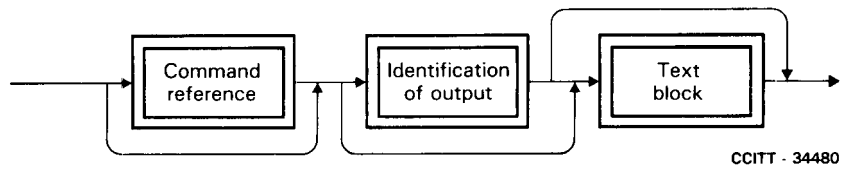

4 Input/output management

4.1 *General*

The question of input/output management is highly hardware and system dependent. Input/output management strategies should be provided to:

- solve any conflict of output outside dialogue directed to an input/output (I/O) device involved in a dialogue procedure;
- solve any conflict of more than one output outside dialogue competing for the same I/O device;
- permit the user to perform a dialogue at any time.

4.2 Priorities of output

The priority of an output outside dialogue will determine the behaviour of the output in relation to a dialogue procedure and in relation to other outputs. System crash messages and those outputs that occur after a dangerous situation, implying an immediate recovery procedure such as system reload, are not governed by the following input/output management procedures but may be output at any time.

The priority of an output outside dialogue is the property of the output and dictates the sequence of the output. When several outputs are competing for the use of the same I/O device, the output with the highest priority is output first. Outputs of the same priority are output on a first come first served basis. From an input/output management point of view there shall be two classes of priority for output outside dialogue: high, low.

Lengthy outputs shall be divided into convenient units. Interruptions of output shall only occur at the end of an output unit. A suitable dimension for a unit of output shall be sufficient to allow the output of a meaningful message.

4.3 Output to a device not in a dialogue procedure

An output outside dialogue directed to an I/O device not involved in a dialogue procedure is always output, unless another output is in progress on that I/O device, in which case the current output must be completed first. These outputs may be interrupted by input (see § 4.5).

Optionally a system may choose to output the current output only up to the end of the current unit of output before outputting a waiting high priority output.

4.4 Output to a device in a dialogue procedure

High priority outputs, which are outputs outside dialogue, are allowed either to be announced or to interrupt the dialogue between interactive operating sequences¹⁾. When a high priority output is announced by means of a message waiting indication, an acceptance input can be given which will cause the waiting output to take place (see § 4.4.1 for an extended syntax diagram for output interrupting input).

Low priority outputs, which are outputs outside dialogue, are not allowed to be announced or to interrupt the dialogue and should be delayed until the end of the dialogue.

4.4.1 Interruption in dialogue due to input/output management

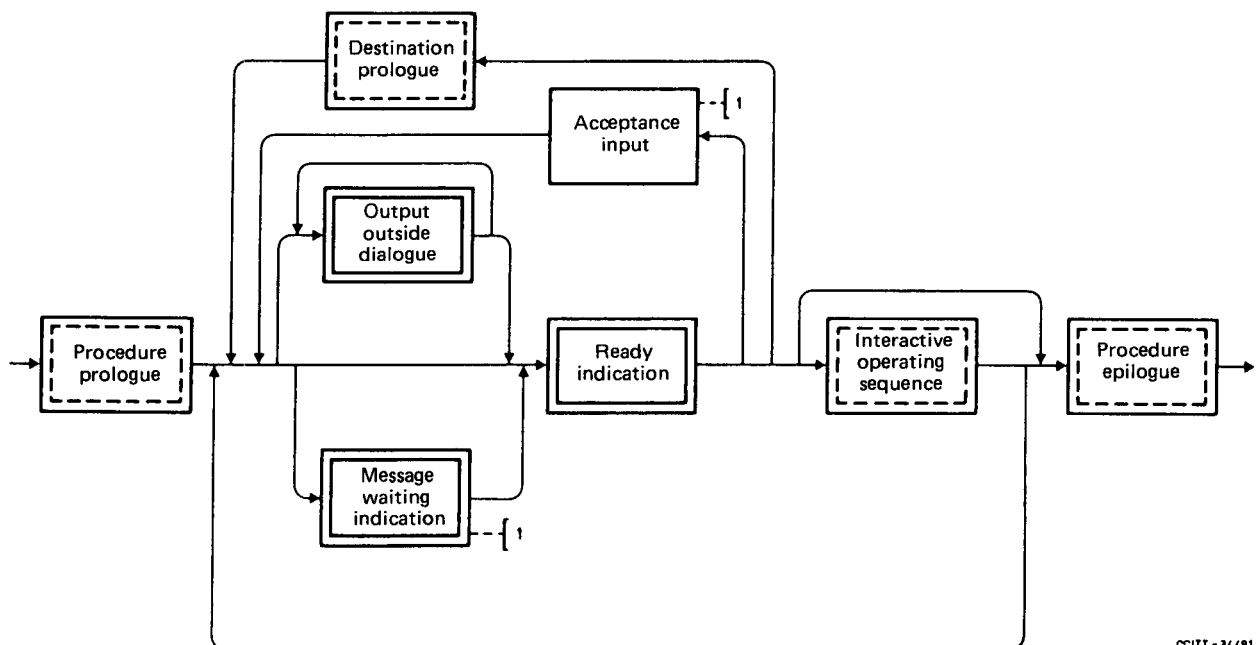

1) Not further expanded in diagram form.

1) Interruption in other places is not excluded.

4.5 *Input interrupting output*

A facility is provided to allow the interruption of an output occurring at an I/O device. However, a request, rejection or acceptance output (where it is not used as the result of the actual action) cannot be interrupted. The output may be interrupted by means of a request as defined in § 2.2.1. When the above request has been made the dialogue with the system can be started/continued.

The interrupted output may be managed by giving an instruction to resume, cancel or restart it. Alternatively, the interrupted output may be managed according to the property of the message itself, assigned at the time of message design.

When the interrupt request is given, the interrupt shall be carried out after the current unit of output.

5 **Time-out control inside dialogue**

Two particular time-outs are identified within a dialogue. The time-outs are provided to prevent lockout of outputs and/or to prove the presence of the user. The latter is used when the system has functions for procedure prologue and epilogue. In this case, two time-outs may be provided where the first one is used within any input. The second time-out is set after completion of the procedure prologue, the destination prologue, and the command entry sequence. Both time-outs are cancelled by the receipt of any input.

When the first time-out elapses, it is suggested that cancellation of the actual input should occur. When the second time-out elapses, it is suggested that the epilogue procedure should take place. Any output can take place when the first time-out has elapsed.

ANNEX A

(to Recommendation Z.317)

Use of SDL to describe MML dialogue procedures

A.1 *Introduction*

The specification and Description Language (SDL) described in the Z.100 series Recommendations can be used to describe MML dialogue procedures. This annex provides SDL examples of MML dialogue procedures from Recommendation Z.317.

A.2 *SDL description of dialogue procedures*

The SDL diagrams in figures A-1/Z.317 to A-3/Z.317 cover the main procedural aspects described in § 3 of Recommendation Z.317, excluding the "Parameter entry sequence". Also, other aspects, such as I/O management and timing recommended in §§ 4 and 5 of Recommendation Z.317 have not been dealt with in the SDL diagrams.

The SDL diagrams have been developed with the aim of describing the MML interface. The SDL elements are:

<i>SDL element</i>	<i>Purpose</i>
INPUT	What the operator keys in
OUTPUT	System response
DECISION	A system decision point
ALTERNATIVE	Shows different implementation possibilities

The SDL diagrams correspond to the following figures in Recommendation Z.317:

Figure A-1/Z.317	Procedure prologue (§ 3.2) Request (§ 3.2.1) Identification procedure (§ 3.2.2)
Figure A-2/Z.317	Destination prologue (§ 3.3) Procedure epilogue (§ 3.4)
Figure A-3/Z.317	Interactive operating sequence (§ 3.5) Command entry sequence (§ 3.5.1) Direct parameter input (§ 3.6)

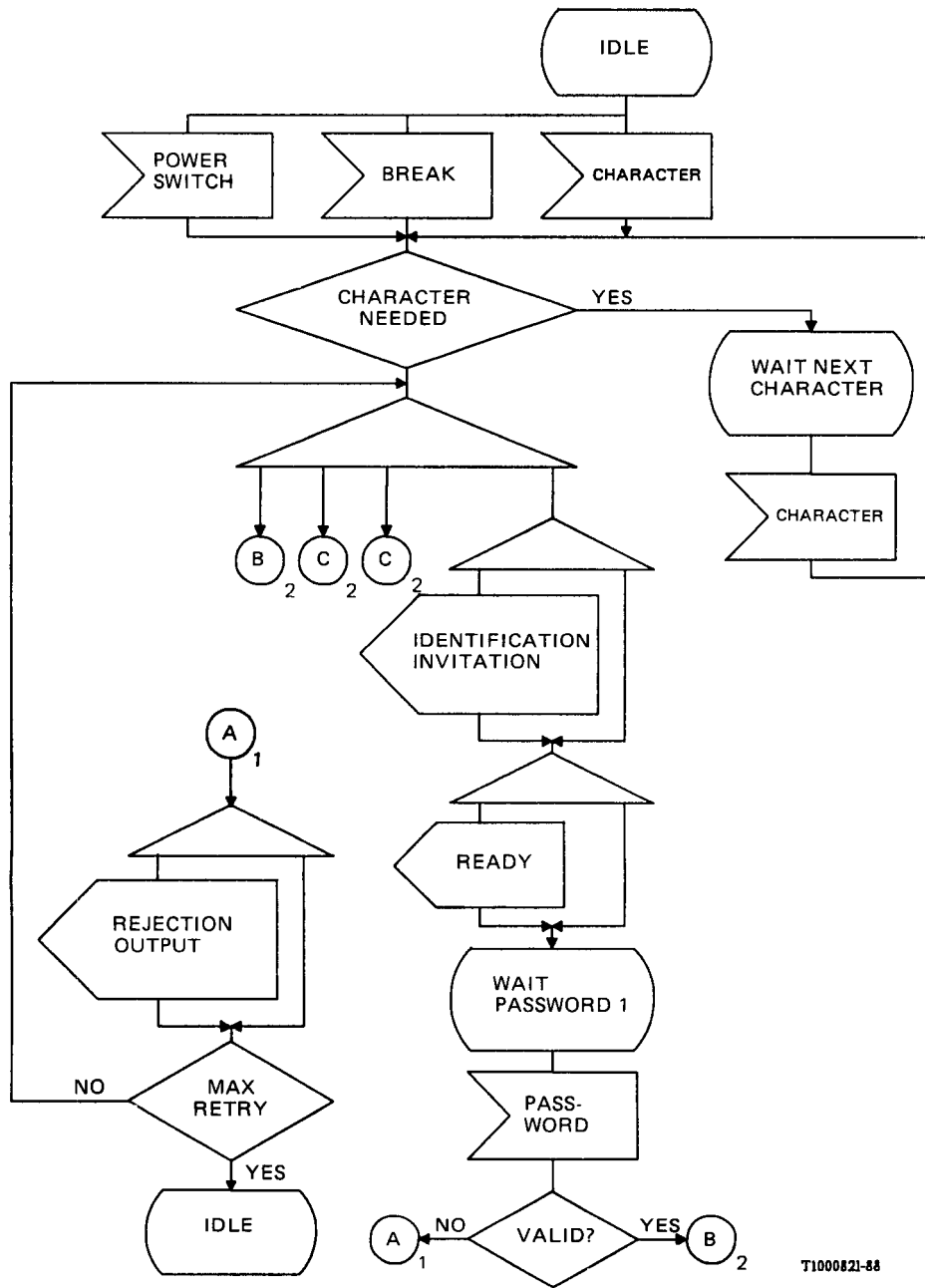

T1000821-88

FIGURE A-1/Z.317 (1 of 2)

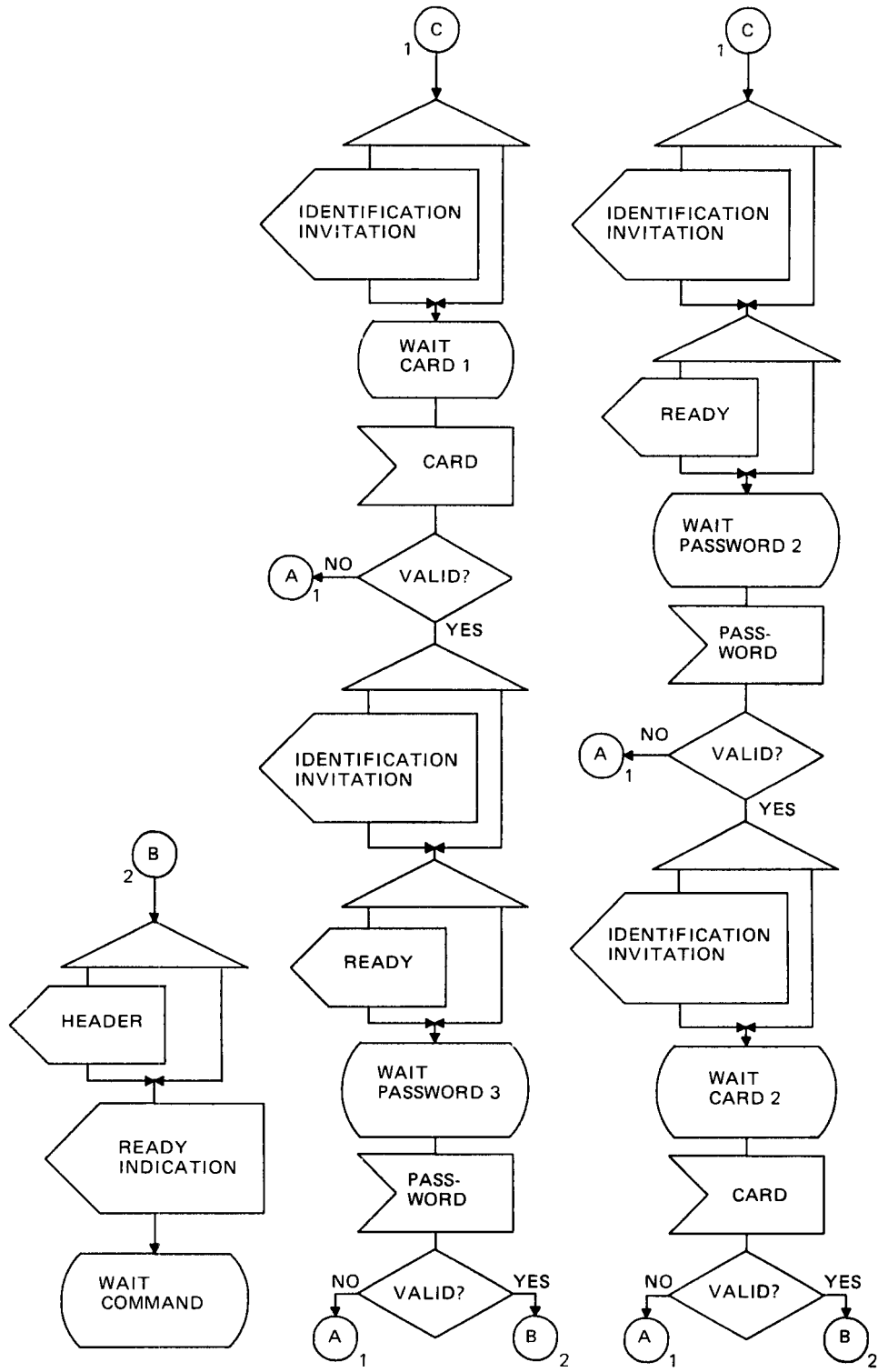

T1000825-88

FIGURE A-1/Z.317 (2 of 2)

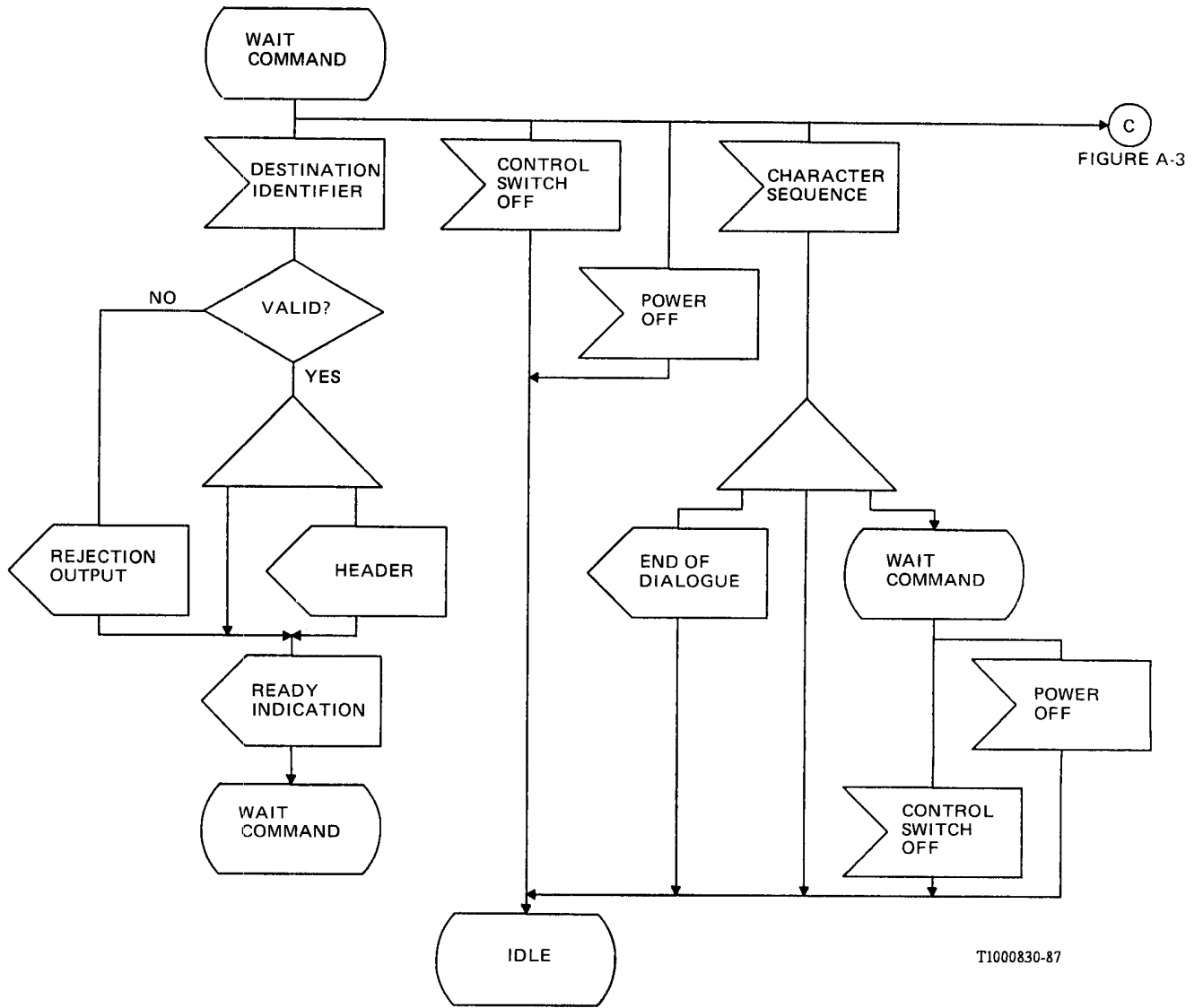
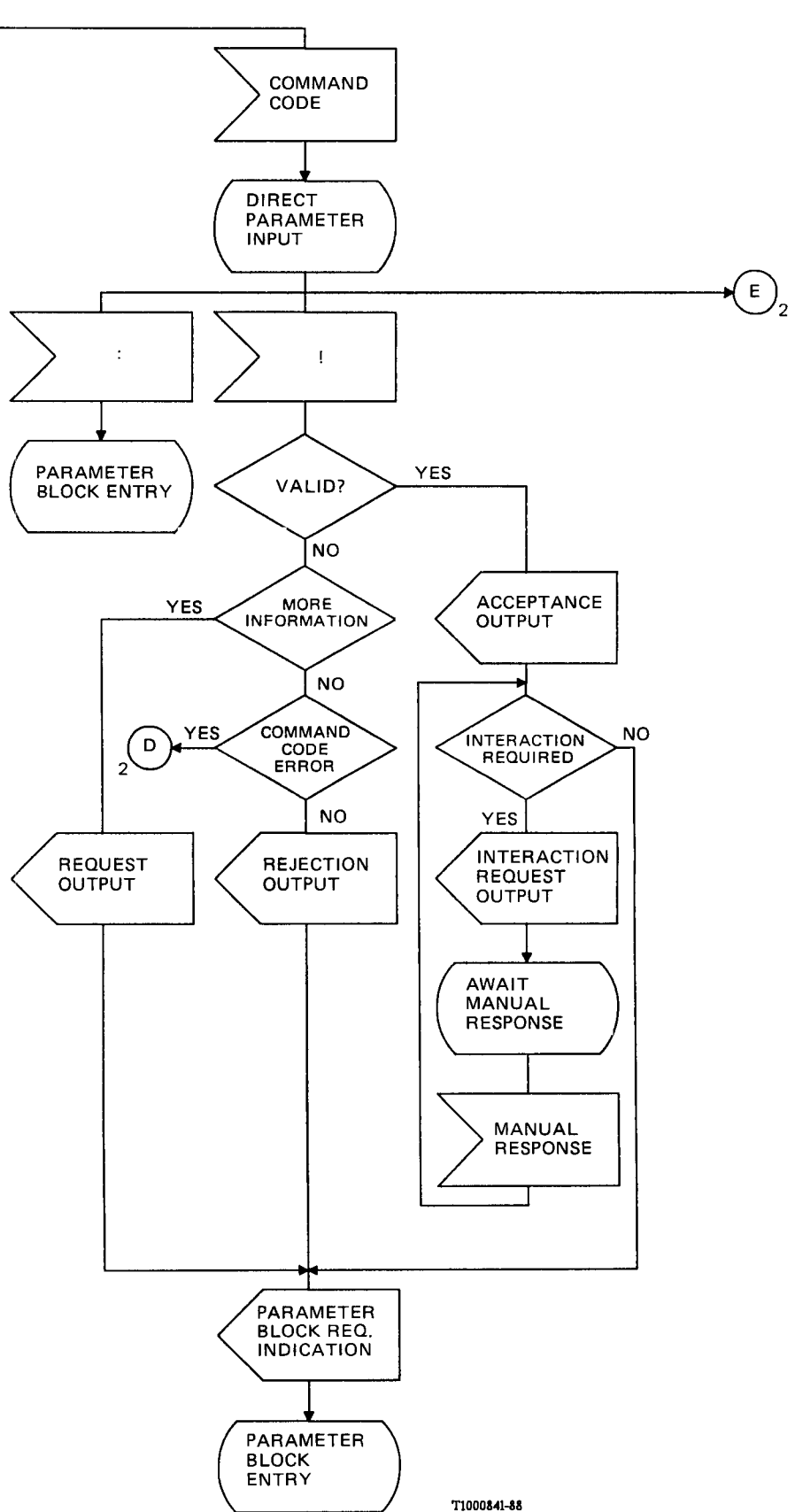

FIGURE A-2/Z.317

FIGURE A-2



T1000841-88

FIGURE A-3/Z.317 (1 of 2)

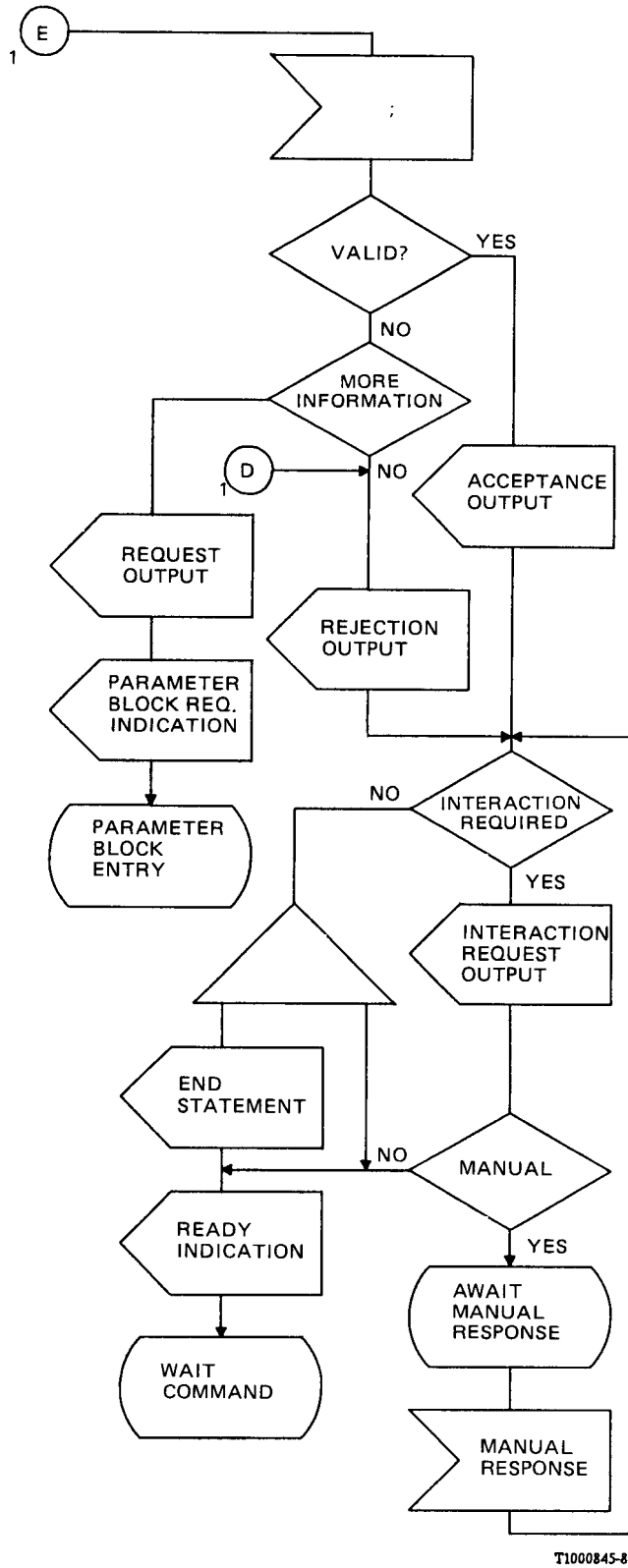

FIGURE A-3/Z.317 (2 of 2)